



GREENCREATIVE

LUMINAIRES



2018 LUMINAIRES CATALOG



GREENCREATIVE

GREEN CREATIVE, founded in 2010, is a solid state lighting development and manufacturing company based in Silicon Valley, CA. The company offers a comprehensive line of high-performance LED lighting solutions which has been widely adopted by some of the largest companies in the world.



2016 Top 10
MUST SEE Products



2017
PRODUCT
SPRINT
2017 WINNER



A complete line with national & international distribution

GREEN CREATIVE's full product line of ENERGY STAR, DLC, NSF & JA8 certified indoor retrofit and new construction lighting solutions serves the Retail, Hospitality, Food & Beverage, Office, Education & Industrial sectors through multiple distribution centers and sales networks across the USA.



Bringing you the latest in LED technology

Anchored by strong integrated R&D capabilities and patented technology, GREEN CREATIVE innovation, performance and reliability have been recognized year after year by the Illuminating Engineering Society Progress Report, the LEDs Magazine Sapphire Awards, Edison Report, NAILD and more.



2018 LUMINAIRES TABLE OF CONTENTS

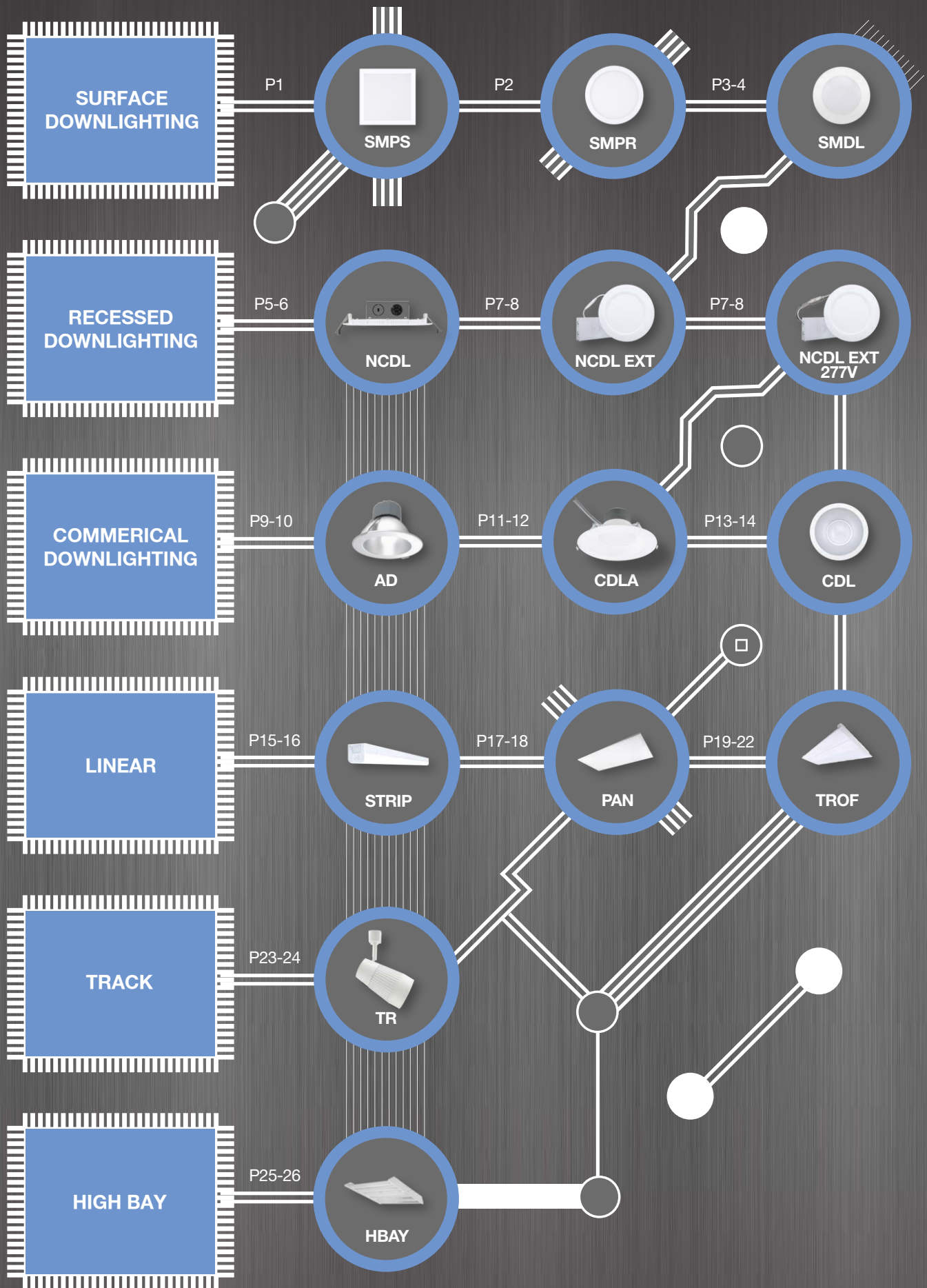

2018 LUMINAIRES FEATURED PRODUCTS



NEW!



P1-2

CLICK DESIGN SMP 277V

SootheOptic technology
120-277V - 0-10V dimming
Wet location & high CRI

NEW!



P7-8

NCDL EXT THINFIT SERIES

4", 6" & 8" form factors
High CRI
Wet location, IC & air-tight rated

COMING SOON!



P7-8

NCDL EXT 277V THINFIT SERIES

120-277V - 0-10V dimming
High CRI
Wet location, IC & air-tight rated

NEW!



P9-10

COMMERCIAL DOWNLIGHT SPECFIT SERIES

4", 6", 8" & 9.5" form factors
Adjustable lumen output
Reflector & lens options

SURFACE MOUNT CEILING LINE

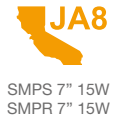

SPECIFICATIONS

	Model	Product	CCT	Lumens (lm)	Equiv.	LPW	Beam Angle	CBCP (cd)	CRI (typ.)	Dim	Life (hrs)	Voltage	Wet	ES
 SMPS 9" 20W	20SMPS9DIM/930	58242	3000K	1200	100W	60	100°	N.A.	90	Yes	50,000	120V	Yes	✓
	20SMPS9DIM/940	58243	4000K	1250	100W	63	100°	N.A.	90	Yes	50,000	120V	Yes	✓
 SMPS 9" 20W 277V	20SMPS9DIM/930/277V	58250	3000K	1200	100W	60	100°	N.A.	90	Yes	50,000	120-277V	Yes	✓
	20SMPS9DIM/940/277V	58251	4000K	1250	100W	63	100°	N.A.	90	Yes	50,000	120-277V	Yes	✓
 SMPS 7" 15W	15SMPS7DIM/927	58244	2700K	850	75W	57	100°	N.A.	90	Yes	50,000	120V	Yes	✓
	15SMPS7DIM/930	58245	3000K	850	75W	57	100°	N.A.	90	Yes	50,000	120V	Yes	✓
	15SMPS7DIM/940	58246	4000K	870	75W	58	100°	N.A.	90	Yes	50,000	120V	Yes	✓
 SMPS 7" 15W	15SMPS7DIM/927/R	97975	2700K	850	75W	57	100°	N.A.	90	Yes	50,000	120V	Yes	✓ / ✓
	15SMPS7DIM/930/R	97976	3000K	850	75W	57	100°	N.A.	90	Yes	50,000	120V	Yes	✓ / ✓
	15SMPS7DIM/940/R	97977	4000K	870	75W	58	100°	N.A.	90	Yes	50,000	120V	Yes	✓ / ✓
 SMPS 7" 15W 277V	15SMPS7DIM/930/277V	58252	3000K	850	75W	57	100°	N.A.	90	Yes	50,000	120-277V	Yes	✓
	15SMPS7DIM/940/277V	58253	4000K	870	75W	58	100°	N.A.	90	Yes	50,000	120-277V	Yes	✓
 SMPS 5.5" 10W	10SMPS5.5DIM/927	58247	2700K	550	50W	55	100°	N.A.	90	Yes	50,000	120V	Yes	✓
	10SMPS5.5DIM/930	58248	3000K	550	50W	55	100°	N.A.	90	Yes	50,000	120V	Yes	✓
	10SMPS5.5DIM/940	58249	4000K	560	50W	56	100°	N.A.	90	Yes	50,000	120V	Yes	✓
 9" EMERGENCY BACKUP 23W	23SMPS9/EM	98001	9" Square & Round Emergency Backup 23W for Use with CLICK Design Downlights											
	23SMPR9/EM	98002												

SURFACE MOUNT CEILING LINE

Available in both 120V & 120-277V versions



-  Innovative **CLICK** design - Edge lighting technology
-  Wet location & high CRI
-  Compatible with 4" J-boxes (standard)
-  120-277V version - 0-10V dimming

SootheOptic Low Glare Technology

Viewing Angle









0°

45°

>65°

SootheOptic low glare technology reduces visual glare and creates a comfortable lighting environment

SPECIFICATIONS





	Model	Product	CCT	Lumens (lm)	Equiv.	LPW	Beam Angle	CBCP (cd)	CRI (typ.)	Dim	Life (hrs)	Voltage	Wet	ES	JAS
 SMPR 9" 20W	20SMPR9DIM/930	58255	3000K	1200	100W	60	100°	N.A.	90	Yes	50,000	120V	Yes	✓	
	20SMPR9DIM/940	58256	4000K	1250	100W	63	100°	N.A.	90	Yes	50,000	120V	Yes	✓	
 SMPR 9" 20W 277V	20SMPR9DIM/930/277V	NEW! 58263	3000K	1200	100W	60	100°	N.A.	90	Yes	50,000	120-277V	Yes	✓	
	20SMPR9DIM/940/277V	58264	4000K	1250	100W	63	100°	N.A.	90	Yes	50,000	120-277V	Yes	✓	
 SMPR 7" 15W	15SMPR7DIM/927	58257	2700K	850	75W	57	100°	N.A.	90	Yes	50,000	120V	Yes	✓	
	15SMPR7DIM/930	58258	3000K	850	75W	57	100°	N.A.	90	Yes	50,000	120V	Yes	✓	
	15SMPR7DIM/940	58259	4000K	870	75W	58	100°	N.A.	90	Yes	50,000	120V	Yes	✓	
 SMPR 7" 15W	15SMPR7DIM/927/R	NEW! 97978	2700K	850	75W	57	100°	N.A.	90	Yes	50,000	120V	Yes	✓ / ✓	
	15SMPR7DIM/930/R	97979	3000K	850	75W	57	100°	N.A.	90	Yes	50,000	120V	Yes	✓ / ✓	
	15SMPR7DIM/940/R	97980	4000K	870	75W	58	100°	N.A.	90	Yes	50,000	120V	Yes	✓ / ✓	
 SMPR 7" 15W 277V	15SMPR7DIM/930/277V	NEW! 58265	3000K	850	75W	57	100°	N.A.	90	Yes	50,000	120-277V	Yes	✓	
	15SMPR7DIM/940/277V	58266	4000K	870	75W	58	100°	N.A.	90	Yes	50,000	120-277V	Yes	✓	
 SMPR 5.5" 10W	10SMPR5.5DIM/927	58260	2700K	550	50W	55	100°	N.A.	90	Yes	50,000	120V	Yes	✓	
	10SMPR5.5DIM/930	58261	3000K	550	50W	55	100°	N.A.	90	Yes	50,000	120V	Yes	✓	
	10SMPR5.5DIM/940	58262	4000K	560	50W	56	100°	N.A.	90	Yes	50,000	120V	Yes	✓	
 SMP 4" & 6" ACC	SMP/ACC	58033													

4" & 6" Recessed Can Accessories for 5.5" & 7" Round & Square
(5.5" for Use in 4" Can Only, 7" for Use in 4" or 6" Can)

SURFACE MOUNT CEILING LINE



SPECIFICATIONS

Model	Product	CCT	Lumens (lm)	Equiv. LPW	Beam Angle	CBCP (cd)	CRI (typ.)	Dim	Life (hrs)	Voltage	Wet			
 SMDL 6" 14.5W	14.5SMDL6DIM/927	40842	2700K	920	85W	63	110°	N.A.	90	Yes	40,000	120V	No	✓
	14.5SMDL6DIM/930	40843	3000K	950	85W	66	110°	N.A.	90	Yes	40,000	120V	No	✓
	14.5SMDL6DIM/840	40847	4000K	1050	100W	72	110°	N.A.	82	Yes	40,000	120V	No	✓
 SMDL 6" 11W	11SMDL6DIM/927	58101	2700K	680	65W	62	110°	N.A.	90	Yes	40,000	120V	Yes	✓
	11SMDL6DIM/930	58102	3000K	720	65W	65	110°	N.A.	90	Yes	40,000	120V	Yes	✓
	11SMDL6DIM/940	58103	4000K	750	65W	68	110°	N.A.	90	Yes	40,000	120V	Yes	✓
 SMDL 6" ACC	SMDL6/ACC	57974	5-6" Recessed Can Accessories											
 SMDL 4" ACC	SMDL4/ACC	57973	4" Recessed Can Accessories											

* GU24 connector available

SURFACE MOUNT CEILING LINE

Wet location rated & high CRI



SMDL 6" 11W



Seamless Installation



- Innovative CLICK design
- Compatible with 4" J-boxes (standard)
- 4" & 5-6" recessed can accessories sold separately
- Installs in just minutes – No rewiring

CLICK 6" 14.5W & 11W - High CRI

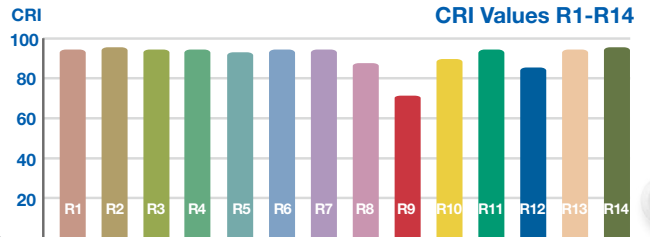

INSTALLATION GUIDE

4" J-BOX

ACCESSORIES INCLUDED:

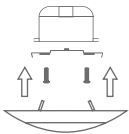

- Attach mounting bracket to J-box
- Click downlight into mounting bracket



Mounting Bracket



J-Box Screws



Wire Nuts



LED Adapter

4" CAN

ACCESSORIES SOLD SEPARATELY:

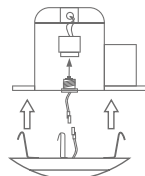

- Connect E26 adapter to the LED adapter
- Insert mounting clips and push downlight up until flush with ceiling



E26 Adapter



LED Adapter



Mounting Bracket



Mounting Clips

5-6" CAN

ACCESSORIES SOLD SEPARATELY:

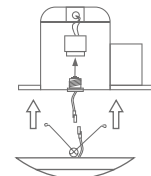

- Connect E26 adapter to the LED adapter
- Squeeze mounting springs and push downlight up until flush with ceiling



E26 Adapter



LED Adapter



Mounting Springs

NEW CONSTRUCTION DOWNLIGHT LINE

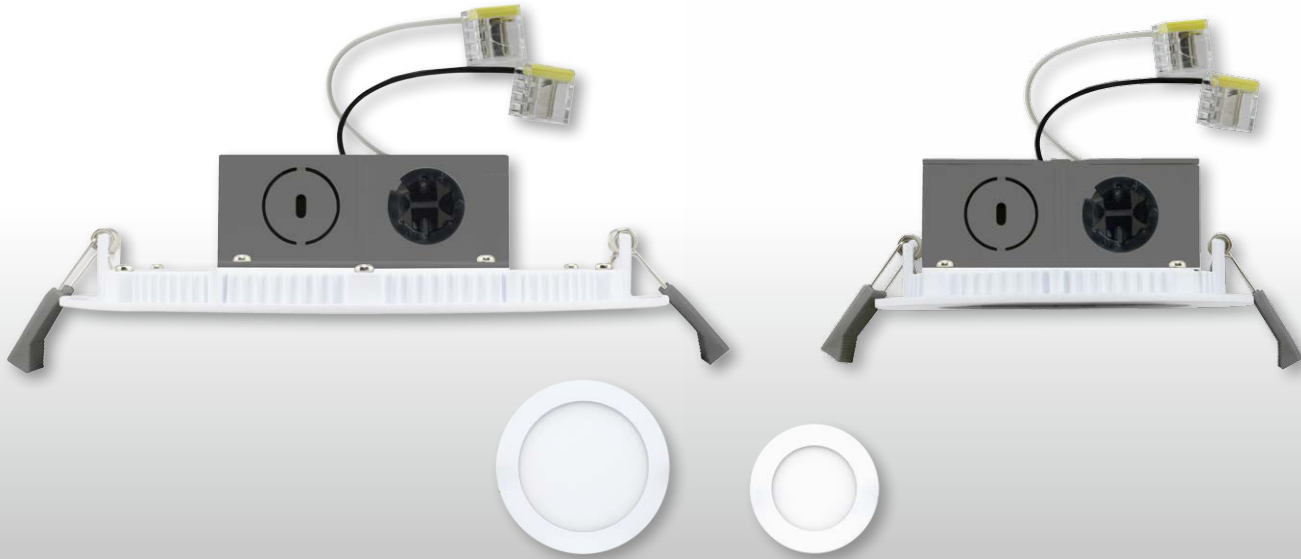

SPECIFICATIONS

Model	Product	CCT	Lumens (lm)	Equiv.	LPW	Beam Angle	CBCP (cd)	CRI (typ.)	Dim	Life (hrs)	Voltage	Wet		
 DLNC 6" 11.6W	11.6DLNC6DIM/827	58028	2700K	810	75W	70	100°	N.A.	82	Yes	40,000	120V	No	✓
	11.6DLNC6DIM/830	58029	3000K	830	75W	72	100°	N.A.	82	Yes	40,000	120V	No	✓
	11.6DLNC6DIM/840	58030	4000K	850	75W	73	100°	N.A.	82	Yes	40,000	120V	No	✓
 DLNC 4" 8.5W	8.5DLNC4DIM/827	58025	2700K	510	50W	60	100°	N.A.	82	Yes	40,000	120V	No	✓
	8.5DLNC4DIM/830	58026	3000K	530	50W	62	100°	N.A.	82	Yes	40,000	120V	No	✓
	8.5DLNC4DIM/840	58027	4000K	550	50W	65	100°	N.A.	82	Yes	40,000	120V	No	✓
 6" GOOF RING	DLNC6GOOF/R	97848	6" Goof Ring Outer Diameter 8.50" (216mm)											
 4" GOOF RING	DLNC4GOOF/R	97847	4" Goof Ring Outer Diameter 6.02" (153mm)											
 T-GRID NC PLATE	NCPLATE/T	97983	New Construction or Remodel Plate for T-grid Ceilings (Multiple Knockouts from 4.3-7.7" (109-196mm))											
 STUD/JOIST NC PLATE	NCPLATE	97984	New Construction Plate for up to 24" Stud/Joist Spacings (Multiple Knockouts from 4.3-7.7" (109-196mm))											

* NCPLATE/T & NCPLATE for use with both 6" & 4" models

NEW CONSTRUCTION DOWNLIGHT LINE

Integrated J-box with LED quick connectors for quick & easy installation

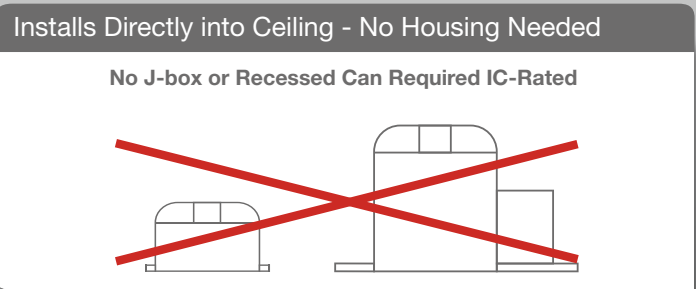
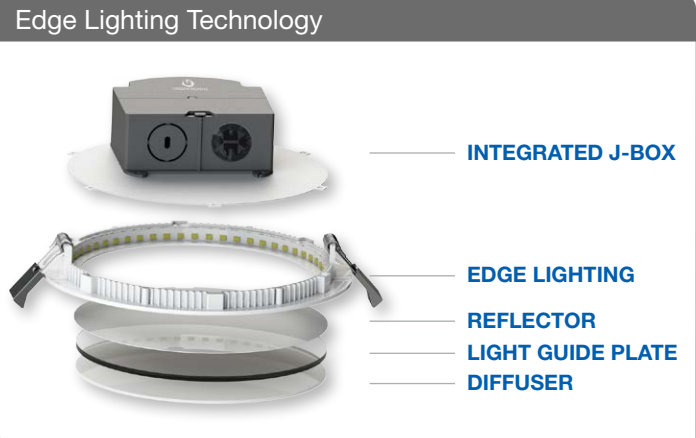

- For new construction or remodel installation
- Innovative design saves time & materials
- Easy to use spring action clips
- Goof Ring available

INSTALLATION GUIDE

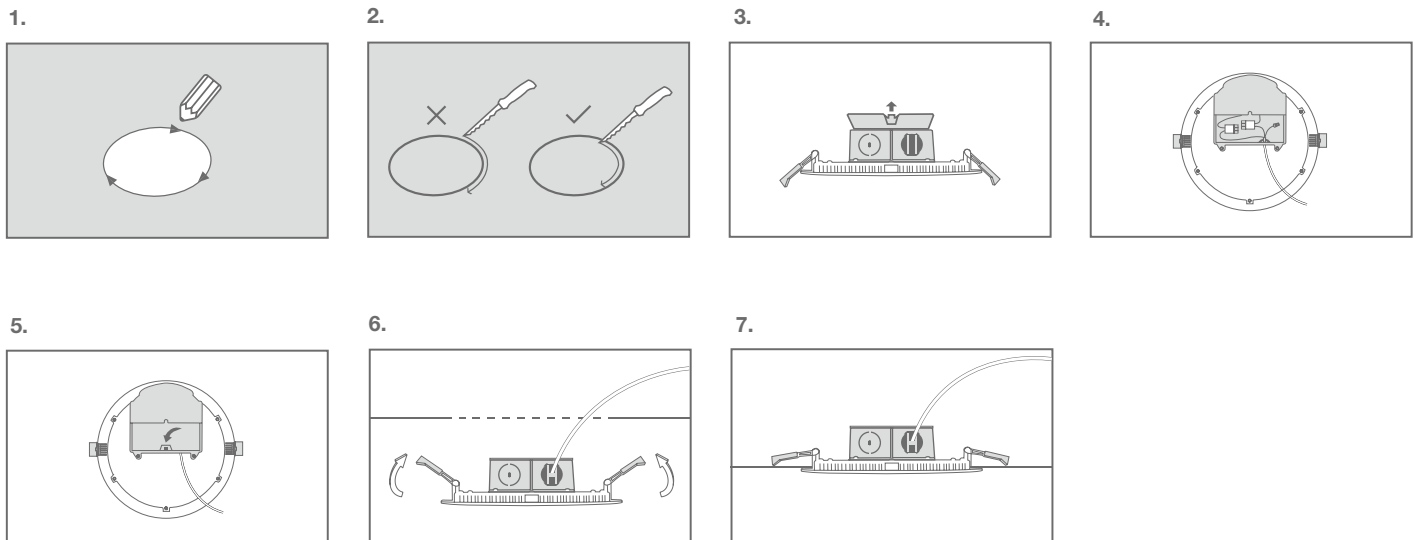

NEW CONSTRUCTION DOWNLIGHT LINE EXT



SPECIFICATIONS

Model	Product	CCT	Lumens (lm)	Equiv. LPW	Beam Angle	CBCP	CRI (typ.)	Dim	Life (hrs)	Voltage	Wet	ES	JA8	
 NCDLR 8" 24.5W	NEW! 24.5NCDLR8DIM/927/EXT	98110	2700K	1820	125W	74	110°	N.A.	90	Yes	50,000	120V	Yes	✓/✓/✓
	24.5NCDLR8DIM/930/EXT	98111	3000K	1920	125W	78	110°	N.A.	90	Yes	50,000	120V	Yes	✓/✓/✓
	24.5NCDLR8DIM/940/EXT	98112	4000K	1920	125W	78	110°	N.A.	90	Yes	50,000	120V	Yes	✓/✓/✓
 NCDLR 6" 12W	NEW! 12NCDLR6DIM/927/EXT	98107	2700K	900	85W	75	110°	N.A.	90	Yes	50,000	120V	Yes	✓/✓/✓
	12NCDLR6DIM/930/EXT	98108	3000K	920	85W	77	110°	N.A.	90	Yes	50,000	120V	Yes	✓/✓/✓
	12NCDLR6DIM/940/EXT	98109	4000K	940	85W	78	110°	N.A.	90	Yes	50,000	120V	Yes	✓/✓/✓
 NCDLR 4" 10W	NEW! 10NCDLR4DIM/927/EXT	98104	2700K	700	65W	70	110°	N.A.	90	Yes	50,000	120V	Yes	✓/✓/✓
	10NCDLR4DIM/930/EXT	98105	3000K	720	65W	72	110°	N.A.	90	Yes	50,000	120V	Yes	✓/✓/✓
	10NCDLR4DIM/940/EXT	98106	4000K	740	65W	74	110°	N.A.	90	Yes	50,000	120V	Yes	✓/✓/✓
 NCDLR 8" 24.5W 277V	COMING SOON! 24.5NCDLR8DIM/930/277V/EXT	98220	3000K	1920	125W	78	110°	N.A.	90	Yes	50,000	120-277V	Yes	Jun. / Jun.
	24.5NCDLR8DIM/935/277V/EXT	98221	3500K	1920	125W	78	110°	N.A.	90	Yes	50,000	120-277V	Yes	Jun. / Jun.
	24.5NCDLR8DIM/940/277V/EXT	98222	4000K	1920	125W	78	110°	N.A.	90	Yes	50,000	120-277V	Yes	Jun. / Jun.
 NCDLR 6" 12W 277V	COMING SOON! 12NCDLR6DIM/930/277V/EXT	98217	3000K	920	85W	77	110°	N.A.	90	Yes	50,000	120-277V	Yes	Jun. / Jun.
	12NCDLR6DIM/935/277V/EXT	98218	3500K	920	85W	77	110°	N.A.	90	Yes	50,000	120-277V	Yes	Jun. / Jun.
	12NCDLR6DIM/940/277V/EXT	98219	4000K	940	85W	78	110°	N.A.	90	Yes	50,000	120-277V	Yes	Jun. / Jun.
 NCDLR 4" 10W 277V	COMING SOON! 10NCDLR4DIM/930/277V/EXT	98214	3000K	720	65W	72	110°	N.A.	90	Yes	50,000	120-277V	Yes	Jun. / Jun.
	10NCDLR4DIM/935/277V/EXT	98215	3500K	720	65W	72	110°	N.A.	90	Yes	50,000	120-277V	Yes	Jun. / Jun.
	10NCDLR4DIM/940/277V/EXT	98216	4000K	740	65W	74	110°	N.A.	90	Yes	50,000	120-277V	Yes	Jun. / Jun.

NEW CONSTRUCTION DOWNLIGHT LINE EXT



External driver with large wiring space designed for daisy chain applications



LED quick connectors

Clip for remodel installations

120-277V version uses flex conduit for cable connection

Suitable for Shallow Ceiling Applications

Wet location, IC & Air-tight Rated



Installs Directly into Ceiling - No Housing Needed

No J-box or Recessed Can Required

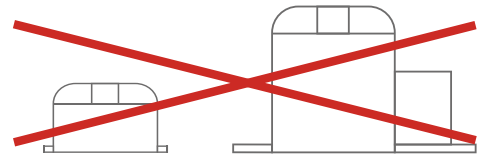

- For new construction or remodel installation
- Innovative design saves time & materials
- Easy to use spring action clips
- 120-277V version - 0-10V dimming

ACCESSORIES

Model	Product	Description
8" GOOF RING	DLNC8GOOF NEW! 98238	8" Goof Ring Outer Diameter 10.24" (260mm)
6" GOOF RING	DLNC6GOOF/R 97848	6" Goof Ring Outer Diameter 8.50" (216mm)
4" GOOF RING	DLNC4GOOF/R 97847	4" Goof Ring Outer Diameter 6.02" (153mm)
T-GRID NC PLATE	NCPLATE/T 97983	New Construction or Remodel Plate for T-grid Ceilings (Multiple Knockouts from 4.3-7.7" (109-196mm))
STUD/JOIST NC PLATE	NCPLATE 97984	New Construction Plate for up to 24" Stud/Joist Spacings (Multiple Knockouts from 4.3-7.7" (109-196mm))

* NCPLATE/T & NCPLATE for use with both 6" & 4" models

COMMERCIAL DOWNLIGHT LINE



Select Drive

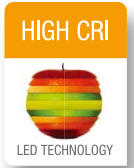

SPECIFICATIONS

Light Engine and Driver								Reflector		
Series	Light Engine	CRI	CCT	Driver	Voltage	Optical Distribution	Options ³	Reflector Shape	Finish	ENERGY STAR
AD4 Specfit 4"	LES ⁵ 500-700-1000lm	90 90+ CRI	27 2700K	DIM010 0-10V Dim to 5%	UNV 120-277, 50/60Hz	MD ¹ Medium	SD347 347V Transformer	ADR4 4" Round Reflector	CC Clear Diffuse Trim and Flange	✓
AD6 Specfit 6"	LEM 1500-2000-2500lm	97 ² 3000K only	30 3000K			VN Very Narrow	SD480 480V Transformer	ADR6 6" Round Reflector	CW Clear Diffuse Trim, White Flange	✓
AD8 Specfit 8"	LEL ⁶ 3000-4000-5000lm		35 3500K			NR Narrow	EM ⁴ Emergency Backup	ADR8 8" Round Reflector	WH Matte White Trim and Flange	✓
AD9.5 Specfit 9.5"			40 4000K			WD Wide		ADR9.5 9.5" Round Reflector	BL Matte Black Trim and Flange	✓

¹ Medium Lens Optic comes standard. If other optic distribution is selected the lens will ship separately and require field installation / ² CRI97 is made to order in 3000K only / ³ Options are factory installed and come with the Light Engine and Driver / ⁴ EM cannot be combined with SD347 or SD480 option / ⁵ LES is not available for AD9.5 / ⁶ LEL is not available for AD4

Selection*

Ex: AD6-LES-9040-DIM010-UNV-MD-ADR6-CC

AD6				DIM010	UNV			ADR6	
-----	--	--	--	--------	-----	--	--	------	--

* A complete fixture consists of one light engine and driver and one reflector

COMMERCIAL DOWNLIGHT LINE

SelectDrive technology light engines come in three lumen packages, each with three adjustable light levels.

LES – 500-700-1000lm, LEM – 1500-2000-2500lm & LEL – 3000-4000-5000lm



LES & LEM



LEL



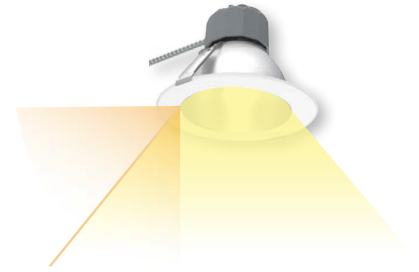

Field Interchangeable Lens - 45° Cut Off





Choose from Medium (MD), Very Narrow (VN), Narrow (NR) and Wide (WD) optical distributions. Medium comes standard with all light engines.

SelectDrive Technology - Adjustable Lumen Output



-  Easy fit installation for retrofit or new construction
-  Universal housing compatibility
-  High CRI 90 – CRI 97 also available
-  Multiple reflector options – CC, CW, WH & BL

ACCESSORIES

Model	Product	Description
 ADWAW	NEW! 98079	Wall Wash Accessory
 9.5" GOOF RING	NEW! 98025	9.5" Goof Ring Outer Diameter 14.17" (360mm)
 T-GRID NC PLATE	97983	New Construction or Remodel Plate for T-grid Ceilings (Multiple Knockouts from 4.3-7.7" (109-196mm))
 STUD/JOIST NC PLATE	97984	New Construction Plate for up to 24" Stud/Joist Spacings (Multiple Knockouts from 4.3-7.7" (109-196mm))

* NCPLATE/T & NCPLATE for use with 8", 6" & 4" models only

COMMERCIAL DOWNLIGHT LINE



Select Drive

2016 Top 10
MUST SEE Products



SPECIFICATIONS

	Model	Product	CCT	Lumens (lm)	Equiv.	LPW	Beam Angle	CRI (typ.)	Dim	Life (hrs)	Voltage	
 CDL 9.5\" data-bbox="55 555 115 575"/>	45CDLA9.5/827/277V	57878	2700K	1860/2325/2975	23.5W - 1x42W/2x26W 32W - 1x57W/2x32W 45W - 2x42W	79/73/76	110°	80	No	40,000	120-277V	✓
	45CDLA9.5/830/277V	57879	3000K	2000/2500/3200		85/78/71	110°	80	No	40,000	120-277V	✓
	45CDLA9.5/835/277V	57880	3500K	2000/2500/3200		85/78/71	110°	80	No	40,000	120-277V	✓
	45CDLA9.5/840/277V	57881	4000K	2000/2500/3200		85/78/71	110°	80	No	40,000	120-277V	✓
 CDL 8\" data-bbox="55 620 115 640"/>	27CDLA8/827/277V	57873	2700K	930/1400/1860	12W - 1x26W/2x13W 19W - 1x32W/2x18W 27W - 1x42W/2x26W	78/74/69	110°	80	No	40,000	120-277V	✓
	27CDLA8/830/277V	57874	3000K	1000/1500/2000		83/79/74	110°	80	No	40,000	120-277V	✓
	27CDLA8/835/277V	57875	3500K	1000/1500/2000		83/79/74	110°	80	No	40,000	120-277V	✓
	27CDLA8/840/277V	57876	4000K	1000/1500/2000		83/79/74	110°	80	No	40,000	120-277V	✓
 CDL 6\" data-bbox="55 685 115 705"/>	21CDLA6/827/277V/R	57868	2700K	650/930/1400	8.5W - 1x18W 13.5W - 1x26W/2x13W 21W - 1x32W/2x18W	76/69/67	110°	80	No	40,000	120-277V	✓
	21CDLA6/830/277V/R	57869	3000K	700/1000/1500		82/74/71	110°	80	No	40,000	120-277V	✓
	21CDLA6/835/277V/R	57870	3500K	700/1000/1500		82/74/71	110°	80	No	40,000	120-277V	✓
	21CDLA6/840/277V/R	57871	4000K	700/1000/1500		82/74/71	110°	80	No	40,000	120-277V	✓
 CDL 4\" data-bbox="55 750 115 770"/>	14CDLA4/827/277V	57863	2700K	465/650/930	6W - 1x13W 9W - 1x18W 14W - 1x26W/2x13W	78/72/66	110°	80	No	40,000	120-277V	✓
	14CDLA4/830/277V	57864	3000K	500/700/1000		83/78/71	110°	80	No	40,000	120-277V	✓
	14CDLA4/835/277V	57865	3500K	500/700/1000		83/78/71	110°	80	No	40,000	120-277V	✓
	14CDLA4/840/277V	57866	4000K	500/700/1000		83/78/71	110°	80	No	40,000	120-277V	✓
 9.5\" data-bbox="55 805 115 815"/>	9.5GOOF	NEW!	98025	9.5\" Goof Ring Outer Diameter 14.17\" (360mm)								
 T-GRID NC PLATE	NCPLATE/T		97983	New Construction or Remodel Plate for T-grid Ceilings (Multiple Knockouts from 4.3-7.7\" (109-196mm))								
 STUD/JOIST NC PLATE	NCPLATE		97984	New Construction Plate for up to 24\" Stud/Joist Spacings (Multiple Knockouts from 4.3-7.7\" (109-196mm))								
 EMERGENCY INVERTER	50EMINVERTER 35EMINVERTER 23EMBACKUP		98235 58012 98003	Emergency Inverter 50W for Use with 9.5\" Model Emergency Inverter 35W for Use with 8\", 6\" & 4\" Models Only Emergency Backup 23W for Use with 6\" & 4\" Models Only								

* IC-Rated - 6\" & 4\" versions

COMMERCIAL DOWNLIGHT LINE

The adjustable housing clips allow for installation in a large range of commercial and architectural housings. These spring-action clips push up easily and fit securely for both retrofit and new construction installations.

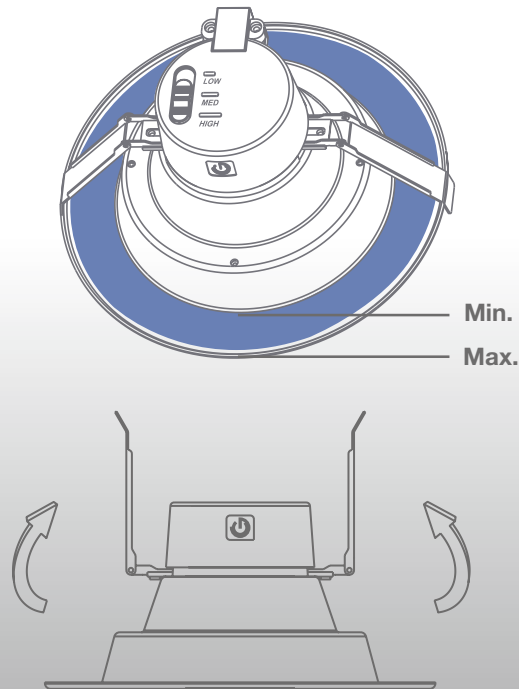

Dimensions		
Model	Aperture Min.	Aperture Max.
9.5"	8.6" (220mm)	10.4" (265mm)
8"	7.6" (195mm)	9.4" (240mm)
6"	6.0" (153mm)	7.4" (190mm)
4"	3.9" (100mm)	5.1" (130mm)

SelectDrive Technology - Adjustable Lumen Output



120-277V

UNIVERSAL

LUMEN OUTPUT

ADJUSTABLE



-  For retrofit or new construction installation
-  Universal housing compatibility
-  Adjustable lumen output – 3 defined light levels
-  Easy fit installation – Spring-action housing clips

SIMPLE RETROFIT OR ECONOMICAL NEW CONSTRUCTION INSTALLATION

Retrofit Installation

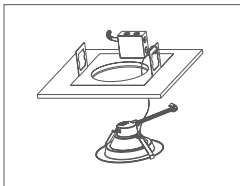

Attach safety clip

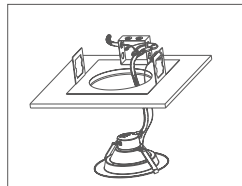

Bypass ballast & wire to j-box

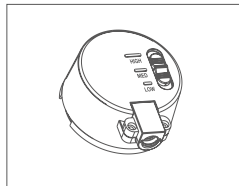

Adjust lumens to desired output

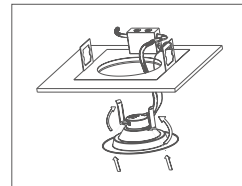

Push clips up & install into fixture

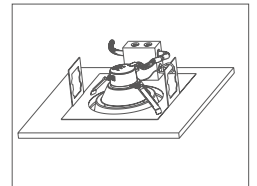

Ensure fixture is flush. Installation is complete

New Construction Installation

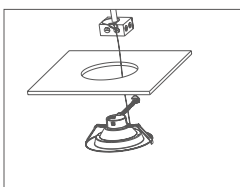

Attach safety clip

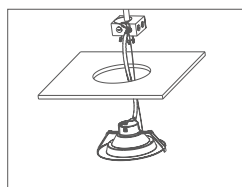

Wire to j-box

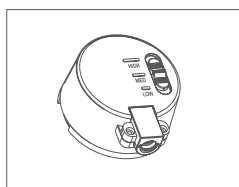

Adjust lumens to desired output

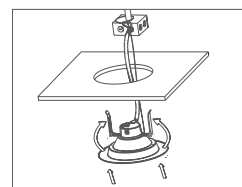

Push clips up & install into opening

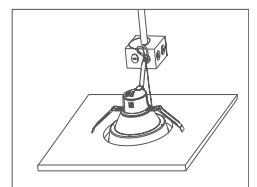





Ensure fixture is flush. Installation is complete

COMMERCIAL DOWNLIGHT LINE



SPECIFICATIONS

	Model	Product	CCT	Lumens (lm)	Equiv.	LPW	Beam Angle	CBCP (cd)	CRI (typ.)	Dim	Life (hrs)	Voltage	Encl.	
 CDL 9.5" 48W	48CDL9.5G4DIM/830/277V	97706	3000K	3200	2 X 42W	67	90°	N.A.	80	Yes	40,000	120-277V	No	✓
	48CDL9.5G4DIM/835/277V	97707	3500K	3400	2 X 42W	71	90°	N.A.	80	Yes	40,000	120-277V	No	✓
	48CDL9.5G4DIM/840/277V	97708	4000K	3600	2 X 42W	75	90°	N.A.	80	Yes	40,000	120-277V	No	✓
 CDL 8" 32W	32CDL8G4DIM/830/277V	97696	3000K	2150	2 X 26W	67	90°	N.A.	80	Yes	40,000	120-277V	No	✓
	32CDL8G4DIM/835/277V	97697	3500K	2300	2 X 26W	72	90°	N.A.	80	Yes	40,000	120-277V	No	✓
	32CDL8G4DIM/840/277V	97698	4000K	2450	2 X 26W	77	90°	N.A.	80	Yes	40,000	120-277V	No	✓
 CDL 6" 22W	22CDL6G4DIM/830/277V	97686	3000K	1600	2 X 18W	73	90°	N.A.	80	Yes	40,000	120-277V	No	✓
	22CDL6G4DIM/835/277V	97687	3500K	1650	2 X 18W	75	90°	N.A.	80	Yes	40,000	120-277V	No	✓
	22CDL6G4DIM/840/277V	97688	4000K	1700	2 X 18W	77	90°	N.A.	80	Yes	40,000	120-277V	No	✓



To order this option add /EM after the model number
 ex. 22CDL6G4DIM/840/277V/EM

Accessories include a carabiner safety clip that can be used during installation for easy wiring. Two types of retaining clips are also included to secure the fixture if recessed frame does not already have pre-installed clips.

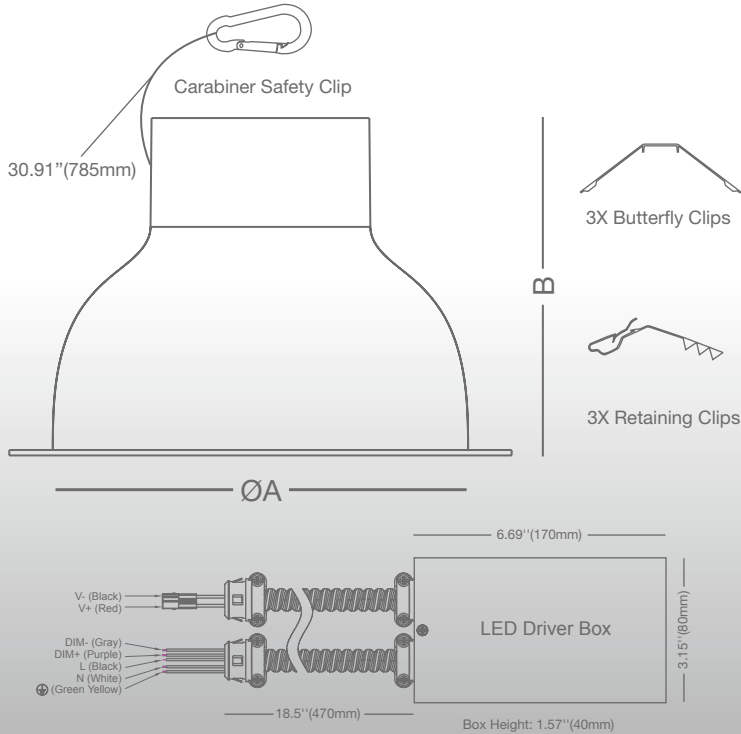

Dimensions		
Model	A	B
48CDL9.5G4DIM/xxx/277V	9.25" (235mm)	6.50" (165mm)
32CDL8G4DIM/xxx/277V	7.80" (197mm)	5.90" (150mm)
22CDL6G4DIM/xxx/277V	6.02" (153mm)	5.39" (137mm)

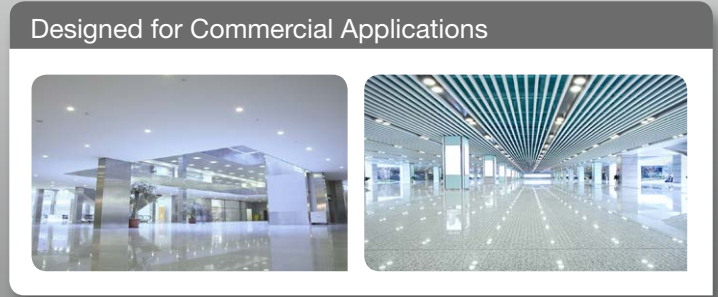

- Fits existing architectural & commercial housing
- 0-10V dimming – Compatible with 120-277V circuits
- Easy installation – Quick connector and pre-wired conduit
- Superior savings and performance over CFL

INSTALLATION GUIDE

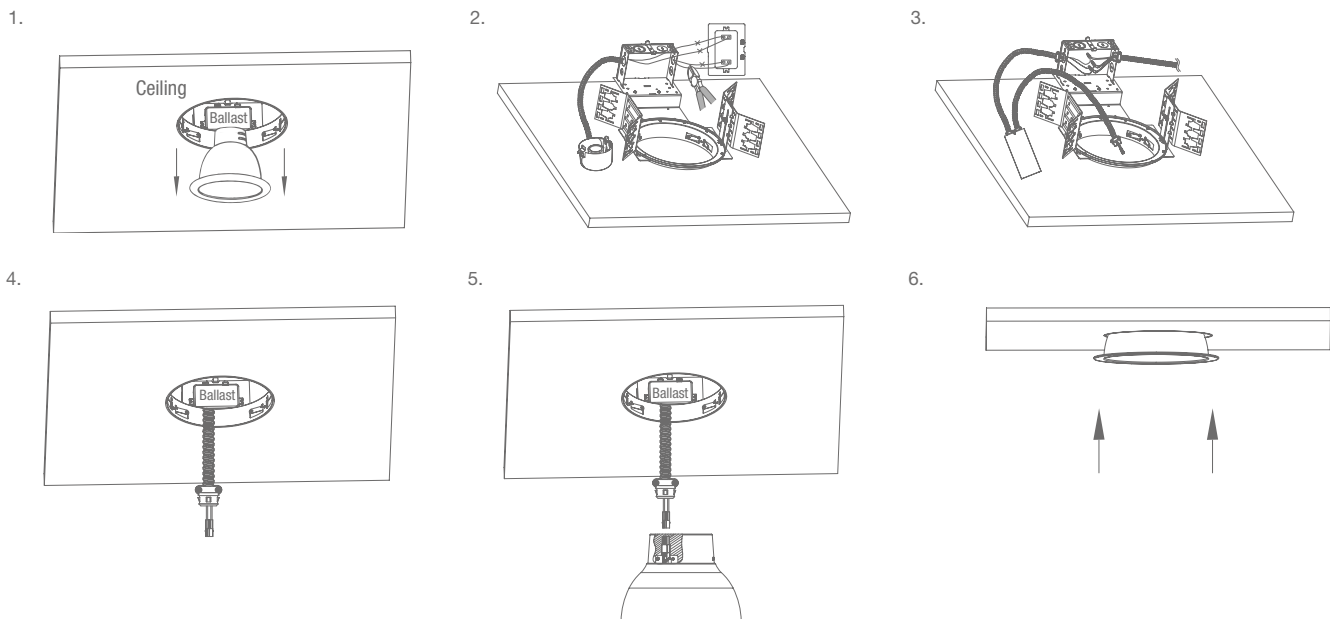





STRIP LINE



QWIKLINK Sensor





SPECIFICATIONS

	Model	Product	CCT	Lumens (lm)	LPW	Beam Angle	CBCP (cd)	CRI (typ.)	Dim	Life (hrs)	Voltage	
 STRIP 4' 38.5W	38.5STRIPDIM/830/277V	28321	3000K	4950	129	120°	N.A.	82	Yes	100,000	120-277V	✓
	38.5STRIPDIM/835/277V	28322	3500K	4950	129	120°	N.A.	82	Yes	100,000	120-277V	✓
	38.5STRIPDIM/840/277V	28323	4000K	5050	131	120°	N.A.	82	Yes	100,000	120-277V	✓
	38.5STRIPDIM/850/277V	28324	5000K	5050	131	120°	N.A.	82	Yes	100,000	120-277V	✓
 STRIP 4' 22.5W	22.5STRIPDIM/830/277V	28317	3000K	2500	111	120°	N.A.	82	Yes	100,000	120-277V	✓
	22.5STRIPDIM/835/277V	28318	3500K	2500	111	120°	N.A.	82	Yes	100,000	120-277V	✓
	22.5STRIPDIM/840/277V	28319	4000K	2600	115	120°	N.A.	82	Yes	100,000	120-277V	✓
	22.5STRIPDIM/850/277V	28320	5000K	2600	115	120°	N.A.	82	Yes	100,000	120-277V	✓
 STEP DIMMING MODULE 100/50	To order this option add /STEPDIM after the model number ex. 38.5STRIPDIM/840/277V/STEPDIM						To order this and emergency add both: ex. 38.5STRIPDIM/840/277V/STEPDIM/EM					
 EMERGENCY DRIVER 10W	To order this option add /EM after the model number ex. 38.5STRIPDIM/840/277V/EM						To order this and step dimming add both: ex. 38.5STRIPDIM/840/277V/STEPDIM/EM					

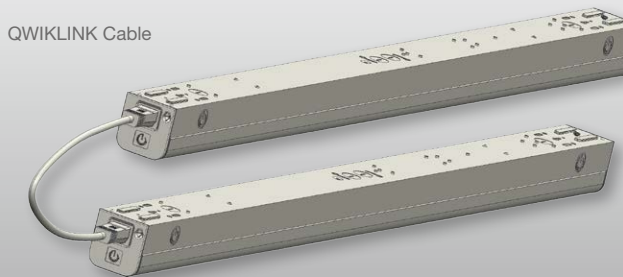
* STRIP 4" 38.5W meets DLC Premium requirements. STRIP 4" 22.5W meets DLC Standard Requirements

The QWIKLINK connection system uses the latest in toolless technology to easily and seamlessly connect up to 64' of fixtures



-  **Surface mount, pendant or suspended installation**
-  **LED quick connectors for fast & easy wiring**
-  **120-277V & 0-10V dimming control compatible**
-  **100,000-hr lifetime, 10-yr warranty**

QWIKLINK Sensor - Single Fixture or Entire Row

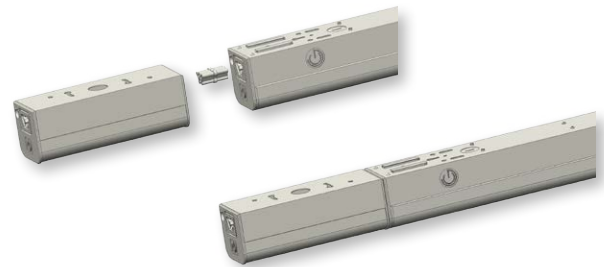

Even Distribution & Uplighting

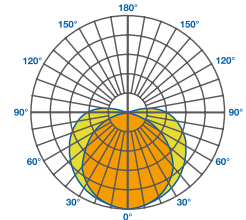





ACCESSORIES

Model	Product	Description
STPSENSOR	28388	Microwave Sensor QWIKLINK Connection Module 120-277V - Tri-level - Field Adjustable
SENSORRC	97881	Remote Control for STPSENSOR
JBOXPLATE	28384	J-box Cover Plate
STPBACKPLATE	97906	47.80"x5.31" (1214x135mm) Plate for Covering Form Factor of Old Fixture
WIRECON20	28385	7.9" (20cm) QWIKLINK Cable
WIRECON150	28386	5' QWIKLINK Cable
STP6CABLE	28382	6' Aircraft Cable with Y-toggle (Set of 2 Cables Suitable for 1 Fixture)
STP10CABLE	28383	10' Aircraft Cable with Y-toggle (Set of 2 Cables Suitable for 1 Fixture)
STPPLATE4C	28387	Back Plate for Mechanical Connection Between Suspended Fixtures in a Continuous Run (2 Aircraft Cables Per Fixture)
STPPLATE2C	97885	Back Plate for Mechanical Connection Between Suspended Fixtures in a Continuous Run (1 Aircraft Cable Per Fixture)
PC6	97860	6' Power Cord 18/3 (Not Pre-wired to Fixture)
PC12	97861	12' Power Cord 18/3 (Not Pre-wired to Fixture)

PANEL LINE



SPECIFICATIONS

	Model	Product	CCT	Lumens (lm)	LPW	Beam Angle	CBCP (cd)	CRI (typ.)	Dim	Life (hrs)	Voltage	
 PANEL 2X4' 38W	38PAN24DIM/830/277V	28349	3000K	4150	109	95°	N.A.	82	Yes	75,000	120-277V	✓
	38PAN24DIM/835/277V	28350	3500K	4150	109	95°	N.A.	82	Yes	75,000	120-277V	✓
	38PAN24DIM/840/277V	28351	4000K	4300	113	95°	N.A.	82	Yes	75,000	120-277V	✓
 PANEL 2X2' 30W	30PAN22DIM/830/277V	28345	3000K	3350	112	95°	N.A.	82	Yes	75,000	120-277V	✓
	30PAN22DIM/835/277V	28346	3500K	3350	112	95°	N.A.	82	Yes	75,000	120-277V	✓
	30PAN22DIM/840/277V	28347	4000K	3450	115	95°	N.A.	82	Yes	75,000	120-277V	✓
 EMERGENCY DRIVER 10W	To order this option add /EM after the model number ex. 38PAN24DIM/840/277V/EM											

SootheOptic low glare technology reduces visual glare and creates a comfortable lighting environment

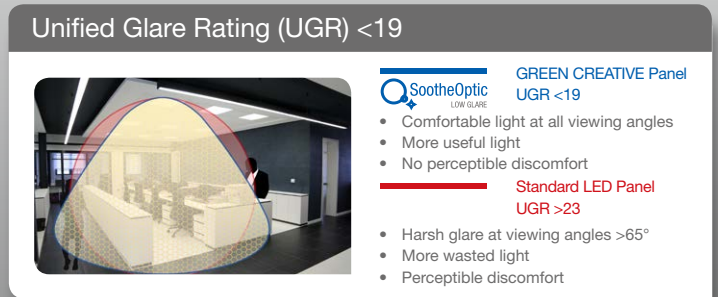
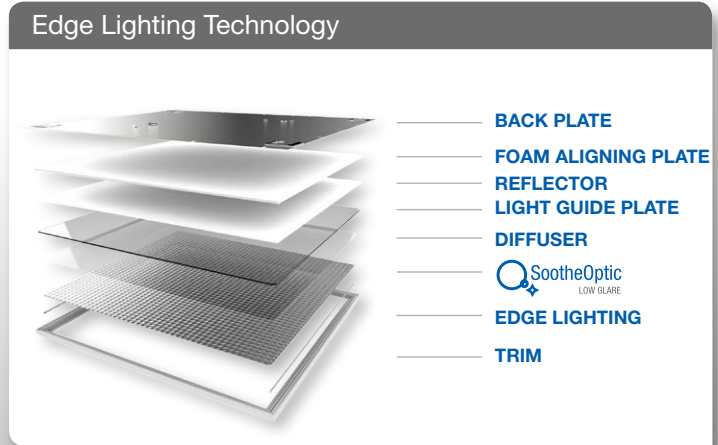
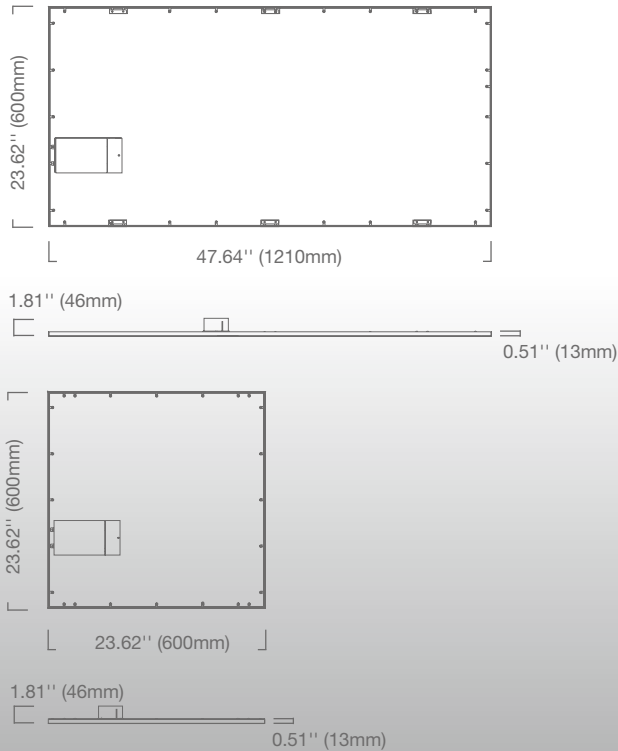







- ⌚ **Recessed, surface mount or suspended installation**
- ⌚ **Integrated J-box for fast & easy wiring**
- ⌚ **120-277V & 0-10V dimming control compatible**
- ⌚ **75,000-hr lifetime, 10-yr warranty**

ACCESSORIES			
Model	Product		Description
SM FRAME 2X4'	MOUNTFRAME24	28391	2X4' Surface Mount Frame 47.83"x23.82"x2.83" (1215x605x72mm)
SM FRAME 2X2'	MOUNTFRAME22	28390	2X2' Surface Mount Frame 23.82"x23.82"x2.83" (605x605x72mm)
DRYWALL FRAME 2X4'	DWFRAME24	98036	2X4' Drywall Frame 49.33"x25.32"x1.50" (1253x643x38mm)
DRYWALL FRAME 2X2'	DWFRAME22	98035	2X2' Drywall Frame 25.32"x25.32"x1.50" (643x643x38mm)
SUSPENSION CABLE 2X4'	SUSPCABLE24	28393	70.9" (1.8m) Aircraft Suspension Cable (Set of 6 Cables for 1 2X4' Fixture)
SUSPENSION CABLE 2X2'	SUSPCABLE22	28392	70.9" (1.8m) Aircraft Suspension Cable (Set of 4 Cables for 1 2X2' Fixture)

TROFFER HE LINE



SPECIFICATIONS

	Model	Product	CCT	Lumens (lm)	LPW	Beam Angle	CBCP (cd)	CRI (typ.)	Dim	Life (hrs)	Voltage	
 TROFFER HE 2X4' 30W	30TROF24DIM/830/277V	28333	3000K	4200	140	120°	N.A.	82	Yes	50,000	120-277V	✓
	30TROF24DIM/835/277V	28334	3500K	4200	140	120°	N.A.	82	Yes	50,000	120-277V	✓
	30TROF24DIM/840/277V	28335	4000K	4300	143	120°	N.A.	82	Yes	50,000	120-277V	✓
 TROFFER HE 2X2' 25W	25TROF22DIM/830/277V	28329	3000K	3500	140	120°	N.A.	82	Yes	50,000	120-277V	✓
	25TROF22DIM/835/277V	28330	3500K	3500	140	120°	N.A.	82	Yes	50,000	120-277V	✓
	25TROF22DIM/840/277V	28331	4000K	3600	143	120°	N.A.	82	Yes	50,000	120-277V	✓
 TROFFER HE 1X4' 26W	26TROF14DIM/835/277V	97939	3500K	3250	125	120°	N.A.	82	Yes	50,000	120-277V	✓
	26TROF14DIM/840/277V	97940	4000K	3300	127	120°	N.A.	82	Yes	50,000	120-277V	✓
 STEP DIMMING MODULE 100/50	To order this option add /STEPDIM after the model number ex. 30TROF24DIM/835/277V/STEPDIM		To order this and emergency add both: ex. 30TROF24DIM/835/277V/STEPDIM/EM									
 SENSOR	To order this option add /OCCDIM after the model number ex. 30TROF24DIM/835/277V/OCCDIM		To order this and emergency add both: ex. 30TROF24DIM/835/277V/OCCDIM/EM									
 EMERGENCY DRIVER 10W	To order this option add /EM after the model number ex. 30TROF24DIM/835/277V/EM		To order this and step dimming or sensor add both: ex. 30TROF24DIM/835/277V/STEPDIM/EM									

Easy installation for new construction or retrofit

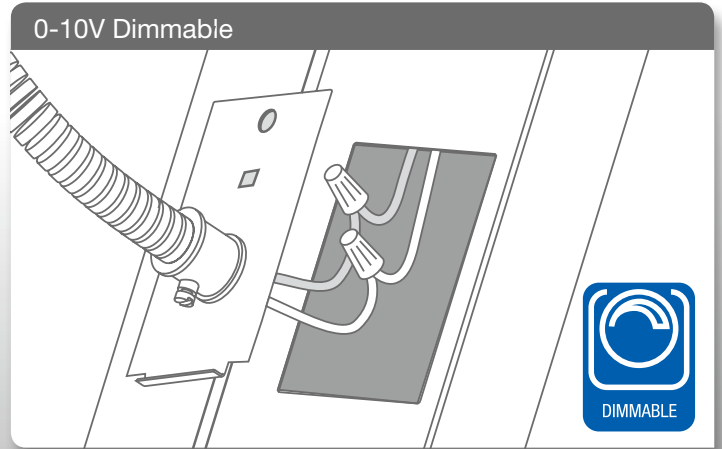
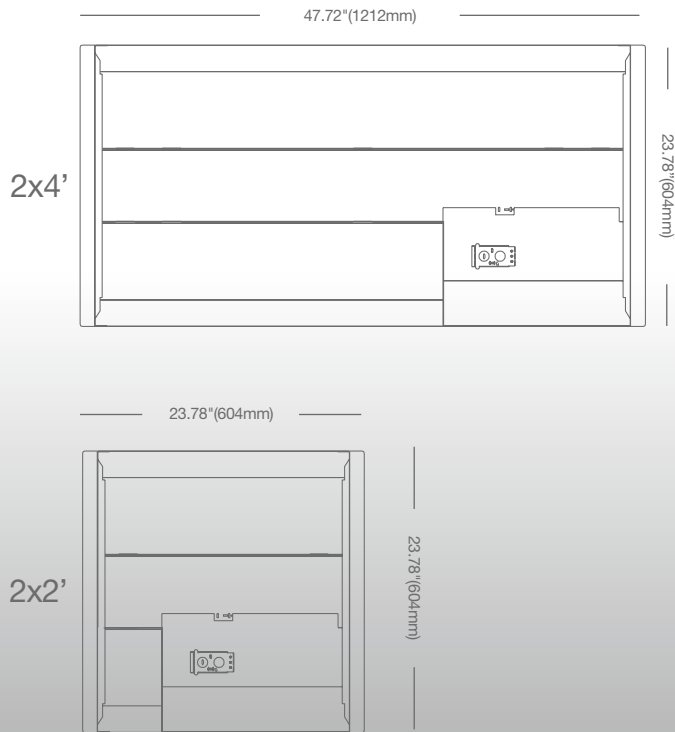

- High performance lighting distribution**
- Exceptional efficacy >140 LPW**
- 120-277V & 0-10V dimming control compatible**
- 100.000-hr lifetime, 10-yr warranty**

Elevate Your Lighting









ACCESSORIES

Model	Product	Description
DWFRAME24	98036	2X4' Drywall Frame
DWFRAME14	98037	1X4' Drywall Frame
DWFRAME22	98035	2X2' Drywall Frame

TROFFER RETROFIT KIT HE LINE



SPECIFICATIONS

	Model	Product	CCT	Lumens (lm)	LPW	Beam Angle	CBCP (cd)	CRI (typ.)	Dim	Life (hrs)	Voltage	
 RETROFIT KIT HE 2X4' 30W	30TROPKIT24DIM/830/277V	28341	3000K	4200	140	120°	N.A.	82	Yes	100,000	120-277V	✓
	30TROPKIT24DIM/835/277V	28342	3500K	4200	140	120°	N.A.	82	Yes	100,000	120-277V	✓
	30TROPKIT24DIM/840/277V	28343	4000K	4300	144	120°	N.A.	82	Yes	100,000	120-277V	✓
 RETROFIT KIT HE 2X2' 25W	25TROPKIT22DIM/830/277V	28337	3000K	3500	140	120°	N.A.	82	Yes	100,000	120-277V	✓
	25TROPKIT22DIM/835/277V	28338	3500K	3500	140	120°	N.A.	82	Yes	100,000	120-277V	✓
	25TROPKIT22DIM/840/277V	28339	4000K	3600	144	120°	N.A.	82	Yes	100,000	120-277V	✓
 STEP DIMMING MODULE 100/50	To order this option add /STEPDIM after the model number ex. 30TROPKIT24DIM/835/277V/STEPDIM						To order this and emergency add both: ex. 30TROPKIT24DIM/835/277V/STEPDIM/EM					
 SENSOR	To order this option add /OCCDIM after the model number ex. 30TROPKIT24DIM/835/277V/OCCDIM						To order this and emergency add both: ex. 30TROPKIT24DIM/835/277V/OCCDIM/EM					
 EMERGENCY DRIVER 10W	To order this option add /EM after the model number ex. 30TROPKIT24DIM/835/277V/EM						To order this and step dimming or sensor add both: ex. 30TROPKIT24DIM/835/277V/STEPDIM/EM					



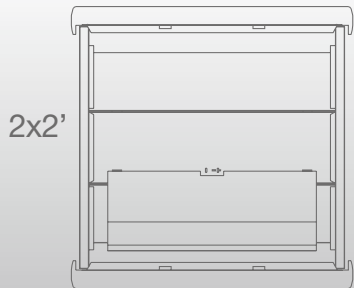
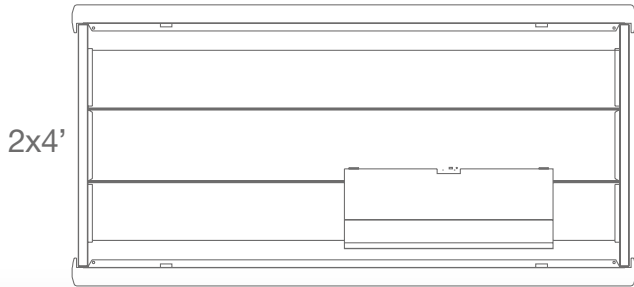

* Remote control available for SENSOR

TROFFER RETROFIT KIT HE LINE

Universally compatible to upgrade 2x2' and 2x4' troffers and louvers while continuing to utilize the existing luminaire housing.



Housing	Retrofit Kit Dimensions	Retrofit Kit Dimensions (w/o brackets)
2x4'	47.83"x23.94"x2.76"(1215x608x70mm)	46.77"x20.59"x2.76"(1188x523x70mm)
2x2'	23.90"x23.94"x2.76"(607x608x70mm)	22.51"x20.59"x2.76"(572x523x70mm)

-  **High performance lighting distribution**
-  **Exceptional efficacy >140 LPW**
-  **120-277V & 0-10V dimming control compatible**
-  **100,000-hr lifetime, 10-yr warranty**

High-Performance Light Distribution

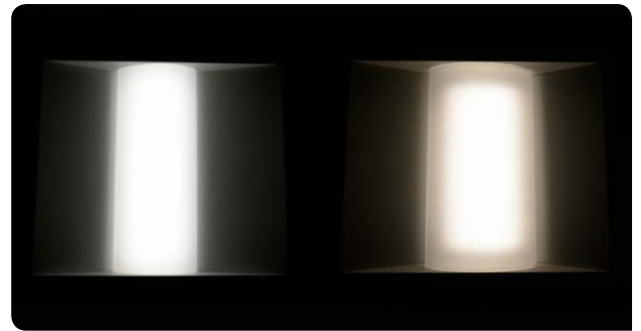

GREEN CREATIVE Retrofit Kit

Other Retrofit Kit

Elevate Your Lighting

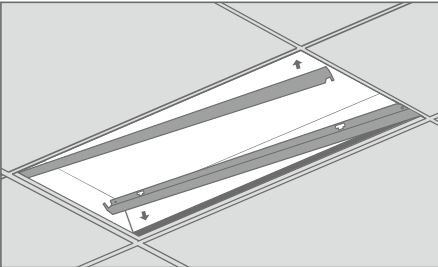
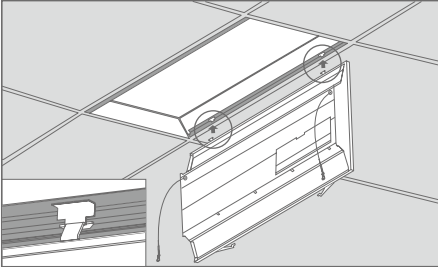
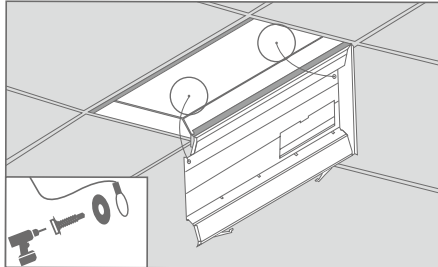
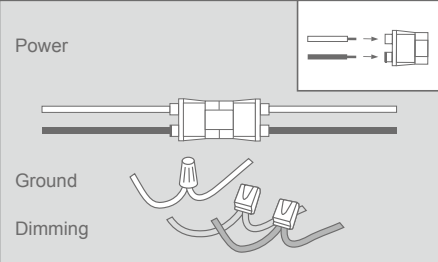

INSTALLATION GUIDE

1. 
2. 
3. 
4. 

Power

Ground

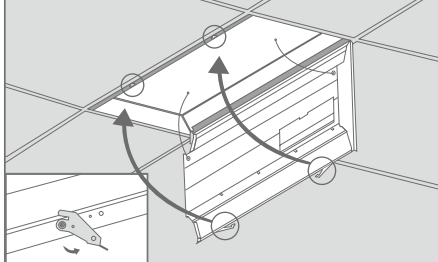
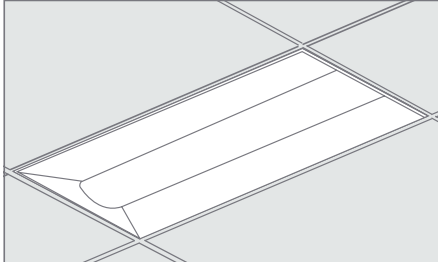
Dimming
5. 
6. 

TRACK LINE



TRACK 33W L

TRACK 33W L
TRACK 22W M



SPECIFICATIONS

	Model	Product	CCT	Lumens (lm)	Equiv.	LPW	Beam Angle	CBCP (cd)	CRI (typ.)	Dim	Life (hrs)	Voltage	
	33TRLG4DIM/927/W/H	97623	2700K	2200	39W HID	65	25°/38°	10,000/5150	90	Yes	40,000	120V	✓
	33TRLG4DIM/930/W/H	97629	3000K	2300	39W HID	68	25°/38°	10,350/5250	90	Yes	40,000	120V	✓
	33TRLG4DIM/927/W/J	97624	2700K	2200	39W HID	65	25°/38°	10,000/5150	90	Yes	40,000	120V	✓
	33TRLG4DIM/930/W/J	97630	3000K	2300	39W HID	68	25°/38°	10,350/5250	90	Yes	40,000	120V	✓
	33TRLG4DIM/927/B/H •	97626	2700K	2200	39W HID	65	25°/38°	10,000/5150	90	Yes	40,000	120V	✓
	33TRLG4DIM/930/B/H •	97632	3000K	2300	39W HID	68	25°/38°	10,350/5250	90	Yes	40,000	120V	✓
	33TRLG4DIM/927/B/J •	97627	2700K	2200	39W HID	65	25°/38°	10,000/5150	90	Yes	40,000	120V	✓
	33TRLG4DIM/930/B/J •	97633	3000K	2300	39W HID	68	25°/38°	10,350/5250	90	Yes	40,000	120V	✓
	22TRMG4DIM/927/W/H	97587	2700K	1200	20W HID	55	25°/38°/15°	6300/3250/12,200	90	Yes	40,000	120V	✓
	22TRMG4DIM/930/W/H	97599	3000K	1250	20W HID	57	25°/38°/15°	6700/3450/13,000	90	Yes	40,000	120V	✓
	22TRMG4DIM/927/W/J	97588	2700K	1200	20W HID	55	25°/38°/15°	6300/3250/12,200	90	Yes	40,000	120V	✓
	22TRMG4DIM/930/W/J	97600	3000K	1250	20W HID	57	25°/38°/15°	6700/3450/13,000	90	Yes	40,000	120V	✓
	22TRMG4DIM/927/B/H •	97590	2700K	1200	20W HID	55	25°/38°/15°	6300/3250/12,200	90	Yes	40,000	120V	✓
	22TRMG4DIM/930/B/H •	97602	3000K	1250	20W HID	57	25°/38°/15°	6700/3450/13,000	90	Yes	40,000	120V	✓
	22TRMG4DIM/927/B/J •	97591	2700K	1200	20W HID	55	25°/38°/15°	6300/3250/12,200	90	Yes	40,000	120V	✓
	22TRMG4DIM/930/B/J •	97603	3000K	1250	20W HID	57	25°/38°/15°	6700/3450/13,000	90	Yes	40,000	120V	✓

* The J and L type adaptors are compatible with single or two-circuit track types. The H type adaptor is only compatible with single-circuit track types
• Black finish

Interchangeable lens options (TRACK L & M)

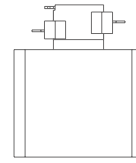
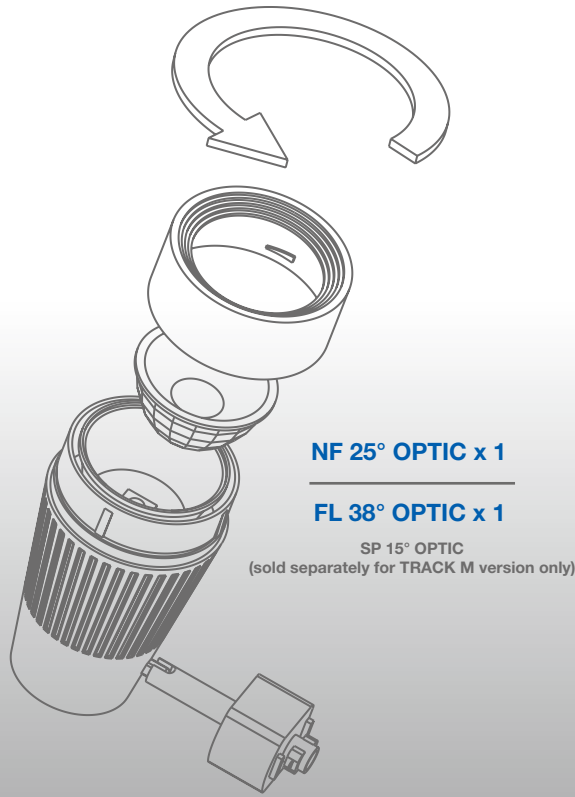

H - Halo Track

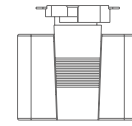

J - Juno Track
For use with single and two-circuit track applications

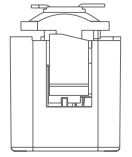

L - Lightolier Track (MTO)
For use with single and two-circuit track applications

Dimensions

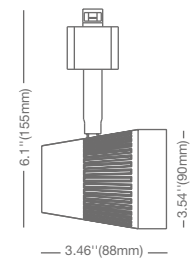
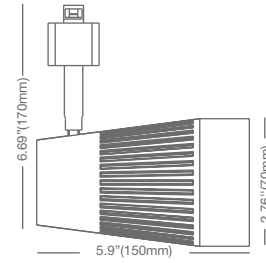

- Exceptional color rendering CRI 90
- Tight LED binning – 4-step Macadam ellipse
- Sleek design, integrated driver
- NF & FL optics ship with TRL & TRM versions

TRACK L & M - High CRI

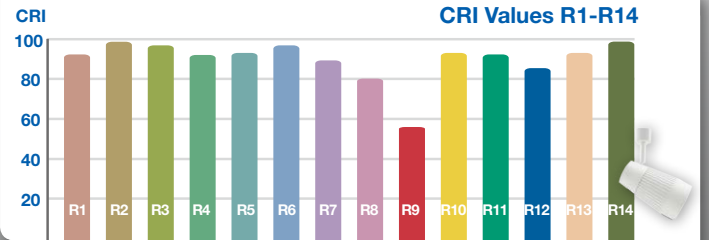

SPECIFICATIONS

Model	Product	CCT	Lumens (lm)	Equiv.	LPW	Beam Angle	CBCP (cd)	CRI (typ.)	Dim	Life (hrs)	Voltage	
8TRSG4DIM/827NF30/W/H	16340	2700K	600	75W Hal	68	30°	1905	80	Yes	40,000	120V	✓
8TRSG4DIM/830NF30/W/H	16346	3000K	625	75W Hal	71	30°	1950	80	Yes	40,000	120V	✓
8TRSG4DIM/827NF30/W/J	16341	2700K	600	75W Hal	68	30°	1905	80	Yes	40,000	120V	✓
8TRSG4DIM/830NF30/W/J	16347	3000K	625	75W Hal	71	30°	1950	80	Yes	40,000	120V	✓
8TRSG4DIM/827NF30/B/H •	16343	2700K	600	75W Hal	68	30°	1905	80	Yes	40,000	120V	✓
8TRSG4DIM/830NF30/B/H •	16349	3000K	625	75W Hal	71	30°	1950	80	Yes	40,000	120V	✓
8TRSG4DIM/827NF30/B/J •	16344	2700K	600	75W Hal	68	30°	1905	80	Yes	40,000	120V	✓
8TRSG4DIM/830NF30/B/J •	16350	3000K	625	75W Hal	71	30°	1950	80	Yes	40,000	120V	✓



* The J and L type adaptors are compatible with single or two-circuit track types. The H type adaptor is only compatible with single-circuit track types
• Black finish

HIGH BAY LINE



185W Medium Optic (ME) comes standard



130W Medium Optic (ME) comes standard



95W Prismatic Optic (GP) comes standard

SPECIFICATIONS

	Model	Product	CCT	Lumens (lm)	Equiv.	LPW	Beam Dist.	CBCP (cd)	CRI (typ.)	Dim	Life (hrs)	Voltage	Max Temp.	
 HIGH BAY 185W	185HBAY/840/GP	58227	4000K	22,700	400W HID 324W FLUO.	123	100°	N.A.	82	Yes	100,000	120-277V	131°F/55°C	✓
	185HBAY/840/ME	58228	4000K	25,000		135	80°	N.A.	82	Yes	100,000	120-277V	131°F/55°C	✓
	185HBAY/840/AL	58230	4000K	25,000		135	45°/90°	N.A.	82	Yes	100,000	120-277V	131°F/55°C	✓
	185HBAY/850/GP	58232	5000K	22,700		123	100°	N.A.	82	Yes	100,000	120-277V	131°F/55°C	✓
	185HBAY/850/ME	58233	5000K	25,000		135	80°	N.A.	82	Yes	100,000	120-277V	131°F/55°C	✓
	185HBAY/850/AL	58235	5000K	25,000		135	45°/90°	N.A.	82	Yes	100,000	120-277V	131°F/55°C	✓
 HIGH BAY 130W	130HBAY/840/GP	58212	4000K	17,200	250W HID 216W FLUO.	132	100°	N.A.	82	Yes	100,000	120-277V	131°F/55°C	✓
	130HBAY/840/ME	58213	4000K	18,900		145	80°	N.A.	82	Yes	100,000	120-277V	131°F/55°C	✓
	130HBAY/840/AL	58215	4000K	18,900		145	45°/90°	N.A.	82	Yes	100,000	120-277V	131°F/55°C	✓
	130HBAY/850/GP	58217	5000K	17,200		132	100°	N.A.	82	Yes	100,000	120-277V	131°F/55°C	✓
	130HBAY/850/ME	58218	5000K	18,900		145	80°	N.A.	82	Yes	100,000	120-277V	131°F/55°C	✓
	130HBAY/850/AL	58220	5000K	18,900		145	45°/90°	N.A.	82	Yes	100,000	120-277V	131°F/55°C	✓
 HIGH BAY 95W	95HBAY/840/GP	58197	4000K	11,800	175W HID 162W FLUO.	125	100°	N.A.	82	Yes	100,000	120-277V	131°F/55°C	✓
	95HBAY/840/ME	58198	4000K	13,100		138	80°	N.A.	82	Yes	100,000	120-277V	131°F/55°C	✓
	95HBAY/840/AL	58200	4000K	13,100		138	45°/90°	N.A.	82	Yes	100,000	120-277V	131°F/55°C	✓
	95HBAY/850/GP	58202	5000K	11,900		125	100°	N.A.	82	Yes	100,000	120-277V	131°F/55°C	✓
	95HBAY/850/ME	58203	5000K	13,200		139	80°	N.A.	82	Yes	100,000	120-277V	131°F/55°C	✓
	95HBAY/850/AL	58205	5000K	13,200		139	45°/90°	N.A.	82	Yes	100,000	120-277V	131°F/55°C	✓
 347V & 480V TRANSFORMER	For 347V - /347V For 480V - /480V		To order this option add either /347V or /480V after the model number ex. 130HBAY/840/ME/347V											
 SENSOR	Up to 20' Mounting Heights - /OCCDIM20 Up to 40' Mounting Heights - /OCCDIM40		To order this option add either /OCCDIM20 or /OCCDIM40 after the model number ex. 130HBAY/840/ME/347V/OCCDIM40											
 EMERGENCY DRIVER 20W	To order this option add /EM after the model number ex. 130HBAY/840/ME/347V/OCCDIM40/EM													
 SURGE PROTECTOR 10KV	To order this option add /SP after the model number ex. 130HBAY/840/ME/347V/OCCDIM40/EM/SP													

* HIGH BAY 185W GP & 95W GP meet DLC Standard requirements. All other models meet DLC Premium requirements.

** 347V & 480V TRANSFORMER cannot be used with EMERGENCY DRIVER 20W

Customizable optics, installation and accessories optimize fixture performance to meet all low and high bay application needs

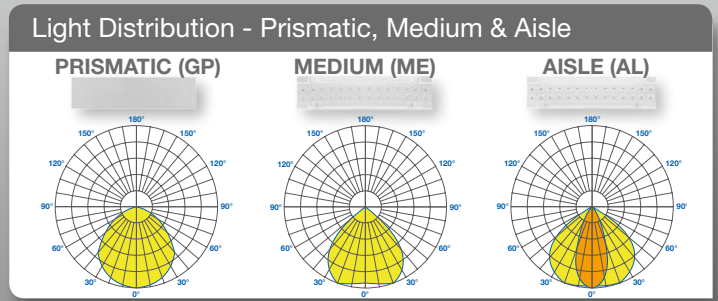
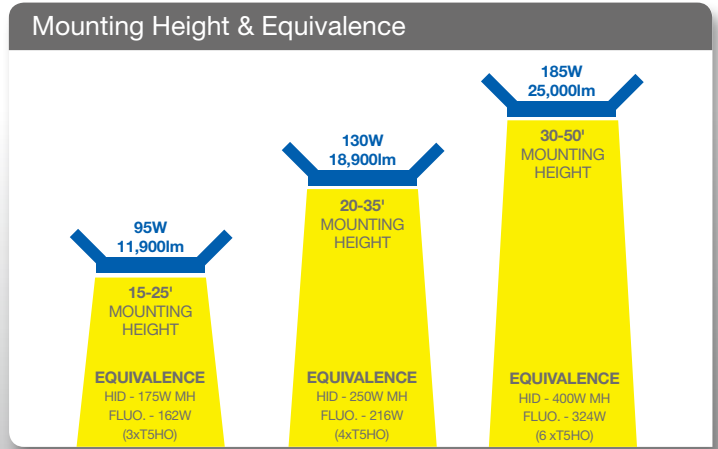
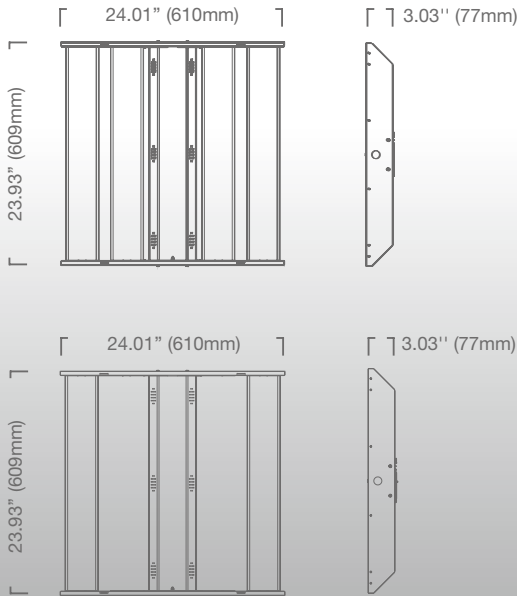

- Suspended or pendant mount installation**
- 2x2' compact form factor with flicker-free driver**
- 120-277V & 0-10V dimming control compatible**
- 100,000-hr lifetime, 10-yr warranty**

ACCESSORIES

Model	Product	Description
SENSOR REMOTE	HBAYOCCDIMRC	97859 Remote Control for OCCDIM20 & OCCDIM40
WIRE GUARD 4X	HBAYWG4XMOD	58282 130W & 185W High Bay Wire Guard
WIRE GUARD 2X	HBAYWG2XMOD	58281 95W High Bay Wire Guard
PENDANT MOUNT	HBAYPENDHANG	58283 Rod/Stem Pendant Mount (Rod/Stem Not Included)
AIRCRAFT CABLE 10'	HBAY10CABLE	97862 10' Aircraft Cable & Cable Gripper (For Use with V-hooks)
AIRCRAFT CABLE 20'	HBAY20CABLE	97863 20' Aircraft Cable & Cable Gripper (For Use with V-hooks)



GREEN CREATIVE

1200 Bayhill Drive, Suite 220
San Bruno, CA 94066
Tel / Fax: (866) 774-5433
info@greencreative.com

www.greencreative.com



/ GREENCREATIVELED



/ GClightingLED



/ GREEN CREATIVE



GREENCREATIVE