



 **FANIMATION**<sup>®</sup>  
SHOWROOM COLLECTION



220 VOLT PRODUCT



FANIMATION®  
C E I L I N G F A N S

 888.567.2055

 [fanimation.com](http://fanimation.com)

 [fanimation](https://www.facebook.com/fanimation)

 [fanimation](https://twitter.com/fanimation)

 [fanimationfans](https://www.pinterest.com/fanimationfans)

 [fanimationfan](https://www.youtube.com/fanimationfan)

 10983 Bennett Parkway, Zionsville, Indiana 46077

## FANIMATION : AIR APPARENT

Fanimation's focus is producing creative and functional fans that provide ultimate personal comfort using the latest technology for energy efficiency and seamless control. From our humble beginnings in 1984, inside Founder and CEO Tom Frampton's Pasadena, California garage, ingenuity and quality craftsmanship have been central in every product we manufacture. Our timeless and inspired fans are sought across the globe.

You will find Fanimation in some of the most luxurious locales—from tropical resorts to the heart of your home.

# CHOOSING YOUR FAN

## LOCATION IS EVERYTHING

Where you will install your fan is the first step in selecting the right fan for your space.

- Dry, indoor location: Choose from any of our fans—dry, damp or wet rated.
- Outdoor covered or high-humidity indoor location: Choose from our damp or wet rated fans.
- Outdoor location with likely direct contact with water: Choose from our wet rated fans.

**We've made it easy for you!**

Look for these icons to identify location rating:

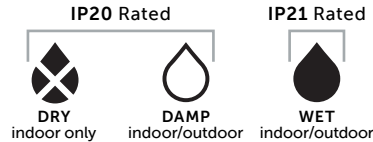

## SIZE MATTERS

The size of your room will help determine the size of your fan, identified by blade sweep. The following are general guidelines.

- Optimal performance will come from mounting your fan in the center of the room.
- If you have a long or large room, consider the use of multiple fans
- Scale is a personal preference. Large diameter fans can go in both small rooms and larger rooms—it's all in the look you desire.

**SMALL ROOM**  
132cm or smaller

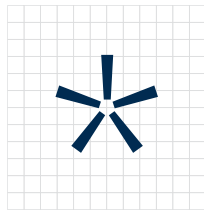

**LARGE ROOM**  
132cm or larger

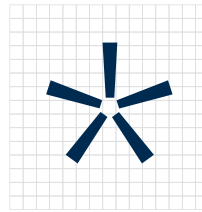

**GREAT ROOM**  
152cm or larger

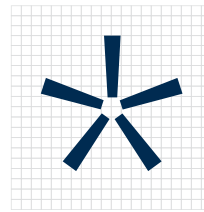

Recommended downrod length is based on ceiling height. Ideal distance from floor to fan blades is 2,13m to 2,74 m

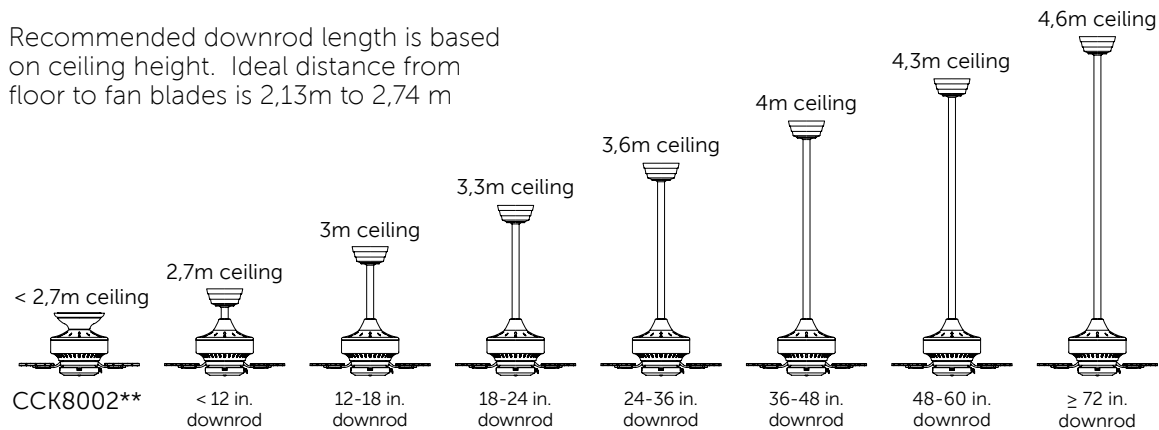



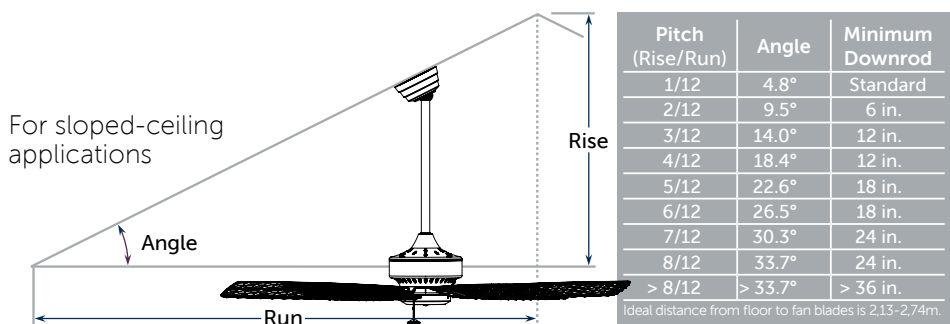

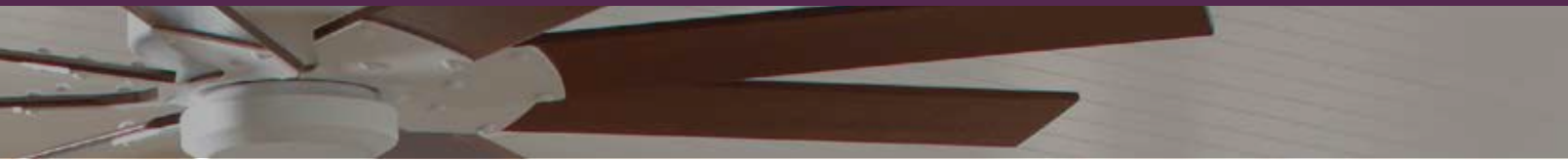



For lengths greater than 72 in., join two downrods with DR1-CP\*\* coupler





## IDENTIFYING FEATURES IMPORTANT TO YOU

We offer a diverse line of fans with equally diverse features. As you choose your fan, identify the features that matter to you—use Features Legend below to understand the Features icons.

| fan control type  |   |   |   | light kit included +<br>lamping info  | number of fan<br>speeds + location of<br>reversing switch  | fan, blades and light<br>sold separately  | features energy-<br>efficient DC<br>motor   |
|---|---|---|---|---|--|---|---|
| <br><b>CONTROL</b><br>wall | <br><b>CONTROL</b><br>remote | <br><b>CONTROL</b><br>pull chain | <br><b>CONTROL</b><br>rotary | <br><b>WATTAGE</b><br>bulb style | <br><b>SPEED</b><br>reverse location |  |  |

## UNDERSTANDING AIRFLOW

We provide airflow information—at high speed—for each fan. Airflow is measured in CFM (cubic feet per minute), energy used is measured in watts and the energy efficiency of the fan is measured in CFM per watt.

### ENERGY INFORMATION AT HIGH SPEED:

| Airflow  | Electricity Use                          | Airflow Efficiency   |
|--|--|--|
| <b>6942</b><br>Cubic Feet<br>Per Minute                    | <b>65</b><br>Watts<br>(excluding lights) | <b>107</b><br>Cubic Feet Per<br>Minute Per Watt                |
| The greater<br>the number,<br>the greater<br>the air moved | Energy<br>consumed                       | The greater<br>the number, the<br>more efficient<br>the fan is |

## FANIMATION MOTORS—AC AND DC

All Fanimation motors are built using high quality materials and components, insuring years of reliable and dependable operation for every Fanimation fan.

- Our fans are equipped with either an AC motor or DC motor.
- AC motors use supplied power directly and regulate speeds by controlling frequency.
- DC motors convert supplied power and regulate speeds by controlling electrical current.
- Our AC motors come in 1-, 3- and 4-speed variants.
- Our DC motors come with 6 speeds. DC motors are more efficient, generate more torque and are virtually silent.

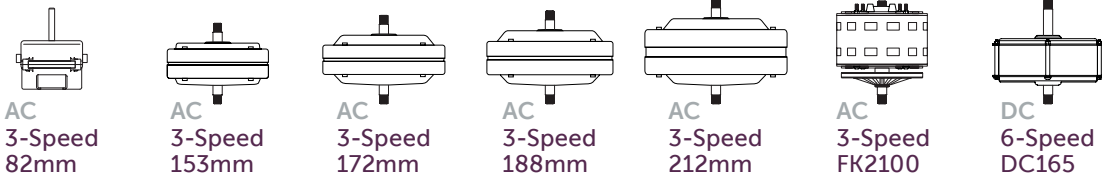

## SEASONAL CEILING FAN USE

Ceiling fans save money year-round when turning in the proper direction.

**WARM WEATHER**  
Airflow with counter-clockwise rotation, as you look up, provides a cooling breeze

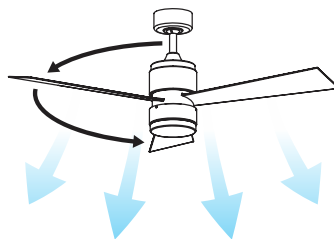

**COOL WEATHER**  
Airflow with clockwise rotation, as you look up, forces warm air downward

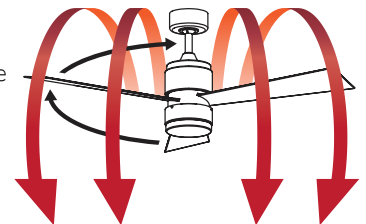

**Need more assistance? Call 1-888-567-2055**

INDOOR

AIRE DÉCOR  
16



BENITO  
14



BOURBON STREET  
17



ENIGMA  
28



LEVON AC  
12



PALMETTO  
18



ZONIX  
10



INDOOR/OUTDOOR

AMERICANA  
50



ASCENSION  
30



BELLERIA  
46

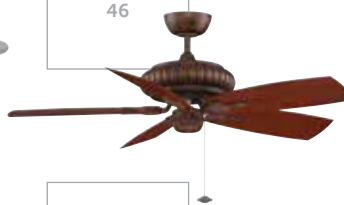

BREWMASTER  
54



EDGEWOOD DELUXE WET  
42

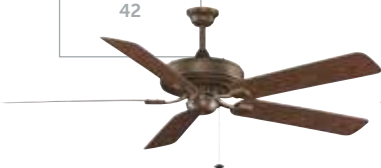

EDGEWOOD WET  
40

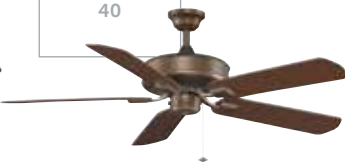

EXTRAORDINAIRE  
26



HUGH 44  
22



HUGH 52  
24



ISLANDER AC  
48



ODYN  
36



PUNKAH  
52



SPITFIRE  
38



WINDPOINTE CUSTOM  
44



XENO WET  
32



ZONIX WET  
34

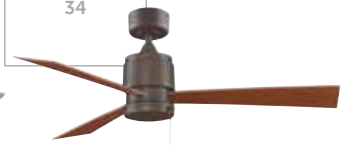

## PORTABLES

ARDEN  
58



MINI BREEZE  
60



## ACCESSORIES

BLADES  
65



CONTROLS  
63



LIGHTING  
61



DOWNRODS &  
ACCESSORIES  
62



## TABLE OF CONTENTS

|   |    |
|---|----|
| Aire Décor® .....                       | 16 |
| Americana® .....                        | 50 |
| Arden™ .....                            | 58 |
| Ascension™ .....                        | 30 |
| Belleria® .....                         | 46 |
| Benito™ .....                           | 14 |
| Bourbon Street® .....                   | 17 |
| Brewmaster® .....                       | 54 |
| Edgewood® Deluxe Wet .....              | 42 |
| Edgewood® Wet .....                     | 40 |
| Enigma® .....                           | 28 |
| Extraordinaire® .....                   | 26 |
| Hugh™ 44 .....                          | 22 |
| Hugh™ 52 .....                          | 24 |
| Islander® .....                         | 48 |
| Levon™ .....                            | 12 |
| Mini Breeze™ .....                      | 60 |
| Odyn™ .....                             | 36 |
| Palmetto® .....                         | 18 |
| Punkah® .....                           | 52 |
| Spitfire™ .....                         | 38 |
| Windpointe® Custom .....                | 44 |
| Xeno™ Wet .....                         | 32 |
| Zonix™ .....                            | 10 |
| Zonix™ Wet .....                        | 34 |
| Choosing Your Fan.....                  | 3  |
| Lighting Kits .....                     | 61 |
| Fitters, Shades & Decorative Glass..... | 61 |
| Downrods & Accessories .....            | 62 |
| Wall Controls.....                      | 63 |
| Remote Controls .....                   | 64 |
| Blades .....                            | 65 |
| Antique Fan Museum .....                | 67 |
| Index .....                             | 69 |







INDOOR

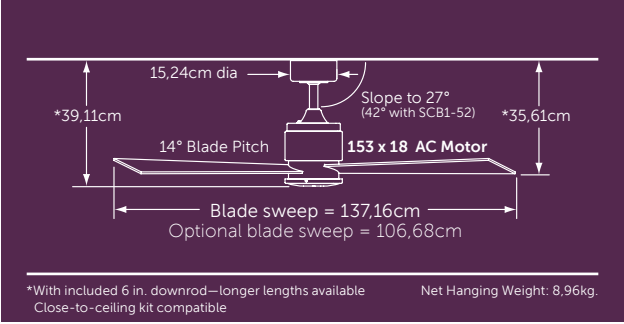

**FAN: FP4620OB-220 (1)**  
oil-rubbed bronze assembly with reversible cherry/walnut wood blades  
● cherry side showing



**FAN: FP4620SN-220 (1)**  
satin nickel assembly with reversible cherry/walnut wood blades  
● cherry side showing



**SOLD SEPARATELY:**



See page 63-64 for optional controls

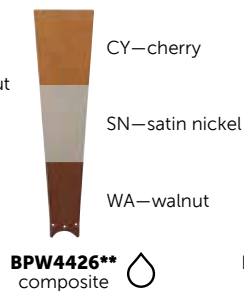

ZONIX™

 **FAN: FP4620SN-220 (1)**  
satin nickel assembly with  
reversible cherry/walnut  
wood blades

- walnut side showing

|                      |                     |
|----------------------|---------------------|
| oil-rubbed<br>bronze | satin<br>nickel     |
| cherry walnut        | cherry walnut       |
| <b>FP4620OB-220</b>  | <b>FP4620SN-220</b> |

INCLUDED:



blade set



CW40-220

ENERGY INFORMATION  
AT HIGH SPEED:

Airflow  
**3952**  
Cubic Feet  
Per Minute

Electricity Use  
**38**  
Watts  
(excluding lights)

Airflow Efficiency  
**104**  
Cubic Feet Per  
Minute Per Watt

  
**4-SPEED AC**  
reverse switch  
on fan

  
**CONTROL**  
wall

  
**DRY (IP20)**  
indoor only

**LIMITED LIFETIME MOTOR WARRANTY**

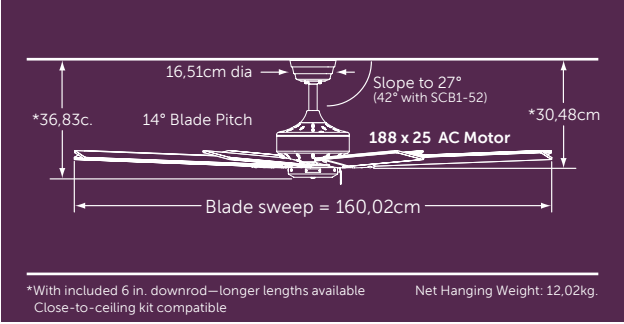

**FAN: FP7910OB-220 (1)**  
oil-rubbed bronze assembly  
with walnut blades

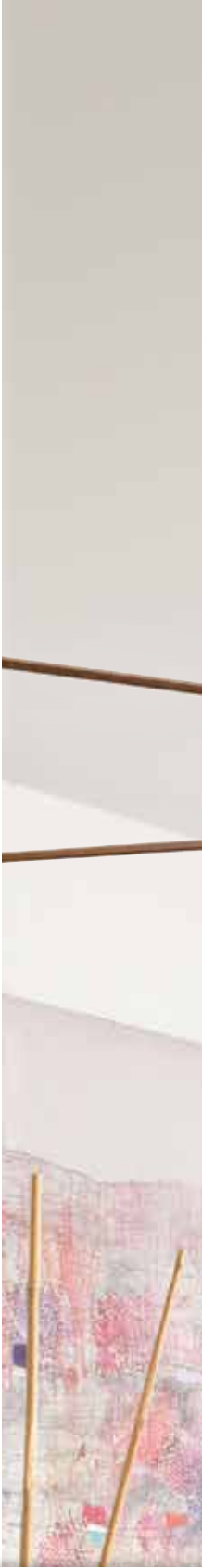

**SOLD SEPARATELY:**



See page 63-64 for  
optional controls

LEVON™

**FAN: FP7910OB-220** (1)  
oil-rubbed bronze assembly  
with walnut blades

oil-rubbed  
bronze  
walnut  
FP7910OB-220

  
**3-SPEED AC**  
reverse switch  
on fan

  
**CONTROL**  
pull chain

  
**DRY (IP20)**  
indoor only

INCLUDED:

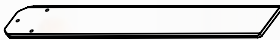

blade set

ENERGY INFORMATION  
AT HIGH SPEED:

Airflow  
**5151**  
Cubic Feet  
Per Minute

Electricity Use  
**58**  
Watts  
(excluding lights)

Airflow Efficiency  
**89**  
Cubic Feet Per  
Minute Per Watt

LIMITED LIFETIME MOTOR WARRANTY

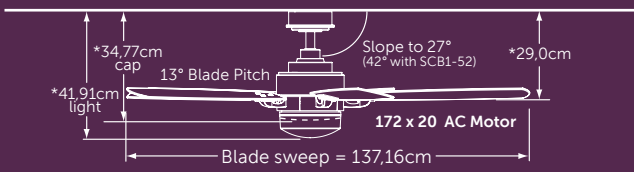

\*With included 4.5 in. downrod—longer lengths available  
Close-to-ceiling kit compatible

Net Hanging Weight: 8.89kg.



SOLD SEPARATELY:



See page 63-64 for optional controls

# BENITO™

**FAN: FP8003BN-220 (1)**  
 brushed nickel assembly with  
 opal frosted glass and reversible  
 cherry/walnut wood blades  
 • walnut side showing

|                     |                     |
|---------------------|---------------------|
| brushed<br>nickel   | matte<br>white      |
| cherry walnut       | matte<br>white      |
| <b>FP8003BN-220</b> | <b>FP8003MW-220</b> |



(2) 9W  
CFL base



3-SPEED AC  
reverse switch  
on fan



CONTROL  
remote



DRY (IP20)  
indoor only

## INCLUDED:



blade set



light kit  
light cover



TRL4WH-220

## ENERGY INFORMATION AT HIGH SPEED:

Airflow  
**5535**  
Cubic Feet  
Per Minute

Electricity Use  
**60**  
Watts  
(excluding lights)

Airflow Efficiency  
**92**  
Cubic Feet Per  
Minute Per Watt

LIMITED LIFETIME MOTOR WARRANTY

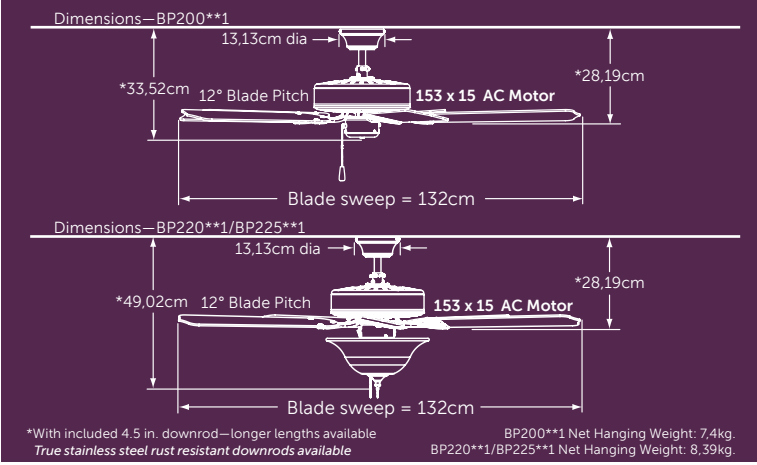

**FAN: BP200MW1-220** (1)  
matte white assembly in  
downrod configuration with  
matte white wood blades



**FAN: BP200OB1-220** (1)  
oil-rubbed bronzed assembly in  
downrod configuration with reversible  
cherry/walnut wood blades

- walnut side showing



**FAN: BP200SN1-220** (1)  
satin nickel assembly in flush-mount  
configuration with reversible cherry/  
walnut wood blades

- cherry side showing



**FAN: BP220MW1-220** (1)  
matte white assembly in downrod  
configuration with white frosted glass  
bowl and matte white wood blades



**SOLD SEPARATELY:**



control options: p.63-64  
light options: p.61



# AIRE DECOR®

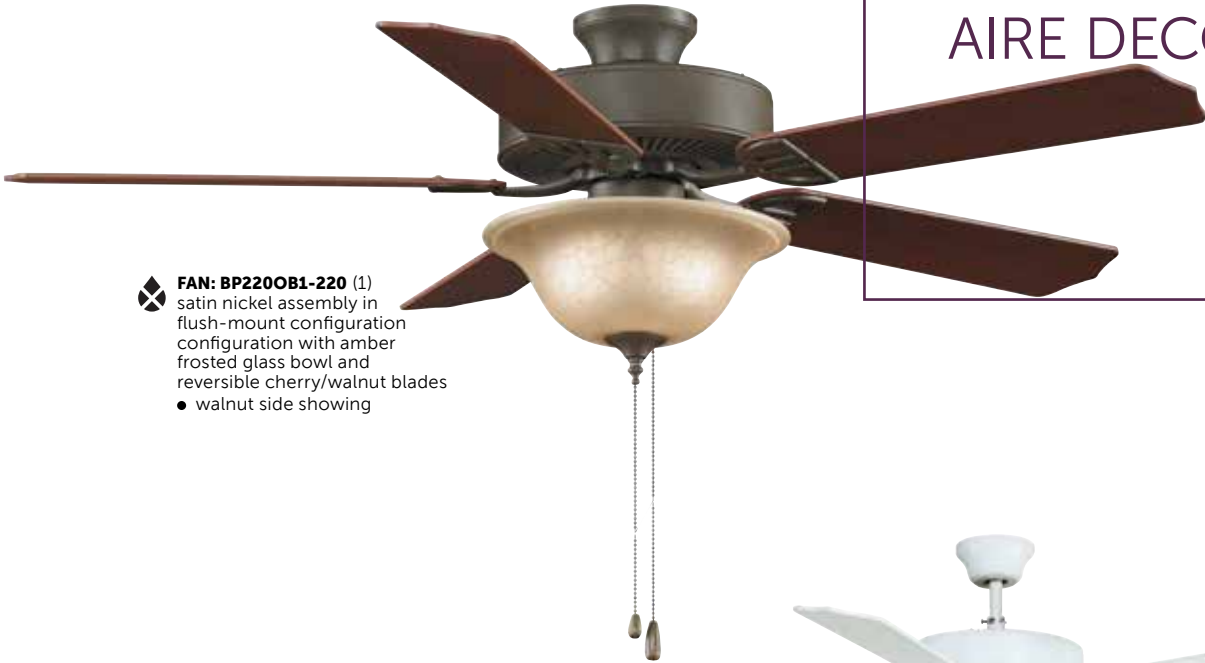

**FAN: BP220OB1-220** (1)  
satin nickel assembly in flush-mount configuration with amber frosted glass bowl and reversible cherry/walnut blades  
● walnut side showing



**FAN: BP220MW1-220** (1)  
matte white assembly in downrod configuration with white frosted glass bowl and matte white wood blades



**FAN: BP225OB1-220** (1)  
oil-rubbed bronze assembly in downrod configuration with white frosted glass bowl (amber glass version available: BP220OB1-220) and cherry/walnut reversible wood blades  
● walnut side showing

|  |   |  |
|--|---|--|
| matte white                                | oil-rubbed bronze   | satin nickel                               |
| matte white                                | cherry walnut   | cherry walnut                              |
| <b>BP220MW1-220</b><br><b>BP220MW1-220</b> | <b>BP220OB1-220</b><br><b>BP220OB1-220</b><br><b>BP225OB1-220</b> | <b>BP200SN1-220</b><br><b>BP220SN1-220</b> |

  
**SEE INCLUDED**  
incandescent  
candelabra

  
**3-SPEED AC**  
reverse switch  
on fan

  
**CONTROL**  
pull chain

  
**DRY (IP20)**  
indoor only

**INCLUDED:**



blade set



light kit—(3) 60W  
(bulbs not included)

BP220\*\*1-220 & BP225OB1-220

**ENERGY INFORMATION**  
AT HIGH SPEED:

Airflow  
**4510**  
Cubic Feet  
Per Minute

Electricity Use  
**49**  
Watts  
(excluding lights)

Airflow Efficiency  
**93**  
Cubic Feet Per  
Minute Per Watt

**LIMITED LIFETIME MOTOR WARRANTY**

Due to their complex systems, multiple components and special installation requirements, we recommend contacting our Customer Service department for assistance with ordering—888.567.2055

For dimensions and configurations, please see our comprehensive Specification Book or model-specific specification sheet, available at [www.fanimation.com](http://www.fanimation.com)

## BOURBON STREET®

- ✦ **MOTOR: FP580BL-220** (1)  
black (required but not shown)
- HEAD: FP510BL** (3)  
black short assembly
- BLADES: FP1018** (3)  
132cm sweep reversible oak/  
walnut wood
- oak side showing

PALMETTO®

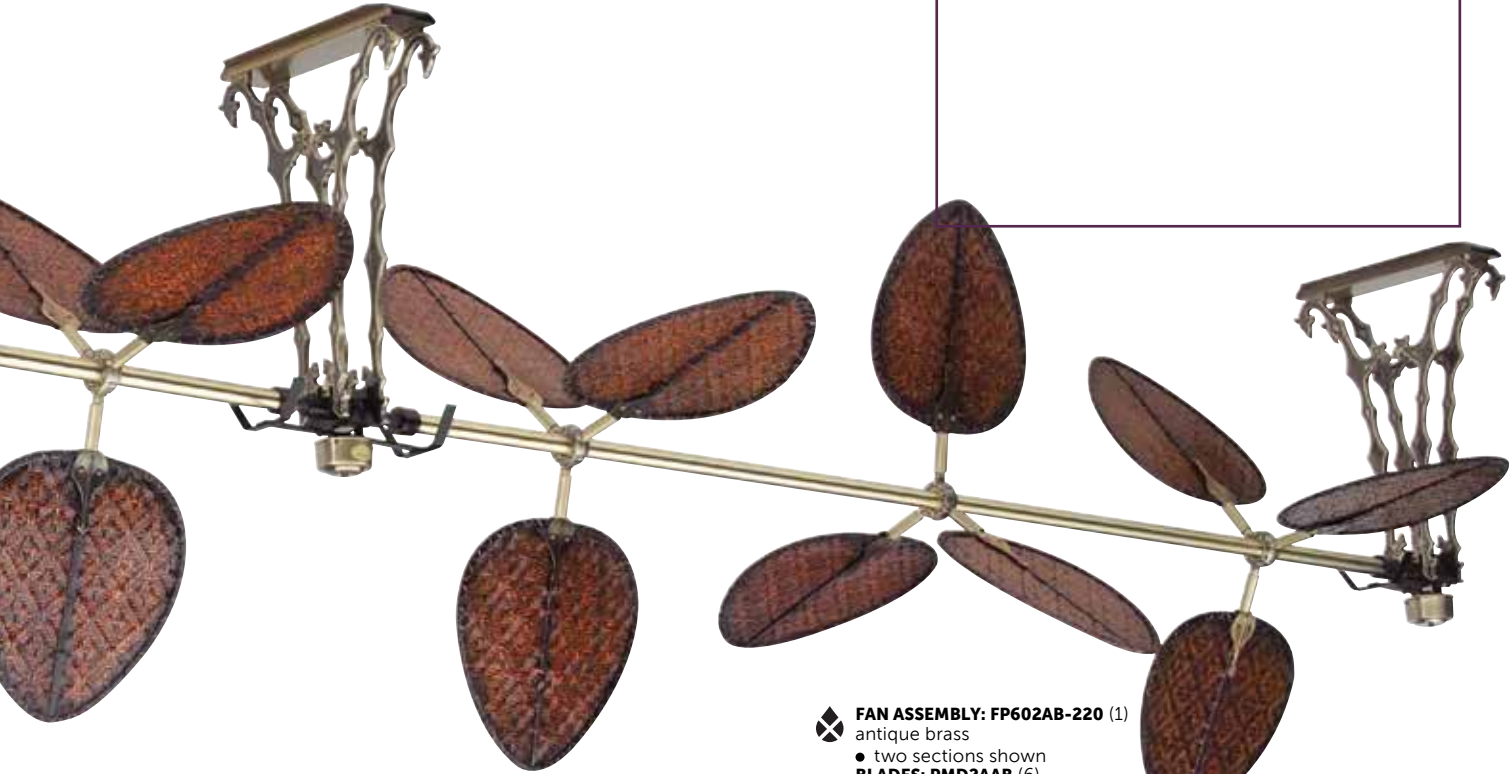

**FAN ASSEMBLY: FP602AB-220** (1)  
antique brass  
• two sections shown  
**BLADES: PMD2AAB** (6)  
antique brass assemblies with  
antique woven bamboo wide  
oval blades







INDOOR/OUTDOOR

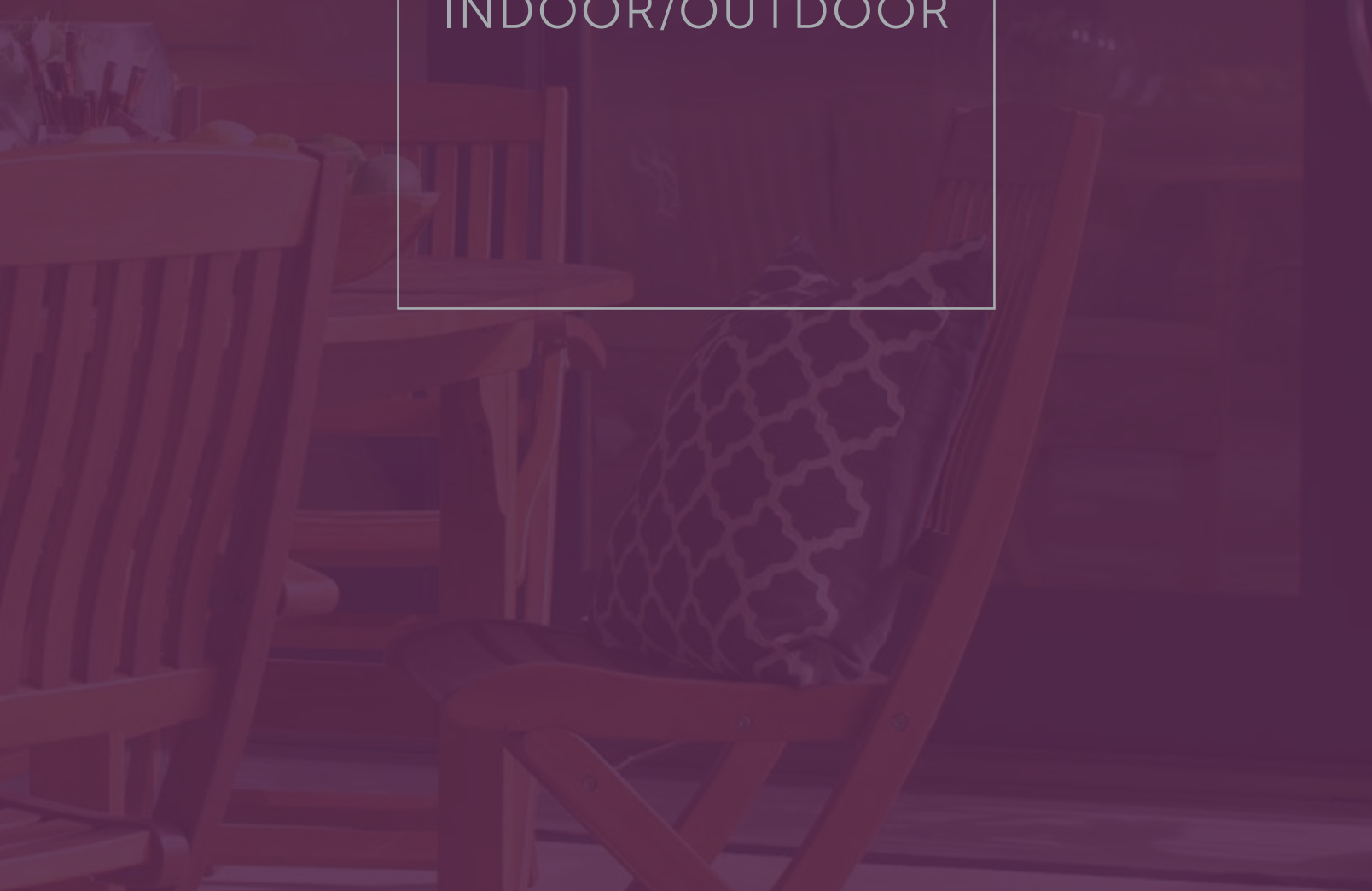

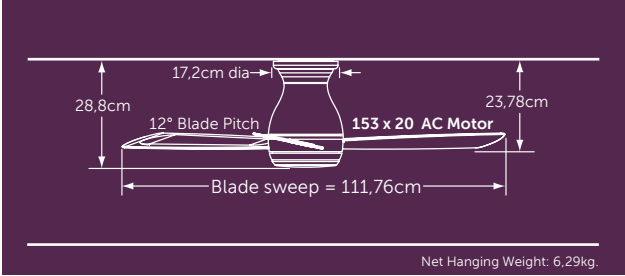

**FAN: FPS8332BNW-220** (1)  
brushed nickel assembly with brushed nickel blades and matching brushed nickel light cover (included)



**FAN: FPS8332DZW-220** (1)  
dark bronze assembly with dark bronze blades and opal frosted glass



**FAN: FPS8332GRW-220** (1)  
matte greige assembly with matte greige blades and matching matte greige light cover (included)



**FAN: FPS8332MWW-220** (1)  
matte white assembly with matte white blades and opal frosted glass



**SOLD SEPARATELY:**



See page 63-64 for optional controls

# HUGH™ 44

**FAN: FPS8332MWW-220 (1)**  
matte white assembly with opal frosted glass and matte white blades

|                       |                       |                       |                       |
|-----------------------|-----------------------|-----------------------|-----------------------|
| brushed nickel        | dark bronze           | matte greige          | matte white           |
| brushed nickel        | dark bronze           | matte greige          | matte white           |
| <b>FPS8332BNW-220</b> | <b>FPS8332DZW-220</b> | <b>FPS8332GRW-220</b> | <b>FPS8332MWW-220</b> |

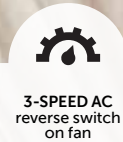

**INCLUDED:**

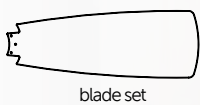

**ENERGY INFORMATION AT HIGH SPEED:**

Airflow  
**4147**  
Cubic Feet Per Minute

Electricity Use  
**52**  
Watts (excluding lights)

Airflow Efficiency  
**81**  
Cubic Feet Per Minute Per Watt

**LIMITED LIFETIME MOTOR WARRANTY**

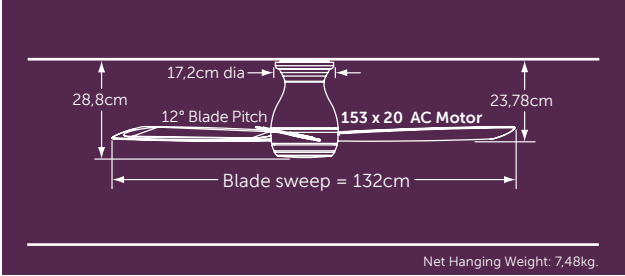

**FAN: FPS8355BNW-220** (1)  
brushed nickel assembly with brushed  
nickel blades and matching brushed  
nickel light cover (included)



**FAN: FPS8355DZW-220** (1)  
dark bronze assembly with  
dark bronze blades and opal  
frosted glass



**FAN: FPS8355GRW-220** (1)  
matte greige assembly with matte  
greige blades and matching matte  
greige light cover (included)



**FAN: FPS8355MWW-220** (1)  
matte white assembly with  
matte white blades and opal  
frosted glass



**SOLD SEPARATELY:**



See page 63-64 for  
optional controls



# HUGH™ 52

**FAN: FPS8355DZW-220** (1)  
dark bronze assembly with  
dark bronze blades and  
matching dark bronze light  
cover (included)

|                       |                       |                       |                       |
|-----------------------|-----------------------|-----------------------|-----------------------|
| brushed nickel        | dark bronze           | matte greige          | matte white           |
| brushed nickel        | dark bronze           | matte greige          | matte white           |
| <b>FPS8355BNW-220</b> | <b>FPS8355DZW-220</b> | <b>FPS8355GRW-220</b> | <b>FPS8355MWW-220</b> |



## INCLUDED:



## ENERGY INFORMATION AT HIGH SPEED:

Airflow  
**5300**  
Cubic Feet Per Minute

Electricity Use  
**52**  
Watts (excluding lights)

Airflow Efficiency  
**103**  
Cubic Feet Per Minute Per Watt

**LIMITED LIFETIME MOTOR WARRANTY**

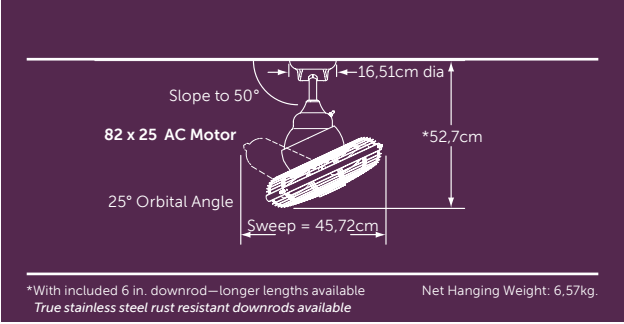

 **FAN: OF110OB-220 (1)**  
oil-rubbed bronze assembly with black cage



 **FAN: OF110PW-220 (1)**  
pewter assembly with black cage



**SOLD SEPARATELY:**



See page 63-64 for optional controls

# EXTRAORDINAIRE™



 **FAN: OF110OB-220 (1)**  
oil-rubbed bronze  
assembly with black cage

|                    |                    |
|--------------------|--------------------|
| oil-rubbed bronze  | pewter             |
| black              | black              |
| <b>OF110OB-220</b> | <b>OF110PW-220</b> |

-  **3-SPEED AC**  
no reverse
-  **CONTROL**  
wall
-  **DRY/DAMP (IP20)**  
model specific

**INCLUDED:**

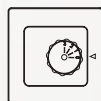



CW110WH-220

**ENERGY INFORMATION  
AT HIGH SPEED:**

|                       |                          |                                |
|-----------------------|--------------------------|--------------------------------|
| Airflow               | Electricity Use          | Airflow Efficiency             |
| <b>1587</b>           | <b>71</b>                | <b>22</b>                      |
| Cubic Feet Per Minute | Watts (excluding lights) | Cubic Feet Per Minute Per Watt |

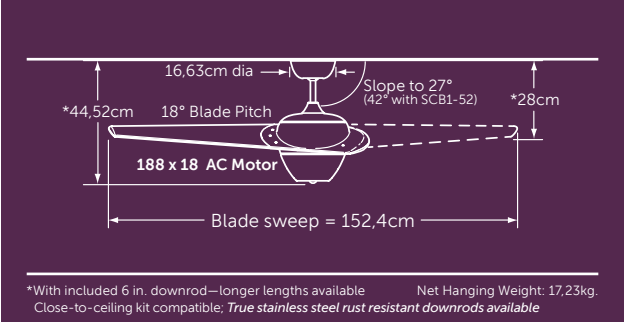
**LIMITED LIFETIME MOTOR WARRANTY**



 **FAN: FP2120MG-220 (1)**  
metro gray assembly



 **FAN: FP2120MG-220 (1)**  
metro gray assembly



**SOLD SEPARATELY:**



See page 63-64 for optional controls

# ENIGMA™



**FAN: FP2120MG-220 (1)**  
metro gray assembly

metro gray  
metro gray  
metro gray  
**FP2120MG-220**



**3-SPEED AC**  
no reverse



**CONTROL**  
remote



**DAMP (IP20)**  
indoor/outdoor

**INCLUDED:**



blade



TR4WH-220

**ENERGY INFORMATION AT HIGH SPEED:**

Airflow  
**5796**  
Cubic Feet Per Minute

Electricity Use  
**51**  
Watts  
(excluding lights)

Airflow Efficiency  
**114**  
Cubic Feet Per Minute Per Watt

**LIMITED LIFETIME MOTOR WARRANTY**

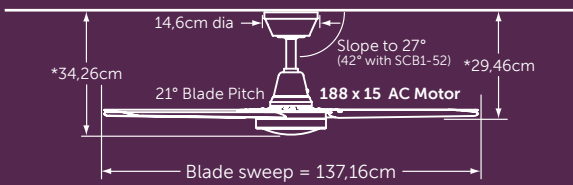

\*With included 6 in. downrod—longer lengths available  
 True stainless steel rust resistant downrods available

Net Hanging Weight: 8,36kg.

NOTE: DISTANCE FROM FLOOR TO BLADES MUST BE AT LEAST 10 FEET FOR THE ASCENSION™

**FAN: FP6717BN-220 (1)**  
 brushed nickel assembly with  
 brushed nickel blades



**FAN: FP6717MW-220 (1)**  
 matte white assembly with matte  
 white blades



SOLD SEPARATELY:



See page 63-64 for  
 optional controls

# ASCENSION™

 **FAN: FP6717BN-220 (1)**  
brushed nickel assembly with  
brushed nickel blades

|                     |                     |
|---------------------|---------------------|
| brushed nickel      | matte white         |
| brushed nickel      | matte white         |
| <b>FP6717BN-220</b> | <b>FP6717MW-220</b> |

INCLUDED:

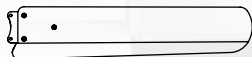

blade set

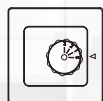

CW6717WH-220

ENERGY INFORMATION  
AT HIGH SPEED:

Airflow  
**6629**  
Cubic Feet  
Per Minute

Electricity Use  
**53**  
Watts  
(excluding lights)

Airflow Efficiency  
**126**  
Cubic Feet Per  
Minute Per Watt

  
**3-SPEED AC**  
reverse switch  
on fan

  
**CONTROL**  
wall

  
**DAMP (IP20)**  
indoor/outdoor



**LIMITED LIFETIME MOTOR WARRANTY**

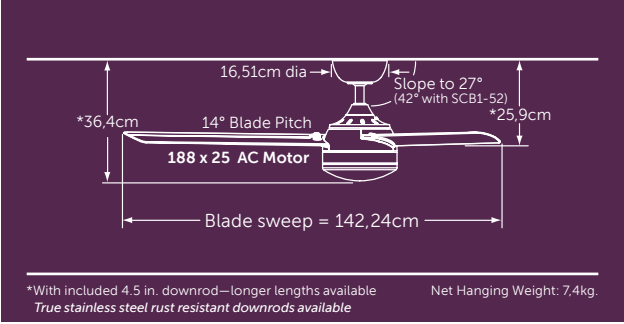

**FAN: FP6729BNW-220 (1)**  
brushed nickel assembly with  
opal frosted glass and brushed  
nickel blades



**FAN: FP6729DZW-220 (1)**  
dark bronze assembly with  
opal frosted glass and dark  
bronze blades



**FAN: FP6729MWW-220 (1)**  
matte white assembly with  
opal frosted glass and matte  
white blades



**SOLD SEPARATELY:**



See page 63-64 for  
optional controls



# XENO™ WET

**FAN: FP6729BNW-220 (1)**  
brushed nickel assembly  
with opal frosted glass and  
brushed nickel blades

|                      |                      |                      |
|----------------------|----------------------|----------------------|
| brushed<br>nickel    | dark<br>bronze       | matte<br>white       |
| brushed<br>nickel    | dark<br>bronze       | matte<br>white       |
| <b>FP6729BNW-220</b> | <b>FP6729DZW-220</b> | <b>FP6729MWW-220</b> |



**18W  
LED**



**3-SPEED AC  
reverse switch  
on fan**



**CONTROL  
wall**



**WET (IP21)  
indoor/outdoor**

## INCLUDED:

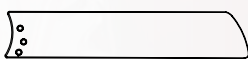

blade set



light kit



CW6729-220

## ENERGY INFORMATION AT HIGH SPEED:

Airflow  
**6545**  
Cubic Feet  
Per Minute

Electricity Use  
**58**  
Watts  
(excluding lights)

Airflow Efficiency  
**113**  
Cubic Feet Per  
Minute Per Watt

**LIMITED LIFETIME MOTOR WARRANTY**

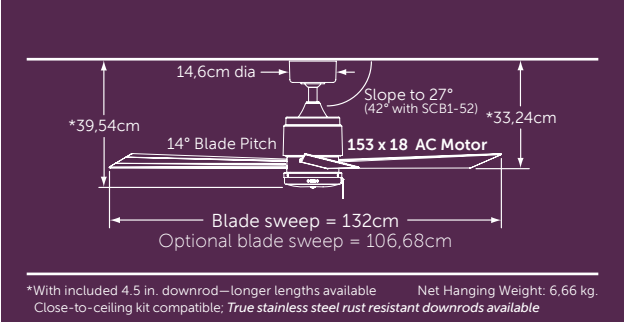

**FAN: FP4640OB-220 (1)**  
oil-rubbed bronze assembly with  
cherry all weather composite blades

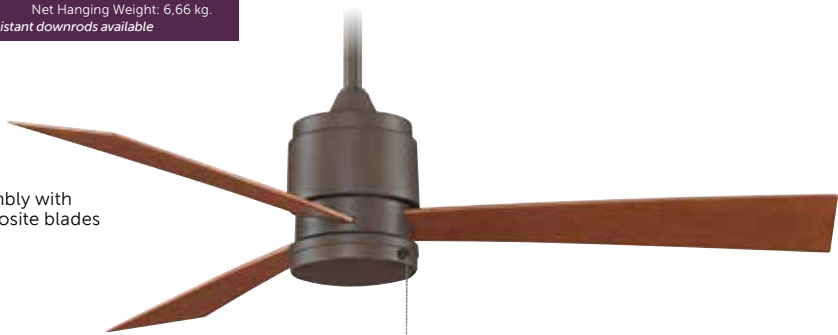

**FAN: FP4640SN-220 (1)**  
satin nickel assembly with satin  
nickel all weather composite blades



**FAN: FP4640WH-220 (1)**  
white assembly with white all  
weather composite blades



**FAN: FP4640OB-220 (1)**  
oil-rubbed bronze assembly  
with cherry all weather  
composite blades  
**LIGHT KIT: LK4640OB-220 (1)**  
oil-rubbed bronze finish 18W  
LED light kit



**SOLD SEPARATELY:**



See page 63-64 for  
additional control options

- CY—cherry
- WA—walnut
- SN—satin nickel
- WH—white

**BPW4426\*\***  
composite



**LK4640\*\***-220  
18W LED

use with  
CW4640-220WH



**CW4640-220WH**  
wall control

# ZONIX™ WET

**FAN: FP4640OB-220 (1)**  
oil rubbed bronze  
assembly with cherry all  
weather composite blades

|                      |                     |                     |
|----------------------|---------------------|---------------------|
| oil-rubbed<br>bronze | satin<br>nickel     | white               |
| cherry               | satin<br>nickel     | white               |
| <b>FP4640OB-220</b>  | <b>FP4640SN-220</b> | <b>FP4640WH-220</b> |

INCLUDED:



blade set

ENERGY INFORMATION  
AT HIGH SPEED:

Airflow  
**4946**  
Cubic Feet  
Per Minute

Electricity Use  
**43**  
Watts  
(excluding lights)

Airflow Efficiency  
**115**  
Cubic Feet Per  
Minute Per Watt

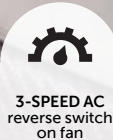

LIMITED LIFETIME MOTOR WARRANTY

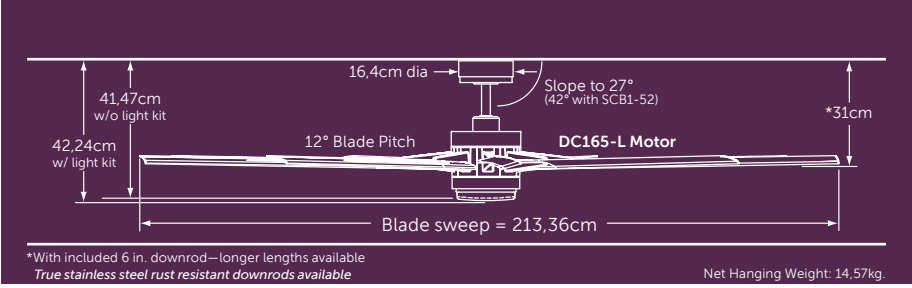

**FAN: FPD8148BN-220 (1)**  
 brushed nickel assembly with  
 brushed nickel blades and matching  
 brushed nickel light cover (included)



**FAN: FPD8148MW-220 (1)**  
 matte white assembly with  
 matte white blades and opal  
 frosted glass



**SOLD SEPARATELY:**



See page 63-64 for  
 optional controls

# ODYN™

**FAN: FPD8148BN-220** (1)  
brushed nickel assembly  
with brushed nickel blades  
and opal frosted glass

|                      |                      |
|----------------------|----------------------|
| brushed nickel       | matte white          |
| brushed nickel       | matte white          |
| <b>FPD8148BN-220</b> | <b>FPD8148MW-220</b> |

**ENERGY SAVINGS**

**18W LED**

**6-SPEED DC reverse switch on fan**

**CONTROL remote**

**DAMP (IP20) indoor/outdoor**

**INCLUDED:**

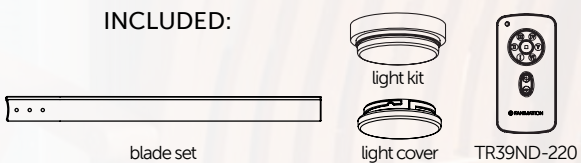



**ENERGY INFORMATION AT HIGH SPEED:**

|                       |                          |                                |
|-----------------------|--------------------------|--------------------------------|
| Airflow               | Electricity Use          | Airflow Efficiency             |
| <b>10,104</b>         | <b>32</b>                | <b>314</b>                     |
| Cubic Feet Per Minute | Watts (excluding lights) | Cubic Feet Per Minute Per Watt |

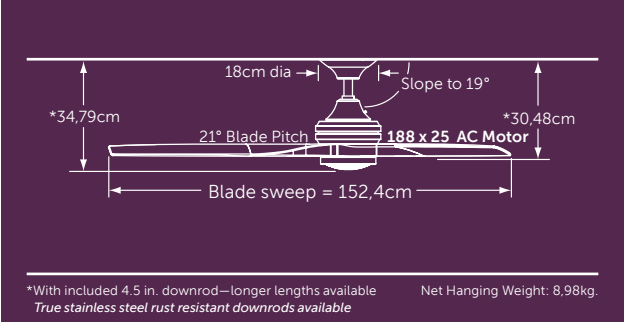

**LIMITED LIFETIME MOTOR WARRANTY**



**MOTOR: MA6721BN-220** (1)  
 brushed nickel assembly  
**BLADES: B6720BN** (1)  
 brushed nickel finish buttonwood



**MOTOR: MA6721DZ-220** (1)  
 dark bronze assembly  
**BLADES: B6720N** (1)  
 natural finish buttonwood



**MOTOR: MA6721GR-220** (1)  
 matte greige assembly  
**BLADES: B6720WE** (1)  
 weathered wood finish buttonwood  
**LIGHT KIT: LK6721GR-220** (1)  
 matte greige with frosted fresnel glass



**SOLD SEPARATELY:**



See page 63-64 for optional controls



**B6720\*\***   
button wood

- BN—brushed nickel
- DF—driftwood
- DWA—dark walnut
- N—natural
- WE—weathered wood
- WK—whiskey wood



**LK6721\*\*-220**   
18W LED

# SPITFIRE™

- MOTOR: MA6721DZ-220** (1)  
dark bronze assembly
- BLADES: B6720N** (1)  
natural finish buttonwood
- LIGHT KIT: LK6721DZ-220** (1)  
dark bronze with frosted fresnel glass

brushed nickel  
**MA6721BN-220**

dark bronze  
**MA6721DZ-220**

matte greige  
**MA6721GR-220**

  
**MIX & MATCH**  
components  
sold separately

  
**3-SPEED AC**  
reverse switch  
on fan

  
**CONTROL**  
wall

  
**DAMP (IP20)**  
indoor/outdoor

INCLUDED:



CW6721WH-220

ENERGY INFORMATION  
AT HIGH SPEED:

Airflow  
**6774**  
Cubic Feet  
Per Minute

Electricity Use  
**53**  
Watts  
(excluding lights)

Airflow Efficiency  
**127**  
Cubic Feet Per  
Minute Per Watt



**LIMITED LIFETIME MOTOR WARRANTY**

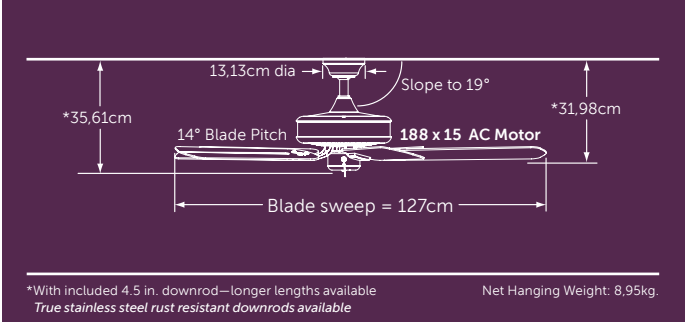

**FAN: TF910AZ-220** (1)  
aged bronze assembly with  
dark cherry all-weather  
composite blades



**FAN: TF910WH-220** (1)  
white assembly with  
white all-weather  
composite blades

**SOLD SEPARATELY:**



control options: p.63-64  
light options: p.61



# EDGEWOOD® WET

**FAN: TF910WH-220 (1)**  
white assembly with all-weather  
composite white blades

|                    |                    |
|--------------------|--------------------|
| aged<br>bronze     | white              |
| dark<br>cherry     | white              |
| <b>TF910AZ-220</b> | <b>TF910WH-220</b> |

INCLUDED:



blade set

ENERGY INFORMATION  
AT HIGH SPEED:

Airflow  
**5272**  
Cubic Feet  
Per Minute

Electricity Use  
**53**  
Watts  
(excluding lights)

Airflow Efficiency  
**99**  
Cubic Feet Per  
Minute Per Watt

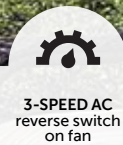

**LIMITED LIFETIME MOTOR WARRANTY**

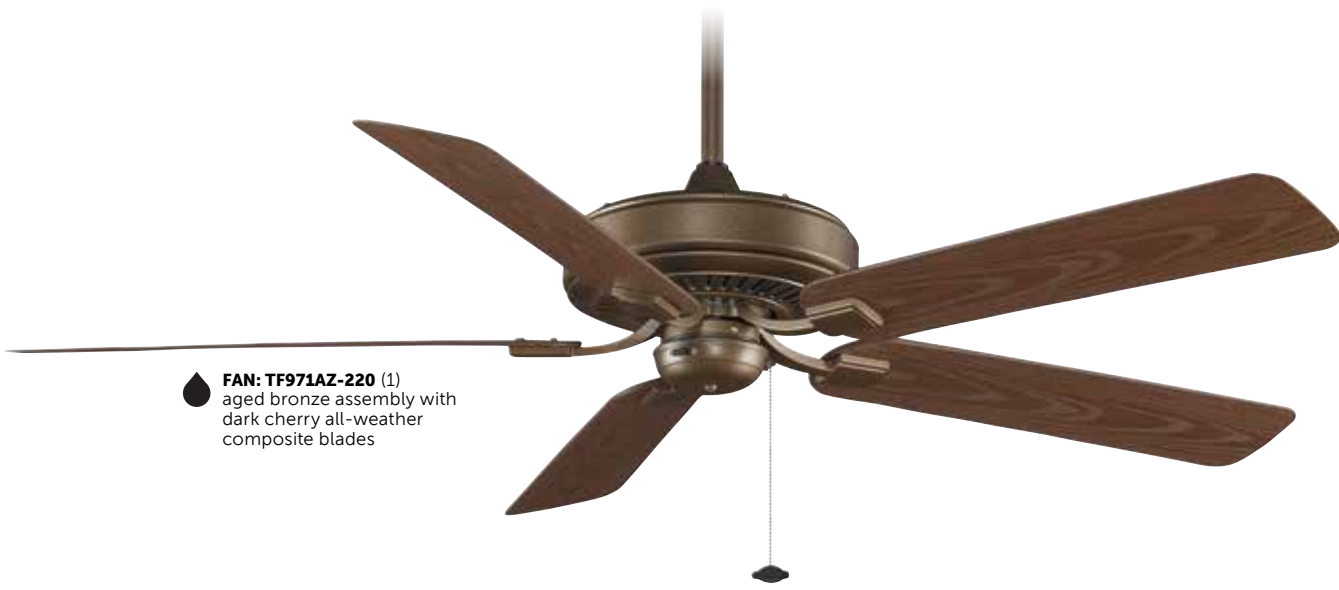
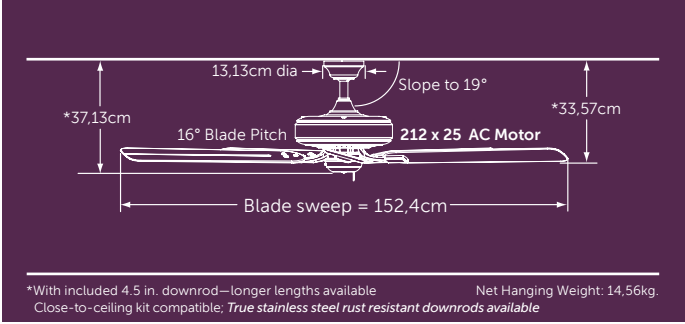

**FAN: TF971AZ-220** (1)  
aged bronze assembly with  
dark cherry all-weather  
composite blades



**SOLD SEPARATELY:**



control options: p.63-64  
light options: p.61



# EDGEWOOD® DELUXE WET

**FAN: TF971AZ-220** (1)  
aged bronze assembly with  
all-weather composite  
dark cherry blades

aged  
bronze  
dark  
cherry  
**TF971AZ-220**

**INCLUDED:**

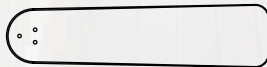

blade set

**ENERGY INFORMATION  
AT HIGH SPEED:**

Airflow  
**8053**  
Cubic Feet  
Per Minute

Electricity Use  
**79**  
Watts  
(excluding lights)

Airflow Efficiency  
**102**  
Cubic Feet Per  
Minute Per Watt

  
**3-SPEED AC**  
reverse switch  
on fan

  
**CONTROL**  
pull chain

  
**WET (IP21)**  
indoor/outdoor



**LIMITED LIFETIME MOTOR WARRANTY**

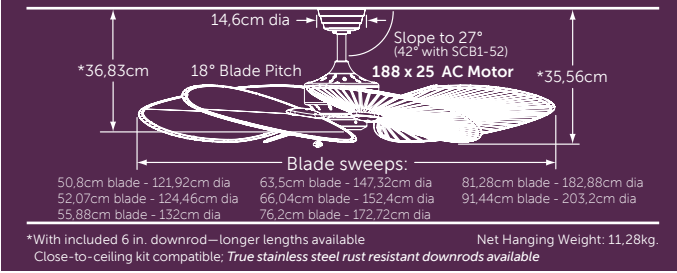

**MOTOR: MA7500AB-220** (1)  
antique brass assembly  
**BLADES: B5340WA** (1)  
132cm sweep walnut carved wood



**MOTOR: MA7500OB-220** (1)  
oil-rubbed bronze assembly  
**BLADES: BPW20CY** (1)  
121,92cm sweep all-weather composite cherry  
**LIGHT KIT: LKLP102OB-220** (1)  
opal frosted glass low profile  
**CLOSE TO CEILING KIT: CCK8002OB** (1)  
oil-rubbed bronze



**MOTOR: MA7500RS-220** (1)  
rust assembly  
**BLADES: B5280WA** (1)  
132cm sweep walnut wide oval leaf carved wood



**SOLD SEPARATELY:**



blade options: p.65-66  
control options: p.63-64  
light options: p.61

# WINDPOINTE® CUSTOM

**MOTOR: MA7500RS-220** (1)  
rust assembly  
**BLADES: ISD1A** (1)  
132cm sweep walnut wide  
oval leaf carved wood

antique  
brass

MA7500AB-220

oil-rubbed  
bronze

MA7500OB-220

rust

MA7500RS-220



**MIX & MATCH**  
components  
sold separately



**3-SPEED AC**  
reverse switch  
on fan



**CONTROL**  
pull chain



**DRY OR DAMP**  
model specific

## ENERGY INFORMATION AT HIGH SPEED:

Airflow measured with  
BPW6030 blades

Airflow

**5188**

Cubic Feet  
Per Minute

Electricity Use

**56**

Watts  
(excluding lights)

Airflow Efficiency

**93**

Cubic Feet Per  
Minute Per Watt



**LIMITED LIFETIME MOTOR WARRANTY**

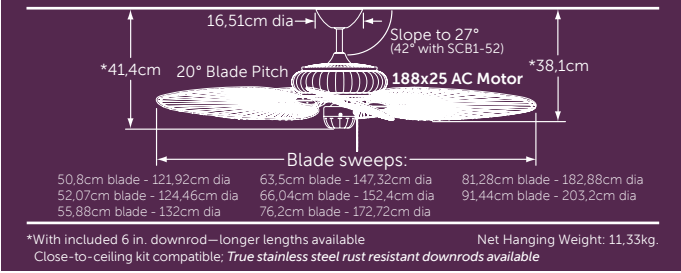

**FAN: FP4320AZ1-220** (1)  
aged bronze assembly  
**BLADES: BPD4A** (1)  
132cm sweep all-weather  
composite antique woven  
bamboo narrow oval



**FAN: FP4320TB1-220** (1)  
textured black assembly  
**BLADES: BPP4BR** (1)  
132cm sweep all-weather  
composite brown/red  
woven bamboo narrow oval



**FAN: FP4320TS1-220** (1)  
tortoise shell assembly  
**BLADES: B5340WA** (1)  
132cm sweep walnut  
carved wood



**SOLD SEPARATELY:**



blade options: p.65-66  
control options: p.63-64  
light options: p.61

BELLERIA®

**FAN: FP4320AZ1-220** (1)  
aged bronze assembly  
**BLADES: BPW6090DNA** (1)  
152.4cm sweep all-weather composite  
dark natural accent narrow palm

aged bronze    textured black    tortoise shell  
**FP4320AZ1-220    FP4320TB1-220    FP4320TS1-220**

  
**MIX & MATCH**  
 components  
 sold separately

  
**3-SPEED AC**  
 reverse switch  
 on fan

  
**CONTROL**  
 pull chain

  
**DRY/WET (IP21)**  
 blade finish  
 specific

**ENERGY INFORMATION**  
**AT HIGH SPEED:**  
 Airflow measured with  
 BPP4 blades

Airflow  
**4379**  
 Cubic Feet  
 Per Minute

Electricity Use  
**51**  
 Watts  
 (excluding lights)

Airflow Efficiency  
**86**  
 Cubic Feet Per  
 Minute Per Watt



**LIMITED LIFETIME MOTOR WARRANTY**

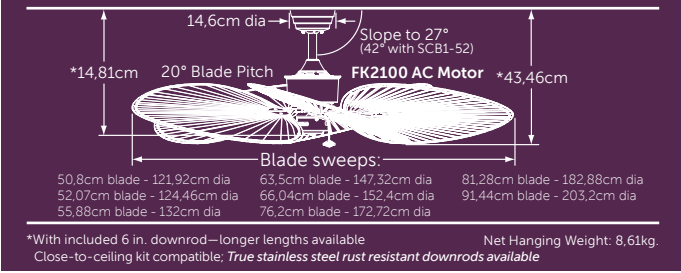

**FAN: FP320AB1-220** (1)  
antique brass assembly  
**BLADES: ISP1** (1)  
132cm sweep natural palm leaf wide oval

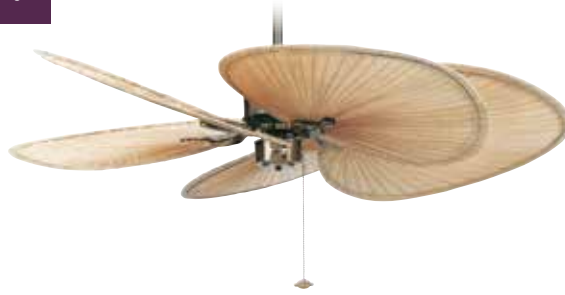

**FAN: FP320OB1-220** (1)  
oil-rubbed bronze assembly  
**BLADES: BPW20CY** (1)  
121,92cm sweep all-weather composite cherry



**FAN: FP320PW1-220** (1)  
pewter assembly  
**BLADES: B5133TKMH** (1)  
132cm sweep reversible teak/mahogany wood blades  
● teak side showing



**SOLD SEPARATELY:**



blade options: p.65-66  
control options: p.63-64  
light options: p.61



# ISLANDER® AC

**FAN:** FP320OB1-220 (1)  
oil-rubbed bronze assembly  
**BLADES:** ISD4A (1)  
132cm sweep antique narrow  
oval woven bamboo

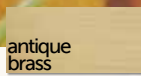
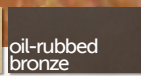
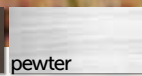
-   
**antique  
brass**  
**FP320AB1-220**
-   
**oil-rubbed  
bronze**  
**FP320OB1-220**
-   
**pewter**  
**FP320PW1-220**

  
**MIX & MATCH**  
components  
sold separately

  
**3-SPEED AC**  
reverse switch  
on fan

  
**CONTROL**  
pull chain

  
**DRY/DAMP (IP20)**  
model specific

**ENERGY INFORMATION  
AT HIGH SPEED:**  
Airflow measured with  
BPW6030 blades

Airflow  
**6351**  
Cubic Feet  
Per Minute

Electricity Use  
**90**  
Watts  
(excluding lights)

Airflow Efficiency  
**71**  
Cubic Feet Per  
Minute Per Watt



**LIMITED LIFETIME MOTOR WARRANTY**

For dimensions and configurations, please see our comprehensive Specification Book or model-specific specification sheet, available at [fanimation.com](http://fanimation.com)

- ◆ **FAN: FP410AB-220** (1)  
antique brass short assembly
- ◆ **BLADE SET: FP1018** (1)  
127cm sweep reversible oak/walnut wood blades
- oak side showing



- **FAN: FP410BL-220** (1)  
black short assembly
- **BLADE SET: BPP4TN** (1)  
132cm sweep natural finish narrow oval all-weather composite palm blades



**SOLD SEPARATELY:**



blade options: p.65-66  
control options: p.63-64  
light options: p.61

# AMERICANA®

- ◆ **FAN: FP410AB-220** (1)  
antique brass short assembly
- ◆ **BLADE SET: FP1018** (1)  
127cm sweep reversible oak/  
walnut wood blades
  - oak side showing

antique  
brass

**FP410AB-220**

black

**FP410BL-220**



**MIX & MATCH**  
components  
sold separately



**3-SPEED AC**  
reverse switch  
on fan



**CONTROL**  
pull chain



**DRY/DAMP** (IP20)  
model specific

**LIMITED LIFETIME MOTOR WARRANTY**

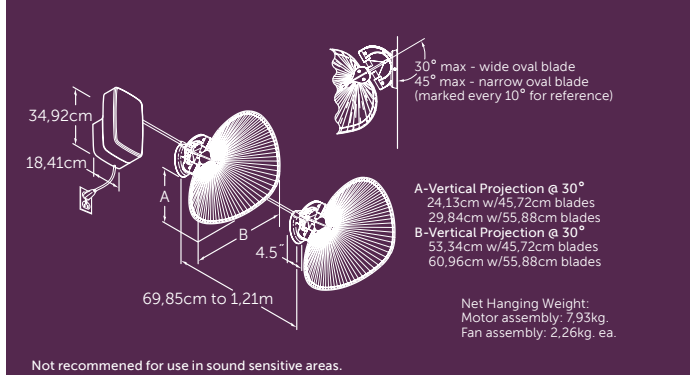

- ❖ **MOTOR: FP780AB-220** (1)  
antique brass
- FAN ASSEMBLIES: FP720AB** (4)  
antique brass
- BLADES: PUP1** (4)  
55,88cm natural palm leaf wide oval



- ❖ **MOTOR: FP780PW-220** (1)  
pewter
- FAN ASSEMBLIES: FP720PW** (6)  
pewter
- BLADES: PUD1A** (6)  
55,88cm antique woven bamboo wide oval



- 💧 **MOTOR: FP780RS-220** (1)  
rust
- FAN ASSEMBLIES: FP720RS** (4)  
rust
- BLADES: PUD1A** (4)  
55,88cm antique woven bamboo wide oval



SOLD SEPARATELY:



See page 65-66 for blade options

# PUNKAH®

 **MOTOR: FP780PW-220** (1)  
 pewter  
**FAN ASSEMBLIES: FP720PW** (5)  
 pewter  
**BLADES: PUP1** (5)  
 55,88cm natural palm leaf  
 wide oval

antique  
 brass  
**FP780AB-220**  
**FP720AB**

pewter  
**FP780PW-220**  
**FP720PW**

rust  
**FP780RS-220**  
**FP720RS**

  
**POWER CORD**  
 0,6m cord

  
**MIX & MATCH**  
 components  
 sold separately

  
**1-SPEED AC**  
 no reverse

  
**DRY/DAMP (IP20)**  
 model specific



**LIMITED LIFETIME MOTOR WARRANTY**

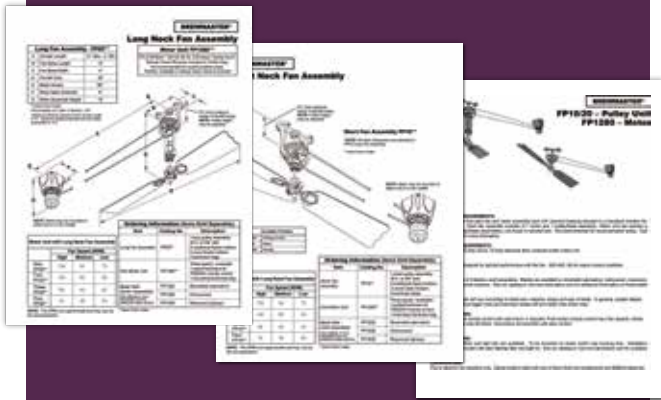

For dimensions and configurations, please see our comprehensive Specification Book or model-specific specification sheet, available at [fanimation.com](http://fanimation.com)

Not recommended for use in sound sensitive areas.





The Brewmaster® carries on Fanimation's reputation for reproducing unusual, yet functional, belt-drive fans. These fans were originally produced in the late 1800s by Snediker & Carr®, the premier belt-drive fan manufacturer of their day. Fanimation has adapted this timeless masterpiece to install and operate with more ease and durability.

- Neoprene belting replaces the high-maintenance leather belts.
- Lead and copper babbitt sleeves have given way to sealed ball bearings.
- Hardwood laminate blades that resist warping and splitting replace the temperamental solid wood blades.

The Brewmaster® combines the latest technology with several blade options including the original oversized wood blade design. The Brewmaster® is powered by a gearless direct drive motor, and allows you to operate one or two fans.

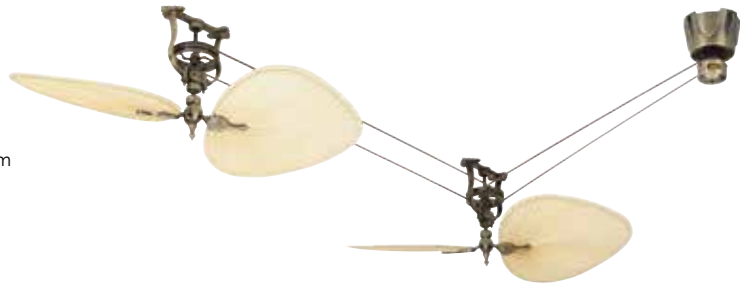
-  **MOTOR: FP1280AB-220** (1)  
 antique brass  
**HEAD: FP10AB** (2)  
 antique brass short neck assembly  
**BLADE SET: BMP1** (2)  
 127cm sweep natural finish wide oval palm



-  **MOTOR: FP1280BL-220** (1)  
 black (required but not shown)  
**HEAD: FP20BL** (1)  
 black long neck assembly  
**BLADE SET: BMD4A** (1)  
 127cm sweep narrow oval woven bamboo

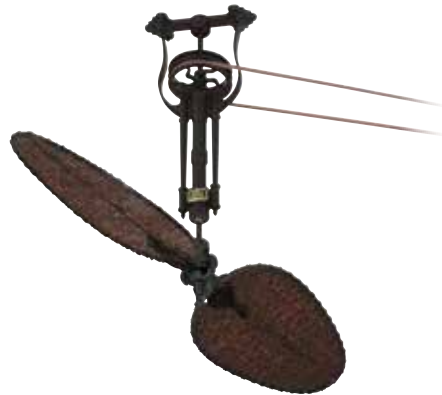

-  **MOTOR: FP1280PW-220** (1)  
 pewter (required but not shown)  
**HEAD: FP10PW** (1)  
 pewter short neck assembly  
**BLADE SET: FP1030** (1)  
 142,24cm sweep rosewood



**SOLD SEPARATELY:**

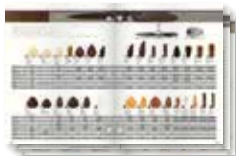

additional blade options: p.65-66  
 control options: p.63-64  
 light options: p.61



reversible oak/walnut

**FP1022**  
wood 



cherry

**FP1026**  
wood 



rosewood

**FP1030**  
wood 

# BREWMASTER™

-  **MOTOR: FP1280BL-220** (1)  
black (required but not shown)
- HEAD: FP20BL** (1)  
black long neck assembly
- BLADE SET: FP1026** (1)  
63,5cm cherry

antique  
brass

**FP1280AB-220**  
**FP10AB**  
**FP20AB**

black

**FP1280BL-220**  
**FP10AB**  
**FP20AB**

pewter

**FP1280PW-220**  
**FP10AB**  
**FP20AB**

INCLUDED:



C3-220



**MIX & MATCH**  
components  
sold separately



**3-SPEED AC**  
reverse switch  
on remote



**CONTROL**  
wall



**DRY/DAMP** (IP20)  
model specific

FAN SPEED (RPM): Fan Assemblies

|              | High       | Medium     | Low       |
|--------------|------------|------------|-----------|
| <b>One</b>   | <b>127</b> | <b>100</b> | <b>82</b> |
| <b>Two</b>   | <b>106</b> | <b>60</b>  | <b>46</b> |
| <b>Three</b> | <b>89</b>  | <b>46</b>  | <b>35</b> |
| <b>Four</b>  | <b>76</b>  | <b>38</b>  | <b>28</b> |



**LIMITED LIFETIME MOTOR WARRANTY**







PORTABLES



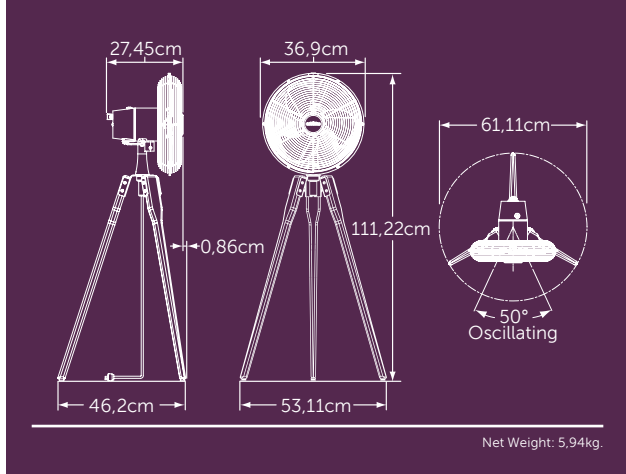

**FAN: FP8015OB-220 (1)**  
oil-rubbed bronze assembly with black blades and walnut legs



**FAN: FP8015SN-220 (1)**  
satin nickel assembly with black blades and walnut legs





# ARDEN™

 **FAN: FP8015SN-220 (1)**  
satin nickel assembly with  
walnut legs

|                      |                     |
|----------------------|---------------------|
| oil-rubbed<br>bronze | satin<br>nickel     |
| walnut               | walnut              |
| <b>FP8015OB-220</b>  | <b>FP8015SN-220</b> |



**3-SPEED**  
no reverse



**POWER CORD**  
2,43m cord



**CONTROL**  
rotary



**DRY (IP20)**  
indoor only



**LIMITED LIFETIME MOTOR WARRANTY**

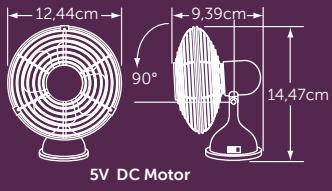

Net Weight: 0,5kg.

**FAN: FP6252BN (1)**  
brushed nickel assembly with  
brushed nickel fan blades and  
brushed nickel cage



**FAN: FP6252BN (1)**  
brushed nickel assembly with  
brushed nickel fan blades and  
brushed nickel cage



**FAN: FP6252BN (1)**  
brushed nickel assembly with  
brushed nickel fan blades and  
brushed nickel cage



# MINI BREEZE™



 **FAN: FP6252BN (1)**  
brushed nickel assembly with  
brushed nickel blades and  
brushed nickel cage

brushed  
nickel  
brushed  
nickel  
**FP6252BN**

 **USB**

USB PLUG



**1-SPEED**  
no reverse



**DRY (IP20)**  
indoor only

INCLUDED:



USB power cord

**LIMITED LIFETIME MOTOR WARRANTY**

## LIGHT KITS

- Light kits are for use with most Fanimation fans
- Light bulb requirements vary and are listed for each light kit
- Pull-chain light kits come with chain and fob
- Light bulbs included



- ◊ **LKLP101SN-220** satin nickel
- low-profile light kit
  - opal frosted glass
  - pull chain operation
  - 21,59cm (H) x 13,2cm (W)
  - One 100W halogen minican bulb included



- ◊ **LKLP102OB-220** oil-rubbed bronze  
◊ **LKLP102SN-220** satin nickel
- low-profile light kit
  - opal frosted glass
  - pull chain operation
  - 20,32cm (H) x 13,2cm (W)
  - One 100W halogen minican bulb included



- ◊ **LKLP112AOB-220** oil-rubbed bronze
- low-profile light kit
  - amber linen glass
  - pull chain operation
  - 21,59cm (H) x 13,2cm (W)
  - One 100W halogen minican bulb included



- ◊ **LKLP112WSN-220** satin nickel
- low-profile light kit
  - white linen glass
  - pull chain operation
  - 21,59cm (H) x 13,2cm (W)
  - One 100W halogen minican bulb included

## FITTERS, SHADES & DECORATIVE GLASS

- Fitters are for use with most Fanimation fans
- Fitter glass sold separately below
- Finishes and light bulb requirements vary and are listed for each
- Glass and shades should be ordered based on the fitter model selected
- Glass bowls—32,38cm diameter x 12,06cm height (G210 and G400 series) require fitters F423-220 and FW423-220
- Light bulbs included



- ◆ **F423AB-220** antique brass  
◊ **F423AZ-220** aged bronze  
◊ **F423OB-220** oil-rubbed bronze  
◆ **F423PW-220** pewter  
◊ **F423RS-220** rust  
◊ **F423SN-220** satin nickel
- 15,24cm (H) x 15,24cm (W)
  - Three 60W candelabra bulbs included



- ◆ **FW423RS-220** rust  
◆ **FW423TS-220** tortoise shell  
◆ **FW423WH-220** white
- Uses glass bowls only, sold separately below
  - 17,78cm (H) x 33,02cm (W)
  - Three 40W candelabra bulbs included



**G210**  
Tropical bowl



**G439**  
Hand-painted parrot



**G450**  
Amber



**G451**  
Powdered amber



**G456**  
White frost

# DOWNRODS & ACCESSORIES

## DOWNRODS

- Order according to length
- Use finish code to complete the part number
- See page 3 for suggested lengths

|              |          |                           |
|--------------|----------|---------------------------|
| <b>STEEL</b> | *DR1-6** | 6 in. (15,24cm) downrod   |
|              | DR1-12** | 12 in. (30,48 cm) downrod |
|              | DR1-18** | 18 in. (47,72cm) downrod  |
|              | DR1-24** | 24 in. (60,96cm) downrod  |
|              | DR1-36** | 36 in. (91,44cm) downrod  |
|              | DR1-48** | 48 in. (121,92cm) downrod |
|              | DR1-60** | 60 in. (152,4cm) downrod  |
|              | DR1-72** | 72 in. (182,88cm) downrod |



|                        |             |                           |
|------------------------|-------------|---------------------------|
| <b>STAINLESS STEEL</b> | DR1SS-12*** | 12 in. (30,48 cm) downrod |
|                        | DR1SS-18*** | 18 in. (47,72cm) downrod  |
|                        | DR1SS-24*** | 24 in. (60,96cm) downrod  |
|                        | DR1SS-36*** | 36 in. (91,44cm) downrod  |
|                        | DR1SS-48*** | 48 in. (121,92cm) downrod |
|                        | DR1SS-60*** | 60 in. (152,4cm) downrod  |
|                        | DR1SS-72*** | 72 in. (182,88cm) downrod |

**TRUE STAINLESS STEEL DOWNROD.**  
Wet location rated. Resistant to rust and corrosion.



### DOWNROD COUPLERS



- Joins two downrods together for extended lengths
- When ordering, use finish code for steel downrods shown above to complete the part number.

DR1-CP\*\* 1 in. diameter downrod coupler

## CLOSE-TO-CEILING KIT



- Replaces hanger bracket/downrod assembly to move your fan closer to the ceiling, creating more head room
- Intended for use with low ceilings.
- Please see individual fan pages for compatibility
- Tall dimensions: 13cm (H) x 20,32cm (DIA.)
- Short dimensions: 6,78cm (H) x 20,32cm (DIA.)

## STANDARD

|           |                |           |                   |
|-----------|----------------|-----------|-------------------|
| CCK8002AB | antique brass  | CCK8002OB | oil-rubbed bronze |
| CCK8002AZ | aged bronze    | CCK8002PW | pewter            |
| CCK8002BL | black          | CCK8002RS | rust              |
| CCK8002BN | brushed nickel | CCK8002SN | satin nickel      |
| CCK8002DZ | dark bronze    | CCK8002TS | tortoise shell    |
| CCK8002MW | matte white    | CCK8002WH | white             |

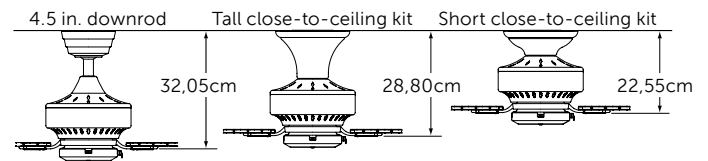

## WET RATED

|            |                    |            |                       |
|------------|--------------------|------------|-----------------------|
| CCK8002BLW | black wet          | CCK8002OBW | oil-rubbed bronze wet |
| CCK8002BNW | brushed nickel wet | CCK8002SNW | satin nickel wet      |
| CCK8002DZW | dark bronze wet    | CCK8002WHW | white wet             |
| CCK8002MWW | matte white wet    |            |                       |

## SLOPED CEILING BALL KIT



- Includes black hanger ball only
  - For use with Fanimation fans purchased after June 2004
  - See individual fan pages for compatibility with your fan
  - Hanger ball works with current Fanimation canopy and hanger bracket
  - Allows for ceiling slope up to 42°
  - For use with any length downrod
- SCB1-52 For use with 1 in. dia. downrods

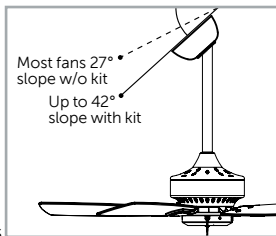

## DOWNROD SLEEVE





- Tropical downrod sleeve
  - 40,64cm tall
  - Requires minimum 24 in. downrod or extension pole
- DRS24TR Downrod sleeve

# CONTROLS

• Control options are not available for Bourbon Street®, Palmetto® and Punkah®

**TUV LISTED**

-  Included
  -  Optional
  -  Optional—Install control in a dry location only
- WH—White LA—Light Almond



C1-220

- 220v non-reversing fan-only wall control
- 100-watt max. fan load

C2-220

- 220v non-reversing fan and light wall control
- 100-watt max. fan load
- 300-watt max. light load

C3-220

- 220v non-reversing fan-only two-fan wall control
- 100-watt max. fan load

C6-220

- 220v non-reversing fan and light wall control
- Controls two fans
- 100-watt max. fan load
- 300-watt max. light load

CW40-220

- 220V non-reversing fan-only wall control
- 100-watt max. fan load

CW110-220

- 220V non-reversing fan-only wall control
- 100-watt max. fan load

|                           |   |   |   |   |   |  |
|---------------------------|---|---|---|---|---|--|
| Aire Décor®—BP200/220/225 |   |   |   |   |   |  |
| Americana®                |    |    |    |    |   |  |
| Ascension™                |   |   |   |   |   |  |
| Belleria®                 |    |    |    |    |   |  |
| Benito™                   |   |   |   |   |   |  |
| Bourbon Street®           |   |   |   |   |   |  |
| Brewmaster®               |   |   |  |  |   |  |
| Edgewood®                 |  |  |  |  |   |  |
| Enigma®                   |   |   |   |   |   |  |
| Extraordinaire®           |   |   |   |   |  |  |
| Hugh™ 44 & 52             |   |   |   |   |   |  |
| Islander® AC              |  |  |  |  |   |  |
| Levon™                    |  |  |  |  |   |  |
| Odyn™                     |   |   |   |   |   |  |
| Palmetto®                 |   |   |   |   |   |  |
| Punkah®                   |   |   |   |   |   |  |
| Spitfire™                 |   |   |   |   |   |  |
| Windpointe®               |  |  |  |  |   |  |
| Xeno™                     |   |   |   |   |   |  |
| Zonix™—FP4620 & FP4630    |  |  |  |  |  |  |
| Zonix™ (WET)—FP4640       |  |  |  |  |   |  |





**CW6717WH-220**  
 • 220V non-reversing fan-only wall control  
 • 100-watt max. fan load

**CW6721-220**  
 • 220v non-reversing fan and light wall control  
 • 100-watt max. fan load  
 • 300-watt max. light load

**CW6729-220**  
 • 220v non-reversing fan and light wall control  
 • 100-watt max. fan load  
 • 300-watt max. light load

**CW8332-220/CW8355-220**  
 • 220v non-reversing fan and light wall control  
 • 100-watt max. fan load  
 • 300-watt max. light load

**CRL4WH-220**  
 • 220v non-reversing fan and light remote  
 • 3 fan speeds  
 • 120-watt max. fan load.  
 • Infinite light levels up to 300-watts  
 • Canopy receiver unit included

**TR4WH-220**  
 • Fan and light remote  
 • hand-held transmitter

**TR39ND-220**  
 • Fan and light remote  
 • 6 fan speeds  
 • On/Off light hand-held transmitter only

**TRL4WH-220**  
 • 220v non-reversing fan and light remote  
 • 3 fan speeds  
 • 120-watt max. fan load.  
 • Infinite light levels up to 300-watts

|   |  |   |   |   |   |   |  |   |
|---|--|---|---|---|---|---|--|---|
|   |  |   |   |   | ☺ |   |  |   |
|   |  |   |   |   | ☺ |   |  |   |
| ☺ |  |   |   |   | ☺ |   |  |   |
|   |  |   |   |   | ☹ |   |  |   |
|   |  |   |   |   | ☺ |   |  | ☺ |
|   |  |   |   |   |   |   |  |   |
|   |  |   |   |   | ☺ |   |  |   |
|   |  |   |   |   | ☺ |   |  |   |
|   |  |   |   |   | ☺ | ☺ |  |   |
|   |  |   |   | ☺ | ☹ |   |  |   |
|   |  |   |   |   | ☺ |   |  |   |
|   |  |   |   |   | ☺ |   |  |   |
|   |  |   |   |   |   |   |  | ☺ |
|   |  |   |   |   |   |   |  |   |
|   |  | ☺ |   |   | ☺ |   |  |   |
|   |  |   |   |   | ☺ |   |  |   |
|   |  |   | ☺ |   | ☹ |   |  |   |
|   |  |   |   |   | ☺ |   |  |   |
|   |  |   |   |   | ☹ |   |  |   |

## BLADES

- Blades listed come in sets of five (5) except those for Punkah®—one (1), Brewmaster®—two (2), and Palmetto—three (3).
- Blades should be ordered based on the fan model selected
- Blade sets vary based on catalog number and are specific to fan models
- Some blade catalog numbers require fan finish codes
- Due to the nature of the materials and the hand-crafted processes; stain, color, texture and shading will vary



|                    |             |               |             |               |                |                |  |
|--------------------|-------------|---------------|-------------|---------------|----------------|----------------|--|
| Americana®         | <b>ISP1</b> |               | <b>ISP4</b> | <b>FP1018</b> | <b>B5280WA</b> | <b>B6080WA</b> |  |
| Belleria®          | <b>ISP1</b> |               | <b>ISP4</b> |               | <b>B5280WA</b> | <b>B6080WA</b> |  |
| Bourbon Street®    | <b>ISP1</b> |               | <b>ISP4</b> | <b>FP1018</b> | <b>B5280WA</b> | <b>B6080WA</b> |  |
| Brewmaster®        | <b>BMP1</b> |               |             |               |                |                |  |
| Islander® AC       | <b>ISP1</b> |               | <b>ISP4</b> |               | <b>B5280WA</b> | <b>B6080WA</b> |  |
| Palmetto®          |             | <b>PMP2**</b> |             |               |                |                |  |
| Punkah®            | <b>PUP1</b> |               |             |               |                |                |  |
| Windpointe® Custom | <b>ISP1</b> |               | <b>ISP4</b> |               | <b>B5280WA</b> | <b>B6080WA</b> |  |



|                    |              |                |              |              |              |               |  |
|--------------------|--------------|----------------|--------------|--------------|--------------|---------------|--|
| Americana®         | <b>ISD1A</b> |                | <b>ISD4A</b> | <b>BPD1A</b> | <b>BPD4A</b> | <b>BPD4MW</b> |  |
| Belleria®          | <b>ISD1A</b> |                | <b>ISD4A</b> | <b>BPD1A</b> | <b>BPD4A</b> | <b>BPD4MW</b> |  |
| Bourbon Street®    | <b>ISD1A</b> |                | <b>ISD4A</b> | <b>BPD1A</b> | <b>BPD4A</b> | <b>BPD4MW</b> |  |
| Brewmaster®        |              |                | <b>BMD4A</b> |              |              |               |  |
| Islander® AC       | <b>ISD1A</b> |                | <b>ISD4A</b> | <b>BPD1A</b> | <b>BPD4A</b> | <b>BPD4MW</b> |  |
| Palmetto®          |              | <b>PMD2A**</b> |              |              |              |               |  |
| Punkah®            | <b>PUD1A</b> | <b>PUD1C</b>   |              |              |              |               |  |
| Windpointe® Custom | <b>ISD1A</b> |                | <b>ISD4A</b> | <b>BPD1A</b> | <b>BPD4A</b> | <b>BPD4MW</b> |  |

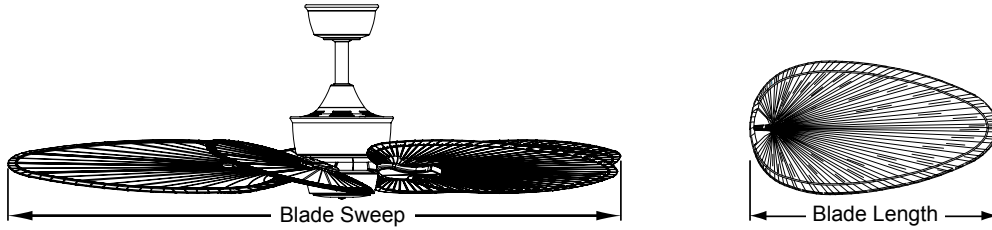

|  |                |                |                |                |                |                  |                  |
|--|----------------|----------------|----------------|----------------|----------------|------------------|------------------|
|  | <b>B5340WA</b> | <b>B5350WA</b> | <b>B5300WA</b> | <b>B5330WA</b> | <b>B6130WA</b> | <b>B5133TKMH</b> | <b>B6133TKMH</b> |
|  | <b>B5340WA</b> | <b>B5350WA</b> | <b>B5300WA</b> | <b>B5330WA</b> | <b>B6130WA</b> | <b>B5133TKMH</b> | <b>B6133TKMH</b> |
|  | <b>B5340WA</b> | <b>B5350WA</b> | <b>B5300WA</b> | <b>B5330WA</b> | <b>B6130WA</b> | <b>B5133TKMH</b> | <b>B6133TKMH</b> |
|  | <b>B5340WA</b> | <b>B5350WA</b> | <b>B5300WA</b> | <b>B5330WA</b> | <b>B6130WA</b> | <b>B5133TKMH</b> | <b>B6133TKMH</b> |
|  | <b>B5340WA</b> | <b>B5350WA</b> | <b>B5300WA</b> | <b>B5330WA</b> | <b>B6130WA</b> | <b>B5133TKMH</b> | <b>B6133TKMH</b> |



|  |               |               |               |               |                |                |                   |                  |                  |
|--|---------------|---------------|---------------|---------------|----------------|----------------|-------------------|------------------|------------------|
|  | <b>BPP1TN</b> | <b>BPP4TN</b> | <b>BPP1BR</b> | <b>BPP4BR</b> | <b>BPW20CY</b> | <b>BPW24MW</b> | <b>BPW6090DNA</b> | <b>BPW6030MH</b> | <b>BPW6030TK</b> |
|  | <b>BPP1TN</b> | <b>BPP4TN</b> | <b>BPP1BR</b> | <b>BPP4BR</b> | <b>BPW20CY</b> | <b>BPW24MW</b> | <b>BPW6090DNA</b> | <b>BPW6030MH</b> | <b>BPW6030TK</b> |
|  | <b>BPP1TN</b> | <b>BPP4TN</b> | <b>BPP1BR</b> | <b>BPP4BR</b> | <b>BPW20CY</b> | <b>BPW24MW</b> | <b>BPW6090DNA</b> | <b>BPW6030MH</b> | <b>BPW6030TK</b> |
|  | <b>BPP1TN</b> | <b>BPP4TN</b> | <b>BPP1BR</b> | <b>BPP4BR</b> | <b>BPW20CY</b> | <b>BPW24MW</b> | <b>BPW6090DNA</b> | <b>BPW6030MH</b> | <b>BPW6030TK</b> |
|  | <b>BPP1TN</b> | <b>BPP4TN</b> | <b>BPP1BR</b> | <b>BPP4BR</b> | <b>BPW20CY</b> | <b>BPW24MW</b> | <b>BPW6090DNA</b> | <b>BPW6030MH</b> | <b>BPW6030TK</b> |

# ANTIQUe FAN MUSEUM

*presented by the Antique Fan Collectors Association*



## PASSION, HERITAGE & PRESERVATION

Led by our Founder and CEO, Tom Frampton, Fanimation is dedicated to preserving the history of fans and the fan industry. For years, Tom has been an avid antique fan collector and member of the Antique Fan Collectors Association (AFCA). The AFCA membership has operated a museum since 1997, displaying fans on loan by the membership; this museum was in Wichita, Kansas up until 2008, when the need to relocate the museum arose. Answering the call to preserve viewing of the one-of-a-kind collection, Fanimation made the offer to house the museum at its facility in Zionsville. The move and set-up took nearly a year and the museum saw its reopening July 23, 2009. Since that time, the museum has grown and continues to grow, housing over a thousand antique fans on two floors. Tom's own unique collection of fans is a part of the museum collection along with over 500 antique advertising style hand fans and other fan memorabilia.





## LOCATION

10983 Bennett Parkway  
Zionsville, IN 46077



## HOURS

Monday thru Friday 10 am - 4 pm  
Or call for an appointment, 317-733-4113



## MUSEUM HIGHLIGHTS

- The AFCA museum contains more than 1,000 antique ceiling, desk and hand fans with over 140 manufacturers represented
- The oldest electric desk fan in the museum dates from the early 1890's
- The oldest non-electric fans (steam, belt & pulley or water powered) date from the early 1880's.
- It is the only antique fan museum open to the public in the world
- The AFCA has approximately 700 members worldwide
- The museum contains some of the earliest battery-powered fans, water-powered fans, wind-up fans, electric hand-held fans, ceiling fans, wall fans, desk fans, pedestal fans, rail-car fans and fans that don't even look like fans.
- The museum contains hundreds of hand-held fans that feature advertising from manufactures, retailers, politicians and movie stars.



## INDEX

|                      |             |                           |             |                    |             |
|----------------------|-------------|---------------------------|-------------|--------------------|-------------|
| <b>FANS</b>          | <b>PAGE</b> | <b>FITTERS</b>            | <b>PAGE</b> | <b>BLADES</b>      | <b>PAGE</b> |
| BP200**1-220 .....   | 15, 16      | F423**-220 .....          | 61          | ISP4 .....         | 65          |
| BP220**1-220 .....   | 15, 16      | FW423**-220 .....         | 61          | PMP2 .....         | 65          |
| BP225OB1-220 .....   | 15, 16      |                           |             | PUD1A .....        | 51, 65      |
| FP10** .....         | 53, 54      | <b>GLASS &amp; SHADES</b> | <b>PAGE</b> | PUD1C .....        | 65          |
| FP1280**-220 .....   | 53, 54      | G210 .....                | 61          | PUP1 .....         | 51, 65      |
| FP20** .....         | 53, 54      | G439 .....                | 61          |                    |             |
| FP2120MG-220 .....   | 27, 28      | G450 .....                | 61          | <b>CONTROLS</b>    | <b>PAGE</b> |
| FP320**1-220 .....   | 47, 48      | G451 .....                | 61          | C1-220 .....       | 63          |
| FP410**-220 .....    | 49, 50      | G456 .....                | 61          | C2-220 .....       | 63          |
| FP4320**1-220 .....  | 45, 46      |                           |             | C3-220 .....       | 54, 63      |
| FP4620**-220 .....   | 9, 10       | <b>BLADES</b>             | <b>PAGE</b> | C6-220 .....       | 63          |
| FP4640**-220 .....   | 33, 34      | B4400SN .....             | 9           | CW6717WH-220 ..... | 30, 64      |
| FP510** .....        | 17, 18      | B4442** .....             | 9           | CW6721WH-220 ..... | 38, 64      |
| FP520** .....        | 17, 18      | B5133TKMH .....           | 47, 66      | CW6729WH-220 ..... | 32, 64      |
| FP540** .....        | 17, 18      | B5280WA .....             | 43, 65      | CW8332-220 .....   | 22, 64      |
| FP580**-220 .....    | 17, 18      | B5300WA .....             | 66          | CW8355-220 .....   | 24, 64      |
| FP601**-220 .....    | 17, 18      | B5330WA .....             | 66          | CRL4WH-220 .....   | 64          |
| FP602**-220 .....    | 17, 18      | B5340WA .....             | 43, 45, 66  | CW110-220 .....    | 26, 63      |
| FP603**-220 .....    | 17, 18      | B5350WA .....             | 66          | CW40-220 .....     | 10, 63      |
| FP604**-220 .....    | 17, 18      | B6080WA .....             | 65          | TR39ND-220 .....   | 36, 64      |
| FP605**-220 .....    | 17, 18      | B6130WA .....             | 66          | TR4WH-220 .....    | 28, 64      |
| FP6252BN .....       | 59, 60      | B6133TKMH .....           | 66          | TRL4WH-220 .....   | 14, 64      |
| FP6717**-220 .....   | 29, 30      | B6720** .....             | 37, 38      |                    |             |
| FP6729**-220 .....   | 31, 32      | BMD4A .....               | 53, 65      | <b>ACCESSORIES</b> | <b>PAGE</b> |
| FP720** .....        | 51, 52      | BMP1 .....                | 53, 65      | CCK8002** .....    | 62          |
| FP780**-220 .....    | 51, 52      | BPD1A .....               | 65          | CCK8002**W .....   | 62          |
| FP7910OB-220 .....   | 11, 12      | BPD4A .....               | 45, 65      | DR1-12** .....     | 62          |
| FP8003**-220 .....   | 13, 14      | BPD4MW .....              | 65          | DR1SS-12**W .....  | 62          |
| FP8015**-220 .....   | 57, 58      | BPP1BR .....              | 66          | DR1-18** .....     | 62          |
| FPD8148**-220 .....  | 35, 36      | BPP1TN .....              | 66          | DR1SS-18**W .....  | 62          |
| FPS8332**-220 .....  | 21, 22      | BPP4BR .....              | 45, 66      | DR1-24** .....     | 62          |
| FPS8355**-220 .....  | 23, 24      | BPP4TN .....              | 49, 66      | DR1SS-24**W .....  | 62          |
| MA6721**-220 .....   | 37, 38      | BPW20CY .....             | 43, 47, 66  | DR1-36** .....     | 62          |
| MA7500**-220 .....   | 43, 44      | BPW24MW .....             | 66          | DR1SS-36W** .....  | 62          |
| OF110**-220 .....    | 25, 26      | BPW4426** .....           | 9, 33       | DR1-48** .....     | 62          |
| TF910**-220 .....    | 39, 40      | BPW4442** .....           | 9           | DR1SS-48**W .....  | 62          |
| TF971**-220 .....    | 41, 42      | BPW6030MH .....           | 66          | DR1-60** .....     | 62          |
|                      |             | BPW6030TK .....           | 66          | DR1SS-60**W .....  | 62          |
| <b>LIGHT KITS</b>    | <b>PAGE</b> | BPW6090DNA .....          | 46, 66      | DR1-60B .....      | 62          |
| LK4640**-220 .....   | 33          | FP1018 .....              | 17, 49, 65  | DR1-72** .....     | 62          |
| LK6721**-220 .....   | 37, 38      | FP1022 .....              | 53          | DR1SS-72**W .....  | 62          |
| LKLP101SN-220 .....  | 61          | FP1026 .....              | 53          | DR1-CP** .....     | 62          |
| LKLP102OB-220 .....  | 43, 61      | FP1030 .....              | 53          | DRS24TR .....      | 62          |
| LKLP102SN-220 .....  | 61          | ISD1A .....               | 44, 65      | SCB1-52 .....      | 62          |
| LKLP112AOB-220 ..... | 61          | ISD4A .....               | 48, 65      |                    |             |
| LKLP112WSN-220 ..... | 61          | ISP1 .....                | 47, 65      |                    |             |