

Metallics

Distributor Catalogue 2010-2011

THE METALLICS QUICK
REFERENCE GUIDE

**Anchors, Fasteners,
Tools, and Specialty Products
for the Electrical,
Plumbing, Heating and
Air Conditioning Industries**



Screws &
Screw Kits

A



Nuts &
Nut Kits

B



Washers &
Washer Kits

C



Hexagon
Bolts

D



Anchoring
Devices

E



Telecom Access.
Cable Ties
Plastic Fasteners

F



Fixture Hanging
Accessories

G



Special Purpose
Electrical
Fasteners

H



Tools • Drills
and Accessories

I



Chemicals • Tape
Hand Cleaner
DAP Products

J



Accessories
Pro. Eyewear
First Aid Kits

K



Point of
Purchase
Displays

K

TO OUR DISTRIBUTORS

OFFERING YOU
OVER 1,100
NEW PRODUCTS
FOR 2010-11

The Metallics Difference

Here at Metallics, we realize our distributors' needs for competitive products at competitive prices. We also believe that the reason to take on the Metallics line is to maximize profits. We understand that you, the distributor, are in this business to make a profit. Metallics works closely with distributors in order to grow their bottom-line profitability and increase revenues.

Our company constantly employs more efficient and streamlined methods of doing business. These techniques allow us to operate at peak efficiency in order to pass on our savings to you. In fact, our distributors named the Metallics line the highest Gross Margin Rate of Return over all other lines. In addition to a higher profit margin, we offer:

- Manufacturing
- Live Customer Support
- Exclusive "Hardbody" Packaging
- Same Day Shipping
- Highest Fill Rate
- Distributor Price Catalogue on CD
- Highest Ratio of American-made to Foreign-made Product
- Locations in Bristol, Connecticut and Mancos, Colorado

With Metallics, you can be sure that a strong relationship will be built not only with us, but between you and the customers you serve. Our knowledgeable sales and support staff is always available to answer your questions.



We Lead, They Follow

In the highly competitive world of fasteners and related supplies, companies need to differentiate themselves. Metallics is not just a supplier of fasteners and related supplies. We are also one of the few suppliers that design and manufacture fastener components to your specifications. In coordination with our affiliate, Avanti Screw, we are able to design and produce new and innovative fasteners in our Bristol, Connecticut, plant. We are the gold standard in fasteners!



At Metallics, we are always looking toward the future to provide innovative and profitable solutions for our distributors. Since we sell solely to distributors, you can be confident you will not see the products in this catalogue sold at any of America's "Depot-Marts" or sold directly to your contractors. With new products such as Tri-Drive, and QuaDrive Screws, and Hardbody Packaging, you can offer your customers the most unique and profitable products available. This all leads to maximum profitability for you. This new catalogue will reflect the many new exciting fasteners available for 2010 and 2011.

YOU DESERVE THE PERSONAL TOUCH

Always speak to live people!

In a world ruled by voice mail, answering machines, emails and computerized operators, it can sometimes be difficult to reach a live representative. When you call Metallics, you can be assured you will always be able to speak to a person, not a machine. And with two locations in Bristol, Connecticut, and Mancos, Colorado, there is always someone available. When time matters, voice mail and answering services will only slow you down, minimizing profits. We are proud to have an extremely knowledgeable and readily available team to aid you with answers to your fastener questions. All this because YOU deserve the personal touch.

With this new catalogue, Metallics has made it easier for the distributor, sales team, purchasing and staff people to find product. We understand the importance of removing the hassle from catalogue searching; this is the reason for our new user-friendly format. Color-coded reference tabs make it a snap to stay organized and to quickly find the section you need. The time saved searching will mean more efficiency in securing new sales, as well as expanding existing sales with the ultimate goal of higher profits for you. After all, time is money.

None of our competitors selling to the Distribution trade can claim they manufacture screws. We can and do. Right in Bristol, CT, USA.

There is no doubt: We know the American fastener market and are ahead of our competitors. Avanti Screw, Inc., our fastener manufacturing facility in Bristol, CT, guarantees that we are the only American fastener company that makes a portion of its product sold through electrical distributors.

We know the fastener market and have been serving it since 1959. Our Avanti Screw, Inc. manufacturing facility guarantees that we are different. We are able to fill the need for unique and very profitable fasteners for today's industry.

TERMS

1% 10th net prox., Minimum order \$25.00

Prepaid shipments :

\$550.00 Continental U.S.

\$1,100.00 Alaska and Hawaii

see page 95 for Co-Labeling and Reduced Price on Large Quantity Orders of Anchors.

Remember, Metallics has an east and west warehouse and a manufacturing facility.

Same Day Shipments = 98.3% Fill Rate = 98.1%

We get product to you, easier and faster!



This symbol denotes a product made by a quality American producer. In the case of fasteners, many are produced at Avanti Screw, Inc., a Metallics affiliate.

All salespeople act as if they are selling the same commodity as Metallics. We sell something better: value, service, trust, consistency, and profit building for you and your customer.



We believe Metallics has the largest ratio of American-made to foreign-produced product of any other American fastener company.

It appears that our competitors in the past, and today, have failed to copy our lead in denoting a place of origin in their catalogues. We need to ask, "Why?"

NAED Reference Number: 39720
 Electronic Data Interchange (EDI) at one central location.
 Please call for further information:
 East: 1.800.243.8272
 West: 1.800.269.5183

Metallics Distributor Net Cost Catalogue on Compact Disc



Our customers have asked for an easy, simple way to look up pricing on their computers, and we have responded. Metallics offers a distributor net price catalogue on CD, available upon request through our sales representatives.

Metallics truly is the Gold Standard of fastener distributors.

PRODUCTS SHOWN WITH "MADE IN USA" MAY CHANGE WITHOUT NOTICE

QUICK REFERENCE PRODUCT INDEX

A SCREWS

DECK • DRILL • DRYWALL • MACHINE • SHEET METAL STOVE • TAPPING • WOOD	PAGE	10 - 38
SECURITY SCREWS • TOOLS • ORGANIZERS	PAGE	39 - 50
KITS	PAGE	51 - 54
USA PRODUCTS – LOOK FOR 		

B NUTS

CAP • HEX • LOCK • SQUARE • WING • THREAD INSERT	PAGE	55 - 59
KITS	PAGE	56, 59
USA PRODUCTS – LOOK FOR 		

C WASHERS

CONICAL • FENDER • FLAT SAE • FLAT USS • LOCK REDUCING • FINISHING • OCTAGONAL • SEALING	PAGE	60 - 66
KITS	PAGE	60, 64, 66
USA PRODUCTS – LOOK FOR 		

D BOLTS

HEX • CAP • CARRIAGE • LAG • TAP • U-BOLT	PAGE	67 - 80
USA PRODUCTS – LOOK FOR 		

E ANCHORING DEVICES

CONCRETE SCREW ANCHORS • DRILLS • DRIVERS • DROP IN WEDGE • SLEEVE • ROD • EXPANSION	PAGE	81 - 97
MECHANICAL ANCHORS NAILS • DRIVE PINS TOOL • NAIL-INS	PAGE	97 - 104
PLASTIC DRYWALL ANCHORS	PAGE	106 - 108
TOGGLE BOLT ANCHORS • TOGGLE BOLTS • TOGGLE HEADS	PAGE	87 - 90 124 - 125
KITS (VOLUME DISCOUNTS) • PLASTIC ANCHORS CONCRETE SCREWS • TOGGLE BOLTS	PAGE	82, 87, 90, 104, 110 - 123
USA PRODUCTS – LOOK FOR 		

F TELECOM, CABLE TIES & CLAMPS

CABLE TIES • TOOLS • WRAPS	PAGE	126 - 129, 135
CABLE TIE MOUNTS • CLAMPS • HOSE CLAMPS	PAGE	129 - 135
USA PRODUCTS – LOOK FOR 		

QUICK REFERENCE PRODUCT INDEX

G FIXTURE HANGING ACCESSORIES

CHAIN • CEILING WIRE	PAGE	141 - 142
THREADED RODS • COUPLINGS • CLAMPS • LOCK NUTS	PAGE	136 - 137
HOOKS • SCREWS • EYEBOLTS • "J" BOLTS	PAGE	138 - 140
THREADED ROD HANGERS	PAGE	143 - 154
TIE WIRE AND DISPENSER	PAGE	141
KITS	PAGE	137 - 138
USA PRODUCTS – LOOK FOR 		

H SPECIAL PURPOSE ELECTRICAL FASTENERS

GROUNDING SCREWS • PIGTAILS • CLIPS	PAGE	155 - 158
SCREW KITS	PAGE	159, 161 - 163
CAGE NUTS • CAGE NUT KITS	PAGE	159 - 161
KNOCK OUT SEALS • CONDUIT LOCK NUT	PAGE	167, 174
BOX SUPPORTS • BRIDLE RINGS CEILINGPLATES • CONDUIT FASTENERS • GASKETS	PAGE	167 - 168
NAILS • NAIL APRON • NAIL PLATES • DRIVE RINGS PLATE STRAP • PLUMBERS TAPE	PAGE	169 - 171
RECEPTACLE AND SWITCH PLATE SCREWS • THUMB	PAGE	162 - 165
STAPLES	PAGE	172 - 177
USA PRODUCTS – LOOK FOR 		

I TOOLS, DRILLS AND ACCESSORIES

SCREW DRIVERS • TAPE MEASURES • UTILITY KNIVES STAPLE GUNS • IMPACT DRIVER AND BITS	PAGE	178 - 183
BITS • NUT SETTERS • SAW-CABLE • SAW KEYHOLE • MARKERS SETTING TOOLS • CRAYON • HAMMER • TAPS • CAULK GUNS	PAGE	183 - 191
DRILLS • DRIVER	PAGE	192 - 199
ROOF JACKS AND KITS • FLOOR FLANGES • MARKERS LOCKS • ORGANIZERS • STRAPS	PAGE	200 - 207
USA PRODUCTS – LOOK FOR 		

QUICK REFERENCE PRODUCT INDEX

J	CHEMICAL PRODUCTS		
	WIPES • INSULATING FOAM	PAGE	208 - 210
	FIREBLOCK FOAM • FIRE PATCH	PAGE	209, 211
	ROOF PATCH • SPACKLE • CAULK • CAULK GUNS.....	PAGE	211 - 215
	OXIDE INHIBITOR	PAGE	216
	USA PRODUCTS – LOOK FOR 		

K	ACCESSORIES, TAPES, EYE WARE, FIRST AID		
	CONDUIT MEASURING TAPE	PAGE	218
	ELECTRICAL • DUCT • TEFLON • ALUMINUM	PAGE	217 - 218
	TAPES (DETECTABLE - NON-DETECTABLE) • CAUTION	PAGE	219
	CHILL OUTS • SAFETY GLASSES • FIRST AID KITS	PAGE	220 - 224
	SHOE COVERS • RAGS	PAGE	225 - 226
	USA PRODUCTS – LOOK FOR 		

L	POINT OF PURCHASE DISPLAYS		
	DISPLAYS • HEADER CARDS • SHELF LABELS	PAGE	227 - 234
	USA PRODUCTS – LOOK FOR 		

	MISCELLANEOUS		
	QUICK REFERENCE GUIDE	PAGE	235
	MANUFACTURING DETAILS	PAGE	235, 236
	FASTENER REFERENCE GUIDE	PAGE	237
	QUICK REFERENCE PRODUCT INDEX	PAGE	238 - 249
	SALES FORCE INDEX	PAGE	Inside Back Cover

TO OUR ELECTRICAL DISTRIBUTORS: WE ASK YOU TO UNDERSTAND OUR POSITION.

Since 1968, Metallics has not included yearly stock balancing of distributor's inventory as part of our catalogue fastener program. We have chosen instead to provide the lowest prices in America, superior packaging, same-day shipment, lower prepaids, best fastener fill rate in America, and logistical support in the way of promotions, advertising and sales representative training. At this time we do not anticipate offering stock balancing.

New Customer Buyout of Competitor Inventory: Over the years, many fastener suppliers have gone in and purchased competitor inventories from the electrical distributor, then replaced that inventory with their own products. Metallics has never had this as a catalogue option, and we do not anticipate such a program.

An Honest Mistake or Customer Cancellation: We do offer to take back any single item resulting from a distributor's order entry error. We will also consider taking back an item cancelled by a customer of our electrical distributors. Call to inquire about our RMA System.

The QuaDrive

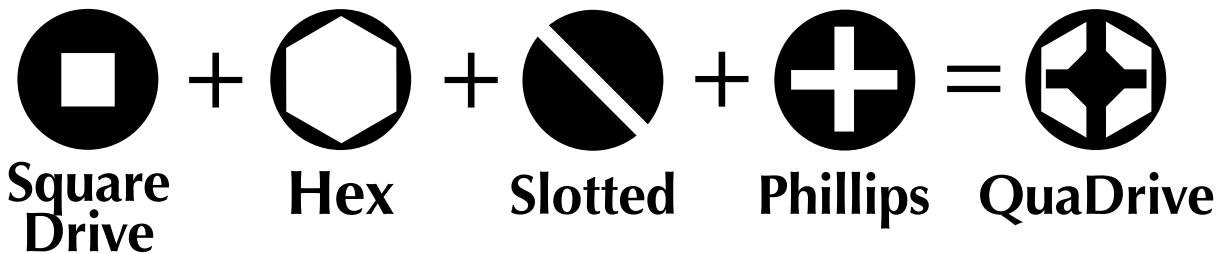

**America's Newest Drive - Designed, Developed and
Manufactured by Metallics/Avanti Screw**

EASTERN

8:00 A.M.
to
5:00 P.M.



Metallics, Inc. CT

CENTRAL



MOUNTAIN

8:00 A.M.
to
5:00 P.M.



Metallics, West Inc. CO

In the event Metallics East, Bristol is CLOSED, call Metallics West at 1-800-269-5183 if you require technical information or overnight shipments



Our goal at Metallics is to present information accurately. Metallics is not responsible for claims traceable to typographical or other errors that may be contained herein. Metallics makes no warranties as to the accuracy of the information contained in this catalogue.

ONLY METALLICS!

AN INDUSTRY FIRST!
A free square drive bit with each jar of Tri-Drive Machine Screws



A

-  Slotted
-  Phillips
-  Square Drive



ROUND TRI-DRIVE MACHINE SCREWS

STEEL ZINC CHROMATE

MADE IN USA



Manufactured by
Avanti Screw, Inc.,
A Metallics
Affiliate

*Three drives
in one head!*

Introduced nationally by Metallics in 1994

STOCK NO.	UPC NO.	DIAMETER	LENGTH	WT. PER PKG.	STD. PKG./MSTR. SLEEVE	SUGGESTED TRADE LIST PRICE PER
JTRM80	80003	6-32	1/2	.28	100/500	4.08/c
JTRM81	80004	6-32	3/4	.36	100/500	4.08/c
JTRM63	80005	6-32	1	.43	100/500	4.43/c
JTRM82	80006	6-32	1 1/2	.58	100/500	5.18/c
JTRM83	80007	6-32	2	.73	100/500	6.35/c
JTRM84	80008	8-32	1/2	.45	100/500	6.05/c
JTRM85	80009	8-32	3/4	.51	100/500	6.08/c
JTRM86	80010	8-32	1	.65	100/500	6.10/c
JTRM87	80011	8-32	1 1/4	.75	100/500	6.15/c
JTRM88	80012	8-32	1 1/2	.86	100/500	7.83/c
JTRM89	80013	8-32	2	1.07	100/500	8.03/c
JTRM16	81255	10-32	1/4	.49	100/500	3.45/c
JTRM33	80014	10-32	1/2	.57	100/500	4.93/c
JTRM98	80015	10-32	1	.89	100/500	6.65/c
JTRM22	80016	1/4-20	3/8	.95	100/500	8.48/c
JTRM99	80017	1/4-20	1/2	1.10	100/500	8.53/c
JTRM100	80018	1/4-20	3/4	1.33	100/500	8.55/c
JTRM101	80019	1/4-20	1	1.58	100/500	10.13/c
JTRM102	80020	1/4-20	1 1/4	1.77	100/500	12.33/c
JTRM103	80021	1/4-20	1 1/2	2.08	100/500	12.38/c
JTRM104	80022	1/4-20	2	2.62	100	15.78/c

ALSO AVAILABLE—TRI-DRIVE™ SHEET METAL SCREWS

QUALITY GUARANTEED

METALLICS STANDS TALL BEHIND AUTHORIZED DISTRIBUTORS AND THEIR PROFESSIONAL USERS:

Any product purchased from this catalogue may be returned within 30 days of purchase if our distributor or contractor is not fully satisfied with the quality.

Distributor—please include Metallics or Metallics West invoice with item, if deemed faulty or of poor quality, we will replace the individual item or issue full credit .

Our goal is to please you. Call to Inquire about our RMA Policy.

AMERICA'S SOURCE FOR PREMIER & INNOVATIVE FASTENERS AND ANCHORS

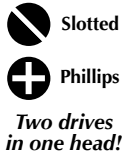

ROUND "COMBO" MACHINE SCREWS

SLOTTED AND PHILLIPS. STEEL ZINC CHROMATE

In 1985, Metallics was the first fastener company in America to offer a full line of Combo's!



STOCK NO.	UPC NO.	DIAMETER	LENGTH	WT. PER PKG.	STD. PKG/ MSTR. SLEEVE	SUGGESTED TRADE LIST PRICE PER
JRM17	80023	6-32	3/8	.25	100/500	2.98/c
JRM80	80024	6-32	1/2	.27	100/500	3.28/c
JRM81	80025	6-32	3/4	.34	100/500	3.18/c
JRM63	80026	6-32	1	.42	100/500	3.53/c
JRM68	80027	6-32	1 1/4	.49	100/500	3.85/c
JRM82	80028	6-32	1 1/2	.56	100/500	4.78/c
JRM83	80029	6-32	2	.70	100/500	6.90/c
JRM140	80030	6-32	2 1/2	.86	100/500	7.23/c
JRM142	80031	6-32	3	1.02	100	8.38/c
JRM144	81129	6-32	4	1.41	100	25.45/c NEW
JRM18	80032	8-32	3/8	.34	100/500	2.98/c
JRM84	80033	8-32	1/2	.40	100/500	3.33/c
JRM85	80034	8-32	3/4	.51	100/500	3.55/c
JRM86	80035	8-32	1	.60	100/500	4.00/c
JRM87	80036	8-32	1 1/4	.73	100/500	4.50/c
JRM88	80037	8-32	1 1/2	.83	100/500	5.30/c
JRM89	80038	8-32	2	1.08	100/500	7.40/c
JRM90	80039	8-32	2 1/2	1.27	100/500	8.03/c
JRM91	80040	8-32	3	1.58	100	9.33/c
JRM23	81085	8-32	4	2.01	100	13.03/c NEW
JRM19	80041	10-24	3/8	.45	100/500	3.38/c
JRM32	80042	10-24	1/2	.52	100/500	3.40/c
JRM92	80043	10-24	3/4	.67	100/500	4.03/c
JRM93	80044	10-24	1	.81	100/500	4.55/c
JRM94	80045	10-24	1 1/4	.95	100/500	5.03/c
JRM95	80046	10-24	1 1/2	1.12	100/500	5.88/c
JRM96	80047	10-24	2	1.39	100/500	7.40/c
JRM97	80048	10-24	2 1/2	1.65	100	8.93/c
JRM127	80049	10-24	3	1.97	100	10.40/c
JRM150	86150	10-24	4	2.57	100	23.53/c NEW
JRM20	80050	10-32	3/8	.48	100/500	3.38/c
JRM33	80051	10-32	1/2	.55	100/500	3.40/c
JRM48	80052	10-32	3/4	.70	100/500	4.03/c
JRM98	80053	10-32	1	.86	100/500	4.55/c
JRM69	80054	10-32	1 1/4	.99	100/500	5.03/c
JRM75	80055	10-32	1 1/2	1.14	100/500	5.88/c
JRM113	80056	10-32	2	1.47	100/500	7.40/c
JRM114	86114	10-32	2 1/2	1.79	100	8.23/c NEW
JRM190	86190	10-32	3	2.11	100	13.93/c NEW
JRM22	80057	1/4-20	3/8	.90	100/500	5.88/c
JRM99	80058	1/4-20	1/2	1.00	100/500	6.23/c
JRM100	80060	1/4-20	3/4	1.25	100/500	6.90/c
JRM101	80061	1/4-20	1	1.54	100/500	7.88/c
JRM102	80062	1/4-20	1 1/4	1.78	100/500	8.03/c
JRM103	80063	1/4-20	1 1/2	2.00	100/500	8.15/c
JRM104	80064	1/4-20	2	2.52	100	11.00/c
JRM105	81105	1/4-20	2 1/2	3.06	100	13.93/c
JRM128	81110	1/4-20	3	3.58	100	14.60/c
JRM132	81115	1/4-20	4	4.61	100	18.85/c
JRM133	81116	1/4-20	5	5.95	100	36.93/c NEW
JRM134	81119	1/4-20	6	6.77	100	67.18/c NEW

CONTINUED ON NEXT PAGE

SCREWS



Slotted



Phillips

Two drives
in one head!



CONTINUED

ROUND "COMBO" MACHINE SCREWS

SLOTTED AND PHILLIPS. STEEL ZINC CHROMATE

In 1985, Metallics was the first fastener company in America to offer a full line of Combo's!

STOCK NO.	UPC NO.	DIAMETER	LENGTH	WT. PER PKG.	STD. PKG/ MSTR. SLEEVE	SUGGESTED TRADE LIST PRICE PER	
JRM35	83935	5/16-18	1/2	1.88	100/500	13.38/c	NEW
JRM50*	81099	5/16-18	3/4	2.12	100/500	15.15/c	NEW
JRM65	81103	5/16-18	1	2.70	100	18.48/c	NEW
JRM71	83971	5/16-18	1 1/4	3.11	100	19.43/c	NEW
JRM77*	83977	5/16-18	1 1/2	3.58	100	21.00/c	NEW
JRM115	86115	5/16-18	2	4.55	100	37.13/c	NEW
JRM36	80065	3/8-16	1/2	2.91	100/500	17.23/c	
JRM51	80066	3/8-16	3/4	3.43	100	19.65/c	
JRM66	80067	3/8-16	1	4.03	100	19.78/c	
JRM72	80068	3/8-16	1 1/4	4.47	100	20.83/c	
JRM78	80069	3/8-16	1 1/2	5.00	100	24.18/c	
JRM116	80070	3/8-16	2	6.48	100	25.95/c	
JRM123	80071	3/8-16	2 1/2	7.54	100	32.48/c	
JRM130	80072	3/8-16	3	4.34	50	37.06/c	
JRM135	81120	3/8-16	4	5.65	50	49.80/c	
RM136	10131	3/8-16	5	13.96	50	117.73/c	NEW

OTHER SIZES AND QUANTITIES AVAILABLE BY REQUEST

* = Slotted Only



Phillips



NEW!

PAN HEAD PHILLIPS MACHINE SCREW

STEEL ZINC CHROMATE

STOCK NO.	UPC NO.	DIAMETER	LENGTH	WT. PER PKG.	STD. PKG/ MSTR. SLEEVE	SUGGESTED TRADE LIST PRICE PER	
JPMP78	86312	6-32	1/4	.23	100/500	5.43/c	NEW
JPMP63	86263	6-32	1	.42	100/500	5.48/c	NEW
JPMP4	86255	8-32	1/4	.34	100/500	4.78/c	NEW
JPMP84	86270	8-32	1/2	.43	100/500	4.83/c	NEW
JPMP85	86271	8-32	3/4	.55	100/500	5.03/c	NEW
JPMP86	86272	8-32	1	.66	100/500	5.10/c	NEW
JPMP88	86266	8-32	1 1/2	.83	100/500	8.45/c	NEW
JPMP6	86257	10-32	1/4	.47	100/500	5.25/c	NEW
JPMP20	86288	10-32	3/8	.56	100/500	4.83/c	NEW
JPMP1032	86324	10-32	1	.95	100/500	8.55/c	NEW
JPMP75	86294	10-32	1 1/2	1.27	100/500	9.43/c	NEW

OTHER SIZES AND QUANTITIES AVAILABLE BY REQUEST



METALLICS

AMERICA'S SOURCE FOR PREMIER AND
INNOVATIVE FASTENERS & ANCHORS



Slotted



STAINLESS STEEL ROUND HEAD SLOTTED MACHINE SCREWS

18-8 SERIES TYPE

A

STOCK NO.	UPC NO.	DIAMETER	LENGTH	WT. PER PKG.	STD. PKG/ MSTR. SLEEVE	SUGGESTED TRADE LIST PRICE PER
JSRM50	80073	6-32	3/8	.24	100/500	7.80/c
JSRM10	80074	6-32	1/2	.29	100/500	9.55/c
JSRM51	80075	6-32	3/4	.38	100/500	13.45/c
JSRM11	80076	6-32	1	.44	100/500	14.30/c
JSRM12	80077	6-32	1 1/4	.51	100/500	15.18/c
JSRM13	80078	6-32	1 1/2	.58	100/500	15.60/c
JSRM14	80079	6-32	2	.72	100/500	17.33/c
JSRM60	80080	8-32	3/8	.35	100/500	10.33/c
JSRM15	80081	8-32	1/2	.41	100/500	10.83/c
JSRM61	80082	8-32	5/8	.43	100/500	12.13/c
JSRM16	80083	8-32	3/4	.54	100/500	12.58/c
JSRM17	80084	8-32	1	.64	100/500	12.98/c
JSRM18	80085	8-32	1 1/4	.70	100/500	19.85/c
JSRM19	80086	8-32	1 1/2	.84	100/500	21.25/c
JSRM20	80087	8-32	2	1.08	100/500	31.38/c
JSRM21	80088	10-24	1/2	.53	100/500	12.98/c
JSRM71	80089	10-24	5/8	.59	100/500	13.20/c
JSRM22	80090	10-24	3/4	.70	100/500	14.73/c
JSRM23	80091	10-24	1	.84	100/500	17.33/c
JSRM24	80092	10-24	1 1/4	.99	100/500	24.70/c
JSRM144	85144	10-24	1 1/2	1.13	100/500	29.23/c NEW
JSRM74	80093	10-24	1 3/4	1.27	100/500	32.30/c
JSRM146	85146	10-24	2	1.43	100/500	35.73/c NEW
JSRM25	80094	10-32	1/2	.57	100/500	12.98/c
JSRM26	80095	10-32	3/4	.74	100/500	16.05/c
JSRM27	80096	10-32	1	.87	100/500	19.03/c
JSRM28	80097	10-32	1 1/4	1.02	100/500	24.60/c
JSRM33	83733	10-32	1 1/2	1.18	100/500	29.68/c NEW
JSRM148	85148	10-32	2	1.33	100/500	35.73/c NEW
JSRM190	85190	10-32	3	1.68	100	54.03/c NEW
JSRM29	80098	1/4-20	3/8	.67	100/500	27.70/c
JSRM30	80099	1/4-20	1/2	1.02	100/500	32.50/c
JSRM31	80100	1/4-20	3/4	1.29	100/500	35.53/c
JSRM32	80101	1/4-20	1	1.51	100/500	35.53/c
JSRM85	80102	1/4-20	1 1/4	1.80	100/500	35.73/c
JSRM90	80103	1/4-20	1 1/2	2.07	100/500	49.38/c
JSRM95	83795	1/4-20	2	2.60	100	66.88/c NEW
JSRM97	83797	1/4-20	2 1/2	2.83	100	89.45/c NEW
JSRM100	85100	1/4-20	3	3.64	100	91.88/c NEW
JSRM132	89232	1/4-20	4	2.38	50	164.38/c NEW
SRM136	12020	1/4-20	6	6.86	100	372.40/c
JSRM133	85133	3/8-16	1/2	2.93	100/500	82.30/c NEW
JSRM66	83766	3/8-16	1	4.22	100	133.95/c NEW
JSRM134	85134	3/8-16	1 1/2	5.20	100	138.95/c NEW

OTHER SIZES AND QUANTITIES AVAILABLE BY REQUEST

Helpful Hints From Metallics:

Did You forget to ask?

GOT FASTENERS?

"We work hard to improve both Distributor Profit and Customer Satisfaction."

SCREWS

A



STAINLESS STEEL ROUND HEAD PHILLIPS MACHINE SCREWS **NEW!**

18-8 SERIES TYPE

STOCK NO.	UPC NO.	DIAMETER	LENGTH	WT. PER PKG.	STD. PKG/ MSTR. SLEEVE	SUGGESTED TRADE LIST PRICE PER		
JSRM11P	93511	6-32	1	.44	100/500	PLEASE	NEW	
JSRM13P	93513	6-32	1½	1.27	100/500		NEW	
JSRM14P	93514	6-32	2	.72	100/500		NEW	
JSRM15P	93515	8-32	½	.40	100/500		NEW	
JSRM17P	93517	8-32	1	.64	100/500		NEW	
JSRM19P	93519	8-32	1½	.86	100/500		NEW	
JSRM20P	93520	8-32	2	1.03	100/500		NEW	
JSRM21P	93521	10-24	½	.55	100/500		NEW	
JSRM23P	93523	10-24	1	.84	100/500		NEW	
JSRM24P	93524	10-24	1¼	.99	100/500		NEW	
JSRM74P	93574	10-24	1¾	1.32	100/500	CALL	NEW	
JSRM27P	93527	10-32	1	.89	100/500	FOR	NEW	
JSRM33P	93533	10-32	1½	1.19	100/500		NEW	
JSRM148P	93648	10-32	2	1.53	100/500		NEW	
JSRM100P	93600	12-24	¾	.92	100/500		TRADE	NEW
JSRM101P	93601	12-24	1	1.13	100/500		NEW	
JSRM102P	93602	12-24	1½	1.51	100/500		LIST	NEW
JSRM30P	93530	¼-20	½	1.02	100/500		PRICING	NEW
JSRM31P	93531	¼-20	¾	1.31	100/500			NEW
JSRM32P	93532	¼-20	1	1.62	100/500			NEW
JSRM85P	93585	¼-20	1¼	1.78	100/500			NEW
JSRM90P	93590	¼-20	1½	2.03	100/500	NEW		
JSRM95P	93595	¼-20	2	2.55	100/500	NEW		
JSRM137P	93637	¾-16	¾	3.66	100/500	NEW		
JSRM138P	93638	¾-16	1	4.22	100/500	NEW		
JSRM139P	93639	¾-16	1½	5.39	100	NEW		
JSRM140P	93640	¾-16	2	6.49	100	NEW		

OTHER SIZES AND QUANTITIES AVAILABLE BY REQUEST



STAINLESS STEEL PAN HEAD PHILLIPS MACHINE SCREWS **NEW!**

18-8 SERIES TYPE

STOCK NO.	UPC NO.	DIAMETER	LENGTH	WT. PER PKG.	STD. PKG/ MSTR. SLEEVE	SUGGESTED TRADE LIST PRICE PER		
JSPMP78SS	98978	6-32	¼	.22	100/500	PLEASE	NEW	
JSPMP17SS	98917	6-32	¾	.26	100/500		NEW	
JSPMP80SS	98980	6-32	½	.28	100/500		NEW	
JSPMP15SS	98915	8-32	½	.40	100/500		NEW	
JSPMP16SS	98916	8-32	¾	.63	100/500		NEW	
JSPMP1SS	98901	8-32	1½	.83	100/500		CALL	NEW
JSPMP20SS	98920	8-32	2	1.07	100/500		NEW	
JSPMP21SS	98921	10-24	½	.53	100/500		FOR	NEW
JSPMP2SS	98902	10-24	¾	.69	100/500		TRADE	NEW
JSPMP7SS	98907	10-24	1	.83	100/500		LIST	NEW
JSPMP4SS	98904	10-24	1¼	.98	100/500	PRICING	NEW	
JSPMP5SS	98905	10-24	1½	1.01	100/500		NEW	
JSPMP33SS	98933	10-32	½	.36	100/500		NEW	
JSPMP3SS	98903	10-32	¾	.73	100/500		NEW	
JSPMP23SS	98923	10-32	¾	.77	100/500		NEW	
JSPMP35SS	98935	10-32	1	.86	100/500		NEW	
JSPMP38SS	98938	10-32	2½	1.90	100		NEW	
JSPMP29SS	98929	¼-20	¾	1.01	100/500		NEW	

OTHER SIZES AND QUANTITIES AVAILABLE BY REQUEST



BRASS ROUND HEAD SLOTTED MACHINE SCREWS

A

STOCK NO.	UPC NO.	DIAMETER	LENGTH	WT. PER PKG.	STD. PKG/ MSTR. SLEEVE	SUGGESTED TRADE LIST PRICE PER	
JRMB61	80104	6-32	1/2	.29	100/500		
JRMB62	80105	6-32	3/4	.37	100/500		
JRMB63	80106	6-32	1	.45	100/500		
JRMB64	83464	6-32	1 1/4	.51	100/500		NEW
JRMB66	83466	6-32	2	.73	100/500		NEW
JRMB140	83540	6-32	2 1/2	.89	100/500		NEW
JRMB8	83408	8-32	3/8	.34	100/500		NEW
JRMB83	80107	8-32	1/2	.43	100/500		
JRMB85	80108	8-32	3/4	.54	100/500		
JRMB86	80109	8-32	1	.61	100/500		
JRMB87	83487	8-32	1 1/4	.70	100/500	PLEASE	NEW
JRMB88	83488	8-32	1 1/2	.88	100/500	CALL	NEW
JRMB91	80110	8-32	2	1.16	100/500		
JRMB90	83490	8-32	2 1/2	1.29	100/500		NEW
JRMB78	83478	8-32	3	1.60	100/500	FOR	NEW
JRMB7	83407	10-24	3/8	.53	100/500		NEW
JRMB49	83449	10-24	1/2	.55	100/500	TRADE	NEW
JRMB92	83450	10-24	3/4	.73	100/500		NEW
JRMB93	83493	10-24	1	.84	100/500	LIST	NEW
JRMB94	83494	10-24	1 1/4	.99	100/500		NEW
JRMB95	80111	10-32	1/2	.57	100/500	PRICING	
JRMB48	80112	10-32	3/4	.73	100/500		NEW
JRMB73	83473	10-32	1 1/2	1.16	100/500		NEW
JRMB113	83537	10-32	2	1.46	100/500		NEW
JRMB105	83529	10-32	2 1/2	1.80	100/500		NEW
JRMB22	83422	1/4-20	3/8	.67	100/500		NEW
JRMB99	83499	1/4-20	1/2	1.03	100/500		NEW
JRMB100	83524	1/4-20	3/4	1.32	100/500		NEW
JRMB30	86268	1/4-20	1	1.63	100/500		NEW
JRMB102	83526	1/4-20	1 1/4	1.71	100/500		NEW
JRMB104	83528	1/4-20	2	2.57	100/500		NEW

OTHER SIZES AND QUANTITIES AVAILABLE BY REQUEST



FLAT HEAD SLOTTED MACHINE SCREWS

STEEL ZINC CHROMATE

STOCK NO.	UPC NO.	DIAMETER	LENGTH	WT. PER PKG.	STD. PKG/ MSTR. SLEEVE	SUGGESTED TRADE LIST PRICE PER	
JFM17	83817	6-32	3/8	.21	100/500	3.20/c	NEW
JFM80	80114	6-32	1/2	.24	100/500	2.70/c	
JFM81	80115	6-32	3/4	.30	100/500	2.95/c	
JFM63	80116	6-32	1	.39	100/500	2.98/c	
JFM68	80117	6-32	1 1/4	.46	100/500	3.38/c	
JFM82	80118	6-32	1 1/2	.53	100/500	4.58/c	
JFM83	80119	6-32	2	.62	100/500	5.45/c	
JFM140	80120	6-32	2 1/2	.82	100/500	8.33/c	
JFM142	80121	6-32	3	.97	100/500	9.60/c	
JFM144	81916	6-32	4	1.28	100/500	25.45/c	NEW

CONTINUED ON NEXT PAGE

SCREWS

CONTINUED

FLAT HEAD SLOTTED MACHINE SCREWS

STEEL ZINC CHROMATE



STOCK NO.	UPC NO.	DIAMETER	LENGTH	WT. PER PKG.	STD. PKG/ MSTR. SLEEVE	SUGGESTED TRADE LIST PRICE PER	
JFM18	83818	8-32	3/8	.27	100/500	3.38/c	NEW
JFM84	80122	8-32	1/2	.33	100/500	3.00/c	
JFM85	80123	8-32	3/4	.48	100/500	3.40/c	
JFM86	80124	8-32	1	.55	100/500	3.58/c	
JFM87	80125	8-32	1 1/4	.64	100/500	4.88/c	
JFM88	80126	8-32	1 1/2	.77	100/500	5.45/c	
JFM89	80127	8-32	2	1.00	100/500	6.38/c	
JFM90	80128	8-32	2 1/2	1.25	100/500	10.13/c	
JFM91	80129	8-32	3	1.46	100/500	13.45/c	
JFM117	83917	8-32	4	1.94	100	23.53/c	NEW
JFM19	83819	10-24	3/8	.47	100/500	4.05/c	NEW
JFM32	83832	10-24	1/2	.50	100/500	4.28/c	NEW
JFM194	76594	10-24	3/4	.58	100/500	4.98/c	NEW
JFM113	83913	10-24	1	.76	100/500	5.58/c	NEW
JFM95	83895	10-24	1 1/2	1.04	100/500	8.65/c	NEW
JFM96	83896	10-24	2	1.41	100/500	10.28/c	NEW
JFM127	83927	10-24	3	2.01	100	26.88/c	NEW
JFM150	84430	10-24	4	2.51	100	23.53/c	NEW
JFM20	83820	10-32	3/8	.38	100/500	4.55/c	NEW
JFM33	80130	10-32	1/2	.50	100/500	3.83/c	
JFM42	83842	10-32	5/8	.56	100/500	4.68/c	NEW
JFM48	80131	10-32	3/4	.73	100/500	4.03/c	
JFM98	80132	10-32	1	.76	100/500	4.23/c	
JFM69	80133	10-32	1 1/4	.96	100/500	5.55/c	
JFM92	81175	10-32	1 1/2	1.04	100/500	5.88/c	
JFM93	81176	10-32	2	1.41	100/500	7.40/c	
JFM94	81177	10-32	3	2.01	100/500	10.40/c	
JFM22	83822	1/4-20	3/8	.69	100/500	7.68/c	NEW
JFM99	80134	1/4-20	1/2	.89	100/500	6.38/c	
JFM100	80135	1/4-20	3/4	1.06	100/500	6.75/c	
JFM101	80136	1/4-20	1	1.30	100/500	7.78/c	
JFM102	83902	1/4-20	1 1/4	1.54	100/500	9.33/c	NEW
JFM103	81900	1/4-20	1 1/2	1.83	100/500	10.40/c	NEW
JFM104	80137	1/4-20	2	2.55	100/500	10.85/c	
JFM128	83928	1/4-20	2 1/2	3.61	100	13.38/c	NEW
JFM105	81185	1/4-20	3	3.38	100	14.60/c	
JFM132	84086	1/4-20	4	4.21	100	30.90/c	NEW
JFM35	83835	5/16-18	1/2	.95	100/500	20.68/c	NEW
JFM50	83850	5/16-18	3/4	1.26	100/500	23.53/c	NEW
JFM65	83865	5/16-18	1	1.60	100/500	23.75/c	NEW
JFM36	83836	3/8-16	1/2	2.70	100/500	30.05/c	NEW
JFM51	83851	3/8-16	3/4	2.90	100	31.90/c	NEW
JFM66	83866	3/8-16	1	3.79	100	39.95/c	NEW
JFM72	83872	3/8-16	1 1/4	3.78	100	40.00/c	NEW
JFM78	83878	3/8-16	1 1/2	3.83	100	45.75/c	NEW
JFM116	83916	3/8-16	2	3.95	100	46.00/c	NEW
JFM123	83923	3/8-16	2 1/2	4.26	100	62.25/c	NEW
JFM130	84084	3/8-16	3	6.25	100	72.98/c	NEW
JFM135	84089	3/8-16	4	11.02	100	95.43/c	NEW

OTHER SIZES AND QUANTITIES AVAILABLE BY REQUEST



FLAT HEAD PHILLIPS MACHINE SCREW **NEW!**

STEEL ZINC CHROMATE AND BRASS



STOCK NO.	UPC NO.	DIAMETER	LENGTH	WT. PER PKG.	STD. PKG/ MSTR. SLEEVE	SUGGESTED TRADE LIST PRICE PER	
JFMP80	84116	6-32	1/2	.23	100/500	4.88/c	NEW
JFMP81	84117	6-32	3/4	.33	100/500	4.93/c	NEW
JFMP63	84063	6-32	1	.39	100/500	4.95/c	NEW
JFMP82	84118	6-32	1 1/2	.54	100/500	11.25/c	NEW
JFMP83	84119	6-32	2	.69	100/500	7.50/c	NEW
JFMP140	85740	6-32	2 1/2	.83	100/500	13.33/c	NEW
JFMP142	85742	6-32	3	.74	100/500	16.80/c	NEW
JFMP84	84120	8-32	1/2	.33	100/500	3.30/c	NEW
JFMP85	84121	8-32	3/4	.44	100/500	4.70/c	NEW
JFMP86	84122	8-32	1	.55	100/500	4.75/c	NEW
JFMP87	84123	8-32	1 1/4	.64	100/500	7.38/c	NEW
JFMP88	84124	8-32	1 1/2	.74	100/500	7.43/c	NEW
JFMP89	84125	8-32	2	1.00	100/500	7.48/c	NEW
JFMP75	84075	10-24	3/4	.48	100/500	5.50/c	NEW
JFMP47	72047	10-32	3/8	.40	100/500	5.50/c	NEW
JFMP98	84134	10-32	1	.76	100/500	6.18/c	NEW
JFMP100	85700	1/4-20	3/4	1.12	100/500	7.25/c	NEW

BRASS

JFMB88	81155	8-32	1 1/2	0.84	100/500	PLEASE CALL FOR TRADE LIST PRICING	NEW
JFMB89	81156	8-32	2	1.05	100/500		

OTHER SIZES AND QUANTITIES AVAILABLE BY REQUEST



STAINLESS STEEL FLAT HEAD SLOTTED MACHINE SCREWS **NEW!**

18-8 SERIES TYPE

STOCK NO.	UPC NO.	DIAMETER	LENGTH	WT. PER PKG.	STD. PKG/ MSTR. SLEEVE	SUGGESTED TRADE LIST PRICE PER	
JFM82SS	91982	6-32	1 1/2	.50	100/500	PLEASE CALL FOR TRADE LIST PRICING	NEW
JFM83SS	91983	6-32	2	.60	100/500		NEW
JFM84SS	91984	8-32	1/2	.35	100/500		NEW
JFM85SS	91985	8-32	3/4	.45	100/500		NEW
JFM86SS	91986	8-32	1	.56	100/500		NEW
JFM87SS	91987	8-32	1 1/4	.67	100/500		NEW
JFM33SS	91933	10-32	1/2	.49	100/500		NEW
JFM48SS	91900	10-32	3/4	.71	100/500		NEW
JFM92SS	91992	10-32	1 1/2	1.08	100/500		NEW
JFM99SS	91999	1/4-20	1/2	.81	100/500		NEW
JFM100SS	92000	1/4-20	3/4	1.08	100/500	NEW	
JFM101SS	93201	1/4-20	1	1.32	100/500	NEW	
JFM102SS	93202	1/4-20	1 1/4	1.56	100/500	NEW	
JFM104SS	93204	1/4-20	2	1.38	100/500	NEW	

OTHER SIZES AND QUANTITIES AVAILABLE BY REQUEST

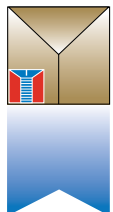

METALLICS

AMERICA'S SOURCE FOR PREMIER AND INNOVATIVE FASTENERS & ANCHORS

SCREWS

A



STAINLESS STEEL FLAT HEAD PHILLIPS MACHINE SCREWS

NEW!

18-8 SERIES TYPE

STOCK NO.	UPC NO.	DIAMETER	LENGTH	WT. PER PKG.	STD. PKG/MSTR. SLEEVE	SUGGESTED TRADE LIST PRICE PER	
JFMP80SS	91980	6-32	1/2	.27	100/500	PLEASE CALL FOR TRADE LIST PRICING	NEW
JFMP81SS	93481	6-32	3/4	.32	100/500		NEW
JFMP63SS	93463	6-32	1	.39	100/500		NEW
JFMP49SS	93949	10-32	1/2	.44	100/500		NEW
JFMP48SS	91948	10-32	3/4	.71	100/500		NEW
JFMP51SS	93951	10-32	1	.77	100/500		NEW
JFMP101SS	92280	1/4-20	1	1.31	100/500		NEW
JFMP103SS	98403	1/4-20	1 1/2	2.00	100/500		NEW

OTHER SIZES AND QUANTITIES AVAILABLE BY REQUEST



FLAT HEAD PHILLIPS DRIVE MACHINE SCREW KIT

NEW!

STEEL ZINC CHROMATE

STOCK NO.	UPC NO.	DESCRIPTION OF CONTENTS	STD. PKG. MSTR. CARTON	WT. EACH	SUGGESTED TRADE LIST PRICE PER KIT
FMKP632	10356	6-32 Flat Head Phillips Drive MS 100 - 3/4", 75 - 1", 75 - 1 1/4", 50 - 1 1/2", 40 - 2", 30 - 3"		1.84	19.18/ea



Two drives in one head!



STOVE BOLTS

Standard Package Square Plastic Jar
Round Head "Combo" (Slotted and Phillips)
STEEL ZINC CHROMATE WITH HEX NUTS

STOCK NO.	UPC NO.	DIAMETER	LENGTH	WT. PER PKG	STD. PKG/MSTR. SLEEVE	SUGGESTED TRADE LIST PRICE PER	
RSB63	10488	6-32	1	.88	100/500	6.90/c	NEW
RSB86	10491	8-32	1	.99	100/500	7.58/c	NEW
RSB89	10492	8-32	2	1.30	100/500	11.70/c	NEW
RSB90	10493	8-32	2 1/2	1.56	100/500	13.95/c	NEW
RSB91	84291	8-32	3	1.83	100/500	15.90/c	NEW
RSB94	10173	8-32	4	2.23	100/500	17.85/c	NEW
RSB92	10466	10-24	3/4	.97	100/500	8.53/c	NEW
RSB93	10158	10-24	1	1.14	100/500	9.85/c	NEW
RSB95	10467	10-24	1 1/2	1.31	100/500	12.18/c	NEW
RSB16	10340	10-32	1/2	.86	100/500	4.93/c	
RSB17	10341	10-32	3/4	.98	100/500	5.43/c	
RSB18	10342	10-32	1	1.13	100/500	5.85/c	
RSB19	10343	10-32	1 1/4	1.28	100/500	6.25/c	
RSB20	10344	10-32	1 1/2	1.42	100/500	6.90/c	
RSB21	10345	10-32	2	1.72	100	8.05/c	
RSB22	10159	1/4-20	3/8	1.58	100/500	5.98/c	
RSB99	10160	1/4-20	1/2	1.67	100/500	6.28/c	
RSB100	10161	1/4-20	3/4	1.96	100/500	7.20/c	
RSB101	10162	1/4-20	1	2.22	100/500	7.73/c	
RSB102	10163	1/4-20	1 1/4	2.42	100/500	8.65/c	
RSB103	10164	1/4-20	1 1/2	2.68	100	9.73/c	
RSB104	10165	1/4-20	2	3.22	100	11.63/c	
RSB105	13037	1/4-20	2 1/2	3.98	100	13.65/c	
RSB106	13045	1/4-20	3	4.30	100	17.60/c	

CONTINUED ON NEXT PAGE

CONTINUED

STOVE BOLTS

Standard Package Square Plastic Jar
Round Head "Combo" (Slotted and Phillips)
Machine Screws with Hex Nuts

STEEL ZINC CHROMATE

-  Slotted
 -  Phillips
- Two drives
in one head!



A

STOCK NO.	UPC NO.	DIAMETER	LENGTH	WT. PER PKG	STD. PKG/ MSTR. SLEEVE	SUGGESTED TRADE LIST PRICE PER	
RSB66	10157	3/8-16	1	5.67	100	32.23/c	NEW
RSB72	10489	3/8-16	1 1/4	6.64	100	36.20/c	NEW
RSB78	10490	3/8-16	1 1/2	7.68	100	38.83/c	NEW
RSB116	13038	3/8-16	2	9.60	100	44.48/c	NEW

OTHER SIZES AND QUANTITIES AVAILABLE BY REQUEST

NEW!



STAINLESS STEEL STOVE BOLTS

18-8 SERIES TYPE

-  Slotted



STOCK NO.	UPC NO.	DIAMETER	LENGTH	WT. PER PKG	STD. PKG/ MSTR. SLEEVE	SUGGESTED TRADE LIST PRICE PER	
RSB100S	98800	1/4-20	3/4	2.07	100/500	PLEASE CALL FOR TRADE LIST PRICING	NEW
RSB101S	98801	1/4-20	1	2.37	100/500		NEW
RSB103S	98803	1/4-20	1 1/2	2.79	100		NEW
RSB104S	98804	1/4-20	2	3.31	100		NEW

-  Slotted
-  Phillips
-  Square Drive



PAN HEAD TRI-DRIVE SHEET METAL SCREWS

STEEL ZINC CHROMATE



Tri-Drive is
manufactured by
Avanti Screw, Inc.,
A Metallics
Affiliate

Three drives
in one head!

Introduced nationally in 1994 by Metallics

STOCK NO.	UPC NO.	DIAMETER	LENGTH	WT. PER PKG.	STD. PKG. MSTR. SLEEVE	SUGGESTED TRADE LIST PRICE PER	
JTTS12	80138	6	1/2	.29	100/500	4.78/c	
JTTS14	80139	6	3/4	.36	100/500	4.90/c	
JTTS15	80140	6	1	.42	100/500	4.90/c	
JTTS38	80141	6	1 1/2	.58	100/500	6.43/c	
JTTS18	80142	8	1/2	.37	100/500	5.00/c	
JTTS20	80143	8	3/4	.48	100/500	5.53/c	
JTTS21	80144	8	1	.58	100/500	5.98/c	
JTTS22	80145	8	1 1/4	.64	100/500	6.68/c	
JTTS23	80146	8	1 1/2	.75	100/500	7.00/c	
JTTS24	80147	8	2	.97	100/500	11.98/c	
JTTS25	80148	10	1/2	.50	100/500	5.40/c	
JTTS27	80149	10	3/4	.64	100/500	5.70/c	
JTTS28	80150	10	1	.75	100/500	5.98/c	
JTTS29	80151	10	1 1/4	.88	100/500	6.23/c	
JTTS30	80152	10	1 1/2	1.01	100/500	7.00/c	
JTTS31	80153	10	2	1.26	100/500	11.23/c	
JTTS33	80154	12	3/4	.82	100/500	7.20/c	
JTTS34	80155	12	1	.98	100/500	8.48/c	
JTTS35	80156	12	1 1/4	1.23	100/500	9.90/c	
JTTS36	80157	12	1 1/2	1.32	100/500	11.08/c	
JTTS37	80158	12	2	1.68	100	14.98/c	

SCREWS

 Slotted
 Phillips
 Two drives
 in one head!



"COMBO" TAPPING SCREWS

Pan Head (Slotted and Phillips)
 STEEL ZINC CHROMATE

STOCK NO.	UPC NO.	DIAMETER	LENGTH	WT. PER PKG.	STD. PKG/MSTR. SLEEVE	SUGGESTED TRADE LIST PRICE PER	
JTS1	82553	4	1/4	.14	100/500	2.65/c	NEW
JTS2	82554	4	3/8	.17	100/500	2.85/c	NEW
JTS10	80159	4	1/2	.20	100/500	3.23/c	
JTS4	80160	4	3/4	.23	100/500	3.75/c	
JTS11	80161	4	1	.28	100/500	3.98/c	
JTS6	80162	6	1/4	.19	100/500	2.75/c	
JTS7	80163	6	3/8	.23	100/500	2.78/c	
JTS12	80164	6	1/2	.26	100/500	3.20/c	
JTS13	80165	6	5/8	.28	100/500	3.28/c	
JTS14	80166	6	3/4	.33	100/500	3.45/c	
JTS15	80167	6	1	.39	100/500	3.20/c	
JTS9	80168	6	1 1/4	.47	100/500	3.55/c	
JTS38	80169	6	1 1/2	.53	100/500	4.50/c	
JTS39	82558	6	2	.66	100/500	6.05/c	NEW
JTS40	80170	7	1/2	.31	100/500	3.98/c	
JTS42	82570	7	3/4	.44	100/500	4.05/c	NEW
JTS44	82572	7	1	.52	100/500	4.28/c	NEW
JTS17	80171	8	3/8	.32	100/500	2.90/c	
JTS18	80172	8	1/2	.39	100/500	3.33/c	
JTS19	80173	8	5/8	.41	100/500	3.53/c	
JTS20	80174	8	3/4	.46	100/500	3.85/c	
JTS21	80175	8	1	.56	100/500	4.28/c	
JTS22	80176	8	1 1/4	.66	100/500	4.63/c	
JTS23	80177	8	1 1/2	.73	100/500	5.03/c	
JTS48	80178	8	1 3/4	.86	100/500	7.70/c	
JTS24	80179	8	2	.96	100/500	7.75/c	
JTS49	80180	10	3/8	.44	100/500	3.28/c	
JTS25	80181	10	1/2	.45	100/500	3.55/c	
JTS26	80182	10	5/8	.57	100/500	3.98/c	
JTS27	80183	10	3/4	.63	100/500	4.70/c	
JTS28	80184	10	1	.75	100/500	5.55/c	
JTS29	80185	10	1 1/4	.86	100/500	5.70/c	
JTS30	80186	10	1 1/2	.94	100/500	7.55/c	
JTS51	80187	10	1 3/4	1.14	100/500	7.68/c	
JTS31	80188	10	2	1.18	100/500	10.93/c	
JTS80	80189	10	2 1/2	1.54	100	13.18/c	
JTS81	80190	10	3	1.82	100	14.28/c	
JTS32	80191	12	1/2	.65	100/500	5.40/c	
JTS52	82577	12	5/8	.74	100/500	10.75/c	NEW
JTS33	80192	12	3/4	.79	100/500	5.70/c	
JTS34	80193	12	1	1.00	100/500	6.43/c	
JTS35	80194	12	1 1/4	1.15	100/500	7.48/c	
JTS36	80195	12	1 1/2	1.33	100/500	8.68/c	
JTS54	80196	12	1 3/4	1.53	100/500	11.05/c	

CONTINUED ON NEXT PAGE

Metallics was the first in America to offer the Combo Head — 1985

CONTINUED

"COMBO" TAPPING SCREWS

Pan Head (Slotted and Phillips)
STEEL ZINC CHROMATE

 Slotted
 Phillips
 Two drives
 in one head!



STOCK NO.	UPC NO.	DIAMETER	LENGTH	WT. PER PKG.	STD. PKG/ MSTR. SLEEVE	SUGGESTED TRADE LIST PRICE PER
JTS37	80197	12	2	1.60	100	12.38/c
JTS82	80198	12	2 1/2	2.06	100	18.60/c
JTS83	80199	12	3	2.37	100	23.33/c
JTS55	80200	14	1/2	.93	100/500	8.40/c
JTS57	80201	14	3/4	1.13	100/500	9.30/c
JTS59	80202	14	1	1.44	100/500	10.08/c
JTS60	80203	14	1 1/4	1.55	100/500	13.13/c
JTS61	80204	14	1 1/2	1.84	100/500	14.93/c
JTS63	80205	14	2	2.34	100	15.50/c

OTHER SIZES AND QUANTITIES AVAILABLE BY REQUEST

 Phillips



FLAT HEAD PHILLIPS TAPPING SCREWS

STEEL ZINC CHROMATE

STOCK NO.	UPC NO.	DIAMETER	LENGTH	WT. PER PKG.	STD PKG/ MSTR. SLEEVE	SUGGESTED TRADE LIST PRICE PER
JTSF10	81861	4	1/2	.15	100/500	4.10/c NEW
JTSF101	81995	4	3/4	.20	100/500	5.35/c NEW
JTSF11	81862	4	1	.25	100/500	7.01/c NEW
JTSF12	80225	6	1/2	.23	100/500	3.20/c
JTSF14	80226	6	3/4	.30	100/500	3.45/c
JTSF15	80227	6	1	.35	100/500	3.50/c
JTSF9	80228	6	1 1/4	.40	100/500	3.55/c
JTSF38	83036	6	1 1/2	.49	100/500	14.15/c NEW
JTSF16	81863	6	2	.63	100/500	32.58/c NEW
JTSF18	81865	8	1/2	.26	100/500	5.18/c NEW
JTSF20	80229	8	3/4	.36	100/500	3.85/c
JTSF21	80230	8	1	.46	100/500	4.25/c
JTSF22	80231	8	1 1/4	.59	100/500	4.63/c
JTSF23	80232	8	1 1/2	.67	100/500	5.03/c
JTSF24	83027	8	2	.86	100/500	5.73/c NEW
JTSF25	83028	10	1/2	.35	100/500	4.65/c NEW
JTSF27	80233	10	3/4	.52	100/500	4.70/c
JTSF28	80234	10	1	.61	100/500	5.55/c
JTSF29	80235	10	1 1/4	.75	100/500	6.05/c
JTSF30	80236	10	1 1/2	.85	100/500	7.55/c
JTSF31	81866	10	2	1.15	100/500	10.90/c NEW
JTSF32	83030	12	1/2	.49	100/500	14.70/c NEW
JTSF33	83031	12	3/4	.68	100/500	11.81/c NEW
JTSF34	83032	12	1	.85	100/500	13.38/c NEW
JTSF35	83033	12	1 1/4	.95	100/500	23.44/c NEW
JTSF36	83034	12	1 1/2	.92	100/500	23.50/c NEW
JTSF37	83035	12	2	1.40	100	37.69/c NEW

OTHER SIZES AND QUANTITIES AVAILABLE BY REQUEST

SCREWS

A



STAINLESS STEEL PAN HEAD SLOTTED TAPPING SCREWS

18-8 SERIES TYPE

STOCK NO.	UPC NO.	DIAMETER	LENGTH	WT. PER PKG.	STD. PKG/ MSTR. SLEEVE	SUGGESTED TRADE LIST PRICE PER
JSTS10	80206	6	1/2	.25	100/500	7.98/c
JSTS11	80207	6	3/4	.32	100/500	9.98/c
JSTS12	80208	6	1	.33	100/500	11.25/c
JSTS13	80209	8	1/2	.34	100/500	10.83/c
JSTS14	80210	8	3/4	.47	100/500	17.08/c
JSTS15	80211	8	1	.54	100/500	24.20/c
JSTS16	80212	8	1 1/4	.63	100/500	16.45/c
JSTS17	80213	8	1 1/2	.74	100/500	18.20/c
JSTS18	80214	8	2	.92	100/500	29.45/c
JSTS19	80215	10	1/2	.48	100/500	16.05/c
JSTS20	80216	10	5/8	.52	100/500	18.15/c
JSTS21	80217	10	3/4	.60	100/500	20.20/c
JSTS22	80218	10	1	.70	100/500	21.05/c
JSTS23	80219	10	1 1/4	.87	100/500	26.85/c
JSTS24	80220	10	1 1/2	.98	100/500	27.03/c
JSTS25	80221	10	2	1.23	100/500	32.90/c
JSTS26	80222	12	1/2	.66	100/500	18.88/c
JSTS27	80223	12	3/4	.88	100/500	27.48/c
JSTS28	80224	12	1	.94	100/500	26.85/c

OTHER SIZES AND QUANTITIES AVAILABLE BY REQUEST



STAINLESS STEEL PAN HEAD PHILLIPS TAPPING SCREWS

NEW!

18-8 SERIES TYPE

STOCK NO.	UPC NO.	DIAMETER	LENGTH	WT. PER PKG.	STD. PKG/ MSTR. SLEEVE	SUGGESTED TRADE LIST PRICE PER
JSTSP39	84039	6	3/8	.25	100/500	NEW
JSTSP10	84010	6	1/2	.27	100/500	NEW
JSTSP11	84011	6	3/4	.29	100/500	NEW
JSTSP12	84012	6	1	.33	100/500	NEW
JSTSP125	84427	6	1 1/2	.58	100/500	NEW
JSTSP37	84037	8	3/8	.33	100/500	NEW
JSTSP13	84013	8	1/2	.34	100/500	NEW
JSTSP14	84014	8	3/4	.47	100/500	NEW
JSTSP15	84015	8	1	.58	100/500	PLEASE NEW
JSTSP16	84016	8	1 1/4	.67	100/500	CALL NEW
JSTSP17	84017	8	1 1/2	.76	100/500	FOR NEW
JSTSP18	84018	8	2	.98	100/500	NEW
JSTSP19	84019	10	1/2	.67	100/500	NEW
JSTSP20	84020	10	3/8	.68	100/500	NEW
JSTSP21	84021	10	3/4	.75	100/500	NEW
JSTSP22	84022	10	1	.87	100/500	TRADE NEW
JSTSP23	84023	10	1 1/4	1.22	100/500	NEW
JSTSP24	84024	10	1 1/2	1.03	100/500	LIST NEW
JSTSP25	84025	10	2	1.46	100/500	NEW
JSTSP29	84029	10	3	1.81	100	PRICING NEW
JSTSP26	84026	12	1/2	.66	100/500	NEW
JSTSP27	84027	12	3/4	.88	100/500	NEW
JSTSP28	84028	12	1	.94	100/500	NEW
JSTSP33	84033	12	1 1/4	1.22	100/500	NEW
JSTSP32	84032	12	1 1/2	1.38	100/500	NEW
JSTSP34	84034	12	2	1.65	100	NEW
JSTSP35	84035	12	3	2.40	100	NEW
JSTSP30	84030	14	3/4	1.15	100/500	NEW

OTHER SIZES AND QUANTITIES AVAILABLE BY REQUEST



PAN HEAD SQUARE DRIVE TAPPING SCREWS



SQUARE DRIVE RECESS. STEEL ZINC CHROMATE

A strong, positive drive fastener that locks onto the square drive bit.
Ideal for Distributors and Users in the Canadian Market.

STOCK NO.	UPC NO.	DIAMETER	LENGTH	WT. PER PKG.	STD. PKG/ MSTR. SLEEVE	SUGGESTED TRADE LIST PRICE PER	
JTSS1	80237	6	1/2	.26	100/500	4.08/c	
JTSS2	80238	6	3/4	.35	100/500	4.20/c	
JTSS3	80239	6	1	.40	100/500	5.38/c	
JTSS4	80240	6	1 1/4	.43	100/500	6.43/c	
JTSS5	80241	6	1 1/2	.54	100/500	7.40/c	
JTSS6	80242	6	2	.66	100/500	13.35/c	
JTSS7	80243	8	1/2	.38	100/500	4.35/c	
JTSS8	80244	8	3/4	.49	100/500	4.55/c	
JTSS9	80245	8	1	.59	100/500	5.58/c	
JTSS10	80246	8	1 1/4	.66	100/500	7.58/c	
JTSS11	80247	8	1 1/2	.77	100/500	8.58/c	
JTSS12	80248	8	2	.92	100/500	10.00/c	
JTSS25	80249	10	1/2	.49	100/500	5.55/c	
JTSS27	80250	10	3/4	.62	100/500	6.15/c	
JTSS28	80251	10	1	.76	100/500	6.90/c	
JTSS29	80252	10	1 1/4	.90	100/500	8.55/c	
JTSS30	80253	10	1 1/2	1.02	100/500	9.23/c	
JTSS31	80254	10	2	1.29	100/500	11.50/c	
JTSS32	80255	10	2 1/2	1.58	100	16.13/c	
JTSS81	80256	10	3	1.73	100	21.53/c	
JTSS33	80257	12	3/4	.88	100/500	9.68/c	
JTSS34	80258	12	1	1.04	100/500	10.65/c	
JTSS35	80259	12	1 1/4	1.28	100/500	11.53/c	
JTSS36	80260	12	1 1/2	1.38	100/500	13.38/c	
JTSS37	80261	12	2	1.75	100	16.45/c	
JTSS83	80262	12	3	2.44	100	21.53/c	

OTHER SIZES AND QUANTITIES AVAILABLE BY REQUEST



STAINLESS STEEL PAN HEAD SQUARE DRIVE TAPPING SCREWS



NEW!

18-8 SERIES TYPE

STOCK NO.	UPC NO.	DIAMETER	LENGTH	WT. PER PKG.	STD. PKG/ MSTR. SLEEVE	SUGGESTED TRADE LIST PRICE PER	
JTSS7SS	96407	8	1/2	.39	100/500	PLEASE CALL FOR TRADE LIST PRICING	NEW
JTSS8SS	96408	8	3/4	.51	100/500		NEW
JTSS9SS	96409	8	1	.60	100/500		NEW
JTSS10SS	96410	8	1 1/4	.68	100/500		NEW
JTSS11SS	96411	8	1 1/2	.79	100/500		NEW
JTSS25SS	96425	10	1/2	.52	100/500		NEW
JTSS27SS	96427	10	3/4	.60	100/500		NEW
JTSS28SS	96428	10	1	.99	100/500		NEW
JTSS29SS	96429	10	1 1/4	.87	100/500		NEW
JTSS30SS	96430	10	1 1/2	.94	100/500		NEW
JTSS31SS	96431	10	2	1.25	100/500	NEW	

OTHER SIZES AND QUANTITIES AVAILABLE BY REQUEST

SCREWS

-  Phillips
 -  Square Drive
- Two drives in one head!



ROUND WASHER HEAD TAPPING SCREWS

SQUARE-PHILLIPS RECESS. STEEL ZINC CHROMATE



STOCK NO.	UPC NO.	DIAMETER	LENGTH	WT. PER PKG.	STD. PKG/MSTR. SLEEVE	SUGGESTED TRADE LIST PRICE PER
JRWS7	80263	8	1/2	.41	100/500	5.53/c
JRWS8	80264	8	3/4	.52	100/500	5.53/c
JRWS9	80265	8	1	.59	100/500	5.98/c
JRWS10	80266	8	1 1/4	.69	100/500	6.68/c
JRWS11	80267	8	1 1/2	.83	100/500	7.00/c
JRWS12	80268	8	2	1.00	100/500	11.98/c
JRWS26	80269	10	1/2	.55	100/500	5.95/c
JRWS27	80270	10	3/4	.68	100/500	6.10/c
JRWS28	80271	10	1	.81	100/500	6.93/c
JRWS29	80272	10	1 1/4	.89	100/500	12.70/c
JRWS30	80273	10	1 1/2	1.10	100/500	13.13/c
JRWS31	80274	10	2	1.30	100/500	17.50/c

OTHER SIZES AND QUANTITIES AVAILABLE BY REQUEST

-  Hex
-  Slotted



HEX HEAD SHEET METAL SCREWS

Indented Hex Washer Slotted Head
STEEL ZINC CHROMATE, SELF-PIERCING
The ideal fastener for light gauge sheet metal*

STOCK NO.	UPC NO.	DIAMETER	LENGTH	WT. PER PKG.	STD. PKG/MSTR. SLEEVE	SUGGESTED TRADE LIST PRICE PER
1/4" HEAD—USE MT208B CHUCK, SEE PAGE 185						
JDS150	80275	6	3/8	.27	100/500	3.65/c
JDS161	80276	6	1/2	.30	100/500	3.70/c
JDS160	80277	6	3/4	.37	100/500	3.85/c
JDS163	80278	6	1	.43	100/500	4.60/c
JDS164	80279	6	1 1/4	.51	100/500	5.53/c
JDS165	80280	6	1 1/2	.62	100/500	6.35/c
JDS151	80281	7	1/2	.33	100/500	4.08/c
JDS166	80282	7	3/4	.43	100/500	4.28/c
JDS152	80283	8	1/2	.37	100/500	4.28/c
JDS153	80284	8	3/4	.45	100/500	4.78/c
JDS154	80285	8	1	.53	100/500	5.13/c
JDS162	80286	8	1 1/4	.68	100/500	6.53/c
JDS157	80287	8	1 1/2	.75	100/500	7.28/c
JDS159	80288	8	2	1.00	100/500	9.33/c
JDS84	81708	8	2 1/2	1.16	100/500	14.78/c NEW
JDS155	80289	10	1/2	.37	100/500	4.65/c
JDS156	80290	10	3/4	.51	100/500	5.45/c
JDS158	80291	10	1	.61	100/500	6.28/c
JDS168	80293	10	1 1/2	.88	100/500	9.33/c
JDS169	80294	10	2	1.12	100/500	12.40/c
5/16" HEAD—USE MT210B CHUCK, SEE PAGE 185						
JDS180	80295	10	1/2	.55	100/500	4.98/c
JDS181	80296	10	3/4	.63	100/500	5.45/c
JDS182	80297	10	1	.75	100/500	6.28/c
JDS183	80298	10	1 1/4	.88	100/500	7.55/c
JDS184	80299	10	1 1/2	1.00	100/500	8.75/c
JDS185	80300	10	2	1.25	100	12.60/c
JDS80	80301	10	2 1/2	1.53	100	14.70/c
JDS81	80302	10	3	1.81	100	16.90/c

CONTINUED ON NEXT PAGE

CONTINUED

HEX HEAD SHEET METAL SCREWS



Indented Hex Washer Slotted Head
STEEL ZINC CHROMATE, SELF-PIERCING
The ideal fastener for light gauge sheet metal*



STOCK NO.	UPC NO.	DIAMETER	LENGTH	WT. PER PKG.	STD. PKG/ MSTR. SLEEVE	SUGGESTED TRADE LIST PRICE PER
5/16" HEAD—USE MT210B CHUCK, SEE PAGE 185						
JDS170	80303	12	3/4	.79	100/500	8.48/c
JDS171	80304	12	1	1.00	100/500	8.75/c
JDS172	80305	12	1 1/4	1.17	100/500	9.83/c
JDS173	80306	12	1 1/2	1.32	100/500	11.33/c
JDS174	80307	12	2	1.63	100	13.03/c
3/8" HEAD—USE MT212B CHUCK, SEE PAGE 185						
JDS85	81709	14	1/2	.94	100/500	16.60/c NEW
JDS175	80308	14	3/4	.97	100/500	12.95/c
JDS176	80309	14	1	1.53	100/500	13.65/c
JDS177	80310	14	1 1/4	1.70	100	15.53/c
JDS178	80311	14	1 1/2	2.01	100	15.83/c
JDS179	80312	14	2	2.45	100	22.55/c
JDS187	81768	14	2 1/2	2.91	100	32.25/c NEW
JDS143	80313	14	3	3.38	100	25.88/c

OTHER SIZES AND QUANTITIES AVAILABLE BY REQUEST

*Used in light metal assembly such as electrical outlets, framing and various other sheet metal applications.



STAINLESS STEEL **NEW!** SHEET METAL SCREWS INDENTED HEX WASHER 18-8 SERIES TYPE

STOCK NO.	UPC NO.	DIAMETER	LENGTH	WT. PER PKG.	STD. PKG/ MSTR. SLEEVE	SUGGESTED TRADE LIST PRICE PER	
1/4" HEAD—USE MT208B CHUCK, SEE PAGE 185							
JDS162SS	92762	8	1 1/4	.69	100/500	PLEASE CALL FOR TRADE LIST PRICING	
5/16" HEAD—USE MT210B CHUCK, SEE PAGE 185							
JDS182SS	92782	10	1	.80	100/500		NEW
JDS183SS	92783	10	1 1/4	.87	100/500		NEW
JDS184SS	81764	10	1 1/2	1.02	100/500		NEW
JDS185SS	81765	10	2	1.33	100		NEW
JDS186SS	92786	12	1/2	.75	100/500		NEW
JDS170SS	92770	12	3/4	.89	100/500		NEW
JDS187SS	92787	14	1	1.63	100/500		NEW
JDS177SS	92777	14	1 1/4	1.81	100		NEW

OTHER SIZES AND QUANTITIES AVAILABLE BY REQUEST

EASTERN



8:00 A.M. to 5:00 P.M.

Metallics, Inc. CT

CENTRAL



8:00 A.M. to 5:00 P.M.

Metallics, West Inc. CO

MOUNTAIN



8:00 A.M. to 5:00 P.M.

Metallics, West Inc. CO

In the event Metallics East, Bristol is CLOSED, call Metallics West at 1-800-269-5183 if you require technical information or overnight shipments

SCREWS

Four drives in one head

-  Hex
-  Slotted
-  Phillips
-  Square Drive



Introduced in 1999

QUADRIE SHEET METAL SELF-PIERCING SCREWS

Indented Hex Washer, Slotted, Phillips, Square Recess Head

STEEL ZINC CHROMATE



FIRST IN THE WORLD

THE IDEAL FASTENER FOR LIGHT GAUGE SHEET METAL

MADE IN USA



Manufactured by
Avanti Screw, Inc.,
A Metallics
Affiliate

STOCK NO.	UPC NO.	DIAMETER	LENGTH	WT. PER PKG.	STD. PKG.	SUGGESTED TRADE LIST PRICE PER
		1/4" HEAD				USE MT208B CHUCK, SEE PAGE 185
QDS152	39100	8	1/2	.39	100/500	7.53/c
QDS153	39101	8	3/4	.48	100/500	8.05/c
QDS154	39102	8	1	.59	100/500	8.63/c
QDS156	39103	10	3/4	.55	100/500	8.35/c
QDS158	39104	10	1	.66	100/500	9.15/c
		5/16" HEAD				USE MT210B CHUCK, SEE PAGE 185
QDS181	39106	10	3/4	.66	100/500	8.63/c
QDS182	39107	10	1	.82	100/500	9.50/c
QDS183	39108	10	1 1/4	.95	100/500	9.83/c
QDS184	39109	10	1 1/2	1.09	100/500	10.48/c
QDS185	39110	10	2	1.36	100	12.13/c
QDS80	39111	10	2 1/2	1.62	100	14.83/c
QDS171	39112	12	1	.97	100/500	11.60/c
QDS172	39113	12	1 1/4	1.12	100/500	12.28/c
QDS174	39114	12	2	1.71	100	15.30/c

OTHER SIZES AND QUANTITIES AVAILABLE BY REQUEST

AMERICA'S SOURCE FOR PREMIER AND INNOVATIVE FASTENERS & ANCHORS



A Modern Up to Date Roll Threading Machine at our Affiliate, Avanti Screw.

MADE IN USA



Metallics and Avanti Screw, Inc., prime American manufacturers of fastener products, have always worked to present the latest in fastener technology to our distributors and their contractors/users.

Hex Washer Head fasteners have historically only offered three drives- the hex, phillips and the slot. In 1999, we introduced "The QuaDrive" square, hex, slotted and Phillips, in fourteen of the most popular sizes of sheet metal screws.

The QuaDrive



America's Newest Drive - Designed, Developed and Manufactured by Metallics/Avanti Screw

These sheet metal screws are being manufactured to fill the need of the growing demand in the North American markets.

Please note: We recommend driving these sheet metal screws with the above special hex driving tool. The slotted, Phillips, hex and square drives make it convenient for disassembly.



Metallics



Quik-Eze

Self Piercing Sheet Metal Screw Kit

- 4 Popular Sheet Metal Screw Sizes – 500 pieces total
- High Performance - Hex Slotted Sharp Point
- Double lead thread means twice the driving speed!
- Convenient, Reusable Container
- Plumbing, HVAC & Electrical Contractor

[CONTRACTOR APPROVED]

PART #	UPC #	DESCRIPTION	QTY / PKG	SUG. TRADE LIST / PKG
QKK1	39291	8 x 1/2" Quik-Eze Hex Slotted	200 pcs.	\$ 24.75
		8 x 3/4" Quik-Eze Hex Slotted	150 pcs.	
		8 x 1" Quik-Eze Hex Slotted	100 pcs.	
		8 x 1-1/2" Quik-Eze Hex Slotted	50 pcs.	

★ ★ ★ ★ ★ *"Growth Through Innovation"* ★ ★ ★ ★ ★

Metallics

229 Cross Street, Bristol, CT 06010
Tel 800-243-8272 • **Fax** 800-831-9358
Email sales@metallicsonline.com

Metallics West

651 North Main Street, Mancos, CO 81328
Tel 800-269-5183 • **Fax** 800-269-6278
Email saleswest@metallicsonline.com

www.metallicsonline.com

SCREWS



QUIK-EZE SHEET METAL SCREWS

High Performance Self-Piercing Screw
Indented Hex Washer Slotted Head
STEEL ZINC CHROMATE

A Double Lead Thread means
twice the driving speed!

STOCK NO.	UPC NO.	DIAMETER	LENGTH	WT. PER PKG.	STD. PKG/ MSTR. SLEEVE	SUGGESTED TRADE LIST PRICE PER
1/4" HEAD—USE MT208B CHUCK, SEE PAGE 185						
JQK1	80314	7	1/2	.32	100/500	4.28/c
JQK5	80315	8	1/2	.35	100/500	3.20/c
JQK10	80316	8	3/4	.43	100/500	3.53/c
JQK15	80317	8	1	.54	100/500	3.78/c
JQK17	80318	8	1 1/2	.71	100/500	5.43/c
JQK19	80319	8	2	.88	100/500	8.35/c
JQK20	80320	10	1/2	.53	100/500	3.83/c
JQK25	80321	10	3/4	.51	100/500	4.35/c
JQK30	80322	10	1	.61	100/500	4.73/c
5/16" HEAD—USE MT208B CHUCK, SEE PAGE 185						
JQK59	75859	10	1	.71	100/500	7.75/c NEW
JQK12114	85983	12	1 1/4	1.11	100/500	14.03/c NEW

1000 PACKS

SUGGESTED
TRADE LIST PRICE PER

1/4" HEAD—USE MT208B CHUCK, SEE PAGE 185						
QK1M	10660	7	1/2	2.76	1000	39.68/m
QK5M	10661	8	1/2	3.02	1000	29.70/m
QK10M	10662	8	3/4	3.86	1000	32.78/m
QK15M	10663	8	1	4.95	1000	35.25/m
QK17M	10664	8	1 1/2	6.59	1000	50.53/m
QK19M	10665	8	2	8.45	1000	77.78/m
QK20M	10666	10	1/2	3.53	1000	35.60/m
QK25M	10667	10	3/4	4.85	1000	40.58/m
QK30M	10668	10	1	7.10	1000	44.03/m

OTHER SIZES AND QUANTITIES AVAILABLE BY REQUEST



SELF-DRILLING & TAPPING SCREWS

Square Drive Recess Pan Head
STEEL ZINC CHROMATE

A strong, positive drive fastener that locks onto the square drive bit—used in difficult-to-apply areas.
See page 185. **SQUARE DRIVE INSERT BITS** for proper driver.

STOCK NO.	UPC NO.	DIAMETER	LENGTH	WT. PER PKG.	STD. PKG/ MSTR. SLEEVE	SUGGESTED TRADE LIST PRICE PER
JTEKS1	80323	8	1/2	.36	100/500	6.98/c
JTEKS3	80324	8	5/8	.43	100/500	7.40/c
JTEKS2	80325	8	3/4	.48	100/500	8.33/c
JTEKS14	80326	8	1	.57	100/500	9.28/c
JTEKS5	80327	10	1/2	.51	100/500	11.00/c
JTEKS8	80328	10	5/8	.57	100/500	13.45/c
JTEKS6	80329	10	3/4	.66	100/500	11.70/c
JTEKS7	80330	10	1	.75	100/500	12.78/c
JTEKS15	80331	10	1 1/4	.85	100/500	14.13/c
JTEKS19	80332	10	1 1/2	1.00	100/500	16.13/c

OTHER SIZES AND QUANTITIES AVAILABLE BY REQUEST



SELF-DRILLING & TAPPING SCREWS PHILLIPS PAN HEAD

STEEL ZINC CHROMATE

STOCK NO.	UPC NO.	DIAMETER	LENGTH	WT. PER PKG.	STD. PKG/ MSTR. SLEEVE	SUGGESTED TRADE LIST PRICE PER
6 HAS A #2 Drill Point 1/4" HEAD—USE MT208B CHUCK, SEE PAGE 185						
JTEK10P	80333	6	1/2	.25	100/500	6.70/c
JTEK11P	80334	6	3/4	.32	100/500	7.55/c
JTEK12P	80335	6	1	.39	100/500	8.05/c
8 HAS A #2 Drill Point 1/4" HEAD—USE MT208B CHUCK, SEE PAGE 185						
JTEK1P	80336	8	1/2	.30	100/500	7.03/c
JTEK2P	80337	8	3/4	.47	100/500	7.55/c
JTEK16P	90080	8	5/8	.41	100/500	12.18/c NEW
JTEK14P	80338	8	1	.55	100/500	8.35/c
JTEK15P	80339	8	1 1/2	.74	100/500	11.05/c
10 HAS A #2 Drill Point 1/4" HEAD—USE MT208B CHUCK, SEE PAGE 185						
JTEK4P	80340	10	1/2	.51	100/500	9.73/c
JTEK3P	80341	10	3/4	.61	100/500	10.93/c
JTEK7P	80342	10	1	.75	100/500	11.75/c
JTEK18P	80343	10	1 1/4	.87	100/500	13.25/c
JTEK19P	80344	10	1 1/2	.98	100/500	14.28/c
JTEK20P	81311	10	2	1.23	100/500	14.55/c NEW

OTHER SIZES AND QUANTITIES AVAILABLE BY REQUEST



SELF-DRILLING & TAPPING SCREWS HEX WASHER HEAD

STEEL ZINC CHROMATE

STOCK NO.	UPC NO.	DIAMETER	LENGTH	WT. PER PKG.	STD. PKG/ MSTR. SLEEVE	SUGGESTED TRADE LIST PRICE PER
6-10 HAS A #2 Drill Point 1/4" HEAD—USE MT208B CHUCK, SEE PAGE 185						
JTEKD26	83324	6	3/8	.28	100/500	4.98/c NEW
JTEKD25	83323	6	1/2	.32	100/500	3.03/c NEW
JTEKD1	80345	8	1/2	.37	100/500	7.23/c
JTEKD16	80346	8	5/8	.44	100/500	7.40/c
JTEKD2	80347	8	3/4	.46	100/500	7.88/c
JTEKD14	80348	8	1	.54	100/500	8.35/c
JTEKD15	80349	8	1 1/2	.78	100/500	10.50/c
JTEKD82	83382	8	2	1.02	100/500	23.52/c NEW
JTEKD4	80350	10	1/2	.46	100/500	8.93/c
JTEKD3	80351	10	3/4	.54	100/500	9.00/c
10 HAS A #2 Drill Point 5/16" HEAD—USE MT210B CHUCK, SEE PAGE 185						
JTEKD5	80352	10	1/2	.50	100/500	8.90/c
JTEKD17	80353	10	5/8	.57	100/500	9.58/c
JTEKD6	80354	10	3/4	.65	100/500	10.40/c
JTEKD7	80355	10	1	.75	100/500	10.85/c
JTEKD18	80356	10	1 1/4	.89	100/500	11.58/c
JTEKD19	80357	10	1 1/2	1.02	100/500	12.78/c
JTEKD24	83322	10	2 1/2	1.57	100	15.25/c NEW
JTEKD23	83321	10	3	1.86	100	20.50/c NEW

CONTINUED ON NEXT PAGE



CONTINUED

SELF-DRILLING & TAPPING SCREWS HEX WASHER HEAD

STEEL ZINC CHROMATE

STOCK NO.	UPC NO.	DIAMETER	LENGTH	WT. PER PKG.	STD. PKG/ MSTR. SLEEVE	SUGGESTED TRADE LIST PRICE PER	
10-12 HAS A #3 Drill Point 5/16" HEAD—USE MT210B CHUCK, SEE PAGE 185							
JTEKD12	80358	10	3/4	.62	100/500	11.23/c	
JTEKD13	80359	10	1	.75	100/500	12.23/c	
JTEKD22	80360	10	2	1.28	100/500	17.88/c	
JTEKD20	80361	12	3/4	.81	100/500	13.93/c	
JTEKD8	80362	12	1	1.00	100/500	15.80/c	
JTEKD21	80363	12	1 1/2	1.33	100/500	18.25/c	
JTEKD32	80364	12	2	1.71	100	20.48/c	
JTEKD12212	90655	12	2 1/2	2.07	100	24.88/c	NEW
JTEKD30	83313	12	3	2.38	100	40.30/c	NEW
12 HAS A #5 Drill Point 5/16" HEAD—USE MT2110B CHUCK, SEE PAGE 185							
JTXV12114Z	25785	12	1 1/4	.65	50/250	35.50/c	NEW
14 HAS A #3 Drill Point 3/8" HEAD—USE MT212B CHUCK, SEE PAGE 185							
JTEKD9	80365	14	3/4	1.23	100/500	18.15/c	
JTEKD10	80366	14	1	1.41	100/500	20.65/c	
JTEKD37	83337	14	1 1/4	1.69	100/500	21.22/c	NEW
JTEKD11	80367	14	1 1/2	1.75	100/500	23.15/c	
JTEKD34	80368	14	2	2.44	100	36.78/c	
JTEKD36	83336	14	3	3.37	100	46.10/c	NEW
JTEKD99	83399	14	4	4.39	100	59.75/c	NEW

OTHER SIZES AND QUANTITIES AVAILABLE BY REQUEST

Not recommended for structural steel or bar joist. See PAGE 32 for heavy duty drill screws.



STAINLESS STEEL **NEW!** SELF-DRILLING & TAPPING SCREWS HEX WASHER HEAD

410 STAINLESS

STOCK NO.	UPC NO.	DIAMETER	LENGTH	WT. PER PKG.	STD. PKG/ MSTR. SLEEVE	SUGGESTED TRADE LIST PRICE PER	
8-10 HAS A #2 Drill Point 5/16" HEAD—USE MT208B CHUCK, SEE PG. 185							
JTEKD1SS	85211	8	1/2	.38	100/500	PLEASE CALL FOR TRADE LIST PRICING	NEW
JTEKD14SS	85214	8	1	.57	100/500		NEW
JTEKD15SS	85215	8	1 1/2	.78	100/500		NEW
JTEKD5SS	85220	10	1/2	.43	100/500		NEW
JTEKD6SS	85222	10	3/4	.63	100/500		NEW
10-14 HAS A #3 Drill Point 5/16" HEAD—USE MT208B CHUCK, SEE PG. 185							
JTEKD12SS	85227	10	3/4	.60	100/500		NEW
JTEKD7SS	85223	10	1	.78	100/500		NEW
JTEKD2SS	85229	10	2	1.26	100/500		NEW
JTEKD20SS	85230	12	3/4	.85	100/500		NEW
JTEKD9SS	85235	14	3/4	1.25	100/500		NEW
JTEKD10SS	85236	14	1	1.39	100/500		NEW
JTEKD23SS	85238	14	3	3.32	100		NEW

OTHER SIZES AND QUANTITIES AVAILABLE BY REQUEST



QUADrive SELF-DRILLING AND TAPPING SCREWS

FIRST IN THE WORLD

STEEL ZINC CHROMATE ECONOMICAL SWAGED POINT
Four drives in one head • Introduced in 1999

MADE IN USA



Manufactured by
 Avanti Screw, Inc.,
 A Metallics
 Affiliate



STOCK NO.	UPC NO.	DIAMETER	LENGTH	WT. PER PKG.	STD. PKG/ MSTR. SLEEVE	SUGGESTED TRADE LIST PRICE PER
-----------	---------	----------	--------	--------------	------------------------	--------------------------------

8-10 HAS A #2 Drill Point 1/4" HEAD



USE MT208B CHUCK see PAGE 185

QTEKD1	39120	8	1/2	.38	100/500	8.30/c
QTEKD2	39121	8	3/4	.48	100/500	9.05/c
QTEKD14	39122	8	1	.58	100/500	9.60/c
QTEKD4	39123	10	1/2	.41	100/500	10.00/c
QTEKD3	39124	10	3/4	.52	100/500	10.35/c

10 HAS A #2 Drill Point 5/16" HEAD



USE MT210B CHUCK see PAGE 185

QTEKD5	39125	10	1/2	.54	100/500	10.00/c
QTEKD17	39126	10	5/8	.59	100/500	10.35/c
QTEKD6	39127	10	3/4	.66	100/500	10.83/c
QTEKD7	39128	10	1	.79	100/500	11.98/c
QTEKD18	39129	10	1 1/4	.91	100/500	12.85/c
QTEKD19	39130	10	1 1/2	1.05	100/500	13.70/c

10-12 HAS A #3 Drill Point 5/16" HEAD



USE MT210B CHUCK see PAGE 185

QTEKD12	39135	10	3/4	.69	100/500	11.00/c
QTEKD13	39136	10	1	.81	100/500	11.98/c
QTEKD20	39137	12	3/4	.77	100/500	12.03/c
QTEKD8	39138	12	1	.95	100/500	13.58/c

AMERICA'S SOURCE FOR PREMIER AND INNOVATIVE FASTENERS & ANCHORS

HELPFUL HINTS FROM METALLICS

Selecting the proper fastener for each application is important in obtaining maximum performance.

Point Length — Length of the unthreaded point — must be greater than total thickness of material to be drilled. In jobs involving more than total thickness of material, calculation of total thickness must also include any spaces between thicknesses.

Driving Technique — Keep the driving tool perpendicular to working surface.

Drivers — Fasteners should be installed with 2500 RPM high-torque drivers equipped with a positive clutch. For wood to steel applications, drivers operating at 1700-2000 RPM should be used.

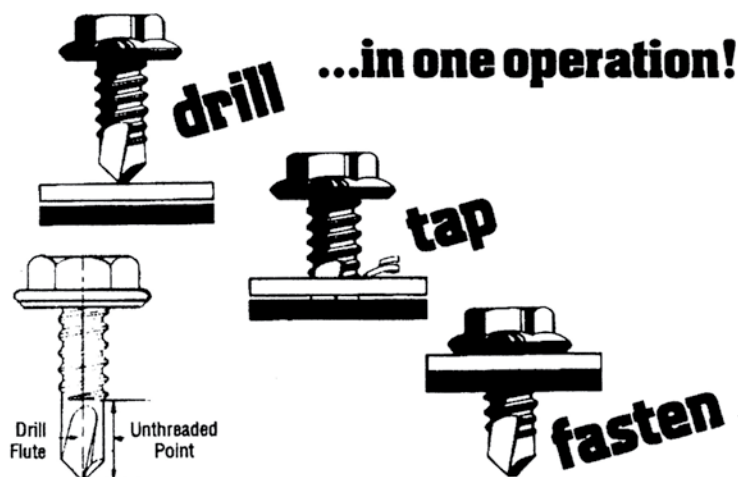



CONSTRUCTION FASTENERS METAL TO WOOD SCREWS

SELF-DRILLING FASTENERS FOR ATTACHING ROOF AND WALL METAL PANELS OVER INSULATION TO WOOD FRAMING.

GIMLET DRILL POINT.

AVAILABLE WITH OR WITHOUT WASHER.

Provides excellent corrosion resistance and lower tapping torque.



STOCK NO.	UPC NO.	DESCRIPTION	SIZE/ HEAD STYLE	STD. QTY.	WT. PER PKG	SUGGESTED TRADE LIST PRICE PER
WITH BONDED WASHER						
TGW9151	25735	9-15 x 1	1/4" Hex Washer Head	50	.43	24.60/c



WITHOUT WASHER						
TG9151	25740	9-15 x 1	1/4" Hex Head	50	.36	12.66/c

OTHER SIZES AND QUANTITIES AVAILABLE BY REQUEST

CONSTRUCTION FASTENERS

HEAVY DUTY DRILL SCREWS



HEAVY DUTY STEEL-TO-STEEL APPLICATION

Self-drilling fasteners for structural steel or bar joists up to 1/2" thick
Milled drill point • Excellent Corrosion Resistant Finish

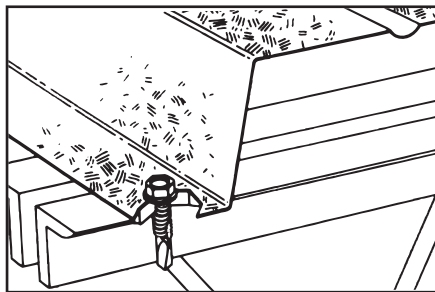

- Unique double fluted point dramatically improves drilling performance over conventional Drill screws.
- Attaches items directly to structural steel or bar joist.
- Excellent corrosion resistant finish.
- Engineered for faster drilling with less effort.
- The only fastener recommended for hanging jack chain without pre-drilling.
- We recommend using JW113 Fender Washer 1/4 x 1 with heavy duty drill screw to ensure proper grip on jack chain.

STOCK NO.	JAR UPC NO.	SIZE DESCRIPTION	SIZE/ HEAD STYLE	DRILL POINT	STD. QTY.	WT. PER PKG	SUGGESTED TRADE LIST PRICE PER
TXV12114	25730	12-24 X 1 1/4	5/16" Hex Washer Head	#5	50	.66	108.80/c
TXV12112	25728	12-24 X 1 1/2	5/16" Hex Washer Head	#5	50	.78	68.75/c NEW
TXV12200	25925	12-24 X 2	5/16" Hex Washer Head	#5	50	.97	76.25/c NEW
TXV14400	25780	1/4-14 X 4	5/16" Hex Washer Head	#5	50	1.95	97.20/c NEW

OTHER SIZES AND QUANTITIES AVAILABLE BY REQUEST

CONSTRUCTION FASTENERS



WOOD TO METAL DRILL SCREWS

FAST, EFFICIENT ATTACHMENT OF WOOD TO STEEL FRAMING WITH NO PRE-DRILLING.
MUST BE USED IN 16 GAUGE STEEL OR GREATER FOR ENGAGEMENT.



- Drill point has precise cutting edges to improve drill performance with less effort.
- Special winged fasteners ream a hole in wood preventing thread engagement during drilling.
- Wafer head design has a large bearing surface ideal for plywood.
- Flat head design countersinks and seats flush in wood.
- Excellent corrosion resistant finish.

STOCK NO.	UPC NO.	DESCRIPTION	HEAD STYLE	DRILL POINT	STD. QTY.	WT. PER PKG.	SUGGESTED TRADE LIST PRICE PER
TW101716	25745	10-24 x 1 ⁷ / ₁₆	Phillips/Flat Head	#3	50	.53	53.06/c
TW12212	25750	12-24 x 2 ³ / ₄	Phillips/Flat Head	#4	50	1.22	112.36/c

OTHER SIZES AND QUANTITIES AVAILABLE BY REQUEST

CONSTRUCTION FASTENERS

METAL TO METAL DRILL SCREWS

SELF DRILLING FASTENERS FOR ATTACHING STANDING ROOF CLIPS AND WALL/ROOF METAL PANELS TO STEEL FRAMING (GIRT/PURLIN/BAR JOIST).



- Hex Head Style.
- Milled drill point
- Available with or without bonded washer.
- Excellent corrosion resistant finish.

STOCK NO.	UPC NO.	DESCRIPTION	SIZE/ HEAD STYLE	DRILL POINT	STD. QTY.	WT. PER PKG.	SUGGESTED TRADE LIST PRICE PER
WITHOUT WASHER							
TX1234	25755	12-14 x 3 ⁴ / ₄	5 ¹⁶ / ₁₆ " Hex Head	#3	50	.44	42.00/c
TX1478	25760	1 ⁴ / ₄ -14 x 7 ⁸ / ₈	3 ⁸ / ₈ " Hex Head	#1	50	.54	45.20/c

WITH BONDED WASHER

TXW1234	25765	12-14 x 3 ⁴ / ₄	5 ¹⁶ / ₁₆ " Hex Washer Head	#3	50	.62	54.36/c
TXW1478	25770	1 ⁴ / ₄ -14 x 7 ⁸ / ₈	3 ⁸ / ₈ " Hex Washer Head	#1	50	.75	64.20/c

410 STAINLESS STEEL WITH BONDED WASHER

TX12114SS	25775	12-14 x 1 ¹ / ₄	5 ¹⁶ / ₁₆ " Hex Washer Head	#3	50	.81	135.16/c
-----------	-------	---------------------------------------	---	----	----	-----	----------

OTHER SIZES AND QUANTITIES AVAILABLE BY REQUEST

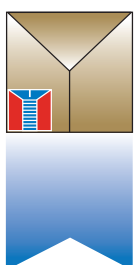

If you can't find the fastener you are looking for, call and experience the Metallics difference.



SCREWS

A



ZINC

FLAT HEAD PHILLIPS WOOD SCREWS

STEEL ZINC PLATED



STAINLESS
STEEL

BRASS

STOCK NO.	UPC NO.	DIAMETER	LENGTH	WT. PER PKG.	STD. PKG/MSTR. SLEEVE	SUGGESTED TRADE LIST PRICE PER	
JFWP120	88120	4	1/2	.11	100/500	14.75/c	NEW
JFWP61	84661	4	3/4	.20	100/500	5.38/c	NEW
JFWP62	84662	4	1	.24	100/500	7.40/c	NEW
JFWP9	84609	6	1/2	.27	100/500	4.53/c	NEW
JFWP10	80369	6	3/4	.28	100/500	4.70/c	
JFWP11	80370	6	1	.35	100/500	5.03/c	
JFWP12	81853	6	1 1/4	.43	100/500	5.10/c	NEW
JFWP13	84613	6	1 1/2	.49	100/500	6.28/c	NEW
JFWP14	81855	6	2	.55	100/500	8.88/c	NEW
JFWP18	80371	8	3/4	.34	100/500	5.03/c	
JFWP19	80372	8	1	.48	100/500	5.20/c	
JFWP20	80373	8	1 1/4	.61	100/500	5.65/c	
JFWP21	80374	8	1 1/2	.67	100/500	6.33/c	
JFWP65	84665	8	1 3/4	.69	100/500	20.00/c	NEW
JFWP22	80375	8	2	.84	100/500	8.55/c	
JFWP23	84623	8	2 1/2	1.05	100/500	10.55/c	NEW
JFWP24	80376	8	3	1.34	100	15.10/c	
JFWP25	84625	8	3 1/2	1.58	100	17.90/c	NEW
JFWP27	84627	10	1/2	.50	100/500	4.75/c	NEW
JFWP28	80377	10	3/4	.53	100/500	5.65/c	
JFWP29	80378	10	1	.67	100/500	6.23/c	
JFWP30	80379	10	1 1/4	.72	100/500	7.33/c	
JFWP31	80380	10	1 1/2	.89	100/500	8.55/c	
JFWP67	84667	10	1 3/4	1.03	100/500	37.35/c	NEW
JFWP32	80381	10	2	1.12	100/500	10.08/c	
JFWP33	80382	10	2 1/2	1.59	100	13.13/c	
JFWP34	84634	10	3	1.63	100	17.83/c	NEW
JFWP35	84635	10	3 1/2	1.85	100	27.90/c	NEW
JFWP36	84636	10	4	2.00	100	34.18/c	NEW
JFWP39	84639	12	1	.91	100	8.48/c	NEW
JFWP40	80383	12	1 1/4	.96	100/500	9.55/c	
JFWP41	80384	12	1 1/2	1.30	100/500	10.48/c	
JFWP42	80385	12	2	1.45	100/500	11.75/c	
JFWP43	80386	12	2 1/2	1.74	100	21.15/c	
JFWP44	84644	12	3	2.07	100	20.00/c	NEW
JFWP45	84645	12	3 1/2	2.89	100	27.10/c	NEW
JFWP46	84646	12	4	3.68	100	37.53/c	NEW
JFWP47	84647	14	1 3/4	1.69	100/500	15.33/c	NEW
JFWP48	84648	14	2	2.37	100	16.68/c	NEW
JFWP50	84650	14	3	2.99	100	24.75/c	NEW
STAINLESS STEEL 18-8 TYPE							
JFWP18SS	92218	8	3/4	.40	100/500	PLEASE CALL FOR TRADE LIST PRICING	NEW
JFWP19SS	92219	8	1	.52	100/500		NEW
JFWP22SS	92222	8	2	.90	100/500		NEW
JFWP28SS	92228	10	3/4	.53	100/500		NEW
JFWP29SS	92229	10	1	.73	100/500		NEW
BRASS							
JFWPB19	73119	8	1	.61	100/500	NEW	

OTHER SIZES AND QUANTITIES AVAILABLE BY REQUEST

FOR FULL THREAD REFER TO FLAT HEAD PHILLIPS SHEET METAL SCREW PAGE 21

SELF-PIERCING DRYWALL SCREWS FINE THREAD



PHILLIPS BUGLE HEAD

For use in up to "20 Gauge" Steel Stud

BLACK PHOSPHATE FINISH

Fine thread for hardwood, light gauge steel and light gauge aluminum.

This product for light applications has become the screw of choice among American tradesmen.

Prolonged use in moist conditions will cause this product to oxidize.

See pages 36 and 42 for a more permanent application.

USE #2 PHILLIPS POINT INSERT OR POWER BIT - SEE PAGE 185



STOCK NO.	UPC NO.	DIAMETER	LENGTH	WT. PER PKG.	STD. PKG./MSTR. SLEEVE	SUGGESTED TRADE LIST PRICE PER
100 PACK						
JDWS1C	80387	6	1	.36	100/500	3.65/c
JDWS3C	80388	6	1 1/4	.42	100/500	3.70/c
JDWS4C	80389	6	1 5/8	.49	100/500	4.35/c
JDWS5C	80390	6	2	.61	100/500	5.98/c
JDWS6C	80391	6	2 1/4	.69	100/500	6.38/c
JDWS7C	80392	8	2 1/2	.98	100/500	9.90/c
JDWS9C	80393	8	3	1.11	100	11.58/c
JDWS10C	84099	10	3 1/2	1.86	100	13.25/c NEW

1000 PACK IN SQUARE PLASTIC JAR



Power Bit included free in 1000 pack
Save over 100 pack

SUGGESTED
TRADE LIST PRICE PER

DWS1M	27001	6	1	3.21	1000	33.55/m
DWS3M	27007	6	1 1/4	3.75	1000	34.25/m
DWS4M	27010	6	1 5/8	4.70	1000	40.60/m
DWS5M	27013	6	2	5.52	1000	55.73/m
DWS6M	27016	6	2 1/4	6.40	1000	59.40/m
DWS7M	27019	8	2 1/2	6.43	1000	91.98/m
DWS9M	27025	8	3	10.55	1000	107.75/m

BULK PACK IN CARTON



3 Power Bits included free in bulk pack
Save over 100 pack

SUGGESTED
TRADE LIST PRICE PER

DWS1B	27002	6	1	30.00	10000	288.70/ea
DWS3B	27008	6	1 1/4	32.80	8000	236.33/ea
DWS4B	27011	6	1 5/8	23.40	5000	174.58/ea
DWS5B	27014	6	2	21.35	3500	166.83/ea
DWS6B	27017	6	2 1/4	24.00	3000	153.08/ea
DWS7B	27020	8	2 1/2	27.00	2500	198.05/ea
DWS9B	27026	8	3	26.00	2000	185.30/ea
DWS10B	10695	10	3 1/2	19.50	1500	184.84/ea NEW

OTHER SIZES AND QUANTITIES AVAILABLE BY REQUEST



PACKED WITH PRIDE

As a part of our Quality Program, each shipment and each single carton leaving our facilities has a label affixed to it, indicating the person who packed the order.

HARD BODY PACKING

When you, the distributor, compare price and performance to other fastener suppliers, please compare our Hard Body Packing to the way they ship products. We do it the right way—the quality way—the Metallics way.





FLAT HEAD PHILLIPS DECK SCREWS COARSE THREAD

For all-weather wood applications

HARDENED STEEL ZINC DICHROMATE
Now available in quantities of 100, 500 and 1000
GOLD DECK SCREWS "YELLOW ZINC"

STOCK NO.	UPC NO.	DIAMETER THREAD	LENGTH	WT. PER PKG.	STD. PKG.	SUGGESTED TRADE LIST PRICE PER
100 PACKS		Bit NOT included				
JGDS0	81679	6	1	.35	100/500	3.70/c
JGDS1	81680	6	1 ¹ / ₄	.42	100/500	3.70/c
JGDS2	81681	6	1 ⁵ / ₈	.51	100/500	4.35/c
JGDS3	81682	6	2	.61	100/500	5.98/c
JGDS4	81683	8	2 ¹ / ₂	.96	100	9.90/c
JGDS5	81684	8	3	1.16	100	11.58/c
JGDS6	81685	10	3 ¹ / ₂	1.88	100	18.48/c
JGDS7	81686	10	4	2.16	100	19.50/c

500 PACKS		1 Power Bit included free in 500 pack Save				SUGGESTED TRADE LIST PRICE PER
GDS1V	12720	6	1 ¹ / ₄	1.97	500	17.13/ea
GDS2V	12721	6	1 ⁵ / ₈	2.40	500	20.30/ea
GDS3V	12722	6	2	2.92	500	27.70/ea
GDS4V	12723	8	2 ¹ / ₂	4.68	500	46.00/ea
GDS5V	12724	8	3	5.62	500	53.70/ea
GDS6V	12725	10	3 ¹ / ₂	9.04	500	85.78/ea
GDS7V	12726	10	4	12.50	500	90.48/ea

1000 PACKS		1 Power Bit included free in 1000 pack Save				SUGGESTED TRADE LIST PRICE PER
GDS1M	12730	6	1 ¹ / ₄	3.74	1000	33.23/m
GDS2M	12731	6	1 ⁵ / ₈	4.69	1000	39.25/m
GDS3M	12732	6	2	6.29	1000	53.70/m
GDS4M	12733	8	2 ¹ / ₂	10.42	1000	88.95/m
GDS5M	12734	8	3	11.13	1000	104.08/m
GDS6M	12735	10	3 ¹ / ₂	18.18	1000	166.18/m
GDS7M	12736	10	4	25.00	1000	175.25/m

500 & 1000 PACKS SUPPLIED IN JARS

Our persistence and determination to ship the same day and maintain the highest fill rate in America among fastener suppliers to the distributor market is not by accident. In all our management offices, this quotation is displayed:

*Nothing in the world can take the place of persistence.
Talent will not; nothing is more common than unsuccessful men with talent.
Genius will not; unrewarded genius is almost a proverb.
Education will not; the world is full of educated derelicts.
Persistence and determination alone are omnipotent.*

- Calvin Coolidge

The secret is out: "Our motivation starts at the top."



SELF-PIERCING DRYWALL SCREWS

PHILLIPS BUGLE HEAD

COARSE THREAD
BLACK PHOSPHATE FINISH

COARSE THREAD USED IN MANY APPLICATIONS
WOOD TO WOOD, DRYWALL TO WOOD, AND
CABINET INSTALLATIONS



STOCK NO.	UPC NO.	DIAMETER	LENGTH	WT. PER PKG.	STD. PKG/ MSTR. SLEEVE	SUGGESTED TRADE LIST PRICE PER
100 PACK						
JDWC1C	90501	6	1	.35	100/500	4.35/c
JDWC3C	90503	6	1 ¹ / ₄	.43	100/500	4.43/c
JDWC4C	90504	6	1 ⁵ / ₈	.51	100/500	5.23/c
JDWC5C	90505	6	2	.60	100/500	7.10/c
JDWC6C	90506	6	2 ¹ / ₄	.66	100/500	7.65/c
JDWC7C	90507	8	2 ¹ / ₂	1.00	100/500	9.90/c
JDWC9C	90509	8	3	1.12	100/500	11.58/c

1000 PACK IN SQUARE PLASTIC JAR — 1 Power Bit included FREE in 1000 Pack

DWC1M	90331	6	1	3.03	1000	40.53/m	NEW
DWC3M	90333	6	1 ¹ / ₄	4.33	1000	39.00/m	NEW
DWC4M	90334	6	1 ⁵ / ₈	4.84	1000	47.50/m	NEW
DWC5M	90335	6	2	5.63	1000	67.25/m	NEW
DWC9M	90339	8	3	11.14	1000	99.75/m	NEW

BULK PACK IN CARTON — 3 Power Bits included FREE in Bulk Pack

DWC3B	83308	6	1 ¹ / ₄	29.99	8000	158.00/ea	NEW
DWC4B	83309	6	1 ⁵ / ₈	23.40	5000	171.50/ea	NEW
DWC5B	83515	6	2	19.29	3500	147.88/ea	NEW
DWC6B	83516	6	2 ¹ / ₄	18.57	3000	140.40/ea	NEW
DWC7B	83517	7	2 ¹ / ₂	22.98	2500	155.63/ea	NEW
DWC9B	83519	8	3	22.25	2000	133.60/ea	NEW
DWC10B	83520	10	3 ¹ / ₂	27.05	1500	185.48/ea	NEW

OTHER SIZES AND QUANTITIES AVAILABLE BY REQUEST



DRYWALL SCREW KIT

FINE THREAD

BLACK PHOSPHATE FINISH

SELF-PIERCING DRYWALL SCREWS

CAN BE USED IN HARDWOOD, LIGHT GAUGE STEEL AND LIGHT ALUMINUM

STOCK NO.	UPC NO.	DESCRIPTION OF CONTENTS	STD. PKG. MSTR. CARTON	WT. EACH	SUGGESTED TRADE LIST PRICE PER KIT
DWSK1	12712	75 - 6 X 1" Drywall Screws 50 - 6 x 1 ¹ / ₄ " Drywall Screws 40 - 6 x 1 ⁵ / ₈ " Drywall Screws 30 - 6 x 2" Drywall Screws 20 - 8 x 2 ¹ / ₂ " Drywall Screws 20 - 8 x 3" Drywall Screws 1 - #2 x 2" Phillips Power Bit	1/25	1.4	27.70/ea

A



TRIM HEAD SCREW KIT

SQUARE DRIVE • TRIM HEAD SHARP POINT

FINE THREAD
BLACK PHOSPHATE FINISH
CAN BE USED FOR ATTACHING
WOOD TRIM TO WOOD OR METAL STUDS



STOCK NO.	UPC NO.	DESCRIPTION OF CONTENTS	STD. PKG. MSTR. CARTON	WT. EACH	SUGGESTED TRADE LIST PRICE PER KIT
THSK1	81794	100 - 6 X 1" Screws 75 - 6 x 1 ⁵ / ₈ " Screws 50 - 6 x 2 ¹ / ₄ " Screws 50 - 8 x 3" Screws		1.6	27.70/ea



SELF-PIERCING DRYWALL FRAMING SCREWS

PHILLIPS PAN HEAD/BLACK PHOSPHATE FINISH

For use in up to "20 Gauge" Steel Stud



Ideal for light duty steel and aluminum metal-to-metal application.
Low profile deep Phillips recess.

STOCK NO.	UPC NO.	DIAMETER	LENGTH	WT. PER PKG.	STD. PKG.	SUGGESTED TRADE LIST PRICE PER
JPDW1C	80401	6	7/16	.32	100/500	3.55/c
1000 PACK IN SQUARE PLASTIC JAR				Power Bit included free in 1000 pack		
PDW1M	27031	6	7/16	2.68	1000	32.90/m
BULK PACK IN BOX CARTON				3 Power Bits included free in bulk pack		
PDW1B	27032	6	7/16	39.75	15,000/carton	428.00/ea pkg



SELF-DRILLING & TAPPING DRYWALL FRAMING SCREWS

PHILLIPS PAN HEAD/SWAGED DRILL POINT/BLACK PHOSPHATE FINISH

For use in up to "12 Gauge" Steel Stud



A drill bit point to speed installation and proper thread seating.
Ideal for light-to-medium duty steel and aluminum, metal-to-metal application.
Low profile deep Phillips recess.

STOCK NO.	UPC NO.	DIAMETER	LENGTH	WT. PER PKG.	STD. PKG.	SUGGESTED TRADE LIST PRICE PER
JPDS1C	80403	6	7/16	.33	100/500	4.23/c
1000 PACK IN SQUARE PLASTIC JAR				Power Bit included free in 1000 pack		
PDS1M	27081	6	7/16	2.82	1000	39.10/m
BULK PACK				3 Power Bits included free in bulk pack		
PDS1B	27082	6	7/16	42.30	15,000/carton	671.40/ea pkg



SELF-DRILLING & TAPPING DRYWALL SCREWS FINE THREAD



For use in up to "12 Gauge" Steel Stud
PHILLIPS BUGLE HEAD/ZINC FINISH/DRILL POINT

Designed to penetrate drywall, and drill and tap a hole in metal studs up to 12 gauge thickness.

This product, for light applications, has become the screw of choice among American tradesmen for wood, drywall, steel and aluminum application. Prolonged use in moist conditions will cause this product to oxidize. See pages 36 and 42 for a more permanent application. **Use Phillips point insert or power bit.**

STOCK NO.	UPC NO.	DIAMETER	LENGTH	BIT SIZE	WT. PER PKG.	WT. PER. MSTR. SLEEVE	SUGGESTED TRADE LIST PRICE PER
100 PACK							
JSDS1C	80405	6	1	#1	.39	100/500	4.28/c
JSDS3C	80406	6	1 1/4	#1	.43	100/500	5.03/c
JSDS4C	80407	6	1 5/8	#1	.53	100/500	6.88/c
JSDS5C	80408	6	1 7/8	#1	.61	100/500	8.25/c
JSDS7C	80409	8	2 5/8	#2	1.10	100	11.90/c
JSDS9C	80410	8	3	#2	1.24	100	12.28/c

1000 PACK IN SQUARE PLASTIC JAR



1 Power Bit included free in 1000 pack

SDS1M	27051	6	1	#1	3.45	1000	39.65/m
SDS3M	27057	6	1 1/4	#1	4.04	1000	47.00/m
SDS4M	27060	6	1 5/8	#1	5.80	1000	63.78/m
SDS5M	27063	6	1 7/8	#1	7.00	1000	76.55/m
SDS7M	27069	8	2 5/8	#2	10.49	1000	110.78/m
SDS9M	27075	8	3	#2	12.07	1000	113.80/m

BULK PACK IN BOX CARTON



3 Power Bits included free in bulk pack

SDS1B	27052	6	1	#1	38.00	10000	342.40/ea pkg
SDS3B	27058	6	1 1/4	#1	36.80	8000	322.25/ea pkg
SDS4B	27061	6	1 5/8	#1	29.00	5000	273.58/ea pkg
SDS5B	27064	6	1 7/8	#1	28.00	4000	263.18/ea pkg
SDS7B	27070	8	2 5/8	#2	23.00	2000	187.98/ea pkg
SDS9B	27076	8	3	#2	18.45	1500	147.05/ea pkg

MANUFACTURING CAPABILITIES

Diameter range #2 thru 5/16" / 1.5mm thru 8mm • Length range 1/8" thru 3" / 3.5mm thru 75mm
Materials: Steel, Brass, Stainless, Aluminum, Bronze.

NEED SCREWS...
Let Us Make Them For You!



A METALLICS AFFILIATE

P.O. Box 1600 • 231 Cross Street
Bristol, CT 06011-1600
Tel: 800-984-8945 • Fax: 800-984-8946

CAPABILITIES LIST

PLANT SIZE: 100,000 SQUARE FEET
LOCATION: Bristol, Connecticut
EQUIPMENT: 27 Hi-Speed Cold Headers
8 Burr-Free Screw Slotters
3 Shank Slotters
2 Pointers
14 High Speed Thread Rollers

ADDITIONAL PLANT INFO: Modern shipping facility utilizing digital scale counting machines. In-house packaging facilities - boxing, sorting, bagging. All material boxed, palletized & labeled with your needs in mind for domestic or export shipping.

SECONDARY WORK: All plating & heat treating is done on the outside and certified for your guarantee.

INFORMATION SYSTEMS: Our facility has new and upgraded Technology to meet your customers specific requirements.

MADE IN USA



SCREWS

A



SELF-PIERCING DRYWALL WAFER HEAD SCREWS FINE THREAD

PHILLIPS WAFER HEAD/ZINC FINISH
FOR USE IN UP TO "20 GAUGE" STEEL STUD

Ideal for light-duty steel and aluminum, metal-to-metal application. Large diameter head provides greater holding surface.

STOCK NO.	UPC NO.	DIAMETER	LENGTH	WT. PER PKG.	STD. PKG.	SUGGESTED TRADE LIST PRICE PER
JWDW1C	80411	8	1/2	.45	100/500	4.03/c
JWDW2C	80412	8	3/4	.51	100/500	4.43/c
JWDW3C	80413	8	1	.59	100/500	5.20/c
JWDW4C	81039	8	1 1/4	.68	100/500	5.73/c NEW

1000 PACK IN VISUAL PLASTIC JAR



Power Bit included free in 1000 pack

WDW1M	27034	8	1/2	3.91	1000	37.58/m
WDW2M	27091	8	3/4	4.77	1000	41.65/m
WDW3M	27092	8	1	5.59	1000	48.35/m
WDW4M	27089	8	1 1/4	6.97	1000	53.30/m NEW

BULK PACK IN BOX CARTON



3 Power Bits included free in bulk pack

WDW1B	27035	8	1/2	36.95	10000	322.25/ea pkg
WDW2B	27093	8	3/4	45.98	10000	355.83/ea pkg
WDW3B	27094	8	1	57.50	10000	416.28/ea pkg
WDW4B	27099	8	1 1/4	69.85	10000	470.00/ea pkg NEW

SELF-DRILLING & TAPPING DRYWALL WAFER HEAD SCREWS FINE THREAD



PHILLIPS WAFER HEAD/DRILL POINT/ZINC FINISH
FOR USE IN UP TO "12 GAUGE" STEEL STUD

For metal-to-metal application. Large diameter head provides greater holding surface. Ideal for metal lath to metal studs up to 12 gauge thickness.

STOCK NO.	UPC NO.	DIAMETER	LENGTH	WT. PER PKG.	STD. PKG.	SUGGESTED TRADE LIST PRICE PER
JWDS1C	80414	8	1/2	.40	100/500	3.93/c
JWDS2C	80415	8	3/4	.56	100/500	4.30/c
JWDS3C	82043	8	1	.62	100/500	8.38/c NEW
JWDS4C	80316	8	1 1/4	.70	100/500	6.10/c
JWDS6C	82046	8	1 5/8	.87	100/500	49.00/c NEW

1000 PACK IN VISUAL PLASTIC JAR



Power Bit included free in 1000 pack

WDS1M	27084	8	1/2	3.42	1000	35.93/m
WDS2M	27095	8	3/4	4.85	1000	39.98/m
WDS3M	27040	8	1	7.90	1000	75.53/m NEW
WDS4M	27098	8	1 1/4	6.73	1000	57.08/m

BULK PACK IN BOX CARTON



3 Power Bits included free in bulk pack

WDS1B	27085	8	1/2	33.25	10000	312.20/ea pkg
WDS2B	27096	8	3/4	55.00	10000	342.40/ea pkg
WDS3B	27104	8	1	79.00	10000	637.80/ea pkg NEW
WDS4B	27097	8	1 1/4	87.10	10000	490.13/ea pkg



AMERICA'S SOURCE FOR PREMIER AND INNOVATIVE FASTENERS & ANCHORS

SELF-PIERCING SQUARE DRIVE DRYWALL SCREWS COARSE THREAD

BUGLE HEAD

For use in drywall-wood applications
BLACK PHOSPHATE FINISH



This product for light applications has become the screw of choice among American tradesmen for wood, drywall, steel and aluminum application. Prolonged use in moist conditions will cause this product to oxidize. See pages 36 and 42 for a more permanent application.

**THIS PRODUCT AVAILABLE ONLY IN COARSE THREAD
USE #2 SQUARE DRIVE INSERT OR POWER BIT SEE PG. 185**

STOCK NO.	JAR UPC NO.	DIAMETER	LENGTH	WT. PER PKG.	STD. PKG./MSTR. SLEEVE	SUGGESTED TRADE LIST PRICE PER
100 PACK						
JDSWR1C	80394	6	1	.35	100/500	3.70/c
JDSWR3C	80395	6	1 1/4	.41	100/500	3.70/c
JDSWR4C	80396	6	1 5/8	.52	100/500	5.45/c
JDSWR5C	80397	6	2	.60	100/500	5.98/c
JDSWR6C	80398	6	2 1/4	.64	100/500	8.38/c
JDSWR7C	80399	8	2 1/2	.95	100	9.90/c
JDSWR9C	80400	8	3	1.19	100	11.58/c

1000 PACK IN VISUAL PLASTIC JAR



Power Bit included free in 1000 pack

DWSR1M	26066	6	1	3.47	1000	34.25/m
DWSR3M	26069	6	1 1/4	3.67	1000	34.25/m
DWSR4M	26072	6	1 5/8	5.20	1000	50.70/m
DWSR5M	26075	6	2	5.59	1000	55.73/m
DWSR6M	26078	6	2 1/4	8.00	1000	78.20/m
DWSR7M	26081	8	2 1/2	9.35	1000	91.98/m
DWSR9M	26084	8	3	13.0	1000	107.75/m

BULK PACK IN BOX CARTON



3 Power Bits included free in bulk pack

DWSR1B	26067	6	1	35.0	10,000	295.40/ea pkg
DWSR3B	26070	6	1 1/4	32.8	8000	236.48/ea pkg
DWSR4B	26073	6	1 5/8	26.0	5000	218.20/ea pkg
DWSR5B	26076	6	2	25.9	3500	166.83/ea pkg
DWSR6B	26079	6	2 1/4	24.0	3000	201.43/ea pkg
DWSR7B	26082	8	2 1/2	27.0	2500	198.05/ea pkg
DWSR9B	26085	8	3	26.0	2000	185.30/ea pkg

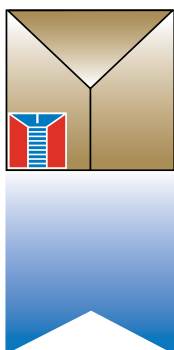

If you can't find the fastener you are looking for, call and experience the Metallics difference.

? 's = Call Us.

Metallics East • Bristol, CT
229 Cross Street
1-800-243-8272

Metallics West • Mancos, CO
651 North Main Street
1-800-269-5183



Square Drive

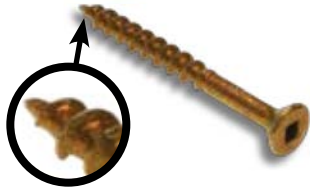

FLAT HEAD SQUARE DRIVE DECK SCREWS COARSE THREAD

HARDENED STEEL ZINC/ALL-WEATHER COATING

Now available in quantities of 100, 500 and 1000
MOST POSITIVE ENGAGEMENT OF ALL DECK SCREWS

TYPE 17 POINT DRILLS ITS OWN HOLE

STOCK NO.	UPC NO.	DIAMETER THREAD	LENGTH	WT. PER PKG.	STD. PKG.	SUGGESTED TRADE LIST PRICE PER
100 PACK						
JRDS1	81727	7	1 ¹ / ₄	.50	100	7.58/c
JRDS2	81728	8	1 ⁵ / ₈	.74	100	10.15/c
JRDS3	81729	9	2	.81	100	13.75/c
JRDS4	81737	9	2 ¹ / ₂	1.23	100	22.25/c
JRDS5	81738	9	3	1.41	100	20.63/c
JRDS6	81739	10	4	2.50	100	31.90/c



1 Power Bit included free in 500 pack

500 PACK						
RDS1V	12740	7	1 ¹ / ₄	1.87	500	35.23/ea pkg
RDS2V	12741	8	1 ⁵ / ₈	3.20	500	47.00/ea pkg
RDS3V	12742	9	2	3.34	500	63.95/ea pkg
RDS4V	12743	9	2 ¹ / ₂	5.21	500	82.75/ea pkg
RDS5V	12744	9	3	6.02	500	95.85/ea pkg
RDS6V	12745	10	4	9.09	500	148.20/ea pkg



1 Power Bit included free in 1000 pack

1000 PACK						
RDS1M	12750	7	1 ¹ / ₄	4.80	1000	66.83/m
RDS2M	12751	8	1 ⁵ / ₈	7.06	1000	89.30/m
RDS3M	12752	9	2	8.29	1000	121.15/m
RDS4M	12753	9	2 ¹ / ₂	10.42	1000	156.63/m
RDS5M	12754	9	3	13.95	1000	181.28/m
RDS6M	12755	10	4	18.18	1000	280.63/m

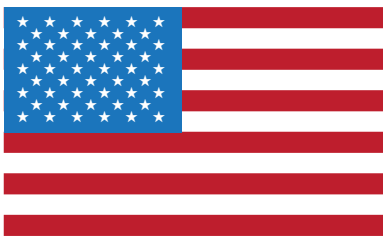

METALLICS

“Growth Through Innovation”

We believe Metallics has the largest ratio of American made to foreign produced product of any other American fastener company.

SERVING THE
ELECTRICAL, PLUMBING, HEATING AND AIR CONDITIONING
DISTRIBUTOR MARKETPLACE

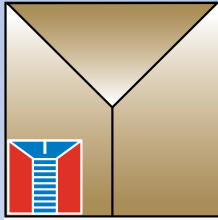

Metallics



Ceramic Coated Deck Screws



- Ceramic Polymer coating protects against corrosion
- Good wear resistance and can be used in pressure lumber
- Excellent resistance to UV radiation
- Flat head with Nibs
- Combo Square-Phillips Drive
- Type - 17 point
- In packages of 100, 500 or 1000 pieces

PART #	UPC #	DESCRIPTION	QTY / PKG	SUG. TRADE LIST / PKG
JCPD1	77007	#8 x 1-5/8" flat hd, w/nibs, sq/phl drive, typ-17pt. Ceramic coated deck screw	100	\$ 14.28
CPD1V	77057	#8 x 1-5/8" flat hd, w/nibs, sq/phl drive, typ-17pt. Ceramic coated deck screw	500	\$ 52.98
CPD1M	77107	#8 x 1-5/8" flat hd, w/nibs, sq/phl drive, typ-17pt. Ceramic coated deck screw	1000	\$ 101.83
JCPD2	77009	#8 x 2" flat hd, w/nibs, sq/phl drive, typ-17pt. Ceramic coated deck screw	100	\$ 19.25
CPD2V	77059	#8 x 2" flat hd, w/nibs, sq/phl drive, typ-17pt. Ceramic coated deck screw	500	\$ 76.95
CPD2M	77109	#8 x 2" flat hd, w/nibs, sq/phl drive, typ-17pt. Ceramic coated deck screw	1000	\$ 147.75
JCPD3	77010	#9 x 2-1/2" flat hd, w/nibs, sq/phl drive, typ-17pt. Ceramic coated deck screw	100	\$ 23.43
CPD3V	77074	#9 x 2-1/2" flat hd, w/nibs, sq/phl drive, typ-17pt. Ceramic coated deck screw	500	\$ 106.38
CPD3M	77124	#9 x 2-1/2" flat hd, w/nibs, sq/phl drive, typ-17pt. Ceramic coated deck screw	1000	\$ 195.73
JCPD4	77025	#9 x 3" flat hd, w/nibs, sq/phl drive, typ-17pt. Ceramic coated deck screw	100	\$ 26.25
CPD4V	77075	#9 x 3" flat hd, w/nibs, sq/phl drive, typ-17pt. Ceramic coated deck screw	500	\$ 120.63
CPD4M	77125	#9 x 3" flat hd, w/nibs, sq/phl drive, typ-17pt. Ceramic coated deck screw	1000	\$ 230.78
JCPD5	77040	#10 x 3-1/2" flat hd, w/nibs, sq/phl drive, typ-17pt. Ceramic coated deck screw	100	\$ 55.83
CPD5V	77090	#10 x 3-1/2" flat hd, w/nibs, sq/phl drive, typ-17pt. Ceramic coated deck screw	500	\$ 254.88
CPD5M	77140	#10 x 3-1/2" flat hd, w/nibs, sq/phl drive, typ-17pt. Ceramic coated deck screw	1000	\$ 485.45

★ ★ ★ ★ ★ "Growth Through Innovation" ★ ★ ★ ★ ★

Metallics

229 Cross Street, Bristol, CT 06010
 Tel 800-243-8272 • Fax 800-831-9358
 Email sales@metallicsonline.com

Metallics West

651 North Main Street, Mancos, CO 81328
 Tel 800-269-5183 • Fax 800-269-6278
 Email saleswest@metallicsonline.com

www.metallicsonline.com

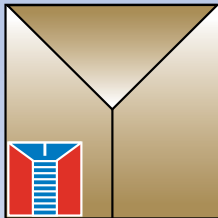

Metallics



Single Sided and Double Sided Organizers

Organizer boxes have clear lids to see product inside, and dividers have dovetails to lock in place



- **ORG1** is single sided and offers 22 storage compartments. Includes 18 dovetail dividers allowing you to customize the size of the compartments.
- **ORG2** is double sided and offers 32 storage compartments. Includes 24 dovetail dividers.

PART #	UPC #	DESCRIPTION	QTY / PKG	SUG. TRADE LIST / PKG
ORG1	34501	Single Sided box with up to 22 compartments, measures 13"L x 10"W x 2"H	1	\$ 27.75
ORG2	34502	Double Sided box with up to 32 compartments, measures 13"L x 10"W x 3"H	1	\$ 40.98

★ ★ ★ ★ ★ *"Growth Through Innovation"* ★ ★ ★ ★ ★

Metallics

229 Cross Street, Bristol, CT 06010
 Tel 800-243-8272 • Fax 800-831-9358
 Email sales@metallicsonline.com

Metallics West

651 North Main Street, Mancos, CO 81328
 Tel 800-269-5183 • Fax 800-269-6278
 Email saleswest@metallicsonline.com

www.metallicsonline.com

TAMPER-RESIST STAINLESS STEEL HEX PIN & STAR PIN MACHINE SCREWS

A

**SPECIAL
ORDER**

ALL ITEMS LISTED ARE
SPECIAL ORDER ITEMS
PLEASE ALLOW
1-2 WEEKS FOR DELIVERY



HEX PIN

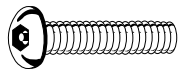
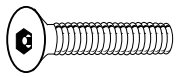

FLAT HEX PIN
STOCK NO.

BUTTON HEX PIN
STOCK NO.

STAR PIN

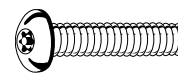
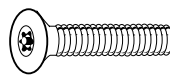

FLAT STAR PIN
STOCK NO.

BUTTON STAR PIN
STOCK NO.

SIZE	FLAT HEX PIN STOCK NO.	BUTTON HEX PIN STOCK NO.	FLAT STAR PIN STOCK NO.	BUTTON STAR PIN STOCK NO.
6-32	DRIVER SIZE 1/8		DRIVER SIZE T10	
1/2"	TP100SFC	TP100SBC	TP200SFC	TP200SBC
3/4"	TP101SFC	TP101SBC	TP201SFC	TP201SBC
1"	TP102SFC	TP102SBC	TP202SFC	TP202SBC
1 1/4"	TP103SFC	TP103SBC	-	-
1 1/2"	TP104SFC	TP104SBC	TP204SFC	TP204SBC
8-32	DRIVER SIZE 5/32		DRIVER SIZE T25	
1/2"	TP105SFC	TP105SBC	TP205SFC	TP205SBC
3/4"	TP106SFC	TP106SBC	TP206SFC	TP206SBC
1"	TP107SFC	TP107SBC	TP207SFC	TP207SBC
1 1/4"	TP108SFC	TP108SBC	TP208SFC	TP208SBC
1 1/2"	TP109SFC	TP109SBC	TP209SFC	TP209SBC
2"	TP110SFC	TP110SBC	-	-
10-24	DRIVER SIZE 5/32		DRIVER SIZE T25	
1/2"	TP111SFC	TP111SBC	TP211SFC	TP211SBC
3/4"	TP112SFC	TP112SBC	TP212SFC	TP212SBC
1"	TP113SFC	TP113SBC	TP213SFC	TP213SBC
1 1/4"	TP114SFC	TP114SBC	TP214SFC	TP214SBC
1 1/2"	TP115SFC	TP115SBC	TP215SFC	TP215SBC
1/4-20	DRIVER SIZE 5/32		DRIVER SIZE T30	
1/2"	TP116SFC	TP116SBC	TP216SFC	TP216SBC
3/4"	TP117SFC	TP117SBC	TP217SFC	TP217SBC
1"	TP118SFC	TP118SBC	TP218SFC	TP218SBC
1 1/4"	TP119SFC	TP119SBC	TP219SFC	TP219SBC
1 1/2"	TP120SFC	TP120SBC	TP220SFC	TP220SBC
2"	TP121SFC	TP121SBC	-	-

CALL
METALLICS
EAST OR WEST
FOR
PRICING

OTHER SIZES AND QUANTITIES AVAILABLE BY REQUEST

SEE PAGE 48 FOR DRIVER STOCK NUMBERS.

BECAUSE OF THE SPECIAL NATURE OF THESE PRODUCTS WE DO NOT PROVIDE
A RECOMMENDED TRADE LIST PRICE

Metallics East • Bristol, CT
229 Cross Street
1-800-243-8272

Metallics West • Mancos, CO
651 North Main Street
1-800-269-5183

SCREWS

TAMPER-RESIST STAINLESS STEEL SPANNER & ONE-WAY MACHINE SCREWS



ALL ITEMS LISTED ARE
SPECIAL ORDER ITEMS
PLEASE ALLOW
1-2 WEEKS FOR DELIVERY



SIZE	SPANNER		ONE-WAY
	FLAT SPANNER STOCK NO.	PAN SPANNER STOCK NO.	ONE WAY ROUND HEAD STOCK NO.
6-32	DRIVER SIZE #6		DRIVER SIZE #6
1/2"	TP300SFC	TP300SPC	TP400SRC
3/4"	TP301SFC	TP301SPC	TP401SRC
1"	TP302SFC	TP302SPC	TP402SRC
1 1/4"	TP303SFC	TP303SPC	TP403SRC
1 1/2"	TP304SFC	TP304SPC	TP404SRC
2"	TP305SFC	TP305SPC	-
8-32	DRIVER SIZE #8		DRIVER SIZE #8
1/2"	TP306SFC	TP306SPC	TP406SRC
3/4"	TP307SFC	TP307SPC	TP407SRC
1"	TP308SFC	TP308SPC	TP408SRC
1 1/4"	TP309SFC	TP309SPC	TP409SRC
1 1/2"	TP310SFC	TP310SPC	TP410SRC
2"	TP311SFC	TP311SPC	-
10-24	DRIVER SIZE #10		DRIVER SIZE #10
1/2"	TP312SFC	TP312SPC	TP412SRC
3/4"	TP313SFC	TP313SPC	TP413SRC
1"	TP314SFC	TP314SPC	TP414SRC
1 1/4"	TP315SFC	TP315SPC	TP415SRC
1 1/2"	TP316SFC	TP316SPC	TP416SRC
2"	TP317SFC	TP317SPC	-
1/4-20	DRIVER SIZE #14		DRIVER SIZE #14
1/2"	TP318SFC	TP318SPC	TP418SRC
3/4"	TP319SFC	TP319SPC	TP419SRC
1"	TP320SFC	TP320SPC	TP420SRC
1 1/4"	TP321SFC	TP321SPC	TP421SRC
1 1/2"	TP322SFC	TP322SPC	TP422SRC
2"	TP323SFC	TP323SPC	TP423SRC

CALL
METALLICS
EAST OR WEST
FOR
PRICING

OTHER SIZES AND QUANTITIES AVAILABLE BY REQUEST

SEE PAGE 48 FOR DRIVER STOCK NUMBERS.

BECAUSE OF THE SPECIAL NATURE OF THESE PRODUCTS WE DO NOT PROVIDE A RECOMMENDED TRADE LIST PRICE

Metallics East • Bristol, CT
229 Cross Street
1-800-243-8272

Metallics West • Mancos, CO
651 North Main Street
1-800-269-5183

TAMPER-RESIST STAINLESS STEEL HEX PIN & STAR PIN SHEET METAL SCREWS



**SPECIAL
ORDER**

ALL ITEMS LISTED ARE
SPECIAL ORDER ITEMS
PLEASE ALLOW
1-2 WEEKS FOR DELIVERY

HEX PIN			STAR PIN	
SIZE	HEX FLAT STOCK NO.	HEX BUTTON STOCK NO.	STAR FLAT STOCK NO.	STAR BUTTON STOCK NO.
6	DRIVER SIZE 1/8		DRIVER SIZE T10	DRIVER SIZE T10
1/2"	TP500SFC	TP500SBC	TP600SFC	TP600SBC
3/4"	TP501SFC	TP501SBC	TP601SFC	TP601SBC
1"	TP502SFC	TP502SBC	TP602SFC	TP602SBC
1 1/2"	TP503SFC	TP503SBC	TP603SFC	TP603SBC
8	DRIVER SIZE 5/32		DRIVER SIZE T15	DRIVER SIZE T15
1/2"	TP504SFC	TP504SBC	TP604SFC	TP604SBC
3/4"	TP505SFC	TP505SBC	TP605SFC	TP605SBC
1"	TP506SFC	TP506SBC	TP606SFC	TP606SBC
1 1/2"	TP507SFC	TP507SBC	TP607SFC	TP607SBC
10	DRIVER SIZE 5/32		DRIVER SIZE T20	DRIVER SIZE T25
1/2"	TP508SFC	TP508SBC	TP608SFC	TP608SBC
3/4"	TP509SFC	TP509SBC	TP609SFC	TP609SBC
1"	TP510SFC	TP510SBC	TP610SFC	TP610SBC
1 1/4"	TP511SFC	TP511SBC	TP611SFC	TP611SBC
1 1/2"	TP512SFC	TP512SBC	TP612SFC	TP612SBC
2"	TP513SFC	TP513SBC	-	-
14	DRIVER SIZE 5/32		DRIVER SIZE T30	DRIVER SIZE T27
1/2"	TP514SFC	TP514SBC	TP614SFC	TP614SBC
3/4"	TP515SFC	TP515SBC	TP615SFC	TP615SBC
1"	TP516SFC	TP516SBC	TP616SFC	TP616SBC
1 1/4"	TP517SFC	TP517SBC	TP617SFC	TP617SBC
1 1/2"	TP518SFC	TP518SBC	TP618SFC	TP618SBC
2"	TP519SFC	TP519SBC	-	-



**CALL
METALLICS
EAST OR WEST
FOR
PRICING**

OTHER SIZES AND QUANTITIES AVAILABLE BY REQUEST

SEE PAGE 48 FOR DRIVER STOCK NUMBERS.

BECAUSE OF THE SPECIAL NATURE OF THESE PRODUCTS WE DO NOT PROVIDE A RECOMMENDED TRADE LIST PRICE

Metallics East • Bristol, CT
229 Cross Street
1-800-243-8272

Metallics West • Mancos, CO
651 North Main Street
1-800-269-5183

SCREWS



TAMPER-RESIST BITS, TOOLS AND KITS

A

POWER INSERT BITS

SPANNER BIT



STOCK NO.	UPC NO.	SIZE/ DESCRIPTION	SUGGESTED TRADE LIST PRICE PER
00SP6B	25027	#6 Spanner	5.03/ea
00SP8B	10195	#8 Spanner	5.03/ea
00SP10B	10196	#10 Spanner	5.03/ea
00SP12B	10194	#12 Spanner	5.03/ea
00SP14B	10197	#14 Spanner	5.03/ea

STAR PIN (TORX)



00TP10	41200	T10	5.03/ea
00TP15	41210	T15	5.03/ea
00TP20	41215	T20	5.03/ea
00TP25	41220	T25	5.03/ea
00TP27	41222	T27	5.03/ea
00TP30	41230	T30	5.03/ea

HEX PIN



00HP18B	41255	1/8	5.03/ea
00HP32B	41260	5/32	5.03/ea



MAGNETIC HAND DRIVER BIT STORAGE IN HANDLE

(ORDER BITS SEPARATELY)

STOCK NO.	UPC NO.	DESCRIPTION	WT. EACH	STD. PKG.	SUGGESTED TRADE LIST PRICE PER
HDT14	41265	Magnetic Hand Driver 1/4" Hex	.24	1	18.15/ea



USE WITH TP400 SERIES SCREWS

ONE-WAY REMOVAL TOOL

ONE-WAY MACHINE SCREW INSTALLATION AND REMOVAL

- Install with a standard blade screwdriver
- Remove **only** with a One-Way Removal Tool

STOCK NO.	UPC NO.	DESCRIPTION	SIZE	WT. EACH	STD. PKG.	SUGGESTED TRADE LIST PRICE PER
RT1W	41270	1-Way Removal Tool	6-8	.23	1	53.70/ea
RT2W	41271	1-Way Removal Tool	10-12	.30	1	53.70/ea
RT3W	41272	1-Way Removal Tool	1/4	.38	1	53.70/ea

30-PIECE TAMPER-RESIST KIT



STOCK NO.	UPC NO.	NO. OF PIECES	WT. EACH	SUGGESTED TRADE LIST PRICE PER
TPK30	41280	30	1.04	119.18/ea kit

INCLUDES

BIT/PT. SIZE

Driver	1/4 (magnetic w/storage handle)
TORX® Bits	T8, T9, T10, T15, T20, T25, T27, T30, T40
Hex Pin Bits	3/32; 1/8; 9/64; 5/32; 3/16; 7/32; 1/4; 5/16
Spanner Bits	6; 8; 10
TRI-WING® Bits	1; 2; 3
POZIDRIV® Bit	1; 2; 3
Socket Adapter	1"
Bit Holder	3"



ISOMAX® ASSORTMENT OF INSERT BITS 100 PC. SECURITY & NON SECURITY BIT KIT

Isomax® is a registered trademark

STOCK NO.	UPC NO.	DESCRIPTION	WT. PER PKG.	SUGGESTED TRADE LIST PRICE PER
EVBK100	26720	100 Piece Security & Non Security Bit Kit	2	92.88/ea kit

Kit Contains the Following Bits

Tip Types	Tip Sizes	Length
Socket Adapters	1/4"	1"
	1/4"	2"
Female Socket Adapters	1/4"	1"
Y-Cup Hook Installer/Remover	Fits All	1"
Bit Holder	1/4" Hex	2-3/8"
Phillips® (2) each	#0	1"
	#1	1"
	#2	1"
	#3	1"
Octo-Driv® fits Pozzi-Drive® - (2) each	#0	1"
	#1	1"
	#2	1"
	#3	1"
Slotted	2	1"
	2.5	1"
	3	1"
	4	1"
	4.5	1"
	5	1"
	6	1"
	7	1"
8	1"	

Tip Types	Tip Sizes	Length
Tee*Star®	T8	1"
	T9	1"
	T10	1"
	T15	1"
	T20	1"
	T25	1"
	T27	1"
	T30	1"
	T40	1"
	Security Tee*Star® (fits Security Torx®)	T8
T9		1"
T10		1"
T15		1"
T20		1"
T25		1"
T27		1"
T30		1"
T40		1"
Hex Key (fits Allen®)		2mm
	2.5mm	1"
	3mm	1"
	4mm	1"
	5mm	1"
	5.5mm	1"
	6mm	1"
	7mm	1"
	8mm	1"
	1/16"	1"
	5/64"	1"
	3/32"	1"
	7/64"	1"
	1/8"	1"
	5/32"	1"
	3/16"	1"
7/32"	1"	
1/4"	1"	
5/16"	1"	

Tip Types	Tip Sizes	Length
Security Hex (fits Security Allen®)	2mm	1"
	2.5mm	1"
	3mm	1"
	4mm	1"
	5mm	1"
	6mm	1"
	5/64"	1"
	3/32"	1"
Spanner	7/64"	1"
	1/8"	1"
	9/64"	1"
	5/32"	1"
Triple-Y® (fits Tri-Wing®)	#4	1"
	#6	1"
	#8	1"
	#10	1"
Tee-Cross® (fits Torq-Set®)	1	1"
	2	1"
	3	1"
Tee-Cross® (fits Torq-Set®)	4	1"
	6	1"
	8	1"
Square Recess	10	1"
	R0	1"
	R1	1"
	R2	1"
Splines	R3	1"
	#4	1"
	#5	1"
Clutch	#6	1"
	#1	1"
	#2	1"
	#3	1"

A



TAMPER RESISTANT SCREWS STAINLESS STEEL MACHINE SCREW KIT KEEP IT SAFE

STOCK NO.	UPC NO.	DESCRIPTION	WT. PER PKG.	SUGGESTED TRADE LIST PRICE PER
TPKRM1	41322	25 - #6-32 x 1" Hex-Pin Button Head 25 - #8-32 x 1" Hex-Pin Button Head 25 - #10-24 x 1" Hex-Pin Button Head 25 - 1/4 - 20 X 1" Hex-Pin Button Head 25 - #6 x 1" Star-Pin Button Head 25 - #8 x 1" Star-Pin Button Head 25 - #10 x 1" Star-Pin Button Head 25 - 1/4 - 20 X 1" Star-Pin Button Head 25 - #6 x 1" Spanner Button Head 25 - #8 x 1" Spanner Button Head 25 - #10 x 1" Spanner Button Head 25 - 1/4 - 20 X 1" Spanner Button Head	2.80	368.60/ea kit



TAMPER RESISTANT SCREWS STAINLESS STEEL SHEET METAL SCREW KIT KEEP IT SAFE

STOCK NO.	UPC NO.	DESCRIPTION	WT. PER PKG.	SUGGESTED TRADE LIST PRICE PER
TPKSM1	41320	25 - #6 x 1" Hex-Pin Button Head 25 - #8 x 1" Hex-Pin Button Head 25 - #10 x 1" Hex-Pin Button Head 25 - #6 x 1" Star-Pin Button Head 25 - #8 x 1" Star-Pin Button Head 25 - #10 x 1" Star-Pin Button Head	1.26	167.38/ea kit



SHEET METAL SCREW KITS

PAN HEAD — HEX HEAD

POWER BITS AND DRIVERS INCLUDED

STOCK NO.	UPC NO.	DESCRIPTION OF CONTENTS	STD. PKG./MSTR. CARTON	WT. EACH	SUGGESTED TRADE LIST PRICE
TSK8	10494	300 pcs - #8 Pan Head Combo (Phillips/slotted) 100 - 1/2", 75 - 3/4", 50 - 1", 30 - 1 1/4", 25 - 1 1/2", 20 - 2" 1 - #2 2" Phillips Power Bit - 100P2B	1/25	1.66	17.63/ea kit
TSK10	10495	245 pcs - #10 Pan Head Combo (Phillips/slotted) 75 - 1/2", 50 - 3/4", 45 - 1", 30 - 1 1/4", 25 - 1 1/2", 20 - 2" 1 - #2 2" Phillips Power Bit - 100P2B	1/25	1.84	18.80/ea kit
DSK8	10496	300 pcs - #8 1/4 Hex Slotted Washer Head 100 - 1/2", 75 - 3/4", 50 - 1", 30 - 1 1/4", 25 - 1 1/2", 20 - 2" 1 - 1/4" x 1 5/8" Hex Nut Driver - MT208B	1/25	1.69	20.65/ea kit
DSK10	10497	245 pcs - #10 5/16 Hex Slotted Washer Head 75 - 1/2", 50 - 3/4", 45 - 1", 30 - 1 1/4", 25 - 1 1/2", 20 - 2" 1 - 5/16" x 1 5/8" Hex Nut Driver - 1 - 5/16" MT210B	1/25	1.59	24.18/ea kit
DSK12	10473	245 pcs - #12 5/16 Hex Slotted Washer Head 75 - 1/2", 50 - 3/4", 45 - 1", 30 - 1 1/4", 25 - 1 1/2", 20 - 2" 1 - 5/16" x 1 5/8" Hex Nut Driver - 1 - 5/16" MT210B	1/25	2.00	25.00/ea kit NEW
TSSK8	10498	300 pcs - #8 Pan Head Square Drive Recess 100 - 1/2", 75 - 3/4", 50 - 1", 30 - 1 1/4", 25 - 1 1/2", 20 - 2" 1 - #2 2" Square Drive Power Bit - 100R2B	1/25	1.50	21.83/ea kit
TTSK10	10499	245 pcs - #10 Pan Head Tri-Drive (square/phillips/slotted) 75 - 1/2", 50 - 3/4", 45 - 1", 30 - 1 1/4", 25 - 1 1/2", 20 - 2" 1 - #2 2" Square Drive Power Bit - 100R2B	1/25	1.75	24.18/ea kit

ONLY METALLICS!



THE GOLD DECK SCREW KIT

ASSORTED FLAT HEAD PHILLIPS DECK SCREWS

ALL WEATHER WOOD APPLICATIONS YELLOW ZINC DICHROMATE COARSE THREAD

KIT INCLUDES: 300 screws

- 80 - 6 x 1
- 70 - 6 x 1-1/4
- 60 - 6 x 1-5/8
- 40 - 6 x 2
- 30 - 8 x 2-1/2
- 20 - 8 x 3
- 1 - 6 COMPARTMENT BOX



STOCK NO.	UPC NO.	WT. PER PKG.	STD. PKG.	SUGGESTED TRADE LIST PRICE
GDSK1	12704	1.69	1 Kit	20.13/ea kit

A



SELF DRILLING SCREW KITS

Several popular drive styles in assorted sizes

ECONOMICAL SWAGED POINT DRILL SCREWS
PACKED IN A RIGID PLASTIC BOX WITH DIVIDERS
ZINC PLATED

POWER BITS AND SETTERS INCLUDED

STOCK NO.	UPC NO.	DESCRIPTION OF CONTENTS	STD. PKG./ MSTR. CARTON	WT. EACH	SUGGESTED TRADE LIST PRICE PER
TEKDK1	10503	305 pcs - #8 & #10 Hex Washer Head Screws #8 WITH 1/4" HEX HEAD 100 - 1/2", 50 - 3/4", 40 - 1", #10 WITH 5/16" HEX HEAD 50 - 1/2", 35 - 3/4", 30 - 1" 1 - 1/4" Nut Setter - MT208B 1 - 5/16" Nut Setter - MT210B	1/25	1.69	32.75/ea kit
TEKSK1	10504	380 pcs - #8 & #10 Square Drive Pan Head Screws 100 - #8 1/2", 60 - #8 3/4", 50 - #8 1", 80 - #10 1/2", 50 - #10 3/4", 40 - #10 1" 1 - #2 2" Square Drive Power Bit - 100R2B	1/25	1.18	25.18/ea kit
TEKPK1	10505	380 pcs - #8 & #10 Pan Head Phillips Screws 100 - #8 1/2", 60 - #8 3/4", 50 - #8 1", 80 - #10 1/2", 50 - #10 3/4", 40 - #10 1" 1 - #2 2" Phillips Power Bit - 100P2B	1/25	1.96	25.18/ea kit



ROUND HEAD MACHINE SCREW KITS

Several popular drive styles in assorted sizes

Packed in a rigid plastic box with dividers
ZINC PLATED

STOCK NO.	UPC NO.	DESCRIPTION OF CONTENTS	STD. PKG./ MSTR. CARTON	WT. EACH	SUGGESTED TRADE LIST PRICE PER
RMK632	10894	370 pcs - 6-32 Round Head Combo (Phillips/slotted) 100 - 3/4", 75 - 1", 75 - 1 1/4", 50 - 1 1/2", 40 - 2", 30 - 3"	1/25	1.92	18.28/ea kit
RMK832	10264	370 pcs - 8-32 Round Head Combo (Phillips/slotted) 100 - 1/2", 75 - 3/4", 75 - 1", 50 - 1 1/4", 40 - 1 1/2", 30 - 2"	1/25	2.28	18.15/ea kit
RMK1032	10501	245 pcs - 10-32 Round Head Combo (Phillips/slotted) 75 - 1/2", 50 - 3/4", 40 - 1", 30 - 1 1/4", 25 - 1 1/2", 25 - 2"	1/25	2.18	17.63/ea kit
RMK1420	10502	124 pcs - 1/4-20 Round Head Combo (Phillips/slotted) 35 - 1/2", 30 - 3/4", 20 - 1", 15 - 1 1/4", 12 - 1 1/2", 12 - 2"	1/25	2.02	16.80/ea kit



FLAT HEAD MACHINE SCREW KITS

Several popular drive styles in assorted sizes

Packed in a rigid plastic box with dividers

ZINC PLATED

A

STOCK NO.	UPC NO.	DESCRIPTION OF CONTENTS	STD. PKG./MSTR. CARTON	WT. EACH	SUGGESTED TRADE LIST PRICE PER
FMK632	10263	370 pcs - 6-32 Flat Head Slotted 100 - 3/4", 75 - 1", 75 - 1 1/4", 50 - 1 1/2", 40 - 2", 30 - 3"	1/25	1.79	18.15/ea
FMKP632	10356	370 pcs - 6-32 Flat Head Phillips 100 - 3/4", 75 - 1", 75 - 1 1/4", 50 - 1 1/2", 40 - 2", 30 - 3"	1/25	1.84	19.18/ea NEW
FMK832	10883	370 pcs - 8-32 Flat Head Slot 100 - 1/2", 75 - 3/4", 75 - 1", 50 - 1 1/4", 40 - 1 1/2", 30 - 2"	1/25	1.81	18.28/ea NEW



STOVE BOLT KITS

Packed in a rigid plastic box with dividers

ZINC PLATED

STOCK NO.	UPC NO.	DESCRIPTION OF CONTENTS	STD. PKG./MSTR. CARTON	WT. EACH	SUGGESTED TRADE LIST PRICE PER KIT
RSBK1	10365	6-32 Round Head Combo (Phillips and Slotted) MS 50 - 1/2", 30 - 3/4", 20 - 1", 20 - 1 1/4", 15 - 1 1/2", 15 - 2" 150 - 6-32 Hex Steel Nuts 100 #6 SAE Washers 100 #6 Lock Washers	1/25	1.23	33.13/ea kit
TOTAL PIECES IN KIT 500					
RSBK2	10366	8-32 Round Head Combo (Phillips and Slotted) MS 50 - 1/2", 30 - 3/4", 20 - 1", 20 - 1 1/4", 15 - 1 1/2", 15 - 2" 150 - 8-32 Hex Steel Nuts 100 #8 SAE Washers 100 #8 Lock Washers	1/25	1.64	37.08/ea kit
TOTAL PIECES IN KIT 500					
RSBK3	10367	10-32 Round Head Combo (Phillips and Slotted) MS 50 - 1/2", 30 - 3/4", 20 - 1", 20 - 1 1/4", 15 - 1 1/2", 15 - 2" 150 - 10-32 Hex Steel Nuts 100 #10 SAE Washers 100 #10 Lock Washers	1/25	2.14	39.00/ea kit
TOTAL PIECES IN KIT 500					
RSBK4	10368	1/4"-20 Round Head Combo (Phillips and Slotted) MS 35 - 1/2", 30 - 3/4", 20 - 1", 15 - 1 1/4", 12 - 1 1/2", 12 - 2" 100 - 1/4"-20 Hex Nuts 50 1/4 SAE Washers 50 1/4 Lock Washers	1/25	3.03	32.28/ea kit
TOTAL PIECES IN KIT 324					

A

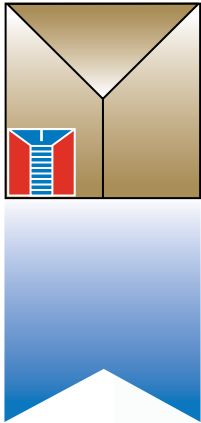

METALLICS INC TREASURE CHEST

END OF THE RUN
ASSORTMENT OF FASTENERS



**A 11 lb. Assortment of Screws,
Nuts, Bolts, Washers, Nails, Anchors, etc.**

No set amount of any one item.

Find the **GOLD Screw and Receive a
FREE GIFT from your Distributor!**

STOCK NO.	UPC NO.	DESCRIPTION	WT. PER PKG.	SUGGESTED TRADE LIST PRICE
FA-1	11500	Mixture of Fasteners	11.35	29.80 ea

FOR INFORMATION CALL
METALLICS EAST AT (800) 243-8272 OR METALLICS WEST AT (800) 269-5183



HEXAGON NUTS

STOCK NO.	UPC NO.	SIZE	BOLT SIZE	WT. PER PKG.	STD. PKG./MSTR. SLEEVE	SUGGESTED TRADE LIST PRICE PER	
GRADE 2 STEEL ZINC PLATED							
JN157	79957	4-40	7/64	.16	100/500	4.48/c	NEW
JN159	80427	6-32	1/8	.26	100/500	2.68/c	
JN160	80428	8-32	5/32	.32	100/500	3.00/c	
JN161	80429	10-24	3/16	.38	100/500	3.20/c	
JN162	80430	10-32	3/16	.36	100/500	3.20/c	
JN163	80431	1/4-20	1/4	.75	100/500	3.85/c	
JN164	80432	5/16-18	5/16	1.09	100/500	6.93/c	
JN165	80433	3/8-16	3/8	1.55	100/500	8.90/c	
JN170	83140	7/16-14	7/16	2.81	100/500	18.63/c	NEW
JN166	80434	1/2-13	1/2	1.80	50/250	18.10/c	
JN167	80435	5/8-11	5/8	1.81	25	32.20/c	
JN168	80436	3/4-10	3/4	2.91	25	44.92/c	
HEAVY HEX NUT GRADE 2 STEEL ZINC PLATED							
JHFN38	80437	3/8-16	3/8	2.86	100	12.50/c	
JHFN12	80438	1/2-13	1/2	6.07	100	24.25/c	
JHFN58	86658	5/8-11	5/8	2.61	25/125	46.20/c	NEW
JHFN34	86489	3/4-10	3/4	4.73	25/125	129.00/c	NEW
GRADE 5 HARDENED STEEL ZINC PLATED							
JG5N163	80439	1/4-20	1/4	.75	100/500	4.03/c	
JG5N164	80440	5/16-18	5/16	1.10	100/500	5.98/c	
JG5N165	80441	3/8-16	3/8	1.59	100/500	9.68/c	
JG5N170	83915	7/16-14	7/16	11.9	100/500	57.40/c	NEW
JG5N166	80442	1/2-13	1/2	1.82	50	19.40/c	
JG5N167	80443	5/8-11	5/8	1.83	25	39.40/c	
JG5N168	80444	3/4-10	3/4	2.92	25	65.80/c	
GRADE 8 HARDENED STEEL ZINC PLATED							
JG8N163	80445	1/4-20	1/4	.74	100/500	5.70/c	
JG8N164	80446	5/16-18	5/16	1.10	100/500	8.48/c	
JG8N165	80447	3/8-16	3/8	1.60	100/500	12.33/c	
JG8N169	81482	7/16-14	7/16	2.81	100/500	20.89/c	NEW
JG8N166	80448	1/2-13	1/2	1.85	50	28.06/c	
JG8N167	80449	5/8-11	5/8	1.87	25	55.20/c	
JG8N168	80450	3/4-10	3/4	2.87	25	87.32/c	
STAINLESS STEEL 18-8 TYPE							
JSN10	80451	6-32	1/8	.26	100/500	7.23/c	
JSN11	80452	8-32	5/32	.30	100/500	7.73/c	
JSN12	80453	10-24	3/16	.36	100/500	8.35/c	
JSN13	80454	10-32	3/16	.35	100/500	8.35/c	
JSN14	80455	1/4-20	1/4	.77	100/500	10.68/c	
JSN15	80456	5/16-18	5/16	1.10	100/500	21.80/c	
JSN16	80457	3/8-16	3/8	1.63	100/500	23.50/c	
JSN20	82279	7/16-14	7/16	2.85	100/500	37.53/c	NEW
JSN18	80458	1/2-13	1/2	1.92	50	50.80/c	
JSN19	82278	5/8-11	5/8	7.34	100/500	118.93/c	NEW

OTHER SIZES AND QUANTITIES AVAILABLE BY REQUEST

CONTINUED ON NEXT PAGE



NUTS



CONTINUED HEXAGON NUTS

STOCK NO.	UPC NO.	SIZE	BOLT SIZE	WT. PER PKG.	STD. PKG./MSTR. SLEEVE	SUGGESTED TRADE LIST PRICE PER	
SILICON BRONZE							
JSBN6	73306	6-32	1/8	.25	100/500	27.68/c	NEW
JSBN8	73308	8-32	5/32	.38	100/500	31.93c	NEW
JSBN24	73324	10-24	3/16	.36	100/500	40.53/c	NEW
JSBN32	73332	10-32	3/16	.38	100/500	40.53/c	NEW
JSBN14	80459	1/4-20	1/4	.46	50	29.36/c	
JSBN516	80460	5/16-18	5/16	.63	50	41.36/c	
JSBN38	80461	3/8-16	3/8	.91	50	53.86/c	NEW
JSBN12	80462	1/2-13	1/2	1.06	25	126.12/c	
JSBN58	84340	5/8-11	5/8	1.81	25	375.38/c	NEW
BRASS							
JN159BR	80463	6-32	1/8	.26	100/500	7.10/c	
JN160BR	80464	8-32	5/32	.33	100/500	7.60/c	
JN161BR	62272	10-24	3/16	.38	100/500	15.40/c	NEW
JN162BR	80465	10-32	3/16	.38	100/500	9.70/c	
JN163BR	80466	1/4-20	1/4	1.82	100/500	15.53/c	
JN165BR	62276	3/8-16	3/8	1.73	100/500	48.73/c	NEW
NEW 316 TYPE STAINLESS STEEL							
JSN14316SS	89341	1/4-20	1/4	.66	100/500	PLEASE CALL FOR TRADE LIST PRICING	NEW
JSN15316SS	89315	5/16-18	5/16	.65	100/500		NEW
JSN16316SS	96716	3/8-16	3/8	.82	50/250		NEW
JSN20316SS	89320	7/16-14	7/16	1.44	50		NEW
JSN25316SS	89325	1/2-13	1/2	1.82	50		NEW
JSN19316SS	96719	5/8-11	5/8	3.67	50		NEW
NEW GALVANIZED							
JN163G	83163	1/4-20	1/4	.81	100/500	12.10/c	NEW
JN165G	83165	3/8-16	3/8	1.60	100/500	16.10/c	NEW
JN166G	83166	1/2-13	1/2	1.92	50/250	36.00/c	NEW
JN167G	83167	5/8-11	5/8	3.66	50/250	68.20/c	NEW
NEW JAM NUT STEEL ZINC							
JN163J	83713	1/4-20	1/4	.55	100/500	7.03/c	NEW
JN165J	83715	3/8-16	3/8	1.55	100/500	49.75/c	NEW

OTHER SIZES AND QUANTITIES AVAILABLE BY REQUEST



STAINLESS STEEL NUT KIT **NEW!** 18-8 SERIES TYPE

STOCK NO.	UPC NO.	DESCRIPTION OF CONTENTS	STD. PKG./MSTR. CARTON	WT. EACH	SUGGESTED TRADE LIST PRICE PER
SNK1	90210	400 pcs - Hexagon Nuts 100 - 6-32, 100 - 8-32, 100 - 10-32 50 - 1/4-20, 30 - 5/16-18, 20 - 3/8-16	1/25	1.90	31.08/ea kit



HEX LOCK NUTS

WITH EXTERNAL TOOTH LOCK WASHER ATTACHED

STOCK NO.	UPC NO.	SIZE	BOLT SIZE	WT. PER PKG.	STD. PKG./MSTR. SLEEVE	SUGGESTED TRADE LIST PRICE PER
STEEL ZINC CHROMATE						
JTLN1	80467	6-32	1/8	.28	100/500	7.25/c
JTLN2	80468	8-32	5/32	.33	100/500	7.73/c
JTLN3	80469	10-24	3/16	.39	100/500	8.25/c
JTLN4	80470	10-32	3/16	.40	100/500	8.35/c
JTLN5	80471	1/4-20	1/4	.72	100/500	9.75/c
JTLN6	80472	5/16-18	5/16	1.20	100/500	15.80/c
JTLN7	80473	3/8-16	3/8	1.72	100/500	20.35/c
NEW STAINLESS STEEL 18-8 TYPE						
JTLN5SS	90095	1/4-20	1/4	0.73	100/500	PLEASE CALL
JTLN7SS	90097	3/8-16	3/8	1.70	100/500	

OTHER SIZES AND QUANTITIES AVAILABLE BY REQUEST



NYLON INSERT LOCK NUTS

For use in areas of high vibration • Eliminates the need for a lockwasher
Not for use in high heat situations.

STOCK NO.	UPC NO.	SIZE	BOLT SIZE	WT. PER PKG.	STD. PKG./MSTR. SLEEVE	SUGGESTED TRADE LIST PRICE PER	
STEEL ZINC CHROMATE							
JNYN159	80474	6-32	1/8	.30	100/500	7.25/c	
JNYN160	80475	8-32	5/32	.44	100/500	7.73/c	
JNYN161	80476	10-24	3/16	.54	100/500	8.35/c	
JNYN162	80477	10-32	3/16	.53	100/500	8.35/c	
JNYN163	80478	1/4-20	1/4	.80	100/500	9.75/c	
JNYN164	80479	5/16-18	5/16	1.18	100/500	15.80/c	
JNYN165	80480	3/8-16	3/8	1.77	100/500	20.35/c	
JNYN166	80481	1/2-13	1/2	2.26	50	25.40/c	
JNYN167	80482	5/8-11	5/8	2.19	25	44.72/c	
JNYN168	80483	3/4-10	3/4	3.10	25	84.80/c	
NEW STAINLESS STEEL 18-8 TYPE							
JNYN160SS	84471	8-32	3/32	.45	100/500	PLEASE CALL FOR TRADE LIST PRICING	
JNYN161SS	84472	10-24	3/16	.53	100/500		NEW
JNYN162SS	84473	10-32	3/16	.52	100/500		NEW
JNYN163SS	84474	1/4-20	1/4	.84	100/500		NEW
JNYN164SS	84475	5/16-18	5/16	1.15	100/500		NEW
JNYN165SS	84476	3/8-16	3/8	1.81	100/500		NEW
JNYN172SS	84483	7/16-14	7/16	2.41	100/500		NEW
JNYN166SS	84477	1/2-13	1/2	2.30	50/250		NEW
JNYN167SS	84478	5/8-11	5/8	4.42	50/250		NEW

OTHER SIZES AND QUANTITIES AVAILABLE BY REQUEST



SERRATED HEX FLANGE LOCK NUTS

FOR USE IN HIGH VIBRATION AREAS

STOCK NO.	UPC NO.	SIZE	BOLT SIZE	WT. PER PKG.	STD. PKG./MSTR. SLEEVE	SUGGESTED TRADE LIST PRICE PER
STEEL ZINC CHROMATE						
JSFN832	82060	8-32	3/32	.60	100/500	3.65/c
JSFN1024	82062	10-24	3/16	.66	100/500	3.83/c
JSFN1032	82064	10-32	3/16	.65	100/500	3.83/c
JSFN1420	82066	1/4-20	1/4	.93	100/500	4.60/c
JSFN51618	82068	5/16-18	5/16	1.30	100/500	8.93/c
JSFN3816	82070	3/8-16	3/8	1.90	100/500	11.23/c
NEW STAINLESS STEEL 18-8 TYPE						
JSFN1213SS	93818	1/2-13	1/2	2.29	50/250	PLEASE CALL

OTHER SIZES AND QUANTITIES AVAILABLE BY REQUEST

NUTS



WING NUTS

General purpose nuts designed for rapid assembly and disassembly by hand

STOCK NO.	UPC NO.	SIZE	WT. PER PKG.	STD. PKG./MSTR. SLEEVE	SUGGESTED TRADE LIST PRICE
ZINC PLATED					
JWN3	79899	8-32	.86	100/500	12.38/c NEW
JWN4	79900	10-24	.92	100/500	14.90/c NEW
JWN5	79901	10-32	.92	100/500	16.20/c NEW
JWN6	80484	1/4-20	1.28	100/500	17.65/c
JWN7	80485	5/16-18	1.47	100/500	24.43/c
JWN8	80486	3/8-16	2.75	100/500	37.63c
JWN9	80487	1/2-13	3.40	50/250	89.43/c
NEW STAINLESS STEEL 18-8 TYPE					
JWN2SS	90782	6-32	.80	100/500	PLEASE CALL FOR TRADE LIST PRICING NEW
JWN3SS	90783	8-32	.84	100/500	
JWN4SS	90793	10-24	.93	100/500	
JWN6SS	90785	1/4-20	1.36	100/500	
JWN7SS	90786	5/16-18	1.99	100/500	
JWN8SS	90787	3/8-16	3.35	100/500	



CAP NUTS

Provides a proper finish when covering exposed threaded bolt ends

STOCK NO.	UPC NO.	SIZE	WT. PER PKG.	STD. PKG./MSTR. SLEEVE	SUGGESTED TRADE LIST PRICE
NICKEL PLATED					
JCN160	81798	6-32	.30	100/500	26.13/c NEW
JCN163	80488	1/4-20	.75	100/500	10.75/c
JCN164	80489	5/16-18	1.42	100/500	20.83/c
JCN165	80490	3/8-16	1.88	100/500	27.05/c
NEW STAINLESS STEEL 18-8 TYPE					
JCN163SS	90916	1/4-20	1.31	100/500	PLEASE CALL NEW
JCN164SS	92917	5/16-18	2.18	100/500	
JCN165SS	92918	3/8-16	3.36	100/500	



SQUARE NUTS

ZINC PLATED

Used for channel and strut applications

STOCK NO.	UPC NO.	THREAD DIAMETER	WIDTH "A"	THICKNESS "B"	WT. PER PKG.	STD. PKG./MSTR. SLEEVE	SUGGESTED TRADE LIST PRICE
JSQ2	80491	6/32	5/16	7/64	.12	100/500	3.33/c
JSQ3	80492	8/32	11/32	1/8	.36	100/500	3.45/c
JSQ4	80493	10/24	3/8	1/8	.43	100/500	3.65/c
JSQ5	80494	10/32	3/8	1/8	.44	100/500	3.70/c
JSQ6	80495	1/4-20	7/16	3/16	.79	100/500	5.78/c
JSQ7	80496	5/16-18	9/16	7/32	.47	100/500	9.03/c
JSQ8	80497	3/8-16	5/8	1/4	2.45	100/500	14.53/c
JSQ9	81069	1/2-13	13/16	7/16	2.90	50/250	77.23/c NEW

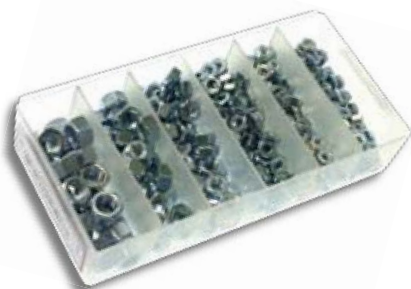

HEXAGON NUT KIT

STEEL ZINC CHROMATE

Six popular sizes!

STOCK NO.	UPC NO.	DESCRIPTION OF CONTENTS	STD. PKG./MSTR. CARTON	WEIGHT EACH	SUGGESTED TRADE LIST PRICE PER
NK1	10506	400 pcs - Hexagon Nuts 100 - 6-32, 100 - 8-32, 100 - 10-32, 50 - 1/4-20, 30 - 5/16-18, 20 - 3/8-16	1/25	1.92	18.80/ea kit

MASTER PLUG® SYSTEM

THREADED INSERT-FASTENING, SEALING, CUSHIONING SYSTEM



ADAPTABILITY

- Fastens blind holes and closed-end holes
- Cushions and seals similar and non-similar materials
- Absorbs vibration and seals both sides
- Tapered design enhances fastening installation
- Won't crack with ozone and ultraviolet exposure

VERSATILITY

- Removable and re-insertable
- Installs with conventional tools
- Works as a system with MASTER SEAL® washers
- Flange thickness always in proportion to size
- Grip range covers all dimensions

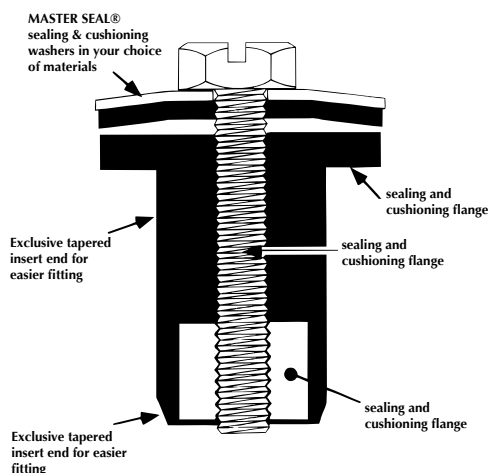

MASTER PLUG® IS A REGISTERED TRADEMARK
MASTER SEAL® IS A REGISTERED TRADEMARK

FOR STEEL BUILDING CONSTRUCTION

PACKAGED IN A PLASTIC BOX

STOCK NO.	UPC NO.	SIZE	BODY DIA.	OVERALL LENGTH	FLANGE O.D.	FLANGE THICKNESS	STD. PKG.	WT. PER PKG.	SUGGESTED TRADE LIST PRICE PER
MPS10	10383	6-32L	.250	1.062	.500	.062	25	.14	19.03/ ea pkg
MPS11	10384	10-32S	.375	.625	.562	.062	25	.20	19.13/ ea pkg
MPS12	10385	10-32R	.375	1.062	.562	.062	25	.16	22.50/ ea pkg
MPS13	10386	1/4-20S	.500	.855	.875	.090	20	.13	19.03/ ea pkg
MPS14	10387	1/4-20R	.500	1.276	.875	.100	15	.19	16.98/ ea pkg

PACKAGED IN A POLY BAG

STOCK NO.	UPC NO.	SIZE	BODY DIA.	OVERALL LENGTH	FLANGE O.D.	FLANGE THICKNESS	STD. PKG.	WT. PER PKG.	SUGGESTED TRADE LIST PRICE PER
MPS15	10388	6-32L	.250	1.062	.500	.062	100	.58	57.08/c
MPS16	10389	10-32S	.375	.625	.562	.062	100	.50	57.43/c
MPS17	10390	10-32R	.375	1.062	.562	.062	100	.56	67.43/c
MPS18	10391	1/4-20S	.500	.855	.875	.090	100	.94	71.50/c
MPS19	10392	1/4-20R	.500	1.276	.875	.100	100	1.18	84.93/c



WASHER KITS

Three styles in assorted sizes.
Flat - Lock

STOCK NO.	UPC NO.	DESCRIPTION OF CONTENTS	STD. PKG./MSTR. CARTON	WEIGHT EACH	SUGGESTED TRADE LIST PRICE PER
STEEL ZINC CHROMATE					
SWK1	10507	485 pcs - Flat Washers 100 - #6, 100 - #8, 100 - #10 75 - 1/4 50 - 5/16 35 - 3/8 25 - 1/2	1/25	1.93	17.13/ ea kit
STEEL ZINC CHROMATE					
LWK1	10508	425 pcs - Split Lock Washers 100 - #8, 100 - #10, 100 - 1/4 60 - 5/16 40 - 3/8 25 - 1/2	1/25	1.32	15.10/ea kit
18-8 TYPE STAINLESS STEEL					
SSWK1	90216	485 pcs - Flat Washers 100 - #6, 100 - #8, 100 - #10 75 - 1/4 50 - 5/16 35 - 3/8 25 - 1/2	1/25	1.93	27.70/ ea kit NEW



FLAT WASHERS

DESIGNED FOR METAL-TO-METAL APPLICATION

NOW IN MORE SIZES OF SILICON BRONZE, BRASS, STAINLESS, GALVANIZED, AND NYLON

STOCK NO.	UPC NO.	I.D./O.D.	BOLT SIZE	WT. PER PKG.	STD. PKG./MSTR. SLEEVE	SUGGESTED TRADE LIST PRICE PER
STEEL ZINC CHROMATE						
JSW68	71968	1/8 X 5/16	4	.14	100/500	4.78/c NEW
JSW70	80498	5/32 X 3/8	6	.17	100/500	2.53/c
JSW71	80499	3/16 X 7/16	8	.20	100/500	2.60/c
JSW72	80500	7/32 X 1/2	10	.26	100/500	2.93/c
JSW73	80501	9/32 X 5/8	1/4	.52	100/500	3.10/c
JSW74	80502	11/32 X 11/16	5/16	.60	100/500	4.08/c
JSW75	80503	13/32 X 13/16	3/8	.78	100/500	5.88/c
JSW79	86379	15/32 X 59/64	7/16	1.04	100/500	18.63/c NEW
JSW76	80504	17/32 X 1 1/16	1/2	1.71	100/500	10.73/c
JSW77	80505	21/32 X 1 5/16	5/8	2.60	100/500	16.25/c
JSW78	80506	13/16 X 1 1/2	3/4	4.22	100	25.55/c
JSW82	71982	15/16 X 1 3/4	7/8	5.98	100	60.88/c NEW
JSW80	71980	1 1/16 X 2	1	8.49	100	112.25/c NEW
STAINLESS STEEL 18-8 TYPE						
JSSW8	81278	5/32 X 3/8	6	.13	100/500	4.18/c NEW
JSSW10	80507	3/16 X 7/16	8	.12	100/500	4.90/c
JSSW11	80508	7/32 X 1/2	10	.22	100/500	5.50/c
JSSW12	80509	9/32 X 5/8	1/4	.40	100/500	7.80/c
JSSW13	80510	11/32 X 11/16	5/16	.49	100/500	9.53/c
JSSW14	80511	13/32 X 13/16	3/8	.61	100/500	13.58/c
JSSW20	81327	15/32 X 59/64	7/16	.77	100/500	26.78/c
JSSW15	80512	17/32 X 1 1/16	1/2	1.40	100/500	33.95/c NEW
JSSW17	81324	21/32 X 1 5/16	5/8	2.00	100	64.78/c NEW

OTHER SIZES AND QUANTITIES AVAILABLE BY REQUEST

CONTINUED ON NEXT PAGE



CONTINUED FLAT WASHERS

DESIGNED FOR METAL-TO-METAL APPLICATION

NOW IN MORE SIZES OF SILICON BRONZE, BRASS, STAINLESS, GALVANIZED AND NYLON

STOCK NO.	UPC NO.	I.D./O.D.	BOLT SIZE	WT. PER PKG.	STD. PKG./MSTR. SLEEVE	SUGGESTED TRADE LIST PRICE PER	
NEW 316 TYPE STAINLESS STEEL							
JSSW121	89521	9/32 x 5/8	1/4	.39	100/500		NEW
JSSW131	89531	11/32 x 11/16	5/16	.50	100/500	PLEASE CALL FOR TRADE LIST PRICING	NEW
JSSW141	89541	13/32 x 13/16	3/8	.65	100/500		NEW
JSSW18	81325	15/32 x 59/64	7/16	1.30	100/500		NEW
JSSW151	89551	17/32 x 1 1/16	1/2	1.62	100/500		NEW
JSSW171	89571	21/32 x 1 5/16	5/8	2.85	100		NEW
JSSW201	89772	13/16 x 1 1/2	3/4	6.17	100		NEW
SILICON BRONZE							
JSBW6	80513	5/32 x 3/8	6	.22	100/500	12.15/c	
JSBW8	80514	3/16 x 7/16	8	.13	100/500	14.35/c	
JSBW36	80515	7/32 x 1/2	10	.21	100/500	16.90/c	
JSBW14	80516	9/32 x 5/8	1/4	.45	100/500	24.40/c	
JSBW516	80517	11/32 x 11/16	5/16	.72	100/500	45.55/c	
JSBW38	80518	13/32 x 13/16	3/8	.92	100/500	56.60/c	
JSBW12	80519	17/32 x 1 1/16	1/2	2.40	100/500	138.48/c	
JSBW58	84345	21/32 x 1 5/16	5/8	3.86	100	376.90/c	NEW
BRASS							
JSWBR6	80520	5/32 x 3/8	6	.10	100/500	4.28/c	
JSWBR8	80521	3/16 x 7/16	8	.14	100/500	5.60/c	
JSWBR16	80522	7/32 x 1/2	10	.25	100/500	7.05/c	
JSWBR14	80523	9/32 x 5/8	1/4	.27	100/500	15.55/c	
JSWBR38	85838	13/32 x 13/16	3/8	0.92	100/500	48.50/c	NEW
JSWBR12	81812	17/32 x 1 1/16	1/2	2.40	100/500	165.92/c	NEW
NEW GALVANIZED							
JSW73G	84173	9/32 x 5/8	1/4	.68	100/500	11.85/c	NEW
JSW75G	84175	13/32 x 13/16	3/8	1.67	100/500	12.95/c	NEW
JSW76G	84176	17/32 x 1 1/16	1/2	3.71	100/500	36.43/c	NEW
JSW77G	84177	21/32 x 1 5/16	5/8	1.79	50	58.10/c	NEW
NEW NYLON							
JSWN1	71911	7/32 x 1/2	10	.40	100/500	76.62/c	NEW
JSWN73	72273	9/32 x 5/8	1/4	.10	50/250	77.40/c	NEW
JSWN74	89705	11/32 x 11/16	5/16	.70	50	78.10/c	NEW



USS FLAT WROUGHT WASHERS

STEEL ZINC CHROMATE
A strong, heavy-duty washer

STOCK NO.	UPC NO.	I.D./O.D.	BOLT SIZE	WT. PER PKG.	STD. PKG./MSTR. SLEEVE	SUGGESTED TRADE LIST PRICE PER	
JWW80	80524	5/16 x 3/4	1/4	.72	100/500	3.75/c	
JWW81	80525	3/8 x 7/8	5/16	1.22	100/500	5.78/c	
JWW82	80526	7/16 x 1	3/8	1.46	100/500	10.45/c	
JWW83	80527	9/16 x 1 3/8	1/2	3.47	100	17.20/c	
JWW84	80528	11/16 x 1 3/4	5/8	6.72	100	33.60/c	
JWW85	80529	13/16 x 2	3/4	4.84	50	45.76/c	
JWW87	84395	1 1/16 x 2 1/2	1	3.90	25	58.40/c	NEW

OTHER SIZES AND QUANTITIES AVAILABLE BY REQUEST

WASHERS



GRADE 8 FLAT WROUGHT WASHERS

HARDENED STEEL ZINC CHROMATE

For use with Grade 5 and Grade 8 Bolts and Nuts

STOCK NO.	UPC NO.	I.D./O.D.	BOLT SIZE	WT. PER PKG.	STD. PKG./MSTR. SLEEVE	SUGGESTED TRADE LIST PRICE PER
JG8WW80	80530	5/16 X 3/4	1/4	.66	100/500	13.93/c
JG8WW81	80531	3/8 X 7/8	5/16	.59	100/500	19.28/c
JG8WW82	80532	7/16 X 1	3/8	1.18	100/500	23.68/c
JG8WW87	81443	1/2 X 1 1/4	7/16	1.91	100/500	64.75/c NEW
JG8WW83	80533	9/16 X 1 3/8	1/2	3.77	100	65.50/c
JG8WW86	81442	1 1/16 X 1 3/4	5/8	7.16	100	158.75/c NEW
JG8WW85	81441	1 3/16 X 2	3/4	6.62	100	212.15/c NEW
JG8WW84	81439	1 5/16 X 2 1/4	7/8	13.07	100	274.53/c NEW

OTHER SIZES AND QUANTITIES AVAILABLE BY REQUEST



FINISHING WASHERS

STEEL NICKEL PLATED

STOCK NO.	UPC NO.	SIZE	BOLT SIZE	WT. PER PKG.	STD. PKG./MSTR. SLEEVE	SUGGESTED TRADE LIST PRICE PER
STEEL NICKEL PLATED						
JCW10	80555	6	1/8	.11	100/500	3.70/c
JCW11	80556	8	5/32	.16	100/500	5.83/c
JCW12	80557	10	3/16	.16	100/500	6.68/c
JCW14	80558	12	7/32	.26	100/500	11.08/c
NEW STAINLESS STEEL 18-8 TYPE						
JCW12SS	81304	10	3/16	.17	100/500	7.43/c NEW

OTHER SIZES AND QUANTITIES AVAILABLE BY REQUEST



CONICAL WASHERS (Belleville)

STAINLESS STEEL 18-8 TYPE

Load bearing tension type applications

STOCK NO.	UPC NO.	I.D./O.D.	BOLT SIZE	WT. PER PKG.	STD. PKG./MSTR. SLEEVE	SUGGESTED TRADE LIST PRICE PER
JBWSS14	81691	5/16 X 3/4	1/4	.17	100/500	28.88/c NEW
JBWSS38	81676	7/16 X 3/4	3/8	.48	100/500	42.20/c
JBWSS12	81675	1 7/32 X 1 1/8	1/2	1.00	100/500	74.08/c
JBWSS34	81671	2 5/32 X 1 5/16	3/4	2.10	100	199.75/c NEW

OTHER SIZES AND QUANTITIES AVAILABLE BY REQUEST



JAR DISPLAY CENTER
Holds 18 Jars



ATTENTION
ON LARGE ORDERS OF ANCHOR KITS —
OUR PRICE CAN BE EVEN LOWER!

50 KITS

Order two master cartons of this kit and receive an added **10% Discount!**

QUANTITY DISCOUNTS:
10% DISCOUNT ON 50-99 LIKE KITS
OR
15% DISCOUNT ON 100+ LIKE KITS

Please Call Us for Co-Labeling on Kits!



FENDER WASHERS

STEEL ZINC CHROMATE AND STAINLESS STEEL
A larger diameter for greater bearing surface.

STOCK NO.	UPC NO.	I.D./O.D.	BOLT SIZE	WT. PKG.	STD. PKG./MSTR. SLEEVE	SUGGESTED TRADE LIST PRICE PER	
STEEL ZINC CHROMATE							
JW110	82896	3/16 x 3/4	3/16	.49	100/500	19.50/c	NEW
JW112	80534	3/16 x 1	3/16	1.64	100/500	6.63/c	
JW111	80535	3/16 x 1 1/4	3/16	2.06	100/500	8.00c	
JW126	82912	1/4 x 7/8	1/4	1.22	100/500	7.85/c	NEW
JW113	80536	1/4 x 1	1/4	1.35	100/500	6.23/c	
JW116	80537	1/4 x 1 1/4	1/4	2.09	100/500	7.88/c	
JW114	80538	1/4 x 1 1/2	1/4	3.06	100	11.28/c	
JW122	80539	1/4 x 2	1/4	5.43	100	31.10/c	
JW115	80540	5/16 x 1 1/4	5/16	2.30	100/500	11.28/c	
JW118	80541	5/16 x 1 1/2	5/16	2.94	100/500	15.88/c	
JW127	80542	3/8 x 1	3/8	1.24	100/500	9.60/c	
JW119	80543	3/8 x 1 1/4	3/8	2.33	100/500	10.93/c	
JW117	80544	3/8 x 1 1/2	3/8	3.20	100	11.33/c	
JW123	80545	3/8 x 2	3/8	6.43	100	28.73/c	
JW120	80546	1/2 x 1 3/8	1/2	3.37	100	16.73/c	
JW1201	80547	1/2 x 1 1/2	1/2	2.56	100	18.95/c	
JW121	80548	1/2 x 2	1/2	5.18	100	27.70/c	
18-8 TYPE STAINLESS STEEL							
JW112SS	90733	3/16 x 1	3/16	1.65	100/500	22.05/c	NEW
JW111SS	90751	3/16 x 1 1/4	3/16	2.05	100/500	27.19/c	NEW
JW113SS	80549	1/4 x 1	1/4	.95	100/500	24.25/c	
JW116SS	80550	1/4 x 1 1/4	1/4	1.51	100/500	34.65/c	
JW114SS	80551	1/4 x 1 1/2	1/4	2.82	100	60.63/c	
JW115SS	90752	5/16 x 1 1/4	5/16	1.46	100/500	60.63/c	NEW
JW118SS	80552	5/16 x 1 1/2	5/16	2.75	100/500	65.85/c	
JW127SS	90761	3/8 x 1	3/8	0.91	100/500	37.90/c	NEW
JW119SS	90753	3/8 x 1 1/4	3/8	1.37	100/500	38.75/c	NEW
JW117SS	80553	3/8 x 1 1/2	3/8	1.36	50	38.90/c	NEW
JW123SS	90757	3/8 x 2	3/8	2.34	100	81.75/c	NEW
JW120SS	90754	1/2 x 1 3/8	1/2	3.10	100	86.25/c	NEW
JW1201SS	90762	1/2 x 1 1/2	1/2	2.49	100	86.85/c	NEW
JW121SS	80554	1/2 x 2	1/2	5.18	50	91.00/c	
NEW 316 TYPE STAINLESS STEEL							
JW1141SS	91513	1/4 x 1 1/2	1/4	3.06	100/500	PLEASE CALL FOR TRADE LIST PRICING	NEW
JW1221SS	91494	1/4 x 2	1/4	3.16	100/500		NEW
JW1171SS	91489	3/8 x 1 1/2	3/8	2.33	100/500		NEW
JW1231SS	91495	3/8 x 2	3/8	6.43	100		NEW
JW12011SS	91480	1/2 x 1 1/2	1/2	2.65	100		NEW

OTHER SIZES AND QUANTITIES AVAILABLE BY REQUEST



OCTAGONAL WASHERS NEW!

STOCK NO.	UPC NO.	I.D./O.D.	BOLT SIZE	WT. PKG.	STD. PKG./MSTR. SLEEVE	SUGGESTED TRADE LIST PRICE PER 100	
JHFW114	90015	1/4 x 1 1/2	1/4	2.53	100	30.87/c	NEW
JHFW117	90017	3/8 x 1 1/2	3/8	2.53	100	29.93/c	NEW

OTHER SIZES AND QUANTITIES AVAILABLE BY REQUEST

WASHERS



FENDER WASHER KIT

STEEL ZINC CHROMATE

STOCK NO.	UPC NO.	DESCRIPTION OF CONTENTS	STD. PKG./ MSTR. CARTON	WEIGHT EACH	SUGGESTED TRADE LIST PRICE PER
FWK10	13050	180 pcs - Fender Washers 30 - 3/16 X 1, 3/16 X 1 1/4, 1/4 X 1, 1/4 X 1 1/4, 3/8 X 1, 3/8 X 1 1/4	1/25	3.02	20.48/ea kit



SPLIT LOCKWASHERS

Now in more sizes of Steel Zinc, Stainless, 316 Stainless - Silicon Bronze - Galvanized - Nylon

STOCK NO.	UPC NO.	SIZE	BOLT SIZE	WT. PER PKG.	STD. PKG. MSTR. SLEEVE	SUGGESTED TRADE LIST PRICE PER	
STEEL ZINC CHROMATE							
JLW167	81844	4	7/64	.08	100/500	3.58/c NEW	
JLW169	80583	6	1/8	.10	100/500	2.38/c	
JLW170	80584	8	5/32	.11	100/500	2.43/c	
JLW171	80585	10	3/16	.13	100/500	2.53/c	
JLW153	81830	12	13/64	.17	100/500	3.35c NEW	
JLW172	80586	1/4	1/4	.26	100/500	2.68/c	
JLW173	80587	5/16	5/16	.45	100/500	3.13/c	
JLW174	80588	3/8	3/8	.66	100/500	4.73/c	
JLW178	81894	7/16	7/16	.95	100/500	6.38/c NEW	
JLW175	80589	1/2	1/2	1.29	100/500	6.75/c	
JLW176	80590	5/8	5/8	2.54	100/500	15.90/c	
JLW177	80591	3/4	3/4	3.67	100	33.78/c	
18-8-TYPE STAINLESS STEEL							
JSLW4	71774	6	1/8	.08	100/500	2.88/c NEW	
JSLW5	80592	8	5/32	.10	100/500	3.83/c	
JSLW6	80593	10	3/16	.13	100/500	4.28/c	
JSLW12	84188	12	13/64	.16	100/500	6.00/c NEW	
JSLW7	80594	1/4	1/4	.31	100/500	7.60/c	
JSLW8	80595	5/16	5/16	.44	100/500	11.50/c	
JSLW9	80596	3/8	3/8	.69	100/500	16.98/c	
JSLW11	84187	7/16	7/16	.95	100/500	27.35/c NEW	
JSLW10	80597	1/2	1/2	1.40	100/500	33.48/c	
JSLW92	84892	5/8	5/8	3.32	100/500	59.55/c NEW	
NEW 316 TYPE STAINLESS STEEL							
JSLW71	72771	1/4	1/4	.28	100/500	PLEASE CALL FOR TRADE LIST PRICING	NEW
JSLW81	84881	5/16	5/16	.45	100/500		NEW
JSLW91	84891	3/8	3/8	.68	100/500		NEW
JSLW111	92991	7/16	7/16	1.01	100		NEW
JSLW101	92981	1/2	1/2	.67	50		NEW
SILICON BRONZE							
JBLW6	84160	6	1/8	.10	100/500	3.83/c	
JBLW8	84161	8	5/32	.11	100/500	4.40/c	
JBLW178	80598	10	3/16	.13	100/500	4.25/c	
JBLW14	80599	1/4	1/4	.32	100/500	12.03/c	
JBLW516	80600	5/16	5/16	.47	100/500	18.33/c	

OTHER SIZES AND QUANTITIES AVAILABLE BY REQUEST

CONTINUED ON NEXT PAGE

CONTINUED

SPLIT LOCKWASHERS



STOCK NO.	UPC NO.	SIZE	BOLT SIZE	WT. PER PKG.	STD. PKG./MSTR. SLEEVE	SUGGESTED TRADE LIST PRICE PER	
SILICON BRONZE							
JBLW38	80601	3/8	3/8	.75	100/500	28.53/c	
JBLW12	80602	1/2	1/2	1.41	100/500	36.83/c	
JBLW58	84350	5/8	5/8	2.86	100	109.75/c	NEW
JBLW34	76334	3/4	3/4	3.77	100	251.35/c	NEW
NEW GALVANIZED							
JLW172G	82961	1/4	1/4	.71	100/500	14.20/c	NEW
JLW174G	82963	3/8	3/8	.74	100/500	15.95/c	NEW
JLW175G	82964	1/2	1/2	1.08	100/500	30.08/c	NEW
JLW176G	82965	5/8	5/8	2.62	100/500	49.75/c	NEW
NEW NYLON							
JLWN7	71707	1/4	1/4	.09	50	378.00/c	NEW

ALSO AVAILABLE IN A HANDY KIT, SEE PAGE 60!
OTHER SIZES AND QUANTITIES AVAILABLE BY REQUEST.



EXTERNAL TOOTH LOCK WASHERS

STOCK NO.	UPC NO.	SIZE	BOLT SIZE	WT. PER PKG.	STD. PKG./MSTR. SLEEVE	SUGGESTED TRADE LIST PRICE PER	
STEEL ZINC CHROMATE							
JLWX1	82521	4	7/64	.03	100/500	3.55/c	NEW
JLWX3	80603	6	1/8	.07	100/500	2.38/c	
JLWX4	80604	8	5/32	.09	100/500	2.43/c	
JLWX5	80605	10	3/16	.10	100/500	2.53/c	
JLWX12	81505	12	7/32	.12	100/500	12.60/c	NEW
JLWX6	80606	1/4	1/4	.13	100/500	2.68/c	
JLWX7	80607	5/16	5/16	.15	100/500	3.13/c	
JLWX8	80608	3/8	3/8	.24	100/500	4.73/c	
JLWX9	80609	1/2	1/2	.39	100/500	6.75/c	
NEW 18-8 TYPE STAINLESS STEEL							
JLWX3SS	92953	6	1/8	.08	100/500	PLEASE CALL FOR TRADE LIST PRICING	NEW
JLWX4SS	92954	8	5/32	.09	100/500		NEW
JLWX5SS	92955	10	3/16	.16	100/500		NEW
JLWX6SS	92956	1/4	1/4	.13	100/500		NEW
JLWX8SS	92958	3/8	3/8	.19	100/500		NEW
JLWX9SS	92959	1/2	1/2	.36	100/500		NEW

OTHER SIZES AND QUANTITIES AVAILABLE BY REQUEST



INTERNAL TOOTH LOCK WASHERS

STOCK NO.	UPC NO.	SIZE	BOLT SIZE	WT. PER PKG.	STD. PKG./MSTR. SLEEVE	SUGGESTED TRADE LIST PRICE PER	
STEEL ZINC CHROMATE							
JLWI3	83650	6	1/8	.10	100/500	2.38/c	
JLWI4	83652	8	5/32	.10	100/500	2.43/c	
JLWI5	83654	10	3/16	.10	100/500	2.53/c	
JLWI6	83656	1/4	1/4	.10	100/500	2.68/c	
JLWI7	83658	5/16	5/16	.17	100/500	3.13/c	
JLWI8	83660	3/8	3/8	.23	100/500	4.73/c	
JLWI9	83662	1/2	1/2	.38	100/500	6.75/c	
NEW 18-8 TYPE STAINLESS STEEL							
JLWIX4SS	97004	8	5/32	.04	100/500	PLEASE CALL FOR TRADE LIST PRICING	NEW
JLWIX5SS	97005	10	3/16	.09	100/500		NEW

OTHER SIZES AND QUANTITIES AVAILABLE BY REQUEST

WASHERS



REDUCING WASHERS

ELECTRO-GALVANIZED STEEL

Designed to reduce larger knockouts to accept smaller connectors



STOCK NO.	UPC NO.	I.D./O.D.	WT. PER PKG.	STD. PKG/MSTR. SLEEVE	SUGGESTED TRADE PRICE PER
JR100	80559	1/2 x 3/4	.92	100/500	15.33/c
JR101	80560	1/2 x 1	1.60	100/500	20.20/c
JR102	80561	3/4 x 1	1.34	100/500	20.20/c
JR103	80562	1/2 x 1 1/4	1.25	50/250	31.96/c
JR104	80563	3/4 x 1 1/4	1.11	50/250	31.96/c
JR105	80564	1 x 1 1/4	.80	50/250	31.96/c
JR106	80565	1/2 x 1 1/2	2.11	50/250	39.16/c
JR107	80566	3/4 x 1 1/2	2.12	50/250	41.50c
JR108	80567	1 x 1 1/2	2.01	50/250	41.50/c
JR109	80568	1 1/4 x 1 1/2	1.42	50	41.50c
JR110	80569	1/2 x 2	3.54	50	50.30/c
JR111	80570	3/4 x 2	3.05	50	50.30/c
JR112	80571	1 x 2	3.30	50	50.30/c
JR113	80572	1 1/4 x 2	2.98	50	50.30/c
JR114	80573	1 1/2 x 2	2.63	50	50.30/c
JR115	80574	3/4 x 2 1/2	4.74	50	145.06/c
JR116	80575	1 x 2 1/2	4.22	50	145.06c
JR117	80576	1 1/4 x 2 1/2	3.10	50	145.06/c
JR118	80577	1 1/2 x 2 1/2	3.09	50	145.06/c
JR119	80578	2 x 2 1/2	2.22	50	145.06/c
JR120	80579	2 x 3	2.50	25	246.60/c
JR121	80580	2 x 3 1/2	1.50	10	544.00/c
JR122	80581	2 1/2 x 4	1.75	10	710.80/c
JR123	80582	3 x 4	2.10	10	710.80/c



Steel Building Construction

MASTER SEAL®

SEALING AND CUSHIONING WASHERS

Provides an affordable alternative to pre-assembled construction fasteners

GALVANIZED AND STAINLESS



STOCK NO.	KIT UPC NO.	DESCRIPTION	SUGGESTED TRADE LIST PRICE PER KIT
MSWP120	12694	120 pcs - Plastic Box of Assorted Steel Galvanized Washers containing a total of 120 pieces. 20 each of #6, #8-10, #12, 1/4", 5/16", and 3/8"	8.44/ea kit

STOCK NO.	UPC NO.	DESCRIPTION	SIZE (INT. DIA.)	OVERALL DIAMETER	STD. PKG.	WT. PER PKG.	SUGGESTED TRADE LIST PRICE PER
JMSW20	82375	Galvanized Steel	6	3/8	100	.18	5.03/c
JMSW21	82376	Galvanized Steel	8-10	1/2	100	.26	5.13/c
JMSW22	82377	Galvanized Steel	12	9/16	100	.32	6.35/c
JMSW23	82378	Galvanized Steel	1/4	5/8	100	.36	6.70/c
JMSW24	82379	Galvanized Steel	5/16	3/4	100	.47	9.88/c
JMSW25	82380	Galvanized Steel	3/8	3/4	100	.40	9.88/c
JMSWS30	82381	Stainless Steel	8-10	1/2	100	.26	13.55/c
JMSWS31	82382	Stainless Steel	12-1/4	5/8	100	.38	17.65/c

MASTER SEAL® IS A REGISTERED TRADEMARK

GALVANIZED



GRADE 2 HEXAGON CAP SCREWS

STEEL ZINC CHROMATE AND GALVANIZED



STEEL ZINC CHROMATE

STOCK NO.	UPC NO.	SIZE	LENGTH	WT. PER PKG.	STD. PKG./MSTR. SLEEVE	SUGGESTED TRADE LIST PRICE PER
STEEL ZINC CHROMATE						
JBHC11	80610	1/4-20	1/2	1.24	100/500	6.10/c
JBHC48	80611	1/4-20	5/8	1.32	100/500	7.23/c
JBHC1	80612	1/4-20	3/4	1.47	100/500	7.40/c
JBHC2	80613	1/4-20	1	1.72	100/500	8.25/c
JBHC49	80614	1/4-20	1 1/4	2.11	100	9.50/c
JBHC3	80615	1/4-20	1 1/2	2.47	100	10.73/c
JBHC50	80616	1/4-20	1 3/4	2.82	100	12.40/c
JBHC4	80617	1/4-20	2	3.15	100	12.60/c
JBHC5	80618	1/4-20	2 1/2	3.86	100	16.30/c
JBHC6	80619	1/4-20	3	4.45	100	18.80/c
JBHC7	80620	1/4-20	3 1/2	3.92	100	23.85/c
JBHC8	80621	1/4-20	4	5.95	100	27.13/c
JBHC9	80622	1/4-20	4 1/2	6.66	100	32.90/c
JBHC10	82140	1/4-20	5	7.41	100	54.23/c NEW
JBHC53	82179	1/4-20	5 1/2	8.00	100	58.33/c NEW
JBHC12	82142	1/4-20	6	8.75	100	62.28/c NEW
JBHC101	82221	5/16-18	5/8	2.18	100/500	15.63/c NEW
JBHC42	80623	5/16-18	3/4	2.48	100/500	10.73/c
JBHC43	80624	5/16-18	1	2.83	100/500	12.88/c
JBHC54	80625	5/16-18	1 1/4	3.31	100/500	14.45/c
JBHC13	80626	5/16-18	1 1/2	3.91	100	15.38/c
JBHC14	80627	5/16-18	2	4.98	100	19.88/c
JBHC15	80628	5/16-18	2 1/2	6.09	100	22.83/c
JBHC16	80629	5/16-18	3	7.11	100	27.05/c
JBHC20	82150	5/16-18	5	5.77	100	74.40/c NEW
JBHC58	82180	5/16-18	5 1/2	12.00	100	79.55/c NEW
JBHC22	82152	5/16-18	6	13.15	50	84.70/c NEW
JBHC88	80630	3/8-16	1/2	2.86	100/500	12.45/c
JBHC44	80631	3/8-16	3/4	3.80	100	14.83/c
JBHC45	80632	3/8-16	1	4.20	100	19.13/c
JBHC59	80633	3/8-16	1 1/4	4.75	100	19.40/c
JBHC23	80634	3/8-16	1 1/2	5.60	100	23.40/c
JBHC60	80635	3/8-16	1 3/4	6.47	100	27.63/c
JBHC24	80636	3/8-16	2	7.31	100	28.88/c
JBHC61	80637	3/8-16	2 1/4	3.99	50	31.26/c
JBHC25	80638	3/8-16	2 1/2	4.39	50	33.90/c
JBHC26	80639	3/8-16	3	5.19	50	40.40/c
JBHC27	80640	3/8-16	3 1/2	6.02	50	43.96/c
JBHC28	82157	3/8-16	4	6.75	50	55.56/c
JBHC29	82158	3/8-16	4 1/2	7.23	50	52.56/c
JBHC30	82159	3/8-16	5	8.24	50	100.60/c NEW
JBHC63	82183	3/8-16	5 1/2	18.09	50	108.03/c NEW
JBHC32	82161	3/8-16	6	16.23	50	116.25/c NEW

OTHER SIZES AND QUANTITIES AVAILABLE BY REQUEST

CONTINUED ON NEXT PAGE

BOLTS

GALVANIZED



CONTINUED GRADE 2 HEXAGON CAP SCREWS

STEEL ZINC CHROMATE AND GALVANIZED



STOCK NO.	UPC NO.	SIZE	LENGTH	WT. PER PKG.	STD. PKG./MSTR. SLEEVE	SUGGESTED TRADE LIST PRICE PER	
STEEL ZINC CHROMATE							
JBHC93	82212	7/16-14	1	5.83	100	67.13/c	NEW
JBHC94	82213	7/16-14	1 1/4	6.80	100	73.25/c	NEW
JBHC95	82214	7/16-14	1 1/2	8.18	100	79.11/c	NEW
JBHC96	82215	7/16-14	2	9.06	100	85.33/c	NEW
JBHC97	82216	7/16-14	2 1/2	10.02	100	91.36/c	NEW
JBHC98	82217	7/16-14	3	12.75	100	94.90/c	NEW
JBHC99	82218	7/16-14	3 1/2	15.66	100	107.43/c	NEW
JBHC86	82205	1/2-13	3/4	7.39	100	43.48/c	NEW
JBHC46	80641	1/2-13	1	4.25	50	34.56/c	
JBHC64	80642	1/2-13	1 1/4	4.82	50	39.26/c	
JBHC47	80643	1/2-13	1 1/2	5.53	50	41.66/c	
JBHC65	80644	1/2-13	1 3/4	5.85	50	47.16/c	
JBHC33	80645	1/2-13	2	6.85	50	53.36/c	
JBHC66	80646	1/2-13	2 1/4	7.46	50	58.36/c	
JBHC34	80647	1/2-13	2 1/2	8.23	50	63.46/c	
JBHC67	80648	1/2-13	2 3/4	8.75	50	71.50/c	
JBHC35	80649	1/2-13	3	9.50	50	72.16/c	
JBHC36	82175	1/2-13	3 1/2	5.57	25	81.40/c	
JBHC37	82176	1/2-13	4	6.25	25	87.40/c	
JBHC38	82167	1/2-13	4 1/2	27.00	25	139.05/c	NEW
JBHC39	82168	1/2-13	5	29.80	25	153.38/c	NEW
JBHC68	82185	1/2-13	5 1/2	32.05	25	168.10/c	NEW
JBHC41	82170	1/2-13	6	33.24	25	182.28/c	NEW
JBHC21	80650	5/8-11	1	7.79	50	59.80/c	
JBHC31	80651	5/8-11	1 1/2	9.23	50	61.90/c	
JBHC69	82186	5/8-11	2	10.94	50	71.86/c	
JBHC71	80653	5/8-11	2 1/2	13.30	50	82.90/c	
JBHC73	80654	5/8-11	3	15.15	50	96.06/c	
JBHC75	80655	5/8-11	3 1/2	7.02	25	129.52/c	
JBHC76	82193	5/8-11	4	9.18	25	133.20/c	
JBHC80	82197	5/8-11	5	10.80	25	202.63/c	NEW
JBHC7612	82202	3/4-10	1 1/2	14.37	50	135.30/c	
JBHC77	82194	3/4-10	2	17.05	50	159.80/c	
JBHC79	82196	3/4-10	2 1/2	17.88	50	170.56/c	
JBHC81	82181	3/4-10	3	23.60	50	201.96/c	
JBHC83	82203	3/4-10	3 1/2	12.24	25	242.80/c	
JBHC85	82204	3/4-10	4	17.50	25	267.12/c	
NEW GALVANIZED							
JBHC1G	85601	1/4-20	3/4	1.57	100/500	24.38/c	NEW
JBHC2G	85602	1/4-20	1	1.85	100/500	48.44/c	NEW
JBHC45G	85645	3/8-16	1	4.83	100	55.82/c	NEW
JBHC23G	85623	3/8-16	1 1/2	5.60	100	95.68/c	NEW
JBHC24G	85624	3/8-16	2	6.12	100	98.72/c	NEW
JBHC46G	85646	1/2-13	1	2.13	100	121.18/c	NEW
JBHC33G	85633	1/2-13	2 1/2	26.31	100	242.37/c	NEW
JBHC36G	85636	1/2-13	3 1/2	7.43	25	688.52/c	NEW

OTHER SIZES AND QUANTITIES AVAILABLE BY REQUEST



GRADE 5 HEXAGON CAP SCREWS

HARDENED STEEL ZINC CHROMATE

A hardened steel bolt for lower grade structural use
To be used with Grade 5 nuts and washers



STOCK NO.	UPC NO.	SIZE	BOLT SIZE	WT. PER PKG.	STD. PKG./MSTR. SLEEVE	SUGGESTED TRADE LIST PRICE PER
JG5HC11	80656	1/4-20	1/2	1.25	100/500	7.55/c
JG5HC1	80657	1/4-20	3/4	1.49	100/500	9.90/c
JG5HC21	82099	1/4-20	7/8	1.62	100/500	13.25/c NEW
JG5HC2	80658	1/4-20	1	1.75	100/500	11.83/c
JG5HC49	80659	1/4-20	1 1/4	2.15	100/500	13.85/c
JG5HC3	80660	1/4-20	1 1/2	2.44	100	17.05c
JG5HC4	80661	1/4-20	2	3.17	100	20.15/c
JG5HC5	80662	1/4-20	2 1/2	3.75	100	21.90/c
JG5HC6	80663	1/4-20	3	4.53	100	25.60/c
JG5HC7	80664	1/4-20	3 1/2	5.16	100	29.55/c
JG5HC8	80665	1/4-20	4	5.94	100	34.93/c
JG5HC42	80666	5/16-18	3/4	2.45	100/500	14.18/c
JG5HC41	83280	5/16-18	7/8	2.92	100/500	19.95/c NEW
JG5HC43	80667	5/16-18	1	2.85	100/500	16.13/c
JG5HC13	80668	5/16-18	1 1/2	3.87	100	21.20/c
JG5HC14	80669	5/16-18	2	4.97	100	27.45/c
JG5HC15	80670	5/16-18	2 1/2	6.10	100	32.78/c
JG5HC16	80671	5/16-18	3	7.11	100	39.20/c
JG5HC18	80672	5/16-18	3 1/2	4.28	50	49.06/c
JG5HC20	80673	5/16-18	4	4.72	50	56.16/c
JG5HC88	80674	3/8-16	1/2	2.88	100/500	17.70/c
JG5HC44	80675	3/8-16	3/4	3.51	100/500	21.78/c
JG5HC45	80676	3/8-16	1	4.19	100	25.53/c
JG5HC59	80677	3/8-16	1 1/4	4.84	100	29.95/c
JG5HC23	80678	3/8-16	1 1/2	5.53	100	34.08/c
JG5HC24	80679	3/8-16	2	7.20	100	43.50/c
JG5HC29	82827	3/8-16	2 1/4	7.82	100	44.38/c NEW
JG5HC25	80680	3/8-16	2 1/2	4.41	50	46.36/c
JG5HC26	80681	3/8-16	3	5.20	50	59.20/c
JG5HC27	82825	3/8-16	3 1/2	5.91	50	63.90/c
JG5HC28	82826	3/8-16	4	6.87	50	76.56/c
JG5HC119	76219	7/16-14	1	3.60	50	41.65/c NEW
JG5HC123	76223	7/16-14	1 1/4	3.73	50	58.55/c NEW
JG5HC120	82098	7/16-14	1 1/2	3.95	50	58.75/c NEW
JG5HC121	76221	7/16-14	2	4.15	50	66.46/c NEW
JG5HC122	76222	7/16-14	2 1/2	5.12	50	75.86/c NEW
JG5HC81	82881	1/2-13	3/4	3.73	50	56.40/c NEW
JG5HC46	80682	1/2-13	1	4.23	50	50.46/c
JG5HC64	80683	1/2-13	1 1/4	4.73	50	58.30/c
JG5HC47	80684	1/2-13	1 1/2	5.41	50	74.60/c
JG5HC33	80685	1/2-13	2	6.61	50	78.30/c
JG5HC12	82083	1/2-13	2 1/4	7.52	50	90.06/c NEW
JG5HC34	80686	1/2-13	2 1/2	8.11	50	96.76/c

OTHER SIZES AND QUANTITIES AVAILABLE BY REQUEST

CONTINUED ON NEXT PAGE

BOLTS

CONTINUED

GRADE 5 HEXAGON CAP SCREWS

HARDENED STEEL ZINC CHROMATE

A hardened steel bolt for lower grade structural use
To be used with Grade 5 nuts and washers



STOCK NO.	UPC NO.	SIZE	BOLT SIZE	WT. PER PKG.	STD. PKG./MSTR. SLEEVE	SUGGESTED TRADE LIST PRICE PER
JG5HC67	80687	1/2-13	2 ³ / ₄	8.87	50	124.40/c
JG5HC35	80688	1/2-13	3	9.14	50	98.50/c
JG5HC36	80689	1/2-13	3 ¹ / ₂	5.40	25	115.72/c
JG5HC37	82837	1/2-13	4	5.94	25	130.20/c
JG5HC38	82838	1/2-13	5	6.94	25	283.48/c NEW
JG5HC60	82853	5/8-11	1	3.96	25	92.94/c NEW
JG5HC62	80690	5/8-11	1 ¹ / ₂	4.65	50	98.30/c
JG5HC63	80691	5/8-11	2	11.07	50	117.46/c
JG5HC66	82859	5/8-11	2 ¹ / ₂	13.30	50	137.90/c
JG5HC68	82862	5/8-11	3	15.38	50	160.46/c
JG5HC70	82870	5/8-11	3 ¹ / ₂	10.80	50	176.56/c
JG5HC72	82872	5/8-11	4	20.00	50	212.26/c
JG5HC73	82873	5/8-11	4 ¹ / ₂	6.67	25	372.60/c NEW
JG5HC75	82875	5/8-11	5	7.82	25	406.80/c NEW
JG5HC74	80694	3/4-10	1 ¹ / ₂	5.30	50	188.00/c
JG5HC76	82874	3/4-10	2	6.47	50	200.46/c
JG5HC78	82877	3/4-10	2 ¹ / ₂	7.88	50	222.90/c
JG5HC80	82880	3/4-10	3	10.41	50	253.80/c
JG5HC82	82883	3/4-10	3 ¹ / ₂	12.50	50	286.00/c
JG5HC84	82886	3/4-10	4	13.10	50	318.26/c
JG5HC85	82885	3/4-10	5	5.72	20	691.25/c NEW

OTHER SIZES AND QUANTITIES AVAILABLE BY REQUEST

GRADE 8 HEXAGON CAP SCREWS

HARDENED STEEL ZINC CHROMATE

The highest grade hardened steel structural bolt that we carry!
To be used with Grade 8 nuts and washers



STOCK NO.	UPC NO.	SIZE	BOLT SIZE	WT. PER PKG.	STD. PKG./MSTR. SLEEVE	SUGGESTED TRADE LIST PRICE PER
JG8HC1	80698	1/4-20	3/4	1.53	100/500	13.35/c
JG8HC2	80699	1/4-20	1	1.74	100/500	14.23/c
JG8HC114	90555	1/4-20	1 ¹ / ₄	2.10	100/500	20.18/c NEW
JG8HC3	80700	1/4-20	1 ¹ / ₂	2.46	100/500	18.53/c
JG8HC4	80701	1/4-20	2	3.07	100	27.63/c
JG8HC5	80702	1/4-20	2 ¹ / ₂	1.99	50	30.60/c
JG8HC6	80703	1/4-20	3	2.28	50	43.90/c
JG8HC8	83216	1/4-20	4	2.95	50	60.76/c
JG8HC42	80704	5/16-18	3/4	2.46	100/500	19.50/c
JG8HC17	83235	5/16-18	7/8	2.65	100/500	24.75/c NEW
JG8HC43	80705	5/16-18	1	2.87	100/500	21.65/c
JG8HC13	80706	5/16-18	1 ¹ / ₂	3.93	100	31.43/c
JG8HC14	80707	5/16-18	2	5.00	100	43.50/c
JG8HC15	80708	5/16-18	2 ¹ / ₂	3.10	50	52.10/c
JG8HC16	83234	5/16-18	3	3.67	50	61.66/c
JG8HC20	83237	5/16-18	4	4.56	50	89.16/c

OTHER SIZES AND QUANTITIES AVAILABLE BY REQUEST

CONTINUED ON NEXT PAGE

CONTINUED

GRADE 8 HEXAGON CAP SCREWS

HARDENED STEEL ZINC CHROMATE

The highest grade hardened steel structural bolt that we carry!
To be used with Grade 8 nuts and washers



STOCK NO.	UPC NO.	SIZE	BOLT SIZE	WT. PER PKG.	STD. PKG./MSTR. SLEEVE	SUGGESTED TRADE LIST PRICE PER
JG8HC2334	80710	3/8-16	3/4	3.59	100/500	24.98/c
JG8HC231	80711	3/8-16	1	4.36	100	28.75/c
JG8HC214	90565	3/8-16	1 1/4	4.78	100	34.80/c NEW
JG8HC23	80712	3/8-16	1 1/2	5.58	100	40.30/c
JG8HC24	80713	3/8-16	2	3.62	50	50.36/c
JG8HC25	80714	3/8-16	2 1/2	4.37	50	65.26/c
JG8HC26	83255	3/8-16	3	5.06	50	72.46/c
JG8HC28	83258	3/8-16	4	6.60	50	96.70/c
JG8HC76114	90647	7/16-14	1 1/4	3.84	100	70.10/c NEW
JG8HC76112	90645	7/16-14	1 1/2	6.70	50	88.36/c NEW
JG8HC46	83261	1/2-13	1	4.24	50	67.20/c
JG8HC48	83287	1/2-13	1 1/4	4.75	50	70.93/c NEW
JG8HC47	81037	1/2-13	1 1/2	2.73	25	75.60/c
JG8HC33	83267	1/2-13	2	3.36	25	102.72/c
JG8HC34	83270	1/2-13	2 1/2	4.08	25	122.12/c
JG8HC35	83273	1/2-13	3	4.66	25	148.32/c
JG8HC37	83276	1/2-13	4	5.81	25	180.52/c
JG8HC38	83277	1/2-13	4 1/2	6.80	25	274.00/c NEW
JG8HC583	90595	5/8-11	3	15.50	50	253.20/c NEW
JG8HC58312	90615	5/8-11	3 1/2	16.74	50	321.20/c NEW
JG8HC584	90596	5/8-11	4	17.43	50	376.56/c NEW
JG8HC58412	90625	5/8-11	4 1/2	21.95	50	408.46/c NEW
JG8HC343	90575	3/4-10	3	9.28	20	526.15/c NEW
JG8HC34312	90605	3/4-10	3 1/2	10.5	20	573.15/c NEW



HEXAGON CAP SCREWS

18-8 TYPE STAINLESS STEEL



STOCK NO.	UPC NO.	SIZE	LENGTH	WT. PER PKG.	STD. PKG./MSTR. SLEEVE	SUGGESTED TRADE LIST PRICE PER
JSBH11	80719	1/4-20	1/2	1.23	100/500	18.93/c
JSBH5	83569	1/4-20	5/8	1.34	100/500	21.38/c NEW
JSBH1	80720	1/4-20	3/4	1.49	100/500	23.85/c
JSBH2	80721	1/4-20	1	1.75	100/500	26.65/c
JSBH49	80722	1/4-20	1 1/4	2.12	100/500	32.73/c
JSBH3	80723	1/4-20	1 1/2	2.44	100	40.40/c
JSBH4	83568	1/4-20	2	3.23	100	57.38/c NEW
JSBH51	83615	1/4-20	2 1/4	3.64	100	70.33/c NEW
JSBH41	83605	1/4-20	2 1/2	3.89	100	73.08/c NEW
JSBH412	93312	1/4-20	3	4.42	100	74.98/c NEW
JSBH86	80724	5/16-18	1/2	2.03	100/500	38.40/c
JSBH42	80725	5/16-18	3/4	2.41	100/500	42.43/c
JSBH43	80726	5/16-18	1	2.85	100/500	53.40/c
JSBH54	80727	5/16-18	1 1/4	3.28	100/500	60.13/c
JSBH13	80728	5/16-18	1 1/2	3.92	100	62.03/c

OTHER SIZES AND QUANTITIES AVAILABLE BY REQUEST

CONTINUED ON NEXT PAGE



CONTINUED HEXAGON CAP SCREWS

18-8 TYPE STAINLESS STEEL



STOCK NO.	JAR UPC NO.	SIZE	LENGTH	WT. PER PKG.	STD. PKG./MSTR. SLEEVE	SUGGESTED TRADE LIST PRICE PER
JSBH12	80729	5/16-18	1 3/4	4.50	100	82.83/c
JSBH14	80730	5/16-18	2	5.01	100	85.98/c
JSBH15	80731	5/16-18	2 1/2	6.14	100	97.18/c
JSBH16	80732	5/16-18	3	7.14	100	114.05/c
JSBH17	80733	5/16-18	3 1/2	8.30	100	150.65/c
JSBH88	80734	3/8-16	1/2	2.94	100/500	81.18/c
JSBH44	80735	3/8-16	3/4	3.57	100	59.18/c
JSBH48	80736	3/8-16	7/8	3.83	100	64.65/c
JSBH45	80737	3/8-16	1	4.19	100	64.65/c
JSBH59	80738	3/8-16	1 1/4	1.11	100	73.83/c
JSBH23	80739	3/8-16	1 1/2	5.65	100	84.80/c
JSBH24	80740	3/8-16	2	7.24	100	113.35/c
JSBH25	83589	3/8-16	2 1/2	4.12	50	200.86/c NEW
JSBH26	83590	3/8-16	3	5.23	50	324.46/c NEW
JSBH28	83592	3/8-16	3 1/2	6.41	50	347.11/c NEW
JSBH29	83593	3/8-16	4	6.77	50	441.00/c NEW
JSBH30	83594	3/8-16	5	8.39	50	425.00/c NEW
JSBH32	83596	3/8-16	6	9.51	50	431.38/c NEW
JSBH71	83635	7/16-14	1	5.72	100	78.45/c NEW
JSBH22	83586	7/16-14	1 1/4	6.71	100	99.25/c NEW
JSBH82	83646	7/16-14	1 1/2	7.31	100	149.63/c NEW
JSBH502	94302	7/16-14	2	6.02	50	192.36/c NEW
JSBH503	94303	7/16-14	2 1/2	4.99	50	298.70/c NEW
JSBH74	83638	7/16-14	4	8.23	50	427.25/c NEW
JSBH81	80741	1/2-13	3/4	7.22	100	138.23/c
JSBH46	80742	1/2-13	1	4.29	50	154.26/c
JSBH64	80743	1/2-13	1 1/4	4.80	50	155.96/c
JSBH47	80744	1/2-13	1 1/2	5.44	50	157.40/c
JSBH65	80745	1/2-13	1 3/4	5.91	50	196.50/c
JSBH33	80746	1/2-13	2	6.85	50	252.66/c
JSBH34	80747	1/2-13	2 1/2	8.20	50	274.90/c
JSBH35	80748	1/2-13	3	9.48	50	374.40/c
JSBH356	94156	1/2-13	3 1/4	11.26	50	393.40/c NEW
JSBH350	94150	1/2-13	3 1/2	10.94	50	485.00/c NEW
JSBH355	94155	1/2-13	4	12.31	50	602.60/c NEW
JSBH359	91459	1/2-13	4 1/2	13.64	50	603.25/c NEW
JSBH37	83601	1/2-13	5	14.42	50	605.38/c NEW
JSBH19	83583	1/2-13	5 1/2	8.32	25	737.52/c NEW
JSBH913	95113	5/8-11	1	8.62	50	242.80/c NEW
JSBH912	95112	5/8-11	1 1/2	9.28	50	448.06/c NEW
JSBH93	83665	5/8-11	2	10.99	50	535.60/c NEW
JSBH94	83664	5/8-11	2 1/2	13.16	50	643.76/c NEW
JSBH96	83667	5/8-11	3	15.35	50	659.20/c NEW
JSBH800	95000	5/8-11	3 1/2	8.81	25	860.00/c NEW
JSBH801	95001	5/8-11	4	9.99	25	978.60/c NEW
JSBH808	95008	5/8-11	6	12.53	25	1184.52/c NEW
JSBH91	83661	3/4-10	1	24.75	100	398.13/c NEW
JSBH90	83659	3/4-10	1 1/2	26.63	100	410.20/c NEW

OTHER SIZES AND QUANTITIES AVAILABLE BY REQUEST



HEXAGON CAP SCREWS NEW!

316 TYPE STAINLESS STEEL



STOCK NO.	UPC NO.	SIZE	LENGTH	WT. PER PKG.	STD. PKG./MSTR. SLEEVE	SUGGESTED TRADE LIST PRICE PER
JSBH231	98231	1/4-20	3/4	1.49	100	NEW
JSBH234	98234	1/4-20	1	1.77	100	NEW
JSBH491	93391	1/4-20	1 1/4	2.09	100	NEW
JSBH236	98236	1/4-20	1 1/2	2.52	100	NEW
JSBH238	98238	1/4-20	2	3.19	100	NEW
JSBH411	93311	1/4-20	2 1/2	3.82	100	NEW
JSBH611	94611	1/4-20	3	1.90	100	NEW
JSBH421	93321	5/16-18	3/4	2.53	100	NEW
JSBH435	93335	5/16-18	1	2.85	100	NEW
JSBH541	94341	5/16-18	1 1/4	3.38	100	NEW
JSBH131	96331	5/16-18	1 1/2	3.92	100	NEW
JSBH142	96342	5/16-18	2	4.99	100	NEW
JSBH252	98252	3/8-16	1	4.20	100	NEW
JSBH253	98253	3/8-16	1 1/4	4.85	100	NEW
JSBH254	98254	3/8-16	1 1/2	5.71	100	NEW
JSBH255	98255	3/8-16	2	7.37	100	NEW
JSBH552	94352	7/16-14	1	5.95	100	NEW
JSBH811	95011	1/12-13	3/4	7.13	100	NEW
JSBH332	94132	1/12-13	1	8.55	100	NEW
JSBH336	94136	1/12-13	1 1/4	9.71	100	NEW
JSBH337	94137	1/12-13	1 1/2	10.76	100	NEW
JSBH339	94139	1/12-13	2	13.76	100	NEW
JSBH334	94134	1/12-13	2 1/4	7.87	50	NEW
JSBH341	94141	1/12-13	2 1/2	8.20	50	NEW
JSBH351	94151	1/2-13	3	9.94	50	NEW
JSBH353	94153	1/2-13	3 1/2	11.32	50	NEW
JSBH354	12354	1/2-13	4	12.64	50	NEW
JSBH670	94670	5/8-11	1	15.31	100	NEW
JSBH671	94671	5/8-11	1 1/4	16.71	100	NEW
JSBH672	94672	5/8-11	1 1/2	18.71	100	NEW
JSBH674	94674	5/8-11	2	22.82	50	NEW
JSBH941	95141	5/8-11	2 1/2	13.57	50	NEW
JSBH961	95161	5/8-11	3	15.55	50	NEW
JSBH680	94680	5/8-11	3 1/2	17.88	50	NEW
JSBH990	95190	3/4-10	1	24.46	100	NEW
JSBH991	95191	3/4-10	1 1/2	29.66	100	NEW
JSBH992	95192	3/4-10	2	35.12	100	NEW
JSBH951	95151	3/4-10	2 1/2	20.67	50	NEW
JSBH981	95181	3/4-10	3	23.78	50	NEW
JSBH760	94960	3/4-10	3 1/2	26.89	50	NEW

PLEASE
CALL
FOR
TRADE
LIST
PRICING



OTHER SIZES AND QUANTITIES AVAILABLE BY REQUEST

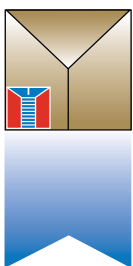

METALLICS

AMERICA'S SOURCE FOR PREMIER AND INNOVATIVE FASTENERS & ANCHORS

BOLTS



HEXAGON CAP SCREWS

SILICON BRONZE

STOCK NO.	UPC NO.	SIZE	LENGTH	WT. PER PKG.	STD. PKG./MSTR. SLEEVE	SUGGESTED TRADE LIST PRICE PER
JBBH11	80749	1/4-20	1/2	1.30	100/500	
JBBH48	84948	1/4-20	5/8	1.28	100/500	NEW
JBBH1	80750	1/4-20	3/4	1.64	100/500	
JBBH2	80751	1/4-20	1	1.92	100/500	
JBBH19	84919	1/4-20	1 1/4	2.14	100/500	
JBBH3	80752	1/4-20	1 1/2	2.48	100/500	
JBBH4	84904	1/4-20	2	3.04	100	NEW
JBBH51	84951	1/4-20	2 1/4	3.52	100	NEW
JBBH5	84905	1/4-20	2 1/2	3.66	100	NEW
JBBH6	84906	1/4-20	3	4.22	100	NEW
JBBH7	84907	1/4-20	3 1/2	4.78	100	NEW
JBBH8	84908	1/4-20	4	5.34	100	NEW
JBBH42	84942	5/16-18	3/4	2.60	100	NEW
JBBH43	80753	5/16-18	1	3.27	100	NEW
JBBH54	84954	5/16-18	1 1/4	4.23	100	NEW
JBBH13	84913	5/16-18	1 1/2	4.62	100	NEW
JBBH14	84914	5/16-18	2	4.99	100	NEW
JBBH56	84956	5/16-18	2 1/4	5.32	100	NEW
JBBH15	84915	5/16-18	2 1/2	5.53	100	NEW
JBBH16	84916	5/16-18	3	6.29	100	NEW
JBBH17	84917	5/16-18	3 1/2	6.93	100	NEW
JBBH18	84918	5/16-18	4	7.25	100	NEW
JBBH88	80754	3/8-16	1/2	3.60	100/500	
JBBH44	80755	3/8-16	3/4	3.92	100/500	
JBBH45	80756	3/8-16	1	4.55	100	
JBBH59	84959	3/8-16	1 1/4	5.25	100	NEW
JBBH23	80757	3/8-16	1 1/2	5.96	100	
JBBH24	80758	3/8-16	2	7.29	100	
JBBH61	84961	3/8-16	2 1/4	8.02	100	NEW
JBBH25	84925	3/8-16	2 1/2	8.73	100	NEW
JBBH26	84926	3/8-16	3	6.31	50	NEW
JBBH27	84927	3/8-16	3 1/2	6.82	50	NEW
JBBH28	84928	3/8-16	4	6.62	50	NEW
JBBH29	84929	3/8-16	4 1/2	7.15	50	NEW
JBBH30	84930	3/8-16	5	3.91	25	NEW
JBBH32	84932	3/8-16	6	4.26	25	NEW
JBBH81	80759	1/2-13	3/4	8.11	100	
JBBH46	80760	1/2-13	1	4.71	50	
JBBH64	80761	1/2-13	1 1/4	5.31	50	
JBBH47	80762	1/2-13	1 1/2	5.87	50	
JBBH65	80763	1/2-13	1 3/4	6.54	50	
JBBH33	80764	1/2-13	2	7.17	50	
JBBH34	80765	1/2-13	2 1/2	8.38	50	
JBBH35	80766	1/2-13	3	9.64	50	
JBBH36	84936	1/2-13	3 1/2	10.87	50	NEW
JBBH37	84937	1/2-13	4	12.29	50	NEW
JBBH38	84938	1/2-13	4 1/2	13.35	50	NEW

PLEASE
CALL
FOR
TRADE
LIST
PRICING

OTHER SIZES AND QUANTITIES AVAILABLE BY REQUEST

CONTINUED ON NEXT PAGE



CONTINUED
HEXAGON CAP SCREWS
 SILICON BRONZE

STOCK NO.	UPC NO.	SIZE	LENGTH	WT. PER PKG.	STD. PKG./ MSTR. SLEEVE	SUGGESTED TRADE LIST PRICE PER	
JBBH39	84939	1/2-13	5	8.76	25	PLEASE CALL FOR TRADE LIST PRICING	NEW
JBBH41	84941	1/2-13	6	9.23	25		NEW
JBBH80	85080	5/8-11	1	16.37	100		NEW
JBBH82	84320	5/8-11	1 1/2	18.43	100		NEW
JBBH69	84969	5/8-11	2	24.35	100		NEW
JBBH71	84971	5/8-11	2 1/2	25.07	100		NEW
JBBH73	84973	5/8-11	3	28.71	100		NEW
JBBH75	84975	5/8-11	3 1/2	32.26	50		NEW
JBBH76	84976	5/8-11	4	35.72	50		NEW
JBBH84	84984	5/8-11	4 1/2	39.35	50		NEW
JBBH85	84985	5/8-11	5	42.75	25		NEW
JBBH86	84986	3/4-10	1 1/2	19.48	50		NEW
JBBH77	84977	3/4-10	2	19.88	50		NEW
JBBH78	84978	3/4-10	2 1/4	19.95	50		NEW
JBBH79	84979	3/4-10	2 1/2	20.18	50		NEW
JBBH87	84987	3/4-10	3	22.00	50		NEW
JBBH89	84989	3/4-10	3 1/2	24.55	50		NEW
JBBH90	84490	3/4-10	4	54.01	50		NEW

OTHER SIZES AND QUANTITIES AVAILABLE BY REQUEST



HEX TAP BOLTS
 FULL THREADED STEEL ZINC CHROMATE AND STAINLESS STEEL 18-8 TYPE
 For complete thread engagement applications

STOCK NO.	UPC NO.	DIAMETER	LENGTH	WT. PER PER PKG.	STD. PKG./ MSTR. SLEEVE	SUGGESTED TRADE LIST PRICE PER	
STEEL ZINC CHROMATE							
JHTB11	80767	1/4-20	1/2	1.23	100/500	6.38/c	
JHTB1	80768	1/4-20	3/4	1.48	100/500	7.03/c	
JHTB2	80769	1/4-20	1	1.72	100/500	8.88/c	
JHTB49	80770	1/4-20	1 1/4	2.07	100/500	10.00/c	
JHTB3	80771	1/4-20	1 1/2	2.33	100/500	10.40/c	
JHTB4	80772	1/4-20	2	2.84	100	12.78/c	
JHTB82	82804	1/4-20	2 1/2	3.39	100	41.95/c	NEW
JHTB6	82458	1/4-20	3	3.38	100	42.75/c	NEW
JHTB56	82778	1/4-20	4	4.97	100	45.53/c	NEW
JHTB61	82783	1/4-20	5	5.95	100	68.45/c	NEW
JHTB5	82739	1/4-20	6	6.27	100	99.80/c	NEW
JHTB38	82760	5/16-18	3/4	2.39	100	12.58/c	NEW
JHTB39	82761	5/16-18	1	2.84	100	17.18/c	NEW
JHTB54	82507	5/16-18	1 1/4	3.30	100	18.20/c	NEW
JHTB13	82746	5/16-18	1 1/2	3.65	100	27.48/c	NEW
JHTB42	82764	5/16-18	2	4.49	100	28.08/c	NEW
JHTB43	82765	5/16-18	2 1/2	5.82	100	29.45/c	NEW
JHTB55	82777	5/16-18	3	3.17	50	35.70/c	NEW
JHTB88	80773	3/8-16	1/2	2.88	100/500	12.40/c	
JHTB90	82812	3/8-16	5/8	3.28	100	16.15/c	NEW
JHTB44	80774	3/8-16	3/4	3.82	100	14.70/c	

OTHER SIZES AND QUANTITIES AVAILABLE BY REQUEST

CONTINUED ON NEXT PAGE

BOLTS



CONTINUED

HEX TAP BOLTS

FULL THREADED STEEL ZINC CHROMATE AND STAINLESS STEEL 18-8 TYPE
For complete thread engagement applications

STOCK NO.	UPC NO.	DIAMETER	LENGTH	WT. PER PKG.	STD. PKG./MSTR. SLEEVE	SUGGESTED TRADE LIST PRICE PER
STEEL ZINC CHROMATE						
JHTB45	80775	3/8-16	1	4.29	100	18.80/c
JHTB59	80776	3/8-16	1 1/4	4.93	100	21.50/c
JHTB23	80777	3/8-16	1 1/2	5.43	100	24.45/c
JHTB24	80778	3/8-16	2	6.75	100	29.15/c
JHTB25	80779	3/8-16	2 1/2	3.97	50	33.76/c
JHTB26	80780	3/8-16	3	4.46	50	40.20/c
JHTB60	82513	3/8-16	4	5.76	50	59.50/c NEW
JHTB93	82815	7/16-14	1	6.19	100	64.56/c NEW
JHTB81	80781	1/2-13	3/4	3.78	50	29.06/c
JHTB46	80782	1/2-13	1	4.30	50	34.96/c
JHTB64	80783	1/2-13	1 1/4	4.85	50	36.30/c
JHTB47	80784	1/2-13	1 1/2	5.47	50	40.96/c
JHTB33	80785	1/2-13	2	6.62	50	53.36/c
JHTB34	80786	1/2-13	2 1/2	7.62	50	63.06/c
JHTB35	80787	1/2-13	3	8.69	50	71.86/c
JHTB48	82501	1/2-13	4	5.56	25	108.50/c NEW
JHTB94	82816	5/8-11	3/4	8.11	25	319.40/c NEW
JHTB89	82811	5/8-11	2	24.36	25	675.25/c NEW
JHTB71	82793	5/8-11	2 1/2	6.45	25	677.20/c NEW
JHTB72	82794	5/8-11	2 3/4	6.89	25	752.00/c NEW
JHTB73	82795	5/8-11	3	7.31	25	810.00/c NEW
NEW STAINLESS STEEL 18-8 TYPE						
JSHTB11	86011	1/4-20	1/2	1.23	100	NEW
JSHTB1	86001	1/4-20	3/4	1.41	100	NEW
JSHTB2	86002	1/4-20	1	1.85	100	NEW
JSHTB49	86049	1/4-20	1 1/4	2.03	100	NEW
JSHTB3	86003	1/4-20	1 1/2	2.33	100	NEW
JSHTB4	86004	1/4-20	2	2.84	100	NEW
JSHTB41	86041	1/4-20	2 1/2	3.17	100	NEW
JSHTB42	86042	1/4-20	3	3.72	100	NEW
JSHTB44	86044	3/8-16	3/4	3.59	100	NEW
JSHTB45	86045	3/8-16	1	4.20	100	NEW
JSHTB59	86059	3/8-16	1 1/4	4.84	100	NEW
JSHTB23	86023	3/8-16	1 1/2	5.50	100	NEW
JSHTB24	86024	3/8-16	2	6.73	100	NEW
JSHTB25	86025	3/8-16	2 1/2	7.94	100	NEW
JSHTB26	86026	3/8-16	3	9.24	100	NEW
JSHTB60	86060	3/8-16	4	11.77	100	NEW
JSHTB46	86046	1/2-13	1	4.32	50	NEW
JSHTB48	86048	1/2-13	1 1/4	9.71	100	NEW
JSHTB47	86047	1/2-13	1 1/2	6.00	50	NEW
JSHTB33	86033	1/2-13	2	6.35	50	NEW
JSHTB34	86034	1/2-13	2 1/2	15.75	50	NEW
JSHTB35	86035	1/2-13	3	8.72	50	NEW
JSHTB36	86036	1/2-13	3 1/2	4.47	25	NEW

PLEASE
CALL
FOR
TRADE
LIST
PRICING

OTHER SIZES AND QUANTITIES AVAILABLE BY REQUEST



CARRIAGE BOLTS

STEEL ZINC CHROMATE, STAINLESS STEEL 18-8 TYPE AND GALVANIZED

STOCK NO.	UPC NO.	SIZE	LENGTH	WT. PER PKG.	STD. PKG./MSTR. SLEEVE	SUGGESTED TRADE LIST PRICE PER	
STEEL ZINC CHROMATE							
JCB42	83000	1/4-20	1/2	1.34	100/500	7.40/c	
JCB1	83001	1/4-20	3/4	1.66	100/500	8.73/c	
JCB2	83002	1/4-20	1	2.08	100/500	13.75/c	
JCB3	83003	1/4-20	1 1/2	2.33	100/500	14.73/c	
JCB4	83006	1/4-20	2	2.85	100	17.78/c	
JCB6	83010	1/4-20	3	4.09	100	25.78/c	
JCB36	83070	1/4-20	4 1/2	5.48	100	40.63/c	NEW
JCB31	83055	1/4-20	6	1.89	25	53.75/c	NEW
JCB21	76721	5/16-18	2 1/2	5.51	100	67.15/c	NEW
JCB55	83041	3/8-16	3/4	4.25	100/500	26.90/c	
JCB56	83042	3/8-16	1	4.77	100	29.78/c	
JCB23	83044	3/8-16	1 1/2	6.02	100	37.15/c	
JCB24	83046	3/8-16	2	3.61	50	45.70/c	
JCB25	83048	3/8-16	2 1/2	4.28	50	61.70/c	
JCB26	83050	3/8-16	3	4.98	50	55.40/c	
JCB28	83052	3/8-16	4	6.10	50	70.26/c	
JCB29	76729	3/8-16	5	3.61	25	124.50/c	NEW
JCB40	83074	3/8-16	6	8.42	50	131.55/c	NEW
JCB30	83054	3/8-16	8	11.05	50	162.75/c	NEW
JCB33	83065	1/2-13	2	3.07	25	78.00/c	
JCB34	83067	1/2-13	2 1/2	4.05	25	87.60/c	
JCB35	83069	1/2-13	3	4.72	25	103.40/c	
JCB8	76708	1/2-13	6	33.38	25	145.75/c	NEW
JCB9	83013	1/2-13	8	9.92	25	250.00/c	NEW
NEW STAINLESS STEEL 18-8 TYPE							
JCB42SS	91742	1/4-20	1/2	2.09	100	PLEASE CALL FOR TRADE LIST PRICING	NEW
JCB1SS	91701	1/4-20	3/4	1.68	100		NEW
JCB2SS	91702	1/4-20	1	2.10	100		NEW
JCB7SS	91707	1/4-20	2 1/2	2.93	100		NEW
JCB56SS	91756	5/16-18	1 1/2	3.94	100		NEW
JCB55SS	91755	3/8-16	3/4	4.14	100		NEW
JCB23SS	91723	3/8-16	1 1/2	6.01	100		NEW
JCB24SS	91724	3/8-16	2	3.64	50		NEW
JCB26SS	91726	3/8-16	3	4.95	50		NEW
JCB101SS	94701	1/2-13	1 1/2	4.98	50		NEW
NEW GALVANIZED							
JCB33G	769334	1/2-13	2	13.96	25		NEW

OTHER SIZES AND QUANTITIES AVAILABLE BY REQUEST

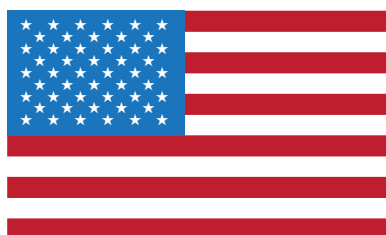

METALLICS

“Growth Through Innovation”

We believe Metallics has the largest ratio of American made to foreign produced product of any other American fastener company.

BOLTS

STEEL ZINC
CHROMATE

GALVANIZED



HEXAGON LAG BOLTS

STEEL ZINC CHROMATE,
STAINLESS STEEL 18-8 TYPE AND GALVANIZED

STOCK NO.	UPC NO.	SIZE	LENGTH	WT. PER PKG.	STD. PKG. MSTR. SLEEVE	SUGGESTED TRADE LIST PRICE PER
STEEL ZINC CHROMATE						
JBLS37	80788	1/4	1	1.55	100	12.60/c
JBLS38	80789	1/4	1 1/4	1.70	100	13.45/c
JBLS1	80790	1/4	1 1/2	1.98	100	13.60/c
JBLS39	80791	1/4	1 3/4	2.29	100	15.10/c
JBLS2	80792	1/4	2	2.62	100	15.60/c
JBLS3	80793	1/4	2 1/2	3.12	100	19.30/c
JBLS4	80794	1/4	3	3.64	100	20.83/c
JBLS5	80795	1/4	3 1/2	4.10	100	23.15/c
JBLS6	82308	1/4	4	4.58	100	25.18/c
JBLS40	76440	1/4	4 1/2	5.25	100	27.63/c NEW
JBLS8	76408	1/4	5	5.49	100	33.57/c NEW
JBLS10	76410	1/4	6	6.51	100	44.62/c NEW
JBLS41	76441	5/16	1	2.87	100	33.78/c NEW
JBLS42	76442	5/16	1 1/4	2.91	100	34.58/c NEW
JBLS11	80796	5/16	1 1/2	3.03	100	16.80/c
JBLS12	80797	5/16	2	3.72	100	18.48/c
JBLS13	80798	5/16	2 1/2	4.78	100	21.13/c
JBLS14	80799	5/16	3	5.59	100	23.00/c
JBLS15	82312	5/16	3 1/2	3.19	50	31.25/c NEW
JBLS16	82324	5/16	4	3.81	50	28.90/c
JBLS44	76444	5/16	4 1/2	4.01	50	37.40/c NEW
JBLS18	82326	5/16	5	3.40	50	38.26/c
JBLS20	82327	5/16	6	5.61	50	47.96/c
JBLS45	80800	3/8	1	3.29	100	19.50/c
JBLS46	80801	3/8	1 1/4	3.95	100	20.45/c
JBLS36	80802	3/8	1 1/2	4.50	100	21.43/c
JBLS21	80803	3/8	2	5.50	100	25.05/c
JBLS22	80804	3/8	2 1/2	3.52	50	31.16/c
JBLS23	80805	3/8	3	4.06	50	35.60/c
JBLS24	80806	3/8	3 1/2	4.53	50	38.16/c
JBLS25	10408	3/8	4	4.89	50	48.90/c
JBLS48	76448	3/8	4 1/2	11.28	50	61.75/c NEW
JBLS26	82319	3/8	5	6.50	50	62.05/c NEW
JBLS49	76449	3/8	5 1/2	13.41	50	67.69/c NEW
JBLS27	82344	3/8	6	7.36	50	68.20/c
JBLS52	76452	3/8	7	17.63	50	88.13/c NEW
JBLS53	82369	1/2	1 1/2	4.35	50	150.63/c NEW
JBLS28	80807	1/2	2	5.41	50	155.96/c
JBLS29	76429	1/2	2 1/2	13.01	50	162.35/c NEW
JBLS30	80808	1/2	3	7.54	50	79.50/c
JBLS31	76431	1/2	3 1/2	16.98	50	85.73/c NEW
JBLS32	82353	1/2	4	4.92	25	86.72/c
JBLS50	76450	1/2	4 1/2	5.32	25	96.88/c NEW
JBLS33	76433	1/2	5	5.99	25	101.00/c NEW
JBLS51	76451	1/2	5 1/2	6.42	25	112.50/c NEW
JBLS34	82355	1/2	6	7.32	25	132.50/c NEW
JBLS88	76448	3/4	3	4.02	10	347.26/c NEW

OTHER SIZES AND QUANTITIES AVAILABLE BY REQUEST

CONTINUED ON NEXT PAGE

STEEL ZINC CHROMATE GALVANIZED



CONTINUED HEXAGON LAG BOLTS

STEEL ZINC CHROMATE,
STAINLESS STEEL 18-8 TYPE AND GALVANIZED

STOCK NO.	UPC NO.	SIZE	LENGTH	WT. PER PKG.	STD. PKG. MSTR. SLEEVE	SUGGESTED TRADE LIST PRICE PER
NEW STAINLESS STEEL 18-8 TYPE						
JBLS1SS	85001	1/4	1 1/2	1.97	100	PLEASE CALL FOR TRADE PRICING
JBLS2SS	85002	1/4	2	2.61	100	
JBLS4SS	85004	1/4	3	3.61	100	
JBLS13SS	85013	5/16	1 1/2	5.32	100	
JBLS12SS	85012	5/16	2	5.61	100	
JBLS14SS	85014	5/16	3	5.87	100	
JBLS36SS	85036	3/8	1 1/2	5.40	100	
JBLS21SS	85021	3/8	2	5.94	100	
JBLS23SS	85023	3/8	3	8.23	50	
JBLS30SS	85030	1/2	3	15.08	50	
JBLS32SS	85032	1/2	4	19.68	25	
NEW GALVANIZED						
JBLS1G	86401	1/4	1 1/2	2.58	100	38.08/c
JBLS2G	86402	1/4	2	2.78	100	39.90/c
JBLS41G	86441	5/16	1	2.48	100	60.90/c
JBLS21G	86421	3/8	2	2.91	50	55.00/c
JBLS22G	86422	3/8	2 1/2	3.50	50	55.20/c
JBLS25G	86425	3/8	4	5.34	50	86.10/c
JBLS27G	86427	3/8	6	15.34	50	163.48/c
JBLS30G	86430	1/2	1 1/2	9.34	50	100.18/c

OTHER SIZES AND QUANTITIES AVAILABLE BY REQUEST

MANUFACTURING CAPABILITIES

Diameter range #2 thru 5/16" / 1.5mm thru 8mm • Length range 1/8" thru 3" / 3.5mm thru 75mm
Materials: Steel, Brass, Stainless, Aluminum, Bronze.

NEED SCREWS...
Let Us Make Them For You!



A METALLICS AFFILIATE

P.O. Box 1600 • 231 Cross Street
Bristol, CT 06011-1600
Tel: 800-984-8945 • Fax: 800-984-8946

CAPABILITIES LIST

- PLANT SIZE:** 100,000 SQUARE FEET
- LOCATION:** Bristol, Connecticut
- EQUIPMENT:** 27 Hi-Speed Cold Headers
8 Burr-Free Screw Slotters
3 Shank Slotters
2 Pointers
14 High Speed Thread Rollers



ADDITIONAL PLANT INFO: Modern shipping facility utilizing digital scale counting machines. In-house packaging facilities - boxing, sorting, baggings. All material boxed, palletized & labeled with your needs in mind for domestic or export shipping.

SECONDARY WORK: All plating & heat treating is done on the outside and certified for your guarantee.

INFORMATION SYSTEMS: Our facility has new and upgraded Technology to meet your customers specific requirements.

BOLTS



ROUND BEND U-BOLTS

STEEL ZINC PLATED, 18-8 TYPE STAINLESS STEEL
With Hexagon Nuts

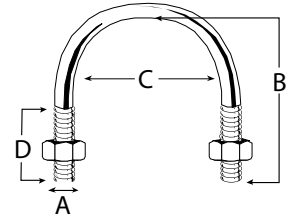

STOCK NO.	UPC NO.	THREAD DIA (A)	INSIDE LENGTH (B)	INSIDE WIDTH (C)	THREAD LENGTH (D)
-----------	---------	----------------	-------------------	------------------	-------------------

ZINC PLATED U-BOLTS WITH NUTS

UB01	25800	1/4-20	1 1/4	9/16	3/4
UB03	25810	1/4-20	2 1/4	3/4	1 1/2
UB04	25815	1/4-20	1 3/4	1	1
UB05	25820	1/4-20	2	1 1/8	1
UB06	25825	1/4-20	2 1/4	1 1/4	1 1/4
UB07	25830	1/4-20	2 3/4	1 1/2	1 3/8
UB08	25835	1/4-20	3	1 3/4	1 3/8
UB09	25840	1/4-20	3 1/4	2	1 3/8
UB010	25845	5/16-18	2 3/16	1	1 3/8
UB011	25855	5/16-18	2 3/16	1 3/8	1
UB012	25860	5/16-18	2 3/16	1 1/2	1
UB013	25865	5/16-18	2 11/16	1 3/4	1 1/8
UB014	25870	5/16-18	2 11/16	2	1
UB015	25875	5/16-18	3 3/16	2 1/2	1
UB016	25880	5/16-18	3 11/16	3	1
UB017	25885	3/8-16	2 1/4	1	1 1/4
UB018	25895	3/8-16	2 1/2	1 1/2	1 1/4
UB019	25900	3/8-16	2 3/4	1 3/4	1 1/8
UB021	25905	3/8-16	2 5/8	2	1 1/4
UB022	25910	3/8-16	3 1/8	2 1/2	1 1/4
UB023	25915	3/8-16	3 5/8	3	1 1/4
UB024	25920	3/8-16	4 1/8	3 1/2	1 1/4

STAINLESS STEEL U-BOLTS WITH NUTS 18-8 Type

UBS01	26100	1/4-20	1 1/4	9/16	3/4
UBS03	26110	1/4-20	2 1/4	3/4	1 1/2
UBS04	26115	1/4-20	1 3/4	1	1
UBS05	26120	1/4-20	2	1 1/8	1
UBS06	26125	1/4-20	2 1/4	1 1/4	1 1/4
UBS07	26130	1/4-20	2 3/4	1 1/2	1 3/8
UBS08	26135	1/4-20	3	1 3/4	1 3/8
UBS09	26140	1/4-20	3 1/4	2	1 3/8
UBS010	26145	5/16-18	2 3/16	1	1 3/8
UBS011	26150	5/16-18	2 3/16	1 3/8	1
UBS012	26155	5/16-18	2 3/16	1 1/2	1
UBS013	26160	5/16-18	2 11/16	1 3/4	1 1/8
UBS014	26165	5/16-18	2 11/16	2	1
UBS015	26170	5/16-18	3 3/16	2 1/2	1
UBS016	26175	5/16-18	3 11/16	3	1
UBS017	26180	3/8-16	2 1/4	1	1 1/4
UBS018	26190	3/8-16	2 1/2	1 1/2	1 1/4
UBS020	26195	3/8-16	2 3/4	1 3/4	1 1/8
UBS021	26200	3/8-16	2 5/8	2	1 1/4
UBS022	26205	3/8-16	3 1/8	2 1/2	1 1/4
UBS023	26210	3/8-16	3 5/8	3	1 1/4
UBS024	26215	3/8-16	4 1/8	3 1/2	1 1/4

U-BOLTS ONLY AVAILABLE BY SPECIAL QUOTATION.

MINIMUMS MAY APPLY AT THE TIME OF DISTRIBUTOR INQUIRY. GALVANIZED AVAILABLE.

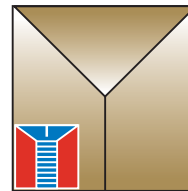

Innovative
Fasteners & Anchors:
1st Base



Highest Fill
Rates:
2nd Base



Same day Shipping:
3rd Base



Home Run!!

*"You win everytime
with Metallics"*

AMERICA'S
SOURCE FOR
PREMIER
&
INNOVATIVE
FASTENERS
&
ANCHORS

ANCHORING DEVICES

QUADRIVE CONCRETE SCREW ANCHORS

MADE IN USA



Manufactured by Avanti Screw, Inc., A Metallics Affiliate

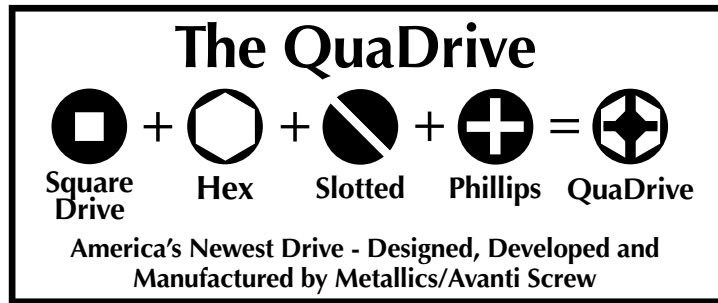

CraftCoat® 1000 coating is applied after heat-treating to provide anti-corrosion protection. CraftCoat® 1000 coating is a Rohs compliant mechanical zinc coating that offers 1000 hours to 15% red rust corrosion in salt spray testing performed to ASTM B117 specifications.

Metallics offers our Distributor/Contractor users an alternative to the blue color of standard concrete screws. Silver color is cosmetically appealing when used with zinc plated or stainless steel brackets, electrical fixtures or conduit.

CraftCoat® is a registered trademark of Donham Craft Inc.

THE METALLICS QUADRIVE CONCRETE SCREW
IT'S A RE-DESIGNED TAPPING SCREW AND ANCHORING SYSTEM WITH A CRAFTCOAT® 1000 COATING

- ← **Large fillet under head to fit $3/16$ and $1/4$ " holes provides greater driving strength**
- ← **Fluted, interrupted threads aid tapping into masonry products**
- ← **Twin lead threads for faster application**
- ← **Silver color to match conduit, strap and concrete**

We will be glad to send a sample bag of 10 pieces to our Distributors for their customer trials. Please specify size

MADE IN USA

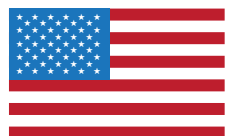

ONLY METALLICS



THE FIRST IN THE WORLD

QUADRIVE HEAD can be driven or extracted with hex, slotted, Phillips or square recess drivers.

America's Source For Premier and Innovative Fasteners & Anchors

ANCHORING DEVICES

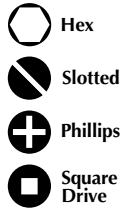

Four drives in one head



QUADRI CONCRETE SCREW KITS



STOCK NO.	UPC NO.	DESCRIPTION	WT. PER PKG.	SUGGESTED TRADE LIST PRICE PER
QCSHK1 3/16" Kit	39200	50 - 3/16 X 1 1/4 , 35 - 3/16 X 1 3/4 25 - 3/16 X 2 1/4 1 - 5/32 X 3 1/2 Masonry Drill 1 - 1/4 Drill Chuck	1.33	34.85/ea kit
QCSHK2 1/4" Kit	39204	50 - 1/4 X 1 1/4 , 35 - 1/4 X 1 3/4 25 - 1/4 X 2 1/4 1 - 3/16 X 3 1/2 Masonry Drill 1 - 5/16 Drill Chuck	2.11	44.13/ea kit

Metallics/Avanti Screw is Manufacturing

QUADRI CONCRETE SCREWS

FOUR DRIVES IN ONE HEAD
(Hex, Slotted, Phillips & Square Drives)

CRAFTCOAT® 1000

IT'S A TAPPING SCREW AND AN ANCHORING SYSTEM

WE RECOMMEND A #2 SQUARE DRIVE BIT
OR THE QUADRI DRIVE SOCKET DRIVER



Made by
Avanti Screw, Inc.,
A Metallics Affiliate

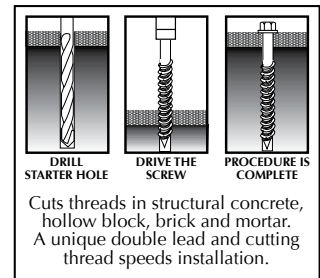

INTRODUCED IN 1999

STOCK NO.	UPC NO.	DIAMETER	LENGTH	*DRILL STOCK NO.	WT. PER PKG.	STD PKG	SUGGESTED TRADE LIST PRICE PER
INSTALL WITH 1/4" QUADRI DRIVE SOCKET DRIVER - SEE PAGE 83							
QCSH1	39145	3/16	1 1/4	CD1	.79	100	23.18/c
QCSH2	39146	3/16	1 3/4	CD1	1.12	100	24.83/c
QCSH3	39147	3/16	2 1/4	CD2	1.39	100	33.35/c
INSTALL WITH 5/16" QUADRI DRIVE SOCKET DRIVER - SEE PAGE 83							
QCSH10	39148	1/4	1 1/4	CD5	1.43	100	29.08/c
QCSH20	39149	1/4	1 3/4	CD5	1.86	100	31.20/c
QCSH30	39150	1/4	2 1/4	CD6	2.29	100	35.35/c
QCSH40	39151	1/4	2 3/4	CD6	2.77	100	42.05/c

* ONE CONCRETE SCREW MASONRY DRILL PACKAGED WITH EACH HARD BODY PAC SQUARE JAR

1000 BULK PACK IN CARTON - CONCRETE SCREWS ONLY

REMEMBER TO ORDER CONCRETE SCREW MASONRY DRILLS AND QUADRI DRIVE SOCKET DRIVER SEPARATELY

STOCK NO.	UPC NO.	DIAMETER	LENGTH	WT. PER PKG.		STD PKG	SUGGESTED TRADE LIST PRICE PER
QCSH1B	39152	3/16	1 1/4	8.30	MASONRY	1000	197.05/M
QCSH2B	39153	3/16	1 3/4	15.10	DRILLS	1000	198.05/M
QCSH3B	39154	3/16	2 1/4	18.00	NOT	1000	283.33/M
QCSH10B	39155	1/4	1 1/4	10.35	INCLUDED	1000	238.35/M
QCSH20B	39156	1/4	1 3/4	17.80	IN	1000	265.20/M
QCSH30B	39157	1/4	2 1/4	22.47	1000	1000	300.10/M
QCSH40B	39158	1/4	2 3/4	34.50	PACK	1000	357.15/M

CRAFTCOAT® IS A REGISTERED TRADEMARK OF DONHAM CRAFT, INC.



QUADRIVE SOCKET DRIVER

QUADRIVE SOCKET DRIVERS - FOR QUADRIVE CONCRETE SCREWS

STOCK NO.	UPC NO.	HEAD SIZE	LENGTH	WT. PER PKG.	STD. PKG.	SUGGESTED TRADE LIST PRICE PER
1591910	39091	1/4	2 ⁵ / ₈	.26	1	9.00/ea
1513910	39092	5/16	2 ⁵ / ₈	.53	1	9.63/ea

Safety glasses should be worn for any driving applications.

See Pages 220-222

BLUE CONCRETE SCREWS IT'S A TAPPING SCREW ANCHORING SYSTEM

One Masonry Drill Packaged with every jar.

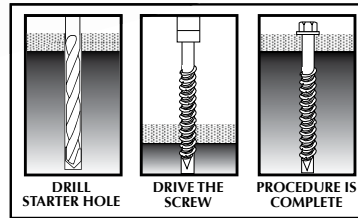

Cuts threads in structural concrete, hollow block, brick and mortar. A unique double lead and cutting thread speeds installation.

INDENTED HEX SLOTTED WASHER HEAD

STOCK NO.	UPC NO.	DIAMETER	LENGTH	DRILL STOCK NO.	WT. PER PKG.	STD PKG	SUGGESTED TRADE LIST PRICE PER
INSTALL WITH 1/4" HEX DRIVER—SEE PAGE 185							
CSH1F	87101	3/16	1 ¹ / ₄	CD1	.80	100	23.00/c NEW
CSH2F	87102	3/16	1 ³ / ₄	CD1	1.03	100	24.63/c NEW
CSH3F	87103	3/16	2 ¹ / ₄	CD2	1.32	100	33.03/c NEW
CSH4F	87104	3/16	2 ³ / ₄	CD2	1.62	100	42.50/c NEW
CSH5F	87105	3/16	3 ¹ / ₄	CD3	1.88	100	49.50/c NEW
CSH6F	87106	3/16	4	CD3	2.35	100	54.95/c NEW
INSTALL WITH 5/16" HEX DRIVER—SEE PAGE 185							
CSH10F	87110	1/4	1 ¹ / ₄	CD5	1.28	100	28.83/c NEW
CSH20F	87120	1/4	1 ³ / ₄	CD5	1.71	100	30.95/c NEW
CSH30F	87130	1/4	2 ¹ / ₄	CD6	2.14	100	35.15/c NEW
CSH40F	87140	1/4	2 ³ / ₄	CD6	2.57	100	41.78/c NEW
CSH50F	87150	1/4	3 ¹ / ₄	CD7	3.11	100	63.83/c NEW
CSH60F	87160	1/4	4	CD7	3.62	100	71.45/c NEW
CSH70F	87170	1/4	5	CD7	4.46	100	104.03/c NEW
NEW STAINLESS STEEL 410 TYPE INSTALL WITH 5/16" HEX DRIVER—SEE PAGE 185							
CSH10SS	90260	1/4	1 ¹ / ₄	CD5	1.38	100	36.40/c NEW
CSH20SS	90270	1/4	1 ³ / ₄	CD5	1.67	100	64.33/c NEW

DRILL SIZES ON PAGE 87

SAFETY GLASSES SHOULD BE WORN FOR ANY DRIVING APPLICATIONS PG. 220-222

CONTINUED ON NEXT PAGE

ANCHORING DEVICES

CONTINUED

BLUE CONCRETE SCREWS IT'S A TAPPING SCREW ANCHORING SYSTEM

One Masonry Drill Packaged with every jar.



FLAT PHILLIPS HEAD

INSTALL WITH #2 PHILLIPS BIT SEE PAGE 185

STOCK NO.	UPC NO.	DIAMETER	LENGTH	DRILL STOCK NO.	WT. PER PKG.	STD PKG	SUGGESTED TRADE LIST PRICER PER
CSF1F	87201	3/16	1 1/4	CD1	0.78	100	25.50/c
CSF2F	87202	3/16	1 3/4	CD1	1.05	100	27.58/c
CSF3F	87203	3/16	2 1/4	CD2	1.35	100	31.03/c
CSF4F	87204	3/16	2 3/4	CD2	1.52	100	31.38/c
CSF5F	87205	3/16	3 1/4	CD3	1.80	100	40.28/c
CSF6F	87206	3/16	4	CD3	2.12	100	64.00/c

NEW STAINLESS STEEL 410 TYPE INSTALL WITH #2 PHILLIPS BIT SEE PAGE 185

CSF2SS	96602	3/16	1 3/4	CD1	1.07	100	84.75/c NEW
CSF4SS	96604	3/16	2 3/4	CD2	1.50	100	112.25/c NEW

INSTALL WITH #3 PHILLIPS BIT SEE PAGE 185

CSF10F	87210	1/4	1 1/4	CD5	1.25	100	30.85/c
CSF20F	87220	1/4	1 3/4	CD5	1.75	100	31.10/c
CSF30F	87230	1/4	2 1/4	CD6	2.11	100	52.05/c
CSF40F	87240	1/4	2 3/4	CD6	2.15	100	61.35/c
CSF50F	87250	1/4	3 1/4	CD7	2.88	100	85.40/c
CSF60F	87260	1/4	4	CD7	3.70	100	104.35/c NEW
CSF70F	87270	1/4	5	CD7	4.50	100	141.03/c NEW

OTHER SIZES AND QUANTITIES AVAILABLE BY REQUEST

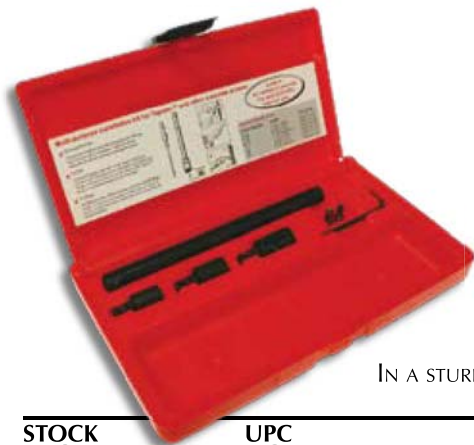

KIT INCLUDES:

- 1 - Drill Driver
- 1 - Drill Adapter
- 2 - Hex Drivers
- 1 - Phillips Bit Holder
- 2 - Phillips Bits
- 1 - Allen Hex Key

DOES NOT INCLUDE DRILL BIT

IN A STURDY PLASTIC STORAGE CASE

CONCRETE SCREW INSTALLATION KIT

8 PIECE KIT

Tools and Driving Accessories

STOCK NO.	UPC NO.	DESCRIPTION	WT. EA.	STD. PKG.	SUGGESTED TRADE LIST PRICE PER
IT1000	31200	Installation Tool (complete kit)	.95	1	110.10/ea
REPLACEMENT COMPONENTS FOR KIT					
MHD14	31205	1/4" Magnetic Hex Driver			30.55/ea
MHD56	31210	5/16" Magnetic Hex Driver			30.55/ea
PBH	31215	#2 & #3 Phillips Bit Holder			33.60/ea
ITSLEVE	31203	Drill/Driver Adapter			39.98/ea
PB2	31220	#2 Phillips Bit			1.53/ea
PB3	31225	#3 Phillips Bit			1.53/ea
HK1	31230	1/8" Allen Hex Key			1.33/ea

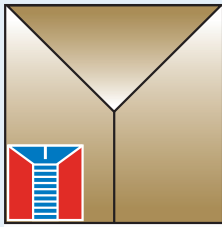

Metallics

LCS LARGE DIAMETER CONCRETE SCREW ANCHOR

Self-Threading Anchor



City of Los Angeles #RR25741 #RR25560 (CMU)
 Florida FL11506.7
 Factory Mutual 3017082

High strength screw anchor for concrete and masonry. Designed for optimum performance in both cracked concrete and uncracked concrete under both static and seismic load conditions.

Fast Installation

- Just drill with standard ANSI bit to proper depth
- Installs with 50% less torque

Finished hex washer head

- Length identification on head
- Serrated washer

Close edge/spacing distance

Less spacing and edge distance required.

Saves Time

Installs in less than half the time of wedge or adhesive anchors.

Another NEW exciting solution from Metallics! Tired of searching for the right large diameter anchor... Here it is!

Selection Chart

Carbon Steel with Zinc Plating

Part Number	Anchor Diameter	Socket Size	Drill Bit Diameter	Effective Length
LCS3816	3/8"	9/16"	3/8"	1 3/4"
LCS3824	3/8"		3/8"	2 1/2"
LCS3830	3/8"		3/8"	3"
LCS3840	3/8"		3/8"	4"
LCS3850	3/8"		3/8"	5"
LCS1230	1/2"	3/4"	1/2"	3"
LCS1240	1/2"		1/2"	4"
LCS1250	1/2"		1/2"	5"
LCS1260	1/2"		1/2"	6"



PRODUCT SPECIFICATIONS

Diameter:
3/8" and 1/2"

Thread Form:
Serrated teeth on the tip reduces installation torque

Material:
Carbon steel with zinc plate

Head Style:
Finished hex serrated washer head

STOCK NUMBER	UPC #	DESCRIPTION	QTY PER PKG.	SUG. TRADE LIST / PKG
LCS3816	14470	3/8 x 1 3/4" Hex Washer Head Concrete Anchor	50	\$64.20
LCS3824	14471	3/8 x 2 1/2" Hex Washer Head Concrete Anchor	50	\$89.83
LCS3830	14472	3/8 x 3" Hex Washer Head Concrete Anchor	50	\$98.33
LCS3840	14473	3/8 x 4" Hex Washer Head Concrete Anchor	50	\$105.50
LCS3850	14474	3/8 x 5" Hex Washer Head Concrete Anchor	40	\$99.41
LCS1230	14480	1/2 x 3" Hex Washer Head Concrete Anchor	25	\$78.70
LCS1240	14481	1/2 x 4" Hex Washer Head Concrete Anchor	25	\$85.83
LCS1250	14482	1/2 x 5" Hex Washer Head Concrete Anchor	25	\$92.98
LCS1260	14483	1/2 x 6" Hex Washer Head Concrete Anchor	20	\$105.98

Metallics

229 Cross Street,
 Bristol, Ct. 06010
 Tel: 800-243-8272
 Fax: 800-831-9358
 Email: sales@metallicsonline.com

"Growth Through Innovation"

Metallics West

651 North Main Street
 Maancos, Co. 81328
 Tel: 800-269-5183
 Fax: 800-269-6278
 Email: saleswest@metallicsonline.com

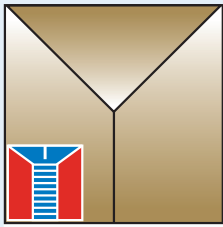

Metallics

LCSX LARGE DIAMETER CONCRETE SCREW ANCHOR Mechanically Galvanized



City of Los Angeles #RR25741 #RR25560 (CMU)
Florida FL11506.7
Factory Mutual 3017082

High strength screw anchor for concrete and masonry. Designed for optimum performance in both cracked concrete and uncracked concrete under both static and seismic conditions.

Fast Installation

- Just drill with standard ANSI bit to proper depth
- Installs with 50% less torque

Finished hex washer head

- Length identification on head
- Serrated washer

Close edge/spacing distance

Less spacing and edge distance required.

Saves Time

Installs in less than half the time of wedge or adhesive anchors.



PRODUCT SPECIFICATIONS

Diameter:
3/8" and 1/2"

Thread Form:
Serrated teeth on the tip reduces installation torque

Material:
Carbon steel with zinc plate

Head Style:
Finished hex washer head with mechanically galvanized coating

Selection Chart

Carbon Steel with Mechanically Galvanized Coating

Part Number	Anchor Diameter	Socket Size	Drill Bit Diameter	Effective Length	Max. Thickness of Material To Be Fastened
LCSX3850	3/8"	9/16"	3/8"	5"	3 1/2"
LCSX1250	1/2"	3/4"	1/2"	5"	2 1/2"

Another NEW exciting solution from Metallics! Tired of searching for the right large diameter anchor... Here it is!

STOCK NUMBER	UPC #	DESCRIPTION	QTY PER PKG.	SUG. TRADE LIST / PKG
LCSX3850	14492	3/8 x 5" Hex Washer Head Concrete Anchor with mechanically galvanized coating	40	\$182.60
LCSX1250	14498	1/2 x 5" Hex Washer Head Concrete Anchor with mechanically galvanized coating	25	\$194.53

Metallics

229 Cross Street,
Bristol, Ct. 06010
Tel: 800-243-8272
Fax: 800-831-9358
Email: sales@metallicsonline.com

"Growth Through Innovation"

Metallics West

651 North Main Street
Maancos, Co. 81328
Tel: 800-269-5183
Fax: 800-269-6278
Email: saleswest@metallicsonline.com

ANCHORING DEVICES

MASONRY DRILL BITS FOR CONCRETE SCREWS



Can be used with our
QuaDrive and Blue
Concrete Screws

SPECIAL SIZE AND LENGTH

For use with Installation Tool, see Page 84
or any standard electric rotary tool or hammer drill

STOCK NO.	UPC NO.	SIZE	SCREW DIA.	WT. PER PKG.	STD. PKG.	SUGGESTED TRADE LIST PRICE PER
CD1	31250	5/32 x 3 1/2	3/16	.02	1	3.38/ea
CD2	31255	5/32 x 4 1/2	3/16	.02	1	3.98/ea
CD3	31260	5/32 x 5 1/2	3/16	.02	1	4.53/ea
CD5	31265	3/16 x 3 1/2	1/4	.02	1	3.45/ea
CD6	31270	3/16 x 4 1/2	1/4	.02	1	4.08/ea
CD7	31275	3/16 x 5 1/2	1/4	.03	1	5.78/ea
CD8	31280	3/16 x 6	1/4	.03	1	7.43/ea



BLUE CONCRETE SCREW KITS

INDENTED HEX SLOTTED WASHER HEAD

STOCK NO.	UPC NO.	DESCRIPTION OF CONTENTS	STD. PKG./MSTR. CARTON	WEIGHT EACH	SUGGESTED TRADE LIST PRICE PER
CSH316RF	87370	50 pcs 3/16 x 1 1/4, 35 pcs 3/16 x 1 3/4 25 pcs 3/16 x 2 1/4, 1 pc 3 1/2 x 5/32 masonry drill, 1 pc MT208 1/4" chuck	1/25	1.29	40.50/ea kit NEW
CSH14RF	87365	50 pcs 1/4 x 1 1/4, 35 pcs 1/4 x 1 3/4 25 pcs 1/4 x 2 1/4, 1 pc 3 1/2 x 3/16 masonry drill, 1 pc MT210 5/16" chuck	1/25	2.00	44.88/ea kit NEW



SPRING WING TOGGLE BOLTS

STEEL ZINC CHROMATE

Bolts and Wings in One Package

STOCK NO.	JAR UPC NO.	DIAMETER & LENGTH	WT. PER PKG.	STD. PKG.	SUGGESTED TRADE LIST PRICE PER
ROUND HEAD					
J1501 (slot/Phillips)	80809	1/8 x 2	1/8" WING USE 7/16" DRILL	0.72	50 24.80/c
J1502 (slot/Phillips)	80810	1/8 x 3	3/16" WING USE 9/16" DRILL	0.80	50 28.56/c
J1503 (slot/Phillips)	81203	1/8 x 4		0.98	50 30.56/c
J1504 (slot/Phillips)	81204	1/8 x 6	1/4" WING USE 3/4" DRILL	2.60	50 49.10/c NEW
J1505 (slot/Phillips)	80811	3/16 x 2		1.40	50 29.96/c
J1506 (slot/Phillips)	80812	3/16 x 3	5/16" WING USE 7/8" DRILL	1.71	50 33.26/c
J1507 (slot/Phillips)	81207	3/16 x 4		1.95	50 34.76/c
J1508 (slotted)	81208	3/16 x 5	3/8" WING USE 1" DRILL	2.35	50 37.36/c
J1509 (slotted)	81209	3/16 x 6		2.60	50 43.06/c
J1511 (slot/Phillips)	80813	1/4 x 3	1/2" WING USE 1-1/4" DRILL	2.93	50 37.66/c
J1512 (slot/Phillips)	10396	1/4 x 4		3.45	50 41.96/c
J1513 (slotted)	81213	1/4 x 5		3.93	50 49.00/c
J1514 (slotted)	81214	1/4 x 6	SELECT THE PROPER DRILL FOR MATERIAL TO BE DRILLED	4.47	50 55.90/c

CONTINUED ON NEXT PAGE

ANCHORING DEVICES



CONTINUED SPRING WING TOGGLE BOLTS

STEEL ZINC CHROMATE

Bolts and Wings in One Package

STOCK NO.	JAR UPC NO.	DIAMETER & LENGTH	WT. PER PKG.	STD. PKG.	SUGGESTED TRADE LIST PRICE PER
ROUND HEAD					
J1516 (slotted)	10407	5/16 x 4	3.05	25	89.92/c
J1517 (slotted)	81217	5/16 x 5	3.81	25	127.52/c NEW
J1518 (slotted)	81218	5/16 x 6	4.03	25	142.72/c NEW
J1519 (slot/Phillips)	81219	3/8 x 3	3.72	25	99.92/c
J1520 (slot/Phillips)	81220	3/8 x 4	4.31	25	111.18/c
J1521 (slotted)	81221	3/8 x 5	5.06	25	136.52/c
J1522 (slotted)	81222	3/8 x 6	5.60	25	148.92/c
J1523 (slotted)	81223	1/2 x 4	3.95	10	201.80/c
J1524 (slotted)	81224	1/2 x 5	4.25	10	269.00/c
J1525 (slotted)	81225	1/2 x 6	4.85	10	295.80/c
FLAT HEAD					
J1528 (slotted)	81228	1/8 x 2	0.69	50	NEW
J1529 (slotted)	80814	1/8 x 3	0.87	50	
J1530 (slotted)	81230	1/8 x 4	0.97	50	NEW
J1531 (slotted)	81231	3/16 x 2	1.48	50	
J1532 (slotted)	81232	3/16 x 3	1.68	50	
J1533 (slotted)	81233	3/16 x 4	2.10	50	
J1534 (slotted)	81234	3/16 x 5	2.24	50	NEW
J1535 (slotted)	81235	3/16 x 6	2.62	50	NEW
J1536 (slotted)	81236	1/4 x 3	2.82	50	
J1537 (slotted)	81237	1/4 x 4	3.31	50	
J1538 (slotted)	81238	1/4 x 5	3.96	50	NEW
J1539 (slotted)	81239	1/4 x 6	4.46	50	NEW
J1540 (slotted)	81240	5/16 x 3	2.55	25	
J1541 (slotted)	81241	5/16 x 4	2.88	25	
J1542 (slotted)	81242	5/16 x 5	3.22	25	NEW
J1543 (slotted)	81243	5/16 x 6	3.79	25	NEW
J1544 (slotted)	81244	3/8 x 3	3.49	25	
J1545 (slotted)	81245	3/8 x 4	4.22	25	
J1546 (slotted)	81246	3/8 x 5	4.90	25	
J1547 (slotted)	81247	3/8 x 6	5.75	25	NEW
MUSHROOM - TRUSS HEAD					
J1548 (slotted)	80815	1/8 x 2	0.75	50	24.80/c
J1549 (slot/Phillips)	80816	1/8 x 3	0.82	50	28.56/c
J1550 (slot/Phillips)	80817	1/8 x 4	1.01	50	30.56/c
J1551 (slot/Phillips)	80818	3/16 x 3	1.80	50	33.26/c
J1552 (slot/Phillips)	10397	3/16 x 4	2.01	50	34.76/c
J1553 (slot/Phillips)	10399	1/4 x 3	2.96	50	39.06/c
J1554 (slot/Phillips)	10398	1/4 x 4	3.50	50	41.96/c
SQUARE MUSHROOM - TRUSS HEAD					
J1560 (square)	80819	1/8 x 2	0.84	50	49.70/c
J1561 (square)	80820	1/8 x 3	0.95	50	28.56/c
J1562 (square)	80821	1/8 x 4	1.10	50	30.56/c
J1563 (square)	80822	3/16 x 2	1.58	50	29.96/c
J1564 (square)	80823	3/16 x 3	1.85	50	33.26/c
J1565 (square)	81265	3/16 x 4	2.00	50	34.76/c
J1566 (square)	81266	1/4 x 3	3.03	50	39.06/c

1/8" WING
USE
7/16" DRILL

3/16" WING
USE
9/16" DRILL

1/4" WING
USE
3/4" DRILL

5/16" WING
USE
7/8" DRILL

3/8" WING
USE
1" DRILL

1/2" WING
USE
1-1/4" DRILL

SELECT THE
PROPER DRILL FOR
MATERIAL TO
BE DRILLED

*SPECIAL
ORDER
ITEMS.

INQUIRE
ABOUT
AVAIL-
ABILITY
AND
PRICES

1-800
243-8272
EAST

1-800
269-5183
WEST

E

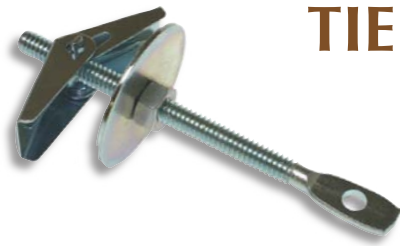

TIE WIRE ACOUSTICAL TOGGLE BOLTS

Includes: (1) Tie Wire 1/4-20 toggle bolt
 (1) 1/4-20 nut
 (1) 1/4 washer
 (1) 1/4 toggle wing

Tie wire acoustical toggle bolts are primarily for overhead applications. The winged end is inserted through the drywall, ceiling tile, etc., and expands behind that medium while the 1/4" x 1-1/4" fender washer and hex nut act to secure the anchor on the exterior of the hole.

STOCK NO.	UPC NO.	SIZE	DESCRIPTION	WT. PER PKG.	PKG. QTY	SUGGESTED TRADE LIST
JTWA144	81402	1/4 x 4	Toggle bolt	2.47	50	152.00/c
JTWA145	81404	1/4 x 5	Toggle bolt	2.33	50	163.72/c

Hole Size 5/8" ● Eye Size 1/4"



SHEET ROCK TOGGLES

Vertical Mount used for hanging Threaded Rod 1/4" or 3/8"
 For use in sheetrock ceilings, metal, lath & plaster, metal liners, wood, ceiling panels.

SheetRock Toggle for 1/4 Rod (Vertical Mount)
 Use Nut Driver SMDB2

STOCK NO.	UPC NO.	SIZE	DESCRIPTION	WT. PER PKG.	PKG. QTY	SUGGESTED TRADE LIST
JSRT14	81388	1/4	SheetRock Toggle	3.08	25	307.12/c



SPRING TOGGLE HEADS

STEEL ZINC CHROMATE & STAINLESS STEEL 18-8 TYPE
 For Light Duty Application

STOCK NO.	UPC NO.	THREAD DIAMETER	WT. PER PKG.	STD. PKG.	SUGGESTED TRADE LIST PRICE PER
STEEL ZINC CHROMATE					
J1590	80824	6-32	0.71	100	15.48/c
J1592	80825	10-24	1.38	100	18.53/c
J1593	80826	1/4-20	2.25	100	20.98/c
J1594	80827	5/16-18	4.20	100	39.25/c
J1595	80828	3/8-16	1.47	25	57.12/c
J1596	80829	1/2-13	4.42	25	132.40/c
NEW STAINLESS STEEL 18-8 TYPE					
J1593SS	96993	1/4-20	0.94	50	200.00/c NEW
J1592SS	96992	3/16	0.74	50	225.00/c NEW

FOR APPROPRIATE
 DRILL SIZE SEE
 CHART ON PAGE
88

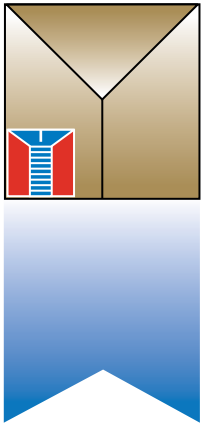

METALLICS

INTRODUCING...

MUSHROOM HEAD TOGGLE BOLT KIT



KIT INCLUDES THE FOLLOWING:

1/8" X 3" MUSHROOM HEAD COMBO
DRIVE BOLT (50 PIECES)

1/8" SPRING WING TOGGLE
(50 PIECES)

3/16" X 3" MUSHROOM HEAD COMBO
DRIVE BOLT (34 PIECES)

3/16" SPRING WING TOGGLE
(34 PIECES)

1/4" X 4" MUSHROOM HEAD COMBO
DRIVE BOLT (20 PIECES)

1/4" SPRING WING TOGGLE
(20 PIECES)

DESCRIPTION:

We are at it again with Kits!
Introducing 3 of the most commonly used Mushroom Head Toggle Bolts all in
one convenient kit at one great low price.

STOCK NO.	UPC NO.	WT. PER PKG.	SUGGESTED TRADE LIST PRICE PER
TBMK1	70060	3.7 lbs.	46.28/ea. kit

Metallics East • Bristol, CT
229 Cross Street
1-800-243-8272

Metallics West • Mancos, CO
651 North Main Street
1-800-269-5183

ANCHORING DEVICES

HOLLOW BLOCK T-ANCHORS

For Hollow Wallblock

STEEL ZINC CHROMATE



STOCK NO.	UPC NO.	SIZE	THREAD LENGTH	DRILL SIZE	WT. PER PKG.	STD. PKG.	SUGGESTED TRADE LIST PRICE PER
JTA14134	80830	1/4 x 1 3/4	1	5/16	0.93	25	241.72/c
JTA14212	80831	1/4 x 2 1/2	1 3/4	5/16	1.12	25	253.72/c
JTA14314	80832	1/4 x 3 1/4	2 5/8	5/16	0.89	25	261.80/c
JTA516212	80833	5/16 x 2 1/2	1 5/8	5/16	1.60	25	263.80/c
JTA516314	80834	5/16 x 3 1/4	2 3/8	5/16	2.03	25	274.00/c
JTA516334	80835	5/16 x 3 3/4	2 7/8	5/16	2.31	25	288.00/c
JTA38314	80836	3/8 x 3 1/4	2 1/4	3/8	2.88	25	314.32/c
JTA38334	81143	3/8 x 3 3/4	2 3/4	3/8	3.05	25	322.32/c
JTA38412	81146	3/8 x 4 1/2	3 1/2	3/8	3.59	25	352.52/c

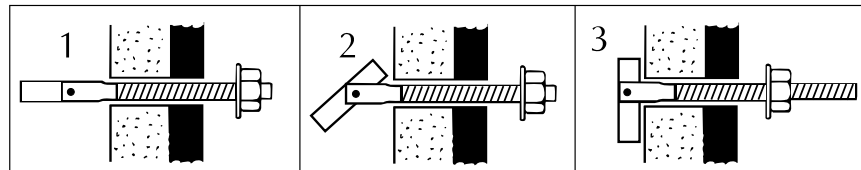

1. Drill hole using proper diameter and insert T-Anchor with washer and hex nut attached through item to be fastened.
2. Give it a quarter turn; retaining bar drops into place.
3. Tighten nut until a firm resistance is attained.

HOLLOW WALL SCREW ANCHORS, DRIVE-TYPE

STEEL ZINC CHROMATE - INCLUDES COMBO HEAD MACHINE SCREW



A hammer is the only tool needed to set in place.
No predrilling required when fastening fixtures and electrical components to sheet rock.
It is a time-saver for the professional contractor.

STOCK NO.	UPC NO.	SIZE & WALL THICKNESS	GRIP RANGE	DRILL SIZE	WT. PER PKG.	STD. PKG./MSTR. SLEEVE	SUGGESTED TRADE LIST PRICE PER
J6721	80837	1/8 Short	1/8 - 1/2	5/16	1.37	100/500	38.08/c
J6726	80838	1/8 Long	1/8 - 1 3/16	5/16	1.84	100	39.10/c



HOLLOW WALL SCREW ANCHOR

STEEL ZINC CHROMATE

INCLUDES COMBO HEAD MACHINE SCREW

STOCK NO.	UPC NO.	SIZE & WALL THICKNESS	GRIP RANGE	DRILL SIZE	WT. PER PKG.	STD. PKG.	SUGGESTED TRADE LIST PRICE PER
J1001	80839	1/8 X-Short	1/16 - 1/4	5/16	.91	100	33.23/c
J1002	80840	1/8 Short	1/8 - 1/2	5/16	1.36	100	33.90/c
J1003	80841	1/8 Long	5/8 - 7/8	5/16	1.81	100	36.48/c
J1004	80842	3/16 Short	1/8 - 5/8	7/16	3.45	100	66.95/c
J1005	80843	3/16 Long	5/8 - 1 3/16	7/16	2.15	50	81.96/c
J1006	80844	1/4 Short	1/8 - 5/8	1/2	2.81	50	97.30/c
J1007	80845	1/4 Long	5/8 - 1 3/16	1/2	3.65	50	110.50/c

ANCHORING DEVICES

MACHINE SCREW LEAD ANCHOR

ONE SETTING TOOL FURNISHED IN EACH JAR OF ANCHORS



We only recomend these anchors for cement floors,
not to be used overhead in ceilings or walls.

STOCK NO.	UPC NO.	SIZE	HOLE SIZE	ANCHOR LENGTH	WT. PER PKG.	STD. PKG.	SUGGESTED TRADE LIST PRICE PER
J1401	83155	6-32	5/16	17/32	0.87	100	44.75/c NEW
J1402	80846	8-32	5/16	17/32	0.91	100	45.03/c
J1403	80847	10-24	3/8	11/16	1.78	100	45.63/c
J1404	80848	10-32	3/8	1/2	1.88	100	45.63/c
J1406	80850	1/4-20	1/2	7/8	3.75	100	51.38/c
J1407	80851	5/16-18	5/8	1 1/16	6.69	100	129.38/c
J1408	80852	3/8-16	3/4	1 5/16	5.25	50	130.50/c
J1409	80853	1/2-13	7/8	1 9/16	8.97	50	158.90/c

NOT RECOMMENDED FOR CEMENT CEILING APPLICATIONS

PLEASE NOTE THAT MACHINE SCREW ANCHORS HAVE A LEAD OUTER GRIPPING SHELL. IN APPLICATIONS WHERE LEAD IS CONSIDERED DANGEROUS, WE DO NOT RECOMMEND THEIR USE. UNTIL U.S. GOVT. SAFETY REGULATIONS TAKE A FIRM STAND ON THEIR USE, METALLICS WILL CONTINUE TO OFFER THIS PRODUCT-AS DO MANY OTHER FASTENER COMPETITORS.

E



MACHINE SCREW ANCHOR SETTING TOOL

Safety glasses should be worn for any driving applications.
See Safety Glasses Pg. 220-222

STOCK NO.	UPC NO.	SIZE	WT. PER PKG.	STD. PKG.	SUGGESTED TRADE LIST PRICE PER
1401ST	17900	6-32	.04	1	4.93/ea NEW
1402ST	17905	8-32	.07	1	4.20/ea
1403ST	17910	10-24	.08	1	5.03/ea
1404ST	17915	10-32	.14	1	5.03/ea
1406ST	17925	1/4-20	.17	1	5.58/ea
1407ST	17930	5/16-18	.27	1	5.95/ea
1408ST	17935	3/8-16	.38	1	6.28/ea
1409ST	17940	1/2-13	.58	1	12.13/ea

STEEL SELF-DRILLING ANCHOR

STEEL ZINC CHROMATE/SNAP-OFF STYLE

Can be used in conjunction with
Machine Screws, Bolts, or Threaded Rod
Eliminates use of carbide masonry drill bits.
For use in structural fastening to concrete floors.



Safety glasses should be worn for any driving applications. Safety Glasses see Pages 220-222

STOCK NO.	UPC NO.	BOLT SIZE	WT. PER PKG.	STD. PKG.	SUGGESTED TRADE LIST PRICE PER
J14SOT	82600	1/4-20	4.81	100	170.00/c
J38SOT	82610	3/8-16	5.22	50	247.70/c
J12SOT	82615	1/2-13	4.88	25	380.52/c

ANCHORING DEVICES



LAG SCREW SHIELD

ALLOY ZINC DIE CAST
Medium-Duty Application
See page 78 and 79 for Lag Bolts

A secure die cast expansion anchor of zinc rustproof alloy. Most effective for holding in brittle or soft masonry. The ideal product for mortar joints.

STOCK NO.	UPC NO.	LAG SCREW DIAMETER	HOLE SIZE	ANCHOR LENGTH	WT. PER PKG.	STD. PKG.	SUGGESTED TRADE LIST PRICE PER
SHORT							
J1201	80854	1/4	1/2	1	1.06	50	46.66/c
J1202	80855	5/16	1/2	1 1/4	1.21	50	42.70/c
J1203	80856	3/8	5/8	1 3/4	2.19	50	68.80/c
J1204	80857	1/2	3/4	2	1.73	25	111.40/c
J1205	80858	5/8	7/8	2	2.74	25	171.00/c
J1206	83081	3/4	1	2	.81	25	198.05/c NEW
LONG							
J1207	80859	1/4	1/2	1 1/2	1.48	50	49.30/c
J1208	80860	5/16	1/2	1 3/4	1.45	50	50.26/c
J1209	80861	3/8	5/8	2	3.32	50	92.86/c
J1210	80862	1/2	3/4	3	2.57	25	141.80/c
J1211	80863	5/8	7/8	3 1/2	5.37	25	271.00/c
J1212	83086	3/4	1	3 1/2	1.06	25	365.26/c NEW



DROP-IN ANCHOR

STEEL ZINC CHROMATE AND STAINLESS STEEL
FOR USE IN STRUCTURAL FASTENING TO CONCRETE FLOORS
ONE SETTING TOOL FURNISHED IN EACH JAR OF ANCHORS

STOCK NO.	UPC NO.	SIZE	HOLE SIZE	ANCHOR LENGTH	STD. PKG.	WT. PER PKG.	SUGGESTED TRADE LIST PRICE PER
STEEL							
JDIA14	81870	1/4-20	3/8	1	100	2.33	64.20/c
JDIA38	81875	3/8-16	1/2	1 9/16	50	3.30	88.20/c
JDIA12	81880	1/2-13	5/8	2	50	6.41	145.70/c
JDIA58	81881	5/8-11	7/8	2 1/2	25	8.91	296.60/c
JDIA34	81873	3/4-10	1	3 3/16	25	13.58	736.20/c NEW
STAINLESS STEEL 18-8 TYPE							
JDIA14SS	81872	1/4-20	3/8	1	100	2.54	PLEASE CALL FOR TRADE LIST PRICING
JDIA38SS	81876	3/8-16	1/2	1 9/16	50	3.50	
JDIA12SS	81883	1/2-13	5/8	2	50	6.25	
JDIA58SS	81882	5/8-11	7/8	2 1/2	25	8.36	
NEW STAINLESS STEEL - 316 TYPE							
JDIA141SS	90345	1/4-20	3/8	1	100	2.54	NEW
JDIA381SS	90349	3/8-16	1/2	1 9/16	100	3.50	NEW
JDIA121SS	90353	1/2-13	5/8	2	50	6.03	NEW

STEEL DROP-IN ANCHOR SETTING TOOL

FOR SETTING DROP-IN ANCHORS

Safety glasses should be worn for any driving applications.
See our line of Safety Glasses Pages 220-222



STOCK NO.	UPC NO.	SIZE	WT. PER PKG.	STD. PKG.	SUGGESTED TRADE LIST PRICE PER
DIA14T	12181	1/4-20	0.18	1	3.85/ea
DIA38T	12182	3/8-16	0.24	1	5.00/ea
DIA12T	12183	1/2-13	0.41	1	6.18/ea
DIA58T	12184	5/8-11	0.51	1	11.53/ea
DIA34T	17890	3/4-10	0.65	1	11.68/ea NEW

ANCHORING DEVICES



SINGLE EXPANSION ANCHOR

ZINC CHROMATE

STOCK NO.	UPC NO.	SIZE	HOLE SIZE	ANCHOR BODY LENGTH	WT. PER PKG.	STD. PKG.	SUGGESTED TRADE LIST PRICE PER
JSEA14	81195	1/4	1/2	1	2.57	100	63.13/c
JSEA516	81196	5/16	5/8	1 1/4	2.44	50	96.96/c
JSEA38	81197	3/8	3/4	1 1/2	2.32	50	102.36/c
JSEA12	81198	1/2	7/8	2	3.04	25	218.20/c



DOUBLE EXPANSION ANCHOR

ZINC CHROMATE

The Double Expansion Anchor is manufactured of rustproof zinc alloy and is used with machine screws or machine bolts. These Anchors work well in soft masonry, as it sets, the two opposing wedges pull towards each other, expanding the full length of the anchor body.

STOCK NO.	UPC NO.	SIZE	HOLE SIZE	ANCHOR BODY LENGTH	WT. PER PKG.	STD. PKG.	SUGGESTED TRADE LIST PRICE PER
ZINC CHROMATE							
JDEA14	80872	1/4	1/2	1	2.94	100	126.23/c
JDEA516	80873	5/16	5/8	1 1/4	2.82	50	173.56/c
JDEA38	80874	3/8	3/4	1 1/2	4.48	50	229.50/c
JDEA12	80875	1/2	7/8	2	3.70	25	361.80/c
JDEA58	82397	5/8	1	2 1/4	8.91	25	442.12/c NEW
JDEA34	82390	3/4	1 1/4	2 7/8	9.12	20	650.00/c NEW



WOOD AND TAPPING SCREW LEAD ANCHOR

STOCK NO.	UPC NO.	SIZE	LENGTH	HOLE SIZE	WT. PER PKG.	STD. PKG.	SUGGESTED TRADE LIST PRICE PER
J1302	80877	6-8	1	1/4	1.47	100/500	21.50/c
J1303	80878	6-8	1 1/2	1/4	1.98	100/500	23.68/c
J1305	80879	10-14	1	5/16	2.00	100/500	27.33/c
J1306	80880	10-14	1 1/2	5/16	2.97	100/500	37.58/c
J1307	80881	16-18	1	3/8	2.75	100/500	37.58/c
J1308	80882	16-18	1 1/2	3/8	3.59	100/500	51.08/c

PLEASE NOTE THAT WOOD AND TAPPING SCREW LEAD ANCHORS HAVE A LEAD OUTER GRIPPING SHELL. IN APPLICATIONS WHERE LEAD IS CONSIDERED DANGEROUS, WE DO NOT RECOMMEND THEIR USE. UNTIL U.S. GOVT. SAFETY REGULATIONS TAKE A FIRM STAND ON THEIR USE, METALLICS WILL CONTINUE TO OFFER THIS PRODUCT, AS DO MANY OTHER FASTENER COMPETITORS.



ROD COUPLING WEDGE ANCHOR

ANCHORS THREADED ROD TO CONCRETE CEILINGS

STOCK NO.	UPC NO.	BOLT AND HOLE DIA.	BOLT LENGTH	WT. PER PKG.	STD. PKG.	SUGGESTED TRADE LIST PRICE PER
JRCA381	81585	3/8	1 7/8	9.24	100	201.23/c NEW
JRCA38	81586	3/8	2 1/8	4.97	50	167.66/c
JRCA12	81588	1/2	2 3/4	11.40	50	271.80/c

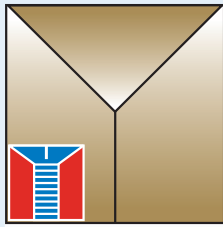

Metallics

MULTI-PURPOSE ANCHORS

ZINC PLATED

- Light-Duty Hammer-Drive Concrete and Masonry Anchors
- Specified for anchorage into concrete, block and brick
- As simple as using a nail – drive into predrilled holes in concrete



PART NUMBER	DRILL BIT SIZE	TOTAL LENGTH	MIN. EMBEDMENT	CLEARANCE HOLE SIZE
RD4158	1/4"	1 1/2"	1 1/4"	5/16"
RD4200	1/4"	2"	1 1/4"	5/16"
RD4212	1/4"	2 1/2"	1 1/4"	5/16"
RD4300	1/4"	3"	1 1/4"	5/16"

PART NUMBER	UPC #	DESCRIPTION	QTY / PKG.	SUG. TRADE LIST / PKG.
RD4158	74488	Multi-Purpose Mushroom Head Anchor 1 1/2"	100	\$32.43
RD4200	74490	Multi-Purpose Mushroom Head Anchor 2"	100	\$39.63
RD4212	74492	Multi-Purpose Mushroom Head Anchor 2 1/2"	100	\$48.20
RD4300	74494	Multi-Purpose Mushroom Head Anchor 3"	100	\$54.20

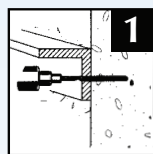

1
Drill a proper-sized diameter hole 1/2" deeper than the required embedment.

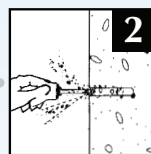

2
Clean hole.

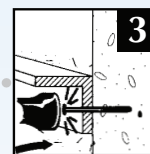

3
Insert anchor through material to be fastened and drive with hammer until head is flush with surface.

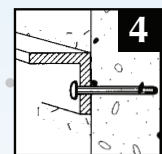

4
Multi-Purpose Anchor is now set.

Metallics

229 Cross Street,
Bristol, Ct. 06010
Tel: 800-243-8272
Fax: 800-831-9358
Email: sales@metallicsonline.com

"Growth Through Innovation"

Metallics West

651 North Main Street
Maancos, Co. 81328
Tel: 800-269-5183
Fax: 800-269-6278
Email: saleswest@metallicsonline.com

ANCHORING DEVICES

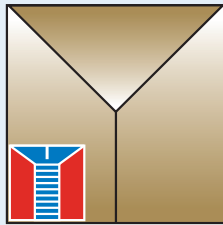

Metallics MULTI-PURPOSE ANCHORS

ZINC PLATED



Tie Wire Anchors - For acoustical ceilings and suspended electrical fixtures.

Pipe Hanging Anchors - For sprinkler, water lines, steam/gas and electrical conduits.

Available in 1/4"-20 and 3/8"-16 internal thread.

Forming Anchors - For wood attachments to concrete.

Selection Guide

Part Number	Drill Bit Size	Min. Embedment	Hole Size I.D.
TD4112	1/4"	1-1/8"	9/32"

Part Number	Int. Thread	Drill Bit Size	Min. Embedment
PD4112	1/4"-20"	3/16"	1-1/4"
PD8134	3/8"-16"	1/4"	1-1/2"

Part Number	Fixture Hole Size	Drill Bit Size	Min. Embedment
FD8234	5/16"	1/4"	1-1/4"



Another NEW exciting solution from Metallics! Tired of searching for the right Anchor? Here they are! Multi-Purpose Anchors...

STOCK NUMBER	UPC #	DESCRIPTION	QTY PER PKG.	SUG. TRADE LIST / PKG
TD4112	73918	Multi-Purpose Tie Wire Anchor	100	\$116.88
PD4112	73924	Multi-Purpose Pipe Hanging Anchor 1/4"-20 Int Thread	100	\$109.13
PD8134	73925	Multi-Purpose Pipe Hanging Anchor 3/8"-16 Int Thread	100	\$131.88
FD8234	73915	Multi-Purpose Forming Anchor 2-3/4" Long	100	\$123.25

Metallics

229 Cross Street,
Bristol, Ct. 06010
Tel: 800-243-8272
Fax: 800-831-9358
Email: sales@metallicsonline.com

"Growth Through Innovation"

Metallics West

651 North Main Street
Maancos, Co. 81328
Tel: 800-269-5183
Fax: 800-269-6278
Email: saleswest@metallicsonline.com

FLAT HEAD SPLIT DRIVE ANCHOR



- Can be used in concrete, hard masonry and stone
- Load can be applied immediately
- High grade steel with a memory
- One piece, pre-expanded anchor
- Exact hole depth not required to set anchor
- Fast, permanent installation

Safety glasses should be worn for any driving applications. See Pages 220-222

STOCK NO.	UPC NO.	JAR UPC NO.	SIZE	MASONRY DRILL SIZE	WT. PER PKG.	STD. PKG.	SUGGESTED TRADE LIST PRICE PER
JFSD141	81594	81594	1/4 x 1 1/2	1/4 x 4	1.22	50	54.56/c
JFSD142	81596	81596	1/4 x 2	1/4 x 4	1.58	50	62.10/c
JFSD1421	81598	81598	1/4 x 2 1/2	1/4 x 4	1.87	50	68.20/c
JFSD143	81600	81600	1/4 x 3	1/4 x 4	2.27	50	74.26/c
JFSD1431	81602	81602	1/4 x 3 1/2	1/4 x 6	1.35	25	81.80/c
JFSD144	81604	81604	1/4 x 4	1/4 x 6	1.50	25	89.40/c

SLEEVE TYPE ANCHOR

STEEL ZINC CHROMATE



* = acorn nuts



STOCK NO.	UPC NO.	DIAMETER & LENGTH	FASTENS MATERIAL UP TO	DEPTH IN LENGTH	WT. PER PKG.	STD. PKG.	SUGGESTED TRADE LIST PRICE PER
STEEL ZINC CHROMATE – HEX (Acorn)							
J2505	77405	1/4 x 5/8	1 1/4	1	1.57	100	41.25/c NEW
J2513*	80883	1/4 x 1 3/8	3/8	1	2.32	100	41.55/c
J2522*	80884	1/4 x 2 1/4	1 1/4	1	3.14	100	58.98/c
J3114	80885	5/16 x 1 1/2	1/2	1	3.54	100	69.08/c
J3124	80886	5/16 x 2 1/2	1 1/2	1	5.24	100	90.50/c
J3717	80887	3/8 x 1 7/8	5/8	1 1/4	3.58	50	92.36/c
J3730	80888	3/8 x 3	1 3/4	1 1/4	5.15	50	119.20/c
J3732	77310	3/8 x 4	1 3/4	1 1/4	6.71	50	119.20/c NEW
J5022	80889	1/2 x 2 1/4	3/4	1 1/2	3.24	25	130.72/c
J5026	80890	1/2 x 3	1 1/4	1 1/2	4.07	25	172.72/c
J5040	81131	1/2 x 4	2 1/2	1 1/2	5.02	25	285.00/c
J5060	81135	1/2 x 6	4 1/2	1 1/2	7.15	25	401.40/c
J6222	80891	5/8 x 2 1/4	1/4	2	6.60	25	251.00/c
J6242	81345	5/8 x 4 1/4	2 1/4	2	4.14	10	353.80/c
J6256	81350	5/8 x 6	3 3/4	2	5.30	10	476.00/c
J7524	80892	3/4 x 2 1/2	1/2	2	4.07	10	377.00/c
J7542	81360	3/4 x 4 1/4	1 3/4	2 1/2	3.23	5	582.00/c
J7562	81365	3/4 x 6 1/4	3 3/4	2 1/2	4.75	5	698.60/c

LARGER DIAMETERS & LENGTHS AVAILABLE BY SPECIAL REQUEST.

CONTINUED ON NEXT PAGE

ANCHORING DEVICES



CONTINUED

SLEEVE TYPE ANCHOR

STEEL ZINC CHROMATE

* = acorn nuts

STOCK NO.	JAR UPC NO.	DIAMETER & LENGTH	FASTENS MATERIAL UP TO	DEPTH IN LENGTH	WT. PER PKG.	STD. PKG.	SUGGESTED TRADE LIST PRICE PER
NEW STEEL ZINC CHROMATE - FLAT HEAD							
J2520F	77220	1/4 x 2	1	1	3.11	100	97.38/c NEW
J2530F	77225	1/4 x 3	2	1	4.17	100	101.85/c NEW
NEW STEEL ZINC CHROMATE - ROUND HEAD							
J2512R	81089	1/4 x 1 1/4	1/4	1	1.89	100	63.88/c NEW
J2520R	82620	1/4 x 2	1	1	2.52	100	64.88/c NEW
J2526R	82626	1/4 x 2 3/4	1	1	3.24	100	80.75/c NEW
STAINLESS STEEL 18-8 TYPE - HEX							
J2513SS*	82106	1/4 x 1 3/8	3/8	1	2.14	100	77.53/c
J2522SS*	82107	1/4 x 2 1/4	1 1/4	1	3.30	100	92.58/c
J3114SS	82108	5/16 x 1 1/2	1/2	1	4.50	100	102.85/c
J3124SS	82109	5/16 x 2 1/2	1 1/2	1	6.30	100	147.48/c
J3717SS	82111	3/8 x 1 7/8	5/8	1 1/4	3.62	50	223.86/c
J3730SS	82112	3/8 x 3	1 3/4	1 1/4	4.87	50	223.86/c
J5022SS	82113	1/2 x 2 1/4	3/4	1 1/2	3.12	25	290.92/c
J5026SS	82114	1/2 x 3	1 1/4	1 1/2	3.88	25	467.80/c
J5030SS	82116	1/2 x 3	1 1/2	2	4.02	25	360.40/c
J5040SS	82117	1/2 x 4	2 1/2	1 1/2	5.50	25	466.72/c
J6230SS	82118	5/8 x 3	1/4	2	6.60	25	630.52/c
J6242SS	82119	5/8 x 4 1/4	2 1/4	2	4.00	10	829.00/c
J7524SS	82121	3/4 x 2 1/2	1/2	2	5.00	10	894.80/c
J7542SS	82123	3/4 x 4 1/4	1 3/4	2 1/2	3.50	5	1,263.00/c
J7554SS	82124	3/4 x 5 1/2	3 3/4	2 1/2	4.70	5	1,493.60/c

LARGER DIAMETERS & LENGTHS AVAILABLE BY SPECIAL REQUEST.

Sleeve Anchors hold more because:

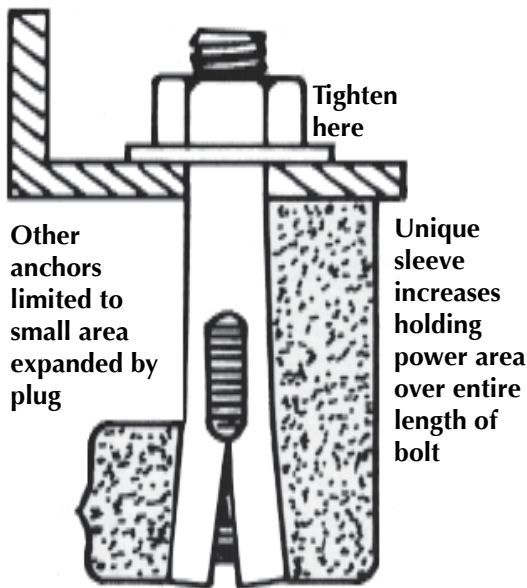

Sleeve anchors do not depend on bottom of hole to expand the anchor

Sleeve anchors work under a true expansion principle, whereby the tightening of the nut forces the expansion of an outer sleeve over a tapered portion of the bolt. The sleeve also becomes a factor in a shear load application providing increased strength in addition to the anchor's bolt.

SELECTING THE PROPER LENGTH SLEEVE ANCHOR

The selection of the proper length of sleeve anchor depends upon the thickness of the material to be fastened and the minimum depth of anchor required in masonry for maximum holding power. Add the thickness of the material (A) and the recommended depth for the anchor diameter (B) to determine the correct length of anchor to be used. (B) to determine the correct length of anchor to be used.

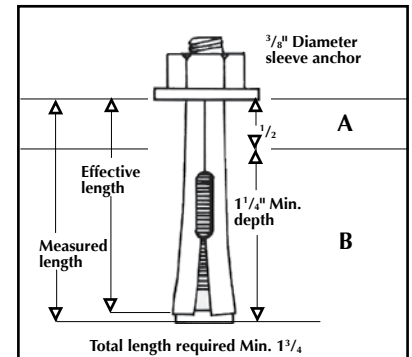

ANCHORING DEVICES



(STUD ANCHOR) WEDGE ANCHORS

STEEL ZINC CHROMATE AND STAINLESS STEEL

A powerful product when strength is needed, eliminates drilling oversized holes; exact hole depth not required. This spring stainless steel band, when locked, acts like a fish hook that digs into concrete. Then 3 to 4 turns of the nut expands the wedge.

STOCK NO.	UPC NO.	DRILL & BODY DIAMETER/LENGTH	THREAD LENGTH	MIN. DEPTH IN LENGTH	WT. PER PKG.	STD. PKG.	SUGGESTED TRADE LIST PRICE PER
STEEL							
JTS1134	80893	1/4 x 1 3/4	3/4	1 1/8	3.12	100	66.85/c
JTS1214	80894	1/4 x 2 1/4	3/4	1 1/8	3.68	100	75.40/c
JTS103	80895	1/4 x 3 1/4	3/4	1 1/8	4.63	100	85.65/c
JTS3218	80896	3/8 x 2 1/4	7/8	1 1/2	8.05	100	108.98/c
JTS3234	81165	3/8 x 2 3/4	1 1/8	1 1/2	9.30	100	114.80/c
JTS303	80898	3/8 x 3	1 1/8	1 1/2	9.92	100	117.83/c
JTS312	80899	3/8 x 3 3/4	1 1/8	1 1/2	11.70	100	134.40/c
JTS385	81614	3/8 x 5	1 1/8	1 1/2	7.45	50	154.70/c
JTS3612	81615	3/8 x 6 1/2	1 1/4	1 5/8	9.85	50	210.46/c
JTS4234	81166	1/2 x 2 3/4	1 1/4	2 1/4	9.10	50	184.60/c
JTS4334	81770	1/2 x 3 3/4	1 1/4	2 1/4	11.00	50	206.40/c
JTS4414	81622	1/2 x 4 1/4	1 1/4	2 1/4	6.12	25	214.40/c
JTS4512	81623	1/2 x 5 1/2	1 1/4	2 1/4	7.28	25	266.00/c
JTS407	81624	1/2 x 7	1 1/4	2 1/4	9.55	25	323.72/c
JTS5312	81630	5/8 x 3 1/2	2	2 3/4	9.22	25	343.52/c
JTS5412	81631	5/8 x 4 1/4	2	2 3/4	10.48	25	377.40/c
JTS505	81632	5/8 x 5	2	2 3/4	11.60	25	395.20/c
JTS506	81633	5/8 x 6	2	2 3/4	19.00	25	432.52/c
JTS6414	81640	3/4 x 4 1/4	2	3 1/4	12.09	20	516.65/c
JTS6434	81641	3/4 x 4 3/4	2	3 1/4	13.27	20	541.50/c
JTS6512	81642	3/4 x 5 1/2	2	3 1/4	14.75	20	606.75/c
JTS6614	81643	3/4 x 6 1/4	2	3 1/4	8.25	10	672.30/c
STAINLESS STEEL 18-8 TYPE							
JTS1134SS	80900	1/4 x 1 3/4	3/4	1 1/8	1.55	50	164.16/c
JTS1214SS	80901	1/4 x 2 1/4	3/4	1 1/8	1.85	50	188.08/c
JTS103SS	80902	1/4 x 3 1/4	3/4	1 1/8	2.50	50	214.80/c
JTS3218SS	80903	3/8 x 2 1/4	7/8	1 1/2	4.02	50	304.60/c
JTS303SS	80904	3/8 x 3	1 1/8	1 1/2	5.07	50	358.96/c
JTS312SS	80905	3/8 x 3 3/4	1 1/8	1 1/2	5.96	50	517.16/c
JTS385SS	95250	3/8 x 5	1 1/8	1 1/2	7.46	50	523.26/c NEW
JTS3612SS	95255	3/8 x 6 1/2	1 1/4	1 5/8	4.94	25	923.64/c NEW
JTS4234SS	82126	1/2 x 2 3/4	1 1/4	2 1/4	4.11	25	592.52/c
JTS4334SS	82127	1/2 x 3 3/4	1 1/4	2 1/4	5.77	25	686.60/c
JTS4512SS	95260	1/2 x 5 1/2	1 1/4	2 1/4	14.56	50	1,285.66/c NEW
NEW STAINLESS STEEL 316 TYPE							
JTS1034SS	90298	1/4 x 3 1/4	3/4	1 1/8	5.02	100	PLEASE CALL NEW
JTS3033SS	90305	3/8 x 3	1 1/8	1 1/2	5.08	50	PLEASE CALL NEW

LARGER DIAMETERS & LENGTHS AVAILABLE BY SPECIAL REQUEST.



Metallics Avanti Screw Manufacturing Facility in Bristol, CT



None of our competitors selling to the Electrical, Plumbing and HVAC Distribution trade can claim they manufacture screws.

There is no doubt: We know the American fastener market and are ahead of our competitors. Our Avanti Screw, Inc., fastener manufacturing facility in Bristol, CT, provides you an American fastener company who makes a portion of its product, sold through electrical, plumbing and HVAC distributors.

ANCHORING DEVICES

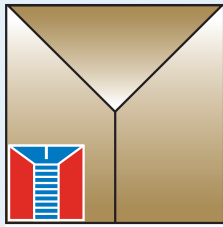

Metallics STRONG-BOLT™ Wedge Anchors

Carbon Steel Wedge Anchors for
Cracked and Uncracked Concrete

NEW!

Tested to
Meet
2006 IBC

INSTALLATION STEPS

1. Drill hole with carbide tipped masonry drill in base material the same size as the nominal diameter of the anchor.
2. Drill hole to proper embedment depth and blow clean.
3. Assemble anchor with nut and washer flush with top of anchor.

4. Place the anchor in fixture and drive into the hole until washer and nut are tight against fixture.
5. Tighten to the required installation torque.

DO NOT USE AN IMPACT WRENCH TO SET OR TIGHTEN.



Features:

- Tri-Segmented clip is able to adjust independently increasing follow-up expansion should the hole increase in size as a result of a crack.
- 316 stainless clip with superior corrosion resistance.
- Head is stamped with Simpson Strong-Tie® "S" sign and size ID.
- Carbon-steel zinc plated stud with 316 stainless-steel clip.

Codes:

ICC-ES ESR-1771; City of L.A. RR25705; Florida FL 11506.6

Test Criteria:

Strong-Bolt™ Wedge anchor has been tested in accordance with ICC-ES's *Acceptance Criteria for Mechanical Anchors in Concrete Elements (AC193) and ACI 355.2 for the following in cracked and uncracked concrete:*

- Static tension and shear loading in cracked and uncracked concrete
- Seismic and wind loading in cracked and uncracked concrete
- Performance in cracked concrete
- Performance in lightweight concrete over metal deck

Selection Guide

Part Number	Thread Length	Anchor Diameter & Drill Bit Size (Threads) Per Inch	Overall Length
SWA3830	1 1/4"	3/8" - 16	3"
SWA3836	2 3/8"	3/8" - 16	3 3/4"
SWA3850	3 3/8"	3/8" - 16	5"
SWA1236	2 1/8"	1/2" - 13	3 3/4"
SWA1244	2 7/8"	1/2" - 13	4 1/4"
SWA1254	3 7/8"	1/2" - 13	5 1/2"
SWA1270	5 3/8"	1/2" - 13	7"
SWA5850	3 3/16"	5/8" - 11	5"
SWA5860	4 3/16"	5/8" - 11	6"
SWA5870	5 3/16"	5/8" - 11	7"
SWA5884	5 1/4"	5/8" - 11	8 1/2"

PART #	UPC #	DESCRIPTION	QTY / PKG	SUG. TRADE LIST / PKG
SWA3830	14978	3/8 x 3" Strong-Bolt Wedge Anchor	50	\$125.45
SWA3836	14981	3/8 x 3-3/4" Strong-Bolt Wedge Anchor	50	\$158.63
SWA3850	14986	3/8 x 5" Strong-Bolt Wedge Anchor	50	\$183.25
SWA1236	15451	1/2 x 3-3/4" Strong-Bolt Wedge Anchor	25	\$111.55
SWA1244	15454	1/2 x 4-1/4" Strong-Bolt Wedge Anchor	25	\$115.33
SWA1254	15458	1/2 x 5-1/2" Strong-Bolt Wedge Anchor	25	\$126.58
SWA1270	15463	1/2 x 7" Strong-Bolt Wedge Anchor	25	\$140.58
SWA5850	16236	5/8 x 5" Strong-Bolt Wedge Anchor	10	\$73.75
SWA5860	16239	5/8 x 6" Strong-Bolt Wedge Anchor	10	\$81.68
SWA5870	16243	5/8 x 7" Strong-Bolt Wedge Anchor	10	\$87.20
SWA5884	16247	5/8 x 8-1/2" Strong-Bolt Wedge Anchor	10	\$96.63

Metallics

229 Cross Street,
Bristol, Ct. 06010
Tel: 800-243-8272
Fax: 800-831-9358
Email: sales@metallicsonline.com

"Growth Through Innovation"

Metallics West

651 North Main Street
Maancos, Co. 81328
Tel: 800-269-5183
Fax: 800-269-6278
Email: saleswest@metallicsonline.com



TIE WIRE WEDGE ANCHOR

ZINC WITH STAINLESS STEEL CLIP
For various overhead suspension applications

STOCK NO.	UPC NO.	DIAMETER/LENGTH	MIN. DEPTH IN LENGTH	WT. PER PKG.	STD. PKG.	SUGGESTED TRADE LIST PRICE
JTWA214	80906	1/4 x 2 ³ / ₁₆	1 ³ / ₈	2.46	100	108.60/c

HAMMER DRIVE WEDGE ANCHOR

ZINC AND STAINLESS STEEL
A superior alternative to traditional wedge anchors



- Installs six times faster than an ordinary wedge-type anchor.
- Easily installs through pre-drilled holes in plates and footings – no need for templates.
- No special tools required.
- Tensions during setting process.
- Deforms the concrete to set, eliminating creep and loss of pre-load.
- Faster, easier and more consistent installation.

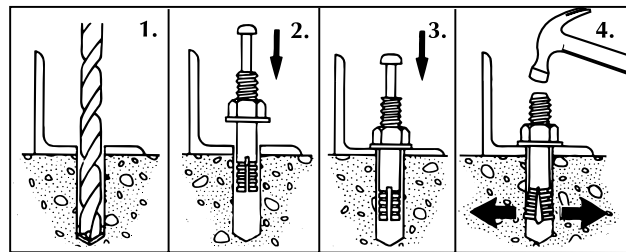

INSTALLATION:

1. Drill hole.
2. Preset nut and washer for desired embedment.
3. Hammer center pin until it is aligned with top of the bolt.
4. Anchor is set.

Safety glasses should be worn for any driving applications. See our line of Safety Glasses, pages 220-222

STOCK NO.	UPC NO.	SIZE	THREAD LENGTH	MASONRY DILL SIZE	WT. PER PKG.	STD. PKG.	SUGGESTED TRADE LIST PRICE PER
ZINC CHROMATE							
JHW14134	80907	1/4 x 1 ³ / ₄	5/8	1/4 x 4	1.72	50	112.46/c
JHW14238	80908	1/4 x 2 ³ / ₈	3/4	1/4 x 4	2.05	50	119.20/c
JHW5162	80909	5/16 x 2	3/4	5/16 x 4	2.70	50	146.00/c
JHW516234	80910	5/16 x 2 ³ / ₄	1	5/16 x 4	3.04	50	169.60/c
JHW38238	80911	3/8 x 2 ³ / ₈	1	3/8 x 4	4.35	50	184.60/c
JHW38312	80912	3/8 x 3 ¹ / ₂	1 ¹ / ₈	3/8 x 6	6.05	50	256.80/c
JHW38434	82630	3/8 x 4 ³ / ₄	1 ¹ / ₈	3/8 x 6	7.03	50	372.66/c
JHW12234	82635	1/2 x 2 ³ / ₄	1/2	1/2 x 4	4.80	25	305.20/c
JHW12312	82640	1/2 x 3 ¹ / ₂	1/2	1/2 x 6	5.92	25	320.92/c
JHW12434	82645	1/2 x 4 ³ / ₄	2	1/2 x 6	7.25	25	470.00/c
JHW126	82650	1/2 x 6	2	1/2 x 12	9.07	25	703.60/c
JHW584	82655	5/8 x 4	1 ⁵ / ₈	5/8 x 6	10.76	25	488.52/c
JHW58434	82660	5/8 x 4 ³ / ₄	1 ⁵ / ₈	5/8 x 6	12.22	25	676.52/c
JHW586	82665	5/8 x 6	2	5/8 x 12	6.03	10	834.50/c
JHW345	82670	3/4 x 5	2	3/4 x 12	7.36	10	904.80/c
JHW346	82675	3/4 x 6	2	3/4 x 12	8.39	10	1,326.00/c
JHW34712	82680	3/4 x 7 ¹ / ₂	2	3/4 x 12	9.21	10	1,587.80/c

LARGER DIAMETERS & LENGTHS AVAILABLE BY SPECIAL REQUEST.



Metallics

BOA™ COIL

Expansion Anchor
Heavy-Duty,
Reusable Fastening



Standard Replacement
Coils for 1/2", 5/8", and
3/4" diameter bolts.



Installation Steps

NOTE: To achieve maximum loads the installation process needs to be carries out as follows:

1. Using the fixture as a template, drill the correct diameter and depth hole.
2. Remove debris with vacuum or hand pump.
3. Insert the assembled Boa Coil anchor. (The coil anchor tab points up the anchor) Tap anchor down to depth set mark and stop.
4. Tighten until washer is firmly held to the fixture and stop. The number of turns to set a 1/2" anchor is 3-4 turns, for 5/8" and 3/4" anchors 4-5 turns. Ensure washer is tight and snugfit.
5. The Boa Coil anchor is ready to take load. (The bolt can be removed leaving the coil in the hole. To re-insert follow steps 3 and 4.) The Boa Coil anchor can be reused up to 3 times.

- Easy installation
- Removable
- Reusable
- High shear strength

Applications

- Tilt-wall construction
- Concrete formwork
- Load bearing angles, beams and columns
- Machinery holddown
- Jersey barrier
- Glare screens

*Another NEW
exciting solution
from Metallics!
Tired of searching
for the right
expansion anchor...
Here they are!*

Stock Number	UPC#	Description	Quantity Per Pkg.	Suggested Trade List Per Pkg.
BCA1230	14761	1/2" x 3" Boa Coil Expansion Anchor	25	\$115.20
BCA1240	14675	1/2" x 4" Boa Coil Expansion Anchor	25	\$139.33
BCA1254	14770	1/2" x 5-1/2" Boa Coil Expansion Anchor	25	\$161.68
BCA5834	14840	5/8" x 3-1/2" Boa Coil Expansion Anchor	20	\$147.38
BCA5850	14846	5/8" x 5" Boa Coil Expansion Anchor	15	\$145.33
BCA3444	14874	3/4" x 4-1/2" Boa Coil Expansion Anchor	10	\$101.93
BCA3560	14879	3/4" x 6" Boa Coil Expansion Anchor	10	\$124.15
BCAR12	14720	1/2" Replacement Coil	100	\$88.30
BCAR58	14736	5/8" Replacement Coil	100	\$100.43
BCAR34	14740	3/4" Replacement Coil	100	\$117.00

Metallics

229 Cross Street,
Bristol, Ct. 06010
Tel: 800-243-8272
Fax: 800-831-9358
Email: sales@metallicsonline.com

"Growth Through Innovation"

Metallics West

651 North Main Street
Mancos, Co. 81328
Tel: 800-269-5183
Fax: 800-269-6278
Email: saleswest@metallicsonline.com

RED HEAD® IS A REGISTERED TRADEMARK

ANCHORING DEVICES

HAND DRIVE PINS

STEEL ZINC PLATED

An economical way of attaching wood and metal to masonry and block construction.

SAFETY GLASSES SHOULD BE WORN FOR ANY DRIVING APPLICATIONS. SEE PAGES 220-222



STOCK NO.	UPC NO.	HEAD SIZE	LENGTH	WT. PER PKG.	STD. PKG./MSTR. SLEEVE	SUGGESTED TRADE LIST PRICE PER
JDP1	80916	1/4	1/2	.46	100/500	12.33/c
JDP2	80917	1/4	3/4	.60	100/500	13.15/c
JDP3	80918	1/4	1	.72	100/500	13.93/c
JDP4	80919	1/4	1 1/4	.80	100/500	15.93/c
JDP5	80920	1/4	1 1/2	.87	100/500	16.13/c
JDP6	80921	1/4	2	1.18	100/500	21.13/c
JDP7	80922	1/4	2 1/2	1.28	100/500	22.83/c
JDP8	81595	1/4	3	1.32	100/500	31.18/c NEW



HAND DRIVE TOOL

FOR HAND DRIVE PINS — DP1 thru 8

SAFETY GLASSES SHOULD BE WORN FOR ANY DRIVING APPLICATIONS. SEE PAGES 220-222

STOCK NO.	UPC NO.	DESCRIPTION	WT. EACH	STD. PKG.	SUGGESTED TRADE LIST PRICE PER
HDT2	18720	Hand Drive Tool	.51	1	96.70/ea

The Metallics Alternative to Hand Drive Pins
THE MOST ECONOMICAL ANCHORING DEVICE

HEAT TEMPERED FLUTED MASONRY NAILS

STEEL

FOR GREATER BEARING SURFACE USE WITH SAE OR FENDER WASHER.
WE RECOMMEND FOR ATTACHING WIRE SCREENING OVER
STYROFOAM AND BLOCK BEFORE STUCCO.



STOCK NO.	UPC NO.	SIZE	WT. PER PKG.	APPROX COUNT	STD. PKG.	SUGGESTED TRADE LIST PRICE PER
MN1TM	21242	1"	2.60	435	1 Jar	10.35/ea pkg
MN112TM	21243	1-1/2"	2.55	225	1 Jar	10.35/ea pkg
MN2TM	21244	2"	2.64	180	1 Jar	10.45/ea pkg
MN212TM	21245	2-1/2"	2.63	190	1 Jar	10.48/ea pkg
MN3TM	21246	3"	2.62	135	1 Jar	10.93/ea pkg

ANCHORING DEVICES

CONTRACTOR/DISTRIBUTOR SPECIAL REQUEST

100 EACH MASONRY NAILS
100 EACH FENDER WASHERS
CONVENIENCE TO GO!!



FLUTED MASONRY NAIL AND FENDER WASHER KITS IN A JAR

STOCK NO.	UPC NO.	NAIL SIZE	WASHER SIZE	WT. PER JAR	STD. PKG.	SUGGESTED TRADE LIST PRICE PER
MNK1	81660	1	3/16 x 1	1.91	1	13.90/ea pkg
MNK112	81662	1 1/2	3/16 x 1	2.15	1	13.90/ea pkg
MNK2	81664	2	3/16 x 1	2.31	1	14.50/ea pkg
MNK212	81666	2 1/2	3/16 x 1	2.54	1	14.50/ea pkg
MNK3	81668	3	3/16 x 1	2.74	1	14.93/ea pkg



FLUTED MASONRY NAIL AND WASHER ASSORTMENT KIT

STOCK NO.	UPC NO.	DESCRIPTION OF CONTENTS	STD. PKG./MSTR. CARTON	WT. EACH KIT	SUGGESTED TRADE LIST PRICE PER
MNK10 175 PIECES	21275	70 3/16 x 1 fender washers 25 x 1", 25 x 1 1/2", 20 x 2", 20 x 2 1/2", 15 x 3 masonry nails	1/25	2.35	21.73/ea kit



METAL HAMMER DRIVE NAIL-IN ANCHOR

FOR LIGHT-DUTY APPLICATION

STOCK NO.	UPC NO.	DIAMETER/LENGTH	HOLE SIZE	WT. PER PKG.	STD. PKG./MSTR. SLEEVE	SUGGESTED TRADE LIST PRICE PER
JNA316	80923	3/16 x 7/8	3/16	.91	100/500	27.83/c
JNA140	80924	1/4 x 3/4	1/4	1.59	100/500	32.18/c
JNA141	80925	1/4 x 1	1/4	1.87	100/500	32.83/c
JNA1414	80926	1/4 x 1 1/4	1/4	2.25	100	36.23/c
JNA1415	80927	1/4 x 1 1/2	1/4	2.49	100	40.43/c
JNA142	80928	1/4 x 2	1/4	2.98	100	52.53/c

NEW STAINLESS STEEL 18-8 TYPE

JNA141SS	90387	1/4 x 1	1/4	1.86	100	PLEASE CALL	NEW
JNA1414SS	81987	1/4 x 1 1/4	1/4	2.23	100		NEW
JNA142SS	91381	1/4 x 2	1/4	3.33	100		NEW

OTHER SIZES AND QUANTITIES AVAILABLE BY REQUEST



HAND DRILLING HAMMER

3-LB. - WOODEN HANDLE

SAFETY GLASSES SHOULD BE WORN FOR ANY DRIVING APPLICATIONS. SEE PAGES 220-222

STOCK NO.	UPC NO.	HEAD WEIGHT	STD. PKG.	SUGGESTED TRADE LIST PRICE PER
HAM3	18700	3.53	1	40.38/ea

ASSORTED PLASTIC ANCHORS

"Big Red" Conical Plastic Anchor



STOCK NO.	UPC NO.	COLOR/LENGTH	SCREW SIZE	HOLE SIZE	WT. PER PKG.	STD. PKG./MSTR. SLEEVE	SUGGESTED TRADE LIST PRICE PER
JRA1	80929	Red 3/4	6-8	3/16	.10	100/500	3.38/c
JRA15	80930	Red 7/8	8-10	3/16	.10	100/500	3.50/c
JRA2	80931	Red 1	10-12	1/4	.18	100/500	4.03/c
JRA3	80932	Red 1 1/2	12-14	5/16	.31	100/500	7.60/c

"Denver Blue" Conical Plastic Anchor



JBA1	80933	Blue 3/4	6-8	3/16	.10	100/500	3.38/c
JBA15	80934	Blue 7/8	8-10	3/16	.09	100/500	3.50/c
JBA2	80935	Blue 1	10-12	1/4	.17	100/500	4.03/c
JBA3	80936	Blue 1 1/2	12-14	5/16	.28	100/500	7.60/c

"Super Yellow" Plastic Wall Anchor



JSYA316	80940	Yellow 1	6-8	3/16	.13	100/500	3.50/c
JSYA14	80941	Yellow 1 1/4	8-10	1/4	.18	100/500	4.03/c
JSYA516	80942	Yellow 1 5/8	12-14	5/16	.27	100/500	8.08/c

"Gray Ribbed" Plastic Anchor



JGA1	80953	Gray 7/8	6-8	3/16	.13	100/500	3.58/c
JGA2	80954	Gray 1	10-12	1/4	.18	100/500	4.03/c
JGA3	80955	Gray 1 1/4	14-16	5/16	.24	100/500	8.08/c

"Collared Vinyl" Anchor



JVA1	81920	Orange	6-8-10-12-16	1/4	.19	100/500	7.15/c
------	-------	--------	--------------	-----	-----	---------	--------

"Collarless Vinyl" Wall Anchor



J1106	80945	Green 1	10-12	1/4	.25	100/500	4.20/c
J1107	80946	Green 1 1/4	10-12	1/4	.27	100/500	7.73/c
J1108	80947	Green 1 1/2	10-12	1/4	.35	100/500	11.80/c
J1110	80948	Blue 1	14	5/16	.31	100/500	5.88/c
J1111	80949	Blue 1 1/2	14	5/16	.41	100/500	7.53/c
J1114	80950	Orange 1 1/2	5/16	3/8	.39	50/250	9.70/c
J1115	80951	Orange 2	5/16	3/8	.46	50	12.20/c
J1116	80952	Orange 2 1/2	5/16	3/8	.67	50	13.86/c

"Expandet Nylon" Anchor



JELR2	80943	Red 1 1/2	8	1/4	.26	100/500	15.25/c
-------	-------	-----------	---	-----	-----	---------	---------

JELR3	80944	Blue 1 3/4	12	5/16	.48	100/500	25.85/c
-------	-------	------------	----	------	-----	---------	---------

E

ANCHORING DEVICES



Metallics

TOGGLER®

Alligator® Solid Wall Anchors

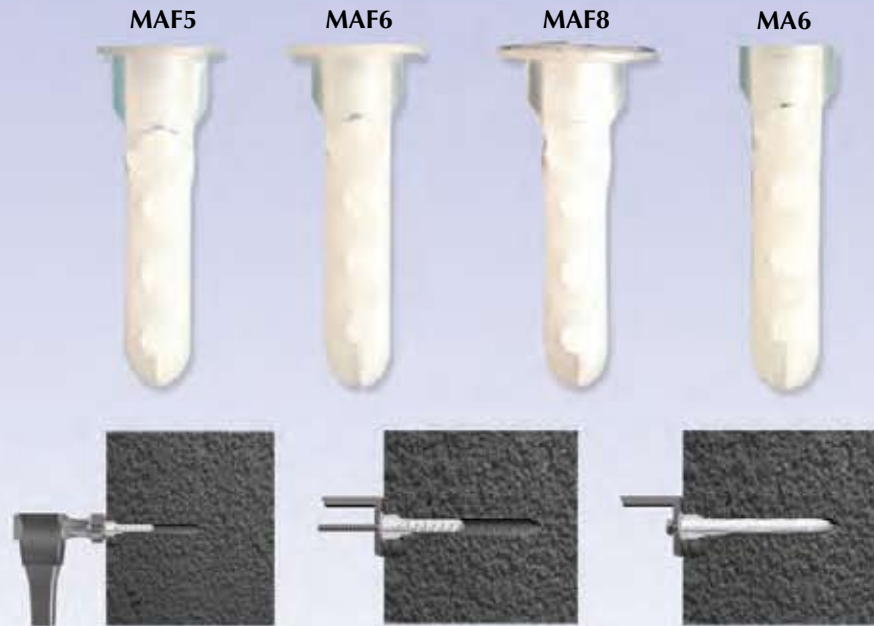

Another NEW exciting solution from Metallics!

Tired of searching for the right Anchor? Here they are!

Alligator® Solid Wall Anchors...

ALLIGATOR solid-wall anchors are designed to support heavy loads. (even under vibration)

ALLIGATOR solid-wall anchors can be used in almost any material, including: Concrete, Wood, Plaster, Aerated Concrete, Brick, Masonry, Stone, Flakeboard, Cinder Block, Ceramic Tile, Stucco, Drywall

Stock Number	UPC#	Description	Quantity Per Pkg.	Suggested Trade List Per Pkg.
MAF5	73905	Toggler 3/16" Alligator anchor with flange	50	\$15.88
MAF6	73906	Toggler 3/16" Alligator anchor with flange	50	\$22.55
MAF8	73908	Toggler 3/16" Alligator anchor with flange	50	\$30.08
MA6	73936	Toggler 3/16" Alligator anchor no flange	50	\$22.55

Metallics

229 Cross Street,
Bristol, Ct. 06010
Tel: 800-243-8272
Fax: 800-831-9358

Email: sales@metallicsonline.com

"Growth Through Innovation"

Metallics West

651 North Main Street
Mancos, Co. 81328
Tel: 800-269-5183
Fax: 800-269-6278

Email: saleswest@metallicsonline.com

NYLON DRIVE-IN ANCHORS



STOCK NO.	UPC NO.	COLOR/LENGTH	HOLE SIZE	WT. PER PKG.	STD. PKG./MSTR. SLEEVE	SUGGESTED TRADE LIST PRICE PER
ROUND HEAD						
J3161R	80956	White 1	3/16	.53	100/500	19.65/c
J141R	80957	White 1	1/4	.60	100/500	25.28/c
J1415R	80958	White 1 1/2	1/4	.89	100	26.75/c
J142R	80959	White 2	1/4	1.09	100	32.83/c
FLAT HEAD						
J3161F	80960	White 1	3/16	.50	100/500	19.65/c
J1434F	80961	White 3/4	1/4	.41	100/500	24.45/c
J141F	80962	White 1	1/4	.62	100/500	25.28/c
J1415F	80963	White 1 1/2	1/4	.87	100	26.75/c
J142F	80964	White 2	1/4	1.09	100	32.83/c
TRUSS - MUSHROOM HEAD						
J3161T	80965	White 1	3/16	.55	100/500	19.65/c
J1434T	80966	White 3/4	1/4	.50	100/500	24.45/c
J141T	80967	White 1	1/4	.63	100/500	25.28/c
J1415T	80968	White 1 1/2	1/4	.87	100	26.75/c
J142T	80969	White 2	1/4	1.21	100	32.83/c



PLASTIC TOGGLE

FOR LIGHT-DUTY APPLICATION

Stays in place if screw is removed. Ideal product for sheetrock.

STOCK NO.	UPC NO.	SIZE & WALL DIA	DRILL PER PKG.	SCREW PKG.	WT. PER PKG.	STD.	SUGGESTED TRADE LIST PRICE PER
JCPT1	80970	3/8	5/16	#8	.55	100	23.45/c
JCPT2	80971	1/2	5/16	#8	.57	100	26.23/c
JCPT3	80972	5/8	5/16	#8	.59	100	27.15/c

ORDER SCREWS SEPARATELY - #8 DIAMETER - SEE SECTION A - SCREWS

PLASTIC TOGGLE ANCHOR KITS

FOR LIGHT-DUTY APPLICATION

Plastic Toggles and matching • Pan Head "Combo" Sheet Metal Screws



STOCK NO.	UPC NO.	SIZE/WALL THICKNESS	DRILL SIZE	DESCRIPTION OF CONTENTS	WT. EACH KIT	STD. PKG.	SUGGESTED TRADE LIST PRICE PER
PTK1	20480	3/8	5/16	50 3/8 Plastic Toggles 50 8 x 1 1/2 Pan Combo Screws	.67	1 Kit	13.93/ea kit
PTK2	20485	1/2	5/16	50 1/2 Plastic Toggles 50 8 x 1 1/2 Pan Combo Screws	.67	1 Kit	15.48/ea kit
PTK3	20490	5/8	5/16	50 5/8 Plastic Toggles 50 8 x 1 1/2 Pan Combo Screws	.65	1 Kit	15.93/ea kit

ANCHORING DEVICES



Metallics TOGGLER® Hollow Wall Anchors



TOGGLER Hollow-Wall Anchors give you super versatility in:

- Gypsum Board
- Plasterboard
- Acoustic Ceilings
- Thin Paneling
- Hollow Core Doors
- Drywall
- Plaster
- Mastonite
- Sheet Metal
- Fiberglass

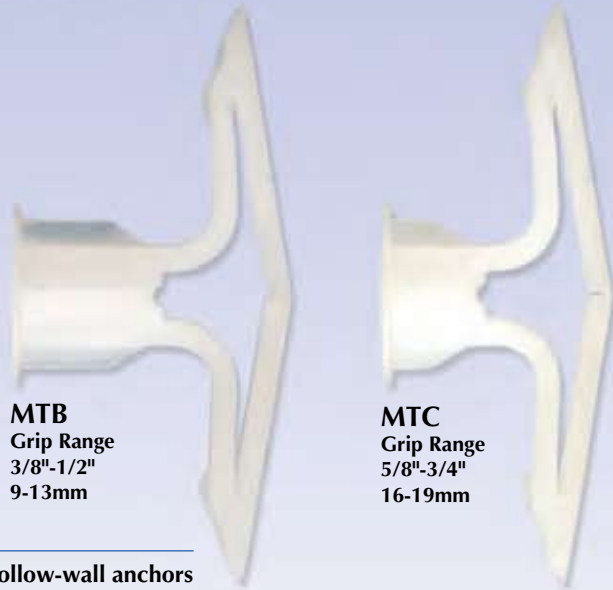

MTB
Grip Range
3/8"-1/2"
9-13mm

MTC
Grip Range
5/8"-3/4"
16-19mm

All TOGGLER hollow-wall anchors install in a small 5/16" (8mm) diameter hole. With reasonable care, you can even use your screwdriver to make the hole in drywall.

Installs quickly and securely



Drill 5/16" (8mm) hole. Fold anchor in middle.



Insert anchor in hole and tap flush with wall.



Insert key to pop anchor open behind hollow wall (not necessary for thick or solid walls) Do not force or hammer key.



Place item over anchor and tighten until screw is flush with fixture. Then, stop.

Another NEW exciting solution from Metallics!
Tired of searching for the right Hollow Wall Anchor...

Here it is!

Toggler®

Stock Number	UPC#	Description	Quantity Per Pkg.	Suggested Trade List Per Pkg.
MTB	73962	Toggler 3/8"-1/2" hollow wall anchor	50	\$21.98
MTC	73963	Toggler 3/8"-3/4" hollow wall anchor	50	\$25.30

Metallics

229 Cross Street,
Bristol, Ct. 06010
Tel: 800-243-8272
Fax: 800-831-9358
Email: sales@metallicsonline.com

"Growth Through Innovation"

Metallics West

651 North Main Street
Mancos, Co. 81328
Tel: 800-269-5183
Fax: 800-269-6278
Email: saleswest@metallicsonline.com

TOGGLER® IS A REGISTERED TRADEMARK

ATTENTION

ON LARGE ORDERS OF ANCHOR KITS — OUR PRICE CAN BE EVEN LOWER!

Please Call Us
for
Co-Labeling
on Kits!

JAR DISPLAY CENTER

Holds 18 Jars

**QUANTITY
DISCOUNTS:**

10% DISCOUNT ON
50-99 LIKE KITS

OR

15% DISCOUNT ON
100+ LIKE KITS

E



ANCHORING DEVICES



ARROW ANCHOR KIT

For Hollow Wall Use AAK68 Kit

EASY INSTALLATION AND REMOVAL
LEAVES ONLY A SMALL SLIT NOT A LARGE HOLE
FOR USE IN SHEETROCK OR WALLBOARD
USE WITH #6 OR #8 X 1" SHEETMETAL SCREW

AAK68 Kit Contains

STOCK NO.	UPC NO.	DESCRIPTION OF CONTENTS	WT. EACH KIT	SUGGESTED TRADE LIST PRICE PER
AAK68	18649	75 Hollow Wall Anchor 75 Phillips Combo T/S 1 #2x2" Phillips Pwr Bit	1.06lb	34.28/ea kit

JAA68 Anchors Only

STOCK NO.	UPC NO.	SIZE	DESCRIPTION OF CONTENTS	WT. EACH KIT	SUGGESTED TRADE LIST PRICE PER
JAA68	18643	1/8 X 1/2 X 1-7/16	Hollow Wall Anchors	.77	37.43/c



ASSORTED PLASTIC ANCHOR KIT WAKTRIO

THREE OF THE MOST POPULAR STYLE ANCHORS
SCREWS INCLUDED
ALL IN AN E-Z TO STORE PLASTIC CASE

WAKTRIO Kit Contains

STOCK NO.	UPC NO.	DESCRIPTION OF CONTENTS	WT. EACH KIT	SUGGESTED TRADE LIST PRICE PER
WAKTRIO	38990	25 - 6x1 Pan Combo Screw 25 - 3/16 Red Plastic Anchors 25 - 10x1 Pan Combo Screw 25 - 1/4 Yellow Super Anchors 25 - 10x1 Pan Combo Screw 25 - 1/4 Red Plastic Anchors	.64	8.63/ea kit



"BIG RED" CONICAL PLASTIC WALL ANCHOR KITS

FOR LIGHT-DUTY APPLICATION

NOW WITH QUADRIVE OPTION!

MASTER
CARTONS
CONTAIN:
25 KITS
18 JARS

STOCK NO.	UPC NO.	SIZE	DESCRIPTION OF CONTENTS	WT. EACH	SUGGESTED TRADE LIST PRICE PER
WAK13	20200/kit	3/16	100 - 3/16 Red Plastic Anchors	.55	13.25/ea kit
WAKJ13	20570/jar		100 - 6 x 1 Pan Combo Screws 1 - 3/16 Masonry Drill	.49	
WAK16	20280/kit	3/16	100 - 3/16 Red Plastic Anchors	.73	13.25/ea kit
WAKJ16	20281/jar		100 - 8 x 1 Pan Combo Screws 1 - 3/16 Masonry Drill	.68	
WAK16T	20284/kit	3/16	100 - 3/16 Red Plastic Anchors	.65	13.25/ea kit
WAKJ16T	20285/jar		100 - 8 x 1 Pan Tri-Drive  1 - 3/16 Masonry Drill	.59	13.25/ea kit Anchors & Screws ONLY METALLICS/Avanti Screw
WAK16H	20288/kit	3/16	100 - 3/16 Red Plastic Anchors	.75	16.80/ea kit
WAKJ16H	20289/jar		100 - 8 x 1 Hex Slotted Screws 1/4 Head 1 - 1/4 Hex Drive 1 - 3/16 Masonry Drill	.75	



CONTINUED ON NEXT PAGE

ANCHORING DEVICES



CONTINUED
"BIG RED"
**CONICAL PLASTIC
 WALL ANCHOR KITS**

MASTER
 CARTONS
 CONTAIN:
25 KITS
18 JARS

FOR LIGHT-DUTY APPLICATION

STOCK NO.	UPC NO.	SIZE	DESCRIPTION OF CONTENTS		WT. EACH	SUGGESTED TRADE LIST PRICE PER
WAK16R	20292/kit	3/16	100 - 3/16 Red Plastic Anchors		.76	13.25/ea kit
WAKJ16R	20293/jar		100 - 8 x 1 Pan Square Drive Screws 1 - 3/16 Masonry Drill		.76	
WAK14	20205/kit	1/4	100 - 1/4 Red Plastic Anchors		.95	13.25/ea kit
WAKJ14	20575/jar		100 - 10 x 1 Pan Combo Screws 1 - 1/4 Masonry Drill		.93	
WAK14T	20446/kit	1/4	100 - 1/4 Red Plastic Anchors		1.00	13.25/ea kit
WAKJ14T	20447/jar		100 - 10 x 1 Pan Tri-Drive Screws 1 - 1/4 Masonry Drill, 1 - 000R2B Bit		.93	
						MADE IN USA Anchors & Screws ONLY METALLICS/Avanti Screw 
WAK14H	20207/kit	1/4	100 - 1/4 Red Plastic Anchors		1.00	15.10/ea kit
WAKJ14H	20580/jar		100 - 10 x 1 with 5/16 Hex Slotted Screws 1 - 1/4 Masonry Drill		.93	
WAK14Q	20206/kit	1/4	100 - 1/4 Red Plastic Anchors		.79	15.10/ea kit
WAKJ14Q	20583/jar		100 - 10 x 1 with 1/4 Hex Slotted Screws 1 - 1/4 Masonry Drill		.83	
WAK14R	20445/kit	1/4	100 - 1/4 Red Plastic Anchors		.95	14.28/ea kit
WAKJ14R	20590/jar		100 - 10 x 1 Pan Square Drive Screws 1 - 1/4 Masonry Drill		.93	
WAK141	23841/kit	1/4	100 - 1/4 Red Plastic Anchors		1.00	13.25/ea kit NEW
WAKJ141	20584/jar		100 - 10 x 1 1/4 Pan Combo Screws 1 - 1/4 Masonry Drill		1.00	
WAK14SS	99414/kit	1/4	100 - 1/4 Red Plastic Anchors		.96	32.38/ea kit NEW
WAKJ14SS	99420/jar		100 - 10 x 1 Pan Slotted Screws S.S. 1 - 1/4 Masonry Drill		.94	
WAK14HSS	99415/kit	1/4	100 - 1/4 Red Plastic Anchors		.97	34.88/ea kit NEW
WAKJ14HSS	99419/jar		100 - 10 x 1 with 5/16 Hex Slotted Screws S.S. 1 - 1/4 Masonry Drill		.95	
WAK14SSPH	99418/kit	1/4	100 - 1/4 Red Plastic Anchors		.96	32.38/ea kit NEW
WAKJ14SSPH	99417/jar		100 - 10 x 1 with 1/4 Pan Phillips Screws S.S. 1 - 1/4 Masonry Drill		.96	
WAK15	20210/kit	5/16	50 - 5/16 Red Plastic Anchors		.85	14.28/ea kit
WAKJ15	20605/jar		50 - 12 x 1 1/4 Pan Combo Screws 1 - 5/16 Masonry Drill		.80	
WAK15R	20450/kit	5/16	50 - 5/16 Red Plastic Anchors		1.00	14.78/ea kit
WAKJ15R	20615/jar		50 - 12 x 1 1/4 Pan Square Drive Screws 1 - 5/16 Masonry Drill		.74	
WAK15S	39162/kit	5/16	50 - 5/16 Red Plastic Anchors		.88	11.80/ea kit
WAKJ15S	39163/jar		50 - 12 x 1 1/4 Ind. Hex Slotted Screw 1 - 5/16 Masonry Drill		.81	
WAK16QD	38980/kit	3/16	100 - 3/16 Red Plastic Anchors		.79	13.25/ea kit
WAKJ16QD	38981/jar		100 - 8 x 1 QUADRIVE / 1/4 HWH 1 - 3/16 Masonry Drill		.70	
						MADE IN USA Anchors & Screws ONLY METALLICS/Avanti Screw 
WAK14QD	39160/kit	1/4	100 - 1/4 Red Plastic Anchors		1.07	13.25/ea kit
WAKJ14QD	39161/jar		100 - 10 x 1 QUADRIVE / 5/16 HHS 1 - 1/4 Masonry Drill		1.03	
						MADE IN USA Anchors & Screws ONLY METALLICS/Avanti Screw 
WAK15QD	39164/kit	5/16	50 - 5/16 Red Plastic Anchors		.83	13.25/ea kit
WAKJ15QD	39165/jar		50 - 12 x 1 1/4 QUADRIVE / 5/16 HHS		.77	
						MADE IN USA Anchors & Screws ONLY METALLICS/Avanti Screw 

**METALLICS IS THE LARGEST ANCHOR KIT
 SOURCE IN AMERICA**

www.metalliconline.com

ANCHORING DEVICES



“DENVER BLUE” CONICAL PLASTIC WALL ANCHOR KITS

FOR LIGHT-DUTY APPLICATION

NOW WITH QUADRIVE OPTION!

IN SOME AREAS OF THE COUNTRY, TRADESMEN PREFER BLUE TO RED. SAME PRODUCT - DIFFERENT COLOR

MASTER
CARTONS
CONTAIN:
25 KITS
18 JARS

STOCK NO.	UPC NO.	SIZE	DESCRIPTION OF CONTENTS	WT. EACH	SUGGESTED TRADE LIST PRICE PER
WAK13B	20201/kit	3/16	100 - 3/16 Blue Plastic Anchors	.53	13.25/ea kit
WAKJ13B	20571/jar		100 - 6 x 1 Pan Combo Screws 1 - 3/16 Masonry Drill	.54	
WAK14B	20209/kit	1/4	100 - 1/4 Blue Plastic Anchors	.96	13.25/ea kit
WAKJ14B	20576/jar		100 - 10 x 1 Pan Combo Screws 1 - 1/4 Masonry Drill	.92	
WAK14TB	20204/kit	1/4	100 - 1/4 Blue Plastic Anchors	1.01	13.25/ea kit
WAKJ14TB	20577/jar		100 - 10 x 1 Pan Tri-Drive 1 - 1/4 Masonry Drill / 1 - 000R2B Bit	.93	13.25/ea kit Anchors & Screws ONLY METALLICS/Avanti Screw
WAK14HB	20213/kit	1/4	100 - 1/4 Blue Plastic Anchors	1.01	15.10/ea kit
WAKJ14HB	20578/jar		100 - 10 x 1 with 5/16 Hex Slotted Screws 1 - 1/4 Masonry Drill	.93	
WAK14QB	20216/kit	1/4	100 - 1/4 Blue Plastic Anchors	.88	15.10/ea kit
WAKJ14QB	20581/jar		100 - 10 x 1 with 1/4 Hex Slotted Screws 1 - 1/4 Masonry Drill	.80	
WAK14HBSS	20814/kit	1/4	100 - 1/4 Blue Plastic Anchors	1.00	34.88/ea kit NEW
WAKJ14HBSS	99416/jar		100 - 10 x 1 with 1/4 Hex Slotted Screws S.S. 1 - 1/4 Masonry Drill	1.00	
WAK14RB	20217/kit	1/4	100 - 1/4 Blue Plastic Anchors	1.03	14.28/ea kit
WAKJ14RB	20582/jar		100 - 10 x 1 Pan Square Drive Screws 1 - 1/4 Masonry Drill	.80	
WAK141B	20585/kit	1/4	100 - 1/4 Blue Zinc Anchors	1.00	13.25/ea kit NEW
WAKJ141B	20586/jar		100 - 10 x 1 1/4 Pan Square Drive Screws 1 - 1/4 Masonry Drill	1.00	
WAK15B	20211/kit	5/16	50 - 5/16 Blue Plastic Anchors	.84	14.28/ea kit
WAKJ15B	20606/jar		50 - 12 x 1 1/4 Pan Combo Screws 1 - 5/16 Masonry Drill	.80	
WAK15RB	20212/kit	5/16	50 - 5/16 Blue Plastic Anchors	1.00	14.78/ea kit
WAKJ15RB	20607/jar		50 - 12 x 1 1/4 Pan Square Drive Screws 1 - 5/16 Masonry Drill	.80	
WAK15SB	20417/kit	5/16	50 - 5/16 Blue Plastic Anchors	.85	11.80/ea kit
WAKJ15SB	39169/jar		50 - 12 x 1 1/4 Hex Slotted Screw 1 - 5/16 Masonry Drill	.85	

CONTINUED ON NEXT PAGE



Metallics Avanti Screw Manufacturing Facility in Bristol, CT



None of our competitors selling to the Electrical, Plumbing and HVAC Distribution trade can claim they manufacture screws.

There is no doubt: We know the American fastener market and are ahead of our competitors. Our Avanti Screw, Inc., fastener manufacturing facility in Bristol, CT, provides you an American fastener company who makes a portion of its product, sold through electrical, plumbing and HVAC distributors.

America's Source For Premier and Innovative Fasteners & Anchors

ANCHORING DEVICES



CONTINUED

"DENVER BLUE" CONICAL PLASTIC WALL ANCHOR KITS

FOR LIGHT-DUTY APPLICATION

MASTER
CARTONS
CONTAIN:
25 KITS
18 JARS

STOCK NO.	UPC NO.	SIZE	DESCRIPTION OF CONTENTS	WT. EACH	SUGGESTED TRADE LIST PRICE PER
WAK14QDB	39166/kit	1/4	100 - 1/4 Blue Plastic Anchors	1.07	13.25/ea kit
WAKJ14QDB	39167/jar		100 - 10 x 1 QUADRIVE 5/16 Hex Head Screws 1 - 1/4 Masonry Drill	1.03	Anchors & Screws ONLY METALLICS/Avanti Screw
WAK15QDB	39170/kit	5/16	50 - 5/16 Blue Plastic Anchors	.83	13.25/ea kit
WAKJ15QDB	39171/jar		50 - 12 x 1 1/4 QUADRIVE 5/16 Hex Head Screws 1 - 5/16 Masonry Drill	.80	Screws ONLY METALLICS/Avanti Screw



"SUPER YELLOW" PLASTIC WALL ANCHOR KITS

FOR LIGHT-DUTY APPLICATION

MASTER
CARTONS
CONTAIN:
25 KITS
18 JARS

STOCK NO.	UPC NO.	SIZE	DESCRIPTION OF CONTENTS	WT. EACH	SUGGESTED TRADE LIST PRICE PER
WAK18	20255/kit	3/16	100 - 3/16 Super Yellow Anchors	.58	15.93/ea kit
WAKJ18	20645/jar		100 - 6 x 1 Pan Combo Screws 1 - 3/16 Masonry Drill	.52	
WAK18T	20256/kit	3/16	100 - 3/16 Super Yellow Anchors	.75	15.93/ea kit
WAKJ18T	20646/jar		100 - 6 x 1 Pan Tri-Drive 1 - 3/16 Masonry Drill / 1 - 000R2B Bit	.55	Anchors & Screws ONLY METALLICS/Avanti Screw
WAK19	20260/kit	1/4	100 - 1/4 Super Yellow Anchors	1.01	17.93/ea kit
WAKJ19	20650/jar		100 - 10 x 1 Pan Combo Screws 1 - 1/4 Masonry Drill	.92	
WAK19T	20261/kit	1/4	100 - 1/4 Super Yellow Anchors	.97	17.93/ea kit
WAKJ19T	20651/jar		100 - 10 x 1 Pan Tri-Drive 1 - 1/4 Masonry Drill 1 - 000R2B Bit	1.01	Anchors & Screws ONLY METALLICS/Avanti Screw
WAK19H	21575/kit	1/4	100 - 1/4 Super Yellow Anchors	1.06	17.93/ea kit
WAKJ19H	20655/jar		100 - 10 x 1 with 5/16 Hex Head Screws 1 - 1/4 Masonry Drill	1.06	NEW
WAK19S	20262/kit	1/4	100 - 1/4 Super Yellow Anchors	1.11	18.63/ea kit
WAKJ19S	20670/jar		100 - 10 x 1 1/4 with 5/16 Hex Head Screws 1 - 1/4 Masonry Drill	1.11	
WAK19SS	20263/kit	1/4	100 - 1/4 Super Yellow Anchors	1.11	34.75/ea kit
WAKJ19SS	99470/jar		100 - 10 x 1 1/2 Pan Phillips Screws S.S. 1 - 1/4 Masonry Drill	1.11	NEW
WAK20	20265/kit	5/16	50 - 5/16 Super Yellow Anchors	.86	17.93/ea kit
WAKJ20	20680/jar		50 - 12 x 1 1/4 Pan Combo Screws 1 - 5/16 Masonry Drill	.76	
WAK191S	32192/kit	1/4	100 - 1/4 Super Yellow Anchors	1.01	18.50/ea kit
WAKJ191S	20673/jar		100 - 12 x 1 1/2 with 5/16 Hex Head Screws 1 - 1/4 Masonry Drill	1.05	NEW
SUPER YELLOW QUADRIVE					
WAK19QD	39176/kit	1/4	100 - 1/4 Plastic Anchors	1.07	17.93/ea kit
WAKJ19QD	39177/jar		100 - 10 x 1 QUADRIVE 5/16 Hex Head Screws 1 - 1/4 Masonry Drill	1.00	Anchors & Screws ONLY METALLICS/Avanti Screw



NEW



ANCHORING DEVICES



COLLARED VINYL WALL ANCHOR KITS

FOR LIGHT-DUTY APPLICATION

MASTER
CARTONS
CONTAIN:
25 KITS
18 JARS

STOCK NO.	UPC NO.	SIZE	DESCRIPTION OF CONTENTS	WT. EACH	SUGGESTED TRADE LIST PRICE PER
WAK17	20250/kit	1/4	100 - 1/4 Vinyl Anchors	1.00	15.93/ea kit
WAKJ17	20250/jar		100 - 10 x 1 Pan Combo Screws 1 - 1/4 Masonry Drill	.91	
WAK17T	20251/kit	1/4	100 - 1/4 Vinyl Anchors	1.05	15.93/ea kit
WAKJ17T	20621/jar		100 - 10 x 1 Pan Tri-Drive 1 - 1/4 Masonry Drill 1 - 000R2B Bit	.95	MADE IN USA Anchors & Screws ONLY METALLICS/Avanti Screw

COLLARED VINYL ANCHOR WITH QUADRIVE SCREWS

WAK17QD	39178/kit	1/4	100 - 1/4 Vinyl Anchors	1.05	15.93/ea kit
WAKJ17QD	39179/jar		100 - 10 x 1 QUADRIVE 5/16 Hex Head Screws 1 - 1/4 Masonry Drill	1.05	15.93/ea kit



ONLY METALLICS/Avanti Screw

America's newest Drive designed, developed and manufactured by Metallics/Avanti
THE QUADRIVE

ONLY METALLICS and Avanti Screw



EXPANDET LIGHT ROSETT NYLON WALL ANCHOR KITS

FOR LIGHT-DUTY APPLICATION

STOCK NO.	UPC NO.	SIZE	DESCRIPTION OF CONTENTS	WT. EACH	SUGGESTED TRADE LIST PRICE PER
WAK33	20270/kit	1/4	50 - 1/4 Expandet Nylon Anchors	.70	12.93/ea kit
WAKJ33	22229/jar		50 - 8 x 2 Pan Combo Screws 1 - 1/4 Masonry Drill	.66	
WAK33R	20272/kit	1/4	50 - 1/4 Expandet Nylon Anchors	.80	12.93/ea kit
WAKJ33R	20761/jar		50 - 8 x 2 Square Drive Screws 1 - 1/4 Masonry Drill	.65	
WAK34	20271/kit	5/16	25 - 5/16 Expandet Nylon Anchors	.65	12.93/ea kit
WAKJ34	22240/jar		25 - 12 x 2 Pan Combo Screws 1 - 5/16 Masonry Drill	1.00	

ANCHORING DEVICES



COLLARLESS VINYL WALL ANCHOR KITS

FOR LIGHT-DUTY APPLICATION
COLOR OF ANCHOR DETERMINED BY SIZE.

MASTER
CARTONS
CONTAIN:
25 KITS
18 JARS

STOCK NO.	UPC NO.	SIZE	DESCRIPTION OF CONTENTS	WT. EACH	SUGGESTED TRADE LIST PRICE PER
WAK7	20230/kit	3/16	100 - 3/16 Vinyl Anchors	.75	11.05/ea kit
WAKJ7	20500/jar		100 - 6 x 1 Pan Combo Screws 1 - 3/16 Masonry Drill	.75	
WAK8	20235/kit	1/4	100 - 1/4 Vinyl Anchors	1.01	11.75/ea kit
WAKJ8	20505/jar		100 - 10 x 1 Pan Combo Screws 1 - 1/4 Masonry Drill	.97	
WAK8T	20402/kit	1/4	100 - 1/4 Vinyl Anchors	1.07	11.75/ea kit
WAKJ8T	20646/jar		100 - 10 x 1 Pan Tri-Drive 1 - 1/4 Masonry Drill, 000R2B	.80	ONLY METALLICS/Avanti Screw 
WAK9	20240/kit	5/16	50 - 5/16 Vinyl Anchors	.86	12.93/ea kit
WAKJ9	20510/jar		50 - 12 x 1 1/4 Pan Combo Screws 1 - 5/16 Masonry Drill	.78	

WAK8QD	39180/kit	1/4	100 - 1/4 Vinyl Anchors	1.00	11.75/ea kit
WAKJ8QD	39181/jar		100 - 10 x 1 QUADRIVE 5/16 Hex Head 1 - 1/4 Masonry Drill	1.00	11.75/ea kit

The QuaDrive



Square Drive + Hex + Slotted + Phillips = QuaDrive

America's Newest Drive - Designed, Developed and Manufactured by Metallics/Avanti Screw

Anchors & Screws

MADE IN USA



ONLY METALLICS/Avanti Screw

ONLY METALLICS

America's newest Drive designed, developed and manufactured by Metallics/Avanti Screw

THE QUADRIVE

MANUFACTURING CAPABILITIES

Diameter range #2 thru 5/16" / 1.5mm thru 8mm • Length range 1/8" thru 3" / 3.5mm thru 75mm
Materials: Steel, Brass, Stainless, Aluminum, Bronze.

NEED SCREWS...
Let Us Make Them For You!



A METALLICS AFFILIATE

P.O. Box 1600 • 231 Cross Street
Bristol, CT 06011-1600
Tel: 800-984-8945 • Fax: 800-984-8946

CAPABILITIES LIST

PLANT SIZE: 100,000 SQUARE FEET
LOCATION: Bristol, Connecticut
EQUIPMENT: 27 Hi-Speed Cold Headers
8 Burr-Free Screw Slotters
3 Shank Slotters
2 Pointers
14 High Speed Thread Rollers

ADDITIONAL PLANT INFO: Modern shipping facility utilizing digital scale counting machines. In-house packaging facilities - boxing, sorting, bagging. All material boxed, palletized & labeled with your needs in mind for domestic or export shipping.

SECONDARY WORK: All plating & heat treating is done on the outside and certified for your guarantee.

INFORMATION SYSTEMS: Our facility has new and upgraded Technology to meet your customers specific requirements.



ANCHORING DEVICES



GRAY CONICAL PLASTIC WALL ANCHOR KITS

FOR LIGHT-DUTY APPLICATION

MASTER CARTONS CONTAIN:
25 KITS
18 JARS

NOW WITH QUADRIVE OPTION!

STOCK NO.	UPC NO.	SIZE	DESCRIPTION OF CONTENTS	WT. EACH	SUGGESTED TRADE LIST PRICE PER
WAK22	10500/kit	3/16	100 - 3/16 Gray Ribbed Anchors	.55	10.93/ea kit
WAKJ22	20730/jar		100 - 6x1 Pan Combo Screws 1 - 3/16 Masonry Drill	.50	
WAK25	20410/kit	3/16	100 - 3/16 Gray Ribbed Anchors	.57	12.25/ea kit NEW
WAKJ25	20751/jar		100 - 8x1 Pan Combo Screws 1 - 3/16 Masonry Drill	.57	
WAK23	20400/kit	1/4	100 - 1/4 Gray Ribbed Anchors	1.01	13.25/ea kit
WAKJ23	20740/jar		100 - 10 x 1 Pan Combo Screws 1 - 1/4 Masonry Drill		
ANCHOR KIT DESIGNED FOR RACEWAY					
WAK23F	39182/kit	1/4	100 - 1/4 Gray Ribbed Anchors	1.01	13.25/ea kit
WAKJ23F	20745/jar		100 - 10 x 1 Flat Head Phillips Screws 1 - 1/4 Masonry Drill		
WAK23T	20401/kit	1/4	100 - 1/4 Gray Ribbed Anchors	1.01	13.25/ea kit
WAKJ23T	20767/jar		100 - 10 x 1 Pan Tri-Drive 1 - 1/4 Masonry Drill / 1 - 000R2B Bit		
WAK24	20405/kit	5/16	50 - 5/16 Gray Ribbed Anchors	1.00	15.48/ea kit
WAKJ24	20750/jar		50 - 12 x 1 1/4 Pan Combo Screws 1 - 5/16 Masonry Drill		



Screws METALLICS/Avanti Screw

WAK23QD	39184/kit	1/4	100 - 1/4 Gray Ribbed Anchors	1.01	13.25/ea kit
WAKJ23QD	39185/jar		100 - 10 x 1 QuaDrive 5/16 Hex Head 1 - 1/4 Masonry Drill		

The QuaDrive

Square Drive + Hex + Slotted + Phillips = QuaDrive

America's Newest Drive - Designed, Developed and Manufactured by Metallics/Avanti Screw

MADE IN USA

Screws METALLICS/Avanti Screw

ONLY METALLICS

America's newest Drive designed, developed and manufactured by Metallics/Avanti Screws

THE QUADRIVE



JAR DISPLAY CENTER
Holds 18 Jars

ATTENTION
ON LARGE ORDERS OF ANCHOR KITS —
OUR PRICE CAN BE EVEN LOWER!



50 KITS
Order two master cartons of this kit and receive an added **10% Discount!**

QUANTITY DISCOUNTS:
10% DISCOUNT ON 50-99 LIKE KITS
OR
15% DISCOUNT ON 100+ LIKE KITS

Please Call Us for Co-Labeling on Kits!

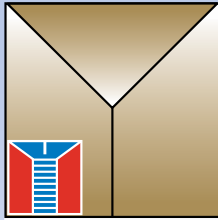

Metallics



Plastic Anchor Kit

- Four Different Style Anchors
- Drill Bits included
- Screws and Driver Bit included
- One four compartment Plastic Case

E

PART #	UPC #	DESCRIPTION	QTY / PKG	SUG. TRADE LIST / PKG
		Super Yellow 3/16" Plastic Anchor	20	
		#8 x 1" Pan Head Combo Sheet Metal Screw	20	
		3/16" x 4" High Speed Drill Bit	1	
		Big Red 1/4" Plastic Anchors	20	
		#10 x 1" Pan Head Combo Sheet Metal Screw	20	
WAKQUAD	38995	1/4" x 4" High Speed Drill Bit	1	\$ 28.58
		Super Yellow 1/4" Plastic Anchor	20	
		#10 x 1" Pan Head Combo Sheet Metal Screw	20	
		1/4" x 4" High Speed Drill Bit	1	
		Denver Blue 5/16" Plastic Anchors	20	
		#12 x 1-1/4" Pan Head Combo Sheet Metal Screw	20	
		5/16" x 4-1/2" High Speed Drill Bit	1	
		#2 Phillips Power Bit 2" Long	1	

★ ★ ★ ★ ★ *"Growth Through Innovation"* ★ ★ ★ ★ ★

Metallics

229 Cross Street, Bristol, CT 06010
Tel 800-243-8272 • **Fax** 800-831-9358
Email sales@metallicsonline.com

Metallics West

651 North Main Street, Mancos, CO 81328
Tel 800-269-5183 • **Fax** 800-269-6278
Email saleswest@metallicsonline.com

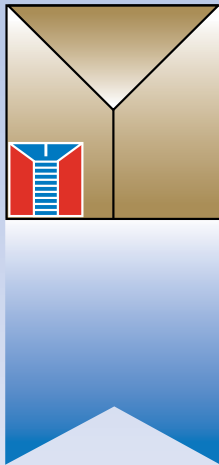

Metallics



Toggler®

Alligator® Solid Wall Anchor Kit

- Alligator® solid-wall anchors can be used in most any material, including: Concrete, Wood, Plaster, Aerated Concrete, Block, Masonry, Stone, Flakeboard, Cinder Block, Ceramic Tile, Stucco, and Drywall.
- Alligator® solid-wall anchors are designed to support heavy loads. (Even under vibration!)

The Alligator anchor is the only anchor that extrudes the entire length of the screw.

The screw extrudes and compresses all the plastic into the wall of the hole under tremendous pressure. The plastic molds and conforms exactly to the surface of the hole (including all the hole's imperfections). All forces supported by the screw are transmitted around the anchor to the wall of the hole. This provides greater holding power by distributing the force over the maximum area possible.

PART #	UPC #	DESCRIPTION	QTY / PKG	SUG. TRADE LIST / PKG
		3/16 Alligator Solid-Wall Anchor with Flange	20	
		#8 x 1" Pan Head Combo Sheet Metal Screw	20	
		3/16 x 4" Masonry Drill Bit	1	
		1/4 Alligator Solid-Wall Anchor with Flange	20	
		#10 x 1" Pan Head Combo Sheet Metal Screw	20	
TSWAK	73998	1/4 x 4" Masonry Drill Bit	1	\$ 41.95
		1/4 Alligator Solid-Wall Anchor No Flange	20	
		#10 x 1" Pan Head Combo Sheet Metal Screw	20	
		1/4 x 4" Masonry Drill Bit	1	
		5/16 Alligator Solid-Wall Anchor with Flange	15	
		#12 x 1-1/4" Pan Head Combo Sheet Metal Screw	15	
		5/16 x 4" Masonry Drill Bit	1	
		#2 Phillips Power Bit 2" Long	1	

★ ★ ★ ★ ★ "Growth Through Innovation" ★ ★ ★ ★ ★

Metallics

229 Cross Street, Bristol, CT 06010
Tel 800-243-8272 • **Fax** 800-831-9358
Email sales@metallicsonline.com

Metallics West

651 North Main Street, Mancos, CO 81328
Tel 800-269-5183 • **Fax** 800-269-6278
Email saleswest@metallicsonline.com

TOGGLER®, ALLIGATOR® ARE A REGISTERED TRADEMARK



Metallics

SNAPSKRU®

Self-Drilling Drywall Anchors



The Strongest, easiest-to-use self-drilling drywall anchor—

INSTALLATION INSTRUCTIONS: Tools Needed

Screw gun with #2 Phillips bit (or #2 Phillips screwdriver, or electric drill with clutch mechanism & #2 bit)



Press tip of SnapSkru® anchor into drywall using #2 Phillips screwdriver or screw gun. Drive anchor clockwise into drywall until anchor stops flush with the outer wall surface. *TIP: To keep anchor in precise position during installation (critical for aligning several anchors), push tip of screwdriver into drywall to mark insertion point.*

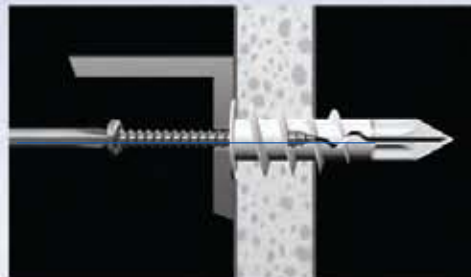

Screw for *MINI* anchor:
#6 through #8 (#6 preferred).
[3.5-4.5mm, 4mm preferred]

Screw for *Regular* anchor:
#6 through #10 (#8 preferred).
[3.5-4.5mm, 4mm preferred]

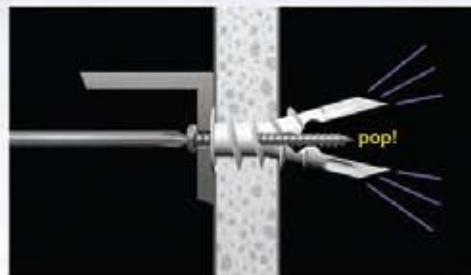

Tighten screw flush with item.

The screw pops open the anchor, locking it on the wall and holding the gypsum board in compression. This reinforces the wall, increasing its holding power significantly.

Screw Length = Thickness of item being installed plus 1-1/4".

Another **NEW** exciting solution from Metallics!
Tired of searching for the right Anchor **Here it is!**

Toggler® SnapSkru®...

Stock Number	UPC#	Description	Quantity Per Pkg.	Suggested Trade List Per Pkg.
ASPM	73921	Toggler SnapSkru® Mini	50	\$23.93
ASP	73920	Toggler SnapSkru® Regular	50	\$30.95

Metallics

229 Cross Street,
Bristol, Ct. 06010
Tel: 800-243-8272
Fax: 800-831-9358
Email: sales@metallicsonline.com

"Growth Through Innovation"

Metallics West

651 North Main Street
Mancos, Co. 81328
Tel: 800-269-5183
Fax: 800-269-6278
Email: saleswest@metallicsonline.com

SNAPSKRU® IS A REGISTERED TRADEMARK
TOGGLER® IS A REGISTERED TRADEMARK

ANCHORING DEVICES



SELF-DRILLING WALL ANCHORS

A unique series of self-drilling Anchoring Products distributed and sold by Metallics through a special agreement

NOTE: Due to possible differences in specifications, applications and interpretation of results, purchasers must make their own evaluation of the product to determine the suitability of anchor.

**MASTER
CARTONS
CONTAIN:
25 KITS
18 JARS**

ANCHOR TYPE	Pullout (ultimate average lbs) Gypsum Thickness			Shear (ultimate average lbs) Gypsum Thickness		
	3/8"	1/2"	5/8"	3/8"	1/2"	5/8"
#6	40	45		92	103	
#8	45	50	75	100	110	105



SELF-DRILLING WALL ANCHOR ZINC

WORKS GREAT IN DOUBLE DRYWALL AND STUDS
COMBO DRIVE #3 PHILLIPS

PULLOUT (ULTIMATE AVERAGE LBS) GYPSUM THICKNESS		
3/8"	1/2"	5/8"
40	50	75

STOCK NO.	UPC NO.	SIZE	DESCRIPTION	PKG. QTY	WT. PER PKG.	SUGGESTED TRADE LIST PRICE PER
ZSTU1J	81315/jar	8 x 1 1/4	Zinc Screw Anchors w/ PPH screws	50	1.5lbs	26.73/ea kit
ZSTU1K	81319/kit	8 x 1 1/4	Zinc Screw Anchors w/ PPH screws	50	1.5lbs	26.73/ea kit
ZSTU1M	81323	8 x 1 1/4	Zinc Screw Anchors w/ PPH screws	1000	15.06	246.10/M NEW



SELF-DRILLING WALL ANCHOR ZINC

WORKS GREAT IN DRYWALL
COMBO DRIVE #3 PHILLIPS

STOCK NO.	BOX UPC NO.	JAR UPC NO.	SCREW SIZE	DESCRIPTION	WT. EACH	STD. PKG.	SUGGESTED TRADE LIST PRICE PER
JZSA1		80973	#8	100 - Zinc Screw Anchors	1.40	100	41.98/c
ZSA1M	33261	-	#8	1000 - Zinc Screw Anchors	13.15	1000	335.70/M



ANCHOR KITS IN BOX AND JAR

						SUGGESTED TRADE LIST PRICE PER KIT
ZSA1K/box	33265/box	#8	50 - Zinc Screw Anchors	1.07		26.00/ea kit
ZSA1J/jar	20710/jar		50 - 8 x 1 1/4 Pan Head Combo Screws	1.03		
ZSA1TK/box	33266/box	#8	50 - Zinc Screw Anchors	1.07		26.00/ea kit
ZSA1TJ/jar	20269/jar		50 - 8 x 1 1/4 Pan Head Tri-Drive Screws	1.01		
			1 - 100R2B Bit			

ANCHORING DEVICES



SELF-DRILLING WALL ANCHOR ZINC-LITE

WORKS GREAT IN DRYWALL • COMBO DRIVE #2 PHILLIPS
Uses #6-8 sheet metal **or** #6-8 drywall screws

STOCK NO.	JAR UPC NO.	SCREW SIZE	DESCRIPTION OF CONTENTS	WT. EACH	STD. PKG.	SUGGESTED TRADE LIST PRICE PER
JZSAL2	80974	#6 or #8	100 - Zinc Alloy Anchor Lite	.85	100	29.88/c



ANCHOR KITS IN BOX AND JAR

SUGGESTED TRADE LIST PRICE PER KIT

ZSAL2K/box	33267/box	#6	50 - Zinc Alloy Anchor Lite	.66	1	18.15/ea kit
ZSAL2J/jar	33268/jar		50 - 6 x 1 Pan Head Combo Screws	.64	1	18.15/ea kit



SELF-DRILLING WALL ANCHOR NYLON

WORKS GREAT IN DRYWALL • COMBO DRIVE #3 PHILLIPS



STOCK NO.	JAR UPC NO.	SCREW SIZE	DESCRIPTION	WT. EACH	STD. PKG.	SUGGESTED TRADE LIST PRICE PER
JPSA1	80975	#6, #8	100 - Plastic Anchors	.40	100	41.98/c
PSA1M	19824	#6, #8	1M/PACK - Plastic Anchors	4.50	1000	268.55/m NEW



ANCHOR KITS IN BOX AND JAR

SUGGESTED TRADE LIST PRICE PER

PSA1K/box	29495	#6, #8	50 - Plastic Anchors	.59	1	26.00/ea kit
PSA1J/jar	20705		50 - 8 X 1-1/4 Pan Head Combo Screws	.56	1	26.00/ea kit



SELF-DRILLING WALL ANCHOR NYLON-LITE

WORKS GREAT IN DRYWALL • COMBO DRIVE #2 PHILLIPS



STOCK NO.	JAR UPC NO.	SCREW SIZE	DESCRIPTION	WT. EACH	STD. PKG.	SUGGESTED TRADE LIST PRICE PER
JPSAL2	80976	#6	100 - Plastic Anchor Lite	.23	100	29.98/c



ANCHOR KITS IN BOX AND JAR

STD. PKG.

SUGGESTED TRADE LIST PRICE PER

PSAL2K/box	19827	#6	50 - Plastic Anchor Lite	.35	1	18.15/ea kit
PSAL2J/jar	20700		50 - 6 X 1 Pan Head Combo Screws	.33	1	18.15/ea kit



ANCHORING DEVICES



TOGGLE ANCHOR

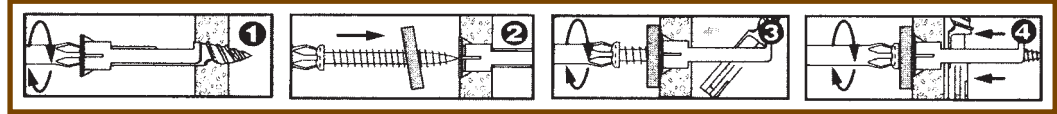

STOCK NO.	JAR UPC NO.	SCREW SIZE	DESCRIPTION	WT. EACH	STD. PKG.	SUGGESTED TRADE LIST PRICE PER
JEZT1	80977	#10	50 - Toggles 50 - 10-24 x 2 Pan Head Combo Machine Screws - Zinc Plated	2.01	50	69.18/ea kit



STOCK NO.	JAR UPC NO.	SCREW SIZE	DESCRIPTION	WT. EACH	STD. PKG.	SUGGESTED TRADE LIST PRICE PER
ANCHOR KITS IN BOX AND JAR						
EZT1K/box	33275	#10	25 Toggles	1.11	1	36.25/ea kit
EZT1J/jar	20715		25 10-24 x 2 Pan Head Combo Machine Screws Zinc Plated	1.24	1	36.25/ea kit

AMERICA'S SOURCE FOR PREMIER AND INNOVATIVE FASTENERS & ANCHORS



A Modern Up to Date Roll Threading Machine at our Affiliate, Avanti Screw.



Metallics and Avanti Screw, Inc., prime American manufacturers of fastener products, have always worked to present the latest in fastener technology to our distributors and their contractors/users.

Hex Washer Head fasteners have historically only offered three drives-the hex, phillips and the slot. In 1999, we introduced "The QuaDrive" square, hex, slotted and Phillips, in fourteen of the most popular sizes of sheet metal screws.

The QuaDrive

◊ + ◻ + ◐ + ⊕ = ⊞
Square Drive Hex Slotted Phillips QuaDrive

America's Newest Drive - Designed, Developed and Manufactured by Metallics/Avanti Screw

These sheet metal screws are being manufactured to fill the need of the growing demand in the North American markets.

Please note: We recommend driving these sheet metal screws with a hex driving tool. The slotted, Phillips, hex and square drives make it convenient for disassembly. See page 185.

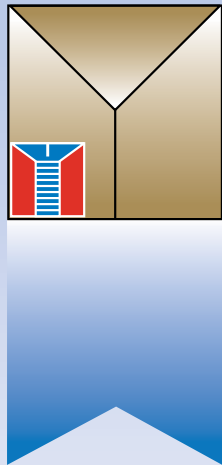

Metallics



Toggler Snapskru® Kit & Bulk

**[CONTRACTOR
APPROVED]**

Self-Drilling Drywall Anchors

The Strongest, easiest-to-use self-drilling drywall anchor—

Another **NEW** exciting solution from Metallics! Tired of searching for the right Anchor? **Here it is!** Toggler Snapskru®...

INSTALLATION INSTRUCTIONS: Tools Needed

Screw gun with #2 Phillips bit (or #2 Phillips screwdriver, or electric drill with clutch mechanism & #2 bit)

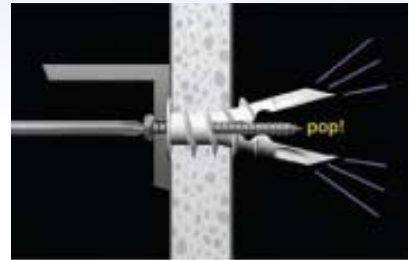
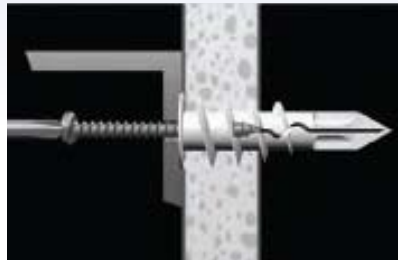

Press tip of Snapskru anchor into drywall using #2 Phillips screwdriver or screw gun. Drive anchor clockwise into drywall until anchor stops flush with the outer wall surface. *TIP: To keep anchor in precise position during installation (critical for aligning several anchors), push tip of screwdriver into drywall to mark insertion point.*

Screw for *MINI* anchor:
#6 through #8 (#6 preferred).
[3.5-4.5mm, 3.5mm preferred]

Screw for *REGULAR* anchor:
#6 through #10 (#8 preferred).
[3.5-4.5mm, 4mm preferred]

Tighten screw flush with item.

The screw pops open the anchor, looking it on the wall and holding the gypsum board in compression. This reinforces the wall, increasing its holding power significantly.

Screw Length = Thickness of item being installed plus 1-1/4".

PART #	UPC #	DESCRIPTION	SUG. TRADE LIST / PKG
ASP1K	78446	50 pcs Toggler Snapskru Reg. / 50 pcs #8 x 1-1/2" Pan Hd Combo SMS / 1 #2 Phillips Power Bit 2" lg.	\$ 28.05
ASP1J	78445	50 pcs Toggler Snapskru Reg. / 50 pcs #8 x 1-1/2" Pan Hd Combo SMS / 1 #2 Phillips Power Bit 2" lg.	\$ 28.05
ASP1M	78447	1000 pcs Toggler Snapskru Regular	\$ 276.50
ASPM1K	78461	50 pcs Toggler Snapskru Mini / 50 pcs #6 x 1-1/2" Pan Hd Combo SMS / 1 #2 Phillips Power Bit 2" lg.	\$ 28.05
ASPM1J	78460	50 pcs Toggler Snapskru Mini / 50 pcs #6 x 1-1/2" Pan Hd Combo SMS / 1 #2 Phillips Power Bit 2" lg.	\$ 28.05
ASPM1M	78462	1000 pcs Toggler Snapskru Mini	\$ 224.50

"Growth Through Innovation"

Metallics

229 Cross Street, Bristol, CT 06010
Tel 800-243-8272 • Fax 800-831-9358
Email sales@metallicsonline.com

Metallics West

651 North Main Street, Mancos, CO 81328
Tel 800-269-5183 • Fax 800-269-6278
Email saleswest@metallicsonline.com

SNAPSKRU® IS A REGISTERED TRADEMARK
TOGLER® IS A REGISTERED TRADEMARK

ANCHORING DEVICES

STRAP-TOGGLE ANCHOR

FOR HEAVY-DUTY APPLICATION
Designed for use in plaster, wallboard,
concrete block or hollow tile

PACKAGED
IN POLY
BAG

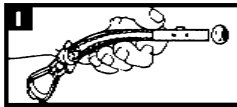
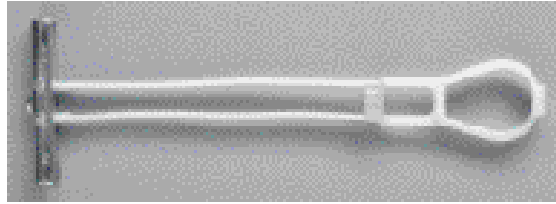

1 Drill appropriate sized hole. Hold metal channel flat alongside plastic straps and slide channel through hole.

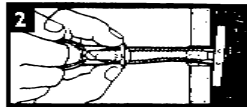

2 Pull on ring so metal channel rests flush behind wall, as you slide plastic cap along straps with other hand, until flange of cap is flush with wall.

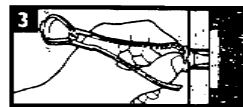

3 Place thumb between plastic straps. Push to side, snapping off straps flush with wall.

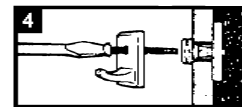

4 Insert bolt through item to be attached and tighten until flush with fixture. Minimum clearance behind wall is 1 7/8".

STOCK NO.	UPC NO.	SCREW SIZE	ANCHOR SIZE	DRILL	DESCRIPTION OF CONTENTS	WT. PER PKG.	STD. PKG.	SUGGESTED TRADE LIST PRICE PER
NT316	18501	10-24	3/16 x 4	1/2	50 - 3/16 x 4 Strap-Toggle Anchors	1.38	50	59.60/ea. pkg.
NT14	18502	1/4-20	1/4 x 4	1/2	50 - 1/4 x 4 Strap-Toggle Anchors	1.37	50	59.60/ea. pkg.
NT38	18510	3/8-4	3/8 x 4	1/2	100 - 3/8 x 4 Strap-Toggle Anchors	5.86	100	191.35/ea. pkg. NEW

Because a wide variety of screws work with this Toggle Anchor, Metallics has chosen not to offer them in a kit, but rather to allow the user to choose the screw that works best for each particular application. Please see Screw/Section A for a full listing of our machine screws.

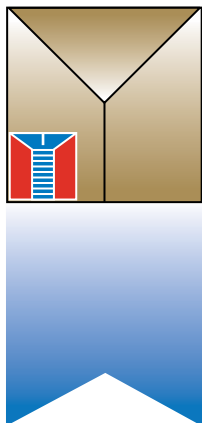

This is the
Heading Line
at
Avanti Screw, Inc.,
A Metallics
Affiliate
Bristol, CT.



We work hard at trying to be the best in America!
America's Source For Premier & Innovative Fasteners.



MADE IN USA





Metallics SNAPTOGGLE®

Secure Installations in Seconds-Not Minutes!
Grip range 3/8"-2 1/2" (9mm-64mm)



Total Anchoring Security!

TOGGLER® Brand Toggle Bolts for
Maximum Strength & Precise Alignment

- Hollow Block
- Cinder Block
- Concrete Block
- Cement Board
- Hollow Brick
- Stucco
- Gypsum Board/Drywall
- Plaster
- Composite Panels
- Fiberglass
- Boat Decks
- Paneling

*Another NEW
exciting solution
from Metallics!
Toggler® Brand
Snaptoggle® the
strongest togglebolt
in the smallest hole!*

1. Drill 1/2" hole. Hold metal channel flat alongside plastic straps, slide channel through hole.
2. With one hand, pull ring so metal channel rests flush behind wall. Slide plastic cap along straps with other hand until flange of cap is flush with wall.
3. Place thumb between plastic straps. Push side to side snapping off straps flush with wall.
4. Insert bolt through item to be attached and tighten until flush with fixture. Minimum clearance behind wall: 1-7/8" (48mm)

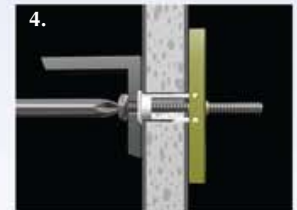
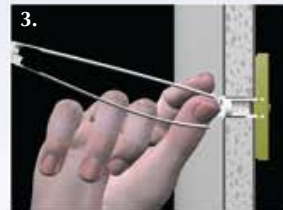
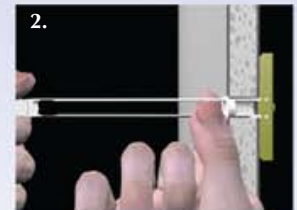

Stock Number	UPC#	Description	Quantity Per Pkg.	Suggested Trade List Per Pkg.
MBA25	73944	Toggler Snaptoggle #10-24	25	\$41.45
MBA50	73971	Toggler Snaptoggle #10-24	50	\$75.83
MBB25	73945	Toggler Snaptoggle 1/4-20	25	\$41.45
MBB50	73972	Toggle Snaptoggle 1/4-20	50	\$75.83

Metallics

229 Cross Street,
Bristol, Ct. 06010
Tel: 800-243-8272
Fax: 800-831-9358
Email: sales@metallicsonline.com

"Growth Through Innovation"

Metallics West

651 North Main Street
Mancos, Co. 81328
Tel: 800-269-5183
Fax: 800-269-6278
Email: saleswest@metallicsonline.com

SNAPTOGGLE® IS A REGISTERED TRADEMARK

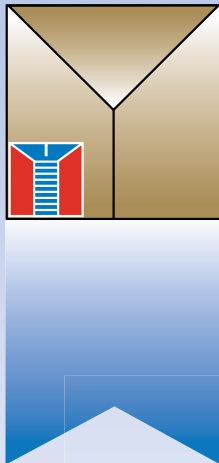

Metallics



Air Handling Cable Ties

(Plenum Rated)

Standard Mounting Hole
Low Profile



[CONTRACTOR APPROVED]

- **Ideal Application:** Air Handling Spaces, above drop ceilings and below raised flooring
- **Meets UL 1565** low smoke generation, low heat release, and mechanical strength test
- **UL Listed** suitable for use in Air Handling Spaces in accordance with the Section 300.22 (C) and (D) of the National Electrical Code and Rules 12-010 (3), (4), and (5) and 12-020 of the Canadian Electrical Code, Part 1
- **Strong and Pure** manufactured from filtered nylon 6/6 reducing particle contamination
- **Mounting Hole Style** secures and positions wire bundles, cables, etc. to surfaces with one mechanical fastener
- **Low Profile Style** reduces head height increases safety, eliminates snags, cuts, and abrasions to cables, surrounding products, and users

Another **NEW** and **EXCITING** solution from Metallics!
Tired of searching for the right Air Handling Cable Ties? Here they are!

PART #	UPC #	DESCRIPTION	LENGTH IN.	TIE TENSILE LBS.	QTY / PKG	SUGGESTED TRADE LIST / PKG
CTAH7S	22672	Standard	7	50	100	\$16.63/c
CTAH11S	22682	Standard	11	50	100	\$35.38/c
CTAH14S	22693	Standard	14	50	100	\$46.30/c
CTAH7MH	22671	Mounting Hole	7	50	100	\$28.40/c
CTAH7LP	22670	Low Profile	7	50	100	\$38.28/c

“Growth Through Innovation”

Metallics

229 Cross Street, Bristol, CT 06010
Tel 800-243-8272 • Fax 800-831-9358
Email sales@metallicsonline.com

Metallics West









651 North Main Street, Mancos, CO 81328
Tel 800-269-5183 • Fax 800-269-6278
Email saleswest@metallicsonline.com

CABLE TIES AND ACCESSORIES

NYLON CABLE TIES

WHITE NYLON AND BLACK UV STABILIZED
ALL CABLE TIES PACKAGED IN PLASTIC BAGS



STOCK NO.	UPC NO.	MIN. TENSILE STRENGTH	MAX. BUNDLE DIAMETER	OVERALL LENGTH	WT. PER PKG.	STD. PKG.	SUGGESTED TRADE LIST PRICE
WHITE NYLON BENT TIP CABLE TIE - 100 PACK							
							
CT1	22600	18 LBS	3/4	4	.07	100	2.75/c
CT2	22605	18 LBS	1 3/8	6	.09	100	4.88/c
CT3	22610	40 LBS	1 1/4	5	.16	100	4.80/c
CT6	22615	50 LBS	2	7	.27	100	6.28/c
CT4	22620	50 LBS	2 3/4	11	.39	100	12.70/c
CT5	22625	50 LBS	4 1/2	14	.49	100	14.95/c
WHITE NYLON 1000 AND 500 PACK							
							
CT1B	22601	18 LBS	3/4	4	.62	1000	24.85/m
CT2B	22606	18 LBS	1 3/8	6	.89	1000	44.00/m
CT3B	22611	40 LBS	1 1/4	5	1.53	1000	43.30/m
CT6B	22616	50 LBS	2	7	3.00	1000	56.40/m
CT4B	22621	50 LBS	2 3/4	11	1.97	500	57.25/ea. pkg.
CT5B	22626	50 LBS	4 1/2	14	2.59	500	67.15/ea. pkg.
BLACK WEATHER-RESISTANT UV-STABILIZED CABLE TIE 100 PACK							
							
CT1UV	22645	18 LBS	3/4	4	.07	100	2.98/c
CT6UV	22650	50 LBS	2	7	.30	100	6.68/c
CT4UV	22655	50 LBS	2 3/4	11	.39	100	13.35/c
CT5UV	22660	50 LBS	4 1/2	14	.50	100	15.73/c
CT21UV	22659	50 LBS	6	21	.75	100	121.32/c NEW
BLACK UV 1000 AND 500 PACK							
							
CT1UVB	22646	18 LBS	3/4	4	.62	1000	26.85/m
CT3UVB	22612	50 LBS	1 1/4	5	3.00	1000	50.00/m NEW
CT6UVB	22651	50 LBS	2	7	2.76	1000	60.10/m
CT4UVB	22656	50 LBS	2 3/4	11	2.02	500	60.10/ea. pkg.
CT5UVB	22661	50 LBS	4 1/2	14	2.41	500	70.65/ea. pkg.
WHITE NYLON - 100 PACK MOUNTING TAB CABLE TIE							
							
MCT10	22700	30 LBS	3/4	5	.19	100	12.63/c
MCT12	22710	50 LBS	2	7	.34	100	14.68/c
MCT13	22715	50 LBS	3	11	.43	100	23.10/c
MCT14	22720	120 LBS	4	14	.56	100	33.38/c
NEW BLACK NYLON - 100 PACK MOUNTING TAB CABLE TIE							
							
MCT15BLK	22764	120 LBS	4	15 5/16	1.33	100	37.48/c NEW
HEAVY DUTY - 50 PACK WHITE NYLON ADJUSTABLE CLAMPS							
							
HCT19	22800	120 LBS	4 1/4	14	.65	50	16.48/ea. pkg.
HCT21	22810	175 LBS	5 7/8	24	.95	50	33.50/ea. pkg.
HCT22	22815	175 LBS	9 3/4	33	2.05	50	39.70/ea. pkg.
NEW HEAVY DUTY - 50 PACK BLACK UV							
							
HCT22UV	22816	175 LBS	9 3/4	33	.85	25	30.23/ea. pkg. NEW
NEW HORIZONTAL I.D. TIE							
							
CT1HID	22602	18 LBS	3/4	4	.55	100	15.10/c NEW

F

CABLE TIES AND ACCESSORIES



ASSORTED CABLE TIES IN A BAG

A handy assortment of popular sizes
in one convenient package so
you're ready for any job!

PACKAGED IN PLASTIC BAGS

FOUR POPULAR SIZES IN EACH BAG

BENT TIP TIES

AVAILABLE IN WHITE NYLON OR BLACK UV STABILIZED



STOCK NO.	UPC NO.	DESCRIPTION OF CONTENTS	STD. PKG.	WT. PER BAG	SUGGESTED TRADE LIST PRICE PER
WHITE NYLON					
CTA1	22825	Bag of 100 Cable Ties includes: 25 CT1 4" White Nylon Ties 25 CT6 7" White Nylon Ties 25 CT4 11" White Nylon Ties 25 CT5 14" White Nylon Ties	1 Bag	.31	11.70/ea
BLACK UV STABILIZED					
CTUVA1	22826	Bag of 100 Cable Ties includes: 25 CT1UV 4" Black Weather Resistant Ties 25 CT6UV 7" Black Weather Resistant Ties 25 CT4UV 11" Black Weather Resistant Ties 25 CT5UV 14" Black Weather Resistant Ties	1 Bag	.32	12.90/c

F



VELCRO® CABLE TIES

PACKAGED IN PLASTIC BAGS



FEATURES

- Eliminates the potential for damage to fiber optics or cables caused by overcinching or accidental cutting.
- Easy to install and adjust without installation tools.
- Reusable

APPLICATIONS

- Wire and cable assemblies
- Fiber optic installations
- Network installations
- Electrical/electronics products

Maximum loop tensile strength:
Roll - 50 lbs Loop ties - 40 lbs

STOCK NO.	UPC NO.	DESCRIPTION	WT. PER PKG.	STD. PKG.	SUGGESTED TRADE LIST PRICE PER
VR12	22801	Velcro® Roll - 1/2" x 15'	.08	One Roll	14.68/ea
VR34	22802	Velcro® Roll - 3/4" x 15'	.13	One Roll	18.15/ea
VT8	22803	Velcro® Loop Tie - 1" tab 1/2" width x 8"	.05	10 Loop Ties	15.20/ea
VT12	22804	Velcro® Loop Tie - 1" tab 1/2" width x 12"	.07	10 Loop Ties	20.95/ea

VELCRO® IS A REGISTERED TRADEMARK

CABLE TIES AND ACCESSORIES



CABLE TIE TOOL

FEATURES A SHORT SQUEEZE STROKE

The cut-off feature ensures a consistently flush, burr-free edge

Polycarbonate Construction

STOCK NO.	UPC NO.	SIZE	WT. EACH	STD. PKG.	SUGGESTED TRADE LIST PRICE PER
RT2	23215	Accepts Cable Tie series CT-1 through MCT14	.78	1	72.93/ea



CABLE CLAMPS

WHITE & BLACK NYLON PLASTIC

Clamps are designed with bevelled inside edges to prevent damage to cables from chafing, Molded to shape and size.



STOCK NO.	UPC NO.	WIRE SIZE	MOUNTING SCREW DIA.	WT. PER PKG.	STD. PKG.	SUGGESTED TRADE LIST PRICE PER
WHITE						
NCC116	23102	1/16	3/16	.03	100	9.75/c NEW
NCC0	23100	1/8	3/16	.09	100	7.23/c
NCC1	23103	3/16	3/16	.09	100	9.83/c NEW
NCC3	23107	5/16	5/16	.09	100	16.15/c NEW
NCC2	23105	1/4	3/16	.11	100	10.15/c
NCC4	23110	3/8	3/16	.24	100	12.38/c
NCC6	23115	1/2	3/16	.28	100	14.00/c
NCC7	23117	5/8	3/16	.35	100	14.28/c NEW
NEW BLACK						
NCC4BLK	23132	3/8	3/16	.16	100	12.83/c NEW
NCC6BLK	23137	1/2	3/16	.25	100	14.78/c NEW



CABLE CLAMPS

STEEL ZINC PLATED



STOCK NO.	UPC NO.	WIRE SIZE	MOUNTING SCREW DIA.	WT. PER PKG.	STD. PKG.	SUGGESTED TRADE LIST PRICE PER
SCC316	21546	3/16	3/16	.56	100	16.95/c
SCC14	21541	1/4	3/16	.61	100	17.35/c
SCC38	21543	3/8	3/16	.79	100	19.18/c
SCC12	21540	1/2	3/16	.46	50	10.50/ea. pkg.
SCC58	21544	5/8	3/16	.65	50	12.23/ea. pkg.
SCC34	21542	3/4	1/4	.37	25	6.60/ea. pkg.
SCC78	21545	7/8	1/4	.41	25	7.03/ea. pkg.

Helpful Hints From Metallics:

Did You forget to ask?

GOT FASTENERS?

"We work hard to improve both Distributor Profit and Customer Satisfaction."

CABLE TIES AND ACCESSORIES

NEOPRENE WRAPPED STEEL CABLE CLAMPS



Light to medium duty steel cable clamp with neoprene cushion for electrical insulation and vibration absorption

- Steel clamps are electroplated for corrosion resistance
- Silver with black neoprene
- Mounts to steel, wood or concrete
- Reusable

STOCK NO.	UPC NO.	MAX WIRE DIAMETER	MOUNTING SCREW DIA.	WT. PER PKG.	STD. PKG.	SUGGESTED TRADE LIST PRICE PER
SPN316	51165	3/16	3/16	.19	25	29.35/ea. pkg.
SPN14	51170	1/4	3/16	.23	25	21.25/ea. pkg.
SPN38	51175	3/8	3/16	.21	20	23.50/ea. pkg.
SPN12	51180	1/2	3/16	.33	20	23.35/ea. pkg.
SPN58	51185	5/8	3/16	.32	20	23.50/ea. pkg.
SPN34	51190	3/4	1/4	.43	20	23.50/ea. pkg.
SPN78	51195	7/8	1/4	.24	10	29.33/ea. pkg.
SPN1	51200	1	1/4	.29	10	29.33/ea. pkg.

4-WAY CABLE TIE MOUNTING CLIP

NYLON MOUNT WITH ACRYLIC ADHESIVE



Clean or wipe surface before mounting.
See Page 208

STOCK NO.	UPC NO.	SIZE	MOUNTING SCREW DIA.	WT. PER PKG.	STD. PKG.	SUGGESTED TRADE LIST PRICE PER
WHITE						
MP25	23005	3/4 sq.	#6	.18	100	26.05/c
MP20	23000	1 sq.	#8	.30	100	31.40/c
BLACK UV						
MP25UV	23020	3/4 sq.	#6	.18	100	28.65/c
MP20UV	23015	1 sq.	#8	.33	100	34.53/c

Jar packaging available

SCREW MOUNT FLAT CABLE TIE HOLDER



Cable Tie Not Included

NYLON 6/6

- Mounts with #6 or #8 Pan or Flat Head screw
- Accepts cable ties up to 3/16" width in any length

STOCK NO.	UPC NO.	MAX. CABLE TIE WIDTH	MOUNTING SCREW	WT. PER PKG.	STD. PKG.	SUGGESTED TRADE LIST PRICE PER
FTHS01	51070	3/16	#6 or #8	.03	25	11.75/ea. pkg.



Metallics HOSE CLAMPS



*Another NEW
exciting solution
from Metallics!
Tired of searching
for the right
Hose Clamp
Here they are!*

Part Number	UPC#	Description	Quantity Per Pkg.	Suggested Trade List Per Pkg.
HMC6SS	23406	7/16"-7/8" ss hose clamp	10	\$28.73
HMC24SS	23424	1-1/16"-2" ss hose clamp	10	\$29.63
HMC32SS	23432	1-9/16"-2-1/2" ss hose clamp	10	\$30.15
HMC36SS	23436	1-13/16"-2-3/4" ss hose clamp	10	\$31.38
HMC40SS	23440	2-1/16"-3" ss hose clamp	10	\$35.93
HMC88SS	23488	5-1/16"-6" ss hose clamp	10	\$71.55
HMC104SS	23534	6-1/16"-7" ss hose clamp	10	\$74.60
Part Number	UPC#	Description	Quantity Per Pkg.	Suggested Trade List Per Pkg.
MHC6	22906	7/16"-7/8" hose clamp	10	\$23.20
MHC24	22924	1-1/16"-2" hose clamp	10	\$24.00
MHC28	22928	1-5/16"-2-1/2" hose clamp	10	\$24.45
MHC32	22932	1-9/16"-2-1/2" hose clamp	10	\$24.45
MHC36	22936	1-13/16"-2-3/4" hose clamp	10	\$25.25
MHC48	22948	2-9/16"-3-1/2" hose clamp	10	\$34.60
MHC52	22952	2-13/16"-3-3/4" hose clamp	10	\$36.75
MHC60	22960	3-5/16"-4-1/4" hose clamp	10	\$38.05
MHC64	22964	3-9/16"-4-1/2" hose clamp	10	\$38.40

Metallics

229 Cross Street,
Bristol, Ct. 06010
Tel: 800-243-8272
Fax: 800-831-9358
Email: sales@metallicsonline.com

"Growth Through Innovation"

Metallics West

651 North Main Street
Mancos, Co. 81328
Tel: 800-269-5183
Fax: 800-269-6278
Email: saleswest@metallicsonline.com

CABLE TIES AND ACCESSORIES

MASONRY MOUNT FLAT CABLE TIE HOLDER

BLACK UV STABILIZED NYLON 6/6



- Tap into 1/4" pre-drilled hole
- Affix wire and cable permanently
- Accepts cable ties up to 3/16" wide and any length

Cable Tie Not Included

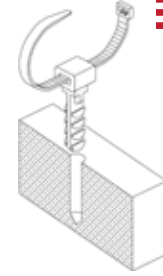

STOCK NO.	UPC NO.	PRE-DRILLED HOLE SIZE	MAX. CABLE TIE WIDTH	WT. PER PKG.	STD. PKG.	SUGGESTED TRADE LIST PRICE PER
FTHM14	51060	1/4	3/16	.07	25	8.35/ea. pkg.

RIVET MOUNT FLAT CABLE TIE HOLDER

YELLOW NYLON 6/6

Accepts a variety of cable tie lengths.

- Punch into pre-drilled hole (.196")
- Has built-in rivet
- One piece construction



Cable Tie Not Included

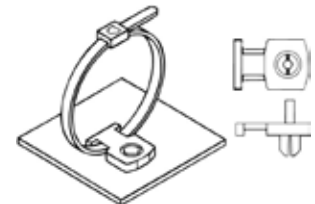

STOCK NO.	UPC NO.	RIVET HOLE DIAMETER	MAX. CABLE TIE WIDTH	WT. PER PKG.	STD. PKG.	SUGGESTED TRADE LIST PRICE PER
FTHR01	51065	.196	3/16	.07	50	7.70/ea. pkg.

C STYLE CABLE CLAMP

GRAY PVC

- Great for routing all types of wire
- Adhesive backing mounts quickly and easily
- Clean or wipe surface before mounting with a solvent cleaner/degreaser

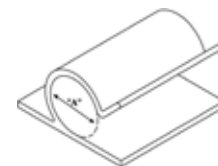

STOCK NO.	UPC NO.	MAX. CABLE CAPACITY "A"	WT. PER PKG.	STD. PKG.	SUGGESTED TRADE LIST PRICE PER
KKC14	51040	1/4	.06	20	17.78/ea. pkg.
KKC38	51045	3/8	.07	20	19.83/ea. pkg.
KKC12	51050	1/2	.13	10	11.03/ea. pkg.
KKC34	51055	3/4	.15	10	15.78/ea. pkg.

America's Source For Premier And Innovative Fasteners

CABLE TIES AND ACCESSORIES

U STYLE CABLE CLAMP

GRAY PVC



- Great for routing all types of wire
 - Adhesive backing mounts quickly and easily
 - Clean or wipe surface with a solvent cleaner/degreaser before mounting.
- See Page 208

STOCK NO.	UPC NO.	MAX. CABLE CAPACITY "A"	WT. PER PKG.	STD. PKG.	SUGGESTED TRADE LIST PRICE PER
KKU14	51020	1/4	.08	20	17.83/ea. pkg.
KKU38	51025	3/8	.07	20	19.88/ea. pkg.
KKU12	51030	1/2	.13	10	11.03/ea. pkg.
KKU34	51035	3/4	.08	10	15.63/ea. pkg.

ADJUSTABLE C STYLE CABLE CLAMP

NYLON 6/6

PACKAGED IN POLY BAGS

Holds cables from 5/16" to 1" in diameter

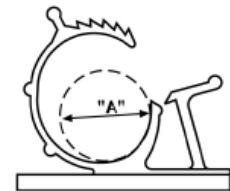

- Handles dozens of routing jobs
 - Locks securely and can be easily re-opened for routing changes
 - Adhesive backing for easy, quick installation
 - Clean or wipe surface with a solvent cleaner/degreaser before mounting
- See Page 208

STOCK NO.	UPC NO.	BUNDLE RANGE DIAMETER "A"	WT. PER PKG.	STD. PKG.	SUGGESTED TRADE LIST PRICE PER
AKK516	51000	5/16 - 13/32	.05	10	9.68/ea. pkg.
AKK1532	51005	15/32 - 9/16	.07	10	12.08/ea. pkg.
AKK3764	51010	37/64 - 3/4	.11	10	16.68/ea. pkg.
AKK78	51015	7/8 - 1	.24	10	18.85/ea. pkg.

TIE-ON-BASE WIRE ROUTING CLIP

NYLON 6/6



Cable Tie Not Included

- Cable tie and mounting clip all in one!
- Adhesive base has slot to guide strap under locking mechanism
 - Release tab allows for load to be removed, replaced or changed when necessary
 - Tensile strength 40 lbs.
 - One size fits a variety of applications
 - Clean or wipe surface with a solvent before mounting.
- See Page 208

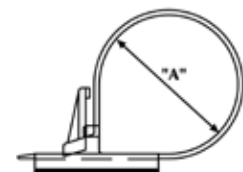

STOCK NO.	UPC NO.	MAX CABLE CAPACITY "A"	WT. PER PKG.	STD. PKG.	SUGGESTED TRADE LIST PRICE PER
TOB1	51125	1-1/8	.06	10	7.40/ea. pkg.

CABLE TIES AND ACCESSORIES



Cable Tie Not Included



KURLY STYLE CABLE WRAP WITH ADHESIVE BASE

NYLON 6/6

For easy cable routing in a variety of applications.

- Adhesive backing for quick and easy installation.
- Wires can be routed and re-routed after installation.
- Clean or wipe surface with a solvent cleaner/degreaser before mounting.

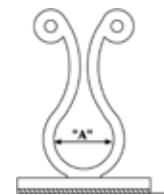

See Page 208

STOCK NO.	UPC NO.	MAX CABLE CAPACITY "A"	WT. PER PKG.	STD. PKG.	SUGGESTED TRADE LIST PRICE PER
KLB38	51075	3/8	.02	10	5.45/ea. pkg.
KLB12	51080	1/2	.03	10	6.05/ea. pkg.
KLB78	51085	7/8	.04	10	6.35/ea. pkg.



Cable Tie Not Included

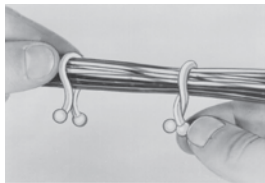

TWIST STYLE CABLE WRAP

NYLON 6/6

Simply twist to secure wire bundles. Reusable.



STOCK NO.	UPC NO.	MAX CABLE CAPACITY "A"	WT. PER PKG.	STD. PKG.	SUGGESTED TRADE LIST PRICE PER
TL516	51090	5/16	.01	25	2.70/ea. pkg.
TL38	51095	3/8	.02	25	2.93/ea. pkg.
TL12	51105	1/2	.02	25	3.18/ea. pkg.
TL78	51110	7/8	.03	25	3.83/ea. pkg.



VINYL HOLE GROMMET

BLACK FLEXIBLE VINYL

Installs instantly. Simply snap into hole in panel box, etc., to protect cable.



STOCK NO.	UPC NO.	INSIDE DIA./ OUTSIDE DIA.	HOLE SIZE	PANEL THICKNESS	WT. PER PKG.	STD. PKG.	SUGGESTED TRADE LIST PRICE PER
HG14	51130	1/4 x 9/16	.37	3/32	.02	10	2.60/ea. pkg.
HG38	51135	3/8 x 43/64	.49	1/16	.02	10	4.30/ea. pkg.
HG12	51140	1/2 x 55/64	.69	1/16	.04	10	5.18/ea. pkg.
HG58	51145	5/8 x 55/64	.75	1/16	.02	10	5.73/ea. pkg.
HG4764	51150	47/64 x 1 15/64	.99	1/16	.09	10	10.30/ea. pkg.
HG5564	51155	55/64 x 1 3/16	1.00	1/16	.06	10	13.05/ea. pkg.
HG3132	51160	3 1/32 x 1 1/2	1.25	1/16	.13	10	15.80/ea. pkg.

CABLE TIES AND ACCESSORIES

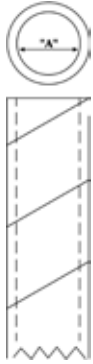

WIRE HARNESS WRAP

BLACK POLYETHYLENE/U.V. STABILIZED



- Wraps around cables to bundle and provide protection.
- Flexible enough to bend around corners, retains elasticity.
- Free assembly tool included with every 100' roll.

STOCK NO.	UPC NO.	DIAMETER "A"	CABLE BUNDLE RANGE	WT. PER ROLL	STD. PKG.	SUGGESTED TRADE LIST PRICE PER
HW14	51115	1/4	3/16-1"	1.25	100 ft. roll	80.30/ea
HW12	51120	1/2	3/4-4"	3.38	100 ft. roll	168.05/ea

WHITE WIRE HARNESS WRAP AVAILABLE BY SPECIAL ORDER

MANUFACTURING CAPABILITIES

Diameter range #2 thru 5/16" / 1.5mm thru 8mm • Length range 1/8" thru 3" / 3.5mm thru 75mm
Materials: Steel, Brass, Stainless, Aluminum, Bronze.

NEED SCREWS...
Let Us Make Them For You!



A METALLICS AFFILIATE

P.O. Box 1600 • 231 Cross Street
Bristol, CT 06011-1600
Tel: 800-984-8945 • Fax: 800-984-8946

CAPABILITIES LIST

PLANT SIZE: 100,000 SQUARE FEET

LOCATION: Bristol, Connecticut

EQUIPMENT: 27 Hi-Speed Cold Headers
8 Burr-Free Screw Slotters
3 Shank Slotters
2 Pointers
14 High Speed Thread Rollers



ADDITIONAL PLANT INFO: Modern shipping facility utilizing digital scale count ing machines. In-house packaging facilities - boxing, sorting, baggings. All material boxed, palletized & labeled with your needs in mind for domestic or export shipping.

SECONDARY WORK: All plating & heat treating is done on the outside and certified for your guarantee.

INFORMATION SYSTEMS: Our facility has new and upgraded Technology to meet your customers specific requirements.

FIXTURE HANGING ACCESSORIES



HEX ROD COUPLINGS

STEEL ZINC CHROMATE AND STAINLESS STEEL

STOCK NO.	UPC NO.	HEX SIZE	SIZE	LENGTH	WT. PER PKG.	STD. PKG.	SUGGESTED TRADE LIST PRICE PER
STEEL							
RCT26	21705	1/4-20	3/8	7/8	1.02	50	33.06/c
RCT27	21710	5/16-18	3/8	7/8	1.21	50	40.36/c
RCT28	21715	3/8-16	1/2	1	1.87	50	45.16/c
RCTL28(1-3/4 LONG)	23328	3/8-16	1/2	1 3/4	5.71	50	77.26/c NEW
RCT29	21720	1/2-13	5/8	1 1/4	1.46	25	56.20/c
RCTL29(1-3/4 LONG)	23329	1/2-13	5/8	1 3/4	2.95	25	246.20/c NEW
RCT30	21725	5/8-11	3/4	1 1/2	2.24	25	172.80/c NEW
RCT31	21728	3/4-10	7/8	1 1/4	7.19	25	471.30/c NEW
18-8 TYPE STAINLESS STEEL							
RCT26SS	10644	1/4-20	3/8	7/8	1.02	50	461.66/c
RCT27SS	10645	5/16-18	3/8	7/8	1.40	50	566.40/c
RCT28SS	21726	3/8-16	1/2	1	1.87	50	741.36/c
RCT29SS	21727	1/2-13	5/8	1 1/4	1.52	25	915.52/c
RCT30SS	22830	5/8-11	3/4	1 1/2	9.68	50	1840.46/c NEW
NEW STAINLESS STEEL 316							
RCT28SS316	94828	3/8-16	1/2	1	1.89	50	1046.50/c NEW
RCT29SS316	94829	1/2-13	5/8	1 1/4	2.85	50	1443.46/c NEW



REDUCING ROD COUPLING

STEEL ZINC CHROMATE

STOCK NO.	UPC NO.	SIZE	WT. PER PKG.	STD. PKG.	SUGGESTED TRADE LIST PRICE PER
RCTR28	21706	3/8-16 x 1/4-20	2.02	50	72.50/c
RCTR27	21704	3/8-16 x 5/16-18	2.35	50	81.86/c NEW

THREADED ROD

STEEL ZINC CHROMATE AND STAINLESS STEEL

THREADED ROD SOLD ONLY IN FULL BUNDLE QUANTITIES



STOCK NO.	UPC NO.	SIZE
18-8 TYPE STAINLESS STEEL		
TRS6/6SS	10619	1/4-20 x 6'
TRS7/6SS	10618	5/16-18 x 6'
TRS8/6SS	10616	3/8-16 x 6'
TRS9/6SS	10617	1/2-13 x 6'
TRS106SS	21677	5/8-11 x 6' NEW

PLEASE CALL FOR BUNDLE QUANTITIES AND PRICING
1-800-243-8272 EAST
1-800-269-5183 WEST

STOCK NO.	UPC NO.	SIZE
STEEL ZINC CHROMATE		
TRS6/3	21613	1/4-20 x 3'
TRS7/3	21614	5/16-18 x 3'
TRS8/3	21617	3/8-16 x 3'
TRS9/3	21618	1/2-13 x 3'
TRS6/6B	21640	1/4-20 x 6'
TRS7/6	21610	5/16-18 x 6'
TRS8/6B	21645	3/8-16 x 6'
TRS9/6B	21650	1/2-13 x 6'
TRS106	21607	5/8-11 x 6' NEW
TRS11/6	21580	3/4-10 x 6' NEW
TRS610	21606	1/4-20 x 10'
TRS710	21604	5/16-18 x 10'
TRS810	21616	3/8-16 x 10'
TRS910	21621	1/2-13 x 10'
TRS1010	21685	5/8-11 x 10' NEW
TRS1110	21690	3/4-10 x 10' NEW

DOMESTIC ROD AVAILABLE

GALVANIZED, 316 STAINLESS STEEL, PLAIN, PLEASE CALL FOR PRICING

OTHER SIZES AVAILABLE BY REQUEST

FIXTURE HANGING ACCESSORIES



SLIP-ON LOCK NUTS

FOR THREADED ROD
STEEL ZINC PLATED
PACKAGED IN POLY BAGS

STOCK NO.	UPC NO.	SIZE	HEX SIZE	ACROSS CORNERS	HEIGHT	WT. PER PKG.	STD. PKG.	SUGGESTED TRADE LIST PRICE PER
SLN14	22030	1/4-20	.625	.715	.375	.11	5	18.63/ea pkg
SLN516	22032	5/16-18	.750	.865	.375	.17	5	21.15/ea pkg
SLN38	22034	3/8-16	.875	1.01	.490	.38	5	24.18/ea pkg
SLN12	22036	1/2-13	1.068	1.23	.625	.48	5	28.53/ea pkg



ZINC PLATED STEEL

MALLEABLE IRON

BEAM CLAMPS

ZINC PLATED STEEL AND MALLEABLE IRON

PACKAGED IN POLY BAGS

STOCK NO.	UPC NO.	DESCRIPTION	WT. PER PKG.	STD. PKG.	SUGGESTED TRADE LIST PRICE PER
BC14	81525	1/4-20 Zinc Plated	1.16	10	12.08/ea pkg
BC38	81530	3/8-16 Zinc Plated	2.86	10	23.53/ea pkg
MBC14	81535	1/4-20 Malleable Iron	2.00	10	11.43/ea pkg
MBC38	81537	3/8-16 Malleable Iron	6.81	10	50.38/ea pkg
MBC12	81539	1/2-13 Malleable Iron	13.20	10	63.78/ea pkg



SQUARE

OCTAGONAL

SWIVEL FIXTURE HANGERS

FOR 4" SQUARE AND OCTAGONAL BOXES
STEEL ZINC CHROMATE
PACKAGED 1 PER POLY BAG



STOCK NO.	UPC NO.	SIZE	WT. PER EACH	STD. PKG.	SUGGESTED TRADE LIST PRICE PER
MSC50	81541	Sq. box/pivot threaded for 1/2" npt pipe	.71	1	27.70/ea
MSC75	81543	Sq. box/pivot threaded for 3/4" npt pipe	.68	1	27.70/ea
MSC50R	81545	Oct. box/pivot threaded for 1/2" npt pipe	.63	1	27.70/ea
MSC75R	81547	Oct. box/pivot threaded for 3/4" npt pipe	.59	1	27.70/ea

PAINTED WHITE AVAILABLE BY SPECIAL QUOTE



SLIP-ON LOCK NUT KIT

NEW

STOCK NO.	UPC NO.	DESCRIPTION OF CONTENTS	WT. EACH	SUGGESTED TRADE LIST PRICE PER
SLNK1	22040	1/4 & 3/8 Slip-On Lock Nut Kit (25 pcs. each size)	1.98	205.33/ea kit NEW
SLNK2	22041	3/8 Slip-On Lock Nut Kit (50 pcs.)	2.00	205.33/ea kit NEW

FIXTURE HANGING ACCESSORIES



J-BOLTS

STEEL ZINC CHROMATE & GALVANIZED

PACKAGED 10 PER POLY BAG



STOCK NO.	UPC NO.	THREAD LENGTH	THREAD SIZE/ OVERALL LENGTH	INSIDE HOOK DIA.	WT. PER PKG.	STD. PKG.	SUGGESTED TRADE LIST PRICE PER
BTJ1	81055	1 1/2	1/4-20 x 2 5/16	7/16	.31	10	2.80/ea pkg
BTJ4	81061	1 1/2	1/4-20 x 4	7/16	.52	10	6.85/ea pkg NEW
BTJ2	81057	2	5/16-18 x 3	1/2	.66	10	5.23/ea pkg
BTJ3	81059	2 1/4	3/8-16 x 3 3/4	5/8	1.18	10	9.28/ea pkg
NEW GALVANIZED							
BTJ6G	81656	2	1/2-13 x 3 1/2	1/2	4.95	10	222.50/ea pkg NEW

HEXAGON NUTS AND WASHERS ORDERED SEPARATELY

OTHER SIZES AND QUANTITIES AVAILABLE BY REQUEST

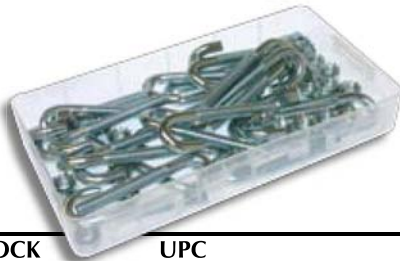

COMMUNICATION RACK J-HOOK KIT **NEW**

STOCK NO.	UPC NO.	DESCRIPTION	WT. EACH	SUGGESTED TRADE LIST PRICE PER
BTJK516	20325	5/16 J-Hook Kit 25 5/16 x 3 J-Bolts 25 5/16 x 3 Hex Lock Nuts Steel Zinc	2.13	29.88/ea kit NEW

OTHER SIZES AND QUANTITIES AVAILABLE BY REQUEST



HOOK AND HOOK TURNBUCKLES

MALLEABLE IRON AND
STEEL ZINC CHROMATE

PACKAGED 1 EACH PER POLY BAG



STOCK NO.	UPC NO.	THREAD DIAMETER	OVERALL LENGTH CLOSED	OVERALL LENGTH OPEN	WT. PER PKG.	STD. PKG.	SUGGESTED TRADE LIST PRICE PER
TBH14	81577	1/4 - 20	5 1/2	7 5/8	0.18	1	6.38/ea
TBH516	81579	5/16 - 18	6 3/4	9 1/4	0.33	1	10.03/ea
TBH38	81581	3/8 - 16	7 1/2	10 1/2	0.52	1	14.45/ea

OTHER SIZES AND QUANTITIES AVAILABLE BY REQUEST



EYE BOLTS WITH HEX NUTS

STEEL ZINC CHROMATE & STAINLESS STEEL

STOCK NO.	UPC NO.	THREAD LENGTH	THREAD SIZE/ OVERALL LENGTH	INSIDE EYE SIZE	WT. PER PKG.	STD. PKG.	SUGGESTED TRADE LIST PRICE PER
JEB6	80992	1 1/4	10-24 x 2	3/8	2.17	100	26.58/c
JEB1	80993	3/4	1/4-20 x 2	1/2	4.34	100	28.15/c
JEB2	80994	1 1/4	1/4-20 x 2 1/2	1/2	4.90	100	30.63/c
JEB3	80995	1 3/4	1/4-20 x 3	1/2	5.36	100	34.80/c
JEB4	82220	2	1/4-20 x 3 1/2	1/2	5.86	100	38.88/c
JEB9	82229	3	1/4-20 x 5	1/2	7.45	100	78.33/c NEW

OTHER SIZES AND QUANTITIES AVAILABLE BY REQUEST

CONTINUED ON NEXT PAGE

FIXTURE HANGING ACCESSORIES



CONTINUED

EYE BOLTS WITH HEX NUTS

STEEL ZINC CHROMATE & STAINLESS STEEL

STOCK NO.	UPC NO.	THREAD LENGTH	THREAD SIZE/ OVERALL LENGTH	INSIDE EYE SIZE	WT. PER PKG.	STD. PKG.	SUGGESTED TRADE LIST PRICE PER
JEB5	82225	2 ³ / ₄	1/4-20 x 4	1/2	6.22	100	39.73/c
JEB15	82236	3	1/4-20 x 6	1/2	8.23	100	144.35/c NEW
JEB32	82253	2 ³ / ₄	5/16-18 x 2 ³ / ₈	1/2	8.03	100	100.73/c NEW
JEB33	82254	1/4	5/16-18 x 3	1/2	2.43	25	243.12/c NEW
JEB13	82233	1	3/8-16 x 3	1	14.80	100	213.23/c NEW
JEB12	82232	1 ¹ / ₄	3/8-16 x 3 ¹ / ₂	1	13.72	100	184.78/c NEW
JEB14	82235	2	3/8-16 x 4	1	8.84	50	231.88/c NEW
JEB8	81190	3	3/8-16 x 5	1	5.13	25	122.90/ea. pkg.
JEB11	82231	3	3/8-16 x 6	1	5.85	25	157.08/ea. pkg. NEW
JEB17	82238	3 ⁷ / ₈	3/8-16 x 8	1	7.50	25	293.95/c NEW
JEB16	82237	3	7/16-14 x 8	1	3.98	20	680.75/c NEW
JEB10	82230	3 ¹ / ₄	7/16-14 x 10	1 ¹ / ₈	4.70	10	694.80/ea. pkg.
JEB124	77824	1 ¹ / ₄	1/2-13 x 4	1 ¹ / ₈	7.00	100	495.18/c NEW

NEW STAINLESS STEEL

JEB1SS	94451	3/4	1/4-20 x 2	1/2	4.25	100	PLEASE CALL FOR TRADE LIST PRICING	NEW
JEB3SS	94453	1 ³ / ₄	1/4-20 x 3	1/2	5.48	100		NEW
JEB13SS	94463	2 ³ / ₈	3/8-16 x 3 ⁷ / ₈	1	3.72	25		NEW
JEB14SS	22228	2	3/8-16 x 4	1	17.52	100		NEW
JEB124SS	98187	1 ¹ / ₄	1/2-13 x 4	1 ¹ / ₈	7.00	25		NEW

OTHER SIZES AND QUANTITIES AVAILABLE BY REQUEST



SCREW EYES

STEEL ZINC CHROMATE
With Lag Screw Thread



STOCK NO.	UPC NO.	OVERALL LENGTH/ HOLE DIAMETER	THREAD DIAMETER	THREAD LENGTH	WT. PER PKG.	STD. PKG.	SUGGESTED TRADE LIST PRICE PER
JSE1	80996	1 ⁵ / ₁₆ x 1/2"	#8	1/2	.83	100	10.00/c
JSE2	80997	1 ⁵ / ₁₆ x 5/8"	1/4	3/4	1.58	100	22.50/c
JSE5*	81416	3 ³ / ₄ x 1/2"	1/4	3/4	5.32	100	140.80/c NEW
JSE3	80998	2 ³ / ₁₆ x 1 ¹ / ₁₆ "	9/32	7/8	4.06	100	30.28/c
JSE4	81415	2 ⁵ / ₈ x 3/4"	5/16	1	6.82	100	59.05/c
JSE7*	81414	5 ¹ / ₂ x 3/4"	7/16	2 ¹ / ₈	8.27	25	75.00/ea. pkg. NEW
JSE8*	81418	5 ¹ / ₄ x 1"	1/2	2 ¹ / ₂	6.50	25	68.34/ea. pkg.
JSE10*	81420	8 x 1 ¹ / ₈ "	9/16	2 ⁵ / ₈	11.65	25	120.80/ea. pkg.
JSE6	81417	8 x 7/16"	7/16	2 ⁷ / ₈	11.50	25	162.50/ea. pkg. NEW

OTHER SIZES AND QUANTITIES AVAILABLE BY REQUEST

* DENOTES A PRODUCT NOT MANUFACTURED IN USA



Metallics has been a proud and loyal member of the National Electrical Manufacturers Representatives Association since January 31, 1991.

FIXTURE HANGING ACCESSORIES

SWIVEL FIXTURE HANGERS



SQUARE



OCTAGONAL

- 20° swing from vertical
- Both load rated at 50 lbs.
- Rugged hinge construction
- **Hands-free fixture hanger**
- Single Electrician Installation
- Fits 4" square and round electrical boxes
- Fits 3/4" pipe and includes a reducing bushing for 1/2" pipe

STOCK NO.	UPC NO.	SHAPE	DESCRIPTION	PKG. QTY	WT. PER PKG.	SUGGESTED TRADE LIST PRICE PER
MSCU	81607	Square	Fixture Hanger	1	.78	41.73/ea
MSCUR	81609	Round	Fixture Hanger	1	.72	41.73/ea



SCREW HOOKS

STEEL ZINC CHROMATE
With Lag Screw Thread

STOCK NO.	UPC NO.	LENGTH/ WIRE DIAMETER	WT. PER PKG.	STD. PKG.	SUGGESTED TRADE LIST PRICE PER
JSH1	83500	2" x .135"	1.20	100	21.93/c
JSH2	83505	3 ³ / ₈ " x .192"	3.92	100	42.38/c
JSH3	83510	4 ¹ / ₈ " x .244"	7.88	100	53.80/c

OTHER SIZES AND QUANTITIES AVAILABLE BY REQUEST



ZINC CHROMATE

STAINLESS STEEL

S-HOOKS

STEEL ZINC CHROMATE
AND STAINLESS STEEL

For Hanging Industrial
Fluorescent Fixtures

**NOW IN
LARGER
SIZES!**



STOCK NO.	UPC NO.	LENGTH/ WIRE DIAMETER	WT. PER PKG.	USE WITH	STD. PKG.	SUGGESTED TRADE LIST PRICE PER
STEEL ZINC CHROMATE						
JSHK1A	81006	3/4" x .071"	.35	JC14	100	8.35/c
JSHK1	81005	1 1/4" x .105"	.76	JC12/JC14	100	8.65/c
JSHK2	81007	1 1/2" x .141"	1.39	JC10/JC12	100	21.00/c
JSHK2A	81008	1 3/4" x .186"	3.12	JC10/JC12	100	31.43/c
JSHK3	81009	2" x .243"	5.63	JC10	100	94.88/c
JSHK4	82256	3" x .312"	6.16	JC10	50	117.20/c
JSHK5	82260	3 1/2" x .375"	10.61	JC10	50	225.56/c
STAINLESS STEEL						
JSHK0ASS	82301	3/4" x .092"	.38	JC14	100	89.25/c NEW
JSHK1SS	82401	1 1/4" x .148"	1.35	JC12/JC14	100	112.82/c NEW
JSHK2SS	82306	1 1/2" x .184"	2.30	JC12/JC14	100	127.30/c
JSHK2ASS	82265	1 3/4" x .192"	3.21	JC10/JC12	100	245.55/c
JSHK3SS	82270	2" x .250"	6.20	JC10	100	447.50/c

OTHER SIZES AND QUANTITIES AVAILABLE BY REQUEST

FIXTURE HANGING ACCESSORIES



TIE WIRE

LOW TENSILE STEEL & STAINLESS STEEL



STOCK NO.	UPC NO.	DESCRIPTION	WT. PER PKG.	STD. CARTON	SUGGESTED TRADE LIST PRICE PER
MTW12	16120	12 Gauge 5Lb/165'	6.00	1	25.18/ea coil NEW
MTW12-3M	16123	12 Gauge 89Lb/3000'	89.00	1	516.23/ea coil NEW
MTW12-4M	16124	12 Gauge 118Lb/4000'	118.00	1	688.33/ea coil NEW
MTW14M	16140	14 Gauge 17Lb/1000'	17.00	1	174.75/ea coil NEW
MTW16	16125	350' 16 Gauge	70.60	20 Coils (min. purchase)	10.73/ea coil
MTW17	22307	500' 16 Gauge/Galvanized	66.00	12 Spools (min. purchase)	20.65/ea coil
MTW1725	22308	250' 16 Gauge/Galvanized	71.60	20 Coils (min. purchase)	15.48/ea coil
MTW18	22313	350' 18 Gauge	13.00	1	10.73/ea coil NEW
NEW STAINLESS STEEL					
MTW16SS1LB	22293	.032 Gauge 1Lb Coil	1.00	1	58.75/ea coil NEW
MTW16SSP	22292	1152' 16 Gauge	2.40	1	220.00/ea coil NEW



TIE WIRE DISPENSER **NEW**

Mounts On Toolbelt • Metal
A Very Handy Way To Store & Dispense Tie Wire

STOCK NO.	UPC NO.	WT. PER PKG.	STD. PKG.	SUGGESTED TRADE LIST PRICE PER
MWDM1	16102	1.0	1	59.80/ea NEW



PRE-TIED CEILING WIRE **NEW**

STOCK NO.	UPC NO.	DESCRIPTION	WT. PER PKG.	STD. BUNDLE	SUGGESTED TRADE LIST PRICE PER
SWL1212	16177	12' Pretied Ceiling Wire w/ single loop	39.00	100 pcs	187.50/c NEW
SWL612	16174	6' Pretied Ceiling Wire w/ single loop	20.00	100 pcs	110.00/c NEW
SWP1212	26717	12' Pretied Ceiling Wire w/ pin & clip	39.00	100 pcs	189.65/c NEW
SWP612	26612	6' Pretied Ceiling Wire w/ pin clip	20.00	100 pcs	117.68/c NEW

FIXTURE HANGING ACCESSORIES

See Page 32 Fasteners to attach jack chain to structural steel or bar joists.

JACK CHAIN

STEEL ZINC PLATED AND STAINLESS STEEL



STOCK NO.	UPC NO.	TRADE SIZE	SIZE ACROSS LINK	WORK LOAD LIMIT/LBS	WT. PER PKG.	STD. PKG.	SUGGESTED TRADE LIST PRICE PER
STEEL ZINC PLATED							
JC10	21515	#10	1/2	43	7.26	50' BOX	26.85/ea pkg
JC10T	21513	#10	1/2	43	37.01	250' BOX	134.28/ea pkg NEW
JC12	21500	#12	3/8	29	4.46	50' BOX	18.28/ea pkg
JC12C	21505	#12	3/8	29	9.13	100' REEL	39.45/ea pkg
JC12CB	21507	#12	3/8	29	6.83	100' BOX	36.58/ea pkg
JC12M	21510	#12	3/8	29	90.00	1000' BUCKET	359.20/ea pkg
JC14	21518	#14	1/4	16	5.35	100' BOX	35.23/ea pkg
JC16	21508	#16	5/64	11	3.12	100' BOX	73.03/ea pkg NEW
JC18CB	21535	#18	3/16	5	1.84	100' BOX	106.08/ea pkg NEW
STAINLESS STEEL 18-8 TYPE							
JC10SS	21516	#10	1/2	43	7.53	50' BOX	189.98/ea pkg
JC10CBSS	21517	#10	1/2	43	15.00	100' BOX	540.60/ea pkg NEW
JC12SS	21501	#12	3/8	29	4.46	50' BOX	230.98/ea pkg
JC12CSS	21506	#12	3/8	29	8.92	100' BOX	469.10/ea pkg NEW
JC16SS	21523	#16	5/64	11	3.14	100' BOX	243.03/ea pkg NEW
JC18SS	21534	#18	3/16	5	2.54	100' BOX	197.75/ea pkg NEW

FIXTURE HANGING CHAIN

PLAIN STEEL FINISH WITH LACQUER



STOCK NO.	UPC NO.	DESCRIPTION	WT. PER PKG.	STD. PKG.	SUGGESTED TRADE LIST PRICE PER
FHC1	21410	2-1/4 x 3/4 W, .148 Thick	44.15	(100) 3' Pieces	312.20/ea pkg

DOUBLE LOOP CHAIN

STEEL ZINC PLATED AND 18-8 SERIES STAINLESS STEEL



STOCK NO.	UPC NO.	TRADE SIZE	WIRE DIA.	WORK LOAD LIMIT/LBS	WT. PER PKG.	STD. PKG.	SUGGESTED TRADE LIST PRICE PER
STEEL ZINC PLATED							
DLC1	21550	#1	.105	155	10.18	100' Box	54.73/ea pkg
DLC1S	21555	#1	.105	155	26.00	250' Spool	135.13/ea pkg
DLC2	21556	#2	.0915	115	7.50	100' Spool	39.10/ea pkg NEW
DLC3	21560	#3	.080	90	6.14	100' Box	42.98/ea pkg
DLC3S	21565	#3	.080	90	16.25	250' Spool	107.43/ea pkg
DLC4	21586	#4	.072	70	5.23	100' Spool	39.65/ea pkg NEW
DLC2/0	21557	#2/0	.135	255	42.50	250' Spool	161.98/ea pkg NEW
STAINLESS STEEL							
SDLC3	21570	#3	.080	90	6.34	100' Box	320.48/ea pkg

FIXTURE HANGING ACCESSORIES



TOP/END

FIXTURE HOOKS

STEEL ZINC CHROMATE
For Hanging Industrial Light Fixtures
PACKAGED IN 1/4 KEG CARTONS



SIDE



STOCK NO.	UPC NO.	DESCRIPTION	WT. PER PKG.	STD. PKG.	SUGGESTED TRADE LIST PRICE PER
FHK1	21400	Top/End Mount	4.50	100	45.13/c
FHK2	21405	Side Mount	4.80	100	45.13/c

TIE WIRE ACOUSTICAL TOGGLE BOLTS

TIE WIRE ACOUSTICAL TOGGLE BOLTS ARE PRIMARILY FOR OVERHEAD APPLICATIONS. THE WINGED END IS INSERTED THROUGH THE DRYWALL, CEILING, TILE, ETC., AND EXPANDS BEHIND THAT MEDIUM WHILE THE 1/4" X 1-1/4" FENDER WASHER AND HEX NUT ACT TO SECURE THE ANCHOR TO THE EXTERIOR OF THE HOLE.



INCLUDES:
(1) TIE WIRE 1/4-20
TOGGLE BOLT
(1) 1/4-20 NUT
(1) 1/4 WASHER
(1) 1/4 TOGGLE WING

STOCK NO.	UPC NO.	DESCRIPTION	WT. PER PKG.	STD. PKG.	SUGGESTED TRADE LIST PRICE PER
JTWA144	81402	1/4" x 4" Toggle Bolt	2.47	25	38.00/ea pkg
JTWA145	81404	1/4" x 5" Toggle Bolt	2.33	25	40.93/ea pkg



HANGER BOLTS

STEEL ZINC CHROMATE



STOCK NO.	UPC NO.	DESCRIPTION	WT. PER PKG.	STD. PKG.	SUGGESTED TRADE LIST PRICE PER
JHAB9	81000	10-24 x 2	1.12	100	11.75/c
JHAB10	81001	1/4-20 x 3	3.10	100	23.13/c
JHAB11	81002	3/8-16 x 3	7.65	100	50.50/c
JHAB13	84111	3/8-16 x 4	9.42	100	53.50/c NEW
JHAB12	84110	3/8-16 x 6	7.31	50	50.03/ea. pkg.



HANGER BOLT DRIVERS

WITH 1/4" POWER HEX SHANKS
INTERNAL THREADS FOR DRIVING
HANGER BOLTS AND THREADED ROD

STOCK NO.	UPC NO.	DESCRIPTION	WT. PER PKG.	STD. PKG.	SUGGESTED TRADE LIST PRICE PER
HABD10	23275	1/4-20 x 2 9/16 BOLT DRIVER	.06	1	11.23/ea
HABD12	23280	3/8-16 x 2 9/16 BOLT DRIVER	.08	1	14.28/ea

FIXTURE HANGING ACCESSORIES



ACOUSTICAL DRILL SCREW

STEEL ZINC CHROMATE

Designed to penetrate 16-18 gauge steel stud for hanging acoustical ceilings

STOCK NO.	UPC NO.	THREAD SIZE/ OVERALL LENGTH	WT. PER PKG.	STD. PKG.	SUGGESTED TRADE LIST PRICE PER
JATEK1	82020	1/4 x 2	1.05	50	21.63/ea. pkg.



ACOUSTICAL LAG SCREW

STEEL ZINC CHROMATE

For use in tie wire and jack chain applications
For Wood Application

STOCK NO.	UPC NO.	THREAD SIZE/ OVERALL LENGTH	WT. PER PKG.	STD. PKG.	SUGGESTED TRADE LIST PRICE PER
JALS14	81003	1/4 x 3	1.19	50	9.03/ea. pkg.
JALS15	77915	1/4 x 4	2.32	100	47.53/c NEW



ACOUSTICAL LAG & ACOUSTICAL DRILL SCREW DRIVER

STOCK NO.	UPC NO.	DESCRIPTION	WT. PER PKG.	STD. PKG.	SUGGESTED TRADE LIST PRICE PER
ALSD	22050	Driver 3 1/4	.13	1	8.93/ea



TIE WIRE WEDGE ANCHOR

ZINC WITH STAINLESS STEEL CLIP

For various overhead suspension applications

STOCK NO.	UPC NO.	DIAMETER/ LENGTH	MIN. DEPTH IN LENGTH	WT.	STD. PKG.	SUGGESTED TRADE LIST PRICE PER
JTWA214	80906	1/4 X 2 1/4	1 3/8	3.41	100	108.60/c



EYE COUPLING

STEEL ZINC CHROMATE

For use in tie wire and jack chain applications

STOCK NO.	JAR UPC NO.	DESCRIPTION	WT. PER PKG.	STD. PKG.	SUGGESTED TRADE LIST PRICE PER
JEC44	81004	1/4-20 x 1 1/2	2.29	100	77.05/c

FIXTURE HANGING ACCESSORIES



SHEETROCK - TOGGLES

VERTICAL MOUNT USED FOR HANGING THREADED ROD 1/4" OR 3/8"
FOR USE IN SHEETROCK CEILINGS, METAL LATH & PLASTER, METAL LINERS,
THIN WOOD, CEILING PANELS

SheetRock Toggle for 1/4 Rod (Vertical Mount)

Use Nut Driver SMDB2 on Page 148

STOCK NO.	UPC NO.	SIZE	DESCRIPTION	WT. PER PKG.	PKG. QTY	SUGGESTED TRADE LIST
JSRT14	81388	1/4	SheetRock Toggle	3.08	25	76.78/ea. pkg.

SheetRock Toggle for 3/8 Rod (Vertical Mount)

Use Nut Driver SMDB2 on Page 148

STOCK NO.	UPC NO.	SIZE	DESCRIPTION	WT. PER PKG.	PKG. QTY	SUGGESTED TRADE LIST
JSRT38	81390	3/8	SheetRock Toggle	3.02	25	76.78/ea. pkg.



2 Large Warehouses strategically positioned in the United States means the highest fill rate, quick shipping, less worry and happy distributors.

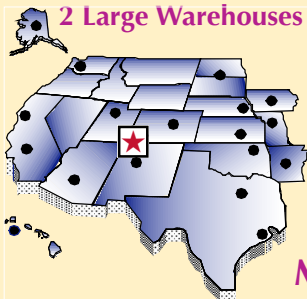

Happy Distributors + Happy Customers = Profit \$\$

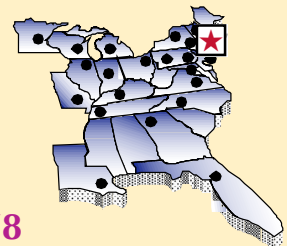

Metallics East, Bristol, CT 1-800-243-8272
Metallics West, Mancos, CO 1-800-269-6278

America's Source For Premier & Innovative Fasteners

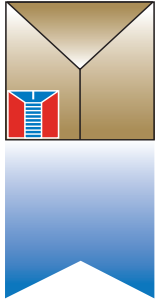

Metallics

Requested by distributors in Hurricane & Flood Prone areas



(ANCHORS ONLY)

HURRICANE / WINDOW / DOOR SHUTTER SCREW KIT

(STAINLESS STEEL CAP)

Don't get caught off guard. Be prepared!!



Installation Instructions Included

This Kit Contains The Following:

STOCK NO.	UPC NO.	DESCRIPTION	WT. PER PKG.	SUGGESTED TRADE LIST PRICE PER
SHSK1	41500	(1) 8" x 4" Plastic 6 Compartment Case (1) 3/16" Carbide Tipped Drill Bit (1) Concrete Driver (1) Wood Driver (20) 1/4" Flat Washers (20) 1/4-20 x 1" Machine Screws (20) 1/4-20 x 1-1/2" Machine Screws (10) 1-1/4" Hurricane Concrete Anchors (SS Cap) (10) 2" Hurricane Wood Anchors (SS Cap)	1.85	115.00/ea

FOR INFORMATION CALL

**METALLICS EAST AT (800) 243-8272
229 CROSS ST, BRISTOL, CT**

**METALLICS WEST AT (800) 269-5183
651 NORTH MAIN ST, MANCOS, CO**

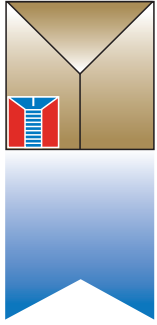

Metallics



HIGH PERFORMANCE PLASTIC SADDLE

(CABLE TRAY APPLICATION)

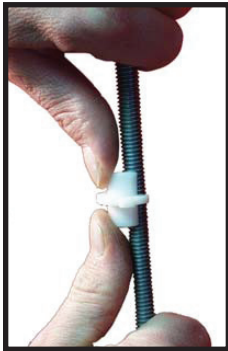

- PLENUM RATED
- MULTIPLE HANGERS PER ROD
- NON-CORROSIVE / NON-CONDUCTIVE
- SNAP NUT ANYWHERE ONTO THREADED ROD
- HOLDS UP TO 35 PICES CAT 5E CABLE
- AN INEXPENSIVE ALTERNATIVE OR ENCHANCEMENT TO A CABLE TRAY

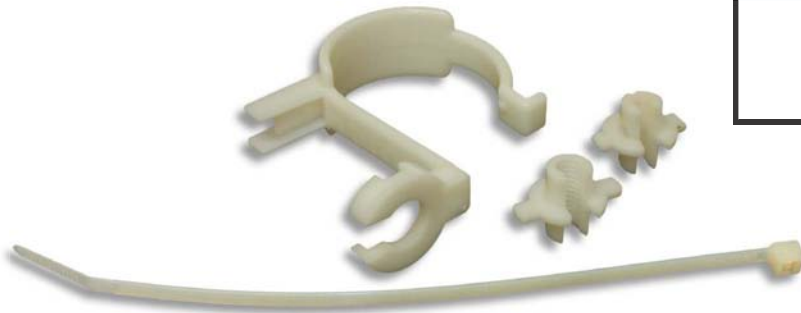
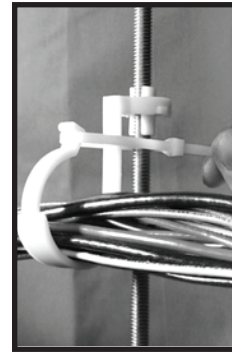

STOCK NO.	JAR UPC NO.	DESCRIPTION	WT. PER PKG.	STD. PKG.	SUGGESTED TRADE LIST PRICE PER
SMS1	41995	1/4" & 3/8" Saddle	.06	1	5.83/ea
SMS5	41996	1/4" & 3/8" Saddle	.29	5	27.13/ea

FOR INFORMATION CALL
 METALLICS EAST AT (800) 243-8272 OR METALLICS WEST AT (800) 269-5183
 229 CROSS ST, BRISTOL, CT 651 NORTH MAIN ST, MANCOS, CO

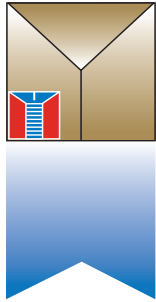

Metallics



VERTICAL MOUNT THREADED ROD ANCHOR SYSTEM

SAVES TIME AND COST FROM TRADITIONAL HANGING METHODS

Drill, Drive, Done!



STOCK NO.	UPC NO.	ROD SIZE	SCREW DESCRIPTION	WT. PER PKG.	STD. PKG.	SUGGESTED TRADE LIST PRICE PER
WOOD						
JSMW14201	78360	1/4-20	5/16 x 2 1/4	1.69	25	52.45/ea pkg
JSMW38161	78365	3/8-16	5/16 x 2 1/4	1.55	25	62.98/ea pkg

FOR 1/2-13 THREADED ROD SEE THE ADAPTER BELOW.



METAL						
JSMW14201	78400	1/4-20	1/4-20 x 1 #3 DRILL POINT	1.43	25	68.25/ea pkg
JSMW38161	78405	3/8-16	1/4-20 x 1 1/2 #3 DRILL POINT	1.77	25	68.83/ea pkg

FOR 1/2-13 THREADED ROD SEE THE ADAPTER BELOW.



CONCRETE						
JSMC14201	78370	1/4-20	5/16 x 2 1/4 1/4 DRILL SIZE	1.78	25	76.53/ea pkg
JSMC38161	78375	3/8-16	5/16 x 2 1/4 1/4 DRILL SIZE	1.64	25	65.78/ea pkg

FOR 1/2-13 THREADED ROD SEE THE ADAPTER BELOW.



**ADAPTER TO CONVERT 3/8-16 WOOD, CONCRETE AND STEEL
VERTICAL MOUNT FASTENERS TO ACCEPT 1/2-13 THREADED ROD.**

ADAPTOR						
SME270	41340	3/8-16 to 1/2-13	Threaded Rod		25	45.33/ea pkg



DRIVER						
SMDB21	78420	1/4 & 3/8	Driver	.10	1	29.70/ea

PLEASE CALL FOR TECHNICAL INFORMATION
OTHER SIZES AND QUANTITIES AVAILABLE BY REQUEST

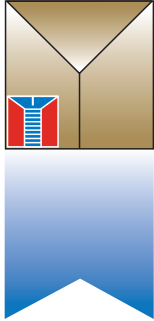

Metallics



HORIZONTAL MOUNT THREADED ROD ANCHOR SYSTEM

SAVES TIME AND COST FROM TRADITIONAL HANGING METHODS

Drill, Drive, Done!



STOCK NO.	UPC NO.	ROD SIZE	SCREW DESCRIPTION	WT. PER PKG.	STD. PKG.	SUGGESTED TRADE LIST PRICE PER
WOOD						
JSMWS14201	78380	1/4-20	5/16 x 2 1/4	2.08	25	76.78/ea pkg
JSMWS38161	78385	3/8-16	5/16 x 2 1/4	1.78	25	76.78/ea pkg

FOR 1/2-13 THREADED ROD SEE THE ADAPTER BELOW.



METAL						
JSMMS14201	78410	1/4-20	1/4-20 x 1 #3 DRILL POINT	1.78	25	83.03/ea pkg
JSMMS38161	78415	3/8-16	1/4-20 x 1 1/2 #3 DRILL POINT	2.16	25	83.03/ea pkg

FOR 1/2-13 THREADED ROD SEE THE ADAPTER BELOW.



CONCRETE						
JSMCS14201	78390	1/4-20	5/16 x 2 1/4 1/4 DRILL SIZE	2.17	25	90.85/ea pkg
JSMCS38161	78395	3/8-16	5/16 x 2 1/4 1/4 DRILL SIZE	1.92	25	90.85/ea pkg

FOR 1/2-13 THREADED ROD SEE THE ADAPTER BELOW.



**ADAPTER TO CONVERT 3/8-16 WOOD, CONCRETE AND STEEL
HORIZONTAL MOUNT FASTENERS TO ACCEPT 1/2-13 THREADED ROD.**

ADAPTOR						
SME270	41340	3/8-16 to 1/2-13	Threaded Rod		25	45.33/ea pkg



DRIVER						
SMDB21	78420	1/4 & 3/8	Driver	.10	1	29.70/ea

PLEASE CALL FOR TECHNICAL INFORMATION
OTHER SIZES AND QUANTITIES AVAILABLE BY REQUEST



PACKED WITH PRIDE

As a part of our Quality Program, each shipment and each single carton leaving our facilities has a label affixed to it, indicating the person who packed the order.

HARD BODY PACKING

When you, the distributor, compare price and performance to other fastener suppliers, please compare our Hard Body Packing to the way they ship products.

We do it the right way—the quality way—the Metallics way.



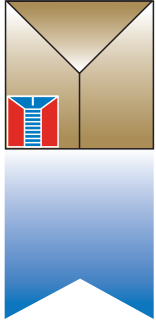

Metallics



STEEL DECKING THREADED ROD ANCHOR SYSTEM

SAVES TIME AND COST FROM TRADITIONAL HANGING METHODS

Drill, Drive, Done!



Expands to provide direct Vertical attachment in:

- Metal Deck (16-22 gauge)
- Z Purlin (16-18 gauge)
- Install in seconds
- Retaining nut is not required

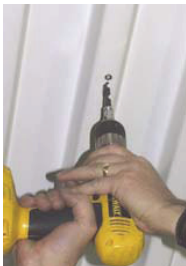

Step 1

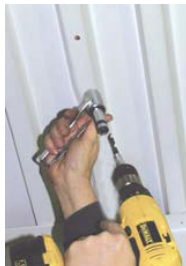

Step 2



Step 3



Step 4



Completed Installation

STOCK NO.	UPC NO.	MOUNT	ROD SIZE	WT. PER PKG.	STD. PKG.	SUGGESTED TRADE LIST PRICE PER
JSMX1	41435	Vertical	1/4 - 20	.44	5	63.10/ea pkg
JSMX2	41440	Vertical	3/8 - 16	.45	5	63.10/ea pkg
JSMX125	41570	Vertical	3/8 - 16	2.02	25	177.25/ea pkg NEW
JSMXP35	41580	Vertical Swivel	3/8 - 16	.48	5	77.33/ea pkg NEW
JSMXP3525	41625	Vertical Swivel	3/8 - 16	2.40	25	377.78/ea pkg NEW
SMXK1	41445		Installation tool	1.01	1	440.40/ea
SMXB1	41450		25/64" Custom Drill Bit for Tool	.90	1	44.63/ea

Installation Kit Includes: Sleeve, bit receiver, hex wrench, and 25/64" drill bit

PLEASE CALL FOR TECHNICAL INFORMATION

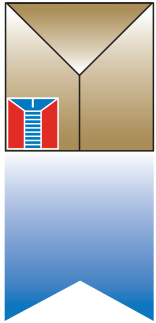

Metallics



SWIVEL HEAD THREADED ROD ANCHOR SYSTEM Drill, Drive, Done!



STOCK NO.	UPC NO.	ROD SIZE	SCREW DESCRIPTION	WT. PER PKG.	STD. PKG.	SUGGESTED TRADE LIST PRICE PER
WOOD						
JSHW3816	41400	3/8-16	1/4 x 2	1.69	25	72.73/ea pkg

APPLICATION - WOOD



DRIVER						
SMDB2	41330	1/4 & 3/8	Driver	.10	1	29.70/ea

APPLICATION - METAL & WOOD DRIVER



Don't Bend That Rod!

- 17° Deflection from Vertical
- Accomodates up to 3-1/2 x 12 Pitch roof

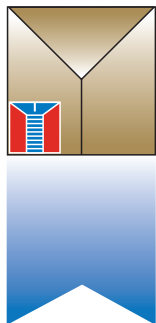

Metallics



ASSORTED KIT FOR WOOD & STEEL THREADED ROD

Drill, Drive, Done!

- 32 piece assortment of our most popular vertical and horizontal for 3/8" threaded rod
- Threaded rod anchoring system for wood & .036", .188", .250", & .500" Steel
- Installation tools included

STOCK NO.	UPC NO.	ROD SIZE	SCREW DESCRIPTION	WT. PER PKG.	STD. PKG.	SUGGESTED TRADE LIST PRICE PER
SMSK1*	41430	Assorted	Assorted	2.44	1	156.68/pkg

* Denotes a product NOT manufactured in the USA (Drivers Only)



Don't get caught off guard. Be prepared!!

HURRICANE / WINDOW SHUTTER SCREWS (STAINLESS STEEL CAPS)



STOCK NO.	UPC NO.	SHANK DIAMETER	SCREW LENGTH	WT. PER PKG.	STD. PKG.	SUGGESTED TRADE LIST PRICE PER
WOOD						
JSMHS10	41415	#10	2	1.05	25	112.78/ea pkg



STOCK NO.	UPC NO.	SHANK DIAMETER	DESCRIPTION	WT. PER PKG.	STD. PKG.	SUGGESTED TRADE LIST PRICE PER
WOOD INSTALLATION TOOL						
SMDH1*	41427	3/16	Installation Tool for Hurricane - Shutter Screws	.03	1	8.23/ea

* Denotes a product NOT manufactured in the USA (Drivers Only)

Predrill a 9/16" diameter counter hole 3/4" deep into the building exterior trim. Install screw flush with the exterior surface.

Note: Concrete requires a 3/16" center drilled hole 2-1/2" deep.



Metallics



NEW CONCRETE/WOOD INSTALLATION KIT

The Concrete/Wood Installation Kit is a quality product, that saves you money and frustration. This multi-purpose kit is convenient and very easy to use.

STOCK NO.	UPC NO.	DESCRIPTION	WT. PER PKG.	SUGGESTED TRADE LIST PRICE PER
SCK1	41589	(1) 7/32" HSD Bit (1) SDS 250 Bit (1/4") (1) SL250 Sleeve (1) HEX 250 Bit Receiver (1/4") (1) SMDB2 Driver (1) SMDB3 Driver (1) 1/8" Allen Wrench (1) 1/4" Concrete Bit	.90	158.78/ea

AMERICA'S SOURCE FOR PREMIER AND INNOVATIVE FASTENERS & ANCHORS



A Modern Up to Date Roll Threading Machine at our Affiliate, Avanti Screw.



Metallics and Avanti Screw, Inc., prime American manufacturers of fastener products, have always worked to present the latest in fastener technology to our distributors and their contractors/users.

Hex Washer Head fasteners have historically only offered three drives—the hex, phillips and the slot. In 1999, we introduced "The QuaDrive" square, hex, slotted and Phillips, in fourteen of the most popular sizes of sheet metal screws.

The QuaDrive

◊ + ◻ + ◯ + ⊕ = ⊕
Square Drive Hex Slotted Phillips QuaDrive

America's Newest Drive - Designed, Developed and Manufactured by Metallics/Avanti Screw

These sheet metal screws are being manufactured to fill the need of the growing demand in the North American markets.

Please note: We recommend driving these sheet metal screws with a hex driving tool. The slotted, Phillips, hex and square drives make it convenient for disassembly.

Metallics



Introducing the New Industry Standard...

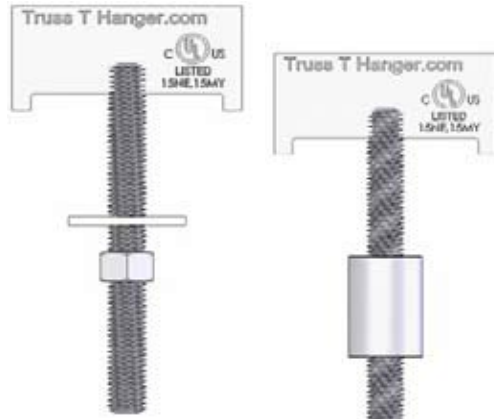

Features and Benefits:

- * UL listed to support 8" max schedule 40 pipe
- * Allowable tension load - 1200 lbs.
- * Test load - 6075 lbs.
- * Unprecedented seismic restraint
- High performance in top and bottom chord
- Distributes the load evenly over the bar joist
- No special tools required
- Fast and easy to install
- Made in USA



Stock No.	UPC	Description	Quantity	Sug. Trade List
TTH1	12251	3/8" T w/ Square Washer & Nut	1	\$19.03/ea.
TTH2	12252	1/2" T w/ Square Washer & Nut	1	\$19.03/ea.
TTH3	12253	1/2" T w/ Threaded Pipe Coupling	1	\$26.70/ea.
TTC1	12270	1/2" -13 to 1/2" NPT Coupling	1	\$13.43/ea.

Application:

The Truss-T Hanger® system for overhead attachment offers a revolutionary process for hanging electrical, fire suppression, plumbing, and HVAC fixtures in open web bar joist truss systems.

Just insert the Truss-T Hanger® in the space between the angle iron of the truss systems and secure with square washer and nut or coupling device. This efficient use of space applies the load symmetrically and delivers a fast, strong, and safe solution for mechanical attachment in both the upper and lower chord of the truss, **while saving up to 70% in labor costs!**

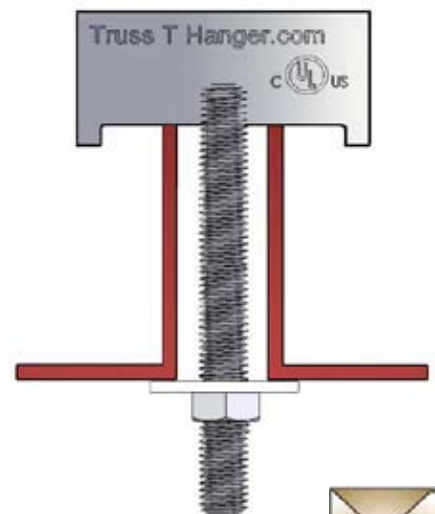

Truss-T Hanger® is a Registered Trademark

SPECIAL PURPOSE ELECTRICAL FASTENERS

METALLICS IS THE ONLY FASTENER SUPPLIER TO AMERICA'S DISTRIBUTORS TO MANUFACTURE ITS OWN GROUNDING SCREWS

MADE IN USA



Manufactured by
Avanti Screw, Inc.,
A Metallics
Affiliate

GROUNDING SCREW

ROUND HEAD WASHER "COMBO" SLOTTED / PHILLIPS
STEEL GREEN ZINC CHROMATE



STOCK NO.	BOX UPC NO.	JAR UPC NO.	SIZE	WT. PER PKG.	STD. PKG.	SUGGESTED TRADE LIST PRICE PER
GS20	16105		10-32 x 3/8	.58	100	6.53/c
JGS20		82643	10-32 x 3/8	.54	100	6.53/c
GS20500		82005	10-32 x 3/8	2.75	500	27.70/ea pkg

GROUNDING SCREW

HEX WASHER "COMBO" SLOTTED / PHILLIPS
DOG POINT - STEEL GREEN ZINC CHROMATE



STOCK NO.	BOX UPC NO.	JAR UPC NO.	SIZE	WT. PER PKG.	STD. PKG.	SUGGESTED TRADE LIST PRICE PER
JGSH19		82079	8/32 x 5/16 Type F	.35	100	10.55/c NEW
GSH20	16110		10-32 x 3/8	.57	100	6.53/c
JGSH20		82080	10-32 x 3/8	.55	100	6.53/c
GSH20500		82010	10-32 x 3/8	2.45	500	27.70/ea pkg

GROUNDING SCREW

HEX WASHER "COMBO" SLOTTED / PHILLIPS
TYPE 23 THREAD CUTTING
STEEL GREEN ZINC CHROMATE



MADE IN USA



Manufactured by
Avanti Screw, Inc.,
A Metallics
Affiliate

STOCK NO.	BOX UPC NO.	JAR UPC NO.	SIZE	WT. PER PKG.	STD. PKG.	SUGGESTED TRADE LIST PRICE PER
GSH23	16115		10-32 x 3/8	.53	100	6.53/c
JGSH23		82091	10-32 x 3/8	.54	100	6.53/c
GSH23500		82015	10-32 x 3/8	2.55	500	27.70/ea pkg

EASTERN

8:00 A.M.
to
5:00 P.M.



Metallics, Inc. CT

CENTRAL



MOUNTAIN

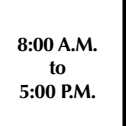

8:00 A.M.
to
5:00 P.M.





Metallics, West Inc. CO

In the event Metallics East, Bristol is CLOSED, call Metallics West at 1-800-269-5183 if you require technical information or overnight shipments

WE ARE HERE TO SERVE ALL OF YOUR FASTENER AND ANCHOR NEEDS

SPECIAL PURPOSE ELECTRICAL FASTENERS

Four drives in one head

-  Hex
-  Slotted
-  Phillips
-  Square Drive

Introduced in 1999



GROUNDING SCREW

"QUADRI" HEX WASHER, SLOTTED, PHILLIPS
AND SQUARE DRIVE DOG POINT
STEEL GREEN ZINC CHROMATE

MADE IN USA



Manufactured by
Avanti Screw, Inc.,
A Metallics
Affiliate

STOCK NO.	BOX UPC NO.	JAR UPC NO.	SIZE	WT. PER PKG.	STD. PKG.	SUGGESTED TRADE LIST PRICE PER
GSH21	16111		10-32 x 3/8	.65	100	6.53/c
JGSH21		82081	10-32 x 3/8	.63	100	6.53/c
GSH21500		82011	10-32 x 3/8	2.99	500	27.70/ea pkg

Four drives in one head

-  Hex
-  Slotted
-  Phillips
-  Square Drive

Introduced in 1999



GROUNDING SCREW

"QUADRI" HEX WASHER, SLOTTED, PHILLIPS
AND SQUARE DRIVE - TYPE 23 THREAD CUTTING
STEEL GREEN ZINC CHROMATE

MADE IN USA



Manufactured by
Avanti Screw, Inc.,
A Metallics
Affiliate

STOCK NO.	BOX UPC NO.	JAR UPC NO.	SIZE	WT. PER PKG.	STD. PKG.	SUGGESTED TRADE LIST PRICE PER
GSH22	16112		10-32 x 3/8	.53	100	6.53/c
JGSH22		82090	10-32 x 3/8	.57	100	6.53/c
GSH22500		82012	10-32 x 3/8	2.97	500	27.70/ea pkg



7 INCH

GROUNDING PIGTAILS

WITH HEX WASHER "COMBO" SLOTTED
PHILLIPS DOG POINT
STEEL GREEN ZINC
GROUNDING SCREW ATTACHED

Wire

MADE IN USA



Assembled in
USA

STOCK NO.	UPC NO.	SIZE	WT. PER PKG.	STD. PKG.	SUGGESTED TRADE LIST PRICE PER
SOLID COPPER INSULATED WIRE IN A PLASTIC BOX					
PT30	16000	#14 Wire	1.51	Box of 100	41.65/ea pkg
PT40	16005	#12 Wire	2.00	Box of 100	46.68/ea pkg
PT40K	10679	#12 Wire	4.77	Jar of 250	110.18/ea pkg

THE PT40K COMES IN A PLASTIC JAR

SPECIAL PURPOSE ELECTRICAL FASTENERS

GROUNDING PIGTAILS

WITH HEX WASHER "COMBO"
SLOTTED/PHILLIPS DOG POINT
STEEL GREEN ZINC
GROUNDING SCREW ATTACHED



7 INCH

STOCK NO.	UPC NO.	SIZE	WT. PER PKG.	STD. PKG.	SUGGESTED TRADE LIST PRICE PER
STRANDED COPPER INSULATED WIRE (with fork and ring terminal) IN A PLASTIC BOX					
PTS30	16001	#14 Wire	1.13	Box of 50	42.78/ea pkg
PTS40	16006	#12 Wire	1.41	Box of 50	58.25/ea pkg

OTHER SIZES AND QUANTITIES AVAILABLE BY REQUEST

GROUNDING PIGTAILS

WITH HEX WASHER "COMBO"
SLOTTED/PHILLIPS DOG POINT
STEEL GREEN ZINC
GROUNDING SCREW ATTACHED



7 INCH

STOCK NO.	UPC NO.	SIZE	WT. PER PKG.	STD. PKG.	SUGGESTED TRADE LIST PRICE PER
BARE SOLID COPPER WIRE (the economic alternative) IN A PLASTIC BOX					
PT30B	16015	#14 Wire	1.42	Box of 100	38.83/ea pkg
PT40B	16010	#12 Wire	1.87	Box of 100	46.15/ea pkg

OTHER SIZES AND QUANTITIES AVAILABLE BY REQUEST

GROUNDING PIGTAILS

WITH "QUADRI" HEX WASHER, SLOTTED,
PHILLIPS, SQUARE DRIVE, DOG POINT
STEEL GREEN ZINC
GROUNDING SCREW ATTACHED



7 INCH

The QuaDrive

Square Drive

Hex

Slotted

Phillips

QuaDrive

+ + + + =

America's Newest Drive - Designed, Developed and Manufactured by Metallics/Avanti Screw

STOCK NO.	UPC NO.	SIZE	WT. PER PKG.	STD. PKG.	SUGGESTED TRADE LIST PRICE PER
SOLID COPPER INSULATED WIRE IN A PLASTIC BOX					
PT35	16021	#14 Wire	1.62	Box of 100	41.65/ea pkg
PT45	16005	#12 Wire	2.06	Box of 100	46.68/ea pkg

OTHER SIZES AND QUANTITIES AVAILABLE BY REQUEST

SPECIAL PURPOSE ELECTRICAL FASTENERS



10 INCH

GROUNDING PIGTAILS

WITH HEX WASHER "COMBO"
SLOTTED/PHILLIPS DOG POINT
STEEL GREEN ZINC
GROUNDING SCREW ATTACHED



STOCK NO.	UPC NO.	SIZE	WT. PER PKG.	STD. PKG.	SUGGESTED TRADE LIST PRICE PER
SOLID COPPER INSULATED WIRE IN A PLASTIC BAG					
PT4010	16007	#12 Wire	.65	Bag of 25	13.45/ea pkg of 25
PT4010V	16092	#12 Wire	13.00	500	242.00/ea pkg NEW

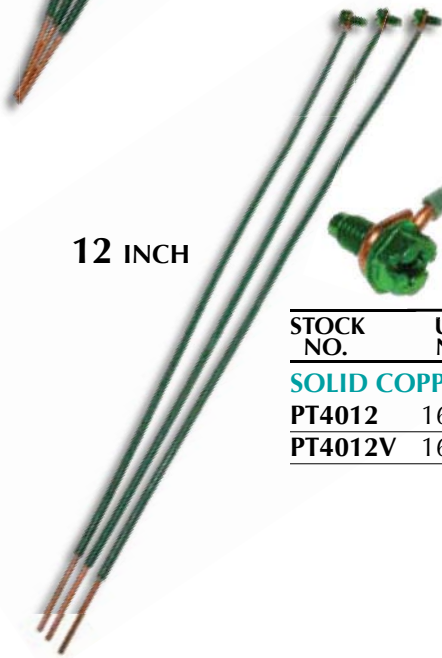

12 INCH

GROUNDING PIGTAILS

WITH "QUADrive" HEX WASHER, SLOTTED/PHILLIPS,
SQUARE DRIVE DOG POINT
STEEL GREEN ZINC
GROUNDING SCREW ATTACHED



STOCK NO.	UPC NO.	SIZE	WT. PER PKG.	STD. PKG.	SUGGESTED TRADE LIST PRICE PER
SOLID COPPER INSULATED WIRE IN A PLASTIC BAG					
PT4012	16012	#12 Wire	.72	Bag of 25	14.28/ea pkg of 25
PT4012V	16094	#12 Wire	15.50	500	270.98/ea pkg NEW

The QuaDrive

Square Drive

+

Hex

+

Slotted

+

Phillips

=

QuaDrive

America's Newest Drive - Designed, Developed and Manufactured by Metallics/Avanti Screw



GROUNDING CLIPS

STEEL GREEN ZINC CHROMATE
DESIGNED TO FIT #10-#12-#14
COPPER OR ALUMINUM WIRE



STOCK NO.	BOX UPC NO.	UPC NO.	WT. PER PKG.	STD. PKG.	SUGGESTED TRADE LIST PRICE PER
CG20	16100		.42	100	16.33/c
JCG20		83100	1.78	500 Jar	63.36/ea pkg
CG20500		82649	.40	100	16.33/c

SPECIAL PURPOSE ELECTRICAL FASTENERS



THREE-IN-ONE TAP THREAD CLEANING TOOL

STOCK NO.	UPC NO.	DESCRIPTION	WT. EACH	STD. PKG.	SUGGESTED TRADE LIST PRICE PER
681032	16345	6-32,8-32,10-32 Thread Cleaning Tool	.21	1	29.00/ea



GRAY CONICAL PLASTIC WALL ANCHOR KITS

A SPECIAL USE WALL ANCHOR KIT FOR HANGING RACEWAY. THE 10 x 1 FLAT HEAD PHILLIPS SMS ZINC PLATED FITS FLUSH WITH METAL AND WILL NOT DAMAGE WIRE

MASTER
CARTONS
CONTAIN:
25 KITS
18 JARS



STOCK NO.	UPC NO.	DESCRIPTION OF CONTENTS	WT. EACH	SUGGESTED TRADE LIST PRICE PER
ANCHOR KIT DESIGNED FOR RACEWAY				
WAK23F	39182/kit	100 - 1/4 Gray Ribbed Anchors	.80	13.25/ea kit
WAKJ23F	20745/jar	100 - 10 x 1 Flat Head Phillips Screws 1 - 1/4 Masonry Drill	.80	13.25/ea kit



TELECOM CABINET SCREW

For use in telecom cabinets, relay racks and patch panels
BIND HEAD (SLOTTED, PHILLIPS, SQUARE DRIVE)
TRI-DRIVE STEEL MACHINE SCREW/DOG (LEAD) POINT/ZINC PLATED
PACKAGED IN PLASTIC VISUAL HANGING BOXES

STOCK NO.	UPC NO.	SIZE	WT. PER PKG.	STD. PKG.	SUGGESTED TRADE LIST PRICE PER
TEL1024BLK	39250	10-24 x 5/8	.52	50	25.00/ea pkg NEW
TEL1032BLK	39260	10-32 x 5/8	.52	50	25.00/ea pkg NEW
TEL1224	39096	12-24 x 5/8	.48	50	8.73/ea pkg
TEL1224BLK	39097	12-24 x 5/8	.48	50	26.55/ea pkg NEW
TEL1228	39095	12-28 x 5/8	.52	50	8.73/ea pkg NEW

OTHER SIZES AND QUANTITIES AVAILABLE BY REQUEST
JAR PACKAGING ALSO AVAILABLE

SPECIAL PURPOSE ELECTRICAL FASTENERS

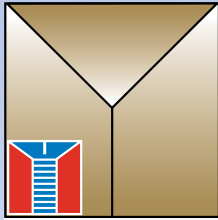

Metallics



Cage Nuts

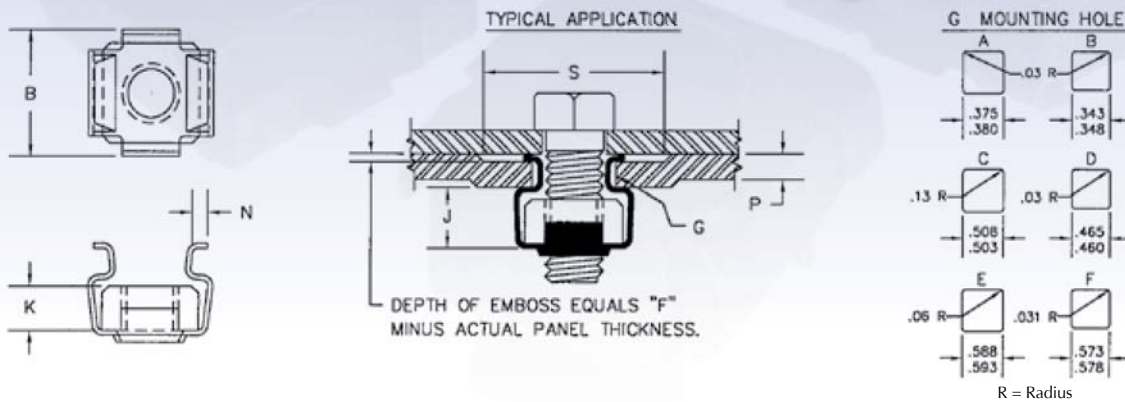

SCREW SIZE	PANEL RANGE P	F	S	MNTG. HOLE G	B	J	N	K	PART NUMBER
12-24	.025 - .063	0.1	0.531	A or B	0.52	0.06	0.6	0.156	CNN1224
10-24	.025 - .063	0.1	0.531	A or B	0.52	0.06	0.6	0.156	CNN1024
10-32	.025 - .063	0.1	0.531	A or B	0.52	0.06	0.6	0.156	CNN1032

Other sizes available on request.

Some sizes available in stainless steel.

PART #	UPC #	DESCRIPTION	QTY / PKG	SUG. TRADE LIST / PKG
CNN1224	30035	12-24 Cage Nuts .025 - .063 Panel Range .343 - .348 or .375 - .380 Mounting Hole Black Phosphate Coated	50	\$ 33.35
CNN1024	30030	10-24 Cage Nut .025 - .063 Panel Range .343 - .348 or .375 - .380 Mounting Hole Black Phosphate Coated	50	\$ 29.78
CNN1032	30025	10-32 Cage Nut .025 - .063 Panel Range .343 - .348 or .375 - .380 Mounting Hole Black Phosphate Coated	50	\$ 27.30

★ ★ ★ ★ ★ "Growth Through Innovation" ★ ★ ★ ★ ★

Metallics

229 Cross Street, Bristol, CT 06010
Tel 800-243-8272 • **Fax** 800-831-9358
Email sales@metallicsonline.com

Metallics West

651 North Main Street, Mancos, CO 81328
Tel 800-269-5183 • **Fax** 800-269-6278
Email saleswest@metallicsonline.com

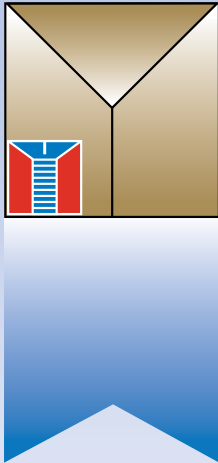

Metallics



Cage Nut Kits

For use in Telecom Cabinets, Relay Racks and Patch Panels

Each kits contains 50 Cage Nuts and 50 Screws



- Three Different Sizes:
 - 12-24
 - 10-24
 - 10-32
- Screws are Pan Head, Tri-Drive (Slotted, Phillips, Square Drive), Lead-Point 5/8" Long Black Oxide.
- Cage Nuts are for Panel thickness of range .025-.063 with a mounting hole of .343-.348 or .375-.380 and are phosphate coated.

PART #	UPC #	DESCRIPTION	QTY / PKG	SUG. TRADE LIST / PKG
CNN1224K	85595	12-24 Cage Nuts .025-.063 Panel Range Mounting Hole .343-.348 or .375-.380 12-24 x 5/8" Pan Head, Tri-Drive, Lead Point, Black Screw	50 of ea.	\$ 56.88
CNN1024K	85585	10-24 Cage Nuts .025-.063 Panel Range Mounting Hole .343-.348 or .375-.380 10-24 x 5/8" Pan Head, Tri-Drive, Lead Point, Black Screw	50 of ea.	\$ 52.08
CNN1032K	85590	10-32 Cage Nuts .025-.063 Panel Range Mounting Hole .343-.348 or .375-.380 10-32 x 5/8" Pan Head, Tri-Drive, Lead Point, Black Screw	50 of ea.	\$ 49.83

★ ★ ★ ★ ★ "Growth Through Innovation" ★ ★ ★ ★ ★

Metallics

229 Cross Street, Bristol, CT 06010
Tel 800-243-8272 • **Fax** 800-831-9358
Email sales@metallicsonline.com

Metallics West

651 North Main Street, Mancos, CO 81328
Tel 800-269-5183 • **Fax** 800-269-6278
Email saleswest@metallicsonline.com

SPECIAL PURPOSE ELECTRICAL FASTENERS



WALL PLATE SCREW

STEEL AND STAINLESS STEEL
SLOTTED OVAL HEAD • PLATED AND PAINTED
PACKAGED IN VISUAL PLASTIC HANGING BOX

STOCK NO.	UPC NO.	SIZE	COLOR	WT. PER PKG.	STD. PKG./MSTR. SLEEVE	SUGGESTED TRADE LIST PRICE PER
SP170	16406	6-32 x 1/2	Stainless Steel	.29	100/500	9.55/c
SP176	16305	6-32 x 1/2	Brass Plate	.26	100/500	8.95/c
SP177	16310	6-32 x 1/2	Nickel Plate	.29	100/500	8.33/c
SP178	16315	6-32 x 1/2	Antique Black	.26	100/500	7.68/c
SP179	16320	6-32 x 1/2	White	.28	100/500	7.68/c
SP180	16325	6-32 x 1/2	Ivory	.29	100/500	7.68/c
SP173	16300	6-32 x 1/2	Light Almond	.30	100/500	7.68/c
SP181	16330	6-32 x 1/2	Gray	.28	100/500	6.10/c NEW
SP182	16335	6-32 x 3/4	Brown	.28	100/500	3.55/c
SP190	16303	6-32 x 3/4	White	.35	100/500	9.58/c
SP191	16304	6-32 x 3/4	Ivory	.36	100/500	9.58/c
SP382	10323	6-32 x 7/32	Brown	.18	100/500	15.53/c NEW
SP380	10321	6-32 x 7/32	Ivory	.18	100/500	15.53/c NEW
SP379	10320	6-32 x 7/32	White	.18	100/500	15.53/c NEW
SP279	16301	6-32 x 1	White	.43	100/500	9.83/c
SP280	16302	6-32 x 1	Ivory	.43	100/500	9.83/c
SP283	16413	6-32 x 1	Stainless Steel	.43	100/500	12.60/c NEW
SP172	16307	6-32 x 1 1/4	Stainless Steel	.44	100/500	15.73/c NEW
SP281	16411	6-32 x 2	Ivory Switch Plate	.72	100/500	12.05/c NEW
SP282	16412	6-32 x 2	White Switch Plate	.72	100/500	12.05/c NEW

SWITCH PLATE SCREW KITS

A convenient assortment of Switch Plate Screws
in the most popular colors and finishes
Plated and Painted



275 PIECE RENOVATION KIT SPK100 CONTAINS:

50 Black, 50 Nickel, 50 Light Almond, 50 Ivory, 50 White
25 6-32 x 1 1/4 Flat Head Slot Switch Plate Screw, Zinc Plated

500 PIECE NEW CONSTRUCTION SPK101 CONTAINS:

100 each 6-32 x 1/2 Ivory, White, Stainless
75 each 6-32 x 1 Ivory, White
50 6-32 x 1 1/4 Flat Head Slot Switch Plate Screw, Zinc Plated

**MASTER
CARTONS
CONTAIN:
25 KITS
18 JARS**

STOCK NO.	UPC NO.	DESCRIPTION OF CONTENTS	WT. PER KIT	SUGGESTED TRADE LIST PRICE PER
SPK100 RENOVATION	16400	6-32 x 1/2 Oval Head Steel Switch Plate Screw Assortment	1.84	21.50/ea pkg
SPK101 NEW CONSTRUCTION	16401	6-32 x 1/2 Oval Head Steel Switch Plate Screw Assortment	1.60	40.88/ea pkg

SPECIAL PURPOSE ELECTRICAL FASTENERS



NYLON SWITCH PLATE SCREW

SLOTTED OVAL HEAD
PACKAGED IN VISUAL PLASTIC HANGING BOX

STOCK NO.	UPC NO.	SIZE	STD. PKG.	WT. PER PKG.	STD. PKG./MSTR. SLEEVE	SUGGESTED TRADE LIST PRICE PER
SPN300	16350	6-32 x 1/2	100	.11	100/500	8.40/c



DECORATIVE SWITCH PLATE SCREW

STEEL, SLOTTED, UNDERCUT OVAL HEAD (PAINTED)
FOR WALL PLATES NOT ACCEPTING STANDARD
1/2" SWITCH PLATE SCREWS

STOCK NO.	UPC NO.	SIZE	COLOR	WT. PER PKG.	STD. PKG.	SUGGESTED TRADE LIST PRICE PER
SPD379	16321	6-32 x 1/4	White	.14	50	3.33/ea pkg
SPD380	16326	6-32 x 1/4	Ivory	.14	50	3.33/ea pkg
SPD382	16336	6-32 x 1/4	Light Almond	.12	50	3.50/ea pkg
SPD383	16341	6-32 x 1/4	Gray	.12	50	3.50/ea pkg
SPD381	16327	6-32 x 1/4	Brown	.14	50	3.50/ea pkg NEW
SPD384	16342	6-32 x 1	White	.25	50	4.35/ea pkg
SPD385	16343	6-32 x 1	Ivory	.26	50	4.35/ea pkg



DECORATIVE SWITCH PLATE SCREW KIT

STEEL, SLOTTED, UNDERCUT OVAL HEAD
A convenient assortment of popular colors
For wall plates not accepting standard
1/2" switch plate screws.

250 PIECE SPDK200 KIT CONTAINS:

6-32 x 1/4" - 50 White, 50 Ivory, 50 Light Almond, 50 Gray
PLUS
6-32 x 1" - 25 White, 25 Ivory

STOCK NO.	UPC NO.	DESCRIPTION OF CONTENTS	WT. PER KIT	STD. PKG./MSTR. CARTON	SUGGESTED TRADE LIST PRICE PER
SPDK200	16405	6-32 x 1/4" & 1" Assorted Steel Slotted, Undercut, Oval Head Switch Plate Screws	.68	1/25 Kits	22.18/ea kit

SPECIAL PURPOSE ELECTRICAL FASTENERS

TAMPER-RESIST SPANNER OVAL HEAD SWITCH PLATE SCREW



STAINLESS STEEL

Only authorized persons would normally have a spanner driver to extract this screw

A special wall plate screw for use in public areas like restrooms where water, mist and vapors are present that could corrode ordinary steel screws. Vandalism is discouraged due to the unique nature of the Spanner Driver.*

Packaged in Visual Plastic Hanging Boxes

STOCK NO.	UPC NO.	SIZE	WT. PER PKG.	STD. PKG.	SUGGESTED TRADE LIST PRICE PER
SPT300	10270	6-32 x 1	.27	50	36.83/ea pkg NEW
SPT200	16355	6-32 x 1/2	.19	50	35.98/ea pkg
SPT400	10275	6-32 x 1 1/2	.35	50	49.83/ea pkg

*COMES COMPLETE WITH 00SP6B SPANNER INSERT DRIVER

RECEPTACLE AND WIRING DEVICES SCREW



TRUSS HEAD COMBO (PHILLIPS/SLOTTED)

STEEL MACHINE SCREW - **HARDENED TYPE F ZINC PLATED**

For our product offering we have chosen to give an added benefit (not offered by our competition) by supplying a Type F thread-forming feature. We offer this because electricians in the field often use a screw that will thread a hole in plastic boxes or need it to clean out plaster.

Packaged in Visual Plastic Hanging Boxes

STOCK NO.	UPC NO.	SIZE	WT. PER PKG.	STD. PKG.	SUGGESTED TRADE LIST PRICE PER
TM80	43138	6-32 x 1/2	.26	100	4.70/c
TM81	43141	6-32 x 3/4	.37	100	4.85/c
TM63	43144	6-32 x 1	.44	100	4.90/c
TM68	43147	6-32 x 1 1/4	.49	100	6.38/c
TM82	43150	6-32 x 1 1/2	.62	100	6.93/c
TM83	43153	6-32 x 2	.79	100	8.93/c

JAR PACKAGING ALSO AVAILABLE

RECEPTACLE AND WIRING DEVICES SCREW



TRUSS HEAD COMBO (PHILLIPS/SLOTTED)

STEEL MACHINE SCREW • **ZINC PLATED - LEAD POINT**

STARTS E-Z

Packaged in Visual Plastic Hanging Boxes

Manufactured by Avanti Screw, Inc., A Metallics Affiliate

STOCK NO.	UPC NO.	SIZE	WT. PER PKG.	STD. PKG.	SUGGESTED TRADE LIST PRICE PER
TM80LP	43154	6-32 x 1/2	.28	100	4.25/c
TM81LP	43155	6-32 x 3/4	.38	100	4.35/c
TM63LP	43156	6-32 x 1	.44	100	4.38/c
TM68LP	43157	6-32 x 1 1/4	.52	100	5.73/c
TM82LP	43158	6-32 x 1 1/2	.62	100	6.23/c
TM83LP	43159	6-32 x 2	.79	100	8.03/c

OTHER SIZES AND QUANTITIES AVAILABLE BY REQUEST

JAR PACKAGING ALSO AVAILABLE

SPECIAL PURPOSE ELECTRICAL FASTENERS

INSULATING FOAM GASKETS



- Energy saving gaskets prevent heat and cold loss through outlets and switches located on outside walls.
- Constructed of UL Rated, close-cell polyethylene insulating foam.
- Available in three different designs: Toggle Switch, Duplex Receptacle & GFI or Decora

STOCK NO.	UPC NO.	DESCRIPTION	WT. PER EACH	STD. PKG.	SUGGESTED TRADE LIST PRICE PER
WGT25	71651	Toggle Switch	.14	25	6.38/ea pkg
WGR25	71652	Duplex Receptacle	.14	25	6.38/ea pkg
WGD25	71653	GFI/Decora	.14	25	6.38/ea pkg
WGT100	71654	Toggle Switch	.48	100	22.83/ea pkg
WGR100	71655	Duplex Receptacle	.48	100	22.83/ea pkg
WGD100	71656	GFI/Decora	.48	100	22.83/ea pkg
WGC100	71657	Combo Pack	.48	100	22.83/ea pkg

CONTAINS: 30 TOGGLE, 30 DUPLEX, 40 DECORA



THUMB SCREW ^{NEW}

STAINLESS STEEL 18-8 TYPE

STOCK NO.	UPC NO.	SIZE	WT. PER PKG.	STD. PKG.	SUGGESTED TRADE LIST PRICE PER
JTMS1SS	92893	1/4 - 20 x 1	1.68	100	136.55/c NEW
JTMS2SS	92894	1/4 - 20 x 2	2.67	100	235.06/c NEW



SPANNER INSERT DRIVER

For use in driving and extracting vandalism deterrent screw

STOCK NO.	UPC NO.	SIZE	WT. PER PKG.	STD. PKG.	SUGGESTED TRADE LIST PRICE PER
00SP6B	25027	#6	.01	1	5.03/ea



CONDUIT DRIVE STRAPS

ROUND TYPE
STEEL ZINC PLATED
PACKAGED IN CLEAR PLASTIC JARS



STOCK NO.	UPC NO.	SIZE EMT	SIZE PIPE & FLEX. COND.	SIZE OVERALL LENGTH	WT. PER PKG.	STD. PKG.	SUGGESTED TRADE LIST PRICE PER
CDS1	21200	3/8 - 1/2	3/8	2	1.93	100	21.43/c
CDS2	21205	3/4	1/2	2 1/4	2.23	100	24.33/c
CDS3	21210	1	3/4	2 1/4	2.37	100	27.73/c

STEEL ZINC PLATED For use in metal and plastic conduit and tubing

CONTINUED ON NEXT PAGE

SPECIAL PURPOSE ELECTRICAL FASTENERS

CONTINUED

CONDUIT DRIVE STRAPS



ROUND TYPE
STEEL COPPER PLATED
PACKAGED IN CLEAR PLASTIC JARS



STOCK NO.	UPC NO.	SIZE COPPER TUBE	SIZE COPPER PIPE	SIZE OVERALL LENGTH	WT. PER PKG.	STD. PKG.	SUGGESTED TRADE LIST PRICE PER
STEEL COPPER PLATED For use in areas requiring copper pipe and tubing							
CDS5	21300	1/2	3/8 - 1/2	2	1.87	100	19.30/c
CDS6	21305	3/4	3/4	2 1/4	2.50	100	20.70/c

CONDUIT DRIVE STRAPS FOR PLUMBING ROUND TYPE, STEEL COPPER PLATED



CONDUIT DRIVE STRAPS

FLAT STAMPED TYPE GALVANIZED



EMT	UPC NO.	SIZE PIPE	SIZE	WT. PER PKG.	STD. PKG.	SUGGESTED TRADE LIST PRICE PER
STAMPED GALVANIZED						
SDS10	21215	3/8 - 1/2	3/8	1.70	100	18.60/c
SDS20	21220	3/4	1/2	2.13	100	21.13/c
SDS30	21225	1	3/4	2.29	100	22.55/c



PLUMBERS TAPE PERFORATED

STEEL GALVANIZED



STOCK NO.	UPC NO.	SIZE	WT. PER PKG.	STD. PKG. (100 ft total)	SUGGESTED TRADE LIST PRICE PER
HR750	22550	20 Gauge x 3/4	7.80	10 rolls of 10 ft. per pkg	34.00/ea pkg
HR760	22552	22 Gauge x 3/4	7.60	10 rolls of 10 ft. per pkg	21.40/ea pkg
HR770	22553	26 Gauge x 3/4	4.31	10 rolls of 10 ft. per pkg	18.25/ea pkg
HR780	22554	28 Gauge x 3/4	4.30	10 rolls of 10 ft. per pkg	13.95/ea pkg

COPPER AVAILABLE UPON REQUEST



NAIL PLATES

STEEL
For Romex, BX, UF, S.E.V. and other Cables
Other sizes & gauges available by request



STOCK NO.	UPC NO.	SIZE	GAUGE	WT. PER PKG.	STD. PKG.	SUGGESTED TRADE LIST PRICE PER
NP400	16500	2 3/4" long x 1 1/2" wide	16	6.40	100	20.83/c
NP400B	16510	1 1/2" long x 2 3/4" wide	16	33.90	500	116.56/ea pkg NEW
NP660	16599	1 1/2" long x 5" wide	16	7.00	100	45.00/c NEW
NP600	16503	5" long x 1 1/2" wide	20	7.18	100	30.88/c
NP800	16504	5" long x 3" wide	16	24.25	100	53.38/c

SPECIAL PURPOSE ELECTRICAL FASTENERS



PLATE STRAP

STEEL

MADE IN USA



STOCK NO.	UPC NO.	SIZE	GAUGE	WT. PER PKG.	STD. PKG.	SUGGESTED TRADE LIST PRICE PER	
NS1812	22548	1-1/2" x 8" hole	12	16.15	25	38.20/ea pkg	
NS1816	22549	1-1/2" x 8" hole	16	45.45	25	28.47/ea pkg	
NPL12	12194	1 1/2" long x 12" wide	18	19.00	50	56.25/ea pkg	NEW
NP580	16520	5" long x 8" wide	16	32.00	50	155.15/ea pkg	NEW
NPL188	16480	5" long x 18" wide	16	39.19	25	155.00/ea pkg	NEW

OTHER SIZES, GAUGES, AND QUANTITIES AVAILABLE BY REQUEST.



BOX SUPPORTS

STEEL
ELECTRO-GALVANIZED

STOCK NO.	UPC NO.	WT. PER PKG.	STD. PKG.	SUGGESTED TRADE LIST PRICE PER
SB300	16200	5.29	100 pairs/200 pieces total	52.70/ea pkg

KNOCK-OUT SEALS

THE ULTIMATE IN HIGH QUALITY SAFETY
3-PIECE QUICK-SEAL TO PLUG HOLES IN PANEL BOXES

MADE IN USA



100KOS

SIZE IS STAMPED ON SEAL

We believe they are easier to use than the one-piece push-in seals. Many areas of the country are requiring a better Knock-Out Seal. Our Electrical Distributors have been asking us for this product in a smaller pack. Now we offer a smaller quantity Contractor Poly Bag.



150KOSG

STOCK NO.	UPC NO.	DESCRIPTION	WT. PER PKG.	STD. PKG.	SUGGESTED TRADE LIST PRICE PER
50KOS	41301	1/2" - 3 piece K/O Seal	.25	10	15.48/ea pkg
75KOS	41302	3/4" - 3 piece K/O Seal	.33	10	20.83/ea pkg
100KOS	41303	1" - 3 piece K/O Seal	.47	10	21.15/ea pkg
125KOS	41304	1 1/4" - 3 piece K/O Seal	.74	10	22.83/ea pkg
150KOS	41306	1 1/2" - 3 piece K/O Seal	.95	10	28.88/ea pkg
200KOS	41307	2" - 3 piece K/O Seal	1.38	10	39.98/ea pkg
250KOS	41308	2 1/2" - 3 piece K/O Seal	2.10	10	69.18/ea pkg
300KOS	41309	3" - 3 piece K/O Seal	1.50	5	44.00/ea pkg
350KOS	41311	3 1/2" - 3 piece K/O Seal	1.93	5	62.08/ea pkg
400KOS	41312	4" - 3 piece K/O Seal	2.74	5	71.18/ea pkg

NEW GASKETED

50KOSG	41650	1/2" - 4 piece K/O Seal	.30	10	29.00/ea pkg	NEW
75KOSG	41651	3/4" - 4 piece K/O Seal	.36	10	30.88/ea pkg	NEW
100KOSG	41652	1" - 4 piece K/O Seal	.45	10	34.75/ea pkg	NEW
125KOSG	41653	1 1/4" - 4 piece K/O Seal	.78	10	40.44/ea pkg	NEW
150KOSG	41654	1 1/2" - 4 piece K/O Seal	.94	10	53.58/ea pkg	NEW
200KOSG	41655	2" - 4 piece K/O Seal	1.62	10	66.75/ea pkg	NEW
250KOSG	41658	2 1/2" - 4 piece K/O Seal	2.10	10	111.63/ea pkg	NEW
300KOSG	41660	3" - 4 piece K/O Seal	1.74	5	71.45/ea pkg	NEW
400KOSG	41317	4" - 4 piece K/O Seal	2.94	5	78.63/ea pkg	NEW

SPECIAL PURPOSE ELECTRICAL FASTENERS



GALVANIZED NAIL-ON DRIVE RINGS

STEEL ZINC PLATED

PACKAGED 10 PER POLY BAG

STOCK NO.	UPC NO.	EYE SIZE	WT. PER PKG.	STD. PKG.	SUGGESTED TRADE LIST PRICE PER
MDR12	81549	1/2	.14	10	2.68/ea pkg
MDR58	81551	5/8	.14	10	3.38/ea pkg
MDR78	81553	7/8	.53	10	6.05/ea pkg
MDR114	81555	1 1/4	.78	10	8.05/ea pkg



MBR125

PACKAGED 10 PER POLY BAG

BRIDLE RINGS

STEEL ZINC PLATED



MBR150WS

STOCK NO.	UPC NO.	EYE SIZE/THREAD SIZE	WT. PER PKG.	STD. PKG.	SUGGESTED TRADE LIST PRICE PER
MACHINE SCREW THREAD					
MBR125	81557	1 1/4 x 1/4-20	.72	10	13.45/ea pkg
MBR150	81559	1 1/2 x 1/4-20	.81	10	13.45/ea pkg
MBR200	81561	2 x 1/4-20	.97	10	13.45/ea pkg
WOOD SCREW THREAD					
MBR100WS	81560	1 x .230	.58	10	9.38/ea pkg NEW
MBR150WS	81563	1 1/2 x .230	.79	10	19.50/ea pkg
MBR200WS	81565	2 x .230	.98	10	19.50/ea pkg



ANGLED CONDUIT CLAMP

OFFSET AND ANGLED FOR FAST, SECURE INSTALLATION OF EMT CONDUIT
PRE-THREADED TAPPED HOLE FOR SECURE INSTALLATION
STEEL ZINC CHROMATE

PACKAGED 10 PER POLY BAG

STOCK NO.	UPC NO.	SIZE	WT. PER PKG.	STD. PKG.	SUGGESTED TRADE LIST PRICE PER
MEZ50	81510	1/2	1.37	10	17.48/ea pkg
MEZ75	81512	3/4	1.47	10	18.80/ea pkg
MEZ100	81514	1	1.61	10	21.50/ea pkg
MEZ125	81516	1 1/4	1.89	10	24.18/ea pkg
MEZ150	81518	1 1/2	2.03	10	28.20/ea pkg
MEZ200	81520	2	2.31	10	29.55/ea pkg

Helpful Hints From Metallics:

Did You forget to ask?

GOT FASTENERS?

"We work hard to improve both Distributor Profit and Customer Satisfaction."

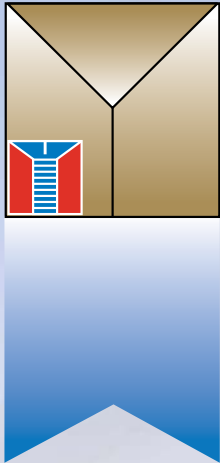

Metallics



Contractor Nail Apron

- Natural Canvas with 2 Large Pockets
- Large Pockets for Tools or Fasteners
- One Small Pocket for Pen or Pencil



PART #	UPC #	DESCRIPTION	QTY / PKG	SUG. TRADE LIST / PKG
NAP1	71740	Contractor Nail Apron - Natural Canvas - 2 Pockets	1	\$ 6.25

★ ★ ★ ★ ★ *"Growth Through Innovation"* ★ ★ ★ ★ ★

Metallics

229 Cross Street, Bristol, CT 06010
Tel 800-243-8272 • **Fax** 800-831-9358
Email sales@metallicsonline.com

Metallics West

651 North Main Street, Mancos, CO 81328
Tel 800-269-5183 • **Fax** 800-269-6278
Email saleswest@metallicsonline.com

WE'VE GOT NAILS!



IN 2-1/2 POUND SQUARE JARS

*You don't have to make an extra trip to the Home Centers to get your supply of nails. "They're Here." at your **Metallics Distributor***



BRIGHT COMMON NAILS

STEEL

For all types of rough-in wood construction

STOCK NO.	UPC NO.	SIZE	WT. PER PKG.	APPROX COUNT	STD. PKG.	SUGGESTED TRADE LIST PRICE PER
MN8C	21226	8D	2.63	220	1 Jar	7.83/ea pkg
MN10C	21227	10D	2.63	140	1 Jar	7.83/ea pkg
MN16C	21228	16D	2.64	115	1 Jar	7.83/ea pkg



BRIGHT FINISH NAILS

STEEL

For interior and exterior wood finishes

STOCK NO.	UPC NO.	SIZE	WT. PER PKG.	APPROX COUNT	STD. PKG.	SUGGESTED TRADE LIST PRICE PER
MN4F	21229	4D	2.61	1350	1 Jar	9.50/ea pkg
MN6F	21230	6D	2.62	1390	1 Jar	8.63/ea pkg



HOT GALVANIZED BOX NAILS

STEEL

For exterior areas affected by water and humidity

STOCK NO.	UPC NO.	SIZE	WT. PER PKG.	APPROX COUNT	STD. PKG.	SUGGESTED TRADE LIST PRICE PER
MN6HG	21231	6D	2.62	450	1 Jar	10.13/ea pkg
MN8HG	21232	8D	2.63	290	1 Jar	10.13/ea pkg
MN10HG	21233	10D	2.66	190	1 Jar	9.93/ea pkg
MN16HG	21234	16D	2.64	135	1 Jar	10.13/ea pkg

OTHER SIZES AND QUANTITIES AVAILABLE UPON REQUEST

SPECIAL PURPOSE ELECTRICAL FASTENERS

Coating allows faster penetration



COATED SINKER NAILS

STEEL

For all types of rough-in wood construction

STOCK NO.	JAR UPC NO.	SIZE	WT. PER PKG.	APPROX COUNT	STD. PKG.	SUGGESTED TRADE LIST PRICE PER
MN8S	21235	8D	2.63	340	1 Jar	7.73/ea pkg
MN10S	21236	10D	2.57	240	1 Jar	8.15/ea pkg
MN16S	21237	16D	2.67	140	1 Jar	7.55/ea pkg
MN16S50B	21295	16D	50.00	2,600	50 lb Box	180.50/ea pkg NEW
MN16SP	21285	16D	10.00	520	10 lb Pail	40.93/ea pkg NEW

OTHER SIZES AND QUANTITIES AVAILABLE UPON REQUEST



BRIGHT DUPLEX NAILS

STEEL

For temporary wood structure/Double head allows for ease of extraction and disassembly

STOCK NO.	JAR UPC NO.	SIZE	WT. PER PKG.	APPROX COUNT	STD. PKG.	SUGGESTED TRADE LIST PRICE PER
MN8DP	21238	8D	2.61	200	1 Jar	8.73/ea pkg
MN16DP	21239	16D	2.63	105	1 Jar	8.73/ea pkg

OTHER SIZES AND QUANTITIES AVAILABLE UPON REQUEST



BRIGHT JOIST HANGER NAILS

STEEL

For all types of light brackets, straps in wood joists

STOCK NO.	JAR UPC NO.	SIZE	WT. PER PKG.	APPROX COUNT	STD. PKG.	SUGGESTED TRADE LIST PRICE PER
MN114J	21240	1-1/4" - 9 GA	2.59	360	1 Jar	8.58/ea pkg
MN112J	21241	1-1/2" - 9 GA	2.60	300	1 Jar	8.73/ea pkg

OTHER SIZES AND QUANTITIES AVAILABLE UPON REQUEST



HEAT TEMPERED FLUTED MASONRY NAILS

STEEL

Nails designed to penetrate concrete and other masonry products

STOCK NO.	JAR UPC NO.	SIZE	WT. PER PKG.	APPROX COUNT	STD. PKG.	SUGGESTED TRADE LIST PRICE PER
MN1TM	21242	1"	2.60	370	1 Jar	10.35/ea pkg
MN112TM	21243	1-1/2"	2.55	225	1 Jar	10.35/ea pkg
MN2TM	21244	2"	2.64	180	1 Jar	10.45/ea pkg
MN212TM	21245	2-1/2"	2.63	168	1 Jar	10.48/ea pkg
MN3TM	21246	3"	2.62	135	1 Jar	10.93/ea pkg

OTHER SIZES AND QUANTITIES AVAILABLE UPON REQUEST

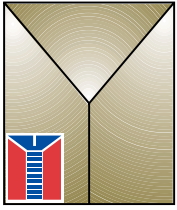

Metallics

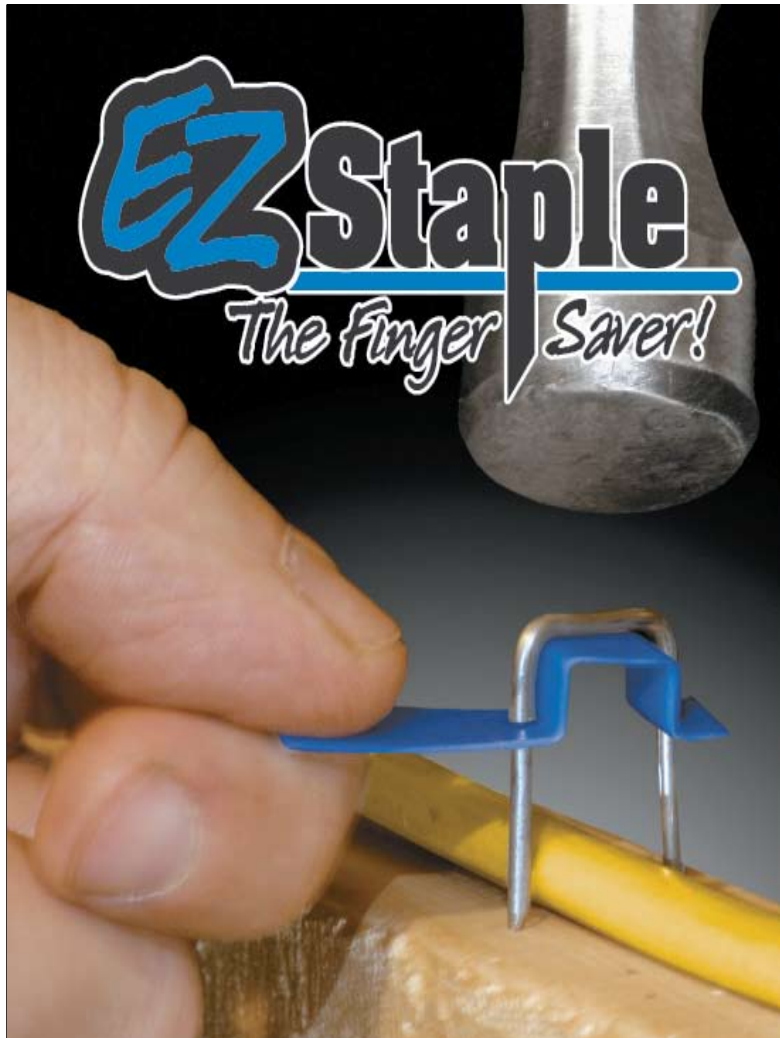

SAVES
Time,
Money,
and
FINGERS!

Easy to
handle, get
into tight
spaces
and reduce
drops!



EZSTPL1C



EXSTPL5C



EZSTPL2M



EZ- POUR LIDS!

Stock Number	UPC #	Description	WEIGHT PER PKG.	SUGGESTED TRADE LIST
EZSTPL1C	#85245	JAR OF 100 1/2"X1" STAPLES	.69 LBS.	12.05/c
EZSTPL5C	#85250	PAIL OF 500 1/2"X1" STAPLES	3.01 LBS.	58.18/ea. pkg.
EZSTPL2M	#85255	PAIL OF 2000 1/2"X1" STAPLES	12.21 LBS.	219.00/ea. pkg.

METALLICS EAST (800) 243-8272 OR METALLICS WEST (800) 269-5183

WWW.METALLICSONLINE.COM

SPECIAL PURPOSE ELECTRICAL FASTENERS



STACKING STAPLES

FOR GROUND - NON METALLIC CABLE
PACKAGED IN PLASTIC BAGS



STOCK NO.	UPC NO.	CABLE SIZE	WT. PER PKG.	STD. PKG.	SUGGESTED TRADE LIST PRICE PER
SCT6215	21755	For stacking two 2-wire #14 or #12 NM cable	.38	50	5.03/ea pkg
SCT6315	21760	For stacking three 2-wire or a 2-wire & 3-wire #14 or #12 NM cable	.42	50	5.85/ea pkg
SCT6415	21765	For stacking two 3-wire or four 2-wire #14 or #12 NM cable	.45	50	6.98/ea pkg



SERVICE ENTRANCE STAPLES

PACKAGED IN PLASTIC BAGS



STOCK NO.	UPC NO.	CABLE SIZE	WT. PER PKG.	STD. PKG.	SUGGESTED TRADE LIST PRICE PER
SES4115	21770	#6 type SER (gray)	.63	50	16.98/ea pkg
SES4215	21771	#6 type SEU (gray)	.60	50	16.98/ea pkg
SES4312	21775	#2 type SER (gray)	.45	25	10.40/ea pkg
SES4412	21776	#2 type SEU (gray)	.33	25	9.63/ea pkg
SES4512	21781	4/0 type SEU (gray)	.51	25	14.28/ea pkg
SES4612	21780	4/0 type SER (gray)	.67	25	14.28/ea pkg



PLASTIC CABLE STAPLES

SECURES NON-METALLIC CABLE
PACKAGED IN PLASTIC BAGS



STOCK NO.	UPC NO.	CABLE SIZE	WT. PER PKG.	STD. PKG.	SUGGESTED TRADE LIST PRICE PER
PCS125	21790	2 & 3 wire NM cable up to #12 2-wire UF cable up to #12 & other cable up to 1/2" wide	.45	100	5.55/c
PCS345	21795	2-wire NM & UF cable up to #8 3-wire UF Cable up to #12 & other cable up to 3/4" wide	.47	100	6.10/c



CO-AXIAL STAPLES

SECURES CO-AXIAL CABLE & OTHER
NON-METALLIC CABLE UP TO 1/4" WIDE
PACKAGED IN PLASTIC BAGS



STOCK NO.	UPC NO.	CABLE SIZE	WT. PER PKG.	STD. PKG.	SUGGESTED TRADE LIST PRICE PER
CAS5051	21800	1/4" wide	.21	100	4.88/c

SPECIAL PURPOSE ELECTRICAL FASTENERS



SMALL WIRE STAPLES

SECURES THERMOSTAT, TELEPHONE AND BELL WIRE
NON-METALLIC CABLE UP TO 1/4" WIDE
PACKAGED IN PLASTIC BAGS



STOCK NO.	UPC NO.	CABLE SIZE	WT. PER PKG.	STD. PKG.	SUGGESTED TRADE LIST PRICE PER
SPS5151	21810	1/4" x 1/8"	.20	100	4.88/c



PVC CONDUIT STRAP

FOR NON-METALLIC PVC ELECTRICAL CONDUIT
PACKAGED IN PLASTIC BAGS



STOCK NO.	UPC NO.	CONDUIT SIZE	WT. PER PKG.	STD. PKG.	SUGGESTED TRADE LIST PRICE PER
PCS212	21815	Gray 1/2"	.66	100	17.68/ea pkg
PCS234	21816	Gray 3/4"	.80	100	20.83/ea pkg
PCS244	21817	Gray 1"	1.05	100	29.10/ea pkg
PCS254	21818	Gray 1 1/4"	.75	50	16.98/ea pkg
PCS264	21819	Gray 1 1/2"	.95	50	18.55/ea pkg
PCS274	21821	Gray 2"	1.40	50	24.25/ea pkg
PCS284	21823	Gray 2 1/2"	.29	5	4.88/ea pkg
PCS294	21825	Gray 3"	.34	5	6.65/ea pkg
PCS204	21829	Gray 4"	.44	5	12.88/ea pkg



CONDUIT LOCK NUTS

STEEL ZINC PLATED

STOCK NO.	UPC NO.	CONUIT SIZE	WT. PER PKG.	STD. PKG.	SUGGESTED TRADE LIST PRICE PER
SFLN50	13575	1/2"	.92	100	11.20/ea pkg
SFLN75	13576	3/4"	1.65	100	15.33/ea pkg
SFLN100	13577	1"	2.80	100	22.65/ea pkg
SFLN125	13578	1 1/4"	2.01	50	15.90/ea pkg
SFLN150	13579	1 1/2"	2.49	50	18.90/ea pkg
SFLN200	13581	2"	2.90	50	25.73/ea pkg
SFLN250	13583	2 1/2"	3.05	25	35.70/ea pkg
SFLN300	13585	3"	4.35	25	45.98/ea pkg
SFLN400	13589	4"	1.49	20	210.31/ea pkg NEW

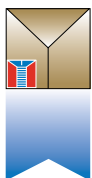

AMERICA'S SOURCE FOR PREMIER AND INNOVATIVE
FASTENERS & ANCHORS

SPECIAL PURPOSE ELECTRICAL FASTENERS

C = 100 PCS PER BOX
 F = 500 PCS PER JAR
 P = 5,000 PCS PER PAIL

NON-INSULATED CABLE STAPLES



EXAMPLE: CST40 = 100 PCS FST40 = 500 PCS PST40 = 5,000 PCS

STOCK NO.	UPC NO.	QTY. PER CONTAINER	USE	SIZE	WT. PER PKG.	SUGGESTED TRADE LIST PRICE PER
 CST40	21000	100/Box	N.M.C. 2 Romex	1 L x 1/2 W	.65	2.90/c
FST40	21005	500/Jar	#12 & #14		2.89	13.45/ea pkg
PST40	21007	5000/Pail			26.95	127.58/ea pkg

 CST100	21010	100/Box	N.M.C. & Armored	1 1/4 L x 9/16 W RX & BX	.59	3.28/c
FST100	21015	500/Jar	#14, #12, #10 w/gr		2.96	14.95/ea pkg
PST100	21017	5000/Pail			35.90	142.65/ea pkg

N.M.C. - to be used on non-metallic cable

 CST300	21020	100/Box	Service Entrance SEU3 #6	1 5/16 L x 3/4 W Full 10 Ga. Wire	1.18	6.05/c
FST300	21022	500/Jar			6.20	27.18/ea pkg

 CST350	21025	100/Box	Service Entrance SEU2 #6	1 1/2 L x 1 1/16 W For 2 #3 Full 10 Ga. Wire	1.31	7.55/c
FST350	21027	500/Jar			6.41	33.90/ea pkg

JAR PACKAGING AVAILABLE
 OTHER QUANTITIES AVAILABLE BY REQUEST



INSULATED CABLE STAPLES

HOT MELT PVC BONDED
 FOR BETTER CABLE PROTECTION!



STOCK NO.	UPC NO.	QTY. PER CONTAINER	USE	SIZE LENGTH X WIDTH	WT. PER PKG.	SUGGESTED TRADE LIST PRICE PER
CST40I	21030	100/Box	#12, #14 Wire	1" x 1/2"	.59	4.55/c
CST100I	21018	100/Box	#10, #12, #14 Wire	1 1/4" x 9/16"	.71	4.43/c
CST350P	21093	2000/Pail	#10, #12, #14 Wire	1 1/4" x 9/16"	27.25	143.70/ea pkg NEW
CST100P	29006	1500/Pail	#10, #12, #14 Wire	1 1/4" x 9/16"	13.35	82.25/ea pkg NEW
FST100I	21019	250/Jar	#10, #12, #14 Wire	1 1/4" x 9/16"	2.20	10.85/ea pkg
PST100I	21021	5000/Pail	#10, #12, #14 Wire	1 1/4" x 9/16"	37.00	203.10/ea pkg
FST40I	21035	500/Jar	#10, #12, #14 Wire	1" x 1/2"	2.74	23.75/ea pkg NEW
PST40I	21040	5000/Pail	#10, #12, #14 Wire	1" x 1/2"	28.98	184.65/ea pkg NEW

JAR PACKAGING AVAILABLE
 OTHER QUANTITIES AVAILABLE BY REQUEST

Metallics East 1-800-243-8272

Metallics West 1-800-269-5183

SPECIAL PURPOSE ELECTRICAL FASTENERS

RAFTER AND TRUSS STAPLES

MADE IN USA



- SAVE TIME AND FRUSTRATION BY FASTENING CABLE FROM THE FRONT OF THE RAFTERS AND TRUSSES
- INCREASE PRODUCTIVITY
- MADE FOR HARD TO REACH PLACES SUCH AS RAFTERS AND FLOOR JOISTS
- ELIMINATES DAMAGE TO WIRE JACKET
- REDUCES BENT OVER NAILS

STOCK NO.	UPC NO.	SIZE	DESCRIPTION	PKG. QTY	WT. PER PKG.	SUGGESTED TRADE LIST PRICE PER
RJS1	21910	1/2	Rafter-Joist Staple	100	1.14	9.85/c
RJS2	21912	1/2	Rafter-Joist Staple	500	6.55	38.58/ea pkg

WHITE INSULATED TWO NAIL STAPLES

MADE IN USA



STOCK NO.	UPC NO.	SIZE	DESCRIPTION	PKG. QTY	WT. PER PKG.	SUGGESTED TRADE LIST PRICE PER
CS50	21914	1/2	Plastic Staple	100	.45	8.75/c
CS50P	21916	1/2	Plastic Staple	2000	9.98	115.93/ea pkg
CS75	21918	3/4	Plastic Staple	100	.50	8.88/c
CS75P	21920	3/4	Plastic Staple	1500	8.05	96.40/ea pkg
1/2 secures 14-2 or 12-2 with ground non-metallic cable and other non-metallic cable 1/2" wide						
3/4 secures 12-3 or 10-3 with ground non-metallic cable and other non-metallic cable 3/4" wide						

BLACK INSULATED TWO NAIL STAPLES

MADE IN USA



STOCK NO.	UPC NO.	SIZE	DESCRIPTION	PKG. QTY	WT. PER PKG.	SUGGESTED TRADE LIST PRICE PER
CCS50	21926	1/2	Plastic Staple	100	.44	6.70/c
CCS50P	21928	1/2	Plastic Staple	2000	9.81	87.73/ea pkg
CCS75	21930	3/4	Plastic Staple	100	.50	7.43/c
CCS75P	21932	3/4	Plastic Staple	1500	8.50	77.58/ea pkg
1/2 secures 14-2 or 12-2 with ground non-metallic cable and other non-metallic cable 1/2" wide						
3/4 secures 12-3 or 10-3 with ground non-metallic cable and other non-metallic cable 3/4" wide						

DATA COMM. STAPLES 0.190 DIAMETER

MADE IN USA



FOR CATEGORY 5 (4 PAIR 24 GAUGE CABLE)

STOCK NO.	UPC NO.	SIZE	DESCRIPTION	PKG. QTY	WT. PER PKG.	SUGGESTED TRADE LIST PRICE PER
DCS1	21938	0.190	Plastic Data Com. Staple	100	.23	8.05/c
DCS1B	21940	0.190	Plastic Data Com. Staple	500	1.15	31.58/ea pkg

SPECIAL PURPOSE ELECTRICAL FASTENERS

INSULATED STAPLES

FOR LOW VOLTAGE WIRING
Conforms to U.S. Government Specifications

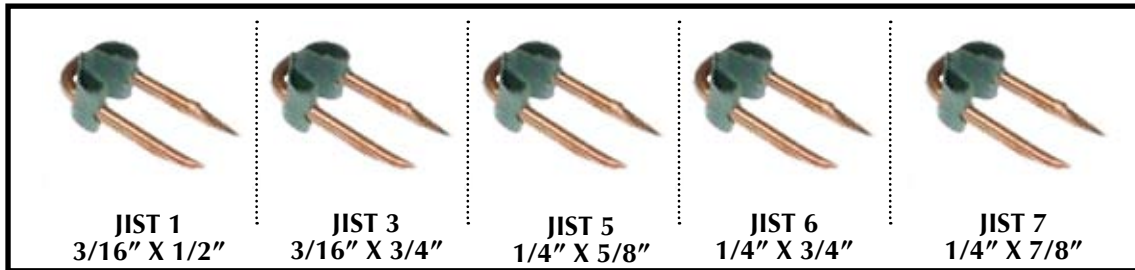

STOCK NO.	UPC NO.	SIZE	WIDTH	LENGTH OF LEGS	WT. PER PKG.	STD. PKG./MSTR. CARTON	SUGGESTED TRADE LIST PRICE PER
JIST1	81016	#1	3/16	1/2	.19	100/500	3.00/c
JIST3	81017	#3	3/16	3/4	.24	100/500	3.00/c
JIST5	81018	#5	1/4	5/8	.22	100/500	3.73/c
JIST6	81019	#6	1/4	3/4	.24	100/500	3.28/c
JIST7	81020	#7	1/4	7/8	.25	100/500	4.33/c

OTHER QUANTITIES AVAILABLE UPON REQUEST

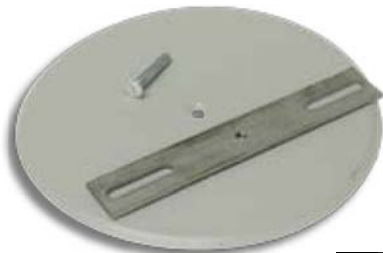

PACKAGED 10 IN POLY BAG

CEILING COVER PLATE ADJUSTABLE



ADJUSTS TO FIT 3" OR 4" OUTLET BOXES
Includes plate, strap and flat head slotted machine screw.
White color to suit most applications.

STOCK NO.	UPC NO.	DESCRIPTION	WEIGHT	STD. PKG.	SUGGESTED TRADE LIST PRICE PER
CP1A	41300	Fits 3" & 4" boxes. 5 1/4 steel canopy with adjustable strap and screws	.12	10	38.93/ea pkg



PACKAGED 10 IN POLY BAG

CEILING COVER PLATE STANDARD



ATTACHES DIRECTLY TO CEILING OUTLET BOXES
Holes predrilled. Flat head slotted machine screws included.
White color to suit most applications.

STOCK NO.	UPC NO.	DESCRIPTION	WEIGHT	STD. PKG.	SUGGESTED TRADE LIST PRICE PER
CP3S	41305	5 1/4 white canopy fits 3" boxes	.18	10	31.90/ea pkg
CP4S	41310	5 1/4 white canopy fits 4" boxes	.15	10	31.90/ea pkg

STAPLE GUNS AND STAPLES



Metallic

INTRODUCING...



STAPLES SOLD SEPARATELY

T-72

MT-72 STAPLE GUN

Professional wire & cable staple gun. Shoots large UL listed & C-UL listed insulated staples for non metallic sheathed cable, 12/2, 14/2 and other wire up to 1/2". Wire guide for proper fit. All steel construction and patented jam proof mechanism.

M721168 STAPLE - 13/64" x 31/64" Insulated Staple - 300 Staples per Package
M721189 STAPLE - 11/32" x 19/32" Insulated Staple - 300 Staples per Package

STOCK NO.	UPC NO.	WEIGHT	SUGGESTED TRADE LIST PRICE PER
MT72	23672	2.50 lbs.	107.55/ea.
M721168	23676	.55 lbs.	21.90/ea.
M721189	23680	.58 lbs.	21.90/ea.



STAPLES SOLD SEPARATELY

T-59

MT-59 STAPLE GUN

Wiring Tacker for UL listed & C-UL listed insulated staples. Ideal for installing RG6 and RG6 Quad shield TV/Cable/Computer wire up to 5/16" wide. Steel construction grooved guide. Patented jam proof mechanism.

M591189 STAPLE - 5/16" x 5/16" Clear Insulated - 300 Staples per Package
M591189BL STAPLE - 5/16" x 5/16" Black Insulated - 300 Staples per Package

STOCK NO.	UPC NO.	WEIGHT	SUGGESTED TRADE LIST PRICE PER
MT59	23659	2.08 lbs.	100.55/ea.
M591189	23665	.28 lbs.	16.43/ea.
M591189BL	23670	.28 lbs.	16.43/ea.



STAPLES SOLD SEPARATELY

T-25

MT-25 STAPLE GUN

Low voltage wire staple gun. Fits wire up to 1/4". Built in grooved guide to prevent wire damage. All steel construction. Patented jam proof mechanism.

M256 STAPLE - 1/4" x 3/8" Non-Insulated Staple - 1,000 Staples per Package
M257 STAPLE - 1/4" x 7/16" Non-Insulated Staple - 1,000 Staples per Package
M259 STAPLE - 1/4" x 9/16" Non-Insulated Staple - 1,000 Staples per Package

STOCK NO.	UPC NO.	WEIGHT	SUGGESTED TRADE LIST PRICE PER
MT25	23625	2.08 lbs.	87.98/ea.
M256	23630	.29 lbs.	5.25/ea.
M257	23635	.34 lbs.	5.25/ea.
M259	23640	.40 lbs.	5.50/ea.



Metallics WIRE TACKERS

Arrow® Model T75™ Wire & Cable Stapler
Uses T75™ Staples

5/8" (16mm)
7/8" (22mm)

NEW!



*Another NEW
exciting solution
from Metallics!
Tired of searching
for the right
Wire & Cable
Stapler...
Here it is!*

- Durable Chrome Finish
- All-Steel Construction
- Cushioned Grip
- Grooved Guide
- Grooved Driving Blade
- Chrome Finish Resists Wear and Tear
- Patented Jam-Proof Mechanism
- Easy Squeeze Double Leverage Operation
- For wires up to 1/2" (12mm)
- NM Sheathed Cable up to #12 3-Wire
- CATV
- Communications
- Alarm Systems
- Electronics



7510S, 7514S Staples



Stock Number	UPC#	Description	Quantity Per Pkg.	Suggested Trade List Per Pkg.
MT75	23675	Wire & Cable Staple Gun	1	\$84.88/ea.
M7510S	23693	5/8 Staple UL Listed	1000	\$22.10/pkg.
M7510	23590	5/8 Staple Not UL Listed	1000	\$16.40/pkg.
M7514S	23687	7/8 Staple UL Listed	1000	\$17.80/pkg.
M7514	23594	7/8 Staple Not UL Listed	1000	\$18.05/pkg.

Metallics

229 Cross Street,
Bristol, Ct. 06010
Tel: 800-243-8272
Fax: 800-831-9358
Email: sales@metallicsonline.com

"Growth Through Innovation"

Metallics West

651 North Main Street
Mancos, Co. 81328
Tel: 800-269-5183
Fax: 800-269-6278
Email: saleswest@metallicsonline.com



Metallics

ISOMAX®

Impact Driver Kit
with Plastic Handle
11pc.



- Perfect for Removing Tight, or Stuck Screws!
- Includes Comfortable Impact Absorbing Hand-Grip with Hand Guard
- Comes with Bit Holder, 9 Tips and Sturdy Molded Plastic Storage Case.



Stock Number	UPC#	Description	Weight Per Pkg.	Suggested Trade List
IBTK11	32771	11 pc. Impact Driver Kit with Plastic Handle	2.3 lbs.	\$47.20ea.



Tee*Star® is Registered Trademark of Eazypower Corporation.
Phillips® is a Registered Trademark of The Phillips® Screw Company.

**Impact Driver Kit
with Plastic Handle
11pc.**

Metallics
229 Cross Street,
Bristol, Ct. 06010
Tel: 800-243-8272
Fax: 800-831-9358
Email: sales@metallicsonline.com

"Growth Through Innovation"

Metallics West
651 North Main Street
Mancos, Co. 81328
Tel: 800-269-5183
Fax: 800-269-6278
Email: saleswest@metallicsonline.com

www.metallicsonline.com • TIP TYPES – SEE BACK FOR AVAILABLE SIZES.



Metallics

ISOMAX®

Impact Driver





Bit Kit

13pc.



*Another NEW
exciting solution
from Metallics!
Tired of searching
for the right bit...*

*Here it is!
The 13pc. Impact
Driver Bit Kit.*

Stock Number	UPC#	Description	Weight Per Pkg.	Suggested Trade List
IBTK13	32773	13 pc. Impact Driver Bit Kit	.42 lbs.	\$45.17ea.
Socket Adapter	Phillips®	Slotted	Hex Key	Tee*Star®
				
<small>Tee*Star® is Registered Trademark of Eazypower Corporation. Phillips® is a Registered Trademark of The Phillips® Screw Company.</small>				

**Impact Driver
Bit Kit 13pc.**

Metallics
229 Cross Street,
Bristol, Ct. 06010
Tel: 800-243-8272
Fax: 800-831-9358
Email: sales@metallicsonline.com

"Growth Through Innovation"

Metallics West
651 North Main Street
Mancos, Co. 81328
Tel: 800-269-5183
Fax: 800-269-6278
Email: saleswest@metallicsonline.com

www.metallicsonline.com • TIP TYPES – SEE BACK FOR AVAILABLE SIZES.

TOOLS, DRILLS AND ACCESSORIES

15 IN ONE RACHET SCREWDRIVER

Handle Contains 1 each of bits listed below



STOCK NO.	UPC NO.	DESCRIPTION	QTY	WT. PER PKG.	SUGGESTED TRADE LIST PRICE PER
SD15B	35025	Screwdriver	1	.50	52.23/ea
15-1 REPLACEMENT BITS (PKG. 6 BITS PER PKG.)					
SDR1B	35028	1/8" Slotted x #0 Phillips	6	.50	31.58/ea pkg
SDR2B	35030	1/4" x 3/16" Slotted	6	.50	31.58/ea pkg
SDR3B	35032	1/4" Slotted x #2 Phillips	6	.50	31.58/ea pkg
SDR4B	35034	5/32" Slotted x #3 Phillips	6	.50	31.58/ea pkg
SDR5B	35036	#1 x #2 Phillips	6	.50	31.58/ea pkg
SDR6B	35038	T15 x T20 Torx Compatible	6	.50	38.28/ea pkg
SDR7B	35040	S1 x S2 Square	6	.50	38.28/ea pkg



25' PRO TAPE MEASURE

Cushion Grip Provides Non-slip Grip and Helps Protect Tape
Quick release and locking button
Tape 7/8" wide for extra strength

STOCK NO.	UPC NO.	DESCRIPTION	QTY	WT. PER PKG.	SUGGESTED TRADE LIST PRICE PER
MPT1	31304	Tape Measure	1	.79	38.50/ea

LUTZ® IS A REGISTERED TRADEMARK

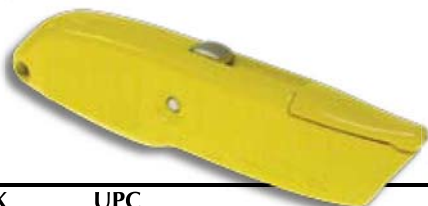

UTILITY KNIFE

Heavy Duty • Xtra Blades in handle • Retractable Blade

STOCK NO.	UPC NO.	DESCRIPTION	QTY	WT. PER PKG.	SUGGESTED TRADE LIST PRICE PER
MUK1	31308	Utility Knife	1	.60	18.65/ea

FOUR-WAY SCREWDRIVER

Convenience of 4 Screwdrivers in One!



- Reversible Shaft
- Heavy Duty Black Plastic Handle with Gold Imprint

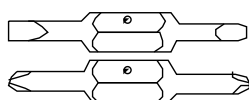

SD4W1

Includes:
3/16 & 9/32 Slotted bit
#1 & #2 Phillips bit

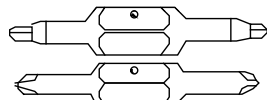

SD4W2

Includes:
#1 & #2 Square bit
#1 & #2 Phillips bit

Attractive counter display included with 12 or more!

SPECIAL ORDER

PRIVATE LABELING AVAILABLE
with purchases of 72 or more drivers
(Specify handle color: Red, Black, Light Blue, Dark Blue, Yellow, Green)

STOCK NO.	UPC NO.	DESCRIPTION	WT. EACH	STD. PKG.	SUGGESTED TRADE LIST PRICE PER
SD4W1	35001	4-way Phillips and Slotted Points	.32	1	16.30/ea
SD4W2	35002	4-way Phillips and Square Points	.31	1	16.30/ea

TOOLS, DRILLS AND ACCESSORIES

SIX-WAY SCREWDRIVER

Same great features as our 4-Way Screwdriver **PLUS** a hardened steel tube for use as a 1/4" or 5/16" hex nut driver!

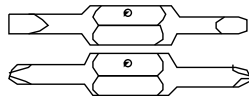
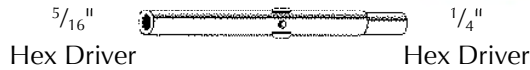

SD6W1

Includes:
3/16 & 9/32 Slotted bit
#1 & #2 Phillips bit

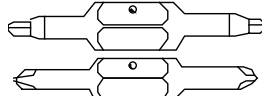

SD6W2

Includes:
#1 & #2 Square bit
#1 & #2 Phillips bit

- Reversible Steel Shaft with Hex Drivers
- Heavy Duty Black Plastic Handle with Gold Imprint

Attractive counter display included with 12 or more!

SPECIAL ORDER

PRIVATE LABELING AVAILABLE

with purchases of 72 or more drivers
(Specify handle color: Red, Black, Light Blue, Dark Blue, Yellow, Green)

STOCK NO.	UPC NO.	DESCRIPTION	WT EACH	STD. PKG.	SUGGESTED TRADE LIST PRICE PER
SD6W1	35010	6-way Phillips and Slotted Points	.35	1	19.95/ea
SD6W2	35011	6-way Phillips and Square Points	.35	1	19.95/ea



THREE-IN-ONE TAP THREAD CLEANING TOOL

STOCK NO.	UPC NO.	DESCRIPTION	WT. EACH	STD. PKG.	SUGGESTED TRADE LIST PRICE PER
681032	16345	6-32,8-32,10-32 Thread Cleaning Tool	.34	1	29.00/ea



MAGNETIC BIT AND NUT SETTER KIT

- Three sizes of Nut Setters and one size Bit Holders
- Magnetized for ease of use
- Be professional, be prepared





















STOCK NO.	UPC NO.	DESCRIPTION	SIZE	QTY	WT. EACH	STD. PKG.	SUGGESTED TRADE LIST PRICE PER
MTKQ	10890	Mag. Hex Bit Holder	1/4 x 2"	2	.8	1	76.30/ea
		Mag Nut Setter	1/4 x 2"	2			
		Mag. Nut Setter	5/16 x 2"	2			
		Mag. Nut Setter	3/8 x 2"	2			

TOOLS, DRILLS AND ACCESSORIES

POWER BITS AND HOLDERS PROFESSIONAL POWER TOOL ACCESSORY VISUAL PACKAGES

ALL BITS "XTRA-HARD"







STOCK NO.	UPC NO.	DESCRIPTION	LENGTH	QTY PER PKG.	WT. PER PKG.	SUGGESTED TRADE LIST PRICE PER
000P1X	25070	#1 Phillips Insert Bit	 1"	10	.18	12.08/ea pkg
000P2X	25074	#2 Phillips Insert Bit	 1"	10	.19	12.08/ea pkg
000P3X	25080	#3 Phillips Insert Bit	 1"	10	.19	12.08/ea pkg
000R2X	25055	#2 Square Drive Insert Bit	 1"	10	.19	14.40/ea pkg
0016X	25235	6-8 Slotted Insert Bit	 1"	10	.19	19.58/ea pkg
0018X	25240	8-10 Slotted Insert Bit	 1"	10	.19	19.58/ea pkg
00110X	25245	10-12 Slotted Insert Bit	 1"	10	.19	19.58/ea pkg
100P1X	25300	#1 Phillips Power Bit	 1 ¹⁵ / ₁₆ "	5	.19	14.20/ea pkg
100P2X	25305	#2 Phillips Power Bit	 1 ¹⁵ / ₁₆ "	5	.19	14.20/ea pkg
100P3X	25312	#3 Phillips Power Bit	 2"	5	.20	14.58/ea pkg
1008X	25415	8-10 Slotted Power Bit	 1 ¹⁵ / ₁₆ "	5	.21	22.53/ea pkg
10010X	25314	10-12 Slotted Power Bit	 1 ¹⁵ / ₁₆ "	5	.21	24.40/ea pkg
P2P2	25510	#2 Phillips Dbl Ended Bit	 1 ³ / ₄ "	2	.11	13.50/ea pkg
P2S8	25505	#2 Phillips Slotted Dbl End	 1 ¹ / ₂ "	2	.18	8.73/ea pkg
MAGNETIZED						
MT208	10870	1/4" Drill Chuck Nut Setter	 1 ⁵ / ₈ "	2	.15	14.78/ea pkg
MT208L	10875	1/4" Drill Chuck Long Nut Setter	 2 ⁹ / ₁₆ "	2	.20	17.88/ea pkg
MT210	10871	5/16" Drill Chuck Nut Setter	 1 ⁵ / ₈ "	2	.17	17.88/ea pkg
MT210L	10876	5/16" Drill Chuck Long Nut Setter	 2 ⁹ / ₁₆ "	2	.22	19.83/ea pkg
MT212	10872	3/8" Drill Chuck Nut Setter	 1 ⁷ / ₈ "	2	.18	19.63/ea pkg
MT212L	10877	3/8" Drill Chuck Long Nut Setter	 2 ⁹ / ₁₆ "	2	.25	22.93/ea pkg
M10	25250	Hex Insert Bit Holder	 2 ⁷ / ₈ "	1	.16	19.65/ea pkg

TOOLS, DRILLS AND ACCESSORIES

BULK PACKAGED 1/4" HEX SHANK SCREWDRIVER POWER BITS AND HOLDERS

ORDER JUST WHAT YOU NEED

	STOCK NO.	UPC NO.	SCREW SIZE	POINT SIZE	OVERALL LENGTH	WT. EACH	SUGGESTED TRADE LIST PRICE PER	
PHILLIPS INSERT & POWER BITS 	000P1B	25071	4-6	#1	1"	.01	1.10/ea	
	000P2B	25076	8-10	#2	1"	.01	1.10/ea	
	000P3B	25081	12-14	#3	1"	.01	1.10/ea	
	001P2B	25085	8-10	#2	1 1/4"	.02	2.35/ea	
	100P1B	25301	4-6	#1	2"	.02	2.53/ea	
	100P2B	25306	8-10	#2	2"	.02	2.53/ea	
	100P3B	25310	12-14	#3	2"	.02	2.30/ea	
	125P1B	25315	4-6	#1	3"	.02	2.98/ea	
	125P2B	25320	8-10	#2	3"	.04	3.33/ea	
	125P3B	25325	12-14	#3	3"	.03	3.78/ea	
	140P1B	25345	4-6	#1	4"	.04	4.20/ea	
	140P2B	25350	8-10	#2	4"	.05	4.20/ea	
	140P3B	25355	12-14	#3	4"	.05	4.20/ea	
	SLOTTED INSERT & POWER BITS 	0014B	25225	4-5	4-5	1"	.01	1.78/ea
0016B		25236	6-8	6-8	1"	.01	1.78/ea	
0018B		25241	8-10	8-10	1"	.01	1.78/ea	
00110B		25206	10-12	10-12	1"	.01	1.78/ea	
0006B		25195	6-8	6-8	1 1/2"	.02	2.30/ea	
0008B		25200	8-10	8-10	1 1/2"	.03	2.30/ea	
00010B		25205	10-12	10-12	1 1/2"	.03	2.30/ea	
1004B		25400	4-5	4-5	2"	.02	3.75/ea	
1006B		25410	6-8	6-8	2"	.03	3.75/ea	
1008B		25416	8-10	8-10	2"	.03	4.20/ea	
10010B		25420	10-12	10-12	2"	.03	4.50/ea	
1256B		25440	6-8	6-8	3"	.04	5.30/ea	
1258B		25445	8-10	8-10	3"	.04	5.70/ea	
12510B		25450	10-12	10-12	3"	.05	7.85/ea	
SQUARE DRIVE INSERT BITS 		000R1B	25050	4-6	#1	1"	.01	1.33/ea
		000R2B	25056	8-10	#2	1"	.01	1.33/ea
	000R3B	25060	12-14	#3	1"	.01	1.33/ea	
	100R1B	25065	4-6	#1	2"	.01	2.60/ea	
	100R2B	25072	8-10	#2	2"	.02	2.60/ea	
	100R3B	25075	12-14	#3	2"	.02	2.60/ea	
	125R1B	10149	4-6	#1	3"	.03	4.55/ea	
	125R2B	10166	8-10	#2	3"	.04	4.55/ea	
	125R3B	10167	12-14	#3	3"	.04	4.55/ea	
	140R1B	10176	4-6	#1	4"	.04	6.53/ea	
	140R2B	10177	8-10	#2	4"	.05	7.28/ea	
	140R3B	10180	12-14	#3	4"	.05	7.28/ea	
	160R2B	25352	8-10	#2	6"	.07	8.68/ea	
	160R3B	25357	12-14	#3	6"	.07	8.68/ea	
	180R2B	10193	8-10	#2	8"	.11	9.35/ea	
	110R2B	10175	8-10	#2	10"	.12	10.45/ea	
	DOUBLE ENDED INSERT BITS 	P2P2B	10178	#2 Phil/#2 Phil		1 3/4"	.02	6.18/ea
P2S8B		10179	#2 Phil/8-10 Slot		1 3/4"	.02	3.13/ea	
00SP6B		25027		#6	1"	.01	5.03/ea	
00SP8B		10195		#8	1"	.01	5.03/ea	
00SP10B		10196		#10	1"	.04	5.03/ea	
BIT HOLDER & NUT SETTERS 	M1B	25260	1/4" Mag Bit Hldr		1 3/4"	.04	15.05/ea	
	M10B	25255	1/4" Mag Bit Hldr		2 7/8"	.08	17.70/ea	
	MT208B	10183	1/4" Mag Nut Setter		1 5/8"	.04	6.70/ea	
	MT208LB	10186	1/4" Mag Nut Setter		2 9/16"	.06	8.10/ea	
	MT210B	10184	5/16" Mag Nut Setter		1 5/8"	.05	7.53/ea	
	MT210LB	10187	5/16" Mag Nut Setter		2 9/16"	.07	9.00/ea	
	MT212B	10185	3/8" Mag Nut Setter		1 5/8"	.05	9.33/ea	
	MT212LB	10188	3/8" Mag Nut Setter		2 9/16"	.08	10.63/ea	

LONGER SIZES AVAILABLE!

SELECT-A-BIT KIT

10 Piece Kit

The Right Drive When You Need It!

KIT INCLUDES:

- 4 - Phillips Drive Bits
- 3 - Slotted Drive Bits
- 2 - Square Drive Bits
- 1 - Magnetic Holder for Power Driving.

Insert the Magnetic Holder into the star hole at the top of the bit case, and it becomes a screwdriver handle.



STOCK NO.	UPC NO.	STD. PKG.	WEIGHT EACH	SUGGESTED TRADE LIST PRICE PER
SAB10	28010	1 Kit	.24	29.88/ea

REPLACEMENT COMPONENTS FOR KIT

QUANTITY	DESCRIPTION	REPLACEMENT PART #
1	Bit Holder	M10B
1	#6 Slotted Bit	0016B
1	#8 Slotted Bit	0018B
1	#10 Slotted Bit	00110B
1	#1 Phillips Bit	000P1B
2	#2 Phillips Bit	000P2B
1	#3 Phillips Bit	000P3B
1	#2 Square Drive Bit	000R2B
1	#3 Square Drive Bit	000R3B

For PVC Plastic

CABLE SAW

FOR ALL PVC PIPE

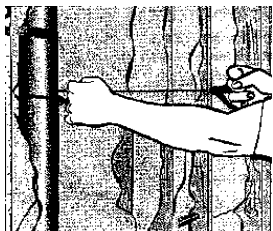

Between Joists

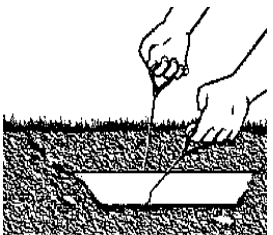

Buried

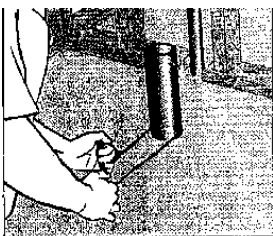

Closet Flanges and Floor

DIRECTIONS:

1. Secure PVC pipe for cutting. Loop cable around pipe at the location you wish to cut.
2. Apply pressure, while making short back and forth strokes to establish a starting cut or pilot groove in the pipe.
3. Using the middle third of the cable, make longer strokes to completely cut through PVC pipe.

- A WIRE CABLE SAW WITH VINYL COVERED HANDLES.
- SUITABLE FOR CUTTING PVC PLASTIC PIPE.



STOCK NO.	UPC NO.	DESCRIPTION	WT. PER PKG.	STD. PKG.	SUGGESTED TRADE LIST PRICE PER
MCS26	71616	26" Cable Saw	0.07	1	18.68/ea
MCS46	71617	46" Cable Saw	0.07	1	20.68/ea



Metallics

SHARPIE®

Sharpie® fine point permanent marker perfect for marking labels, plastic or corrugated. Permanent ink smear proof, heat and water resistant. In either black or yellow ink.



Another NEW exciting solution from Metallics! Tired of searching for the right permanent marker...

Here they are!

Stock Number	UPC#	Description	Quantity Per Pkg.	Suggested Trade List Per Pkg.
30001	13721	Sharpie fine point permanent marker black ink	12	\$39.00
30005	13755	Sharpie fine point permanent marker yellow ink	12	\$39.96

Metallics

229 Cross Street,
Bristol, Ct. 06010
Tel: 800-243-8272
Fax: 800-831-9358
Email: sales@metallicsonline.com

"Growth Through Innovation"

Metallics West

651 North Main Street
Mancos, Co. 81328
Tel: 800-269-5183
Fax: 800-269-6278
Email: saleswest@metallicsonline.com



Metallics

SHARPIE®



King Size permanent marker.
Designed for the toughest marking jobs.
Features a long lasting felt chisel tip
with high performance ink.

Retractable fine tip marker. Quick drying
and water resistant ink. AP certified nontoxic.

Mini with lanyard. Quick-drying nontoxic ink.
Permanent on most surfaces.



Another **NEW**
exciting solution
from Metallics!
Tired of searching
for the right
permanent
marker...
Here they are!

Part Number	UPC#	Description	Quantity Per Pkg.	Suggested Trade List Per Pkg.
M15001	13781	Sharpie King Size Black Marker	12	\$64.95
32701	13785	Sharpie Retractable Fine Tip Black Marker	1	\$10.45
35049	13759	Sharpie Mini with Lanyard Black Marker	1	\$11.75

Metallics

229 Cross Street,
Bristol, Ct. 06010
Tel: 800-243-8272
Fax: 800-831-9358
Email: sales@metallicsonline.com

"Growth Through Innovation"

Metallics West

651 North Main Street
Mancos, Co. 81328
Tel: 800-269-5183
Fax: 800-269-6278
Email: saleswest@metallicsonline.com

TOOLS, DRILLS AND ACCESSORIES



MARKING CRAYONS

Weather resistant, fade resistant, lead free. For use on lumber (rough or smooth), cardboard, concrete, metal, paper, plastic and other surfaces. Each crayon 4-1/2" x 1/2".

STOCK NO.	UPC NO.	COLOR	WT. PER PKG.	STD. PKG.	SUGGESTED TRADE LIST PRICE PER
LCB12	72600	Blue	.75	12	23.40/ea pkg
LCBLK12	72602	Black	.56	12	23.40/ea pkg
LCY12	72603	Yellow	.64	12	23.40/ea pkg
LCR12	72604	Red	.74	12	23.40/ea pkg

CRAYON HOLDER



- Walnut holder fits both round or hexagonal marking crayons 1/2" in diameter.
- Walnut handle, metal chuck, hole for wrist strap.
- Aluminum holder is spring loaded and can be used with extension handle.
- Designed to hold Lumber Crayons and High Heat Metal Crayons 1/2" in diameter.

STOCK NO.	UPC NO.	DESCRIPTION	WT. PER EACH	STD. PKG.	SUGGESTED TRADE LIST PRICE PER
WCH1	72599	Crayon Holder-Wood	.05	1	15.10/ea



MACHINE SCREW ANCHOR SETTING TOOL

For setting Machine Screw Anchors

STOCK NO.	UPC NO.	SIZE	WT. PER EACH	STD. PKG.	SUGGESTED TRADE LIST PRICE PER
1402ST	17905	8-32	.07	1	4.20/ea
1403ST	17910	10-24	.08	1	5.03/ea
1404ST	17915	10-32	.14	1	5.03/ea
1406ST	17925	1/4-20	.17	1	5.58/ea
1407ST	17930	5/16-18	.27	1	5.95/ea
1408ST	17935	3/8-16	.38	1	6.28/ea
1409ST	17940	1/2-13	.58	1	12.13/ea

HAND DRIVE TOOL

STEEL DROP-IN ANCHOR SETTING TOOL

For Setting DIA14, DIA12, DIA38 & DIA58



STOCK NO.	UPC NO.	SIZE	WT. PER EACH	STD. PKG.	SUGGESTED TRADE LIST PRICE PER
DIA14T	12181	1/4-20	.18	1	3.85/ea
DIA38T	12182	3/8-16	.24	1	5.00/ea
DIA12T	12183	1/2-13	.41	1	6.18/ea
DIA58T	12184	5/8-11	.51	1	11.53/ea

TOOLS, DRILLS AND ACCESSORIES



METALLICS KEYHOLE SAW WOODEN HANDLE

- Designed especially for plasterboard.
- Make cut-outs for electrical outlets, etc.
- Point sharpened for plunge cuts.



STOCK NO.	UPC NO.	LENGTH	BLADE EACH	WEIGHT PKG.	SUGGESTED TRADE LIST PRICE PER
US6	31300	6	1.5 oz	.27	9.23/ea

METALLICS HAND DRILLING HAMMER WOODEN HANDLE

- The old standby.

SAFETY GLASSES SHOULD BE WORN FOR ANY DRIVING APPLICATIONS. SEE THE NEW LINE OF SAFETY GLASSES ON PAGES 220-222.



STOCK NO.	UPC NO.	HEAD WEIGHT	OVERALL LENGTH	STD. PKG.	SUGGESTED TRADE LIST PRICE PER
HAM3	18700	3.53	10"	1	40.38/ea



CARBON STEEL TAPS

PLUG STYLE

A STRONG, DURABLE PRODUCT

STOCK NO.	UPC NO.	SIZE	USE DRILL SIZE	WT. PER PKG.	STD. PKG.	SUGGESTED TRADE LIST PRICE PER
440CT	24900	4-40	#43	.05	5 Taps	20.83/ea pkg
632CT	24905	6-32	#36	.05	5 Taps	20.65/ea pkg
832CT	24910	8-32	#29	.07	5 Taps	20.83/ea pkg
1024CT	24915	10-24	#25	.10	5 Taps	21.83/ea pkg
1032CT	24920	10-32	#21	.10	5 Taps	21.83/ea pkg
1420CT	24925	1/4-20	#7	.15	5 Taps	23.85/ea pkg
516CT	24930	5/16-18	17/64	.16	5 Taps	26.00/ea pkg
3816CT	24935	3/8-16	5/16	.23	5 Taps	33.23/ea pkg
1213CT	24940	1/2-13	27/64	.46	5 Taps	43.48/ea pkg

OTHER SIZES AVAILABLE, TAPER OR BOTTOMING TAPS AVAILABLE UPON REQUEST



TAP WRENCH T-HANDLE STYLE

STOCK NO.	UPC NO.	CAPACITY	WT. PER PKG.	STD. PKG.	SUGGESTED TRADE LIST PRICE PER
TWH1	24970	0 to 1/4	.15	1	14.50/ea
TWH2	24975	1/4 to 1/2	.39	1	23.98/ea

TOOLS, DRILLS AND ACCESSORIES

CONCRETE SCREW INSTALLATION KIT

8 PIECE KIT
TOOLS AND DRIVING ACCESSORIES



KIT INCLUDES:

- 1 - Drill Driver
- 1 - Drill Adapter
- 2 - Hex Drivers
- 1 - Phillips Bit Holder
- 2 - Phillips Bits
- 1 - Allen Hex Key

DRILL BIT NOT INCLUDED

STOCK NO.	UPC NO.	DESCRIPTION	STD. PKG.	WT. EACH	SUGGESTED TRADE LIST PRICE PER
KIT					
IT1000	31200	Installation Tool (complete kit)	1	.95	110.10/ea
REPLACEMENT COMPONENTS FOR KIT					
MHD14	31205	1/4" Magnetic Hex Driver			30.55/ea
MHD56	31210	5/16" Magnetic Hex Driver			30.55/ea
PBH	31215	#2 & #3 Phillips Bit Holder			33.60/ea
ITSLEVE	31203	Drill/Driver Adapter			39.98/ea
PB2	31220	#2 Phillips Bit			1.53/ea
PB3	31225	#3 Phillips Bit			1.53/ea
HK1	31230	1/8" Allen Hex Key			1.53/ea

CAN BE USED WITH
THE METALLICS
QUADRIE CONCRETE
SCREWS



MASONRY DRILLS FOR CONCRETE SCREWS

SPECIAL SIZE AND LENGTH
FOR USE WITH INSTALLATION TOOL ABOVE

STOCK NO.	UPC NO.	SIZE	SCREW DIA.	STD. PKG.	WT. EACH	SUGGESTED TRADE LIST PRICE PER
CD1	31250	5/32 x 3 1/2	3/16	1	.02	3.38/ea
CD2	31255	5/32 x 4 1/2	3/16	1	.02	3.98/ea
CD3	31260	5/32 x 5 1/2	3/16	1	.02	4.53/ea
CD5	31265	3/16 x 3 1/2	1/4	1	.02	3.45/ea
CD6	31270	3/16 x 4 1/2	1/4	1	.02	4.08/ea
CD7	31275	3/16 x 5 1/2	1/4	1	.03	5.78/ea
CD8	31280	3/16 x 6	1/4	1	.03	7.43/ea



10 oz



32 oz

CAULKING GUN

PISTON ROD WITH DOUBLE FRICTION PLATE
QUICK-RELEASE LEVER

STOCK NO.	UPC NO.	TUBE SIZE	STD. PKG.	WT. EACH	SUGGESTED TRADE LIST PRICE PER
CG1	35020	10 oz	1	.90	7.55/ea
CG32	35050	32 oz	1	1.92	36.20/ea

TOOLS, DRILLS AND ACCESSORIES



HIGH-SPEED TWIST DRILLS

Bright Steel – Jobber's Length

STOCK NO.	UPC NO.	SIZE	OVERALL LENGTH	WT. PER PKG.	STD. PKG. (DRILLS)	SUGGESTED TRADE LIST PRICE PER
NUMBERED SIZES 118° POINTS						
NHSD6	24806	#6	3 ³ / ₄	.40	10	37.58/ea pkg
NHSD7	24807	#7	3 ⁵ / ₈	.20	10	35.60/ea pkg
NHSD8	24808	#8	3 ⁵ / ₈	.21	10	31.58/ea pkg
NHSD9	24809	#9	3 ⁵ / ₈	.37	10	30.88/ea pkg
NHSD10	24810	#10	3 ⁵ / ₈	.22	10	29.55/ea pkg
NHSD11	24811	#11	3 ¹ / ₂	.22	10	29.55/ea pkg
NHSD20	24820	#20	3 ¹ / ₄	.25	10	24.18/ea pkg
NHSD21	24821	#21	3 ¹ / ₄	.14	10	24.85/ea pkg
NHSD22	24822	#22	3 ¹ / ₈	.13	10	21.83/ea pkg
NHSD25	24825	#25	3	.12	10	21.15/ea pkg
NHSD26	24826	#26	3	.11	10	21.15/ea pkg
NHSD28	24828	#28	2 ⁷ / ₈	.10	10	21.83/ea pkg
NHSD29	24829	#29	2 ⁷ / ₈	.10	10	21.83/ea pkg
NHSD30	24830	#30	2 ³ / ₄	.08	10	21.83/ea pkg
NHSD31	24831	#31	2 ³ / ₄	.08	10	21.83/ea pkg
NHSD35	24835	#35	2 ⁵ / ₈	.07	10	21.83/ea pkg
NHSD36	24836	#36	2 ¹ / ₂	.06	10	21.83/ea pkg
NHSD37	24837	#37	2 ¹ / ₂	.06	10	16.45/ea pkg
NHSD43	24843	#43	2 ¹ / ₄	.05	10	16.45/ea pkg
FRACTIONAL SIZES 118° POINTS						
HSD1	24300	1 ¹ / ₁₆	1 ⁷ / ₈	.03	10	15.80/ea pkg
HSD2	24305	5 ⁵ / ₆₄	2	.04	10	15.80/ea pkg
HSD3	24310	3 ³ / ₃₂	2 ¹ / ₄	.05	10	16.13/ea pkg
HSD4	24315	7 ⁷ / ₆₄	2 ⁵ / ₈	.07	10	16.13/ea pkg
HSD5	24320	1 ¹ / ₈	2 ³ / ₄	.09	10	18.15/ea pkg
HSD6	24325	9 ⁹ / ₆₄	2 ⁷ / ₈	.11	10	19.83/ea pkg
HSD7	24330	5 ⁵ / ₃₂	3 ¹ / ₈	.14	10	20.15/ea pkg
HSD8	24335	11 ¹¹ / ₆₄	3 ¹ / ₄	.17	10	22.83/ea pkg
HSD9	24340	3 ³ / ₁₆	3 ¹ / ₂	.21	10	26.53/ea pkg
HSD29	24345	13 ¹³ / ₆₄	3 ⁵ / ₈	.26	10	30.23/ea pkg
HSD10	24350	7 ⁷ / ₃₂	3 ³ / ₄	.26	10	31.90/ea pkg
HSD11	24355	15 ¹⁵ / ₆₄	3 ⁷ / ₈	.35	10	34.90/ea pkg
HSD12	24360	1 ¹ / ₄	4	.41	10	40.98/ea pkg
HSD13	24365	17 ¹⁷ / ₆₄	4 ¹ / ₈	.29	5	24.18/ea pkg
HSD14	24370	9 ⁹ / ₃₂	4 ¹ / ₄	.28	5	28.40/ea pkg
HSD15	24375	19 ¹⁹ / ₆₄	4 ³ / ₈	.32	5	30.23/ea pkg
HSD16	24380	5 ⁵ / ₁₆	4 ¹ / ₂	.36	5	31.80/ea pkg
*HSD16R	24385	5 ⁵ / ₁₆	3 ¹³ / ₁₆	.32	5	NOT INCLUDED 34.40/ea pkg
HSD17	24390	21 ²¹ / ₆₄	4 ⁵ / ₈	.39	5	34.58/ea pkg
HSD18	24395	11 ¹¹ / ₃₂	4 ³ / ₄	.44	5	39.25/ea pkg
HSD19	24400	23 ²³ / ₆₄	4 ⁷ / ₈	.48	5	44.13/ea pkg
HSD20	24405	3 ³ / ₈	5	.55	5	45.33/ea pkg
*HSD20R	24410	3 ³ / ₈	4 ¹ / ₄	.43	5	NOT INCLUDED 48.03/ea pkg
HSD21	24415	25 ²⁵ / ₆₄	5 ¹ / ₈	.60	5	48.68/ea pkg
HSD22	24420	13 ¹³ / ₃₂	5 ¹ / ₄	.64	5	51.70/ea pkg
HSD23	24425	27 ²⁷ / ₆₄	5 ³ / ₈	.72	5	57.40/ea pkg
HSD24	24430	7 ⁷ / ₁₆	5 ¹ / ₂	.82	5	61.28/ea pkg
*HSD24R	24435	7 ⁷ / ₁₆	4 ¹¹ / ₁₆	.78	5	NOT INCLUDED 59.75/ea pkg
HSD25	24440	29 ²⁹ / ₆₄	5 ⁵ / ₈	.86	5	72.20/ea pkg
HSD26	24445	15 ¹⁵ / ₃₂	5 ³ / ₄	.89	5	69.50/ea pkg
HSD27	24450	31 ³¹ / ₆₄	5 ⁷ / ₈	1.00	5	74.03/ea pkg
HSD28	24455	1 ¹ / ₂	6	1.16	5	77.03/ea pkg
*HSD28R	24460	1 ¹ / ₂	4	.07	5	NOT INCLUDED 80.38/ea pkg

SEE PAGE 193

INCLUDED IN HSCD1 DRILL DISPLAY

NOT INCLUDED

NOT INCLUDED

NOT INCLUDED

NOT INCLUDED

* 1/4" Reduced Shank

OTHER SIZES AND QUANTITY AVAILABLE UPON REQUEST



HIGH-SPEED DRILL COUNTER DISPLAY

An attractive, compact "Point of Purchase" Display, 15" wide X 13" high X 8" deep. Improve sales by providing speedy selection of your complete range of high-speed drills.

- Strong metal construction
- Transparent hinged cover with lock prevents theft

Display contains standard package quantities of all 29 HSD fractional drill sizes in jobber lengths, standard shank, a total of 210 drills.
SEE PAGE 192

FRACTIONAL DRILLS FOR HSCD1 COUNTER DISPLAY

STOCK NO.	UPC NO.	DESCRIPTION	WT. PER EACH	STD. PKG.
HSCD1	24515	Display and 210 Assorted HSD drills	23.60	1 Display



SELECT-A-DRILL

SAD13 - 13 Piece Select-A-Drill Kit

Thirteen (13) high-speed jobber length drills from 1/16" to 1/4" by 64ths. Popular sizes in a unique rotating case

SAD21 - 21 Piece Select-A-Drill Kit

Twenty-one (21) high-speed jobber length drills from 1/16" to 3/8" by 64ths. Popular sizes in a unique rotating case



118° POINT

STOCK NO.	UPC NO.	WT. PER EA.	STD. PKG.	SUGGESTED TRADE LIST PRICE PER
SAD13	24520	.32	1	33.23/ea kit
SAD21	24525	.98	1	85.65/ea kit



118° POINT

HIGH-SPEED DRILL KITS

IN METAL INDEX CASE

HSDK1 29 Drills

HSDK2 15 Drills

HSDK3 13 Drills

STOCK NO.	UPC NO.	DESCRIPTION	WT. PER EA.	STD. PKG.	SUGGESTED TRADE LIST PRICE PER
HSDK1	24510	29 Drills 1/16" thru 1/2" by 1/64ths	3.25	1	180.08/ea kit
HSDK2	24505	15 Drills 1/16" thru 1/2" by 1/32nds	2.08	1	95.15/ea kit
HSDK3	24500	13 Drills 1/16" thru 1/4" by 1/64ths	.80	1	31.20/ea kit

TOOLS, DRILLS AND ACCESSORIES



GOLD HIGH-SPEED DRILL KITS

GOLD SURFACE TREATED HEAVY DUTY DRILLS
13 PIECE KIT IN METAL INDEX CASE

HVAC SPECIAL DRILLS
LIGHT GAUGE SHEET METAL



135° SPLIT POINT

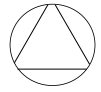

THREE FLATS ON SHANK

STOCK NO.	UPC NO.	DESCRIPTION	WT. PER KIT	STD. PKG.	SUGGESTED TRADE LIST PRICE PER
GDK13	24502	13 Drills 1/16" thru 1/4" x 1/64ths	.67	1	45.33/ea



HEX SHANK DRILL SET

5 PIECE SET

FOR DRILLS AND CORDLESS SCREWDRIVERS

118° POINT

STOCK NO.	UPC NO.	DESCRIPTION	WT. PER KIT	STD. PKG.	SUGGESTED TRADE LIST PRICE PER
DHS5	24530	5 Drills: 3/32" 7/64" 1/8" 9/64" 5/32"	.15	Set of 5 drills	29.28/ea

TO PROLONG DRILL LIFE USE CUTTING OIL FOR METAL.

TAP AND DRILL BIT SET

13 PIECE

- 6 Carbon Plug Taps - 4-40, 6-32, 8-32, 10-24, 10-32, 1/4-20
- 6 HSS Twist Drills - #43, #36, #29, #25, #21, #7
- 1 T-Handle Wrench



STOCK NO.	UPC NO.	WT. PER KIT	STD. PKG.	SUGGESTED TRADE LIST PRICE PER
TDS13	24945	.44	1	59.33/ea

SCREW EXTRACTOR AND DRILL BIT SET

10 PIECE

- Screw Extractors - #1, #2, #3, #4, #5
- Twist Drills - 5/64" 7/64" 5/32" 1/4" 17/64"

118° POINTS

STOCK NO.	UPC NO.	WT. PER KIT	STD. PKG.	SUGGESTED TRADE LIST PRICE PER
SEDS10	25028	.47	1	48.80/ea



TOOLS, DRILLS AND ACCESSORIES



COMBINATION HIGH SPEED STEEL DRILL-TAP

FOR ALL METAL APPLICATIONS

STOCK NO.	UPC NO.	DESCRIPTION	WT. PER PKG.	STD. PKG.	SUGGESTED TRADE LIST PRICE PER
DT632	24094	High Speed Steel 6-32 Drill-Tap	.02	1	31.63/ea
DT832	24095	High Speed Steel 8-32 Drill-Tap	.02	1	32.38/ea
DT1032	24096	High Speed Steel 10-32 Drill-Tap	.02	1	33.55/ea
DT1420	24097	High Speed Steel 1/4-20 Drill Tap	.03	1	39.18/ea
DT3816	24098	High Speed Steel 3/8-16 Drill-Tap	.08	1	54.78/ea
DT1213	24099	High Speed Steel 1/2-13 Drill-Tap	.13	1	76.88/ea

OTHER SIZES AND QUANTITY AVAILABLE UPON REQUEST



SHIP AUGER BITS

HEX SHANK
EXTRA HIGH QUALITY

- Single twist with single cutter and side up
- Machine ground hollows, deep throat for fast chip removal
- $\frac{7}{16}$ " shank for 3 jaw chucks
- Heat treated tool steel for strength and long life
- **E-Z to display packaging!**

SPECIFICALLY DESIGNED FOR WOOD PRODUCT CONSTRUCTION

STOCK NO.	UPC NO.	BORE DIAMETER	LENGTH	WT. PER PKG.	STD. PKG.	SUGGESTED TRADE LIST PRICE PER
AS916	24600	$\frac{9}{16}$	8	.25	1 Bit	27.83/ea
AS58	24601	$\frac{5}{8}$	8	.28	1 Bit	26.78/ea
AS1116	24602	$\frac{11}{16}$	8	.31	1 Bit	37.80/ea
AS34	24603	$\frac{3}{4}$	8	.43	1 Bit	45.08/ea
AS1316	24604	$\frac{13}{16}$	8	.42	1 Bit	45.18/ea
AS78	24605	$\frac{7}{8}$	8	.54	1 Bit	53.05/ea
AS1516	24606	$\frac{15}{16}$	8	.40	1 Bit	54.05/ea
AS1	24607	1	8	.45	1 Bit	57.38/ea
AS118	24608	$1\frac{1}{8}$	8	.79	1 Bit	64.35/ea
AS114	24609	$1\frac{1}{4}$	8	.55	1 Bit	74.18/ea
AS138	24610	$1\frac{3}{8}$	8	.82	1 Bit	96.48/ea
AS112	24611	$1\frac{1}{2}$	8	1.22	1 Bit	103.40/ea
AL916	24615	$\frac{9}{16}$	18	.65	1 Bit	58.30/ea
AL58	24616	$\frac{5}{8}$	18	.72	1 Bit	64.25/ea
AL1116	24617	$\frac{11}{16}$	18	.87	1 Bit	72.58/ea
AL34	24618	$\frac{3}{4}$	18	.71	1 Bit	73.80/ea
AL1316	24619	$\frac{13}{16}$	18	1.08	1 Bit	73.80/ea
AL78	24620	$\frac{7}{8}$	18	1.24	1 Bit	76.03/ea
AL1516	24621	$\frac{15}{16}$	18	1.36	1 Bit	70.70/ea
AL1	24622	1	18	1.54	1 Bit	73.68/ea
AL118	24623	$1\frac{1}{8}$	18	1.42	1 Bit	105.70/ea
AL114	24624	$1\frac{1}{4}$	18	2.35	1 Bit	113.00/ea
AL138	24625	$1\frac{3}{8}$	18	2.94	1 Bit	126.73/ea
AL112	24626	$1\frac{1}{2}$	18	3.30	1 Bit	133.70/ea

THE METALLICS SHIP AUGER BIT IS NOT SOLD AS A NAIL BITER. IT IS ONLY RECOMMENDED FOR WOOD PRODUCTS.

OTHER SIZES AND QUANTITY AVAILABLE UPON REQUEST

TOOLS, DRILLS AND ACCESSORIES



QUIK-BIT FLAT WOOD BORING BIT

PACKED IN VINYL POUCH
E-Z TO DISPLAY PACKAGING

STOCK NO.	UPC NO.	SIZE	OVERALL LENGTH	WT. PER PKG.	STD. PKG.	SUGGESTED TRADE LIST PRICE PER
QB1	24701	1/4	6	.05	1 Bit	6.65/ea
QB2	24702	5/16	6	.06	1 Bit	6.28/ea
QB3	24703	3/8	6	.09	1 Bit	6.75/ea
QB4	24704	7/16	6	.06	1 Bit	6.75/ea
QB5	24705	1/2	6	.09	1 Bit	6.75/ea
QB6	24706	9/16	6	.09	1 Bit	7.08/ea
QB7	24707	5/8	6	.09	1 Bit	7.08/ea
QB8	24708	11/16	6	.09	1 Bit	7.33/ea
QB9	24709	3/4	6	.09	1 Bit	7.33/ea
QB10	24710	13/16	6	.10	1 Bit	7.43/ea
QB11	24711	7/8	6	.10	1 Bit	7.73/ea
QB12	24712	15/16	6	.11	1 Bit	8.28/ea
QB13	24713	1	6	.13	1 Bit	8.28/ea
QB14	24714	1 1/8	6	.13	1 Bit	11.35/ea
QB15	24715	1 1/4	6	.13	1 Bit	11.35/ea
QB16	24716	1 3/8	6	.14	1 Bit	11.48/ea
QB17	24717	1 1/2	6	.14	1 Bit	11.48/ea
QB22	24722	3/8	16	.27	1 Bit	20.50/ea
QB24	24724	1/2	16	.33	1 Bit	20.93/ea
QB26	24726	5/8	16	.28	1 Bit	22.83/ea
QB28	24728	3/4	16	.28	1 Bit	25.15/ea
QB29	24729	7/8	16	.32	1 Bit	25.15/ea
QB31	24731	1	16	.30	1 Bit	24.53/ea

OTHER SIZES AND QUANTITIES AVAILABLE UPON REQUEST

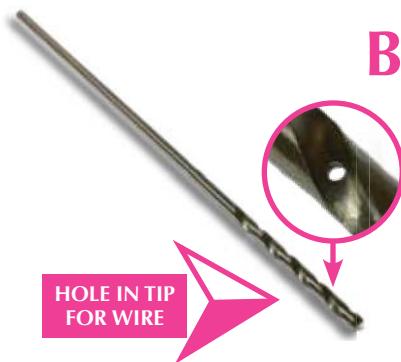

BELL HANGER'S DRILL

HIGH-GRADE STEEL
E-Z TO DISPLAY PACKAGING

- Specifically designed for wood product construction
- For all telephone, electrical, small wire, protective alarm and cable T.V. uses
- Resists damage during drilling if metal is encountered
- Not for masonry products

STOCK NO.	UPC NO.	DIAMETER	LENGTH	DIAMETER	WT. PER PKG.	STD. PKG.	SUGGESTED TRADE LIST PRICE PER
BHD5	26020	1/4	18	1/4	.26	1 Drill	33.03/ea
BHD6	26025	5/16	18	5/16	.40	1 Drill	36.68/ea
BHD7	26030	3/8	18	3/8	.56	1 Drill	39.55/ea
BHD8	26035	1/2	18	3/8	.90	1 Drill	45.13/ea
BHD9	26040	1/4	24	1/4	1.00	1 Drill	46.38/ea
BHD10	26045	5/16	24	5/16	.69	1 Drill	50.40/ea
BHD11	26050	3/8	24	3/8	.70	1 Drill	52.38/ea
BHD12	26055	1/2	24	3/8	.75	1 Drill	57.38/ea

OTHER SIZES AND QUANTITIES AVAILABLE UPON REQUEST

TOOLS, DRILLS AND ACCESSORIES



SDS-PLUS HAMMER DRILL

IDEAL FOR ROTARY AND PERCUSSION DRILLING
FOR ALL MASONRY PRODUCTS

STOCK NO.	UPC NO.	DESCRIPTION	WT. PER PKG.	SUGGESTED TRADE LIST PRICE PER
SDS31645	24101	3/16" x 4-1/2" SDS-Plus Hammer Drill Bit	.08	16.38/ea
SDS31665	24102	3/16" x 6-1/2" SDS-Plus Hammer Drill Bit	.10	16.70/ea
SDS3168	24103	3/16" x 8" SDS-Plus Hammer Drill Bit	.10	23.53/ea
SDS1445	24104	1/4" x 4-1/2" SDS-Plus Hammer Drill Bit	.09	16.38/ea
SDS1465	24106	1/4" x 6-1/2" SDS-Plus Hammer Drill Bit	.11	16.70/ea
SDS149	24107	1/4" x 9" SDS-Plus Hammer Drill Bit	.14	23.53/ea
SDS3865	24108	3/8" x 6-1/2" SDS-Plus Hammer Drill Bit	.16	21.98/ea
SDS389	24109	3/8" x 9" SDS-Plus Hammer Drill Bit	.20	42.33/ea
SDS1265	24111	1/2" x 6-1/2" SDS-Plus Hammer Drill Bit	.22	29.98/ea
SDS129	24112	1/2" x 9" SDS-Plus Hammer Drill Bit	.34	48.43/ea
SDS5865	24113	5/8" x 6-1/2" SDS-Plus Hammer Drill Bit	.26	39.88/ea
SDS589	24114	5/8" x 9" SDS-Plus Hammer Drill Bit	.31	48.43/ea
SDS3465	24116	3/4" x 9" SDS-Plus Hammer Drill Bit	.45	80.58/ea

OTHER SIZES AND QUANTITIES AVAILABLE UPON REQUEST

POWER BIT EXTENSIONS

FOR USE WITH QUIK-BITS, SHIP AUGER, AND POWER BITS



- Hex wrench included
- Two set screws
- **E-Z TO DISPLAY PACKAGING**

STOCK NO.	UPC NO.	SIZE	WT. EACH	STD. PKG.	SUGGESTED TRADE LIST PRICE PER
BE1418	24875	1/4 x 18	.48	1	44.05/ea
BE5618	24880	5/16 x 18	1.50	1	41.23/ea
BE7612	24885	7/16 x 12	.86	1	43.28/ea
BE7618	24890	7/16 x 18	1.20	1	49.98/ea
BE7624	24891	7/16 x 24	1.56	1	61.48/ea



SD34

MULTI STEP DRILLS

SELF STARTING TIP ELIMINATES NEED FOR PILOT HOLE DRILLING
GOOD IN ALL SHEET METALS UP TO 1/8" THICK



SD12

STOCK NO.	UPC NO.	DESCRIPTION	WT. PER PKG.	STD. PKG.	SUGGESTED TRADE LIST PRICE PER
SD12	24080	1/8-1/2, 2 FLUTE, 13 STEP	.06	1	55.10/ea
SD34	24082	1/4-3/4" 2 FLUTE, 9 STEP	.10	1	80.00/ea
SD78	24084	7/8 TO 1 1/8" 3 STEP	.16	1	123.08/ea
3 SET COMBO PACK					
SDCP3	24088	1/8 TO 1/2" 2 FLUTE, 13 STEP 1/4 TO 3/4" 2 FLUTE, 9 STEP 7/8 TO 1 1/8" 3 STEP	.37	1	258.23/ea kit

TOOLS, DRILLS AND ACCESSORIES

SAWTOOTH MULTISPUR WOOD DRILL BITS



PACKAGED INDIVIDUALLY
WITH EXTRA DOUBLE END
SCREWS AND WRENCH

**E-Z TO DISPLAY
PACKAGING**

REPLACEMENT SCREW POINTS

STOCK NO.	UPC NO.	SIZE	FITS	LIST PRICE EA
SP0001	23550	1/4"	1 1/4 - 2 9/16	7.75 EA
SP0002	23552	1/4"	3 - 4 5/16	7.75 EA

STOCK NO.	UPC NO.	DESCRIPTION	SHANK DIAMETER	WT. PER PKG.	STD. PKG.	SUGGESTED TRADE LIST PRICE PER
306MS0	23500	1 3/8 for 3/4" pipes	7/16	.43	1	64.38/ea
306MS1	23505	1 1/2 for 1" pipes	7/16	.46	1	64.38/ea
306MS2	23510	1 3/4 for 1 1/4" pipes	7/16	.51	1	66.23/ea
306MS3	23515	2 1/8 for 1 1/2" pipes	7/16	.74	1	66.23/ea
306MS4	23520	2 9/16 for 2" pipes	7/16	.89	1	100.33/ea

EXTENSIONS FOR SHIP AUGERS & MULTISPUR

HEX WRENCH INCLUDED • TWO SET SCREWS • PACKAGED IN VINYL POUCH

BE7612	24885	7/16 x 12	.86	1	43.28/ea
BE7618	24890	7/16 x 18	1.20	1	49.98/ea

BULK PACKAGED CARBIDE MASONRY DRILLS

The Five Most Popular Sizes



STOCK NO.	UPC NO.	DIAMETER	LENGTH	SHANK DIAMETER	QTY.	WT. PER PKG.	SUGGESTED TRADE LIST PRICE PER
BFRB12	37050	1/4	4	1/4	100	3.43	268.55/ea pkg
BFRB14	37055	5/16	4	1/4	75	3.08	254.28/ea pkg
BFRB16	37060	3/8	4	1/4	50	3.14	109.95/ea pkg
BFRB21	37065	1/2	4	1/4	25	2.64	39.45/ea pkg
BFRB20	37070	1/2	6	3/8	25	4.73	46.15/ea pkg

OTHER SIZES AND QUANTITIES AVAILABLE UPON REQUEST

FLEXIBLE FISH-BITS

- Unique flexible self-feeding bits up to 72" long suitable for drilling holes with the length of wall cavities and through hidden studs with no damage to wallboard plaster or any exterior finish.
 - Bit has hole at tip and the shank which allows you to fish wire



STOCK NO.	UPC NO.	DESCRIPTION	SIZE	SHANK SIZE	WT. PER PKG.	STD. PKG.	SUGGESTED TRADE LIST PRICE PER
MFB1454	26455	FISH-BIT	1/4 x 54	3/16	.65	1	64.30/ea
MFB3854	26459	FISH-BIT	3/8 x 54	3/16	.65	1	67.60/ea
MFB1254	26451	FISH-BIT	1/2 x 54	3/16	.65	1	70.70/ea
MFB1472	26457	FISH-BIT	1/4 x 72	3/16	.75	1	68.18/ea
MFB3872	26461	FISH-BIT	3/8 x 72	3/16	.75	1	69.08/ea
MFB1272	26453	FISH-BIT	1/2 x 72	3/16	.65	1	71.30/ea
MSG1	26445	Steering Guide			.47	1	59.88/ea

TOOLS, DRILLS AND ACCESSORIES

CARBIDE MASONRY DRILLS

IDEAL FOR ROTARY AND PERCUSSION DRILLING
BLACK



- Specially designed spirals for fast dust removal
- **E-Z TO DISPLAY PACKAGING**
- Slow spiral drills can be used with **either rotary or hammer drills** in hard brick, sandstone, bluestone, terracotta block and hard concrete

STOCK NO.	UPC NO.	DIAMETER	LENGTH	SHANK DIAMETER	WT. PER PKG.	STD. PKG.	SUGGESTED TRADE LIST PRICE PER
BFR10	24100	1/8	3	3/32	.02	1	2.98/ea
BFR11	24105	3/16	4	9/64	.03	1	2.98/ea
BFR12	24110	1/4	4	1/4	.04	1	2.98/ea
BFR13	24115	1/4	6	1/4	.06	1	4.35/ea
BFR14	24120	5/16	4	1/4	.05	1	3.75/ea
BFR15	24125	5/16	6	1/4	.08	1	5.40/ea
BFR16	24130	3/8	4	1/4	.07	1	4.88/ea
BFR17	24135	3/8	6	1/4	.11	1	6.05/ea
BFR18	24140	7/16	6	1/4	.15	1	6.15/ea
BFR21	24145	1/2	4	1/4	.11	1	7.00/ea
BFR19	24150	1/2	6	1/4	.20	1	8.23/ea
BFR20	24155	1/2	6	3/8	.20	1	8.23/ea
<hr/>							
BTT22	24160	9/16	6	3/8	.31	1	15.80/ea
BTT23	24165	5/8	6	3/8	.31	1	22.10/ea
BTT25	24175	7/8	6	1/2	.58	1	22.48/ea
BTT26	24180	1	6	1/2	.75	1	29.50/ea
BTT1	24185	1/4	12	1/4	.15	1	11.28/ea
BTT2	24190	5/16	12	1/4	.22	1	11.43/ea
BTT4	24200	1/2	12	3/8	.44	1	15.88/ea
BTT5	24205	5/8	12	3/8	.62	1	21.03/ea
BTT6	24210	3/4	12	1/2	.91	1	33.23/ea
BTT7	24215	7/8	12	1/2	1.24	1	34.88/ea
BTT8	24220	1	12	1/2	1.53	1	47.33/ea

OTHER SIZES AND QUANTITIES AVAILABLE UPON REQUEST

EXTRA LONG MASONRY DRILLS



HEAVY-DUTY CARBIDE TIPPED
E-Z TO DISPLAY PACKAGING

STOCK NO.	UPC NO.	DIAMETER	LENGTH	SHANK DIAMETER	WT. EACH	STD. PKG.	SUGGESTED TRADE LIST PRICE PER
BTT9	24225	1/4	18	1/4	.22	1	19.58/ea
BTT11	24235	3/8	18	3/8	.45	1	21.50/ea
BTT12	24240	1/2	18	3/8	.64	1	25.18/ea
BTT13	24245	5/8	18	1/2	.94	1	29.90/ea
BTT14	24250	3/4	18	1/2	1.37	1	36.55/ea
BTT15	24255	7/8	18	1/2	1.79	1	71.40/ea
BTT16	24260	1	18	1/2	2.50	1	71.58/ea

TOOLS, DRILLS AND ACCESSORIES

MASTER FLASH® COMPLETE ROOF JACK KIT



Everything in ONE KIT!

- The Master Flash® Roof Jack
- UV Cable Tie
- Metallics Special Sealant
- 10 x 1 Indented Hex Tek Type Self-Drilling Screws
- Easy Installation Instructions

Universal Pipe Flashing System...

- Weather Resistant
- Adapts to Many Roof Surfaces
- Easily Installed
- Uniform Plumbing Code (UPC®) Listed

Numerous Applications...

- Plumbing, Heating/Air Conditioning Equipment
- Electrical Service Entrances
- TV Aerials
- Masts, Vents or Pipes Through Decks or Bulkheads

STOCK NO.	UPC NO.	FITS PIPE SIZES/ JACK BASE SIZE	DESCRIPTION OF CONTENTS	WEIGHT EACH	STD. PKG.	SUGGESTED TRADE LIST PRICE PER
RJK1	31400	1/4" - 2" 4 1/2" Base	1 - Roof Jack, 1 - 25" Sealant Strip, 12 - Drive Screws, 1 - 11" Cable Tie	.51	1	30.08/ea
RJK2	31401	1/4" - 3" 6" Base	1 - Roof Jack, 1 - 35" Sealant Strip, 16 - Drive Screws, 1 - 15" Cable Tie	.77	1	34.95/ea
RJK3	31402	1/4" - 4" 8" Base	1 - Roof Jack, 1 - 45" Sealant Strip, 20 - Drive Screws, 1 - 21" Cable Tie	1.13	1	41.10/ea

MASTER FLASH ROOF JACKS - BULK/UNPACKAGED

STOCK NO.	UPC NO.	FITS PIPE SIZES/ JACK BASE SIZE	DESCRIPTION OF CONTENTS	WEIGHT EACH	STD. PKG.	SUGGESTED TRADE LIST PRICE PER
RJK1B	31237	1/4" - 2" for 4 1/2" Base	1 - Roof Jack	.25	1	18.48/ea
RJK2B	31238	1/4" - 3" for 6" Base	1 - Roof Jack	.50	1	21.30/ea
RJK3B	31239	1/4" - 4" for 8" Base	1 - Roof Jack	.75	1	25.05/ea

OTHER SIZES AND QUANTITIES AVAILABLE UPON REQUEST

MASTER FLASH® IS A REGISTERED TRADEMARK

DAP® DOW CORNING® SILICONE SEALANT

Protect and seal with 100% silicone rubber. Waterproof and flexible. Non-paintable.
50 year manufacturer durability guarantee. Meets ASTM C-920, Class 25, Type S, Grade NS.



STOCK NO.	UPC NO.	DESCRIPTION	WT. PER PKG.	STD. PKG.	SUGGESTED TRADE LIST PRICE PER
WDSC10	71234	CLEAR - 10.1 oz.	.86	1	12.50/ea
WDSW10	71235	WHITE - 10.1 oz.	.78	1	12.78/ea

DAP® DOW CORNING® ARE A REGISTERED TRADEMARK

GREY BUTYL TAPE FOR CAULKING

(SOLD IN PLASTIC BAGS)

STOCK NO.	UPC NO.	DESCRIPTION	WT. PER PKG.	STD. PKG.	SUGGESTED TRADE LIST PRICE PER
TC1	31236	1/8" thick x 3/4" wide x 30' long.	1.08	1	24.23/ea

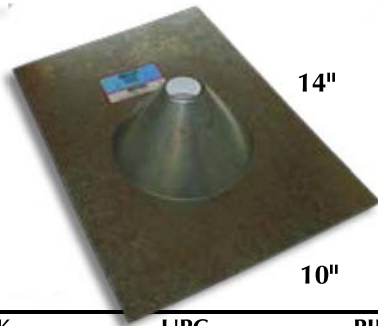

ROOF JACKS

26 GAUGE
10" x 14" Standard Base
Two-piece galvanized

STOCK NO.	UPC NO.	PIPE SIZE	WT. PER EACH	STD. PKG.	SUGGESTED TRADE LIST PRICE PER
MF50	31410	1/2"	1.00	1	8.08/ea
MF75	31411	3/4"	1.05	1	8.08/ea
MF100	31412	1"	.95	1	8.08/ea
MF125	31413	1 1/4"	.95	1	8.08/ea
MF150	31414	1 1/2"	.95	1	8.08/ea
MF200	31415	2"	.90	1	8.08/ea

For 0/12 - 5/12 roof pitch

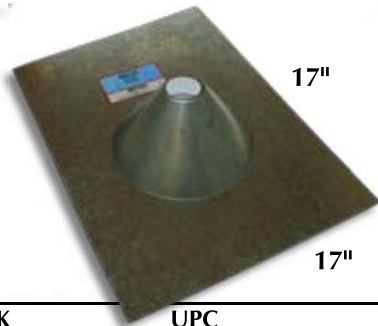

ROOF JACKS

26 GAUGE - FHA
17" x 17" Shingle Base
Two-piece galvanized

STOCK NO.	UPC NO.	PIPE SIZE	WT. PER EACH	STD. PKG.	SUGGESTED TRADE LIST PRICE PER
MFHA50	31416	1/2"	1.80	1	10.03/ea
MFHA75	31417	3/4"	1.80	1	10.03/ea
MFHA100	31418	1"	1.80	1	10.03/ea
MFHA125	31419	1 1/4"	1.80	1	10.03/ea
MFHA150	31420	1 1/2"	1.75	1	10.03/ea
MFHA200	31421	2"	1.75	1	10.03/ea

For 0/12 - 5/12 roof pitch

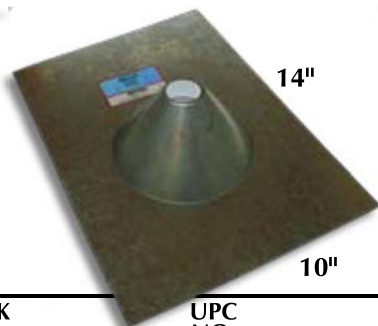

The Economical One! ROOF JACKS

26 GAUGE
One-Piece Spun Galvanized

STOCK NO.	UPC NO.	PIPE SIZE	WT. PER EACH	STD. PKG.	SUGGESTED TRADE LIST PRICE PER
SMF50	31422	1/2"	.75	1	6.95/ea
SMF75	31423	3/4"	.75	1	6.95/ea
SMF100	31424	1"	.75	1	6.95/ea
SMF125	31425	1 1/4"	.75	1	6.95/ea
SMF150	31426	1 1/2"	.75	1	6.95/ea
SMF200	31427	2"	.75	1	6.95/ea

For 0/12 - 5/12 roof pitch

TOOLS, DRILLS AND ACCESSORIES

3-in-1 ROOF FLASHINGS

GALVANIZED BASE ROOF FLASHINGS
24 GAUGE WITH ELASTOMER COLLAR



12^{1/2}

8^{3/4}

Stock No. MRJ50

Fits pipe sizes: 1/2", 3/4", 1"

Fits base size: 8-3/4" x 12-1/2"

- Slides over pipe - for pitch to 45 degree.
- Rustproof, stamped galvanized 24 gauge.
- 18" x 18" base for code required areas.
- Rated 180°F continuous heat.
- Approved for Type B installations.

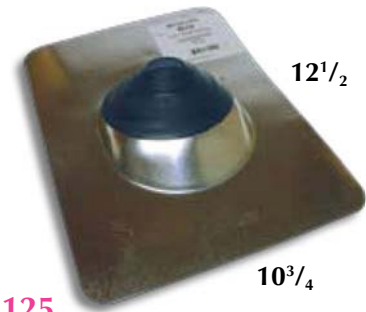

12^{1/2}

10^{3/4}

Stock No. MRJ125

Fits pipe sizes: 1-1/2", 2", 3"*

Fits base size: 10-3/4" x 12-1/2"

* Can be modified to fit 1-1/4" pipe

- Slides over pipe. Type of base determines pitch.
- Ring on collar tears off, allowing flashings to seal different pipe diameters.
- Non-fading, cracking and rusting bases and sealing collars.
- Rated 180°F continuous heat.
- Approved for Type B installations.

STOCK NO.	UPC NO.	PIPE SIZE	WT. PER PKG.	STD. PKG.	SUGGESTED TRADE LIST PRICE PER
MRJ50	31408	1/2" - 1"	.82	1	12.80/ea
MRJ125	31409	1-1/4" - 3"	1.16	1	15.78/ea



FLOOR FLANGE

ZINC PLATED
PACKAGED IN POLY BAGS

STOCK NO.	UPC NO.	PIPE SIZE	ANCHOR HOLE	WT. PER PKG.	STD. PKG.	SUGGESTED TRADE LIST PRICE PER
MFF25	16201	1/2"	1/4	.27	1	5.70/ea
MFF75	16202	3/4"	1/4	.49	1	6.75/ea
MFF100	16203	1"	1/4	.65	1	8.65/ea
MFF125	16204	1 1/4"	1/4	.88	1	11.80/ea
MFF150	16205	1 1/2"	1/4	1.16	1	12.50/ea
MFF200	16206	2"	5/16	1.55	1	16.60/ea



***Metallics and Avanti
Screw, Inc.
Where
Manufacturing
Quality is Job
One!***



Metallics

MASTERLOCK®

MasterLock Set 1", 2-1/2"



Another **NEW**
exciting security
solution from
Metallics!

Tired of searching
for Locks...

Here they are!

Part Number	UPC#	Description	Quantity Per Pkg.	Suggested Trade List Per Pkg.
PDL1	31481	MasterLock Set 1" Shackle Keyed Alike	2	\$44.77
PDL2	31482	MasterLock Set 2-1/2" Shackle Keyed Alike	3	\$51.06

Metallics

229 Cross Street,
Bristol, Ct. 06010
Tel: 800-243-8272
Fax: 800-831-9358
Email: sales@metallicsonline.com

"Growth Through Innovation"

www.metallicsonline.com

Metallics West

651 North Main Street
Mancos, Co. 81328
Tel: 800-269-5183
Fax: 800-269-6278
Email: saleswest@metallicsonline.com



Metallics

MASTERLOCK®

3/8" Braided Steel Looped Cables
4', 8', 15' Lengths



*Another NEW
exciting **security**
solution from
Metallics!*

*Tired of searching
for Braided Steel
Looped Cables...
Here they are!*

Part Number	UPC#	Description	Quantity Per Pkg.	Suggested Trade List Per Pkg.
TBC4	31454	3/8" Braided Looped Cable 4' Lg	1	\$16.98
TBC8	31458	3/8" Braided Looped Cable 8' Lg	1	\$21.40
TBC15	31465	3/8" Braided Looped Cable 15' Lg	1	\$39.38

Metallics

229 Cross Street,
Bristol, Ct. 06010
Tel: 800-243-8272
Fax: 800-831-9358
Email: sales@metallicsonline.com

"Growth Through Innovation"

Metallics West

651 North Main Street
Mancos, Co. 81328
Tel: 800-269-5183
Fax: 800-269-6278
Email: saleswest@metallicsonline.com



Metallics CORDPRO®



Easy to Operate

Extension Cord
Not Included

CordPro® Cord Organizer:

Keep your extension cords, audio/video cords, and hoses organized. Three different sizes in different colors.

Capacities:

PT# MCPM5

- 50 ft. - 18 ga. speaker wire
- 40 ft. - phone wire
- 15 ft. - usb cable
- 10 ft. - 16/3 elect cord

PT# MCPXL

- 150 ft. - 12/3 cord
- 100 ft. - 10/3 cord
- 60 ft. - 3/8" air hose
- 50 ft. - 1/2" water hose
- 50 ft. - 30 amp RV pwr. cord

Capacities Continued:

PT# MCP100

- 100 ft. - 16/3 cord
- 50 ft. - 12/3 cord
- 40 ft. - 10/3 cord
- 25 ft. - 1/2" water hose
- 50 ft. - 1/4" air hose
- 150 ft. - coaxial cable

Another NEW exciting solution from Metallics! Tired of searching for the right cord organizer... Here they are!



MCP100



MCPXL

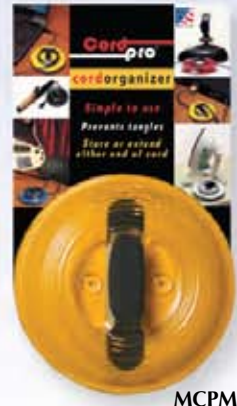

MCPM5

Stock Number	UPC#	Description	Weight Per Pkg.	Suggested Trade List Each
MCPM5	31325	Cordpro mini small cord organizer	1	\$15.23
MCP100	31330	Cordpro cord & hose organizer	1	\$36.50
MCPXL	31332	Cordpro cord & hose XL organizer	1	\$59.90

Metallics

229 Cross Street,
Bristol, Ct. 06010
Tel: 800-243-8272
Fax: 800-831-9358
Email: sales@metallicsonline.com

"Growth Through Innovation"

Metallics West

651 North Main Street
Mancos, Co. 81328
Tel: 800-269-5183
Fax: 800-269-6278
Email: saleswest@metallicsonline.com

CORDPRO® IS A REGISTERED TRADEMARK

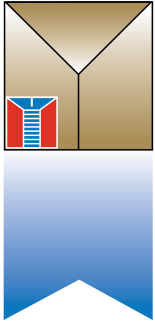

Metallics

Introducing!

MASTER LOCK®

FULLY ADJUSTABLE 5/16" x 6' LOCKING VINYL
COATED BRAIDED STEEL CABLE



STOCK NO.	UPC NO.	U/M	SUGGESTED TRADE LIST PRICE PER
PYLO1BLK	13080	1	24.33/ea.
PYLO1CAM	13085	1	27.83/ea.



Increased Security:

Cable length adjust to any position from 6' to 6'.

Application Flexibility:

Threads through places other cables cannot.

Cut Resistant:

5/16" (8mm) braided steel cable.

Scratch Resistant:

Vinyl coated cable and ABS plastic lock body.

Pick Resistant:

Reliable pin tumble mechanism.

DON'T JUST TIE IT DOWN, LOCK IT DOWN!!!

Metallics East • Bristol, CT
229 Cross Street
1-800-243-8272



Metallics West • Mancos, CO
651 North Main Street
1-800-269-5183

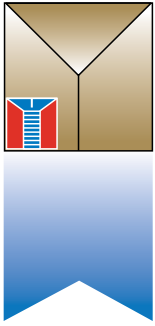

Metallics



Now Carrying!

RUBBER TARP STRAPS



STOCK NO.	UPC NO.	STRAP LENGTH MINUS HOOKS	WT.	SUGGESTED TRADE LIST PRICE PER
RTS14	12060	10"	.19	2.31/ea. NEW
RTS19	12062	15"	.24	2.81/ea. NEW
RTS24	12064	21"	.25	3.56/ea. NEW
RTS35	12066	31"	.33	4.44/ea. NEW
RTS45	12068	41"	.40	6.13/ea. NEW

Metallics East • Bristol, CT
 229 Cross Street
 1-800-243-8272

Metallics West • Mancos, CO
 651 North Main Street
 1-800-269-5183

CHEMICAL PRODUCTS



SIMPLE GREEN® SAFETY TOWELS



- Multi-purpose cleaning power
- Safer non-citrus formula
- Pre-Moistened
- Non-Toxic
- Versatile
- Quick

STOCK NO.	UPC NO.	DESCRIPTION	SIZE	WT. EACH	STD. QTY.	SUGGESTED TRADE LIST PRICE PER
WSGT75	71297	75 towels in each	10 x 11.75	2.28	1	38.78/ea



WYPALL® WATERLESS HAND CLEANER WIPES



STOCK NO.	UPC NO.	DESCRIPTION	WT. EACH	STD. QTY.	SUGGESTED TRADE LIST PRICE PER
WYP75	71390	75 Waterless Hand Cleaner Wipes	2.50	1	20.44/ea



HAND SANITIZER WIPES

Ensure personal protection from organisms that cause disease and sickness through cross-contamination.

Features and benefits:

- Kills 99.9% of disease causing germs and bacteria found on skin.
- Sanitizing formula contains enough alcohol to be highly effective, but will not dry out hands.
- Extended use will not cause dryness or cracking.
- U.S. Patent #: 5,962,001

STOCK NO.	UPC NO.	DESCRIPTION	WT. EACH	STD. QTY.	SUGGESTED TRADE LIST PRICE PER
HSCB85	71295	85 count bucket	1.23	1	32.10/ea

Simple Green®, Wypall® and Scrubs® are all Registered Trademarks

DAP® KWIK FOAM®

POLYURETHANE INSULATING SEALANT



Description:

A one part, moisture-cure, polyurethane foam that expands to economically fill and seal large cavities. Stops air filtration and will not degrade or shrink. Kwik Foam contains a flame retardant. The DAP trademark is a signature for products immediately recognized for their quality and leadership. It is a powerful signal to generations of do-it-yourselfers and professional tradespeople who chose and use products with the utmost confidence.

STOCK NO.	UPC NO.	WT.	SUGGESTED TRADE LIST PRICE PER
KF12	71472	12 oz.	21.63/ea.
KF24	71495	24 oz.	40.80/ea.

DAP® FIREBLOCK FOAM

POLYURETHANE FIREBLOCK FOAM SEALANT

Quick, easy to use fireblock product for filling:

- Joints between ceiling and walls or floors and walls
- Around vents, pipes, ducts and wires

For use in Type V residential construction.
Bright orange for easy code identification.
Expands 2-1/2 to 3 times its dispensed size.



STOCK NO.	UPC NO.	PACKAGE QUANTITY	COLOR	WT.	SUGGESTED TRADE LIST PRICE PER
WDFB12	71252	9 cans per case	Orange	12 oz.	21.63/ea.

DAP® Kwik Foam® are Registered Trademarks

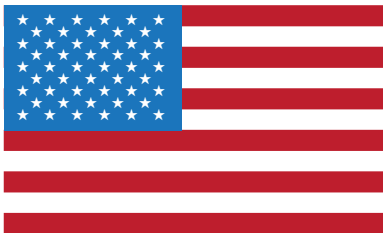

METALLICS

“Growth Through Innovation”

We believe Metallics has the largest ratio of American made to foreign produced product of any other American fastener company.

SERVING THE
ELECTRICAL, PLUMBING, HEATING AND AIR CONDITIONING
DISTRIBUTOR MARKETPLACE



Metallics
WYPALL®



Heavy duty, weather and crush resistant bucket protects the wipes inside. Each bucket holds 220 sheet roll of white thermally embossed hydroknit® wipes. Flex dispensing port for optimum dispensing.

*Another NEW
exciting solution
from Metallics!
Tired of searching
for the right heavy
duty wipe...
Here it is!*

Stock Number	UPC#	Description	Weight Per Pail	Suggested Trade List Per Pail
WYP220	71405	Wypall Wipes 220 sheet roll in a plastic pail	4.5 lbs	\$90.00

Metallics

229 Cross Street,
Bristol, Ct. 06010
Tel: 800-243-8272
Fax: 800-831-9358
Email: sales@metallicsonline.com

"Growth Through Innovation"

Metallics West

651 North Main Street
Mancos, Co. 81328
Tel: 800-269-5183
Fax: 800-269-6278
Email: saleswest@metallicsonline.com

BLACK JACK® ROOF PATCH

WET/DRY ROOF CEMENT

MADE IN USA



Black Jack® is a registered trademark

- Seals and stops leaks
- Expands and contracts with weather
- Forms a tight, strong seal
- Stays soft and pliable
- Repairs flashings



STOCK NO.	UPC NO.	SIZE	WEIGHT	STD. QTY.	SUGGESTED TRADE LIST PRICE PER
RCT1	41350	10 oz. Tube	.92	1	7.85/ea
RCQ1	41355	1 Quart	2.32	1	15.98/ea
RCG1	41360	1 Gallon	8.75	1	33.90/ea

MADE IN USA



DAP® FAST 'N FINAL® LIGHTWEIGHT SPACKLING

A superior lightweight spackling for repairing walls, ceilings and woodwork in one fill. Easy spread formula that needs no sanding. Will not crack or shrink. Excellent for both interior and exterior use.



DAP® and Fast 'N Final® are registered trademark

STOCK NO.	UPC NO.	DESCRIPTION	WT. PER PKG.	STD. PKG.	SUGGESTED TRADE LIST PRICE PER
WDS10	71221	1/2 pint - White	.27	1	5.70/ea
WDS20	71222	Qrt. - White	.98	1	13.95/ea
WDS30	71223	Gal. - White	5.18	1	41.00/ea

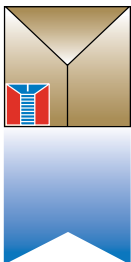

AMERICA'S SOURCE FOR PREMIER AND INNOVATIVE FASTENERS & ANCHORS



Metallics

DAP® 3.0 ADVANCED SEALANTS

Kitchen & Bath, All Purpose,
Gutter & Flashing, Black-Top & Roof,
Self-Leveling Concrete

NEW!



DAP 3.0 Advanced Sealants

All DAP 3.0 advanced sealants are technically superior with greater adhesion and flexibility so they won't crack or shrink and they are also paintable. Thanks to active quick dry technology DAP 3.0 can be exposed to water in just 3 hours.

Available in:

- 3.0 Advanced All-Purpose Sealant White & Clear
- 3.0 Advanced Kitchen & Bath White & Clear
- 3.0 Advanced Self-Leveling Concrete & Mortar Sealant Gray
- 3.0 Advanced Blacktop & Roof Sealant Black
- 3.0 Advanced Gutter & Flashing Sealant White

*Another NEW
exciting solution
from Metallics!
Tired of searching
for the right
Sealant...
Here it is!*

Stock Number	UPC#	Description	Weight Per Tube	Suggested Trade List Per Tube
WDKBW1	71532	3.0 Kitchen & Bath Sealant White	9.0 oz.	\$16.53
WDKBC1	71530	3.0 Kitchen & Bath Sealant Clear	9.0 oz.	\$20.33
WDSW30	71546	3.0 All-Purpose Sealant White	9.0 oz.	\$16.53
WDSC30	71544	3.0 All-Purpose Sealant Clear	9.0 oz.	\$20.33
WDGF1	71536	3.0 Gutter & Flashing Sealant White	9.0 oz.	\$16.53
WDBTR1	71540	3.0 Black-Top & Roof Sealant Black	9.0 oz.	\$16.53
WDSL1	71544	3.0 Self-Leveling Concrete Sealant Gray	9.0 oz.	\$16.53

Metallics

229 Cross Street,
Bristol, Ct. 06010
Tel: 800-243-8272
Fax: 800-831-9358
Email: sales@metallicsonline.com

"Growth Through Innovation"

Metallics West

651 North Main Street
Mancos, Co. 81328
Tel: 800-269-5183
Fax: 800-269-6278
Email: saleswest@metallicsonline.com



Metallics

DAP® ALEX PLUS®
ACRYLIC LATEX CAULK



*Another NEW
exciting solution
from Metallics!
Tired of searching
for the right
Acrylic Latex
Caulk...
Here it is!*

DAP® Alex Plus® Acrylic Latex caulk is a multi-purpose acrylic latex caulk plus silicone. Highly flexible and durable with excellent adhesion and paintable. Cured caulk is mildew resistant and can be used interior/exterior. Exceeds ASTM specification C834.

Stock Number	UPC#	Description	Weight Per Tube	Suggested Trade List Per Tube
WDEW10	71246	Alex Plus Acrylic Latex Caulk White	10.1 oz.	\$8.28
WDEC10	71187	Alex Plus Acrylic Latex Caulk Clear	10.1 oz.	\$8.58
WDEW5	71245	Alex Plus Acrylic Latex Caulk Squeeze Tube	5.5 oz.	\$9.20

Metallics

229 Cross Street,
Bristol, Ct. 06010
Tel: 800-243-8272
Fax: 800-831-9358
Email: sales@metallicsonline.com

"Growth Through Innovation"

Alex Plus® is a
registered trademark

www.metallicsonline.com

Metallics West

651 North Main Street
Mancos, Co. 81328
Tel: 800-269-5183
Fax: 800-269-6278
Email: saleswest@metallicsonline.com

CHEMICAL PRODUCTS

DAP® ELASTOPATCH® SMOOTH



A high performance, smooth finish, brush-on or trowel-on terpolymer patching compound. Designed to fill cracks up to 1/4" in interior or exterior surfaces. Excellent for use on stucco, masonry, brick, wood, plaster, drywall, concrete, metal, virtually any surface requiring a permanently flexible seal.

STOCK NO.	UPC NO.	DESCRIPTION	WT. PER PKG.	STD. PKG.	SUGGESTED TRADE LIST PRICE PER
WDPS10	71224	01smooth - 10.1 oz. - White	1.15	1	8.25/ea
WDPS20	71225	01 smooth - Qt. - White	3.34	1	18.63/ea
WDPS30	71226	01 smooth - Gal. - White	13.05	1	59.10/ea

DAP® ELASTOPATCH® TEXTURED



A high performance, textured finish, brush-on, trowel-on or roll-on terpolymer patching compound. Designed to fill cracks up to 1/4" in interior or exterior surfaces, excellent for use on stucco, masonry, brick, wood, plaster, drywall, concrete, metal, virtually any surface requiring a permanently flexible seal.

STOCK NO.	UPC NO.	DESCRIPTION	WT. PER PKG.	STD. PKG.	SUGGESTED TRADE LIST PRICE PER
WDPT10	71227	02 textured - 10.1 oz. - Off White	.86	1	7.48/ea
WDPT20	71228	02 textured - Qt. - Off White	2.65	1	17.05/ea
WDPT30	71229	02 textured - Gal. - Off White	11.74	1	57.13/ea

DAP® KWIK-SEAL® TUB & TILE ADHESIVE CAULK



Tub and tile adhesive and caulk in one. Mildew resistant. Excellent adhesion and flexibility. Tools easily and dries tack free in 15 minutes. Water clean-up.

STOCK NO.	UPC NO.	DESCRIPTION	WT. PER PKG.	STD. PKG.	SUGGESTED TRADE LIST PRICE PER
WDKS1	71231	5.5 oz. - White	.56	1	5.38/ea

DAP® FIRE STOP SEALANT



Single component silicone fire barrier for sealing around piping and wiring penetrations through fire-rated walls and floors. Meets ASTM Spec. E-814, UL 1479 and UL 2079.

STOCK NO.	UPC NO.	DESCRIPTION	WT. PER PKG.	STD. PKG.	SUGGESTED TRADE LIST PRICE PER
WDFS10	71232	10.1 oz. - Lt. Gray	1.04	1	40.75/ea

DAP®, ElastoPatch® and Kwik Seal® are registered trademarks

DAP® HIGH HEAT MORTAR



For firestopping at openings around vents, pipes, ducts, chimneys, in wood frame construction, also for patching fireplaces and wood-burning stoves. Withstands temperatures up to 2000°F. Non-combustible. ASTM E-136 rated.

STOCK NO.	UPC NO.	DESCRIPTION	WT. PER PKG.	STD. PKG.	SUGGESTED TRADE LIST PRICE PER
WDHM10	71233	10.1 oz. - Black	1.25	1	6.53/ea

DAP® DOW CORNING® SILICONE SEALANT



Protect and seal with 100% silicone rubber. Waterproof and flexible. Non-paintable. 50 year manufacturer durability guarantee. Meets ASTM C-920, Class 25, Type S, Grade NS.

STOCK NO.	UPC NO.	DESCRIPTION	WT. PER PKG.	STD. PKG.	SUGGESTED TRADE LIST PRICE PER
WDSC10	71234	Clear - 10.1 oz.	.86	1	12.50/ea
WDSW10	71235	White - 10.1 oz.	.78	1	12.78/ea
WDSG10	71238	Gray - 10.1 oz	.78	1	12.78/ea

DAP® ALEX PLUS® EASY CAULK



Packaged in a convenient, easy-to-use aerosol can. Eliminates the need for a caulk gun, delivers a smooth and consistent bead with no messy overflow. Ideal for use in tight spaces and for smaller jobs either indoors or outdoors.

STOCK NO.	UPC NO.	DESCRIPTION	WT. PER PKG.	STD. PKG.	SUGGESTED TRADE LIST PRICE PER
WDEC16	71236	16 oz. - White	1.09	1	14.88/ea

DAP® BEATS THE NAIL® CONSTRUCTION ADHESIVE



For general construction, remodeling, maintenance and repair projects. Provides a high-strength, heat and water resistant bond to a variety of substrates. Meets ASTM Specification C 557. For interior/exterior use.

STOCK NO.	UPC NO.	DESCRIPTION	WT. PER PKG.	STD. PKG.	SUGGESTED TRADE LIST PRICE PER
WDN1	71240	10.3 oz. - Gray	1.04	1	5.98/ea
WDN2	71241	29 oz. - Gray	2.96	1	16.98/ea

DAP® is a registered trademark
Beats The Nail® is a registered trademark
Dow Corning® is a registered trademark

CAULKING GUN

PISTON ROD WITH DOUBLE FRICTION PLATE
QUICK-RELEASE LEVER

10 oz

32 oz

STOCK NO.	UPC NO.	TUBE SIZE	WT. PER PKG.	STD. PKG.	SUGGESTED TRADE LIST PRICE PER
CG1	35020	10 oz.	.90	1	7.55/ea
CG32	35050	32 oz.	1.92	1	36.20/ea

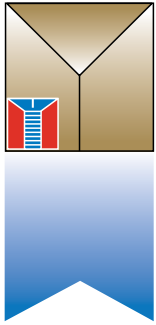

Metallics



OXIDE INHIBITOR COMPOUND



- For use on aluminum to copper and aluminum to aluminum connections.
- Seals out moisture and air to prevent oxidation.
- Improves service life of aluminum electrical applications.
- Compatible with insulating materials
- Installed product remains in place with no running or dripping.
- May be used as an anti-seizing compound.
- Available in an 8 ounce bottle.

STOCK NO.	UPC NO.	U/M	SUGGESTED TRADE LIST PRICE PER
OXIN1	60020	1	19.75/ea.

Metallics East • Bristol, CT
229 Cross Street
1-800-243-8272

Metallics West • Mancos, CO
651 North Main Street
1-800-269-5183

ELECTRICAL TAPES



STOCK NO.	UPC NO.	DESCRIPTION	WT. PER PKG.	STD. PKG.	SUGGESTED TRADE LIST PRICE PER
COLOR CODING P.V.C. TAPE (Individually wrapped in cellophane)					
PT34R	81030	3/4" x 60' Colored Phase Tape - RED UL	1.77	1	3.00/ea
PT34W	81032	3/4" x 60' Colored Phase Tape - WHITE UL	1.78	1	3.00/ea
PT34Y	81034	3/4" x 60' Colored Phase Tape - YELLOW UL	1.72	1	3.00/ea
PT34O	81036	3/4" x 60' Colored Phase Tape - ORANGE UL	1.70	1	3.00/ea
PT34BL	81038	3/4" x 60' Colored Phase Tape - BLUE UL	1.67	1	3.00/ea
PT34BR	81040	3/4" x 60' Colored Phase Tape - BROWN UL	1.73	1	3.00/ea
PT34G	81042	3/4" x 60' Colored Phase Tape - GREEN UL	1.73	1	3.00/ea
PT34GR	81044	3/4" x 60' Colored Phase Tape - GRAY UL	1.68	1	3.00/ea



STOCK NO.	UPC NO.	DESCRIPTION	WT. PER PKG.	STD. PKG.	SUGGESTED TRADE LIST PRICE PER
BLACK P.V.C. TAPE (Individually wrapped in cellophane)					
ST34BLK	81046	3/4" x 60' 7 Mill Black Tape UL	1.89	1	1.40/ea
AW34BLK	81048	3/4" x 66' 7 Mill Black All Weather Tape	1.91	1	4.43/ea



STOCK NO.	UPC NO.	DESCRIPTION	WT. PER PKG.	STD. PKG.	SUGGESTED TRADE LIST PRICE PER
BLACK FRICTION TAPE (Individually wrapped in cellophane)					
FT34BLK	81050	3/4" x 60' Black Friction Tape	.38	1	5.35/ea



STOCK NO.	UPC NO.	DESCRIPTION	WT. PER PKG.	STD. PKG.	SUGGESTED TRADE LIST PRICE PER
BLACK RUBBER TAPE (Individually wrapped in cellophane)					
RT34BLK	81052	3/4" x 22' Black Rubber Tape UL	.39	1	4.93/ea



STOCK NO.	UPC NO.	DESCRIPTION	WT. PER PKG.	STD. PKG.	SUGGESTED TRADE LIST PRICE PER
DUCT TAPE (Individually wrapped in cellophane)					
DT260	81054	2" x 60 yd Silver Duct Tape Utility Grade	1.33	1	12.15/ea



CONDUIT MEASURING TAPE

- Printed footage marking from 0 - 3,000
- Designed to allow user to measure and fish conduit runs
- 150 lbs breaking strength
- Made of 3/16" wide waterproof polyester
- Supplied on light weight metal spools for ease of use
- 3,000 feet per spool
- Designed to be used with industry standard dispensers

STOCK NO.	UPC NO.	DESCRIPTION	WT. PER PKG.	STD. PKG.	SUGGESTED TRADE LIST PRICE PER
CMT1	35055	Measuring Tape	3.98	1	104.43/ea

Add to a Metallics order to hit prepaid Minimums.

ELECTRICAL TAPES



STOCK NO.	UPC NO.	DESCRIPTION	WT. EACH	SUGGESTED TRADE LIST PRICE PER
ALUMINUM TAPE				
AT250	81130	2" x 50 yd Aluminum Tape	1.23	24.18/ea
AT350	81140	3" x 50 yd Aluminum Tape	1.73	38.08/ea



STOCK NO.	UPC NO.	DESCRIPTION	WT. EACH	SUGGESTED TRADE LIST PRICE PER
FIBER REINFORCED ALUMINUM TAPE				
FRT250	81160	2" x 50 yd Fiber Reinforced Aluminum Tape	1.32	42.53/ea



STOCK NO.	UPC NO.	DESCRIPTION	WT. EACH	SUGGESTED TRADE LIST PRICE PER
TEFLON TAPE				
TT12	81150	1/2" x 520" Teflon Tape	.03	1.35/ea



STOCK NO.	UPC NO.	DESCRIPTION	WT. EACH	SUGGESTED TRADE LIST PRICE PER
3" X 1000' - UNDERGROUND TAPE				
BT3TVO	81056	Caution Buried CATV Cable Line Below - ORANGE	7.50	50.13/ea
BT3EY	81058	Caution Buried Electrical Line Below - YELLOW	4.37	50.13/ea
BT3ER	81060	Caution Buried Electrical Line Below - RED	4.91	50.13/ea
BT3HVR	81062	Caution Buried High Voltage Line Below - RED	7.04	50.13/ea
BT3TPO	81064	Caution Buried Telephone Line Below - ORANGE	3.69	50.13/ea
BT3UY	81066	Caution Buried Utility Line Below - YELLOW	4.32	50.13/ea
BT3FO	81068	Caution Buried Fiber Optic Line Below - ORANGE	4.10	50.13/ea

CONTINUED ON NEXT PAGE

K

CONTINUED ELECTRICAL TAPES



STOCK NO.	UPC NO.	DESCRIPTION	WT. EACH	SUGGESTED TRADE LIST PRICE PER
6" x 1000' - NON-DETECTABLE UNDERGROUND TAPE				
BT6TVO	81070	Caution Buried CATV Cable Line Below - ORANGE	9.24	102.33/ea
BT6EY	81072	Caution Buried Electrical Line Below - YELLOW	8.61	102.33/ea
BT6ER	81074	Caution Buried Electrical Line Below - RED	9.21	102.33/ea
BT6HVR	81076	Caution Buried High Voltage Line Below - RED	9.20	102.33/ea
BT6TPO	81078	Caution Buried Telephone Line Below - ORANGE	8.43	102.33/ea
BT6UY	81080	Caution Buried Utility Line Below - YELLOW	8.43	102.33/ea
BT6FO	81082	Caution Buried Fiber Optic Line Below - ORANGE	9.63	102.33/ea



STOCK NO.	UPC NO.	DESCRIPTION	WT. EACH	SUGGESTED TRADE LIST PRICE PER
3" x 1000' - CAUTION BARRICADE TAPE				
CT3OTY	81084	Caution Open Trench - YELLOW	3.30	44.00/ea
CT3HVV	81086	Caution High Voltage - YELLOW	2.42	44.00/ea
CT3DNY	81088	Caution Do Not Enter - YELLOW	2.24	44.00/ea
CT3KOY	81090	Caution Keep Out - YELLOW	3.28	44.00/ea
CT3CY	81092	Caution - YELLOW	2.47	44.00/ea
CT3D	81091	Danger - RED	3.15	44.00/ea



STOCK NO.	UPC NO.	DESCRIPTION	WT. EACH	SUGGESTED TRADE LIST PRICE PER
3" x 1000' - DETECTABLE UNDERGROUND TAPE				
DT3HVR	81094	Caution Buried High Voltage Line Below - RED	7.04	136.50/ea
DT3ER	81096	Caution Buried Electrical Line Below - RED	7.12	136.50/ea
DT3TPO	81098	Caution Buried Telephone Line Below - ORANGE	6.85	136.50/ea
DT3FO	81100	Caution Buried Fiber Optic Line Below - ORANGE	6.75	136.50/ea



STOCK NO.	UPC NO.	DESCRIPTION	WT. EACH	SUGGESTED TRADE LIST PRICE PER
6" x 1000' - DETECTABLE UNDERGROUND TAPE				
DT6HVR	81102	Caution Buried High Voltage Line Below - RED	14.15	271.18/ea
DT6ER	81104	Caution Buried Electrical Line Below - RED	14.12	271.18/ea
DT6TPO	81106	Caution Buried Telephone Line Below - ORANGE	13.78	271.18/ea
DT6FO	81108	Caution Buried Fiber Optic Line Below - ORANGE	8.31	271.18/ea

WE RECOMMEND THAT IN THE INSTALLATION OF UNDERGROUND AND DETECTABLE TAPES, QUALIFIED PROFESSIONALS SHOULD BE PRESENT.



CHILL OUTS



IDEAL FOR SUMMER PROMOTION!

- Just soak in water and wear
- Use as a neckerchief or headband

CONTAINS A CRYSTAL POLYMER THAT ABSORBS WATER AND BECOMES A GEL THAT COOLS YOUR BODY FOR HOURS.

STOCK NO.	UPC NO.	WT. PER PKG.	STD. PKG.	SUGGESTED TRADE LIST PRICE PER
COHB1	41001	.10	1	10.08/ea

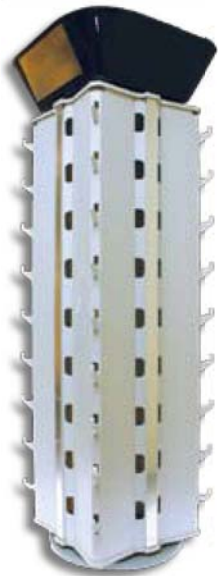

PROTECTIVE EYEWEAR COUNTER TOP CAROUSEL DISPLAY - SGD36

FREE
with first purchase of
36 or more pairs of
glasses.

- Easy-to-clean molded plastic display unit.
- Holds 36 pairs of glasses.
- Two-mirrored unit.
- Rotates 360 degrees.

WARNING: USE OF THIS DISPLAY COULD CAUSE SERIOUS ENVY WITH YOUR DISTRIBUTOR COMPETITION!

STOCK NO.	UPC NO.	DIMENSIONS/ DESCRIPTION
THE METALLICS PROTECTIVE EYEWEAR DISPLAY		
SGD36	71220	10" Diameter x 32" High

SHARK™

DESIGNER SAFETY GLASSES FOR FIELD ELECTRICIANS WHO WANT STRENGTH PLUS A "COOL STYLE"



- Maximum UV Protection
- Single High-Impact, Scratch Resistant Polycarbonate Lens
- Fashionable Wrap-around Styling
- Lightweight Nylon & Polycarbonate Combination Frame
- Adjustable Temples with Positive Stops
- Meets ANSI Z87.1 Standards
- Frame: Multi Colored

STOCK NO.	UPC NO.	DESCRIPTION	WT. EACH	STD. PKG.	SUGGESTED TRADE LIST PRICE PER
SSGC1	71196	Shark™ Safety Glasses with clear lens, R/W/B frame	.08	1	11.75/ea
SSGS1	71197	Shark™ Safety Glasses with smoke lens, black frame	.08	1	13.18/ea
SSGA1	71420	Shark™ Safety Glasses with amber lens, black frame	.08	1	16.38/ea

PROTECTIVE EYE WEAR

VISION™



- Lightweight Design
- Single High-Impact, Scratch-Resistant Polycarbonate Lens
- Integral Lens Sideshield
- Meets ANSI Z87.1 Standards
- Ebony colored Frame



EXTRA SPECIAL ADDED FEATURES:

- Multi-Angle 12-Position Adjustment
- 5-Position Temple Arm Length Adjustment with Fixed End-Stop Position
- Brow and Cheek Guard Protection

STOCK NO.	UPC NO.	DESCRIPTION	WT. EACH	STD. PKG.	SUGGESTED TRADE LIST PRICE PER
SVGC1	71205	VISION™ Safety Glasses with clear lens	.08	1	20.20/ea
SVGS1	71210	VISION™ Safety Glasses with smoke lens	.08	1	22.13/ea

8700 STRIKE FORCE™



WARNING: THIS PRODUCT, WHEN WORN ON CONSTRUCTION JOBS, COULD CAUSE SERIOUS ENVY!

- Maximum UV Protection
- Wrap-around, high-impact, scratch-resistant polycarbonate lens
- Unobstructed peripheral vision
- Soft rubber nosepiece and foam brow pad
- Adjustable length core wire temples with positive stops
- Meets ANSI Z87.1 Standards
- Ebony Frame: Clear and Smoke Lenses

STOCK NO.	UPC NO.	DESCRIPTION	WT. EACH	STD. PKG.	SUGGESTED TRADE LIST PRICE PER
CWGC1	71216	STRIKE FORCE™ Safety Glasses with clear lens	.08	1	17.63/ea
CWGS1	71217	STRIKE FORCE™ Safety Glasses with smoke lens	.08	1	17.63/ea



PACKED WITH PRIDE

As a part of our Quality Program, each shipment and each single carton leaving our facilities has a label affixed to it, indicating the person who packed the order.

HARD BODY PACKING

When you, the distributor, compare price and performance to other fastener suppliers, please compare our Hard Body Packing to the way they ship products. We do it the right way—the quality way—the Metallics way.



K

PROTECTIVE EYE WEAR

COBALT™

- Maximum UV Protection
- High-impact, 6 base curved, scratch-resistant polycarbonate lens
- Sof-Touch Nylon Frame
- Meets ANSI Z87.1 Standards
- Ebony Frame: Clear, Smoke, Amber and Silver Mirror Lenses



STOCK NO.	UPC NO.	DESCRIPTION	WT. EACH	STD. PKG.	SUGGESTED TRADE LIST PRICE PER
LLGC1	71212	COBALT™ Safety Glasses with clear lens	.06	1	12.45/ea
LLGS1	71213	COBALT™ Safety Glasses with smoke lens	.06	1	13.53/ea
LLGM1	71214	COBALT™ Safety Glasses with silver mirror lens	.07	1	14.78/ea

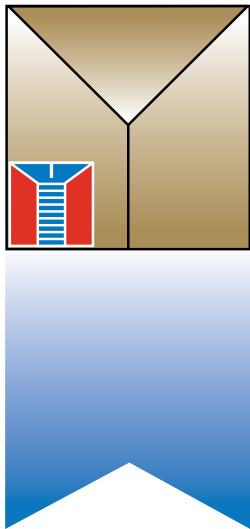

**This is the Heading Line at
Avanti Screw, Inc.,
A Metallics Affiliate
Bristol, CT.**

**We work hard at trying to be the best in America!
America's Source For Premier & Innovative Fasteners.**



MADE IN USA





Metallics

FIRST AID KIT

100 Pc



New! More Items!
In a sturdy polypropylene case, for easy storage.



Another NEW exciting solution from Metallics! Tired of searching for the right First Aid Kit...

Here it is!

Kit Contains

- | | | |
|--------------------------------------|---|-------------------------------|
| 30 Adhesive Bandages - 3/8" x 1-1/2" | 4 Sterile Gauze Dressings - 2" x 2" (2-in-1 pack) | 1 Instant Cold Compress |
| 20 Adhesive Bandages - 3" x 3/4" | 2 Sterile Gauze Dressings - 4" x 4" (2-in-1 pack) | 2 Antibiotic Ointments |
| 5 Butterfly Closure Bandages | 1 Adhesive Tape Roll - 1/2" x 2.5 yds. | 12 Alcohol Prep Pads |
| 10 Cotton Tip Applicators | 2 Examination Gloves | 6 Antiseptic Towelettes |
| 4 Finger Splints | | 1 First Aid Instruction Guide |

Stock Number	UPC#	Description	Quantity Per Pkg.	Suggested Trade List Per Pkg.
FAK100	62280	100 Pieces First Aid Kit	1	\$35.13

Metallics

229 Cross Street,
Bristol, Ct. 06010
Tel: 800-243-8272
Fax: 800-831-9358
Email: sales@metallicsonline.com

"Growth Through Innovation"

Metallics West

651 North Main Street
Mancos, Co. 81328
Tel: 800-269-5183
Fax: 800-269-6278
Email: saleswest@metallicsonline.com

FIRST AID KITS



Metallics FIRST AID KIT

170 Pc OSHA-ANSI Industrial First Aid Kit



New! More Items!
In a sturdy polypropylene
case, for easy storage.



*Another NEW
exciting solution
from Metallics!
Tired of searching
for the right
first aid kit...
Here it is!*

Kit Contains

- | | | |
|--|---|---------------------------------------|
| 20 Adhesive Bandages - 1" x 3" | 8 Sterile Sponge Dressings - 2" x 2"
(2-in-1 pack) | 3 Sting Relief Pads |
| 20 Adhesive Bandages - 3/8" x 1-1/2" | 6 Sterile Sponge Dressings - 4" x 4"
(2-in-1 pack) | 3 Povidone Iodine Pads |
| 20 Adhesive Bandages - 3" x 3/4" | 2 Round Eye Pad 2" | 6 Antibiotic Ointments |
| 5 Butterfly Closure Bandages | 1 Gauze Roll - 2" x 4.1 yds | 6 Burn Cream Packets |
| 1 Adhesive Tape Roll - 1" x 5 yds. | 1 Sterile Trauma Pad - 5" x 9" | 1 Instant Chemical Cold Packs 5" x 6" |
| 1 Triangular Bandage - 40" x 40" x 56" | 4 Examination Gloves | 1 Tweezers Safety pins |
| 10 Cotton Tip Applicators | 12 Alcohol Prep Pads | 1 Scissors |
| 1 Eye Wash - 1 oz. Bottle | 12 Antiseptic Towelettes | 8 Non Aspirin Tablets |
| 3 Finger Splints | | 8 Aspirin Tablets |
| 1 First Aid Instruction Guide | | 5 Safety Pins |

Stock Number	UPC#	Description	Quantity Per Pkg.	Suggested Trade List Per Pkg.
FAK170	62285	170 Pieces OSHA-ANSI Industrial First Aid Kit	1	\$54.25

Metallics

229 Cross Street,
Bristol, Ct. 06010
Tel: 800-243-8272
Fax: 800-831-9358

Email: sales@metallicsonline.com

Metallics West

651 North Main Street
Mancos, Co. 81328
Tel: 800-269-5183
Fax: 800-269-6278

Email: saleswest@metallicsonline.com

"Growth Through Innovation"



Metallics

SHOE COVERS



Reduced Price



Reduced Price



Reduced Price

Packaged in Bags of 10 & 20 pairs and Boxes of 150 pairs.

Description:

This item provides a cost-effective solution to keeping dirt/contamination out of your workplace, office or home.

We offer two different kinds of shoe covers:

- SCW is the original white heavy duty skid proof sole.
- SCB is our multi-purpose waterproof heavy duty blue shoe cover.

Additional Package Quantities

Stock Number	UPC#	Description	Quantity Per Pkg	Suggested Trade List Per Pkg.
SCW10	50030	Shoe Covers White w/Skid Proof Sole	10/pair	\$22.50
SCB10	50040	Shoe Covers Blue Multi-Purpose Waterproof	10/pair	\$22.50
SCW20	50035	Shoe Covers White w/Skid Proof Sole	20/pair	\$42.50
SCB20	50045	Shoe Covers Blue Multi-Purpose Waterproof	20/pair	\$42.50
SCW150	50055	Shoe Covers White w/Skid Proof Sole	150/pair	\$227.23
SCB150	50050	Shoe Covers Blue Multi-Purpose Waterproof	150/pair	\$227.23

Another NEW exciting solution from Metallics! Tired of searching for the right Shoe Cover... Here they are!

Metallics
 229 Cross Street,
 Bristol, Ct. 06010
 Tel: 800-243-8272
 Fax: 800-831-9358
 Email: sales@metallicsonline.com

"Growth Through Innovation"

Metallics West
 651 North Main Street
 Mancos, Co. 81328
 Tel: 800-269-5183
 Fax: 800-269-6278
 Email: saleswest@metallicsonline.com

www.metallicsonline.com





Metallics

NEW ABSORBANT RAGS

New Packaging and New Quantities

BR001 - 1 lb Bag of Rags

BR005 - 5 lb Bag of Rags Features a Convenient Handle in a EZ Open Resealable Poly Bag

BR025 - 25 lb Box of Rags with E-Z Open Top



*Another NEW
exciting solution
from Metallics!
Tired of searching
for the right
amount of rags...
Here they are!*

Part Number	UPC#	Description	Quantity Per Pkg.	Suggested Trade List Per Pkg.
BR001	71650	1-lb Bag of Rags	1-lb	\$7.85
BR005	71660	5-lb Plastic Bag of Rags, with Handle in a E-Z Open Bottom	5-lb	\$31.88
BR025	71669	25-lb Box of Rags, in E-Z Open Cardboard Box	25-lb	\$90.00

Metallics

229 Cross Street,
Bristol, Ct. 06010
Tel: 800-243-8272
Fax: 800-831-9358
Email: sales@metallicsonline.com

"Growth Through Innovation"

www.metallicsonline.com

Metallics West

651 North Main Street
Mancos, Co. 81328
Tel: 800-269-5183
Fax: 800-269-6278
Email: saleswest@metallicsonline.com

The Evolution of POR PAC...

In The Beginning...



We set the standard with the Award winning Por Pac Box and Breakaway sleeve.

Then...



We revolutionized the industry and made the handling and storing of these products easier with the job site plastic square jars.

NOW... Here we go again.



Introducing the E-Z flip lid.

Only at Metallics

Change...Adapt...or Perish!!

POR PAC is BACK in a jar.



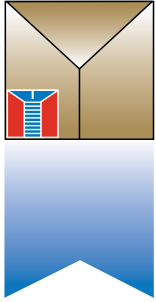

The only Distributor who also Manufactures:
We are the Gold Standard.

The EFC1

The first, the original and still the best.

The majority of our fastener competitors who promote racks have copied this rack design. It is an honor to be copied. Now, if they can improve their prices and their fill rate and ship over 98% of their orders the same day, then we will consider them real competition!

Dimensions:

21" (D) x 32.5" (W) x 81" (H)

**The most
copied
fastener rack
in the
business!**



FASTENER JAR SIZES

When a Distributor moves the fast-selling fastener items from the stock room to the display room, Metallics has the answer with the best Display Systems in the business.



THE JOB SITE AND TRUCK SQUARE PLASTIC JAR



6 oz

8 oz

15 oz

19 oz

28 oz

48 oz

72 oz

COMES SINGLE OR FIVE PER SHRINK WRAP SLEEVE IN 6, 8 AND 15 OZ SIZES



POINT OF PURCHASE DISPLAYS

The Metallics QUADRIVE Concrete Screw Anchor Counter Display #QCSHD

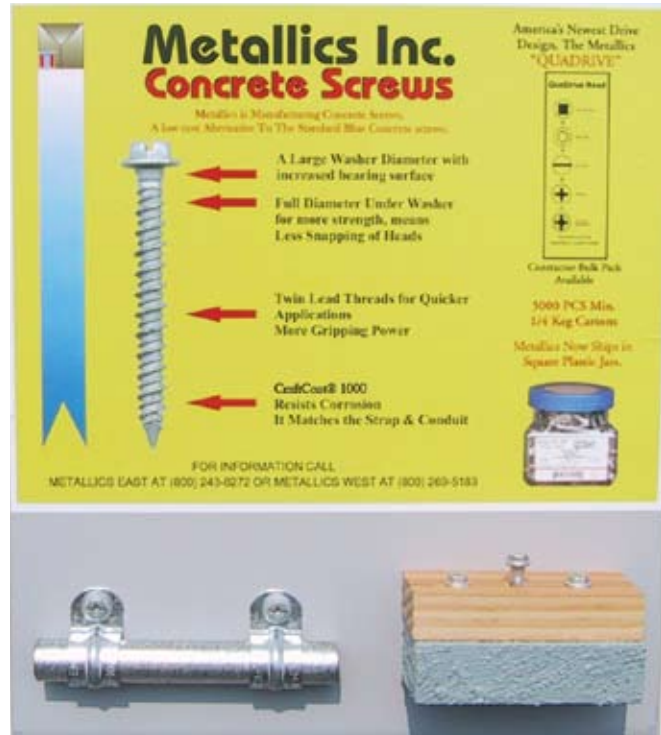

SHELF LABELS FOR OUR POINT OF PURCHASE DISPLAYS

Can be moved easily as you adjust your stock, AND THEY ARE BAR CODED!

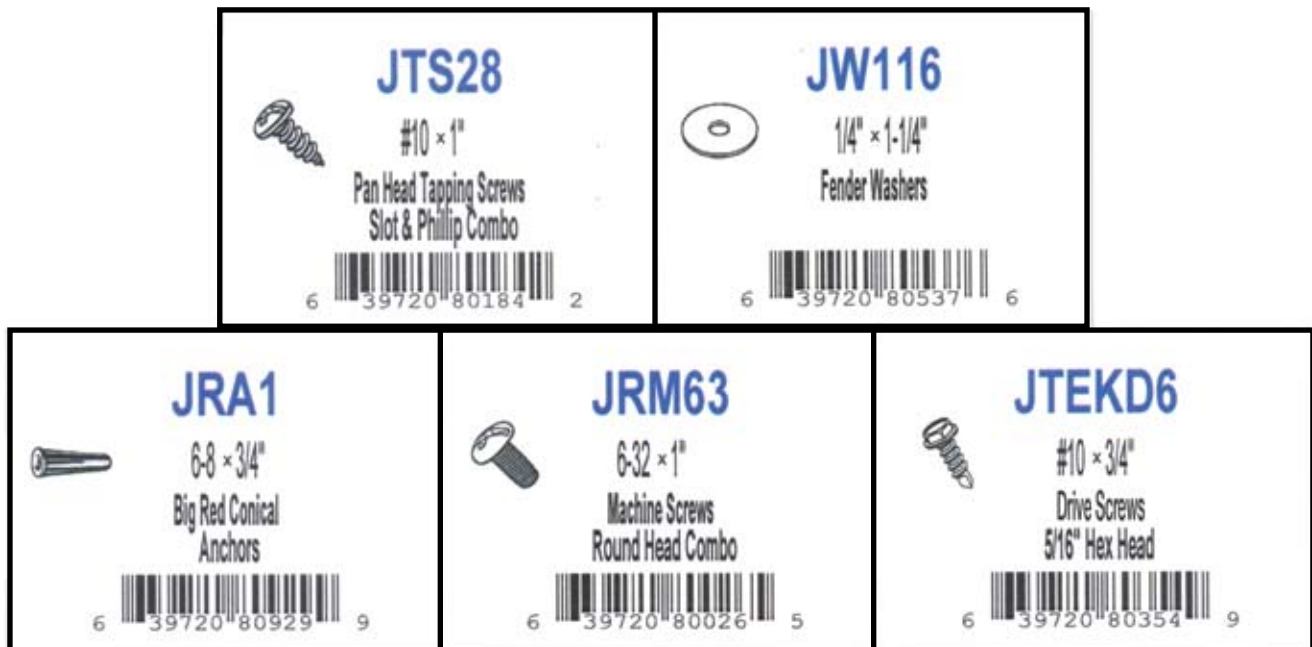

THE LOZIER® RACK SYSTEMS

Many of America's Distributors are using the Lozier® Rack Systems and we at Metallics have incorporated this system into our Point of Purchase Display offering.

- Lozier® shelves are adjustable, flat and canted.
- Metallics has designed dividers for separating product.
- **Call us to help with your Planogram**
- Dimensions: 54" (H) x 22" (D)

Lozier® 8' (W) #EFC8



Lozier® 4' (W) #EFC4



Lozier® 3' (W) #EFC3



Metallics Fastener Center Display Cards



Ceiling Dangler 10" x 13" *Tri Fold*

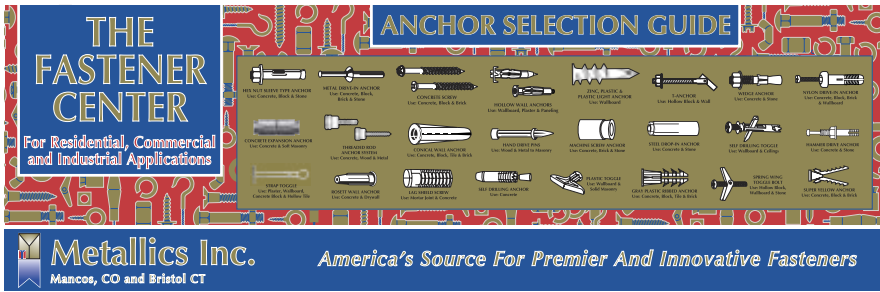

3 ft. Gondola Display
36" x 11.625"



4 ft. Gondola Display Left Side 24" x 11.625"

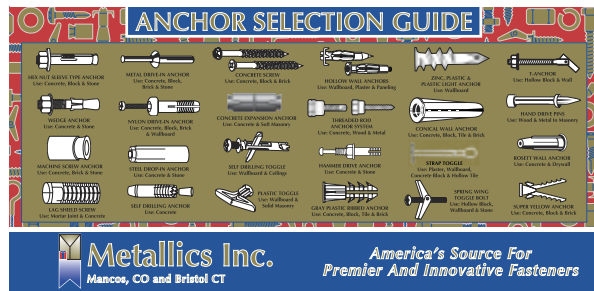

4 ft. Gondola Display Right Side 24" x 11.625"



Free Standing Display 32.5" x 5"
EFC1

THE POWER BIT DISPLAY - PBV1

IN THE SPRING-FED RACK

RECOMMENDED CONTENTS OF PBV1 10 each of the following

INSERT BIT DISPLAY

1. **000P1X** #1 Phillips Insert Bit
2. **000P2X** #2 Phillips Insert Bit
3. **000P3X** #3 Phillips Insert Bit
4. **000R2X** #2 Square Drive Insert Bit
5. **0016X** 6-8 Slotted Insert Bit
6. **0018X** 8-10 Slotted Insert Bit
7. **00110X** 10-12 Slotted Insert Bit

POWER BIT DISPLAY

8. **100P1X** #1 Phillips Power Bit
9. **100P2X** #2 Phillips Power Bit
10. **100P3X** #3 Phillips Power Bit
11. **1008X** 8-10 Slotted Power Bit

12. **10010X** 10-12 Slotted Power Bit
13. **P2P2** #3 Phillips Double Ended Bit
14. **P2S8** #2 Phillips Slotted Dbl Ended Bit

NUT SETTER DISPLAY

15. **MT208** 1/4" Drill Chuck Nut Setter
16. **MT208L** 1/4" Drill Chuck Long Nut Setter
17. **MT210** 5/16" Drill Chuck Nut Setter
18. **MT210L** 5/16" Drill Chuck Long Nut Setter
19. **MT212** 3/8" Drill Chuck Nut Setter
20. **MT212L** 3/8" Drill Chuck Long Nut Setter
21. **M10** Hex Insert Bit Holder



- A select group of the fastest moving bits in point-of-purchase, packaged in Visual Display Packs.
- A unique new spring-fed display.
- Display can be purchased in a combination of one to three layers (7, 14 or 21 individual items).
- Holds up to ten Visual Packs per section.
- Fits pegboard or Lozier® Display.

**CAN COMPRISE ANY
COMBINATION OF BITS.**

THE METALLICS POWER BIT DISPLAY

STOCK NO.	UPC NO.	DIMENSIONS /DESCRIPTION
PBV1	37105	Each shelf unit is 22" W x 10" Deep x 5" H

POINT OF PURCHASE DISPLAYS



HIGH-SPEED DRILL COUNTER DISPLAY

An attractive, compact "Point of Purchase" Display, 15" wide X 13" high X 8" deep. Improve sales by providing speedy selection of your complete range of high-speed drills.

- Strong metal construction
- Transparent hinged cover with lock prevents theft

Display contains standard package quantities of all 29 HSD fractional drill sizes in jobber lengths, standard shank, a total of 210 drills.
SEE PAGE 192

FRACTIONAL DRILLS FOR HSCD1 COUNTER DISPLAY

STOCK NO.	UPC NO.	DESCRIPTION	WT. PER EACH	STD. PKG.
HSCD1	24515	Display and 210 Assorted HSD drills	23.60	1 Display

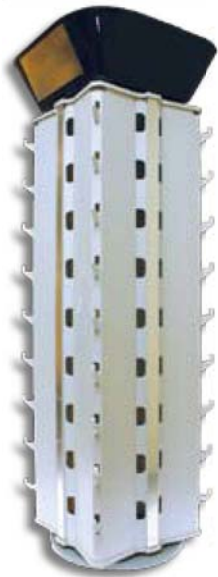

PROTECTIVE EYEWEAR COUNTER TOP CAROUSEL DISPLAY - SGD36

FREE
with first purchase of
36 or more pairs of
glasses.

- Easy-to-clean molded plastic display unit.
- Holds 36 pairs of glasses.
- Two-mirrored unit.
- Rotates 360 degrees.

WARNING: USE OF THIS DISPLAY
COULD CAUSE SERIOUS ENVY WITH
YOUR DISTRIBUTOR COMPETITION!

STOCK NO.	UPC NO.	DIMENSIONS/ DESCRIPTION
THE METALLICS PROTECTIVE EYEWEAR DISPLAY		
SGD36	71220	10" Diameter x 32" High



Avanti Screw Incorporated

Serving America's Fastener Distributors

CAPABILITIES LIST

PLANT SIZE:	100,000 Square Feet
LOCATION:	Bristol, Connecticut
EQUIPMENT:	27 Hi-Speed Cold Headers 8 Burr-Free Screw Slotters 3 Shank Slotters 2 Pointers 14 High Speed Thread Rollers

ADDITIONAL PLANT INFORMATION: Modern shipping facilities utilizing digital scale counting machines. In house packaging facilities – boxing, sorting, bagging. All material boxed, palletized & labeled with your needs in mind for domestic or export shipping.

SECONDARY WORK: All plating & heat treating is done on the outside and certified for your guarantee.

INFORMATION SYSTEMS: Our facility has new and upgraded Technology to meet your customers specific requirements.

We Make Screws It's that Simple

P.O. Box 1600 • 231 Cross Street
Bristol, CT 06011-1600
Tel: 800-984-8945 • Fax: 800-984-8946

MANUFACTURING

THE QUADRIVE SYSTEM

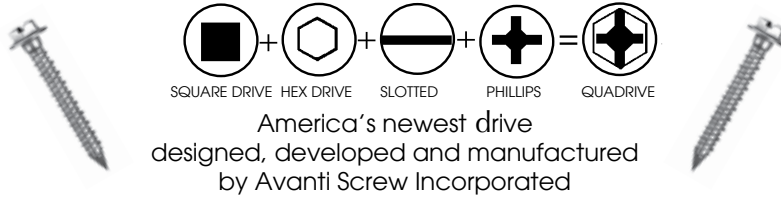

QUADRIVE CONCRETE SCREW



ASK FOR OUR STOCK LIST...

CraftCoat® 1000 Coating

SCREWS FOR PLASTICS

Screws below available in type 'A' Gimlet point and can be shank slotted on request

SUPRA-PLAS



TWIN-PLAS



H/L-PLAS



What makes Avanti Special?

OUR SERVICES

TRU-TAP



Precision Tri-Lobular thread rolling screws that roll-form their mating threads in unthreaded pilot holes in various materials.

- We will ship direct to you or your customer
 - Inquire about our **Distributor Confidentiality Contract**
 - NOTE: Ask about \$\$ **Our Cash Distributor Purchase Incentives** \$\$
- Private labeling capabilities are available to your specifications

We can ship with your Label

Your Logo here		00/00/0000	
Your Name	Any Name		
Your Street	Any Street		
Your City, State, Zip	Any City, State, Zip		
Customer # Sample	Customer P.O.#	Any PO number	
Order Number: 123456789			
Part Number:	Lot Number:		
Customer Part Number: 2-56 X 3/16 SPEC PAN HEAD SLOT U/C M/S			
Gross Weight:	Net Weight:	Pieces:	

Labels: Human Readable or Bar Coded

 CUST PART NUMBER		your logo here	
Rev Level 999	Date Produced	Your Name Your Street Your City, State, Zip	
Quantity 25000	Unit/Measure EA	Customer your customer name your customer address your cust city st zip	
PO Number		Our Part Number:	
		LOT customer part description	

Product Packaging
now available upon request.



Our facility now offers
State of the Art
Optical Sorting

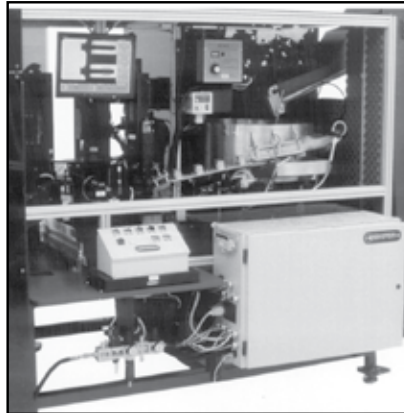

Now Proudly Featuring
Hard Body Packing
to you or your
Customer's Dock



CraftCoat® is a registered trademark of Donham Craft, Inc.

FASTENER REFERENCE GUIDE

METALLICS

AMERICA'S SOURCE FOR PREMIER AND INNOVATIVE FASTENERS

Fastener Reference Guide

Measuring Threaded Fasteners (length)

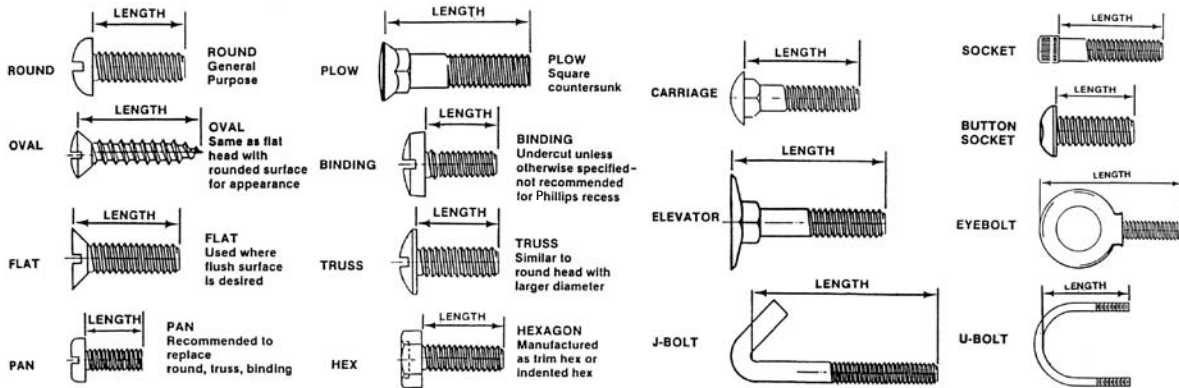

Fastener Identifier (D=Diameter)

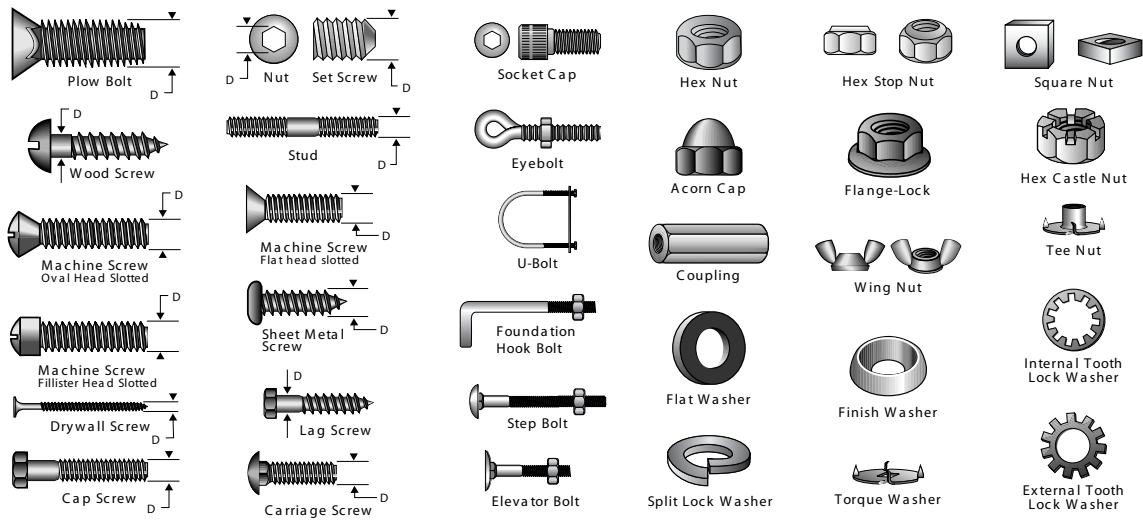

Head Styles

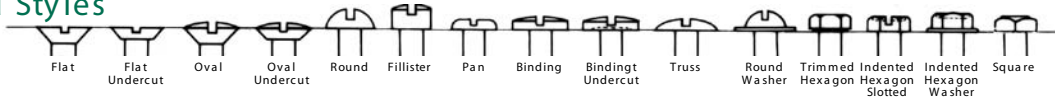

Measuring Threads

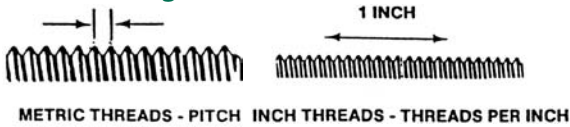

Head Markings of Fasteners

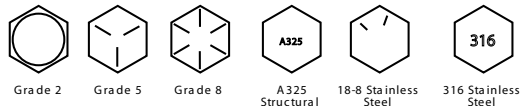

Driver Styles

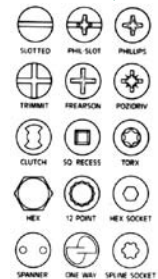

To Select Phillips Driver Style

SCREW TYPE	SCREW DIAMETER & HEAD STYLE			BIT or DRIVER SIZE
	OVAL PAN & FLAT	ROUND & FILLISTER	TRUSS & BRAZIER	
Machine & Tapping Screws	0 & 1	0 & 1	0 & 1	0
	2 thru 4	2 thru 4	2 thru 5	1
	5 thru 10	5 thru 10	6 thru 10	2
	12 thru 1/4	12 thru 5/16	12 thru 1/4	3
Wood Screws	5/16 thru 1/2	3/8 thru 1/2	5/16 thru 1/2	4
	0 & 1	0 & 1	0 & 1	0
	2 thru 4	2 thru 4	2 thru 5	1
	5 thru 9	5 thru 10	6 thru 10	2
	10 thru 16	11 thru 16	12 thru 16	3
	18 thru 24	18 thru 24	18 thru 24	4

#990030

QUICK REFERENCE PRODUCT INDEX

RED = NEW ITEMS

00010B 185	100R1B 185	1407 92	1532 88	2530F 98	7562 97
0006B 185	100R2B 185	1407ST 92,189	1533 88	30001 187	75KOS 167
0008B 185	100R3B 185	1408 92	1534 88	30005 187	75KOSG 167
000P1B 185	1024CT 190	1408ST 92,189	1535 88	300KOS 167	832CT 190
000P1X 184	1032CT 190	1409 92	1536 88	300KOSG 167	
000P2B 185	1106 105	1409ST 92,189	1537 88	306MS0 198	A
000P2X 184	1107 105	140P1B 185	1538 88	306MS1 198	AA68 110
000P3B 185	1108 105	140P2B 185	1539 88	306MS2 198	AKK1532 133
000P3X 184	110R2B 185	140P3B 185	1540 88	306MS3 198	AKK3764 133
000R1B 185	1110 105	140R1B 185	1541 88	306MS4 198	AKK516 133
000R2B 185	1111 105	140R2B 185	1542 88	3114 97	AAK68 110
000R2X 184	1114 105	140R3B 185	1543 88	3114SS 98	AKK78 133
000R3B 185	1115 105	1415F 107	1544 88	3124 97	AL1 195
00110B 185	1116 105	1415R 107	1545 88	3124SS 98	AL1116 195
00110X 184	1201 93	1415T 107	1546 88	3161F 107	AL112 195
0014B 185	1202 93	141F 107	1547 88	3161R 107	AL114 195
0016B 185	1203 93	141R 107	1548 88	3161T 107	AL118 195
0016X 184	1204 93	141T 107	1549 88	32701 188	AL1316 195
0018B 185	1205 93	1420CT 190	1550 88	35049 188	AL138 195
0018X 184	1206 93	142F 107	1551 88	350KOS 167	AL1516 195
001P2B 185	1207 93	142R 107	1552 88	3717 97	AL34 195
00HP18B 48	1208 93	142T 107	1553 88	3717SS 98	AL58 195
00HP32B 48	1209 93	1434F 107	1554 88	3730 97	AL78 195
00SP10B 48,185	1210 93	1434T 107	1560 88	3732 97	AL916 195
00SP12B 48	1211 93	14SOT 92	1561 88	3730SS 98	ALS14 144
00SP14B 48	1212 93	1501 87	1562 88	3816CT 190	ALS15 144
00SP6B 48,165,185	1213CT 190	1502 87	1563 88	38SOT 92	ALSD 144
00SP8B 48,165,185	12510B 185	1503 87	1564 88	400KOS 167	AS1 195
00TP10 48	1256B 185	1504 87	1565 88	400KOSG 167	AS1116 195
00TP15 48	1258B 185	1505 87	1566 88	440CT 190	AS112 195
00TP20 48	125KOS 167	1506 87	1590 89	5022 97	AS114 195
00TP25 48	125KOSG 167	1507 87	1591910 83	5022SS 98	AS118 195
00TP27 48	125P1B 185	1508 87	1592 89	5026 97	AS1316 195
00TP30 48	125P2B 185	1509 87	1592SS 89	5026SS 98	AS138 195
1001 91	125P3B 185	150KOS 167	1593 89	5030SS 98	AS1516 195
10010B 185	125R1B 185	150KOSG 167	1593SS 89	5040 97	AS34 195
10010X 184	125R2B 185	1511 87	1594 89	5040SS 98	AS58 195
1002 91	125R3B 185	1512 87	1595 89	5060 97	AS78 195
1003 91	12SOT 92	1513 87	1596 89	50KOS 167	AS916 195
1004 91	1302 94	1513910 83	160R2B 185	50KOSG 167	ASP 119
1004B 185	1303 94	1514 87	160R3B 185	516CT 190	ASPM 119
1005 91	1305 94	1516 88	180R2B 185	6222 97	AT250 218
1006 91	1306 94	1517 88	200KOS 167	6230SS 98	AT350 218
1006B 185	1307 94	1518 88	200KOSG 167	6242 97	ATEK1 144
1007 91	1308 94	1519 88	250KOS 167	6242SS 98	AW34BLK 217
1008B 185	1401 92	1520 88	250KOSG 167	6256 97	B
1008X 184	1401ST 92	1521 88	2505 97	632CT 190	BA1 105
100KOS 167	1402 92	1522 88	2512R 98	6721 91	BA15 105
100KOSG 167	1402ST 92,189	1523 88	2513 97	6726 91	BA2 105
100P1B 185	1403 92	1524 88	2513SS 98	681032 159,183	BA3 105
100P1X 184	1403ST 92,189	1525 88	2520F 98	7524 97	BBH1 74
100P2B 185	1404 92	1528 88	2520R 98	7524SS 98	BBH11 74
100P2X 184	1404ST 92,189	1529 88	2522 97	7542 97	BBH13 74
100P3B 185	1406 92	1530 88	2522SS 98	7542SS 98	BBH14 74
100P3X 184	1406ST 92,189	1531 88	2526R 98	7554SS 98	

QUICK REFERENCE PRODUCT INDEX

RED = NEW ITEM

BBH15 74	BBH87 75	BHC25 67	BHC83 68	BLS31 78	BTJ3 138
BBH16 74	BBH88 74	BHC26 67	BHC85 68	BLS32 78	BTJ4 138
BBH17 74	BBH89 75	BHC27 67	BHC86 68	BLS32SS..... 79	BTJ6G 138
BBH18 74	BBH90 75	BHC28 67	BHC88 67	BLS33 78	BTJK516 138
BBH19 74	BC14.....137	BHC29 67	BHC9 67	BLS34 78	BTT1 199
BBH2 74	BC38.....137	BHC3 67	BHC93 68	BLS36 78	BTT11 199
BBH23 74	BCA1230 102	BHC30 67	BHC94 68	BLS36SS..... 79	BTT12 199
BBH24 74	BCA1240 102	BHC31 68	BHC95 68	BLS37 78	BTT13 199
BBH25 74	BCA1254 102	BHC32 67	BHC96 68	BLS38 78	BTT14 199
BBH26 74	BCS3444 102	BHC33 68	BHC97 68	BLS39 78	BTT15 199
BBH27 74	BCS3560 102	BHC33G 68	BHC98 68	BLS4 78	BTT16 199
BBH28 74	BCA5834 102	BHC34 68	BHC99 68	BLS4SS..... 79	BTT 199
BBH29 74	BCA5850 102	BHC35 68	BHD10 196	BLS40 78	BTT2 199
BBH3 74	BCAR12 102	BHC36 68	BHD11 196	BLS41 78	BTT23 199
BBH30 74	BCAR34 102	BHC36G 68	BHD12 196	BLS41G 79	BTT25 199
BBH32 74	BCAR58 102	BHC37 68	BHD5 196	BLS42 78	BTT26 199
BBH33 74	BE1418 197	BHC38 68	BHD6 196	BLS44 78	BTT4 199
BBH34 74	BE5618 197	BHC39 68	BHD7 196	BLS45 78	BTT5 199
BBH35 74	BE7612 197,198	BHC4 67	BHD8 196	BLS46 78	BTT6 199
BBH36 74	BE7618 197,198	BHC41 68	BHD9 196	BLS48 78	BTT7 199
BBH37 74	BE7624 197	BHC42 67	BLS1 78	BLS49 78	BTT8 199
BBH38 74	BFR10 199	BHC43 67	BLS1SS 79	BLS5 78	BTT9 199
BBH39 75	BFR11 199	BHC44 67	BLS1G 79	BLS50 78	BWSS12 62
BBH4 74	BFR12 199	BHC45 67	BLS10 78	BLS51 78	BWSS14 62
BBH41 75	BFR13 199	BHC45G 68	BLS11 78	BLS52 78	BWSS34 62
BBH42 74	BFR14 199	BHC46 68	BLS12 78	BLS53 78	BWSS38 62
BBH43 74	BFR15 199	BHC46G 68	BLS12SS..... 79	BLS6 78	
BBH44 74	BFR16 199	BHC47 68	BLS13 78	BLS8 78	C
BBH45 74	BFR17 199	BHC48 67	BLS13SS..... 79	BLS88 78	CAS5051 173
BBH46 74	BFR18 199	BHC49 67	BLS14 78	BLW12 65	CB1 77
BBH47 74	BFR19 199	BHC5 67	BLS14SS..... 79	BLW14 64	CB101SS..... 77
BBH48 74	BFR20 199	BHC50 67	BLS15 78	BLW178 64	CB1SS 77
BBH5 74	BFR21 199	BHC53 67	BLS16 78	BLW34 65	CB2 77
BBH51 74	BFRB12 198	BHC54 67	BLS18 78	BLW38 65	CB2SS 77
BBH54 74	BFRB14 198	BHC58 67	BLS2 78	BLW516 64	CB21 77
BBH56 74	BFRB16 198	BHC59 67	BLS2SS 79	BLW58 65	CB23 77
BBH59 74	BFRB20 198	BHC6 67	BLS2G 79	BLW6 64	CB23SS 77
BBH6 74	BFRB21 198	BHC60 67	BLS20 78	BLW8 64	CB24 77
BBH61 74	BHC1 67	BHC61 67	BLS21 78	BR001 226	CB24SS 77
BBH64 74	BHC10 67	BHC63 67	BLS21SS..... 79	BR005 226	CB25 77
BBH65 74	BHC101 67	BHC64 68	BLS21G 79	BR025 226	CB26 77
BBH69 75	BHC1G 68	BHC65 68	BLS22 78	BT3ER 218	CB26SS 77
BBH7 74	BHC11 67	BHC66 68	BLS22G 79	BT3EY 218	CB28 77
BBH71 75	BHC12 67	BHC67 68	BLS23SS..... 79	BT3FO 218	CB29 77
BBH73 75	BHC13 67	BHC68 68	BLS24 78	BT3HVR 218	CB3 77
BBH75 75	BHC14 67	BHC69 68	BLS25 78	BT3TPO 218	CB30 77
BBH76 75	BHC15 67	BHC7 67	BLS25G 79	BT3TVO 218	CB31 77
BBH77 75	BHC16 67	BHC71 68	BLS26 78	BT3UY 218	CB33 77
BBH78 75	BHC2 67	BHC73 68	BLS27 78	BT6ER 219	CB33G 77
BBH79 75	BHC20 67	BHC75 68	BLS27G 79	BT6EY 219	CB34 77
BBH8 74	BHC22 67	BHC76 68	BLS28 78	BT6FO 219	CB35 77
BBH80 75	BHC2G 68	BHC7612 68	BLS29 78	BT6HVR 219	CB36 77
BBH81 74	BHC21 68	BHC77 68	BLS29 78	BT6TPO 219	CB4 77
BBH82 75	BHC23 67	BHC79 68	BLS3 78	BT6TVO 219	CB40 77
BBH84 75	BHC23G 68	BHC8 67	BLS30 78	BT6UY 219	CB42 77
BBH85 75	BHC24 67	BHC80 68	BLS30G 79	BTJ1 138	CB42SS 77
BBH86 75	BHC24G 68	BHC81 68	BLS30SS..... 79	BTJ2 138	CB55 77

• When Searching Stock # Drop "J"

QUICK REFERENCE PRODUCT INDEX

RED = NEW ITEMS

CB55SS 77	CPD4V 43	CT2 127	DIA34 93	DS182..... 24	DWS10B 35
CB56 77	CPD5 43	CT2UVB 127	DIA34T 93	DS182SS 25	DWS10C 35
CB56SS 77	CPD5M 43	CT2B 127	DIA38 93	DS183..... 24	DWS3B 35
CB6 77	CPR5V 43	CT3 127	DIA38SS 93	DS183SS..... 25	DWS3C 35
CB7SS 77	CPT1 107	CT3YVB 127	DIA38T 93,189	DS184..... 24	DWS3M 35
CB8 77	CPT2 107	CT3B 127	DIA381SS 93	DS184SS 25	DWS4B 35
CB9..... 77	CPT3 107	CT3CY 219	DIA58 93	DS185..... 24	DWS4C 35
CCS50..... 176	CS50 176	CT3D 219	DIA58SS 93	DS185SS..... 25	DWS4M 35
CCS50P 176	CS50P 176	CT3DNY 219	DIA58T 93,189	DS186SS 25	DWS5B 35
CCS75 176	CS75 176	CT3HVV 219	DLC1 142	DS187 25	DWS5C 35
CCS75P 176	CS75P 176	CT3KOY 219	DLC1S 142	DS170SS 25	DWS5M 35
CD1 87,191	CSF1F 84	CT3OTY 219	DLC2 142	DS177SS 25	DWS6B 35
CD2 87,191	CSF10F 84	CT4 127	DLC2/0 142	DS187SS 25	DWS6C 35
CD7 87,191	CSF2F 84	CT4B 127	DLC3 142	DS80..... 24	DWS6M 35
CD3 87,191	CSF2SS 84	CT4UV 127	DLC3S 142	DS81 24	DWS7B 35
CD5 87,191	CSF20F 84	CT4UVB 127	DLC4 142	DS84 24	DWS7C 35
CD6 87,191	CSF3F 84	CT5 127	DP1 103	DS85 25	DWS7M 35
CD7 87,191	CSF30F 84	CT5B 127	DP2 103	DSK10 51	DWS9B 35
CD8 87,191	CSF4F 84	CT5UV 127	DP3 103	DSK12 51	DWS9C 35
CDS1 165	CSF4SS 84	CT5UVB 127	DP4 103	DSK8 51	DWS9M 35
CDS2 165	CSF40F 84	CT6 127	DP5 103	DT1032 195	DWSK1 37
CDS3 165	CSF5F 84	CT6B 127	DP6 103	DT1213 195	DWSR1B 41
CDS5 166	CSF50F 84	CT6UV 127	DP7 103	DT1420 195	DWSR1C 41
CDS6 166	CSF6F 84	CT6UVB 127	DP8 103	DT260..... 217	DWSR1M 41
CG1 191,215	CSF60F 84	CTA1 128	DS143 25	DT3816 197	DWSR3B 41
CG20 158	CSF70F 84	CTAH11S 126	DS150 24	DT3ER 219	DWSR3C 41
CG20500 158	CSH1F 84	CTAH14S 126	DS151 24	DT3FO 219	DWSR3M 41
CG32 191,215	CSH10F 83	CTAH7LP 126	DS152 24	DT3HVR 219	DWSR4B 41
CMT1 218	CSH10SS 83	CTAH7MH 126	DS153 24	DT3TPO 219	DWSR4C 41
CN160 58	CSH14RF 86	CTAH7S 126	DS154 24	DT632 195	DWSR4M 41
CN163 58	CSH10F 83	CTUVA1 128	DS155 24	DT6ER 219	DWSR5B 41
CN163SS 58	CSH20SS 83	CW10 62	DS156 24	DT6FO 219	DWSR5C 41
CN164 58	CSH2F 83	CW11 62	DS157 24	DT6HVR 219	DWSR5M 41
CN164SS 58	CSH20F 83	CW12 62	DS158 24	DT6TPO 219	DWSR6B 41
CN165 58	CSH3F 83	CW12SS 62	DS159 24	DT832 195	DWSR6C 41
CN165SS 58	CSH30F 83	CW14 62	DS160 24	DWC1C 37	DWSR6M 41
CNN1024 160	CSH316RF 86	CWGC1 221	DS161 24	DWC1M 37	DWSR7B 41
CNN1024K 161	CSH4F 83	CWGS1 221	DS162 24	DWC10B 37	DWSR7C 41
CNN1032 160	CSH40F 83	D	DS162SS 25	DWC3B 37	DWSR7M 41
CNN1032K 161	CSH5F 83	DCS1 176	DS163 24	DWC3C 37	DWSR9B 41
CNN1224 160	CSH50F 83	DCS1B 176	DS164 24	DWC3M 37	DWSR9C 41
CNN1224K 161	CSH6F 83	DEA12 94	DS165 24	DWC4B 37	DWSR9M 41
COHB1 220	CSH60F 83	DEA14 94	DS166 24	DWC4C 37	E
CP1A 177	CSH70F 83	DEA34 94	DS168 24	DWC4M 37	EB1 138
CP3S 177	CST100 175	DEA38 94	DS169 24	DWC5B 37	EB1SS 139
CP4S 177	CST100I 175	DEA516 94	DS170 28	DWC5C 37	EB10 139
CPD1 43	CST100P 175	DEA58 94	DS171 25	DWC5M 37	EB11 139
CPD1M 43	CST300 175	DHS5 194	DS172 25	DWC6B 37	EB12 139
CPD1V 43	CST350 175	DIA12 93	DS173 25	DWC6C 37	EB12 139
CPD2 43	CST350P 175	DIA121SS 93	DS174 25	DWC7B 37	EB124 139
CPD2M 43	CST40I 175	DIA12SS 93	DS175 25	DWC7C 37	EB124SS 139
CPD2V 43	CT1 127	DIA12T 93,189	DS176 25	DWC9B 37	EB13 139
CPD3 43	CT1B 127	DIA14 93	DS177 25	DWC9C 37	EB13SS 139
CPD3M 43	CT1HID 127	DIA141SS 93	DS178 25	DWC9M 37	EB14 139
CPD3V 43	CT1UV 127	DIA14SS 93	DS179 25	DWS1B 35	EB14SS 139
CPD4 43	CT1UVB 127	DIA14T 93,189	DS180 24	DWS1C 35	EB15 139
CPD4M 43			DS181 24	DWS1M 35	EB16 139

• When Searching Stock # Drop "J"

QUICK REFERENCE PRODUCT INDEX

RED = NEW ITEMS

EB17 139	FM150 16	FMP101SS 18	FWP24 34	G5HC33 69	G8HC23 71
EB2 138	FM17 15	FMP103SS 18	FWP25 34	G5HC34 69	G8HC231 71
EB3 138	FM18 16	FMP140 17	FWP27 34	G5HC35 70	G8HC2334 71
EB3SS 139	FM19 16	FMP142 17	FWP28 34	G5HC36 70	G8HC24 71
EB32 139	FM194 16	FMP47 17	FWP28SS 34	G5HC37 70	G8HC25 71
EB33 139	FM20 16	FMP48SS 18	FWP29 34	G5HC38 70	G8HC26 71
EB4 138	FM22 16	FMP49SS 18	FWP29SS 34	G5HC4 69	G8HC28 71
EB5 139	FM32 16	FMP51SS 18	FWP30 34	G5HC41 69	G8HC3 70
EB6 138	FM33 16	FMP63 17	FWP31 34	G5HC42 69	G8HC33 71
EB8 139	FM33SS 17	FMP63SS 18	FWP32 34	G5HC43 69	G8HC34 71
EB9 138	FM35 16	FMP75 17	FWP33 34	G5HC44 69	G8HC343 71
EC44 144	FM36 16	FMP80 17	FWP34 34	G5HC45 69	G8HC34312 71
EFC1 188	FM42 16	FMP80SS 18	FWP35 34	G5HC46 69	G8HC35 71
EFC3 187	FM48 16	FMP81 17	FWP36 34	G5HC47 69	G8HC37 71
EFC4 187	FM48SS 17	FMP81SS 18	FWP39 34	G5HC49 69	G8HC38 71
EFC8 187	FM50 16	FMP82 17	FWP40 34	G5HC5 69	G8HC4 70
ELR2 105	FM51 16	FMP83 17	FWP41 34	G5HC59 69	G8HC42 70
ELR3 105	FM63 15	FMP84 17	FWP42 34	G5HC6 69	G8HC43 70
EVBK100 49	FM65 16	FMP85 17	FWP43 34	G5HC6 69	G8HC46 71
EZSTPL5C 172	FM66 16	FMP86 17	FWP44 34	G5HC62 70	G8HC47 71
EZSTPL1C 172	FM68 15	FMP87 17	FWP45 34	G5HC63 70	G8HC48 71
EZSTPL2M 172	FM69 16	FMP88 17	FWP46 34	G5HC64 69	G8HC5 70
EZT1 122	FM72 16	FMP89 17	FWP47 34	G5HC66 70	G8HC583 71
EZT1J 122	FM78 16	FMP98 17	FWP48 34	G5HC67 70	G8HC58312 71
EZT1K 122	FM80 15	FRT250 218	FWP50 34	G5HC68 70	G8HC584 71
F	FM81 15	FSD141 97	FWP61 34	G5HC7 69	G8HC58412 71
FA1 54	FM82 15	FSD142 97	FWP62 34	G5HC70 70	G8HC6 70
FAK100 223	FM82SS 17	FSD1421 97	FWP65 34	G5HC72 70	G8HC76112 71
FAK170 224	FM83 15	FSD143 97	FWP67 34	G5HC73 70	G8HC76114 71
FD6234 96	FM83SS 17	FSD1431 97	FWP9 34	G5HC74 70	G8HC8 70
FD8234 96	FM84 16	FSD144 97	FWPB19 34	G5HC75 70	G8N163 55
FHC1 142	FM84SS 17	FST100 175	G	G5HC76 70	G8N164 55
FHK1 143	FM85 16	FST100I 175	G5HC1 69	G5HC78 70	G8N165 55
FHK2 143	FM85SS 17	FST300 175	G5HC8 69	G5HC80 70	G8N166 55
FM100 16	FM86 16	FST350 175	G5HC11 69	G5HC81 69	G8N167 55
FM100SS 17	FM86SS 17	FST40 175	G5HC119 69	G5HC82 70	G8N168 55
FM101 16	FM87 16	FST40I 175	G5HC12 69	G5HC84 70	G8N169 55
FM101SS 17	FM87SS 17	FT34BLK 217	G5HC120 69	G5HC88 69	G8WW80 62
FM102 16	FM88 16	FTHM14 132	G5HC121 69	G5N163 55	G8WW81 62
FM102SS 17	FM89 16	FTHR01 132	G5HC122 69	G5N164 55	G8WW82 62
FM103 16	FM90 16	FTHS01 130	G5HC123 69	G5N165 55	G8WW83 62
FM104 16	FM91 16	FWK10 64	G5HC13 69	G5N166 55	G8WW84 62
FM104SS 17	FM92 16	FWP10 34	G5HC14 69	G5N167 55	G8WW85 62
FM105 16	FM92SS 17	FWP120 34	G5HC15 69	G5N168 55	G8WW86 62
FM113 16	FM93 16	FWP11 34	G5HC16 69	G5N170 55	G8WW87 62
FM116 16	FM94 16	FWP12 34	G5HC18 69	G8HC1 70	GA1 105
FM117 16	FM95 16	FWP13 34	G5HC2 69	G8HC114 70	GA2 105
FM123 16	FM96 16	FWP14 34	G5HC20 69	G8HC13 70	GA3 105
FM127 16	FM98 16	FWP18 34	G5HC21 69	G8HC14 70	GDK13 194
FM128 16	FM99 16	FWP18SS 34	G5HC23 69	G8HC15 70	GDS0 36
FM130 16	FM99SS 17	FWP19 34	G5HC24 69	G8HC16 70	GDS1 36
FM132 16	FMB88 17	FWP19SS 34	G5HC25 69	G8HC17 70	GDS1M 36
FM135 16	FMB89 17	FWP20 34	G5HC26 69	G8HC2 70	GDS1V 36
FM140 15	FMK632 53	FWP21 34	G5HC27 69	G8HC20 70	GDS2 36
FM142 15	FMK832 53	FWP22 34	G5HC28 69	G8HC214 71	GDS2M 36
FM144 15	FMKP632 18,53	FWP22SS 34	G5HC29 69		GDS2V 36
	FMP100 17	FWP23 34	G5HC3 69		GDS3 36

• When Searching Stock # Drop "J"

QUICK REFERENCE PRODUCT INDEX

RED = NEW ITEMS

GDS3M 36	HMC24SS 131	HTB33 76	IST3 177	LCSX3850 86	M591189BL 178
GDS3V 36	HMC32SS 131	HTB34 76	IST5 177	LCY12 189	M721168 178
GDS4 36	HMC36SS 131	HTB35 76	IST6 177	LLGC1 222	M721189 178
GDS4M 36	HMC40SS 131	HTB38 75	IST7 177	LLGM1 222	M7510S 179
GDS4V 36	HMC6SS 131	HTB39 75	IT1000 84,191	LLGS1 222	M75105 179
GDS5 36	HMC88SS 131	HTB4 75	ITSLEVE ... 84,191	LWI3 65	M7514 179
GDS5M 36	HR750 166	HTB42 75		LWI4 65	M7514S 179
GDS5V 36	HR760 166	HTB43 75	J	LWI5 65	MA6 106
GDS6 36	HR770 166	HTB44 75	JC10 142	LWI6 65	MAF5 106
GDS6M 36	HR780 166	HTB45 76	JC10CBS 142	LWI7 65	MAF6 106
GDS6V 36	HSCB85 208	HTB46 76	JC10T 142	LWI8 65	MAF8 106
GDS7 36	HSCD1 193	HTB47 76	JC10SS 142	LWI9 65	MBA25 125
GDS7M 36	HSD1 192	HTB48 76	JC12 142	LWIX4SS 65	MBA50 125
GDS7V 36	HSD10 192	HTB49 75	JC12C 142	LWIX5SS 65	MBB25 125
GDSK1 51	HSD11 192	HTB5 75	JC12CB 142	LW153 64	MBB50 125
GS20 155	HSD12 192	HTB54 75	JC12CSS 142	LW167 64	MBC12 137
GS20500 155	HSD13 192	HTB55 75	JC12M 142	LW169 64	MBC14 137
GSH19 155	HSD14 192	HTB56 75	JC12SS 142	LW170 64	MBC38 137
GSH20 155	HSD15 192	HTB59 76	JC14 142	LW171 64	MBR100WS ... 168
GSH20500 155	HSD16 192	HTB6 75	JC16 142	LW172 64	MBR125 168
GSH21 156	HSD16R 192	HTB60 76	JC16SS 142	LW172G 65	MBR150 168
GSH21500 156	HSD17 192	HTB61 75	JC18CB 142	LW173 64	MBR150WS 168
GSH22 156	HSD18 192	HTB64 76	JC18SS 142	LW174 64	MBR200 168
GSH22500 156	HSD19 192	HTB71 76		LW174G 65	MBR200WS 168
GSH23 155	HSD2 192	HTB72 76	K	LW175 64	MCP100 205
GSH23500 155	HSD20 192	HTB73 76	KF12 209	LW175G 65	MCPM5 205
	HSD20R 192	HTB81 76	KF24 209	LW176 64	MCPXL 205
H	HSD21 192	HTB82 75	KKC12 132	LW176G 65	MCS26 186
HAB10 143	HSD22 192	HTB88 75	KKC14 132	LW177 64	MCS46 186
HAB11 143	HSD23 192	HTB89 76	KKC34 132	LW178 64	MCT10 127
HAB12 143	HSD24 192	HTB90 75	KKC38 132	LWN7 65	MCT12 127
HAB13 143	HSD24R 192	HTB93 76	KKU12 133	LWN7 65	MCT13 127
HAB9 143	HSD25 192	HTB94 76	KKU14 133	LWX1 65	MCT14 127
HABD10 143	HSD26 192	HW12 135	KKU34 133	LWX12 65	MCT15BLK 127
HABD12 143	HSD27 192	HW12234 101	KKU38 133	LWX3 65	MDR114 168
HAM3 104,190	HSD28 192	HW12312 101	KLB12 134	LWX3SS 65	MDR12 168
HCT19 127	HSD28R 192	HW12434 101	KLB38 134	LWX4 65	MDR58 168
HCT21 127	HSD29 192	HW126 101	KLB78 134	LWX4SS 65	MDR78 168
HCT22 127	HSD3 192	HW14 135		LWX5 65	MEZ100 168
HCT22UV 127	HSD4 192	HW14134 101	L	LWX5SS 65	MEZ125 168
HDT14 48	HSD5 192	HW14238 101	LCB12 189	LWX6 65	MEZ150 168
HDT2 103	HSD6 192	HW345 101	LCBLK12 189	LWX6SS 65	MEZ200 168
HFW114 63	HSD7 192	HW346 101	LCR12 189	LWX7 65	MEZ50 168
HFW117 63	HSD8 192	HW34712 101	LCS1230 85	LWX8 65	MEZ75 168
HG12 134	HSD9 192	HW38238 101	LCS1240 85	LWX8SS 65	MF100 201
HG14 134	HSDK1 193	HW38312 101	LCS1250 85	LWX9 65	MF125 201
HG3132 134	HSDK2 193	HW38434 101	LCS1260 85	LWX9SS 65	MF150 201
HG38 134	HSDK3 193	HW5162 101	LCS3816 85		MF200 201
HG4764 134	HTB1 75	HW516234 101	LCS3824 85	M	MF50 201
HG5564 134	HTB11 75	HW584 101	LCS3830 85	M10 184	MF75 201
HG58 134	HTB13 75	HW58434 101	LCS3840 85	M10B 185	MF1254 198
HHN12 55	HTB2 75	HW586 101	LCS3850 85	M15001 188	MF1272 198
HHN34 55	HTB23 76		LCSX1230 86	M1B 185	MF1454 198
HHN38 55	HTB24 76	I	LCSX1240 86	M256 178	MF1472 198
HHN58 55	HTB25 76	IBTK11 180	LCSX1250 86	M257 178	MF3854 198
HK1 84,191	HTB26 76	IBTK13 181	LCSX3830 86	M259 178	MF3872 198
HMC104SS 131	HTB3 75	IST1 177	LCSX3840 86	M591189 178	MFF100 202

• When Searching Stock # Drop "J"

QUICK REFERENCE PRODUCT INDEX

RED = NEW ITEMS

MFF125 202	MPS12 59	MWDM1 141	NHSD31 192	PBV1 234	PT4010 158
MFF150 202	MPS13 59	N	NHSD35 192	PCS125 173	PT4010V 158
MFF200 202	MPS14 59	N157 55	NHSD36 192	PCS204 174	PT4012 158
MFF25 202	MPS15 59	N159 55	NHSD37 192	PCS212 174	PT4012V 158
MFF75 202	MPS16 59	N159BR 56	NHSD43 192	PCS234 174	PT40K 156
MFHA100 201	MPS17 59	N160 55	NHSD6 192	PCS244 174	PT45 157
MFHA125 201	MPS18 59	N160BR 56	NHSD7 192	PCS254 174	PTK1 107
MFHA150 201	MPS19 59	N161 55	NHSD8 192	PCS264 174	PTK2 107
MFHA200 201	MPT1 182	N161BR 56	NHSD9 192	PCS274 174	PTK3 107
MFHA50 201	MRJ125 202	N162 55	NK1 59	PCS284 174	PTL1J 123
MFHA75 201	MRJ50 202	N162BR 55	NP400 166	PCS294 174	PTL1K 123
MHC24 131	MSCU 140	N163 55	NP400B 166	PCS345 173	PTL1M 123
MHC28 131	MSCUR 140	N163BR 56	NP580 167	PD4112 96	PTS30 157
MHC32 131	MSC50 137	N163G 56	NP600 166	PD8134 96	PTS40 157
MHC36 131	MSC50R 137	N163J 56	NP660 166	PDL1 203	PYLO1BLK 206
MHC48 131	MSC75 137	N164 55	NP800 166	PDL2 203	PYLO1CAM 206
MHC52 131	MSC75R 137	N165 55	NPL12 167	PDS1B 38	Q
MHC6 131	MSG1 198	N165BR 56	NPL188 167	PDS1C 38	QB1 196
MHC60 131	MSW20 66	N165G 56	NS1812 167	PDS1M 38	QB10 196
MHC64 131	MSW21 66	N165J 56	NS1816 167	PDW1B 38	QB11 196
MHD14 84,191	MSW22 66	N166 55	NT14 124	PDW1C 38	QB12 196
MHD56 84,191	MSW23 66	N166G 56	NT316 124	PDW1M 38	QB13 196
MN10C 170	MSW24 66	N167 55	NT38 124	PMP1032 12	QB14 196
MN10HG 170	MSW25 66	N167G 56	NYN159 57	PMP20 12	QB15 196
MN10S 171	MSWP120 66	N168 55	NYN160 57	PMP4 12	QB16 196
MN112J 171	MSWS30 66	N170 55	NYN160SS 57	PMP6 12	QB17 196
MN114J 171	MSWS31 66	NA140 104	NYN161 57	PMP63 12	QB2 196
MN16C 170	MT208 184	NA141 104	NYN161SS 57	PMP75 12	QB22 196
MN16DP 171	MT208B 185	NA1414 104	NYN162 57	PMP78 12	QB24 196
MN16HG 170	MT208L 184	NA1414 104	NYN162SS 57	PMP84 12	QB26 196
MN16S 171	MT208LB 185	NA1414SS 104	NYN163 57	PMP85 12	QB28 196
MN16S50B 171	MT210 184	NA1415 104	NYN163SS 57	PMP86 12	QB29 196
MS16SP 171	MT210B 185	NA142 104	NYN164 57	PMP88 12	QB3 196
MN1TM 103,171	MT210L 184	NA142SS 104	NYN164SS 57	PSA1 121	QB31 196
MN112TM 103,171	MT210LB 185	NA316 104	NYN165 57	PSA1J 121	QB4 196
MN212TM 103,171	MT212 184	NAP1 169	NYN165SS 57	PSA1K 121	QB5 196
MN2TM 103,171	MT212B 185	NCC0 129	NYN166 57	PSA1M 121	QB6 196
MN3TM 103,171	MT212L 184	NCC1 129	NYN166SS 57	PSAL2 121	QB7 196
MN4F 170	MT212LB 185	NCC2 129	NYN167 57	PSAL2J 121	QB8 196
MN6F 170	MT25 178	NCC3 129	NYN167SS 57	PSAL2K 121	QB9 196
MN6HG 170	MT59 178	NCC4 129	NYN168 57	PST100 175	QCSH1 82
MN8C 170	MT72 178	NCC4BLK 129	NYN172SS 57	PST100I 175	QCSH10 82
MN8DP 171	MT75 179	NCC6 129	O	PST40 175	QCSH10B 82
MN8HG 170	MTB 108	NCC7 129	ORG1 44	PST40I 175	QCSH1B 82
MN8S 171	MTC 108	NHSD10 192	ORG2 44	PT30 156	QCSH2 82
MNK1 104	MTKQ 183	NHSD11 192	OXIN1 216	PT30B 157	QCSH20 82
MNK10 104	MTW12 141	NHSD20 192	P	PT34BL 217	QCSH20B 82
MNK112 104	MTW12-3M 141	NHSD21 192	P2P2 184	PT34BR 218	QCSH2B 82
MNK2 104	MTW12-4M 141	NHSD22 192	P2P2B 185	PT34G 218	QCSH3 82
MNK212 104	MTW14M 141	NHSD25 192	P2S8 184	PT34GR 218	QCSH30 82
MNK3 104	MTW16 141	NHSD26 192	P2S8B 184	PT34O 218	QCSH30B 82
MP20 130	MTW16SS1LB 141	NHSD28 192	PB2 84,191	PT34R 217	QCSH3B 82
MP20UV 130	MTW16SSP 141	NHSD29 192	PB3 84,191	PT34W 218	QCSH40 82
MP25 130	MTW17 141	NHSD30 192	PBH 84,191	PT34Y 217	QCSH40B 82
MP25UV 130	MTW18 141			PT35 157	QCSHK1 82
MPS10 59	MTW1725 141			PT40 156	QCSHK2 82
MPS11 59	MUK1 182			PT40B 157	

• When Searching Stock # Drop "J"

QUICK REFERENCE PRODUCT INDEX

RED = NEW ITEMS

QDS152 26	R105 66	RDS2V 42	RM51 12	RMB92 15	RWS12 24
QDS153 26	R106 66	RDS3 42	RM63 11	RMB93 15	RWS26 24
QDS154 26	R107 66	RDS3M 42	RM65 12	RMB94 15	RWS27 24
QDS156 26	R108 66	RDS3V 42	RM66 12	RMB95 15	RWS28 24
QDS158 26	R109 66	RDS4 42	RM68 11	RMB99 15	RWS29 24
QDS171 26	R110 66	RDS4M 42	RM69 11	RMK632 52	RWS30 24
QDS172 26	R111 66	RDS4V 42	RM71 12	RMK1032 52	RWS31 24
QDS174 26	R112 66	RDS5 42	RM72 12	RMK1420 52	RWS7 24
QDS181 26	R113 66	RDS5M 42	RM75 11	RMK832 52	RWS8 24
QDS182 26	R114 66	RDS5V 42	RM77 12	RSB16 18	RWS9 24
QDS183 26	R115 66	RDS6 42	RM78 12	RSB17 18	
QDS184 26	R116 66	RDS6M 42	RM80 11	RSB18 18	S
QDS185 26	R117 66	RDS6V 42	RM81 11	RSB19 18	SAB10 186
QDS80 26	R118 66	RJK1 200	RM82 11	RSB100 18	SAD13 193
QK1 28	R119 66	RJK1B 200	RM83 11	RSB100S 19	SAD21 193
QK1M 28	R120 66	RJK2 200	RM84 11	RSB101 18	SB300 167
QK10 28	R121 66	RJK2B 200	RM85 11	RSB101S 19	SBH1 71
QK10M 28	R122 66	RJK3 200	RM86 11	RSB102 18	SBH11 71
QK12114 28	R123 66	RJK3B 200	RM87 11	RSB103 18	SBH12 72
QK15 28	RA1 105	RJS1 176	RM88 11	RSB103S 19	SBH13 71
QK15M 28	RA15 105	RJS2 176	RM89 11	RSB104 18	SBH131 73
QK17 28	RA2 105	RM100 11	RM90 11	RSB104S 19	SBH14 72
QK17M 28	RA3 105	RM101 11	RM91 11	RSB105 18	SBH142 73
QK19 28	RCA12 94	RM102 11	RM92 11	RSB106 18	SBH15 72
QK19M 28	RCA38 94	RM103 11	RM93 11	RSB116 19	SBH16 72
QK20 28	RCA381 94	RM104 11	RM94 11	RSB20 18	SBH17 72
QK20M 28	RCG1 211	RM105 11	RM95 11	RSB21 18	SBH19 72
QK25 28	RCQ1 211	RM113 11	RM96 11	RSB22 18	SBH2 71
QK25M 28	RCT1 211	RM114 11	RM97 11	RSB63 18	SBH23 72
QK30 28	RCT26 136	RM115 12	RM98 11	RSB66 19	SBH23 72
QK30M 28	RCT26SS 136	RM116 12	RM99 11	RSB72 19	SBH231 73
QK5 28	RCT27 136	RM123 12	RMB100 15	RSB78 19	SBH234 73
QK5M 28	RCT27SS 136	RM127 11	RMB102 15	RSB86 18	SBH236 73
QK59 28	RCT28 136	RM128 11	RMB104 15	RSB89 18	SBH238 73
QKK1 27	RCT28SS 136	RM130 12	RMB105 15	RSB90 18	SBH252 73
QTEKD1 31	RCT28SS316 ..136	RM132 11	RMB113 15	RSB91 18	SBH253 73
QTEKD12 31	RCT29 136	RM133 11	RMB140 15	RSB92 18	SBH254 73
QTEKD13 31	RCT29SS 136	RM134 11	RMB22 15	RSB93 18	SBH255 73
QTEKD14 31	RCT29SS316...136	RM135 12	RMB30 15	RSB94 18	SBH24 72
QTEKD17 31	RCT30136	RM136 12	RMB48 15	RSB95 18	SBH25 72
QTEKD18 31	RCT30SS..... 136	RM140 11	RMB49 15	RSB99 18	SBH26 72
QTEKD19 31	RCT31136	RM142 11	RMB61 15	RSBK1 53	SBH28 72
QTEKD2 31	RCTL28 136	RM144 11	RMB62 15	RSBK2 53	SBH29 72
QTEKD20 31	RCTL29 136	RM150 11	RMB63 15	RSBK3 53	SBH3 71
QTEKD3 31	RCTR27136	RM190 11	RMB64 15	RSBK4 53	SBH30 72
QTEKD4 31	RCTR28 136	RM17 11	RMB66 15	RT1W 48	SBH32 72
QTEKD5 31	RD4034 95	RM18 11	RMB7 15	RT2 129	SBH33 72
QTEKD6 31	RD4118 95	RM19 11	RMB73 15	RT2W 48	SBH332 73
QTEKD7 31	RD4150 95	RM20 11	RMB78 15	RT34BLK 217	SBH334 73
QTEKD8 31	RD4200 95	RM22 11	RMB8 15	RT3W 48	SBH336 73
	RD4212 95	RM23 11	RMB83 15	RTS14 207	SBH337 73
R	RD4300 95	RM32 11	RMB85 15	RTS19 207	SBH339 73
R100 66	RDS1 42	RM33 11	RMB86 15	RTS24 207	SBH34 72
R101 66	RDS1M 42	RM35 12	RMB87 15	RTS35 207	SBH341 73
R102 66	RDS1V 42	RM36 12	RMB88 15	RTS45 207	SBH35 72
R103 66	RDS2 42	RM48 11	RMB90 15	RWS10 24	SBH350 72
R104 66	RDS2M 42	RM50 12	RMB91 15	RWS11 24	SBH351 73

• When Searching Stock # Drop "J"

QUICK REFERENCE PRODUCT INDEX

RED = NEW ITEMS

SBH353 73	SBH913 72	SDS129 197	SFLN250 174	SLN516 137	SN10 55
SBH354 73	SBH93 72	SDS1445 197	SFLN300 174	SLNK1 137	SN11 55
SBH355 72	SBH94 72	SDS1465 197	SFLN400 174	SLNK2 137	SN12 55
SBH356 72	SBH941 73	SDS149 197	SFLN50 174	SLW10 64	SN13 55
SBH359 72	SBH951 73	SDS1B 39	SFLN75 174	SLW101 64	SN14 55
SBH37 72	SBN12 56	SDS1C 39	SFN1024 57	SLW11 64	SN14316SS 56
SBH4 71	SBN14 56	SDS1M 39	SFN1032 57	SLW111 64	SN15 55
SBH41 71	SBN24 56	SDS10 166	SFN1213SS..... 57	SLW12 64	SN15316SS 56
SBH411 73	SBN32 56	SDS20 166	SFN1420 57	SLW4 64	SN16 55
SBH412 71	SBN38 56	SDS30 166	SFN3816 57	SLW5 64	SN16316SS 56
SBH42 71	SBN516 56	SDS31645 197	SFN51618 57	SLW6 64	SN18 55
SBH421 73	SBN58 56	SDS31665 197	SFN832 57	SLW7 64	SN19 55
SBH43 71	SBN6 56	SDS3168 197	SGD36 220	SLW71 64	SN19316SS 56
SBH435 73	SBN8 56	SDS3465 197	SH1 140	SLW8 64	SN20 55
SBH44 72	SBW12 61	SDS3865 197	SH2 140	SLW81 64	SN20316SS 56
SBH45 72	SBW14 61	SDS389 197	SH3 140	SLW9 64	SN25316SS 56
SBH46 72	SBW36 61	SDS3B 39	SHK0ASS 140	SLW91 64	SNK1 56
SBH47 72	SBW38 61	SDS3C 39	SHK1 140	SLW92 64	SP170 162
SBH48 72	SBW516 61	SDS3M 39	SHK1A 140	SMC1213..... 148	SP172..... 162
SBH49 71	SBW58 61	SDS4B 39	SHK1SS..... 140	SMC1420..... 148	SP173..... 162
SBH491 73	SBW6 61	SDS4C 39	SHK2 140	SMC3816..... 148	SP176 162
SBH5 71	SBW8 61	SDS4M 39	SHK2A 140	SMCS1420 149	SP177 162
SBH502 72	SCB10 225	SDS4M 39	SHK2ASS 140	SMCS3816 149	SP178 162
SBH503 72	SCB150 225	SDS5865 197	SHK2SS 140	SMDB2 148, 151	SP179 162
SBH51 71	SCB20 225	SDS589 197	SHK3 140	SMDB3 148	SP180 162
SBH54 71	SCC12 129	SDS5B 39	SHK3SS 140	SMDH1 152	SP181..... 162
SBH541 73	SCC14 129	SDS5C 39	SHK4 140	SMDH2 152	SP182 162
SBH552 73	SCC316 129	SDS5M 39	SHK5 140	SMF100 201	SP190 162
SBH59 72	SCC34 129	SDS7B 39	SHK1 140	SMF125 201	SP191 162
SBH611 73	SCC38 129	SDS7C 39	SHSK1 146	SMF150 201	SP279 162
SBH64 72	SCC58 129	SDS7M 39	SHTB1..... 76	SMF200 201	SP280 162
SBH65 72	SCC78 129	SDS9B 39	SHTB11..... 76	SMF50 201	SP281 162
SBH670 73	SCC78 129	SDS9C 39	SHTB2..... 76	SMF75 201	SP282..... 162
SBH671 73	SCK1 153	SDS9M 39	SHTB23..... 76	SMHS10 152	SP283..... 162
SBH672 73	SCT6215 173	SE1 139	SHTB24..... 76	SMHS316 152	SP379..... 162
SBH674 73	SCT6315 173	SE10 139	SHTB25..... 76	SMM1213 148	SP380..... 162
SBH680 73	SCT6415 173	SE2 139	SHTB26..... 76	SMM1420 148	SP382 162
SBH71 72	SCW10 225	SE3 139	SHTB3..... 76	SMM3816 148	SPD379 163
SBH71 72	SCW150 225	SE4 139	SHTB33..... 76	SMMMS1420 149	SPD380 163
SBH74 72	SCW20 225	SE5 139	SHTB34..... 76	SMMMS3816 149	SPD381 163
SBH760 73	SD12 197	SE6 139	SHTB35..... 76	SMMMS3816 149	SPD382 163
SBH800 72	SD15B 182	SE7 139	SHTB36..... 76	SMMMS3816SS.. 149	SPD382 163
SBH801 72	SD34 197	SE8 139	SHTB36..... 76	SMS1 147	SPD383 163
SBH808 72	SD4W1 182	SEA12 94	SHTB4..... 76	SMS5 147	SPD384 163
SBH81 72	SD4W2 182	SEA14 94	SHTB41..... 76	SMSK1 152	SPD385 163
SBH811 73	SD6W1 183	SEA38 94	SHTB42..... 76	SMW1213 148	SPDK200 163
SBH82 72	SD6W2 183	SEA516 94	SHTB44..... 76	SMW1420 148	SPK100 162
SBH86 71	SD78 197	SEDS10 194	SHTB45..... 76	SMW3816 148	SPK101 162
SBH88 72	SDCP3 197	SES4115 173	SHTB46..... 76	SMWS1420 149	SPMP1SS 14
SBH90 72	SDLC3 142	SES4215 173	SHTB47..... 76	SMWS3816 149	SPMP15SS 14
SBH91 72	SDR1B 182	SES4312 173	SHTB48..... 76	SMW3816SS... 148	SPMP16SS 14
SBH96 72	SDR2B 182	SES4412 173	SHTB49..... 76	SMX1 150	SPMP17SS 14
SBH961 73	SDR3B 182	SES4512 173	SHTB59..... 76	SMX125 150	SPMP2SS 14
SBH981 73	SDR4B 182	SES4612 173	SHTB60..... 76	SMX2 150	SPMP20SS 14
SBH990 73	SDR5B 182	SFLN100 174	SHM3816..... 151	SMXB1 150	SPMP21SS 14
SBH991 73	SDR6B 182	SFLN125 174	SHW3816 151	SMXK1 150	SPMP23SS 14
SBH992 73	SDR7B 182	SFLN150 174	SLN12..... 137	SMXP35 150	SPMP29SS 14
SBH912 72	SDS1265 197	SFLN200 174	SLN14 137	SMXP3525 150	SPMP3SS 14
			SLN38..... 137		

• When Searching Stock # Drop "J"

QUICK REFERENCE PRODUCT INDEX

RED = NEW ITEMS

SPMP33SS 14	SRM17P 14	SSW151 61	SVGS1 221	TBC4 204	TEKD37 30
SPMP35SS 14	SRM18 13	SSW17 60	SW68 60	TBC8 204	TEKD4 29
SPMP38SS 14	SRM19 13	SSW171 61	SW70 60	TBC15 204	TEKD5 29
SPMP4SS 14	SRM19P 14	SSW18 61	SW71 60	TBH14 138	TEKD5SS 30
SPMP5SS 14	SRM190 13	SSW20 60	SW72 60	TBH38 138	TEKD6 29
SPMP7SS 14	SRM20 13	SSW201 61	SW73 60	TBH516 138	TEKD6SS 30
SPMP78SS 14	SRM20P 14	SSW8 60	SW73G 61	TBMK1 90	TEKD7 29
SPMP80SS 14	SRM21 13	SSWK1 60	SW74 60	TC1 200	TEKD7SS 30
SPN1 130	SRM21P 14	ST34BLK 217	SW75 60	TD4112 96	TEKD8 30
SPN12 130	SRM22 13	STS10 22	SW75G 61	TDS13 194	TEKD82 29
SPN14 130	SRM23 13	STS11 22	SW76 60	TEK10P 29	TEKD9 30
SPN300 163	SRM23P 14	STS12 22	SW76G 61	TEK11P 29	TEKD9SS 30
SPN316 130	SRM24 13	STS13 22	SW77 60	TEK12P 29	TEKD99 30
SPN34 130	SRM24P 14	STS14 22	SW77G 61	TEK14P 29	TEKDK1 52
SPN38 130	SRM25 13	STS15 22	SW78 60	TEK15P 29	TEKPK1 52
SPN58 130	SRM26 13	STS16 22	SW79 60	TEK16P 29	TEKS1 28
SPN78 130	SRM27 13	STS17 22	SW80 60	TEK18P 29	TEKS14 28
SPS5151 174	SRM27P 14	STS18 22	SW82 60	TEK19P 29	TEKS15 28
SPT200 164	SRM28 13	STS19 22	SWA1236 100	TEK20P 29	TEKS19 28
SPT300 164	SRM29 13	STS20 22	SWA1244 100	TEK1P 29	TEKS2 28
SPT400 164	SRM30 13	STS21 22	SWA1254 100	TEK2P 29	TEKS3 28
SQ2 58	SRM30P 14	STS22 22	SWA1270 100	TEK3P 29	TEKS5 28
SQ3 58	SRM31 13	STS23 22	SWA3830 100	TEK4P 29	TEKS6 28
SQ4 58	SRM31P 14	STS24 22	SWA3834 100	TEK7P 29	TEKS7 28
SQ5 58	SRM32 13	STS25 22	SWA3850 100	TEKD1 29	TEKS8 28
SQ6 58	SRM32P 14	STS26 22	SWA5850 100	TEKD1SS 30	TEKSK1 52
SQ7 58	SRM33 13	STS27 22	SWA5860 100	TEKD10 30	TEL1024BLK .. 159
SQ8 58	SRM33P 14	STS28 22	SWA5870 100	TEKD10SS 30	TEL1032BLK .. 159
SQ9 58	SRM50 13	STSP10 22	SWA5884 100	TEKD11 30	TEL1224 159
SRM10 13	SRM51 13	STSP11 22	SWBR12 61	TEKD12 30	TEL1224BLK .. 159
SRM100 13	SRM60 13	STSP12 22	SWBR14 61	TEKD12SS 30	TEL1228 159
SRM100P 14	SRM61 13	STSP125 22	SWBR16 61	TEKD12212 ... 30	TG9151 32
SRM101P 14	SRM66 13	STSP13 22	SWBR38 61	TEKD13 30	TGW9151 32
SRM102P 14	SRM71 13	STSP14 22	SWBR6 61	TEKD14 29	THSK1 38
SRM11 13	SRM74 13	STSP15 22	SWBR8 61	TEKD14SS 30	TL12 134
SRM11P 14	SRM74P 14	STSP16 22	SWK1 60	TEKD15 29	TL38 134
SRM12 13	SRM85 13	STSP17 22	SWL1212 141	TEKD15SS 30	TL516 134
SRM13 13	SRM85P 14	STSP18 22	SWL612 141	TEKD16 29	TL78 134
SRM13P 14	SRM90 13	STSP19 22	SWN1 61	TEKD17 29	TLN1 57
SRM132 13	SRM90P 14	STSP20 22	SWN73 61	TEKD18 29	TLN2 57
SRM133 13	SRM95 13	STSP21 22	SWN74 61	TEKD19 29	TLN3 57
SRM134 13	SRM95P 14	STSP22 22	SWP1212 141	TEKD2 29	TLN4 57
SRM136 13	SRM97 13	STSP23 22	SWP612 141	TEKD20 30	TLN5 57
SRM137P 14	SRT14 89,145	STSP24 22	SYA14 105	TEKD20SS 30	TLN5SS 57
SRM138P 14	SRT38 89,145	STSP25 22	SYA316 105	TEKD21 30	TLN6 57
SRM14 13	SSGA1 220	STSP26 22	SYA516 10	TEKD22 30	TLN7 57
SRM139P 14	SSGC1 220	STSP27 22		TEKD22SS 30	TLN7SS 57
SRM14P 14	SSGS1 220	STSP28 22	T	TEKD23 29	TM63 164
SRM140P 14	SSW10 60	STSP29 22	TA14134 91	TEKD23SS 30	TM63LP 164
SRM144 13	SSW11 60	STSP30 22	TA14212 91	TEKD24 29	TM68 164
SRM146 13	SSW12 60	STSP32 22	TA14314 91	TEKD25 29	TM68LP 164
SRM148 13	SSW121 61	STSP33 22	TA38314 91	TEKD26 29	TM80 164
SRM148P 14	SSW13 60	STSP34 22	TA38334 91	TEKD3 29	TM80LP 164
SRM15 13	SSW131 61	STSP35 22	TA38412 91	TEKD30 30	TM80LP 164
SRM15P 14	SSW14 60	STSP37 22	TA516212 91	TEKD32 30	TM81 164
SRM16 13	SSW141 61	STSP39 22	TA516314 91	TEKD34 30	TM81LP 164
SRM17 13	SSW15 60	SVGC1 221	TA516334 91	TEKD36 30	TM82 164
					TM82LP 164

• When Searching Stock # Drop "J"

QUICK REFERENCE PRODUCT INDEX

RED = NEW ITEM

TM83	164	TP202SFC.....	45	TP312SFC	46	TP506SBC	47	TP615SFC.....	47	TS11	20
TM83LP	164	TP204SBC	45	TP312SPC.....	46	TP506SFC.....	47	TP616SBC	47	TS1134	99
TMS1SS	165	TP204SFC.....	45	TP313SFC	46	TP507SBC	47	TP616SFC.....	47	TS1134SS	99
TMS2SS	165	TP205SBC	45	TP313SPC.....	46	TP507SFC.....	47	TP617SBC	47	TS12	20
TOB1	133	TP205SFC.....	45	TP314SFC	46	TP508SBC	47	TP617SFC.....	47	TS1214	99
TPK30	48	TP206SBC	45	TP314SPC.....	46	TP508SFC.....	47	TP618SBC	47	TS1214SS	99
TPKRM1	50	TP206SFC.....	45	TP315SFC	46	TP509SBC	47	TP618SFC.....	47	TS13	20
TPKSM1	50	TP207SBC	45	TP315SPC.....	46	TP509SFC.....	47	TPK30	48	TS14	20
TP100SBC.....	45	TP207SFC.....	45	TP316SFC	46	TP510SBC	47	TPKRM1	50	TS15	20
TP100SFC.....	45	TP208SBC	45	TP316SPC.....	46	TP510SFC.....	47	TPKSM1	50	TS17	20
TP101SBC	45	TP208SFC.....	45	TP317SFC	46	TP511SBC	47	TRM100	10	TS18	20
TP101SFC	45	TP209SBC	45	TP317SPC.....	46	TP511SFC.....	47	TRM101	10	TS19	20
TP102SBC	45	TP209SFC.....	45	TP318SFC	46	TP512SBC	47	TRM102	10	TS2	20
TP102SFC.....	45	TP211SBC	45	TP318SPC.....	46	TP512SFC.....	47	TRM103	10	TS20	20
TP103SBC	45	TP211SFC.....	45	TP319SFC	46	TP513SBC	47	TRM104	10	TS21	20
TP103SFC.....	45	TP212SBC	45	TP319SPC.....	46	TP513SFC.....	47	TRM16.....	10	TS22	20
TP104SBC	45	TP212SFC.....	45	TP320SFC	46	TP514SBC	47	TRM22	10	TS23	20
TP104SFC.....	45	TP213SBC	45	TP320SPC.....	46	TP514SFC.....	47	TRM33	10	TS24	20
TP105SBC	45	TP213SFC.....	45	TP321SFC	46	TP515SBC	47	TRM63	10	TS25	20
TP105SFC.....	45	TP214SBC.....	45	TP321SPC.....	46	TP515SFC.....	47	TRM80	10	TS26	20
TP106SBC	45	TP214SFC.....	45	TP322SFC	46	TP516SBC	47	TRM81	10	TS27	20
TP106SFC.....	45	TP215SBC	45	TP322SPC.....	46	TP516SFC.....	47	TRM82	10	TS28	20
TP107SBC	45	TP215SFC.....	45	TP323SFC	46	TP517SBC	47	TRM83	10	TS29	20
TP107SFC.....	45	TP216SBC	45	TP323SPC.....	46	TP517SFC.....	47	TRM84	10	TS30	20
TP108SBC	45	TP216SFC.....	45	TP400SRC	46	TP518SBC	47	TRM85	10	TS303	99
TP108SFC.....	45	TP217SBC	45	TP401SRC	46	TP518SFC.....	47	TRM86	10	TS303SS	99
TP109SBC	45	TP217SFC.....	45	TP402SRC	46	TP519SBC	47	TRM87	10	TS3033SS	99
TP109SFC.....	45	TP218SBC	45	TP403SRC	46	TP519SFC.....	47	TRM88	10	TS31	20
TP110SBC	45	TP218SFC.....	45	TP404SRC	46	TP600SBC.....	47	TRM89	10	TS312	99
TP110SFC.....	45	TP219SBC	45	TP406SRC	46	TP600SFC.....	47	TRM98	10	TS312SS	99
TP111SBC	45	TP219SFC.....	45	TP407SRC	46	TP601SBC	47	TRM99	10	TS32	20
TP111SFC	45	TP220SBC	45	TP408SRC	46	TP601SFC.....	47	TRS1010.....	136	TS3218	99
TP112SBC	45	TP220SFC.....	45	TP409SRC	46	TP602SBC	47	TRS106	136	TS3218SS	99
TP112SFC.....	45	TP300SFC.....	46	TP410SRC	46	TP602SFC.....	47	TRS106SS	136	TS3234	99
TP113SBC	45	TP300SPC.....	46	TP412SRC	46	TP603SBC.....	47	TRS1110.....	136	TS33	20
TP113SFC.....	45	TP301SFC	46	TP413SRC	46	TP603SFC.....	47	TRS11/6.....	136	TS34	20
TP114SBC	45	TP301SPC.....	46	TP414SRC	46	TP604SBC	47	TRS6/3	136	TS35	20
TP114SFC.....	45	TP302SFC	46	TP415SRC	46	TP604SFC.....	47	TRS6/6B	136	TS36	20
TP115SBC	45	TP302SPC.....	46	TP416SRC	46	TP605SBC.....	47	TRS6/6SS	136	TS3612	99
TP115SFC.....	45	TP303SFC	46	TP418SRC	46	TP605SFC.....	47	TRS610	136	TS361SS	99
TP116SBC	45	TP303SPC.....	46	TP419SRC	46	TP606SBC.....	47	TRS7/3	136	TS37	21
TP116SFC.....	45	TP304SFC	46	TP420SRC	46	TP606SFC.....	47	TRS7/6	136	TS38	20
TP117SBC	45	TP304SPC.....	46	TP421SRC	46	TP607SBC.....	47	TRS7/6SS	136	TS385	99
TP117SFC.....	45	TP305SFC	46	TP422SRC	46	TP607SFC.....	47	TRS710	136	TS385SS	99
TP118SBC	45	TP305SPC.....	46	TP423SRC	46	TP608SBC	47	TRS8/3	136	TS39	23
TP118SFC.....	45	TP306SFC	46	TP500SBC	47	TP608SFC.....	47	TRS8/6B	136	TS4	20
TP119SBC	45	TP306SPC.....	46	TP500SFC.....	47	TP609SBC.....	47	TRS8/6SS	136	TS40	20
TP119SFC.....	45	TP307SFC	46	TP501SBC	47	TP609SFC.....	47	TRS810	136	TS407	99
TP120SBC	45	TP307SPC.....	46	TP501SFC.....	47	TP610SBC	47	TRS9/3	136	TS42	20
TP120SFC.....	45	TP308SFC	46	TP502SBC	47	TP610SFC.....	47	TRS9/6B	136	TS4234	99
TP121SBC	45	TP308SPC.....	46	TP502SFC.....	47	TP611SBC	47	TRS9/6SS	136	TS4234SS	99
TP121SFC.....	45	TP309SFC	46	TP503SBC	47	TP611SFC.....	47	TRS910	136	TS4334	99
TP200SBC	45	TP309SPC.....	46	TP503SFC.....	47	TP612SBC.....	47	TS1	20	TS4334SS	99
TP200SFC.....	45	TP310SFC	46	TP504SBC	47	TP612SFC.....	47	TS10	20	TS44	20
TP201SBC.....	45	TP310SPC.....	46	TP504SFC.....	47	TP614SBC	47	TS103	99	TS4414	99
TP201SFC.....	45	TP311SFC	46	TP505SBC	47	TP614SFC.....	47	TS103SS	99	TS4512	99
TP202SBC	45	TP311SPC.....	46	TP505SFC.....	47	TP615SBC	47	TS1034SS	99	TS4512SS	99

• When Searching Stock # Drop "J"

QUICK REFERENCE PRODUCT INDEX

RED = NEW ITEMS

TS48 20	TSS10SS 23	TTS37 19	UBS022 80	WAK13B 112	WAK8QD 115
TS49 20	TSS11 23	TTS38 19	UBS023 80	WAK14 111	WAK8T 115
TS505 99	TSS11SS 23	TTSK10 51	UBS024 80	WAK141 111	WAK9 115
TS506 99	TSS12 23	TW12212 33	UBS03 80	WAK14B 112	WAKJ13 110
TS51 20	TSS2 23	TW101716 33	UBS04 80	WAK14H 111	WAKJ13B 112
TS52 20	TSS25 23	TWA144.....89,143	UBS05 80	WAK14HB 112	WAKJ14 111
TS5312 99	TSS25SS 23	TWA145.....89,143	UBS06 80	WAK14BSS .. 112	WAKJ141 111
TS54 20	TSS27 23	TWA214 101	UBS07 80	WAK14HSS ... 111	WAKJ141B 112
TS5412 99	TSS27SS 23	TSWAK 118	UBS08 80	WAK14Q 111	WAKJ14B 112
TS55 21	TSS28 23	TWH1 190	UBS09 80	WAK14QB 112	WAKJ14H 111
TS57 21	TSS28SS 23	TWH2 190	US6 190	WAK14QD 111	WAKJ14HB 112
TS59 21	TSS29 23	TX12114SS ... 33	V	WAK14QD 111	WAKJ14HBSS . 112
TS6 20	TSS29SS 23	TX1234 33	VA1 105	WAK14QDB ... 113	WAKJ14HSS 111
TS60 21	TSS3 23	TX1478 33	VR12 128	WAK14R 111	WAKJ14Q 111
TS61 21	TSS30 23	TXV12112 32	VR34 128	WAK14RB 112	WAKJ14QB 112
TS63 21	TSS30SS 23	TXV12114 32	VT12 128	WAK14SS 111	WAKJ14QD ... 111
TS6414 99	TSS31 23	TXV12114Z 32	VT8 128	WAK14SSPH .. 111	WAKJ14QDB ... 113
TS6434 99	TSS31SS 23	TXV12200 32	W	WAK14T 111	WAKJ14R 111
TS6512 99	TSS32 23	TXV14400 32	W110 63	WAK14TB 112	WAKJ14RB 112
TS6614 99	TSS33 23	TXW1234 33	W111 63	WAK15 111	WAKJ14SS 111
TS7 20	TSS34 23	U	W111SS 63	WAK15B 112	WAKJ14SSPH .. 111
TS80 20	TSS35 23	UB01 80	W112 63	WAK15QD 111	WAKJ14T 111
TS81 20	TSS36 23	UB010 80	W112SS 63	WAK15QDB 113	WAKJ14TB 112
TS82 21	TSS37 23	UB011 80	W113 63	WAK15R 111	WAKJ15 111
TS83 21	TSS4 23	UB012 80	W113SS 63	WAK15RB 112	WAKJ15B 112
TS9 20	TSS5 23	UB013 80	W114 63	WAK15S 111	WAKJ15QD 111
TSF10 21	TSS6 23	UB014 80	W114SS 63	WAK15SB 112	WAKJ15QDB ... 113
TSF101 21	TSS7 23	UB015 80	W115 63	WAK16 110	WAKJ15R 111
TSF11 21	TSS7SS 23	UB016 80	W115SS 63	WAK16H 110	WAKJ15RB 112
TSF12 21	TSS8 23	UB017 80	W116 63	WAK16QD 111	WAKJ15S 111
TSF14 21	TSS8SS 23	UB018 80	W116SS 63	WAK16R 111	WAKJ15SB 112
TSF15 21	TSS81 23	UB019 80	W117 63	WAK16T 110	WAKJ16 110
TSF16 21	TSS83 23	UB020 80	W117SS 63	WAK17 114	WAKJ16H 110
TSF18 21	TSS9 23	UB021 80	W118 63	WAK17QD 114	WAKJ16QD 111
TSF20 21	TSS9SS 23	UB022 80	W118SS 63	WAK17T 114	WAKJ16R 111
TSF21 21	TSSK10 51	UB023 80	W119 63	WAK18 113	WAKJ16T 110
TSF22 21	TSSK8 51	UB024 80	W120 63	WAK18T 113	WAKJ17 114
TSF23 21	TT12 218	UB03 80	W1201 63	WAK19 113	WAKJ17QD ... 114
TSF24 21	TTS12 19	UB04 80	W121 63	WAK191S 113	WAKJ17T 114
TSF25 21	TTS14 19	UB05 80	W121SS 63	WAK19H 113	WAKJ18 113
TSF27 21	TTS15 19	UB06 80	W122 63	WAK19QD 113	WAKJ18T 113
TSF28 21	TTS18 19	UB07 80	W1221SS 63	WAK19S 113	WAKJ19 113
TSF29 21	TTS20 19	UB08 80	W123 63	WAK19SS 113	WAKJ191S 113
TSF30 21	TTS21 19	UB09 80	W1231SS 63	WAK19T 113	WAKJ19H 113
TSF31 21	TTS22 19	UBS01 80	W123SS 63	WAK20 101	WAKJ19QD ... 113
TSF32 21	TTS23 19	UBS010 80	W126 63	WAK22 116	WAKJ19S 113
TSF33 21	TTS24 19	UBS011 80	W127 63	WAK23 116, 159	WAKJ19SS 113
TSF34 21	TTS25 19	UBS012 80	W127SS 63	WAK23F.....116, 159	WAKJ19T 113
TSF35 21	TTS27 19	UBS013 80	W128 63	WAK23QD 116	WAKJ20 101
TSF36 21	TTS28 19	UBS014 80	W129 63	WAK23T 116	WAKJ22 116
TSF37 21	TTS29 19	UBS015 80	W130 63	WAK24 116	WAKJ23 116
TSF38 21	TTS30 19	UBS016 80	W131 63	WAK25 116	WAKJ23F ... 116, 159
TSF9 21	TTS31 19	UBS017 80	W132 63	WAK33 114	WAKJ23QD ... 116
TSK10 51	TTS33 19	UBS018 80	W133 63	WAK33R 114	WAKJ23T 116
TSK8 51	TTS34 19	UBS020 80	W134 63	WAK34 114	WAKJ24 116
TSS1 23	TTS35 19	UBS021 80	W135 63	WAK7 115	WAKJ25 159
TSS10 23	TTS36 19		W136 63	WAK8 115	WAKJ33 114

• When Searching Stock # Drop "J"

QUICK REFERENCE PRODUCT INDEX

RED = NEW ITEM

WAKJ33R	114	WDW1C	40
WAKJ34	114	WDW1M	40
WAKJ7	115	WDW2B	40
WAKJ8	115	WDW2C	40
WAKJ8QD	115	WDW2M	40
WAKJ8T	115	WDW3B	40
WAKJ9	115	WDW3C	40
WAKQUAD	117	WDW3M	40
WAKTRIO	110	WDW4B	40
WCH1	189	WDW4C	40
WDBTR1	212	WDW4M	40
WDEC10	213	WGC100	165
WDEC16	215	WGD100	165
WDEW10	213	WGD25	165
WDEW5	213	WGR100	165
WDFB12	209	WGR25	165
WDFS10	214	WGT100	165
WDGF1	212	WGT25	165
WDHM10	215	WN2SS	58
WDKBC1	212	WN3	58
WDKBW1	212	WN3SS	58
WDKS1	214	WN4	58
WDN1	215	WN4SS	58
WDN2	215	WN5	58
WDPS10	214	WN6	58
WDPS20	214	WN6SS	58
WDPS30	214	WN7	58
WDPT10	214	WN7SS	58
WDPT20	214	WN8	58
WDPT30	214	WN8SS	58
WDS3C	40	WN9	58
WDESC30	212	WSGT75	208
WDSL1C	212	WW80	61
WDSW30	212	WW81	61
WDPS30	214	WW82	61
WDPT10	214	WW83	61
WDPT20	214	WW84	61
WDPT30	214	WW85	61
WDS10	211	WW87	61
WDS1B	40	WYP220	210
WDS1C	40	WYP75	208
WDS1M	40		
WDS20	211	Z	
WDS2B	40	ZSA1	120
WDS2C	40	ZSA1J	120
WDS2M	40	ZSA1K	120
WDS30	211	ZSA1M	120
WDS3B	40	ZSA1TJ	120
WDS3M	40	ZSA1TK	120
WDS4B	40	ZSAL2	121
WDS4C	40	ZSAL2J	121
WDS4M	40	ZSAL2K	121
WDS6C	40	ZSTU1J	120
WDESC10	200, 215	ZSTU1K	120
WDSG10	215	ZSTU1M	120
WDSW10	200, 215		
WDW1B	40		

• When Searching Stock # Drop "J"

METALLICS PEOPLE AND SALES FORCE

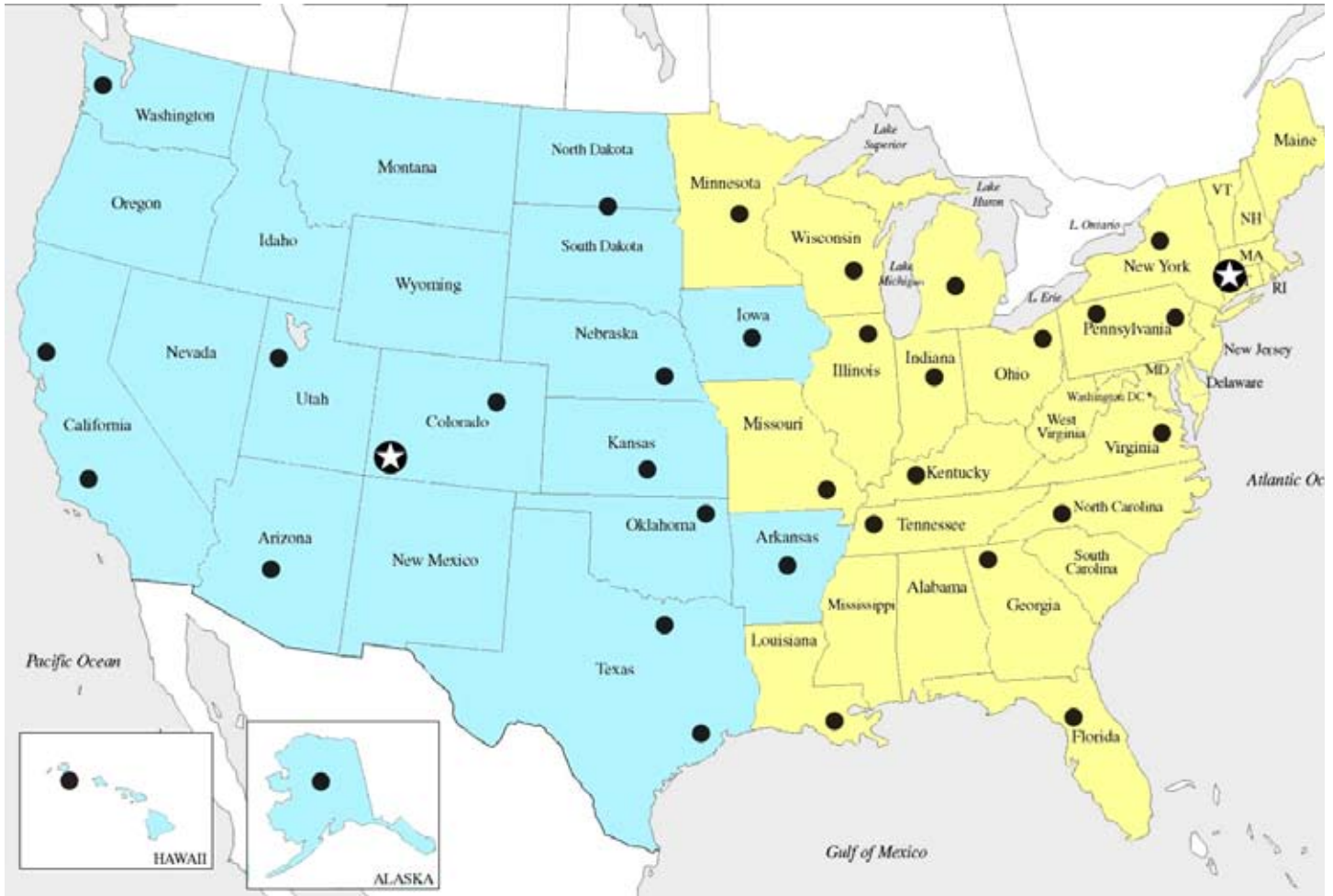

THE LARGEST FASTENER SALES FORCE IN AMERICA SELLING TO ELECTRICAL DISTRIBUTORS

Legend:

- ★ Metallics Distribution And Manufacturing Centers
- Bristol, CT - 100,00 sq. ft.
- Mancos, CO - 38,000 sq. ft.
- Sales Representative Organization Locations

METALLICS, INC. - Eastern Distribution • Bristol, CT Ph 800.243.8272 Fax 800.831.9358
 METALLICS WEST, INC. - Western Distribution • Mancos, CO Ph 800.269.5183 Fax 800.269.6278
 AVANTI SCREW, INC. - Manufacturing Division • Bristol, CT

www.metallicsonline.com

METALLICS SALES FORCE

METALLICS WEST (Mancos, Colorado)

SALES REPRESENTATIVES	TERRITORY	# SALES PERSONNEL
1. Albuquerque, New Mexico	New Mexico/El Paso, TX/SW Colorado	6
2. Danville, California	Northern California/Nevada	6
3. Conway, Arkansas	Arkansas	3
4. Denver, Colorado	Colorado/Wyoming/E. Montano	7
5. Council Bluffs, Iowa	Iowa/Nebraska	7
6. Honolulu, Hawaii	Hawaii	3
7. Houston, Texas	Southern Texas	8
8. Irving, Texas	Northern Texas	11
9. Olathe, Kansas	Kansas/Western Missouri	9
10. Kent, Washington	Washington/Oregon/Northern Idaho/Alaska	12
11. Minneapolis, Missesota	North and South Dakota	2
12. Oklahoma City, Oklahoma	Oklahoma	3
13. Sandy City, Utah	Utah/Southern Idaho/SW Colorado/NE Wyoming.	2
14. Phoenix, Arizona	Arizona/Las Vegas, Nevada	6
15. Whittier, California	Southern California	15
	TOTAL # SALES PERSONNEL	100

METALLICS EAST (Bristol, Connecticut)

SALES REPRESENTATIVES	TERRITORY	# SALES PERSONNEL
1. New Holland, Pennsylvania	Maryland/Washington, D.C./N. Virginia	6
2. Bayside, Wisconsin	Central & Eastern Wisconsin/Upper Michigan	8
3. Canton, Massachusetts	Rhode Island/New Hampshire/Maine/Mass	13
4. Greensboro, North Carolina	North and South Carolina	11
5. Westlake, Ohio	Ohio	7
6. Atlanta, Georgia	Alabama, Georgia	11
7. Nesconset, New York	New York City/N. New Jersey/Long Island	9
8. Elk Grove Village, Illinois	Illinois	6
9. Harahan, Louisiana	Central-South Mississippi/Lousiana	6
10. Indianapolis, Indiana	Indiana	7
11. Kirkwood, Missouri	Eastern Missouri/Southern Illinois	9
12. Louisville, Kentucky	Kentucky	7
13. Memphis, Tennessee	Tennessee/N. Mississippi	2
14. Minneapolis, Minnesota	Minnesota/Western Wisconsin	10
15. Glen Falls, New York	Connecticut/W. Massachusetts/Vermont	2
16. Nashville, Tennessee	Eastern Tennessee	7
17. New Holland, Pennsylvania	Eastern Pennsylvania/S, New Jersey/Delaware	6
18. Novi, Michigan	Western Michigan/Eastern Michigan	8
19. Pittsburgh, Pennsylvania	West Virigina/West Pennsylvania	7
20. Richmond, Virginia	Virginia	3
21. Rochester, New York	Upstate New York	9
22. South Windsor, Connecticut	Connecticut/W. Massachusetts/Vermont	5
23. Tampa, Florida	Florida/Georgia/Alabama	26
24. Feasterville, Pennsylvania	S. New Jersey/E. Pennsylvania/Delaware	3
	TOTAL # SALES PERSONNEL	188

DISTRIBUTOR CATALOGUE 2010-2011

Metallics - East



Product Offering and more...



Avanti Production



Metallics - West

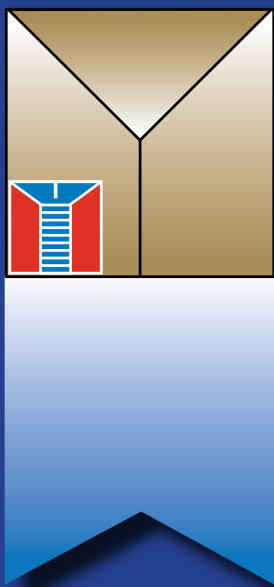

Metallics

Metallics East

229 Cross Street • Bristol, CT 06010
P: 800-243-8272 • F: 800-831-9358
E: sales@metallicsonline.com

Metallics West

651 North Main Street • Mancos, CO 81328
P: 800-269-5183 • F: 800-269-6278
E: saleswest@metallicsonline.com

www.metallicsonline.com

America's
Source for
Premier and
Innovative
Fasteners
& Anchors