



# OUR INNOVATION. YOUR REVOLUTION.

  
**TECHBRITE**

SAVING ENERGY IN THE BEST POSSIBLE LIGHT

[techbrite.com](http://techbrite.com) | 800.246.9977 | Cincinnati, Ohio

## Lower Energy Costs and a Brighter Future

For over twenty years, TechBrite has been providing customers throughout the country with cost-effective lighting solutions. Based in Cincinnati, Ohio, the TechBrite team is committed to improving the environment, one light fixture at a time. Using only premium materials, and following the highest standards, new energy efficient fixtures and Retrofit Kits are saving customers as much as 50% or more on lighting energy costs from the moment they are installed.

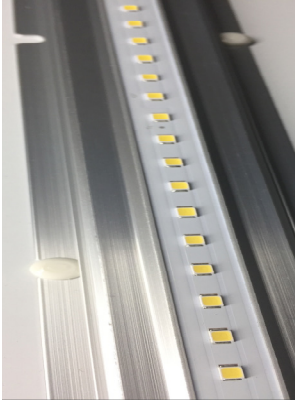

**LED Fixtures**

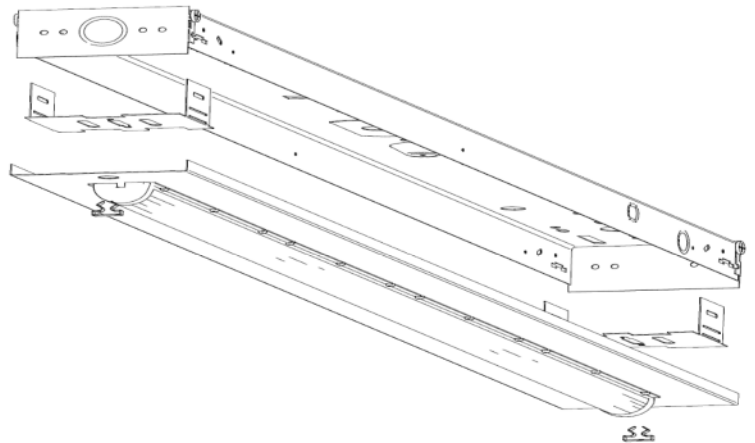

**LED Retro Kits**



**Wired for LED Tubes**

**Wireless Dimming Controls**

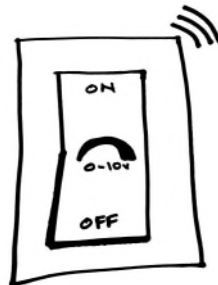

# Table Of Contents

LED Indoor Fixtures	Pages 5-34
LED Retro Kits	Pages 35-48
Wired For LED Tubes	Pages 49-57
LED Outdoor Fixtures	Pages 58-63
Wireless Dimming Controls	Pages 64-65

# Accessories Guide – LED



Digit 1

- 0 ... Standard
- 1 ... Clear Door & Lens, Installed
- 2 ... Wire Guard, Installed
- 3 ... Door, Lens & Wire Guard Installed on High Bay
- S ... Vaporite Strip Stainless Latches
- A ... Vaporite High Bay Ceiling Mount System
- C ... LED 2x2/2x4 Troffer Cloud Lens
- F ... Frosted Lens Installed for High Bay Fixture Only
- 4 ... 2x2/2x4 Troffer Clear Lens
- 5 ... Strip Reflector Wire Guard (per 4" section)
- 6 ... Ballast Cover Wire Guard (per 4" section)
- 9 ... Wire Guard and Frosted Lens for High Bay



Digit 2

- 0 ..... Standard
  - 1 ..... 6' 16/3 SOOW Cord
  - A ..... 6' 16/3 SOOW Cord & 5-15 Straight Plug
  - 2 ..... 6' 16/3 SOOW Cord & L5-15 Plug
  - B ..... 6' 16/3 SOOW Cord & L6-15 Plug
  - 3 ..... 6' 16/3 SOOW Cord & L7-15 Plug
  - Q ..... 6' 16/3 SOOW Cord & L7-20 Plug
  - 9 ..... 6' 16/3 SOOW Cord & L8-20 Plug
  - H ..... 8' 16/3 SOOW Cord
  - I ..... 8' 16/3 SOOW Cord & 5-15 Straight Plug
  - J ..... 8' 16/3 SOOW Cord & L5-15 Plug
  - K ..... 8' 16/3 SOOW Cord & L7-15 Plug
  - 4 ..... 10' 16/3 SOOW Cord
  - R ..... 10' 16/3 SOOW Cord & 5-15 Straight Plug
  - E ..... 10' 16/3 SOOW & L5-15 Plug
  - D ..... 10' 16/3 SOOW & L7-15 Plug
  - C ..... 10' 16/3 SOOW & L7-20 Plug
  - L ..... 10' 16/3 SOOW & L8-20 Plug
  - T ..... 15' 16/3 SOOW Cord
  - V ..... 15' 16/3 SOOW Cord & L5-15 Plug
  - Y ..... 15' 16/3 SOOW Cord & 5-15 Straight Plug
  - 5 ..... 6' 14/3 SOOW Cord
  - 6 ..... 6' 14/3 SOOW Cord & L5-15 Plug
  - 7 ..... 6' 14/3 SOOW Cord & L7-15 Plug
  - 8 ..... 10' 14/3 SOOW Cord
  - F ..... 10' 14/3 SOOW Cord & L5-15 Plug
  - G ..... 10' 14/3 SOOW Cord & L7-15 Plug
  - M ..... 6' 16/3 MC Cord
  - N ..... 6' 14/3 MC Cord
  - P ..... Retro Kit Only Rewire (Strip)
  - P ..... Retro Kit Only Rewire (Troffer)
  - P ..... Prewired for LED Tubes
- \*\*\*\*All Cords and Plugs Installed\*\*\*\*

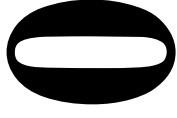

Digit 4

- 0 ..... Standard
- 1 ..... (2) 10' Y Gripples
- 2 ..... Occupancy Sensor, 120/277 Installed-T5/T8
- 4 ..... Occupancy Sensor, 480V Installed-T5/T8
- 5 ..... Sensor #2 Installed & 5' Y Toggle Gripples
- 6 ..... 10' Gripples and Occupancy Sensor
- 7 ..... Sensor #4 Installed & 5' Y Toggle Gripples
- 8 ..... 5' Y Toggle Gripples
- 9 ..... Occupancy Sensor 120/277, Not Installed-T5/T8
- A ..... Occupancy Sensor 480V, Not Installed -T5/T8
- B ..... Pendant Mounting Hub & Plate, Installed (1)
- C ..... (2) Fixture Hooks For Chain Hanging, Small (Strip Fixture, BayBrite, BayBrite Eco)
- D ..... (2) Fixture Hook For Chain Hanging, Large (Vaporite High Bay)
- F ..... Occupancy Sensor 120/177 With Photocell Installed
- G ..... Jack Chain Hanging Kit: S-Hooks, Chain and 2 Fixture Hooks For 1 Fixture
- H ..... Jack Chain Hanging Kit: S-Hooks, Chain and 2 Fixture Hooks For 1 Fixture—Stainless Steel
- J ..... Occupancy Sensor #2 & Pendant Mount
- K ..... Vaporite Jack Chain Hanging Kit: S Hooks, Chain and 2 Hooks for 1 Fixture
- L ..... Adder K (Vaporite Jack Chain Kit) & Adder 2 (Occ Sensor)
- N ..... Jack Chain and Safety Strap hanging kit
- Y ..... Wet Location/ Outdoor Sensor

# LED INDOOR FIXTURES

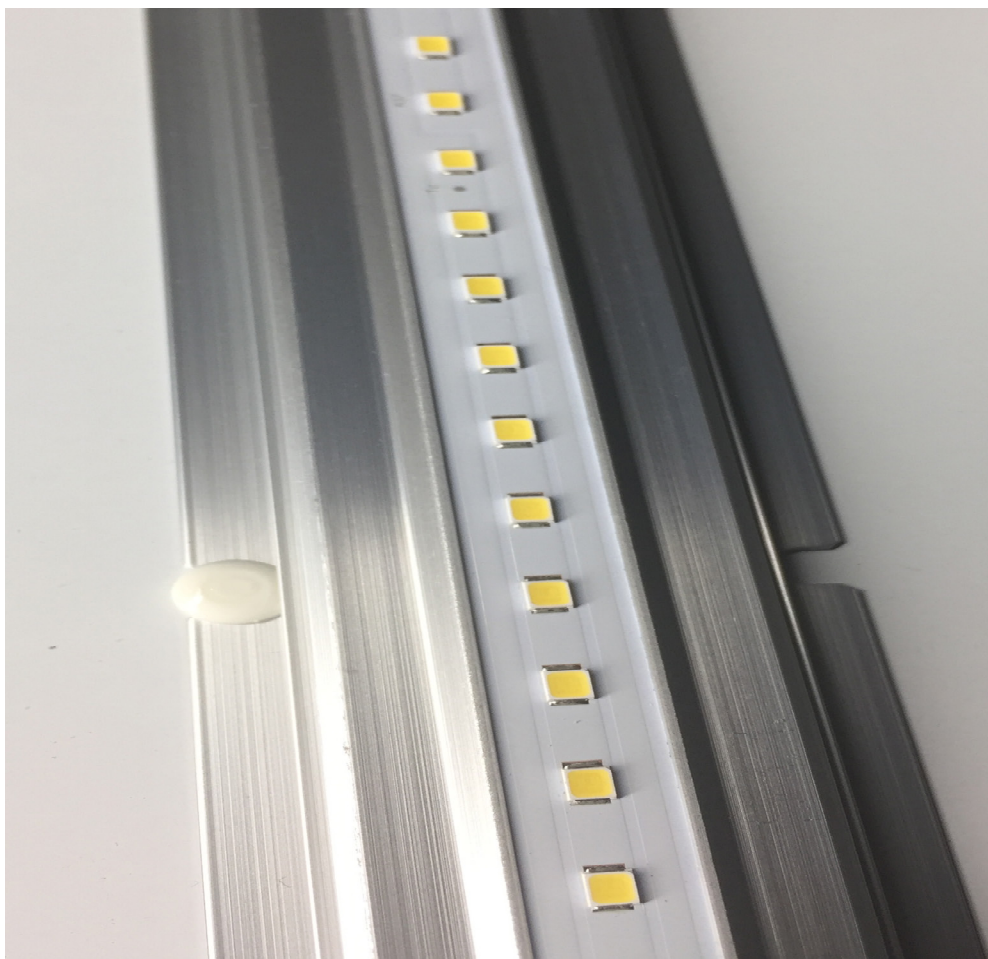





## LED CENTER BASKET TROFFER ECO 2x4

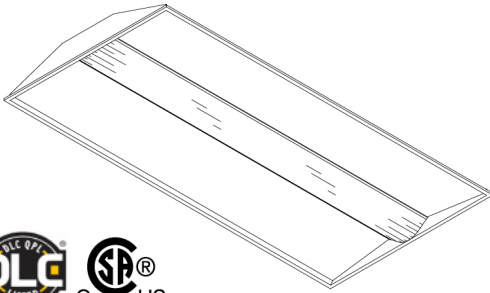

### PRODUCT DESCRIPTION:

The Center Basket LED Eco fixture combines the function of a traditional troffer while adding an aesthetically pleasing architectural look and feel. The diffuser provides excellent light distribution, while also masking the unsightly pixilation created by the LED diodes. The Center Basket LED Eco fixture is an efficient, affordable alternative to fluorescent.

### FEATURES:

- Soft white, low glare diffuser
- Engineered diffuser to maximize LED performance
- Available shroud accessory for surface mounting
- 0 - 10v Dimming standard
- Integrated T-grid clips
- Limited warranty: 5 years on luminaire

### APPLICATIONS:

- New Construction
- Renovation
- Retrofit
- Conference Rooms
- Offices
- Classrooms
- Hospitals

### ORDER GUIDE:

Series	Length	Width	# of Boards	Type	Line Voltage	Reflector	Color Temp	Lumens/Watts	Options
C	Center Basket Troffer Eco	4 4 Foot	24 2x4	2 2 Boards	SS LED	1 Universal (120/277)	B Ballast/ Driver Cover	5 5000K	2x4 Fixture 4000K
								4 4000K	A 3300/ 31w
								3 3500K	B 3940/ 39w
									C 4700/ 46w
									D 5340/ 51w



## LED CENTER BASKET TROFFER ECO 2x2

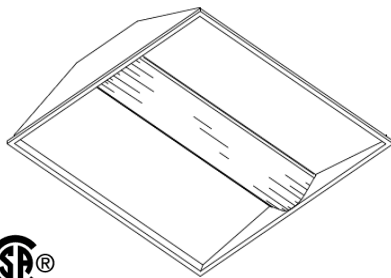

### PRODUCT DESCRIPTION:

The Center Basket LED Eco fixture combines the function of a traditional troffer while adding an aesthetically pleasing architectural look and feel. The diffuser provides excellent light distribution, while also masking the unsightly pixilation created by the LED diodes. The Center Basket LED Eco fixture is an efficient, affordable alternative to fluorescent.

### FEATURES:

- Soft white, low glare diffuser
- Engineered diffuser to maximize LED performance
- Available shroud accessory for surface mounting
- 0 - 10v Dimming standard
- Integrated T-grid clips
- Limited warranty: 5 years on luminaire

### APPLICATIONS:

- New Construction
- Renovation
- Retrofit
- Conference Rooms
- Offices
- Classrooms
- Hospitals

### ORDER GUIDE:

Series	Length		Width		# of Boards		Type		Line Voltage		Reflector		Color Temp		Lumens/Watts		Options
	2	2 Foot	24	2x2	2	2 Boards	SS	LED	1	Universal (120/277)	B	Ballast/ Driver Cover	5	5000K	2x2 Fixture 4000K		
C	Center Basket Troffer Eco												4	4000K	A	3030/ 29w	0E00 Please see Accessories Guide in front of catalog
													3	3500K	B	3490/ 34w	
														C	4220/ 42w		
														D	5100/ 51w		



## LED CENTER BASKET TROFFER 1x4

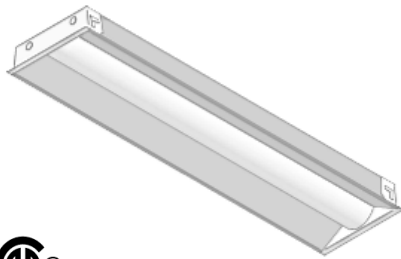

### PRODUCT DESCRIPTION:

The Center Basket LED fixture combines the function of a traditional troffer, while adding an aesthetically pleasing architectural look and feel. The diffuser provides excellent light distribution, while also masking the unsightly pixilation created by the LED diodes. The Center Basket LED fixture is an efficient, affordable alternative to fluorescent.

### FEATURES:

- Soft white, low glare diffuser
- Engineered diffuser to maximize LED performance
- Available shroud accessory for surface mounting
- 0-10v Dimming standard
- Integrated T-grid clips
- Limited warranty: 5 years on luminaire

### APPLICATIONS:

- New Construction
- Renovation
- Retrofit
- Conference Rooms
- Offices
- Classrooms
- Hospitals

### ORDER GUIDE:

Series	Length	Width	# of Boards	Type	Line Voltage	Reflector	Color Temp	Lumens/Watts	Options
C	Center Basket Troffer	4 4 Foot	12 1x4	2 2 Boards	SS LED	1 Universal (120/277)	B Ballast/ Driver Cover	5 5000K	1x4 Fixture 4000K
								4 4000K	A 3310/ 31w
								3 3500K	B 3730/ 38w
									C 4450/ 45w
									D 5060/ 51w





## LED TROFFER 2X4



### PRODUCT DESCRIPTION:

The LED Troffer 2x4 is the most economical solution for troffer lighting. TechBrite's LED Troffer utilizes a prismatic clouded lens engineered to mask the unsightly pixilation created by the LED diodes, while delivering a smoothing, visually appealing appearance. The narrow depth of the LED Troffer 2x4 makes it an ideal choice for reduced plenum heights.

### FEATURES:

- Lower glare than traditional P12 prismatic lens
- Up to 140 LPW
- DLC Premium
- Available in 2x2 and 2x4 (See 2x2 spec sheet for details)
- 0-10v Dimming standard
- Limited warranty: 5 years on luminaire

### APPLICATIONS:

- Office
- Schools
- Universities
- Fitness Rooms
- Hospitals
- Commercial
- Industrial

### ORDER GUIDE:

Series		Length		Width		Type		Line Voltage		Reflector		Color Temp		Lumens/Watts		Options	
L	LED Troffer	4	4 Foot	24	2x4	SS	LED	1	Universal (120/277)	B	Ballast/ Driver Cover	50	5000K	2x4 Fixture 4000K		C000 (cloud lens) Please see Accessories Guide in front of catalog	
												40	4000K	A	4060/ 30w		
												35	3500K	B	5320/ 40w		
												30	3000K	C	6670/ 49w		
														D	7610/ 58w		



## LED TROFFER 2X2



### PRODUCT DESCRIPTION:

The LED Troffer 2x2 is the most economical solution for troffer lighting. TechBrite's LED Troffer utilizes a prismatic clouded lens engineered to mask the unsightly pixilation created by the LED diodes, while delivering a smoothing, visually appealing appearance. The narrow depth of the LED Troffer 2x2 makes it an ideal choice for reduced plenum heights.

### FEATURES:

- Lower glare than traditional P12 prismatic lens
- Up to 125 LPW
- Available in 2x2 and 2x4 (See 2x4 spec sheet for details)
- 0-10v Dimming standard
- Limited warranty: 5 years on luminaire

### APPLICATIONS:

- Office
- Schools
- Universities
- Fitness Rooms
- Hospitals
- Commercial
- Industrial

### ORDER GUIDE:

Series		Length		Width		Type		Line Voltage		Reflector		Color Temp		Lumens/Watts		Options	
L	LED Troffer	2	2 Foot	24	2x2	SS	LED	1	Universal (120/277)	B	Ballast/Driver Cover	50	5000K	2x2 Fixture 4000K		<b>0000</b> Please see Accessories Guide in front of catalog	
												40	4000K	A	2640/ 22w		
												35	3500K	B	3100/ 26w		
												30	3000K	C	3570/ 29w		
														D	4350/ 35w		



## LED TROFFER ECO 2X4



### PRODUCT DESCRIPTION:

The LED Troffer 2x4 Eco is the most economical solution for troffer lighting. It utilizes a prismatic clouded lens engineered to mask the unsightly pixilation created by the LED diodes, while delivering a smoothing, visually appealing appearance. The narrow depth of TechBrite's LED Troffer 2x4 Eco makes it an ideal choice for reduced plenum heights.

### FEATURES:

- Lower glare than traditional P12 prismatic lens
- Designed for optimal general ambient lighting for recessed applications
- Available in 2x2 and 2x4 (See 2x2 spec sheet for details)
- 0-10v Dimming standard
- Limited warranty: 5 years on luminaire

### APPLICATIONS:

- Office
- Schools
- Universities
- Fitness Rooms
- Hospitals
- Commercial
- Industrial

### ORDER GUIDE:

Series		Length		Width		Type		Line Voltage		Reflector		Color Temp		Lumens/Watts		Options	
LT	LED Troffer Eco Kit	4	4 Foot	24	2x4	SS	LED	1	Universal (120/277)	B	Ballast/Driver Cover	50	5000K	2x4 Kit 4000K		0000 Please see Accessories Guide in front of catalog	
												40	4000K	A	3810/ 31w		
												35	3500K	B	4240/ 35w		
												30	3000K	C	4980/ 42w		
														D	5880/ 50w		



## LED TROFFER ECO 2X2



### PRODUCT DESCRIPTION:

The LED Troffer 2x2 Eco is the most economical solution for troffer lighting. TechBrite's LED Troffer utilizes a prismatic clouded lens engineered to mask the pixilation created by the LED diodes while delivering a smoothing, visually appealing appearance. The narrow depth of TechBrite's LED Troffer 2x2 Eco makes it an ideal choice for reduced plenum heights.

### FEATURES:

- Lower glare than traditional P12 prismatic lens
- Designed for optimal general ambient lighting for recessed applications
- Available in 2x2 and 2x4 (See 2x4 spec sheet for details)
- 0-10v Dimming standard
- Limited warranty: 5 years on luminaire

### APPLICATIONS:

- Office
- Schools
- Universities
- Fitness Rooms
- Hospitals
- Commercial
- Industrial

### ORDER GUIDE:

Series		Length		Width		Type		Line Voltage		Reflector		Color Temp		Lumens/Watts		Options	
LT	LED Troffer Eco Kit	2	2 Foot	24	2x2	SS	LED	1	Universal (120/277)	B	Ballast/Driver Cover	50	5000K	2x2 Kit 4000K		0000 Please see Accessories Guide in front of catalog	
												40	4000K	A	2590/ 24w		
												35	3500K	B	2920/ 27w		
												30	3000K	C	3380/ 31w		
														D	3620/ 34w		



## LED FLAT PANEL



## PRODUCT DESCRIPTION:

TechBrite's LED Flat Panel is the obvious choice for an architectural grade office fixture. Designed to be recessed in an acoustical tile ceiling, panels can also be surface or suspension mounted. Achieve 130 LPW in the most efficient models, complete with 7 year warranty. The TechBrite LED Flat Panel is the perfect solution for retrofitting existing spaces or new construction.

## FEATURES:

- 60,000 hour rated life
- 0-10v Dimming standard
- Glare-free for improved aesthetics
- Integral T-bar clips for easy installation
- 3500K, 4000K, 5000K
- Available in 2x2, 2x4 and 1x4
- Limited warranty: 7 years on luminaire

## APPLICATIONS:

- Offices
- Schools
- Universities
- Hospitals
- Fitness Rooms
- Retail

## ORDER GUIDE:

Part Number	Lumens	Watts	LPW	Volt	Color	Description	Dimensions	DLC
KT-PLED30-22-840-VDIM-P	3800	30	127	120-277	4000K	2x2 LED Flat Panel	23.74x23.74x1.74 (inches)	Premium
KT-PLED40-22-840-VDIM	4100	40	103	120-277	4000K	2x2 LED Flat Panel	23.74x23.74x1.74 (inches)	Standard
KT-PLED40-24-840-VDIM-P	5050	40	126	120-277	4000K	2x4 LED Flat Panel	47.76x23.74x1.74 (inches)	Premium
KT-PLED50-24-840-VDIM	5200	50	104	120-277	4000K	2x4 LED Flat Panel	47.76x23.74x1.74 (inches)	Standard
KT-PLED40-14-840-VDIM-P	5000	40	125	120-277	4000K	1x4 LED Flat Panel	47.76x11.87x1.74 (inches)	Premium
KT-PLED40-14-840-VDIM	4100	40	103	120-277	4000K	1x4 LED Flat Panel	47.76x11.87x1.74 (inches)	Standard





## SOTA 4' FIXTURE—LED



### PRODUCT DESCRIPTION:

The SOTA LED Fixture is the quick, easy, and economical way to modernize any commercial and industrial space. TechBrite's SOTA LED Fixture blends high LPW—as much as 135 LPW—with an economical design. The polycarbonate lens is specifically designed for maximum light distribution. New construction or retrofitting an existing space, the SOTA LED Fixture is the perfect solution.

### FEATURES:

- Up to 135 LPW
- Wireless control ready
- 4 Foot and 8 foot (See 8 foot spec sheet for details)
- Surface or suspended mount
- Continuous row mounting available
- 0-10v Dimming standard
- Limited warranty: 5 years on luminaire

### APPLICATIONS:

- Warehouses
- Industrial
- Retail
- Schools
- Offices
- Commercial
- Industrial

### ORDER GUIDE:

Series		Length		Width		Type		Line Voltage	Reflector	Color Temp		Lumens/ Watts (4000K)		Options		
SL	SOTA	4	4 Foot	4	4.25"	SS	LED	1	Universal (120/277)	B	Ballast Cover	50*	5000K	A*	2660/ 20w	L000 (lens) Please see Accessories Guide in front of catalog
												40*	4000K	B*	3620/ 28w	
												30	3000K	C	4920/ 41w	
														D	5690/ 49w	
														E	6390/ 59w	

\* A and B lumen packages in 4000K and 5000K are DLC Premium. All other packages are standard.



## SOTA 8' FIXTURE – LED



### PRODUCT DESCRIPTION:

The SOTA LED Fixture is the quick, easy, and economical way to modernize any commercial and industrial space. TechBrite's SOTA LED Fixture blends high LPW—as much as 140 LPW—with an economical design. The polycarbonate lens is specifically designed for maximum light distribution. New construction or retrofitting an existing space, the SOTA LED Fixture is the perfect solution.

### FEATURES:

- Up to 138 LPW
- Wireless control ready
- 4 Foot and 8 foot (See 4 foot spec sheet for details)
- Surface or suspended mount
- Continuous row mounting available
- 0-10v Dimming standard
- Limited warranty: 5 years on luminaire

### APPLICATIONS:

- Warehouses
- Industrial
- Schools
- Offices
- Retail
- Commercial
- Industrial

### ORDER GUIDE:

Series		Length		Width		Type		Line Voltage		Reflector		Color Temp		Lumens/ Watts (4000K)		Options	
SL	SOTA	8	8 Foot	4	4.25"	SS	LED	1	Universal (120/277)	B	Ballast Cover	50*	5000K	A*	3770/ 28w	L000 (lens) Please see Accessories Guide in front of catalog	
												40*	4000K	B*	5570/ 41w		
												30	3000K	C*	7250/ 56w		
														D*	9020/ 72w		
														E	11020/ 92w		

\* A, B, C and D lumen packages in 5000K— DLC Premium \* A, B and C in 4000K—DLC Premium. All other packages—DLC Standard



## LED QUICK STRIP—4'



### PRODUCT DESCRIPTION:

The Quick Strip LED is a quick, economical way to improve the look of any commercial space, while lowering wattages and improving light output. Constructed with quality pre-painted steel designed for superior light distribution, the Quick Strip LED builds on the traditional strip fixture by adding a stylish diffuser.

### FEATURES:

- Available with and without a lens
- Surface or pendant mounting
- Continuous row mounting available
- 4 Foot and 8 foot available (See 8 foot spec sheet for details)
- 0-10v Dimming standard
- Limited warranty: 5 years on luminaire
- Up to 130 LPW

### APPLICATIONS:

- Warehouses
- Industrial
- Garage
- Retail
- Healthcare
- Offices

### ORDER GUIDE:

Series	Length	Width	Type	Line Voltage	Reflector	Color Temp	Lumens/Watts	Options
QS Quick Strip	4 4 Foot	4 4.5"	SS LED	1 Universal (120/277)	B Ballast/Driver Cover	50 5000K	4FT Fixture 5000K With Lens	L000 (lens) 0000 (no lens) Please see Accessories Guide in front of catalog
						40 4000K	A 5390/ 45w	
						35 3500K	B 6160/ 52w	
							C* 7050/ 55w	
							D* 9340/ 72w	
							E 10570/ 89w	

\* DLC Premium



## LED QUICK STRIP—8'



### PRODUCT DESCRIPTION:

The Quick Strip LED is a quick, economical way to improve the look of any commercial space while lowering wattages and improving light output. Constructed with quality pre-painted steel designed for superior light distribution, the Quick Strip LED builds on the traditional strip fixture by adding a stylish diffuser.

### FEATURES:

- Available with and without a lens
- Surface or pendant mounting
- Continuous row mounting available
- 4 Foot and 8 foot available (See 4 foot spec sheet for details)
- 0-10v Dimming standard
- Limited warranty: 5 years on luminaire
- LPW > 140

### APPLICATIONS:

- Warehouses
- Industrial
- Garage
- Retail
- Healthcare
- Offices

### ORDER GUIDE:

Series		Length		Width		Type		Line Voltage		Reflector		Color Temp		Lumens/Watts		Options	
QS	Quick Strip	8	8 Foot	4	4.5"	SS	LED	1	Universal (120/277)	B	Ballast/Driver Cover	50	5000K	8FT Fixture 5000K With Lens		<b>L000 (lens) 0000 (no lens)</b> Please see Accessories Guide in front of catalog	
												40	4000K	A	6100/ 42w		
												35	3500K	B	6930/ 49w		
														C	8130/ 59w		
														D	9750/ 73w		
														E	11350/ 89w		





## LED STRIP FIXTURE — 4FT



### PRODUCT DESCRIPTION:

The LED Strip Fixture is the workhorse for commercial and industrial applications. TechBrite's LED Strip Fixture is easy to install and compact, making it an ideal solution for dozens of applications. The LED Strip Fixture is available in lumen packages from 2,360 to 11,500 lumens, making it the perfect solution for any environment.

### FEATURES:

- Up to 140 LPW
- Continuous row mounting available
- Available in 4' and 8' (See 8' spec sheet for details)
- 0-10v Dimming standard
- Limited warranty: 5 years on luminaire

### APPLICATIONS:

- Warehouses
- Industrial
- Garages
- Retail
- Commercial

### ORDER GUIDE:

Series	Length	Width	Type	Line Voltage	Reflector	Color Temp		Lumens/Watts		Options						
T	Strip Fixture LED	4	4 Foot	4	4.25"	SS	LED	1	Universal (120/277)	B	Ballast/Driver Cover	50	5000K	4FT Fixture 5000K		0000 Please see Accessories Guide in front of catalog
												40	4000K	A	5700/ 45w	
												35	3500K	B	6450/ 52w	
														C	7590/ 55w	
														D	9870/ 72w	
														E	11550/ 89w	





## LED STRIP FIXTURE — 8 FT



### PRODUCT DESCRIPTION:

The LED Strip Fixture is the workhorse for commercial and industrial applications. TechBrite's LED Strip Fixture is easy to install and compact, making it an ideal solution for dozens of applications. The LED Strip Fixture is available in lumen packages from 6,300 to 12,000 lumens, making it the perfect solution for any environment.

### FEATURES:

- Up to 150 LPW
- Continuous row mounting available
- Available in 4' and 8' (See 4' spec sheet for details)
- 0-10v Dimming standard
- Limited warranty: 5 years on luminaire

### APPLICATIONS:

- Warehouses
- Industrial
- Garages
- Retail
- Commercial

### ORDER GUIDE:

Series	Length	Width	Type	Line Voltage	Reflector	Color Temp	Lumens/Watts	Options								
T	Strip Fixture LED	8	8 Foot	4	4.25"	SS	LED	1	Universal (120/277)	B	Ballast/Driver Cover	5	5000K	8FT Fixture 5000K	0000 Please see Accessories Guide in front of catalog	
												4	4000K	A		6300/ 42w
												3	3500K	B		7110/ 49w
														C		8590/ 59w
														D		10290/ 73w
														E	12120/ 89w	



## LED NARROW LENS STRIP

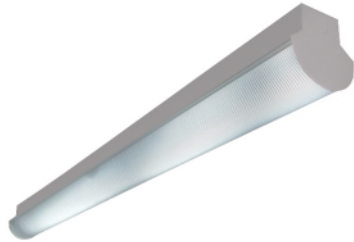

### PRODUCT DESCRIPTION:

The LED Narrow Lens Strip is the perfect solution for nearly every retail and commercial space. TechBrite's LED Narrow Lens Strip can be surface mounted or pendant mounted, providing easy installation options. The driver is dimmable, allowing for optimal end user control. The LED Narrow Lens Strip fixture is an efficient and affordable alternative to fluorescent.

### FEATURES:

- Architectural linear lighting fixture
- Surface or pendant mounting
- Lightweight for easy installation
- 0-10v Dimming standard
- Limited warranty: 5 years on luminaire
- Individual or continuous row mounting—joiner available

### APPLICATIONS:

- Warehouses
- Industrial
- Display Applications
- Retail
- Healthcare

### ORDER GUIDE:

Series	Length	Width		# of Boards		Type		Line Voltage	Reflector		Color Temp		Lumens/Watts		Options
		4	3	2	SS	LED	BC		Ballast/Driver Cover	5	4	3	A	B	
N	Narrow Lens Strip	4 Foot	3.65"	2 Boards	SS	LED	1	Universal (120/277)	BC	Ballast/Driver Cover	5	5000K	4000K		0000 Please see Accessories Guide in front of catalog
											4	4000K	A	3070/ 28w	
											3	3500K	B	3460/ 33w	
													C	4320/ 42w	
													D	5350/ 52w	

## LED CORRIDOR FIXTURE—2'

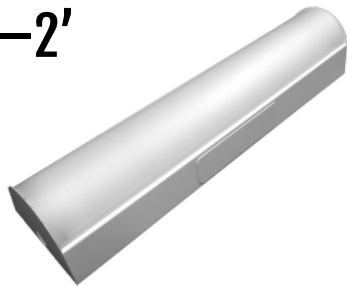

### PRODUCT DESCRIPTION:

TechBrite's LED Corridor Fixture blends multi-use with a sleek design. It features an advanced diffuser design—engineered with a technical specification to increase light distribution and mask the unsightly pixilation created by the LED diodes. The TechBrite LED Corridor Fixture is a versatile, affordable and valuable addition to the LED fixture offering.

### FEATURES:

- Integral sensor available
- Soft white, low glare diffuser
- Engineered diffuser to maximize LED performance
- LPW > 130
- 0-10v Dimming standard
- Limited warranty: 5 years on luminaire

### APPLICATIONS:

- Corridors
- Stairwells
- Vanity
- Retail
- Commercial
- Healthcare

### ORDER GUIDE:

Series	Length	Width	Type	Line Voltage	Reflector	Color Temp	Lumens/Watts	Options
SC Corridor Fixture	2 2 Foot	5 5"	SS LED	1 Universal (120/277)	B Ballast/Driver Cover	50 5000K	2FT 4000K	0000 Please see Accessories Guide in front of catalog
						40 4000K	B 2110/ 18w	
						35 3500K	C 3160/ 25w	
						30 3000K	D 4090/ 34w	

## LED CORRIDOR FIXTURE—4'

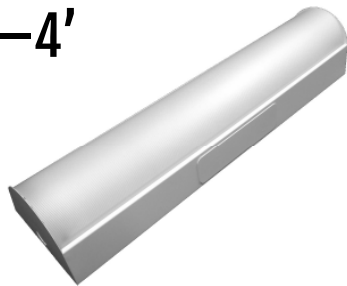

### PRODUCT DESCRIPTION:

TechBrite's LED Corridor Fixture blends multi-use with a sleek design. It features an advanced diffuser design—engineered with a technical specification to increase light distribution and mask the unsightly pixilation created by the LED diodes. The TechBrite LED Corridor Fixture is a versatile, affordable and valuable addition to the LED fixture offering.

### FEATURES:

- Integral sensor available
- Soft white, low glare diffuser
- Engineered diffuser to maximize LED performance
- LPW > 130
- 0-10v Dimming standard
- Limited warranty: 5 years on luminaire

### APPLICATIONS:

- Corridors
- Stairwells
- Vanity
- Retail
- Commercial
- Health Care

### ORDER GUIDE:

Series	Length	Width	Type	Line Voltage	Reflector	Color Temp	Lumens/Watts	Options
SC Corridor Fixture	4 4 Foot	5 5"	SS LED	1 Universal (120/277)	B Ballast/ Driver Cover	50 5000K	4FT 4000K	0000 Please see Accessories Guide in front of catalog
						40 4000K	A 2280/ 17w	
						35 3500K	B 3340/ 25w	
						30 3000K	C 4270/ 34w	
							D 6010/ 49w	



## LED SURFACE WRAP



### PRODUCT DESCRIPTION:

The LED Surface Wrap is the classic, all-purpose fixture for nearly every commercial and industrial setting. It features an engineered prismatic lens that both increases the light output and masks the LED diodes delivering a smooth, visually appealing look. For a quick and economic replacement of T12 or T8 wraps, the TechBrite LED Surface Wrap is the perfect solution.

### FEATURES:

- Surface mounted general ambient lighting
- Up to 120 LPW
- Clear acrylic prismatic lens
- Low-profile, heavy-gauge steel housing
- Limited warranty: 5 years on luminaire
- 0-10v Dimming standard

### APPLICATIONS:

- Office
- Schools
- Universities
- Hospitals
- Fitness Rooms
- Retail
- Commercial

### ORDER GUIDE:

Series	Length	Width	Type	Line Voltage	Reflector	Color Temp	Lumens/Watts	Options
S	Surface Wrap LED	4 4 Foot	9 9"	SS LED 1	Universal (120/277)	BC Ballast/Driver Cover	5 5000K	<b>0000</b> Please see Accessories Guide in front of catalog
						4 4000K	A 3650/ 30w	
						3 3500K	B 4150/ 34w	
							C 4970/ 41w	
							D 5910/ 50w	





## LED LOW BAY



### PRODUCT DESCRIPTION:

The TechBrite LED Low Bay is the perfect solution for commercial or industrial applications requiring lower light levels than a high bay. Designed to replace metal halides, T8, or T5 high bays, the Low Bay is an economical choice for retrofit or new construction. The cost-effective Low Bay will quickly become your “go-to” LED Low Bay.

### FEATURES:

- LPW > 140
- Fully enclosed fixture
- 0-10v Dimming standard
- Easy to install 2 foot design
- Customize with countless adders
- Limited warranty: 5 years on luminaire

### APPLICATIONS:

- Ideal replacement for traditional HID fixtures
- Warehouses
- Storage Facilities
- Manufacturing
- Task Lighting
- Gymnasiums

### ORDER GUIDE:

Series	Length	Width	# of Boards	Type	Line Voltage	Reflector	Color Temp	Lumens/Watts	Options
LB Low Bay	2	2 Foot	20 20"	4 4 Boards	SS LED	1 Universal (120/277)	B Ballast/ Driver Cover	5 5000K	<b>0000</b> Please see Accessories Guide in front of catalog
					2 480v		4 4000K	A 13020/ 46w	
							3 3500K	B 15730/ 58w	
								C 20100/ 73w	
								D 25370/ 87w	
								E 28760/ 94w	

## LED EXPRESS BAY



### PRODUCT DESCRIPTION:

The LED Express Bay is one of TechBrite’s best sellers for good reasons. The nominal 2x2 design is compact, yet large enough to allow for a wide variety of features. Designed to replace metal halides, T8, or T5 high bays, the Express Bay is an economical choice for retrofit or new construction. The cost-effective Express Bay will quickly become your “go-to” LED high bay.

### FEATURES:

- LPW > 160
- Fully enclosed fixture
- 0-10v Dimming standard
- Easy to install 2 foot design
- Customize with countless adders
- Limited warranty: 5 years on luminaire

### APPLICATIONS:

- Ideal replacement for traditional HID fixtures
- Warehouses
- Storage Facilities
- Manufacturing
- Task Lighting
- Gymnasiums

### ORDER GUIDE:

Series	Length	Width	# of Boards	Type	Line Voltage	Reflector	Color Temp	Lumens/ Watts	Options
EB Express Bay	2 2 Foot	20 20"	4 4 Boards	SS LED	1 Universal (120/277)	B Ballast/ Driver Cover	5 5000K	5000K	0000 Please see Accessories Guide in front of catalog
					2 347-480		4 4000K	C 13020/ 79w	
							3 3500K	D 15730/ 97w	
								E 20100/ 127w	
								F 25370/ 164w	
								G 28760/ 188w	



## LED BAYBRITE HIGH BAY



### PRODUCT DESCRIPTION:

The LED BayBrite High Bay is TechBrite's original LED high bay. The swing-away module tray makes future maintenance a breeze. Designed to replace metal halides or strips in retro fit applications, it is an ideal new construction fixture for industrial applications. The LED BayBrite High Bay is heavy on features, while maintaining a budget-friendly price point.

### FEATURES:

- L85 > 100,000
- Fully enclosed fixture
- Heavy gauge construction
- 0-10v Dimming standard
- Limited warranty: 5 years on luminaire
- 140 LPW

### APPLICATIONS:

- Ideal replacement for traditional HID fixtures
- Warehouses
- Storage Facilities
- Manufacturing
- Tasking Lighting
- Gymnasiums

### ORDER GUIDE:

Series	Length	Width	# of LED Boards	Type	Line Voltage	Reflector	Color Temp	Lumens/Watts	Options
B BayBrite High Bay	4 4 Foot	14 14"	8 8/ 14210 Lumens	SS LED	1 Universal (120/277)	B Ballast/ Driver Cover	5 5000K	5000K Fixture	0000 Please see Accessories Guide in front of catalog
			6 6/ 19610 Lumens				4 4000K	L 14210/ 121w	
			8 8/ 24480 Lumens				3 3500K	N 19610/ 138w	
								H 24480/ 176w	

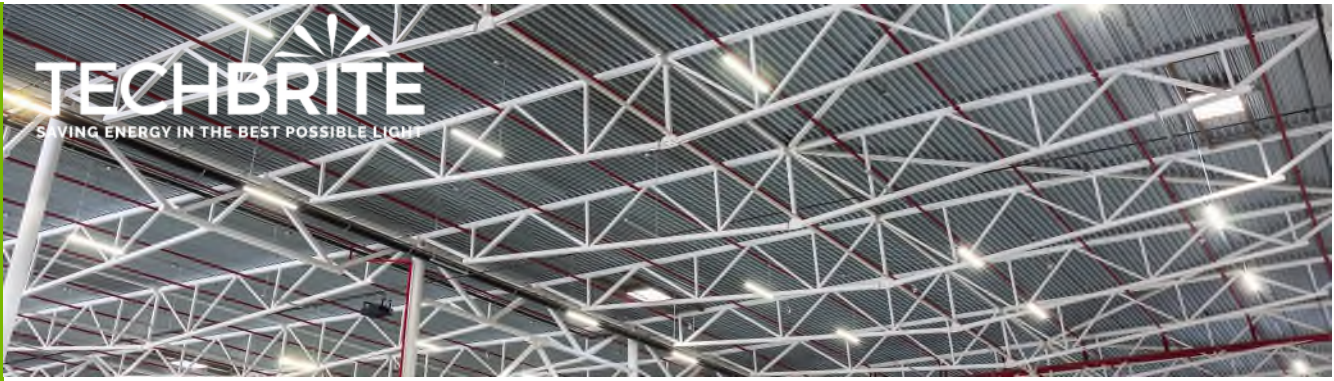

## LED NARROW HIGH BAY—4'

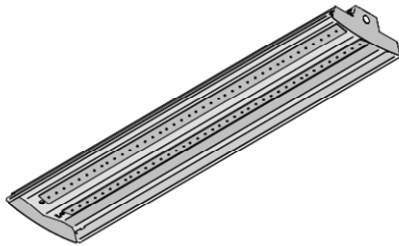

### PRODUCT DESCRIPTION:

The Narrow Bay LED offers a great solution to higher lumen requirements, while providing a smaller footprint than a traditional hi-bay. The diffuser enables excellent light distribution, and masks the unsightly pixilation created by the LED diodes. When the project's scope requires an economical and aesthetically pleasing design, TechBrite's Narrow Bay LED is the perfect fit.

### FEATURES:

- Perfect for retail applications
- Optional lens
- LPW > 140
- Fully enclosed fixture
- 0-10v Dimming standard
- Available in 4 foot and 8 foot (See 8 foot spec sheet for details)
- Limited warranty: 5 years on luminaire

### APPLICATIONS:

- Ideal replacement for traditional HID fixtures
- Warehouses
- Storage Facilities
- Manufacturing
- Task Lighting
- Retail

### ORDER GUIDE:

Series	Length	Width	# of Boards	Type	Line Voltage	Reflector	Color Temp	Lumens/Watts	Options									
NB	Narrow High Bay	4	4 Foot	11	11"	2	2 Boards	SS	LED	1	Universal (120/277)	B	Ballast/Driver Cover	5	5000K	4' Fixture 5000K	0000 Please see Accessories Guide in front of catalog	
														4	4000K	A		6670/ 44w
														3	3500K	B		8180/ 56w
																C		10120/ 72w
																D		11800/ 87w
																E		12690/ 96w
																F	13640/ 104w	



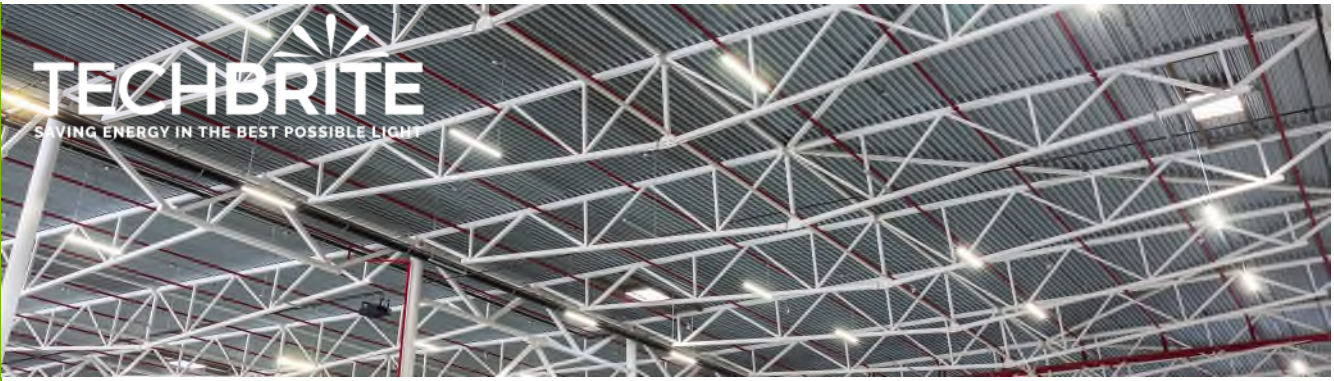

## LED NARROW HIGH BAY—8'

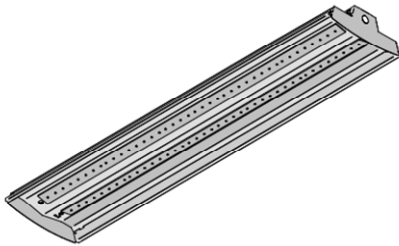

### PRODUCT DESCRIPTION:

The Narrow Bay LED offers a great solution to higher lumen requirements, while providing a smaller footprint than a traditional hi-bay. The diffuser enables excellent light distribution, and masks the unsightly pixilation created by the LED diodes. When the project's scope requires an economical and aesthetically pleasing design, TechBrite's Narrow Bay LED is the perfect fit.

### FEATURES:

- Perfect for retail applications
- Optional lens
- LPW > 140
- Fully enclosed fixture
- 0-10v Dimming standard
- Available in 4ft and 8ft lengths (See 4' spec sheet for details)
- Limited warranty: 5 years on luminaire

### APPLICATIONS:

- Ideal replacement for traditional HID fixtures
- Warehouses
- Storage Facilities
- Manufacturing
- Task Lighting
- Retail

### ORDER GUIDE:

Series	Length	Width	# of Boards	Type	Line Voltage	Reflector	Color Temp	Lumens/Watts	Options
NB Narrow High Bay	8 8 Foot	11 11"	4 4 Boards	SS LED	1 Universal (120/277)	B Ballast/Driver Cover	5 5000K	8' Fixture 5000K	0000 Please see Accessories Guide in front of catalog
							4 4000K	A 13340/ 90w	
							3 3500K	B 16370/ 113w	
								C 20240/ 145w	
								D 23600/ 174w	
								E 25380/ 194w	
								F 27280/ 208w	



## LED ULTRABAY HIGH BAY



### PRODUCT DESCRIPTION:

TechBrite's UltraBay High Bay delivers an impressive 57,000 lumens and qualifies for DLC Premium. It is an ideal replacement for 1000w metal halide. A top-seller, the UltraBay is easy to install and offers up to 60% energy savings. If you are looking for pure lumens in a commercial and industrial environment, TechBrite's UltraBay High Bay is the perfect solution.

### FEATURES:

- DLC Premium
- Up to 157 LPW
- Ideal replacement for 1000w metal halide
- Customize with countless adders
- 0-10v Dimming standard
- Limited warranty: 5 years on luminaire

### APPLICATIONS:

- Warehouses
- Storage Facilities
- Manufacturing
- Task Lighting
- Gymnasiums
- Commercial
- Industrial

### ORDER GUIDE:

Series	Length	Width	# of Boards	Type	Line Voltage	Reflector	Color Temp	Lumens/Watts	Options*
UB UltraBay High Bay	4 4 Foot	20 20"	8 8 Boards	SS LED	1 Universal (120/277)	B Ballast/Driver Cover	5 5000K	5000K	0000 Please see Accessories Guide in front of catalog
					2 480v		4 4000K	A 26380/ 163w	
							3 3500K	B 31340/ 197w	
								C 37260/ 239w	
								D 52790/ 348w	
								E 56900/ 379w	

\* Not all options qualify for DLC Premium. Contact your sales rep for more information.



## LED UFO HIGH BAY



### PRODUCT DESCRIPTION:

TechBrite's LED UFO Fixture has superior lumen performance and boasts over 140 LPW in the most efficient lumen packages. The magnesium alloy allows heat to transfer efficiently, allowing for improved operating temperatures and longer life. Replace existing metal halide, T8, or T5 while improving light output and efficiencies. The IP65 rating allows for maximum placement flexibility.

### FEATURES:

- IP65/ Wet location
- High efficiency LED driver > 90%
- Eye hook included
- Up to 145 LPW
- Limited warranty: 5 years on luminaire
- Dark bronze
- Polycarbonate lens
- 0-10v Dimming standard

### APPLICATIONS:

- Indoor or Outdoor
- Warehouses
- Gas Stations
- Stadiums
- Retail
- Commercial
- Industrial

### ORDER GUIDE:

Part Number	Lumens	Watts	LPW	Voltage	Color	Description	Dimensions	Weight
TBUFO160W27-50K-PC-DG	23200	160	145	120-277	5000K	LED UFO High Bay	9.20 x 10.25 (inches)	10.00 lbs
TBUFO2000W27-50K-PC-DG	28000	200	140	120-277	5000K	LED UFO High Bay	9.85 x 12.60 (inches)	15.00 lbs



## LED VAPORTITE HIGH BAY



### PRODUCT DESCRIPTION:

TechBrite's LED Vaportite High Bay can take on the toughest environments. Rated IP67, the LED Vaportite High Bay is designed to minimize the retention of liquids or debris when hosed down. The standard stainless steel hardware makes it an ideal solution for most environments and is an ideal replacement for metal halide or T8 fixtures.

### FEATURES:

- Designed for tough environments
- Easy to clean and service
- Impact resistant lenses
- Up to 130 LPW
- Simple mounting system—no holes to drill!
- 0-10v Dimming standard
- Limited warranty: 5 years on luminaire

### APPLICATIONS:

- Food Processing Facilities
- Refrigerated Storage
- Parking Garages
- Breweries and Bottling Facilities
- Livestock Facilities
- Gymnasiums
- Commercial
- Industrial

### ORDER GUIDE:

Series	Length	# of Boards	Type	Voltage	Reflector	Color	Lumens/ Watts (5000K)	Options
VH Vaportite High Bay	4 4 Foot	8 8	SS LED	1 Universal (120-277)	B Ballast Cover	50 5000K	A 9930/ 84w	<b>0000</b> Please see Accessories Guide in front of catalog
						40 4000K	B 11260/ 95w	
						35 3500K	C 14210/ 119w	
							D 15450/ 118w	
							E 17580/ 136w	
							F 19990/ 156w	
							G 22750/ 179w	



## LED VAPORTITE STRIP—2'

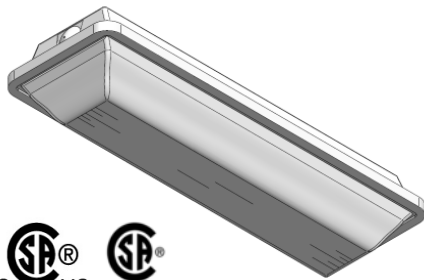

### PRODUCT DESCRIPTION:

The perfect solution for harsh conditions, TechBrite's LED Vaportite Strip is damp listed, wet listed and certified NSF/ ANSI2 Sanitation. With an IP67 rating, the LED Vaportite Strip is designed to minimize the retention of liquids or debris while hosed down. TechBrite's LED Vaportite Strip meets or exceeds all applicable NSF/ ANSI sanitation requirements.

### FEATURES:

- IP67 rated & sanitation/ NSF CSA rated
- Easy to clean and service
- Lengths of 2', 4' or 8' (See 4' and 8' spec sheets for details)
- Plastic (standard) or stainless steel
- Frosted acrylic ribbed diffuser
- 0-10v Dimming standard
- Limited warranty: 5 years on luminaire

### APPLICATIONS:

- Food Processing Facilities
- Parking Garages
- Refrigerated Storage
- Breweries and Bottling Facilities
- Livestock Facilities
- Traffic Tunnels
- Exterior
- Commercial
- Industrial

### ORDER GUIDE:

Series	Length	Width	Type	Line Voltage	Reflector	Color Temp	Lumens/ Watts	Options								
V	LED Vaportite Strip	2	2 Foot	7	7"	2SS	LED	1	Universal (120/277)	B	Ballast/ Driver Cover	50	5000K	5000K	0000 Please see Accessories Guide in front of catalog	
												40	4000K	A		3250/ 27w
												30	3500K	B		3310/ 31w
														C		4530/ 43w
														D	5470/ 51w	





## LED VAPORTITE STRIP—4'



### PRODUCT DESCRIPTION:

The perfect solution for harsh conditions, TechBrite's LED Vaportite Strip is damp listed, wet listed and certified NSF/ ANSI2 Sanitation. With an IP67 rating, the LED Vaportite Strip is designed to minimize the retention of liquids or debris when hosed down. TechBrite's LED Vaportite Strip meets or exceeds all applicable NSF/ ANSI sanitation requirements.

### FEATURES:

- IP67 rated & sanitation/ NSF CSA rated
- Easy to clean and service
- Lengths of 2', 4' or 8' (See 2' and 8' spec sheet for details)
- Plastic (standard) or stainless steel
- Frosted acrylic ribbed diffuser
- 0-10v Dimming standard
- Limited warranty: 5 years on luminaire

### APPLICATIONS:

- Food Processing Facilities
- Parking Garages
- Refrigerated Storage
- Breweries and Bottling Facilities
- Livestock Facilities
- Traffic Tunnels
- Exterior
- Commercial
- Industrial

### ORDER GUIDE:

Series	Length	Width		Type		Line Voltage		Reflector		Color Temp		Lumens/ Watts		Options	
		4	4 Foot	7	7"	4SS	LED	1	Universal (120/277)	B	Ballast/ Driver Cover	50	5000K		5000K
V	LED Vaportite Strip										40	4000K	B	4260/ 38w	0000 Please see Accessories Guide in front of catalog
											30	3500K	C	5370/ 48w	
													D	6470/ 60w	





## LED VAPORTITE STRIP—8'



### PRODUCT DESCRIPTION:

The perfect solution for harsh conditions, TechBrite's LED Vaportite Strip is damp listed, wet listed and certified NSF/ ANSI2 Sanitation. With an IP67 rating, the LED Vaportite Strip is designed to minimize the retention of liquids or debris when hosed down. TechBrite's LED Vaportite Strip meets or exceeds all applicable NSF/ ANSI sanitation requirements.

### FEATURES:

- IP67 rated & sanitation/ NSF CSA rated
- Easy to clean and service
- Lengths of 2', 4' or 8' (See 2' and 4' spec sheets for details)
- Plastic (standard) or stainless steel
- Frosted acrylic ribbed diffuser
- 0-10v Dimming standard
- Limited warranty: 5 years on luminaire

### APPLICATIONS:

- Food Processing Facilities
- Parking Garages
- Refrigerated Storage
- Breweries and Bottling Facilities
- Livestock Facilities
- Traffic Tunnels
- Exterior
- Commercial
- Industrial

### ORDER GUIDE:

Series	Length	Width	Type	Line Voltage	Reflector	Color Temp	Lumens/ Watts	Options
V	8	8 Foot	7 7"	4SS LED 1	Universal (120/277)	B Ballast/ Driver Cover	50 5000K	5000K
						40 4000K	E 7340/ 59w	0000 Please see Accessories Guide in front of catalog
						35 3500K	F 9030/ 79w	
							G 10540/ 93w	

# LED RETRO KITS

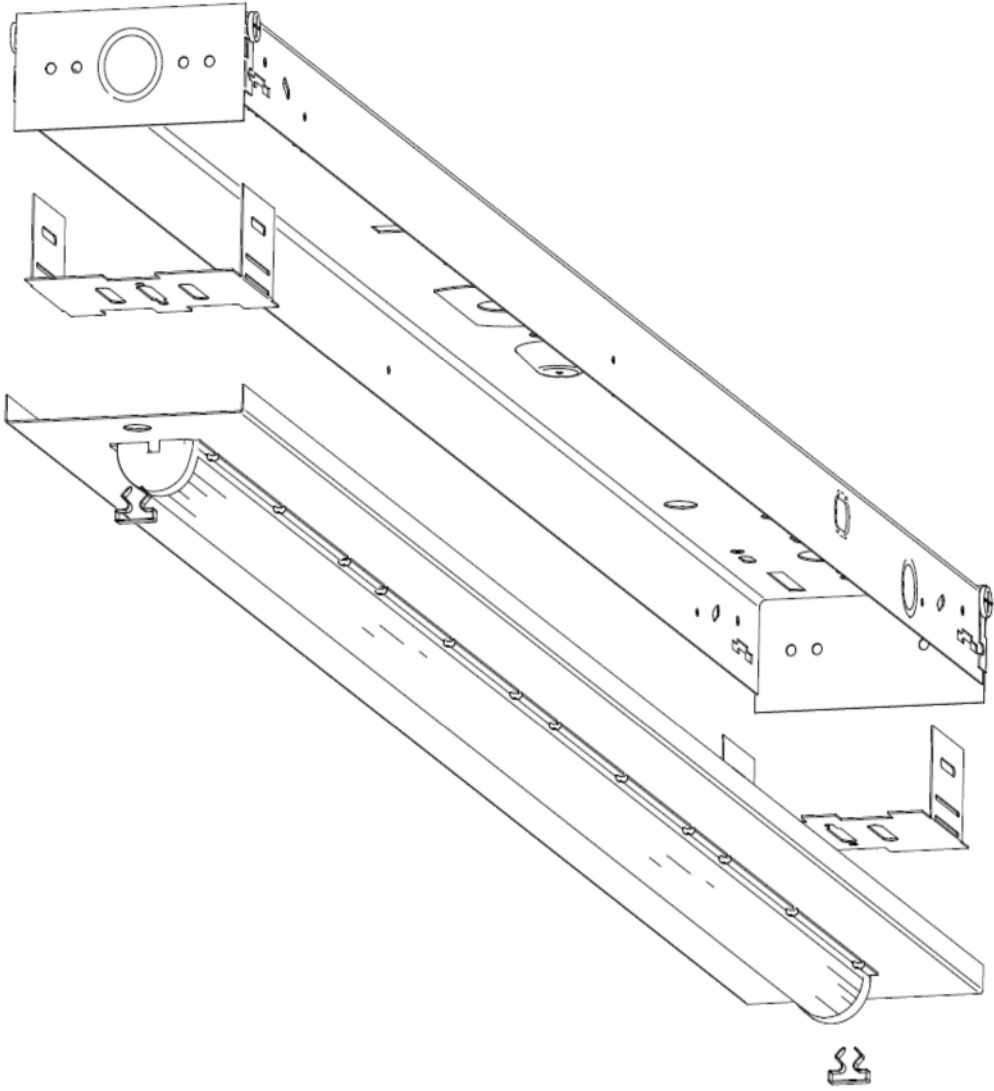



## LED CENTER BASKET RETRO TROFFER 2X4

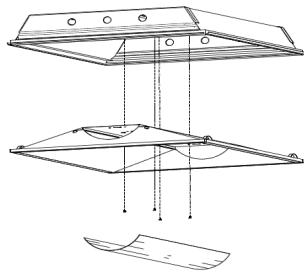

### PRODUCT DESCRIPTION:

The Center Basket Retro Troffer adds an aesthetically pleasing architectural look and feel. The kit contains the LED boards and driver; therefore, no driver to install. Wiring is as easy as connecting the power to the factory-installed disconnect. The LED Center Basket Retro Troffer is an easy way to update the look, feel and efficiency of the existing troffer.

### FEATURES:

- Architecturally styled retrofit kit
- Easy 3 step process
- Retrofit existing prismatic or parabolic fixtures
- 0-10v Dimming standard
- Available in 2x2 and 2x4 (See 2x2 spec sheet for details)
- Limited warranty: 5 years on luminaire

### APPLICATIONS:

- Existing Troffers
- Existing Parabolics
- Universities
- Government
- Hospitals

### ORDER GUIDE:

Series	Length	Width	# of Boards	Type	Line Voltage	Reflector	Color Temp	Lumens/Watts	Options									
CR	Center Basket Troffer Retro	4	4 Foot	24	2x4	2	2 Boards	SS	LED	1	Universal (120/277)	B	Ballast/Driver Cover	5	5000K	2x4 Kit 4000K	0000 Please see Accessories Guide in front of catalog	
														4	4000K	A		3890/ 32w
														3	3500K	B		4310/ 36w
																C		4920/ 43w
																	D	5750/ 52w



## LED CENTER BASKET RETRO TROFFER 2X2

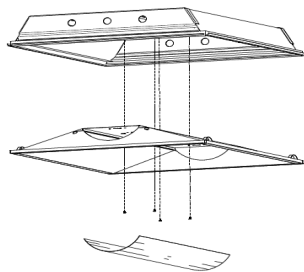

### PRODUCT DESCRIPTION:

The Center Basket Retro Troffer adds an aesthetically pleasing architectural look and feel. The kit contains the LED boards and driver; therefore, no driver to install. Wiring is as easy as connecting the power to the factory-installed disconnect. The LED Center Basket Retro Troffer is an easy way to update the look, feel and efficiency of the existing troffer.

### FEATURES:

- Architecturally styled retrofit kit
- Easy 3 step process
- Retrofit existing prismatic or parabolic fixtures
- 0-10v Dimming standard
- Available in 2x2 and 2x4 (See 2x4 spec sheet for details)
- Limited warranty: 5 years on luminaire

### APPLICATIONS:

- Existing Troffers
- Existing Parabolics
- Universities
- Government
- Hospitals

### ORDER GUIDE:

Series	Length	Width	# of Boards	Type	Line Voltage	Reflector	Color Temp	Lumens/Watts	Options									
CR	Center Basket Troffer Retro	2	2 Foot	24	2x2	2	2 Boards	SS	LED	1	Universal (120/277)	B	Ballast/Driver Cover	5	5000K	2x2 Kit 4000K	0000 Please see Accessories Guide in front of catalog	
														4	4000K	A		3330/ 28w
														3	3500K	B		3770/ 34w
																C		4490/ 43w
																D		5290/ 52w



# LED RETRO TROFFER 2X4

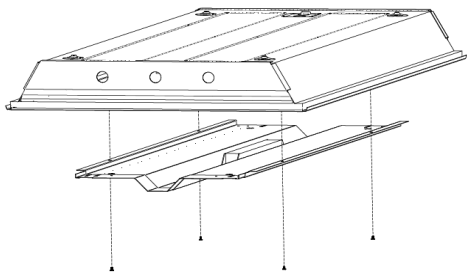

## PRODUCT DESCRIPTION:

The LED Troffer Retro Kit is the easiest way to convert an existing fluorescent troffer to an energy efficient LED troffer. It houses both the boards and the driver, eliminating an additional step of installing the driver. Simply remove the contents of the existing fluorescent troffer and install the LED Troffer Retro Kit with four tek screws.

## FEATURES:

- Save installation time with factory installed boards and drivers
- Available in 2x2 & 2x4 (See 2x2 spec sheet for details)
- Up to 140 LPW
- DLC Premium
- 0-10v Dimming standard
- Limited warranty: 5 years on luminaire

## APPLICATIONS:

- Office
- Schools
- Universities
- Fitness Rooms
- Hospitals

## ORDER GUIDE:

Series	Length	Width	Type	Line Voltage	Reflector	Color Temp	Lumens/Watts	Options
R	LED Retro Troffer Kit	4 4 Foot	24 2x4	SS LED 1	Universal (120/277)	B Ballast/Driver Cover	50 5000K	2x4 Kit 4000K
						40 4000K	A 4060/ 30w	0000 Please see Accessories Guide in front of catalog
						35 3500K	B 5320/ 40w	
						30 3000K	C 6670/ 49w	
							D 7610/ 58w	





## LED RETRO TROFFER 2X2

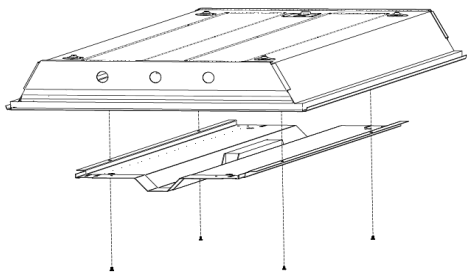

### PRODUCT DESCRIPTION:

The LED Troffer Retro Kit is the easiest way to convert an existing fluorescent troffer to an energy efficient LED troffer. The LED Troffer Retro Kit houses both the boards and the driver, eliminating an additional step of installing the driver. Simply remove the contents of the existing fluorescent troffer and install the LED Troffer Retro Kit with four tek screws.

### FEATURES:

- Save installation time with factory installed boards and drivers
- Available in 2x2 & 2x4 (See 2x4 spec sheet for details)
- Up to 120 LPW
- 0-10v Dimming standard
- Limited warranty: 5 years on luminaire

### APPLICATIONS:

- Office
- Schools
- Universities
- Fitness Rooms
- Hospitals

### ORDER GUIDE:

Series	Length	Width	Type	Line Voltage	Reflector	Color Temp	Lumens/Watts	Options								
R	LED Retro Troffer Kit	2	2 Foot	24	2x2	SS	LED	1	Universal (120/277)	B	Ballast/Driver Cover	50	5000K	2x2 Kit 4000K		0000 Please see Accessories Guide in front of catalog
												40	4000K	A	2640/ 22w	
												35	3500K	B	3100/ 26w	
												30	3000K	C	3570/ 29w	
														D	4350/ 35w	



## LED RETRO TROFFER ECO 2x4

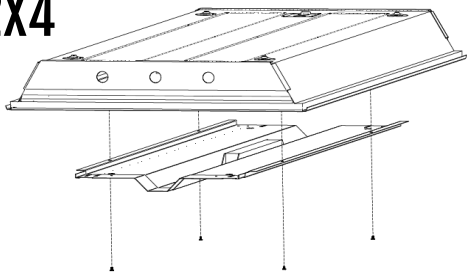

### PRODUCT DESCRIPTION:

The LED Retro Troffer Eco Kit is the easiest way to convert an existing fluorescent troffer to an energy efficient LED troffer. It houses both the boards and the driver, eliminating an additional step of installing the driver. Simply remove the contents of the existing fluorescent troffer and install the LED Retro Troffer Eco Kit with four tek screws.

### FEATURES:

- Save installation time with factory installed boards and drivers
- Available in 2x2 & 2x4 (See 2x2 spec sheet for details)
- Kit includes: LED boards, LED driver, mounting screws
- 0-10v Dimming standard
- Limited warranty: 5 years on luminaire

### APPLICATIONS:

- Office
- Schools
- Universities
- Fitness Rooms
- Hospitals

### ORDER GUIDE:

Series	Length	Width	Type	Line Voltage	Reflector	Color Temp	Lumens/Watts	Options
RT LED Troffer Retro Eco Kit	4	4 Foot	24 2x4	SS LED 1	Universal (120/277)	B Ballast/Driver Cover	50 5000K	2x4 Kit 4000K
							40 4000K	A 3810/ 31w
							35 3500K	B 4240/ 35w
							30 3000K	C 4980/ 42w
								D 5880/ 50w

0000  
Please see  
Accessories Guide  
in front of catalog



## LED RETRO TROFFER ECO 2X2

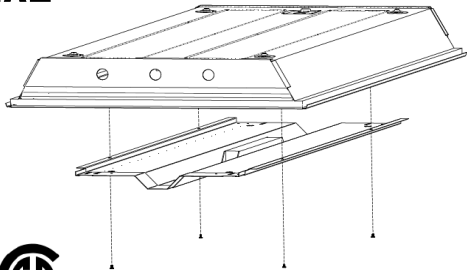

### PRODUCT DESCRIPTION:

The LED Retro Troffer Eco Kit is the easiest way to convert an existing fluorescent troffer to an energy efficient LED troffer. The LED Retro Troffer Eco Kit houses both the boards and the driver eliminating an additional step of installing the driver. Simply remove the contents of the existing fluorescent troffer and install the LED Retro Troffer Eco Kit with four tek screws.

### FEATURES:

- Save installation time with factory installed boards and drivers
- Available in 2x2 & 2x4 (See 2x4 spec sheet for details)
- Kit includes: LED boards, LED driver, mounting screws
- 0-10v Dimming standard
- Limited warranty: 5 years on luminaire

### APPLICATIONS:

- Office
- Schools
- Universities
- Fitness Rooms
- Hospitals

### ORDER GUIDE:

Series	Length	Width	Type	Line Voltage	Reflector	Color Temp	Lumens/Watts	Options
RT LED Retro Troffer Eco Kit	2	2 Foot	24 2x2 SS LED 1	Universal (120/277)	B Ballast/Driver Cover	50 5000K	2x2 Kit 4000K	0000 Please see Accessories Guide in front of catalog
						40 4000K	A 2590/ 24w	
						35 3500K	B 2920/ 27w	
						30 3000K	C 3380/ 31w	
							D 3620/ 34w	



## SOTA 4' RETRO - LED

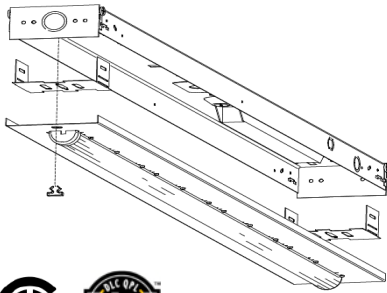

### PRODUCT DESCRIPTION:

The SOTA Retro LED is the quick, easy, and economical way to modernize any commercial and industrial space. TechBrite's SOTA Retro LED combines quality boards and drivers to attain 135 LPW in some models. The SOTA Retro LED is easily customizable with sensors, wireless controls, cords, hanging kits—just to mention a few.

### FEATURES:

- Up to 135 LPW
- Wireless control ready
- 4 Foot and 8 foot (See 8 foot spec sheet for details)
- Surface or suspended mount
- Continuous row mounting available
- 0-10v Dimming standard
- Limited warranty: 5 years on luminaire

### APPLICATIONS:

- Warehouses
- Industrial
- Retail
- Retrofit existing strip fixtures
- Schools
- Offices
- Commercial
- Industrial

### ORDER GUIDE:

Series		Length		Width		Type		Line Voltage		Reflector		Color Temp		Lumens/ Watts (4000K)		Options
SLR	SOTA Retro	4	4 Foot	4	4.25"	SS	LED	1	Universal (120/277)	B	Ballast Cover	50*	5000K	A*	2440/ 20w	L000 (lens) Please see Accessories Guide in front of catalog
												40*	4000K	B*	3320/ 28w	
												30	3000K	C	4920/ 41w	
														D	5690/ 49w	
														E	6390/ 59w	

\* A and B lumen packages in 4000K and 5000K are DLC Premium. All other packages are standard.



## SOTA 8' RETRO— LED

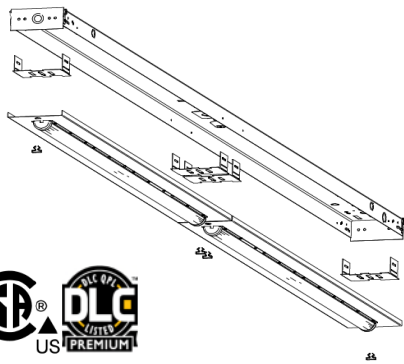

### PRODUCT DESCRIPTION:

The SOTA Retro LED is the quick, easy, and economical way to modernize any commercial and industrial space. TechBrite's SOTA Retro LED combines quality boards and drivers to attain 140 LPW in some models. The SOTA Retro LED is easily customizable with sensors, wireless controls, cords, hanging kits—just to mention a few.

### FEATURES:

- Up to 138 LPW
- Wireless control ready
- 4 Foot and 8 foot (See 4 foot spec sheet for details)
- Surface or suspended mount
- Continuous row mounting available
- 0-10v Dimming standard
- Limited warranty: 5 years on luminaire

### APPLICATIONS:

- Warehouses
- Industrial
- Retail
- Retrofit for existing strip fixtures
- Schools
- Offices
- Commercial
- Industrial

### ORDER GUIDE:

Series		Length		Width		Type		Line Voltage	Reflector		Color Temp		Lumens/ Watts (4000K)		Options	
SLR	SOTA Retro	8	8 Foot	4	4.25"	SS	LED	1	Universal (120/277)	B	Ballast Cover	50*	5000K	A*	3770/ 28w	L000 (lens) Please see Accessories Guide in front of catalog
												40*	4000K	B*	5570/ 41w	
												30	3000K	C*	7250/ 56w	
														D*	9020/ 72w	
														E	11020/ 92w	

\*A, B, C and D lumen packages in 5000K— DLC Premium. \* A, B and C in 4000K—DLC Premium. All other packages— DLC Standard.





## LED QUICK STRIP RETRO—4'

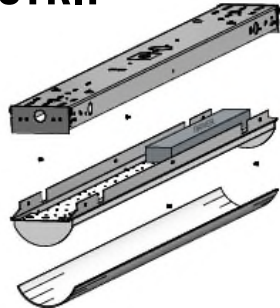

### PRODUCT DESCRIPTION:

The LED Quick Strip Retro is an economical way to improve the look of any commercial space. Retrofitting is “Quick” with the boards and drivers factory installed on the retrofit kit. Just connect the power to the factory provided disconnect and install. The LED Quick Strip Retro is the superior choice for spaces requiring an economical and aesthetically pleasing fixture.

### FEATURES:

- Mounts directly to side of existing fixture
- Available in 4 foot and 8 foot (See 8 spec sheet for details)
- 0-10v Dimming standard
- Available with and without a lens
- Expandable to multiple fixture widths—4.25” to 5.187

### APPLICATIONS:

- Warehouses
- Industrial
- Garage
- Retail
- Any Existing Strip

### ORDER GUIDE:

Series		Length		Width		Type		Line Voltage		Reflector		Color Temp		Lumens/ Watts		Options	
QSR	Quick Strip Retro	4	4 Foot	4	4.5"	SS	LED	1	Universal (120/277)	B	Ballast/ Driver Cover	50	5000K	4FT Fixture 5000K With Lens		L000 (lens) 0000 (no lens) Please see Accessories Guide in front of catalog	
												40	4000K	A	5390/ 122w		
												35	3500K	B	6160/ 115w		
														C*	7050/ 130w		
														D*	9340/ 131w		
														E	10300/ 118w		

\* DLC Premium



## LED QUICK STRIP RETRO—8'

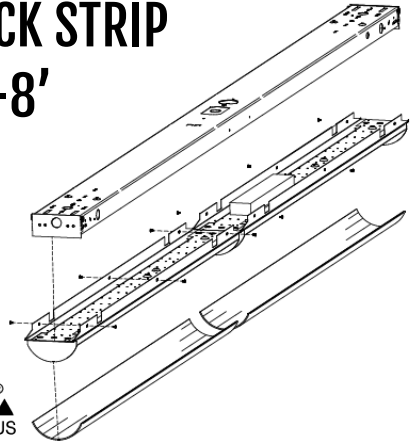

### PRODUCT DESCRIPTION:

The LED Quick Strip Retro is an economical way to improve the look of any commercial space. Retrofitting is “Quick” with the boards and drivers factory installed on the retro-fit kit. Just connect the power to the factory provided disconnect and install. The LED Quick Strip Retro is the superior choice for spaces requiring an economical and aesthetically pleasing fixture.

### FEATURES:

- Mounts directly to side of existing fixture
- Available in 4 foot and 8 foot (See 4 foot spec sheet for details)
- 0-10v Dimming standard
- Available with and without a lens
- Expandable to multiple fixture widths—4.25” to 5.187”
- Limited warranty: 5 years on luminaire

### APPLICATIONS:

- Warehouses
- Industrial
- Garage
- Retail
- Any Existing Strip

### ORDER GUIDE:

Series		Length		Width		Type		Line Voltage		Reflector		Color Temp		Lumens/Watts		Options
QSR	Quick Strip Retro	8	8 Foot	4	4.5"	SS	LED	1	Universal (120/277)	B	Ballast/Driver Cover	50	5000K	8FT Fixture 5000K With Lens		L000 (lens) 0000 (no lens) Please see Accessories Guide in front of catalog
												40	4000K	A	6100/ 42w	
												35	3500K	B	6930/ 48w	
														C	8130/ 59w	
														D	9750/ 72w	
														E	11350/ 89w	



## LED STRIP RETRO KIT — 4FT

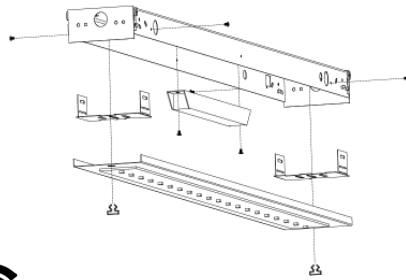

### PRODUCT DESCRIPTION:

The LED Strip Retro Kit is the perfect solution for upgrading existing strip fixtures, without replacing the entire fixture. TechBrite's LED Strip Retro Kit includes everything needed to convert an existing fluorescent fixture to a complete, safety certified LED fixture. Save time, money, and decrease waste by retrofitting!

### FEATURES:

- Retrofit most existing strip channels
- LPW > 140
- Perfect for continuous row mounting
- Available in 4' and 8' (See 8' spec sheet for details)
- Limited warranty: 5 years on luminaire
- 0-10v Dimming standard

### APPLICATIONS:

- Warehouses
- Industrial
- Garages
- Retail

### ORDER GUIDE:

Series	Length	Width	Type	Line Voltage	Reflector	Color Temp	Lumens/Watts	Options								
R	Strip Retro LED	4	4 Foot	4	4.25"	SS	LED	1	Universal (120/277)	B	Ballast/Driver Cover	50	5000K	4FT Kit 5000K		0000 Please see Accessories Guide in front of catalog
												40	4000K	A	5700/ 45w	
												35	3500K	B	6450/ 52w	
														C	7590/ 55w	
														D	9870/ 72w	
														E	11550/ 89w	



## LED STRIP RETRO KIT — 8 FT

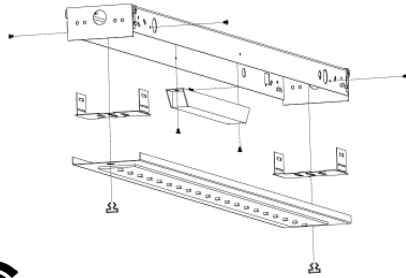

### PRODUCT DESCRIPTION:

The LED Strip Retro Kit is the perfect solution for upgrading existing strip fixtures, without replacing the entire fixture. TechBrite's LED Strip Retro Kit includes everything needed to convert an existing fluorescent fixture to a complete, safety certified LED fixture. Save time, money, and decrease waste by retrofitting!

### FEATURES:

- Retrofit most existing strip channels
- LPW > 140
- Perfect for continuous row mounting
- Available in 4' and 8' (See 4' spec sheet for details)
- Limited warranty: 5 years on luminaire
- 0-10v Dimming standard

### APPLICATIONS:

- Warehouses
- Industrial
- Garages
- Retail

### ORDER GUIDE:

Series	Length	Width	Type	Line Voltage	Reflector	Color Temp	Lumens/Watts	Options	
R	Strip Retro LED	8   8 Foot	4   4.25"	SS   LED	1	Universal (120/277)	B   Ballast/Driver Cover	50   5000K	8FT Kit 5000K
						40   4000K	A   6300/ 42w	0000 Please see Accessories Guide in front of catalog	
						30   3500K	B   7110/ 49w		
							C   8590/ 59w		
							D   10290/ 73w		
							E   12120/ 89w		





## LED HIGH BAY RETRO

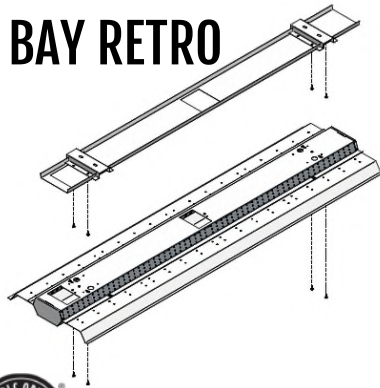

### PRODUCT DESCRIPTION:

TechBrite's LED High Bay Retro provides a viable alternative to replacing existing linear fluorescent high bays. The LED High Bay Retro is popular in applications where existing fixtures are "piped" or hard-wired to the power source. The LED High Bay Retro is the "Plug and Play" answer for difficult-to-replace fixtures while offering maximum controllability.

### FEATURES:

- Retro kit installs in existing fluorescent fixture housing
- Reuse existing metal housing
- Fits fixtures 12.5" and wider
- 0-10v Dimming standard
- DLC Premium—Classified as retro kit and new fixture
- Limited warranty: 5 years on luminaire

### APPLICATIONS:

- Retrofit Existing Fluorescent High Bays
- Warehouses
- Storage Facilities
- Manufacturing
- Gymnasiums
- Task Lighting
- Retrofit Fixtures "Piped"

### ORDER GUIDE:

Series	Length	Width		# of Boards		Type		Line Voltage		Reflector		Color Temp		Lumens/ Watts	Options		
		4	4 Foot	12	12"+	6	6 Boards	SS	LED	1	Universal (120/277)	B	Ballast/ Driver Cover	5		5000K	5000K
RB	High Bay Retro												4	4000K	A	10990/ 72w	<b>0000</b> Please see Accessories Guide in front of catalog
													3*	3500K	B	13850/ 92w	
															C	17600/ 127w	
															D*	19780/ 147w	
															E	24470/ 173w	
															F	25460/ 182w	

# WIRED FOR LED TUBES





## TROFFER — LED TUBES



### PRODUCT DESCRIPTION:

TechBrite's LED Tube Troffer is the most economical solution for troffer lighting. The Troffer is built with quality pre-painted steel. TechBrite's LED Tube Troffer utilizes a prismatic clouded lens engineered to decrease glare and maintain a visually appealing appearance. The Troffer is wired to accommodate a variety of LED tubes and available in 2x2 and 2x4.

### FEATURES:

- Standard P12 prismatic lens
- Designed for optimal general ambient lighting for recessed applications
- Available in 2x2 and 2x4
- Standard lay-in recessed mounting
- Surface mount kit—optional
- Integral hurricane clips
- Limited warranty: 5 years on luminaire

### APPLICATIONS:

- Offices
- Schools
- Universities
- Fitness Rooms
- Hospitals
- Retail
- Commercial

### ORDER GUIDE:

Series		Length		Width		# of Tubes		Type		Socket Type		Reflector/ Ballast Cover		Wiring	
L	Lay-In Troffer	2	2 Foot	24	2x2	2	2 lamp	SS	LED Tubes	X	Shunted	BXX	Ballast Cvr	00P0	Prewired
		4	4 Foot	24	2x4	3	3 lamp			U	Unshunted	WXX	White		
						4	4 lamp					MXX	Miro 4		
						6	6 lamp								

### ADDER:

Lamp Type	
<b>BLANK</b>	Wired single end with unshunted sockets
<b>WOE</b>	Wired opposing ends with shunted sockets



## STRIP FIXTURE—LED TUBES



### PRODUCT DESCRIPTION:

One of TechBrite's most popular fixtures, the LED Tube Strip Fixture, is an easy jump into the LED environment. Replace your existing T12 or T8 fixtures with the LED Tube Strip Fixture from TechBrite. TechBrite's LED Tube Strip features many mounting options, making it a quick and simple retrofit or new building installation.

### FEATURES:

- New construction or retrofit
- Continuous row mounting available
- Energy & operational savings
- Available in 4' and 8' options
- Limited warranty: 5 years on luminaire

### APPLICATIONS:

- Warehouses
- Industrial
- Garages
- Retail
- Commercial

### ORDER GUIDE:

Series	Length		Width		# of Tubes		Type	Socket Type	Reflector/ Ballast Cover		Wiring	
T Strip	4	4 Foot	4	4" Ballast	Four Foot		SS LED Tubes	X Shunted	BCXX	Ballast	00P0	Prewired
	8	8 Foot	4	4" Reflector	1	1 lamp		U Unshunted	WRXX	White		
					2	2 lamp			MRXX	Miro 4		
					3	3 lamp			XXXX	No Cover		
					Eight Foot							
					2	2 lamp						
					4	4 lamp						
					6	6 lamp						

### ADDER:

Lamp Type	
<b>BLANK</b>	Wired single end with unshunted sockets
<b>WOE</b>	Wired Opposing ends with shunted sockets



## SURFACE WRAP — LED TUBES



### PRODUCT DESCRIPTION:

The LED Tube Surface Wrap is an all-purpose fixture for nearly every commercial and industrial application. It features an engineered prismatic lens that both increases the light output and masks the LED tubes delivering an appealing look. For a quick and economic replacement of T12 or T8 wraps, the TechBrite Surface Wrap is the perfect solution.

### FEATURES:

- Available in 9 and 15 inch widths
- 2 and 4 lamp options
- LED Tubes
- Low-profile, heavy-gauge steel housing
- Clear prismatic lens
- Limited warranty: 5 years on luminaire

### APPLICATIONS:

- Offices
- Schools
- Universities
- Fitness Rooms
- Hospitals
- Retail
- Commercial

### ORDER GUIDE:

Series	Length	Width	# of Tubes	Type	Socket Type	Reflector	Wiring						
S Surface Wrap	4 4 Foot	Four Foot		2	2 lamp	SS	LED Tubes	X	Shunted	BCXX	Ballast Cvr	00P0	Prewired
		8 8 Foot	9	9"	4	4 lamp			U	Unshunted			
			15	15"									
			Eight Foot										
		11	11"										

### ADDER:

Lamp Type	
BLANK	Wired single end with unshunted sockets
WOE	Wired opposing ends with shunted sockets





## BAYBRITE HIGH BAY — LED TUBES

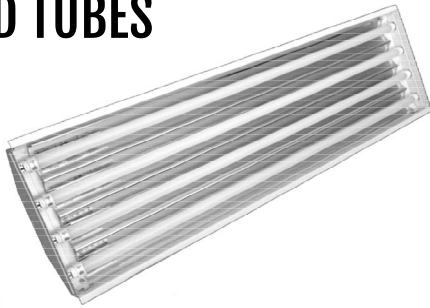

### PRODUCT DESCRIPTION:

A Best Seller— The LED Tube BayBrite is the most economical way to realize energy savings by upgrading to LED technology. Designed to replace metal halides or strips in retrofit applications, it is an ideal new construction fixture for industrial applications. The BayBrite High Bay is heavy on features while maintaining a budget-friendly price point.

### FEATURES:

- Swing away door assembly for simple wiring access
- Fully enclosed fixture
- Heavy gauge construction
- Limited warranty: 5 years on luminaire

### APPLICATIONS:

- Ideal replacement for traditional HID fixtures
- Warehouses
- Storage Facilities
- Manufacturing
- Task Lighting
- Gymnasiums

### ORDER GUIDE:

Series	Length	Width	# of Tubes	Type	Socket Type	Reflector	Wiring
B BayBrite	4 4 Foot	14 4 lamp	4 4 lamp	SS LED Tubes	X Shunted	WRXX* White	00P0 Prewired
		14 6 lamp	6 6 lamp		U Unshunted	MRXX Miro 4	
		20* 8 lamp	8* 8 lamp				

\* White reflector not available on 8 lamp fixture

### ADDER:

Lamp Type	
BLANK	Wired single end with unshunted sockets
WOE	Wired opposing ends with shunted sockets



## VAPORTITE HIGH BAY —LED TUBES



### PRODUCT DESCRIPTION:

TechBrite's LED Tube Vaportite High Bay can take on the toughest environments. Rated IP67, the Vaportite is designed to minimize the retention of liquids or debris when hosed down. The standard stainless steel hardware makes it an ideal solution for most environments. The LED Tube Vaportite High Bay is an ideal replacement for metal halide or T8 fixtures.

### FEATURES:

- Designed for tough environments
- Easy to clean and service
- Variety of tubes combinations (3, 4, 5, 6)
- Impact resistant lenses
- Stainless steel hardware
- Simple mounting system—no holes to drill!
- Limited warranty: 5 years on luminaire

### APPLICATIONS:

- Food Processing Facilities
- Refrigerated Storage
- Parking Garages
- Breweries and Bottling Facilities
- Livestock Facilities
- Commercial
- Industrial

### ORDER GUIDE:

Series	Length	# of	Type	Socket Type	Reflector	Wiring
VH Vaportite High Bay	4 4 Foot	3 3 lamp	SS LED Tubes	X Shunted	BCXX Ballast Cvr	00P0 Prewired
		4 4 lamp		U Unshunted	MRXX Miro 4	
		6 6 lamp				

### ADDER:

Lamp Type	
BLANK	Wired single end with unshunted sockets
WOE	Wired opposing ends with shunted sockets



## VAPORTITE STRIP— LED TUBES

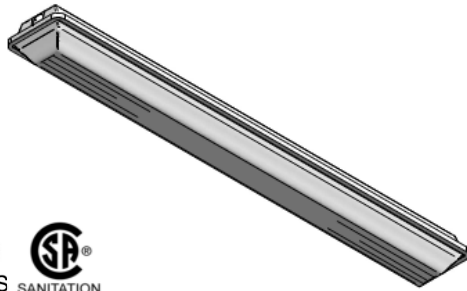

### PRODUCT DESCRIPTION:

The perfect solution for harsh conditions, TechBrite's LED Tube Vaportite Strip is damp listed, wet listed and certified NSF/ ANSI2 Sanitation. With an IP67 rating, the LED Vaportite Strip is designed to minimize the retention of liquids or debris when hosed down. TechBrite's LED Tube Vaportite Strip meets or exceeds all applicable NSF/ ANSI sanitation requirements.

### FEATURES:

- IP67 rated & sanitation/ NSF CSA rated
- Easy to clean and service
- Lengths of 2', 4' or 8'
- Plastic (standard) or stainless steel
- Frosted acrylic ribbed diffuser
- Limited warranty: 5 years on luminaire

### APPLICATIONS:

- Food Processing Facilities
- Parking Garages
- Refrigerated Storage
- Breweries and Bottling Facilities
- Livestock Facilities
- Traffic Tunnels
- Exterior
- Commercial/ Industrial

### ORDER GUIDE:

Series	Length	Width	# of Tubes	Type	Socket Type	Reflector	Wiring
V Vaportite	2 2 Foot	7 7"	Two/ Four Foot	SS LED Tubes	X Shunted	BCXX Ballast Cvr	00P0 Prewired
	4 4 Foot		1 1 lamp		U Unshunted	MRXX Miro 4	
	8 8 Foot		2 2 lamp				
			3 3 lamp				
			Eight Foot				
			2 2 lamp				
			4 4 lamp				
			6 6 lamp				

### ADDER:

Lamp Type	
BLANK	Wired single end with unshunted sockets
WOE	Wired opposing ends with shunted sockets



## RETRO TROFFER—LED TUBES

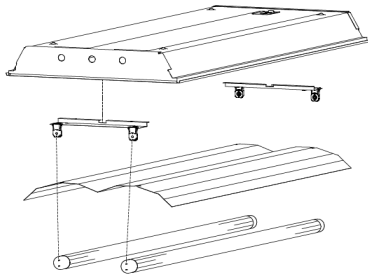

### PRODUCT DESCRIPTION:

Over 1 million kits sold! The LED Tube Retro Troffer is the easiest to install retro kit in the industry. The kit contains sockets rated for direct wire voltage, ensuring a proper, safe installation with direct voltage TLEDs or ballast driven TLEDs. The TechBrite LED Tube Retro Kit is a fast, easy and economical solution to upgrading existing troffer fixtures.

### FEATURES:

- Fits most prismatic lens troffers (2x2 or 2x4)
- Available in 2x2 & 2x4
- Pinch fit reflector for quick installation
- Kit includes: reflector, sockets, mounting brackets, mounting screws, LED tubes (optional)
- Limited warranty: 5 years on luminaire

### APPLICATIONS:

- Office
- Schools
- Universities
- Fitness Rooms
- Hospitals

### ORDER GUIDE:

Series	Length	Width		# of Tubes		Type		Socket Type		Reflector		Wiring*			
		21	2x2	2	2 lamp	SS	LED Tubes	X	Shunted	WXX	White	00P0	Prewired		
R	Retro	2	2 Foot	21	2x2	2	2 lamp	SS	LED Tubes	X	Shunted	WXX	White	00P0	Prewired
		4	4 Foot	21	2x4	3	3 lamp			U	Unshunted	MXX	Miro 4	0000	No Wiring
						4	4 lamp								
						6	6 lamp								

- \* Prewired includes: wire & disconnect
- \* No wiring includes: disconnect & no wires

### ADDER:

Lamp Type	
<b>BLANK</b>	Wired single end with unshunted sockets
<b>WOE</b>	Wired opposing ends with shunted sockets





## RETRO STRIP—LED TUBES

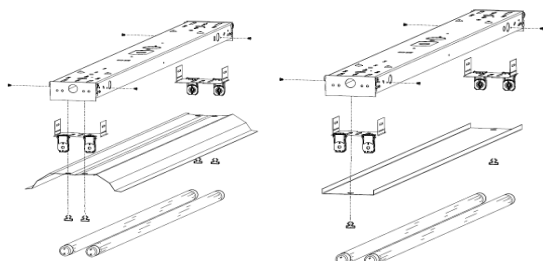

### PRODUCT DESCRIPTION:

TechBrite's most popular industrial retrofit kit, the LED Tube Retro Strip, is a simple installation process. It includes all the items to convert an existing strip fixture to a CSA approved LED tube fixture. The TechBrite LED Tube Retro Strip is a fast, easy, and economical solution to upgrading existing fixtures.

### FEATURES:

- Tool-less channel cover for easy installation
- Energy & operational savings
- Available in 4' and 8' options
- Limited warranty: 5 years on luminaire

### APPLICATIONS:

- Warehouses
- Industrial
- Garages
- Retail

### ORDER GUIDE:

Series	Length	Width	# of Tubes	Type	Socket Type	Reflector	Wiring*									
R	Retro	4	4 Foot	5	4.25" BC**	Four Foot		SS	LED Tubes	X	Shunted	BCXX	BC**	00P0	Prewired	
		8	8 Foot	5	5" BC**	1	1 lamp				U	Unshunted	WRXX	White	0000	None
				9	9" Reflector	2	2 lamp						MRXX	Miro 4		
						3	3 lamp							XXXX	None	
				Eight Foot												
				2	2 lamp											
				4	4 lamp											
				6	6 lamp											

\* \*\*BC = Ballast Cover

### ADDER:

Lamp Type	
BLANK	Wired single end with unshunted sockets
WOE	Wired opposing ends with shunted sockets

\* Prewired includes:

wire & disconnect

\* No wiring includes:

disconnect & no wires

# LED OUTDOOR FIXTURES





## LED UFO HIGH BAY



### PRODUCT DESCRIPTION:

TechBrite's LED UFO Fixture has superior lumen performance and boasts over 140 LPW in the most efficient lumen packages. The magnesium alloy allows heat to transfer efficiently, allowing for improved operating temperatures and longer life. Replace existing metal halide, T8, or T5 while improving light output and efficiencies. The IP65 rating allows for maximum placement flexibility.

### FEATURES:

- IP65/ Wet location
- High efficiency LED driver > 90%
- Eye hook included
- Up to 145 LPW
- Limited warranty: 5 years on luminaire
- Dark bronze
- Polycarbonate lens
- 0-10v Dimming standard

### APPLICATIONS:

- Indoor or Outdoor
- Warehouses
- Gas Stations
- Stadiums
- Retail
- Commercial
- Industrial

### ORDER GUIDE:

Part Number	Lumens	Watts	LPW	Voltage	Color	Description	Dimensions	Weight
TBUFO160W27-50K-PC-DG	23200	160	145	120-277	5000K	LED UFO High Bay	9.20 x 10.25 (inches)	10.00 lbs
TBUFO2000W27-50K-PC-DG	28000	200	140	120-277	5000K	LED UFO High Bay	9.85 x 12.60 (inches)	15.00 lbs



## LED SHOEBOX-FLOOD FIXTURE



### PRODUCT DESCRIPTION:

Need to illuminate large areas? The TechBrite LED Shoebox-Flood Fixture is the perfect solution. The LED Shoebox-Flood Fixture features advanced designed optics for improved light utilization and evenness. The LED Shoebox-Flood Fixture is an ideal replacement for HID/ metal halide and reduces wattages as much as 75%.

### FEATURES:

- Lightweight cast aluminum
- Available in 347/480v
- DLC Premium\*
- IP66/Wet location
- Type 3 or Type 5 distribution
- Photocell & PIR sensor available
- Limited warranty: 5 years on luminaire

### APPLICATIONS:

- Outdoor
- Parking Lots
- Schools
- Roadways

### ORDER GUIDE:

Fixture Type		Wattage		Voltage		CCT		Finish		Photocell (Optional)		Sensor (Optional)		Mounting		Distribution Type	
TB-SB	Shoebox-Flood	70	70w	27V	120-277v	40K	4000K	D	Dark Bronze	P0	120-277v	M	120-277v	SQ	Square/ Round Pole Mount	T3	Type 3
		105	105w	48V	347-480v	50K	5000K	B	Black	P3	347v	M4	347-480v	SP	Slipfitter Mount	T4	Type 4
		150	150w					W	White	P4	480v	Blank	No Sensor	WM	Wall Mount	T5	Type 5
		250	250w							Blank	No Photocell			TR	Trunnion/Yoke		
		300	300w														

\* Please check with your sales rep to determine fixtures meeting DLC Premium classification





## LED WALL PACK FIXTURE



### PRODUCT DESCRIPTION:

Improve your outdoor lighting environment and energy efficiency by 60% or more with TechBrite's LED Wall Pack. The cast aluminum body improves cooling, while featuring a specially engineered lens to improve light utilization, and provides an even distribution.

### FEATURES:

- Polycarbonate lens designed to reduce discoloration
- Beam angle 130°
- Suitable for indoor or outdoor
- Dark bronze
- Limited warranty: 5 years on luminaire

### APPLICATIONS:

- Indoor or Outdoor
- Commercial/ Industrial
- Gas Stations
- Wall Mount

### ORDER GUIDE:

Fixture Type		Wattage		Voltage		CCT		Finish		Photocell (Optional)	
<b>TB-WP</b>	Wall Pack	<b>Universal (120/277)</b>		<b>27V</b>	120-277v	<b>50K</b>	5000K	<b>DM</b>	Dark Bronze	<b>P1</b>	120v
		<b>30</b>	30w	<b>48V</b>	347-480v					<b>P2</b>	120-277v
		<b>45</b>	45w							<b>Blank</b>	No Photocell
		<b>70</b>	70w								
		<b>90</b>	90w								
		<b>480v</b>									
		<b>95</b>	95w								
		<b>135</b>	135w								
		<b>140</b>	140w								



## LED DOOR PACK FIXTURE



### PRODUCT DESCRIPTION:

TechBrite's LED Door Pack is the quick, easy-to-install solution for general outdoor lighting. The TechBrite LED Door Pack has many applications: building facades, parking garages, stairways, pathways, storage areas, etc. The LED Door Pack has two power options - 15w or 25w. The Dusk-to-Dawn Photocell is standard.

### FEATURES:

- IP65 Rated
- Dusk-to-Dawn photocell included
- Easy-to-install
- Powder coated aluminum die cast body
- Polycarbonate lens
- Limited warranty: 5 years on luminaire

### APPLICATIONS:

- Doorways
- Hallways
- Outdoor
- Parking Garages

### ORDER GUIDE:

Part Number	Lumens	Watts	LPW	Color	Description	Dimensions	Weight
TB-DP-15W	1600	15	106	5000K	LED Door Pack	12.70 x 7.60 x 5.50 (inches)	2.65 (lbs)
TB-DP-25W	2600	25	104	5000K	LED Door Pack	12.70 x 7.60 x 5.50 (inches)	3.09 (lbs)



## LED CANOPY OUTDOOR FIXTURE



### PRODUCT DESCRIPTION:

This fixture is the perfect solution to update any outdoor application. TechBrite's LED Canopy Fixture has a high quality powder coated finish able to withstand the harshest environments. TechBrite's Canopy Outdoor Fixture is perfect for parking lots, parking garages, entrances, walkways and any other area where increased light is needed for safety or functionality.

### FEATURES:

- Lightweight cast aluminum cooling fins
- IP65/ Wet location
- Lightweight for easy installation
- CRI > 75
- Polycarbonate lens promotes light distribution
- Limited warranty: 5 years on luminaire

### APPLICATIONS:

- Outdoor
- Parking Garages
- Gas Stations
- Canopies
- Overhangs

### ORDER GUIDE:

Part Number	Lumens	Watts	LPW	Color	Description	Dimensions	Weight
TB-SCL035W27	3045	35	87	5000K	LED Canopy Outdoor Fixture	8.90 x 8.90 x 5.60 (inches)	30.35 (lbs)
TB-SCL06W27	6130	60	102	5000K	LED Canopy Outdoor Fixture	8.90 x 8.90 x 5.60 (inches)	15.98 (lbs)
TB-SCL09W27	7800	90	86	5000K	LED Canopy Outdoor Fixture	8.90 x 8.90 x 5.60 (inches)	15.98 (lbs)

# WIRELESS DIMMING CONTROLS

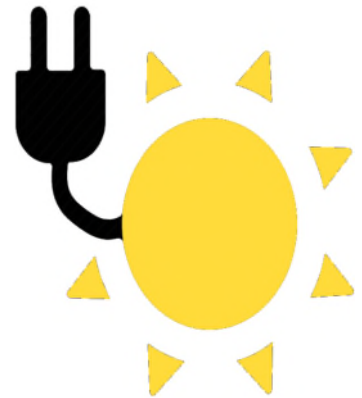
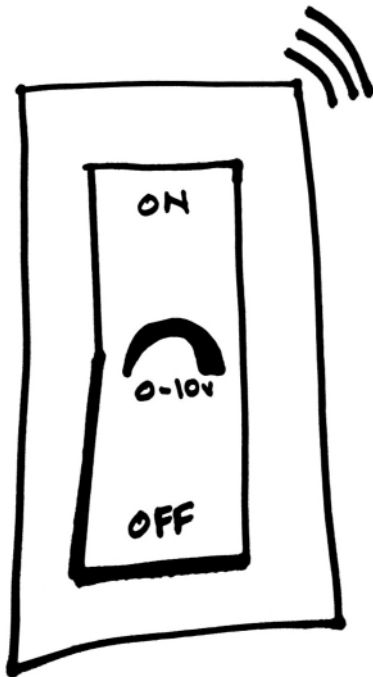

## Wireless Dimming Controls

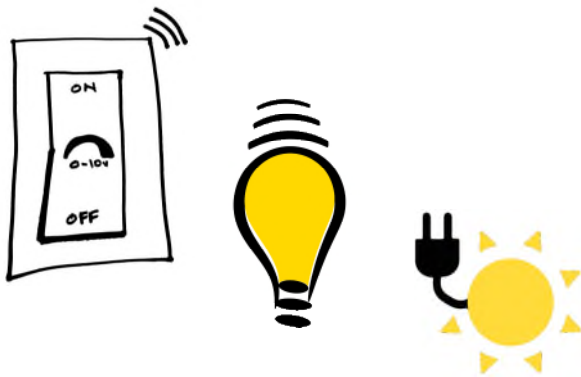

### PRODUCT DESCRIPTION:

TechBrite's Wireless Control Management Solution is capable of dimming, photocell, on/off, zone control, and individual fixture control—all wirelessly, and without pulling control (purple & gray wire). Ideal for office, plant, classroom, stairwell, etc. With its wide range of capabilities, our Wireless Control Management Solution is a perfect addition to any lighting retrofit project.

### FEATURES:

- Save installation time and money with completely wireless controls
- No control wires necessary
- Control fixtures wirelessly
- No power/ no battery needed for controls
- Surface mount or outlet box mount rocker switch
- Install Occ and Photo Sensor in any location throughout the building up to 150 feet

### APPLICATIONS:

- Conference Rooms—separate zones for presentation and seating
- Warehouse—separate zones for workspaces requiring different light levels
- Gymnasiums—different light levels for sporting events and theatre
- Offices—separate zones for workspaces
- Offices—daylight harvesting







