



# CEILING FAN CATALOG 2019

 **PROGRESS**  
LIGHTING™



# Table of Contents

05 FAN INSPIRATION

12 INDOOR FANS

---



82 OUTDOOR FANS

---



98 ACCESSORIES

---

- 98 Light Kits
- 104 Downrods
- 105 Remotes and Wall Controls
- 106 Blade Finishes
- 108 Index

**42" BUILDER** p.73



**42" HUGGER** p.81



**52" BUILDER** p.71



**52" BUILDER WITH LIGHT** p.72



**52" HUGGER** p.80



**BILLOWS** p.58



**BRADEN** p.76



**CALEB** p.22



**DRIFT** p.74



**EDGEFIELD** p.67



**ELLWOOD** p.20



**FARRIS** p.16



**FRESNO** p.52



**GAZE** p.26



**GLANDON** p.34



**GRACEFUL** p.44



**GREER** p.36



**GUST** p.48



**HARRANVALE** p.42



**KUDOS** p.50



**NORTH PARK** p.68



**OLSON** p.46



**ORIOLE** p.30



**PERFORMANCE** p.69



**SANFORD** p.18



**SHAFFER** p.38



**SIGNATURE** p.62



**SIGNATURE PLUS** p.70



**SIGNATURE PLUS II** p.60



**SOAR** p.40



**SPADES** p.28



**SPRINGER** p.14



**TEASLEY** p.32



**TEMPT** p.54



**TREVINA** p.66



**TREVINA II** p.64



**VAST** p.24



**VERADA** p.56



**VOX FAN** p.78



# OUTDOOR FANS

52" PATIO p.96    54" PATIO p.94    DECORATIVE PATIO p.97    EDISTO p.84



LAKEHURST p.92    MONTAGUE p.90    SMYRNA p.88    WHIRL p.86



# Fan Inspiration

*CEILING FANS CAN SERVE AS A STATEMENT PIECE OR EVEN THE FOCAL POINT OF A ROOM*

Today's ceiling fans incorporate beautiful features, such as hand carved blades, sleek finishes and natural elements to appeal to a variety of different design trends.

At Progress Lighting, we strive to incorporate this shift in our ceiling fan designs and are eager to present an expanded offering in this catalog.

Featuring Gust Ceiling Fan

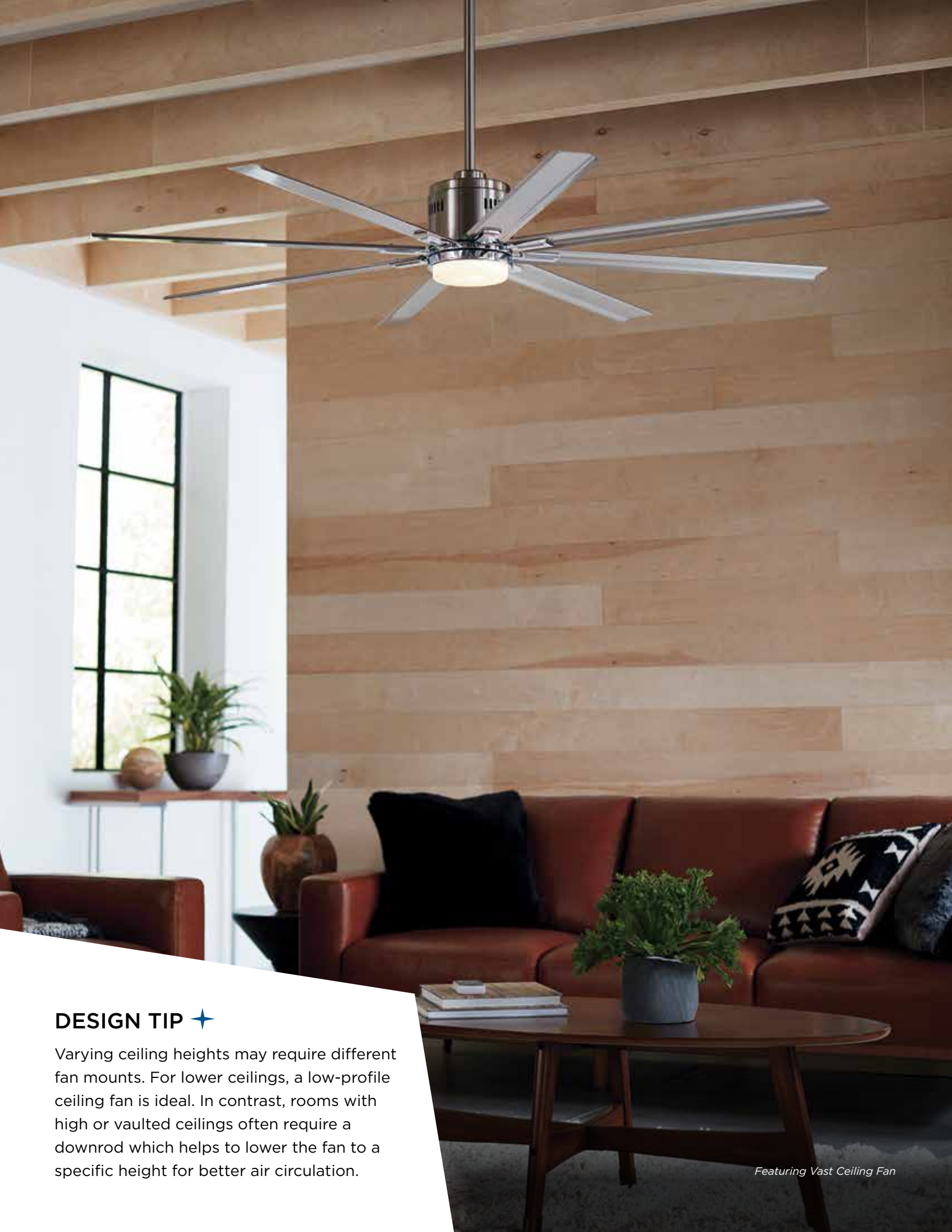

### DESIGN TIP ✦

Varying ceiling heights may require different fan mounts. For lower ceilings, a low-profile ceiling fan is ideal. In contrast, rooms with high or vaulted ceilings often require a downrod which helps to lower the fan to a specific height for better air circulation.

Featuring Vast Ceiling Fan



## CEILING FAN BUYER'S GUIDE THE PERFECT FAN IN 5 STEPS

Ceiling fans are practical and efficient solutions for creating comfortable and welcoming living areas. With many styles, functions and features to choose from, narrowing down the choices can be a challenge. Here we present five tips for selecting the perfect ceiling fan for your home.

# 01

### SETTLE ON STYLE

Choose a style that complements your home décor. Consider fan shape, blade features and finish to help you meet your room's design needs. Choose from Traditional, Transitional, Coastal or Farmhouse styles. The possibilities are vast!

# 02

### EXPLORE INDOOR VS. OUTDOOR USES

Fans provide a breezy setting for reading a book or catching up with friends, making them ideal for outdoor rooms. However, it's important to consider the certifications on the fan depending on the use. For high humidity areas, choose a UL-Listed fan for Damp Locations and for spaces that will be exposed to weather, choose a UL-Listed fan for Wet Locations. For interior use in dry spaces with minimal condensation, select a UL-Listed fan for Dry Locations. See testing listings defined on page 11.



Featuring 52" Builder Ceiling Fan  
(Image: Beazer Homes)

# 03

## GET YOUR HEIGHT RIGHT

You want to allow at least 7 feet (84 in.) from the floor to the bottom of the fan, with 8 or 9 feet being the ideal above-floor placement. For lower ceilings, consider a ceiling fan with a low profile to avoid disturbing inhabitants. Most ceiling fans come equipped with a down rod to help you adjust to the correct height.

# 04

## SIZE IT TO YOUR SPACE

Size is really important when selecting your ceiling fan. If a fan is too large, it can overwhelm the space. On the flip side, if the fan is too small, the airflow may be inadequate for that area.

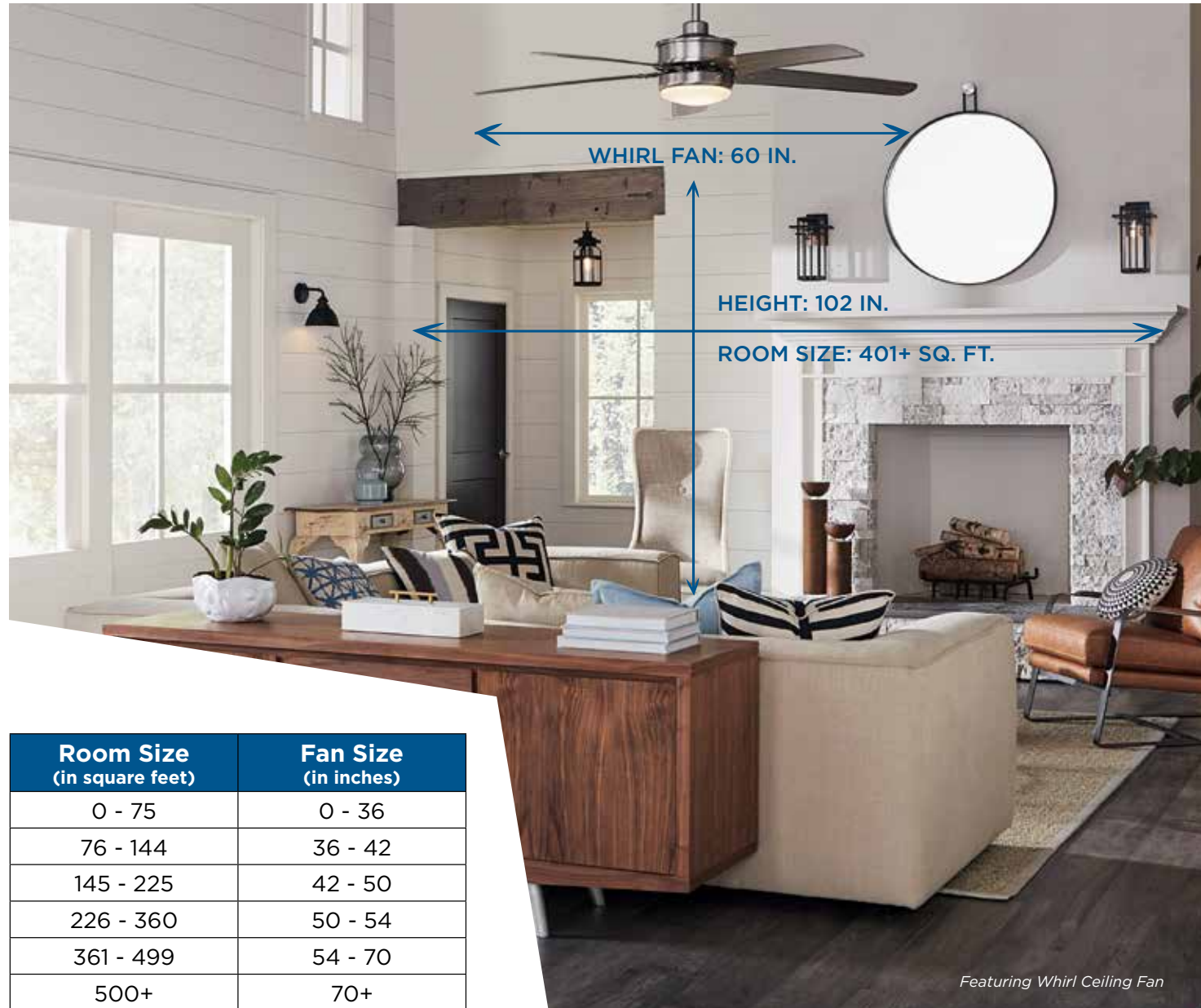

Featuring Whirl Ceiling Fan

Room Size (in square feet)	Fan Size (in inches)
0 - 75	0 - 36
76 - 144	36 - 42
145 - 225	42 - 50
226 - 360	50 - 54
361 - 499	54 - 70
500+	70+

# 05

## CHOOSE YOUR FEATURES

There are many different features to choose from when browsing ceiling fans.

### REVERSIBLE MOTOR

Typically, ceiling fans are used to help cool you down and keep the air flowing with a counter-clockwise blade direction. However, fans can also keep you warm when the direction of the blades is reversed. Select a fan with reversible motor for the option to circulate cool or warm air. Most ceiling fans have a small switch located either on the motor housing or the switch cup.

**BLADE FINISH OPTIONS**  
Multiple blade finish options to coordinate with your home decor.

**BLADE OPTIONS**  
● Medium Cherry  
● Black

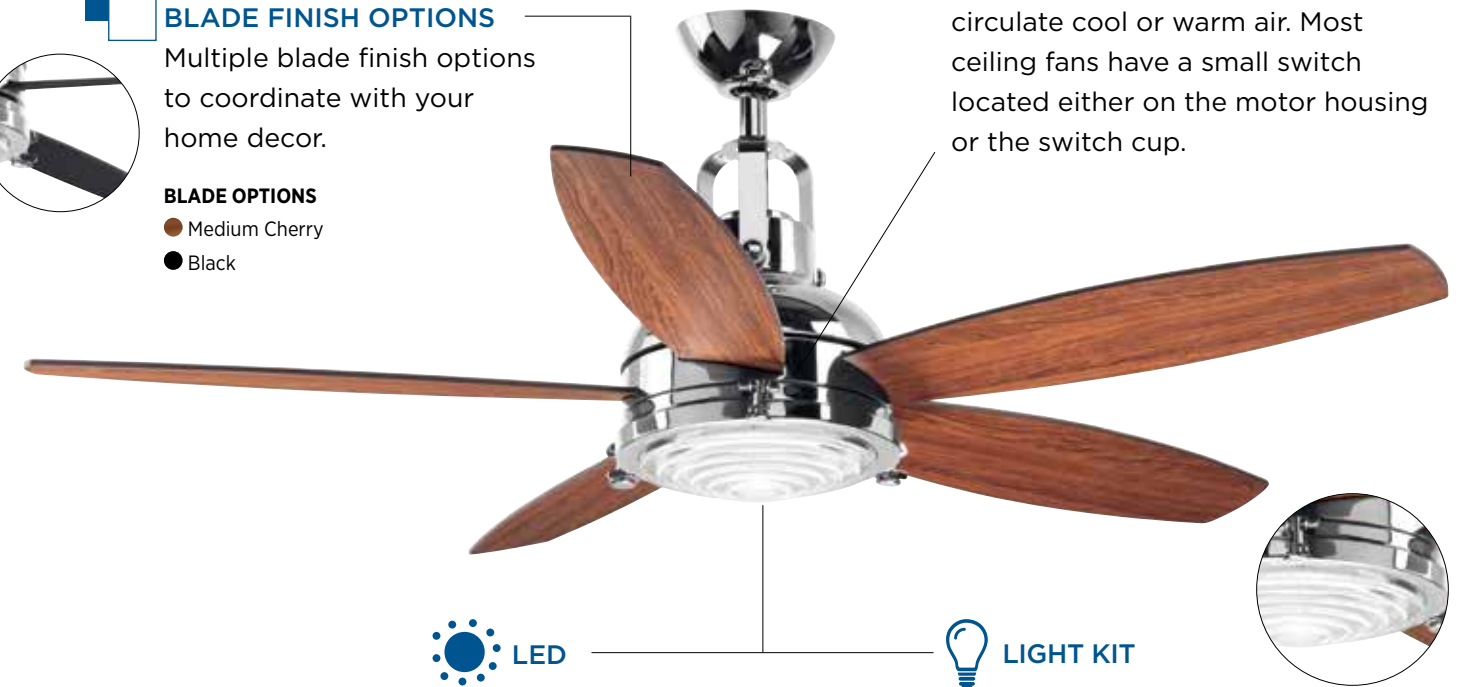

**LED**  
Consider an LED or Energy Star rated fixture to save energy.

**LIGHT KIT**  
For a layered lighting effect, install a ceiling fan with a pre-installed light kit to complement your existing fixtures.



**REMOTE CONTROL WITH FULL RANGE DIMMING**  
Full range dimming and hand-held remote control capabilities are available to offer an added convenience in controlling a room's environment.



Featuring 52" Builder Fan and Low Profile Light Kit  
(Image: St. Jude Dream Home)

## ENERGY SAVING LED LIGHT KITS

With the rapid advancement of lighting technology, LED light kits are quickly surpassing the efficiency of more traditional light kits, including those with fluorescent and incandescent sources. Progress Lighting offers a variety of LED light kits that meet strict requirements for maximum energy savings and superior performance.

LEDs have many unique, inherent benefits including long life, ease of maintenance,

resistance to breakage, lack of infrared or ultraviolet emissions, and instant-on performance.

Progress LED light kits use 3000K lighting temperature for a warm-white appearance. A dimmer can control a light kit so you can adjust illumination levels and set the room for a particular mood.

When you select a high-quality LED fixture, you can expect a significant return on investment from an energy conservation standpoint. Here are some of the energy saving benefits of LEDs from Progress Lighting:



LED sources use at least **75% less energy** than incandescent lighting, allowing homeowners to save on operating expenses.



LEDs last **35 to 50 times longer** than incandescent sources and approximately 2 to 5 times longer than fluorescent lighting. Meaning, less bulb maintenance!



LEDs do not produce heat like traditional sources, **reducing cooling costs.** Traditional incandescent bulbs waste 98% of the energy they consume on heat.



LEDs do not use **power** when they are turned off. According to MSN Real Estate, LED lights can result in an annual bill as low as \$26.

## TESTING LISTINGS DEFINED / FANS

### INDOOR, DAMP AND WET LOCATION

All ceiling fans sold in the United States have been tested and rated by either Underwriters Laboratories (UL) or Intertek (ETL), each an independent product safety certification organization. It's important to pay attention to the rated listing when purchasing a ceiling fan as it will tell you what location the fan was designed for. **There are three location options: dry, damp and wet.**



#### DRY

Please note indoor only (dry location) fans should only be used indoors. Even if an outdoor area or screened-in porch is covered, the motor and the blades can be affected when exposed to humidity. You can, however, "bring the outdoors inside" – as using outdoor ceiling fans are perfectly acceptable to use in interior spaces.



#### DAMP

If you are selecting a ceiling fan for a space that is outdoors and under a roof, i.e. any covered porches; you should select either a damp rated or wet listed fan. Damp location fans may also be used indoors.



#### WET

If the fan comes directly into contact with water, you'll need to ensure that the ceiling fan has a "wet" listing. Ceiling fans designed for damp or wet locations feature elements, such as moisture-resistant motors and all weather blades. Wet location fans may also be used indoors.



Featuring Ellewood Ceiling Fan  
(Image: Dosstie Homes)

Featuring Vast Ceiling Fan  
(Image: Meritage Homes)

Featuring Decorative Patio Fan  
(Image: Drees Homes)

# Indoor Ceiling Fans

## *EXPERIENCE THE VERSATILITY CEILING FANS PROVIDE*

The benefits of incorporating ceiling fans within a home are endless! They are stylish and can enhance a variety of interior design elements. Indoor ceiling fans allow individuals to control the temperature by room at any time, during any season. Finally, ceiling fans offer costs- and energy-savings features. They truly are a versatile and functional home accent.



**MARKET TREND** - Large ceiling fans have become extremely popular over the last few years. These newer, oversized residential fans really create a visual impact in larger rooms, or in areas featuring high ceilings. The current trend is to incorporate bigger fans in smaller settings to help spread the airflow over a wider area, while also providing a dramatic design statement.

*Featuring Billows Ceiling Fan  
(Image: St. Jude Dream Home)*



# SPRINGER NEW



P250000-129 shown with Distressed Walnut blades

Springer is a statement-making ceiling fan with a rustic flair. The 12-blade, 60" ceiling fan was inspired by the form and function of a windmill and is ideal for Farmhouse, Industrial and Transitional interior settings. A full function remote control with batteries is included along with a dual mount canopy that accommodates flat or sloped ceilings.

#### FEATURES

- Limited Lifetime Warranty
- Dual Mount (flat or sloped ceiling-22°)
- DC Motor
- Plywood blades
- Full function remote control with batteries is included

#### SIZE

60" dia., 17-3/8" ht.  
80" lead wires

#### FINISHES

- Architectural Bronze - 129
- Antique Nickel - 081

PROGRESSLIGHTING.COM

#### P250000-081

Antique Nickel shown  
with White Barnwood blades



White Barnwood



#### P250000-129

Architectural Bronze shown  
with Distressed Walnut blades



Distressed Walnut



#### ENERGY INFORMATION AT HIGH SPEED

<b>AIRFLOW:</b>	6,377 cubic feet per minute
<b>ELECTRICITY USE:</b>	33 watts (excludes lights)
<b>AIRFLOW EFFICIENCY:</b>	193 cubic feet per minute per watt



Full Function Remote Control Included  
Six-speed fan operation  
Reverse direction control

PROGRESSLIGHTING.COM



Canada



Fan



Dry  
Indoor only

# FARRIS NEW



P250002-108-30 shown with Walnut blades

Farris features three solid wood carved blades to form a sleek, modern design. The 60" ceiling fan includes an integrated LED light kit that is removable to provide the option in non-illuminated applications. Available in Brushed Nickel, Oil Rubbed Bronze and Graphite finishes. A full function remote control with batteries is included, and the dual mount canopy accommodates flat or sloped ceilings.

#### FEATURES

- Limited Lifetime Warranty
- Dual Mount (flat or sloped ceiling-13°)
- DC Motor
- Carved wood blades
- White opal shatterproof shade
- Removable light kit
- Full function remote control with batteries is included

#### SIZE

60" dia., 15-1/2" ht.  
80" lead wires

#### FINISHES

- Brushed Nickel - 009
- Oil Rubbed Bronze - 108
- Graphite - 143

PROGRESSLIGHTING.COM

#### P250002-009-30

Brushed Nickel shown  
with Gray Weathered Wood blades

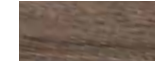

Gray Weathered Wood



#### P250002-108-30

Oil Rubbed Bronze shown  
with Walnut blades



Walnut



shown with light kit removed

#### P250002-143-30

Graphite shown  
with Driftwood blades



Driftwood



#### ENERGY INFORMATION AT HIGH SPEED

**AIRFLOW:** 7,047 cubic feet per minute  
**ELECTRICITY USE:** 32 watts (excludes lights)  
**AIRFLOW EFFICIENCY:** 220 cubic feet per minute per watt

#### LAMPING INFORMATION

18w LED Module, 3000K, 90 CRI,  
1400 lumens, dimmable.

PROGRESSLIGHTING.COM



Canada



Fan



Light



Dry  
Indoor only



Full Function Remote Control Included

Full-range dimming for light  
Six-speed fan operation  
Reverse direction control

# SANFORD NEW



P2594-12930K

Sanford delivers ultra powerful air movement and energy efficient illumination packaged in a modern design. Ideal for both interior and outdoor settings, this "fandelier" adds a contemporary style to porches, foyers, bath and vanity areas providing a wide range of applications. Sanford includes an integrated 23W LED module, offering both form and function with energy and cost-savings benefits. A three-speed remote control is included.

#### FEATURES

- Limited Lifetime Warranty
- Dual Mount (flat or sloped ceiling-18.5°)
- Metal blades
- Remote control with batteries is included
- Remote may be replaced with P2630-30 or P2630-95 wall control

#### SIZE

22-7/8" dia., 17-3/4" ht.  
80" lead wires

#### FINISHES

- Brushed Nickel - 09
- Architectural Bronze - 129

PROGRESSLIGHTING.COM

**P2594-0930K**  
Brushed Nickel



Brushed Nickel



**P2594-12930K**  
Architectural Bronze



Architectural Bronze



#### ENERGY INFORMATION AT HIGH SPEED

<b>AIRFLOW:</b>	1,008 cubic feet per minute
<b>ELECTRICITY USE:</b>	37 watts (excludes lights)
<b>AIRFLOW EFFICIENCY:</b>	27 cubic feet per minute per watt

#### LAMPING INFORMATION

23w LED Module, 3000K, 90 CRI, dimmable.

PROGRESSLIGHTING.COM



Three-Speed Remote Included  
Full-range dimming for light  
Three-speed fan operation



Canada



Fan



Damp  
Indoor/Outdoor

# ELLWOOD



P2546-09 shown with Driftwood blades

A picture of modern design, the functional minimalism of the Ellwood 68" ceiling fan is a product of advanced design. Five long and graceful blades made of carved wood move air with remarkable efficiency. Ellwood features a dual mount system and is compatible with universal light kits. A full function remote control is included.

#### FEATURES

- Limited lifetime warranty
- Dual Mount (flat or sloped ceiling-20°)
- Patented carved Wood blades
- Compatible with universal light kits
- Remote control with batteries is included
- Remote may be replaced with P2631-30 wall control

#### SIZE

68" dia., 16-3/4" ht.  
80' lead wires

#### FINISHES

- Brushed Nickel - 09
- Antique Bronze - 20

PROGRESSLIGHTING.COM

#### P2546-09

Brushed Nickel shown  
with Driftwood blades



Driftwood



#### P2546-20

Antique Bronze shown  
with Walnut blades



Walnut



#### ENERGY INFORMATION AT HIGH SPEED

<b>AIRFLOW:</b>	7,587 cubic feet per minute
<b>ELECTRICITY USE:</b>	90 watts (excludes lights)
<b>AIRFLOW EFFICIENCY:</b>	84 cubic feet per minute per watt



Full Function Remote Included  
Three-speed fan operation  
Reverse direction control

PROGRESSLIGHTING.COM



Fan



Dry  
Indoor only

# CALEB



P2560-20 shown with Walnut blades

Beautiful and expansive in design, the 68" Caleb ceiling fan is ideal for use in large spaces. Bent Carved Wood blades are paired with either Brushed Nickel or Antique Bronze finishes. Caleb features a dual mount system and is compatible with universal light kits. A full function remote control is included.

#### FEATURES

- Limited Lifetime Warranty
- Dual Mount (flat or sloped ceiling-20°)
- Patented bent carved wood blades
- Compatible with universal light kits
- Remote control with batteries is included
- Remote may be replaced with P2631-30 wall control

#### SIZE

68" dia., 18" ht.  
80" lead wires

#### FINISHES

- Brushed Nickel - 09
- Antique Bronze - 20

PROGRESSLIGHTING.COM

#### P2560-09

Brushed Nickel shown  
with Medium Cherry blades



Medium Cherry



#### P2560-20

Antique Bronze shown  
with Walnut blades



Walnut



#### ENERGY INFORMATION AT HIGH SPEED

<b>AIRFLOW:</b>	7,045 cubic feet per minute
<b>ELECTRICITY USE:</b>	86 watts (excludes lights)
<b>AIRFLOW EFFICIENCY:</b>	82 cubic feet per minute per watt



Full Function Remote Included  
Three-speed fan operation  
Reverse direction control

PROGRESSLIGHTING.COM



Fan



Dry  
Indoor only

# VAST



P2550-0930K shown with Brushed Nickel blades

Beautiful and expansive in design, the 72" Vast ceiling fan is ideal for use in large areas and outdoor covered areas for maximum cooling. A white opal shade complements a variety of finish options, including Brushed Nickel with Chrome accents, Antique Bronze or White with Chrome Accents. Vast features a dual mount system and comes with a full function remote control.

### FEATURES

- Limited lifetime warranty
- Dual Mount (flat or sloped ceiling-20°)
- DC motor
- Aluminum blades
- White opal glass
- Remote control with batteries is included

### SIZE

72" dia., 16-3/4" ht.  
80" lead wires

### FINISHES

- Brushed Nickel - 09
- Antique Bronze - 20
- White - 30

PROGRESSLIGHTING.COM

### P2550-0930K

Brushed Nickel shown  
with Chrome Accents  
with Brushed Nickel blades



Brushed Nickel



### P2550-2030K

Antique Bronze shown  
with Antique Bronze blades



Antique Bronze



### P2550-3030K

White shown  
with Chrome Accents  
and White blades



White



### ENERGY INFORMATION AT HIGH SPEED

<b>AIRFLOW:</b>	7,982 cubic feet per minute
<b>ELECTRICITY USE:</b>	28 watts (excludes lights)
<b>AIRFLOW EFFICIENCY:</b>	285 cubic feet per minute per watt

### LAMPING INFORMATION

18w LED Module, 3000K, 90 CRI,  
1400 lumens, dimmable.

PROGRESSLIGHTING.COM



Fan



Light



Damp  
Indoor/Outdoor



Full Function Remote Control Included

- Full-range dimming for light
- Six-speed fan operation
- Reverse direction control

# GAZE



P2554-1530K shown with Cherry blades

Three-blade 60" Gaze ceiling fan features an LED light source, offering both form and function with energy and cost-savings benefits. An opal white shade contains an 18W dimmable, 3000K LED module. Gaze features a dual mount system and includes a three-speed remote control with full range dimming.

### FEATURES

- Limited lifetime warranty
- Dual Mount (flat or sloped ceiling-20°)
- Reversible plywood blades
- White shatterproof lens
- Remote control with batteries is included
- Remote may be replaced with P2630-30 or P2630-95 wall control

### SIZE

60" dia., 13-1/8" ht.  
80" lead wires

### FINISHES

- Brushed Nickel - 09
- Polished Chrome - 15
- Antique Bronze - 20

PROGRESSLIGHTING.COM

**P2554-0930K**  
Brushed Nickel shown  
with Silver blades



Cherry



Silver



**P2554-1530K**  
Polished Chrome shown  
with White Washed blades



Cherry



White Washed



**P2554-2030K**  
Antique Bronze shown  
with Cherry blades



Cherry



Walnut



### ENERGY INFORMATION AT HIGH SPEED

<b>AIRFLOW:</b>	5,902 cubic feet per minute
<b>ELECTRICITY USE:</b>	75 watts (excludes lights)
<b>AIRFLOW EFFICIENCY:</b>	79 cubic feet per minute per watt

### LAMPING INFORMATION

18w LED Module, 3000K, 90 CRI,  
1400 lumens, dimmable.

PROGRESSLIGHTING.COM



Fan



Light



Dry  
Indoor only



Three-Speed Remote Included  
Full-range dimming for light  
Three-speed fan operation

# SPADES



P2570-143 shown with Graphite blades

The 56" Spades ceiling fan features a sleek contemporary two-blade design that is finished in Brushed Nickel, Polished Chrome or Graphite options. Spades features a dual mount system, an energy saving DC motor and ABS composite blades. A full function remote control is included.

#### FEATURES

- Limited Lifetime Warranty
- Dual Mount (flat or sloped ceiling-17°)
- Close-to-ceiling installation
- DC motor
- Non-reversible ABS blades
- Remote control with batteries is included

#### SIZE

56" dia., 36-1/4" ht.  
80" lead wires

#### FINISHES

- Brushed Nickel - 09
- Polished Chrome - 15
- Graphite - 143

PROGRESSLIGHTING.COM

**P2570-09**  
Brushed Nickel shown  
with Silver blades



Silver



**P2570-15**  
Polished Chrome shown  
with Black blades



Black



**P2570-143**  
Graphite shown  
with Graphite blades



Graphite



#### ENERGY INFORMATION AT HIGH SPEED

<b>AIRFLOW:</b>	6,746 cubic feet per minute
<b>ELECTRICITY USE:</b>	32 watts (excludes lights)
<b>AIRFLOW EFFICIENCY:</b>	207 cubic feet per minute per watt



Full Function Remote Control Included  
Six-speed fan operation  
Reverse direction control

PROGRESSLIGHTING.COM

#### CTC INSTALLATION

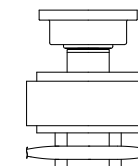

Fan



Dry  
Indoor only



# ORIOLE NEW



P2592-3130K shown with Black blades

This 60" Oriole ceiling fan is the perfect addition to interior garages, industrial shops or commercial buildings to distribute the right amount of air and keep the space cool and comfortable. Oriole contains an integrated 18W LED module, with an optional finishing cap offering the user the choice to install with or without the light kit. A remote control is included to adjust speed and turn on/off the light or fan. A blank off plate comes standard.

#### FEATURES

- Limited lifetime warranty
- Dual Mount (flat or sloped ceiling-18.5°)
- ABS blades
- White opal glass shade
- Remote control with batteries is included
- Remote may be replaced with P2630-30 or P2630-95 wall control

#### SIZE

60" dia., 14-1/2" ht.  
80" lead wires

#### FINISHES

- Brushed Nickel - 09
- Black - 31
- Architectural Bronze - 129

PROGRESSLIGHTING.COM

#### P2592-0930K

Brushed Nickel shown  
with Silver blades



Silver



#### P2592-3130K

Black shown  
with Black blades



Black



shown with light kit removed

#### P2592-12930K

Architectural Bronze shown  
with Architectural Bronze blades



Architectural Bronze



#### ENERGY INFORMATION AT HIGH SPEED

<b>AIRFLOW:</b>	6,171 cubic feet per minute
<b>ELECTRICITY USE:</b>	51 watts (excludes lights)
<b>AIRFLOW EFFICIENCY:</b>	121 cubic feet per minute per watt

#### LAMPING INFORMATION

18w LED Module, 3000K, 90 CRI,  
1400 lumens, dimmable.

PROGRESSLIGHTING.COM



Canada



Fan



Light



Dry  
Indoor only



Three-Speed Remote Included  
Full-range dimming for light  
Three-speed fan operation

# TEASLEY NEW



P250004-129 shown with Distressed Walnut blades

Featuring coastal influences and farmhouse charm, the Teasley 56" 5-blade ceiling fan is suitable for a variety of interior settings. Clear seeded bell-shaped glass shades highlight Architectural Bronze, Graphite or Galvanized finish options. Three vintage LED lamps are included, offering energy efficiency and cost savings benefits for the home, while a dual mount canopy accommodates flat or sloped ceilings.

#### FEATURES

- Limited lifetime warranty
- Dual Mount (flat or sloped ceiling-18.5°)
- Reversible plywood blades
- Clear seeded glass shades
- Three speed pull-chain switch
- Add a P2630-30 or P2630-95 wall control or P2662-01 hand-held remote control

#### SIZE

56" dia., 22-1/2" ht.  
80" lead wires

#### FINISHES

- Architectural Bronze - 129
- Galvanized - 141
- Graphite - 143

PROGRESSLIGHTING.COM

#### P250004-129

Architectural Bronze shown  
with Brushed Bronze accents  
and American Walnut blades

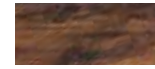

Distressed Walnut



American Walnut

#### P250004-141

Galvanized shown  
with Brushed Nickel accents  
and Driftwood blades



Driftwood

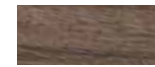

Gray Weathered Wood

#### P250004-143

Graphite shown  
with Brushed Nickel accents  
and Gray Weathered Wood blades



Gray Weathered Wood



American Walnut



#### ENERGY INFORMATION AT HIGH SPEED

<b>AIRFLOW:</b>	5,749 cubic feet per minute
<b>ELECTRICITY USE:</b>	76 watts (excludes lights)
<b>AIRFLOW EFFICIENCY:</b>	75 cubic feet per minute per watt

#### LAMPING INFORMATION

Three medium base vintage lamps,  
each 7w max included. (dimnable)

PROGRESSLIGHTING.COM



Dry  
Indoor only

# GLANDON



P2586-7130K shown with Toasted Oak blades

The 60" Glandon ceiling fan features a 17w LED module (3000K color temperature) with a shatterproof white opal shade. Glandon is available in Antique Nickel and Gilded Iron finishes. With a sophisticated and modern design, Glandon has a dual mount system. Full range dimming and remote control is included.

### FEATURES

- Limited Lifetime Warranty
- Dual Mount (flat or sloped ceiling-20°)
- Reversible plywood blades
- White opal shatterproof shade
- Remote control with batteries is included
- Remote may be replaced with P2630-30 or P2630-95 wall control

### SIZE

60" dia., 17-1/8" ht.  
80" lead wires

### FINISHES

- Gilded Iron - 71
- Antique Nickel - 81

PROGRESSLIGHTING.COM

### P2586-7130K

Gilded Iron shown with Driftwood blades



Driftwood



Toasted Oak



### P2586-8130K

Antique Nickel shown with Classic Walnut blades



Driftwood



Classic Walnut



### ENERGY INFORMATION AT HIGH SPEED

<b>AIRFLOW:</b>	6,036 cubic feet per minute
<b>ELECTRICITY USE:</b>	84 watts (excludes lights)
<b>AIRFLOW EFFICIENCY:</b>	71 cubic feet per minute per watt

### LAMPING INFORMATION

17w LED Module, 3000K, 90 CRI, 1400 lumens, dimmable.

PROGRESSLIGHTING.COM



Remote Control Included  
Full-range dimming for light  
Three-speed fan operation



Fan



Light



Dry  
Indoor only

# GREER



P2584-71 shown with Toasted Oak blades

This five-blade 54" Greer ceiling fan complements either industrial or farmhouse decor. It comes with a wire meshed shade light kit that uses two vintage LED lamps (included). Remote control is also included. Hang it on a flat or sloped ceiling with its dual mount system.

#### FEATURES

- Limited Lifetime Warranty
- Dual Mount (flat or sloped ceiling-45°)
- Reversible plywood blades
- Wire basket shade light kit
- Remote control with batteries is included
- Remote may be replaced with P2630-30 or P2630-95 wall control

#### SIZE

54" dia., 21-5/8" ht.  
80" lead wires

#### FINISHES

- Gilded Iron - 71
- Antique Nickel - 81

PROGRESSLIGHTING.COM

#### P2584-71

Gilded Iron shown  
with Driftwood blades



Driftwood



Toasted Oak



#### P2584-81

Antique Nickel shown  
with Classic Walnut blades



Driftwood



Classic Walnut



#### ENERGY INFORMATION AT HIGH SPEED

<b>AIRFLOW:</b>	4,794 cubic feet per minute
<b>ELECTRICITY USE:</b>	65 watts (excludes lights)
<b>AIRFLOW EFFICIENCY:</b>	73 cubic feet per minute per watt

#### LAMPING INFORMATION

Two medium base vintage lamps,  
each 5.5w max included. (dimnable)

PROGRESSLIGHTING.COM



Remote Control Included  
Full-range dimming for light  
Three-speed fan operation



Dry  
Indoor only

# SHAFFER NEW



P2590-80 shown with Silver blades

The 4-blade 56" Shaffer ceiling fan blends a streamlined design with mixed metal elements and a wire mesh housing, suitable for modern and urban industrial spaces. Available in Satin White with galvanized accents, Forged Black with chrome accents and Architectural Bronze with brushed bronze accents. Shaffer features a dual mount system and includes a remote control with batteries.

#### FEATURES

- Limited lifetime warranty
- Dual Mount (flat or sloped ceiling-18.5°)
- Reversible plywood blades
- Not compatible with light kits
- Remote control with batteries is included
- Remote may be replaced with P2630-30 or P2630-95 wall control

#### SIZE

56" dia., 16-1/4" ht.  
80" lead wires

#### FINISHES

- Satin White - 28
- Forged Black - 80
- Architectural Bronze - 129

PROGRESSLIGHTING.COM

#### P2590-28

Satin White shown  
with Galvanized Accents  
and Silver blades



Silver



White



#### P2590-80

Forged Black shown  
with Chrome Accents  
and Black blades



Black



Silver



#### P2590-129

Architectural Bronze shown  
with Brushed Bronze Accents  
and Driftwood blades



Driftwood



Natural Cherry



#### ENERGY INFORMATION AT HIGH SPEED

<b>AIRFLOW:</b>	6,144 cubic feet per minute
<b>ELECTRICITY USE:</b>	67 watts (excludes lights)
<b>AIRFLOW EFFICIENCY:</b>	91 cubic feet per minute per watt



Three-Speed Remote Included  
Full-range dimming for light  
Three-speed fan operation

PROGRESSLIGHTING.COM



Canada



Fan



Dry  
Indoor only

# SOAR



P2542-0930K shown with Black blades

With a white opal shade and a 17W dimmable LED module, the 54" Soar ceiling fan offers energy and cost-savings benefits for a variety of living spaces. The four-blade fan comes with a remote control and is available in Brushed Nickel, Antique Bronze and White finishes. LED source features a 3000K-color temperature. Soar features a dual mount system and includes a remote control with batteries.

### FEATURES

- Limited lifetime warranty
- Dual Mount (flat or sloped ceiling-20°)
- Non-reversible plywood blades
- White opal shatterproof lens
- Remote control with batteries is included
- Remote may be replaced with P2630-30 or P2630-95 wall control

### SIZE

54" dia., 15" ht.  
80" lead wires

### FINISHES

- Brushed Nickel - 09
- Antique Bronze - 20
- White - 30

PROGRESSLIGHTING.COM

**P2542-0930K**  
Brushed Nickel shown  
with Black blades



Black



**P2542-2030K**  
Antique Bronze shown  
with Walnut blades



Walnut



**P2542-3030K**  
White shown  
with White blades



White



### ENERGY INFORMATION AT HIGH SPEED

<b>AIRFLOW:</b>	4,814 cubic feet per minute
<b>ELECTRICITY USE:</b>	65 watts (excludes lights)
<b>AIRFLOW EFFICIENCY:</b>	74 cubic feet per minute per watt

### LAMPING INFORMATION

17w LED Module, 3000K, 90 CRI,  
1400 lumens, dimmable.

PROGRESSLIGHTING.COM



Remote Control Included  
Full-range dimming for light  
Three-speed fan operation



Fan



Light



Dry  
Indoor only

# HARRANVALE



P2540-2030K shown with Medium Cherry blades

The 54" Harranvale features a design that incorporates mixed metal design details that is very popular in today's home decor. Featuring reversible blades and opal glass shade, fans are available in three finish options: Antique Bronze with Brushed Bronze accent; Graphite with Brushed Nickel accent; and White with Brushed Nickel accent. Harranvale features a dual mount system and includes a remote control with batteries.

#### FEATURES

- Limited lifetime warranty
- Dual Mount (flat or sloped ceiling-20°)
- Reversible plywood blades
- White opal glass
- Remote control with batteries is included
- Remote may be replaced with P2630-30 or P2630-95 wall control

#### SIZE

54" dia., 16-3/8" ht.  
80" lead wires

#### FINISHES

- Antique Bronze - 20
- White - 30
- Graphite - 143

PROGRESSLIGHTING.COM

#### P2540-2030K

Antique Bronze shown  
with Brushed Bronze accent  
and Medium Cherry blades



Classic Walnut



Medium Cherry

#### P2540-3030K

White shown  
with Brushed Nickel accent  
and White blades



White



White

#### P2540-14330K

Graphite shown  
with Brushed Nickel accent  
and Graphite blades



Graphite



American Walnut



#### ENERGY INFORMATION AT HIGH SPEED

<b>AIRFLOW:</b>	5,121 cubic feet per minute
<b>ELECTRICITY USE:</b>	66 watts (excludes lights)
<b>AIRFLOW EFFICIENCY:</b>	78 cubic feet per minute per watt

#### LAMPING INFORMATION

17w LED Module, 3000K, 90 CRI,  
1400 lumens, dimmable.

PROGRESSLIGHTING.COM



Remote Control Included  
Full-range dimming for light  
Three-speed fan operation



Fan



Light



Dry  
Indoor only

# GRACEFUL



P2544-0930K shown with Medium Cherry blades

Refresh your living space with the crisp, clean style of the 54" Graceful fan. With a white opal glass shade and a 17W dimmable LED module, the five-blade fan comes with a remote control and is available in Brushed Nickel, Polished Chrome and Antique Bronze finishes. LED source offers a 3000K-color temperature, energy savings and maintenance benefits for the home.

#### FEATURES

- Limited lifetime warranty
- Dual Mount (flat or sloped ceiling-20°)
- Reversible plywood blades
- White opal glass
- Remote control with batteries is included
- Remote may be replaced with P2630-30 or P2630-95 wall control

#### SIZE

54" dia., 16-3/8" ht.  
80" lead wires

#### FINISHES

- Brushed Nickel - 09
- Polished Chrome - 15
- Antique Bronze - 20

PROGRESSLIGHTING.COM

#### P2544-0930K

Brushed Nickel shown  
with Medium Cherry blades



Medium Cherry



Silver



#### P2544-1530K

Polished Chrome shown  
with Silver blades



Toasted Oak



Silver



#### P2544-2030K

Antique Bronze shown  
with American Walnut blades



Medium Cherry



American Walnut



#### ENERGY INFORMATION AT HIGH SPEED

<b>AIRFLOW:</b>	4,454 cubic feet per minute
<b>ELECTRICITY USE:</b>	60 watts (excludes lights)
<b>AIRFLOW EFFICIENCY:</b>	74 cubic feet per minute per watt

#### LAMPING INFORMATION

17w LED Module, 3000K, 90 CRI,  
1400 lumens, dimmable.

PROGRESSLIGHTING.COM



Remote Control Included  
Full-range dimming for light  
Three-speed fan operation



Fan



Light



Dry  
Indoor only





# OLSON NEW

P2598-143 shown with Graphite blades

The 52" Olson ceiling fan features a generously sized etched watermark glass shade and sweeping blades highlighted with metal accents in a Brushed Nickel or Graphite finish. Two LED lamps are JA8 compliant, offering both form and function with energy and cost-savings benefits. Olson features a dual mount system and a three-speed pull chain fan switch, as well as an on/off pull chain switch to operate the light.

#### FEATURES

- Limited Lifetime Warranty
- Dual Mount (flat or sloped ceiling-18.5°)
- Reversible plywood blades
- Etched watermark glass
- Three speed pull-chain switch
- Add a P2630-30 or P2630-95 wall control, P2661-01 or P2662-01 hand-held remote control

#### SIZE

52" dia., 21-5/16" ht.  
80" lead wires

#### FINISHES

- Brushed Nickel - 09
- Graphite - 143

PROGRESSLIGHTING.COM

#### P2598-09

Brushed Nickel shown  
with Medium Cherry blades



Medium Cherry



Classic Walnut



#### P2598-143

Graphite shown  
with Gray Weathered Wood blades



Gray Weathered Wood



Graphite



#### ENERGY INFORMATION AT HIGH SPEED

<b>AIRFLOW:</b>	5,023 cubic feet per minute
<b>ELECTRICITY USE:</b>	70 watts (excludes lights)
<b>AIRFLOW EFFICIENCY:</b>	71 cubic feet per minute per watt

#### LAMPING INFORMATION

Two medium base LED lamps, 3000K, 90 CRI,  
800 lumens, dimmable.

PROGRESSLIGHTING.COM



Canada



Fan



Light



Dry  
Indoor only

# GUST



P2582-14330K shown with Graphite blades

This five-blade 54" Gust ceiling fan features a white opal glass shade that is available in a Brushed Nickel, Graphite or Antique Bronze finish. A remote control is included. Gust has a dual mount system to offer greater flexibility when installing. The 18W dimmable, 3000K LED module provides energy and cost-savings benefits to the homeowner.

#### FEATURES

- Limited Lifetime Warranty
- Dual Mount (flat or sloped ceiling-18.5°)
- Non-reversible plywood blades
- White opal glass shade
- Remote control with batteries is included
- Remote may be replaced with P2630-30 or P2630-95 wall control

#### SIZE

54" dia., 16" ht.  
80" lead wires

#### FINISHES

- Brushed Nickel - 09
- Antique Bronze - 20
- Graphite - 143

PROGRESSLIGHTING.COM

#### P2582-0930K

Brushed Nickel shown  
with Silver blades



Silver



#### P2582-2030K

Antique Bronze shown  
with Walnut blades



Walnut



#### P2582-14330K

Graphite shown  
with Graphite blades



Graphite



#### ENERGY INFORMATION AT HIGH SPEED

<b>AIRFLOW:</b>	5,242 cubic feet per minute
<b>ELECTRICITY USE:</b>	65 watts (excludes lights)
<b>AIRFLOW EFFICIENCY:</b>	80 cubic feet per minute per watt

#### LAMPING INFORMATION

18w LED Module, 3000K, 90 CRI,  
1400 lumens, dimmable.

PROGRESSLIGHTING.COM



Three-Speed Remote Included  
Full-range dimming for light  
Three-speed fan operation



Fan



Light



Dry  
Indoor only

# KUDOS



P2568-2030K shown with Walnut blades

This five-blade 52" Kudos ceiling fan features a clear Fresnel glass shade. Available in a Brushed Nickel, Polished Chrome or Antique Bronze finish and includes a remote control. The Kudos features a dual mount system to offer greater flexibility when installing. The 18W dimmable, 3000K LED module provides energy and cost-savings benefits to the homeowner.

#### FEATURES

- Limited Lifetime Warranty
- Dual Mount (flat or sloped ceiling-18.5°)
- Reversible plywood Blades
- Clear Fresnel glass shade
- Remote control with batteries is included
- Remote may be replaced with P2630-30 or P2630-95 wall control

#### SIZE

52" dia., 17-5/8" ht.  
80" lead wires

#### FINISHES

- Brushed Nickel - 09
- Polished Chrome - 15
- Antique Bronze - 20

PROGRESSLIGHTING.COM

#### P2568-0930K

Brushed Nickel shown  
with American Walnut blades



American Walnut



Silver



#### P2568-1530K

Polished Chrome shown  
with Black blades



Medium Cherry



Black



#### P2568-2030K

Antique Bronze shown  
with Cherry blades



Walnut



Cherry



#### ENERGY INFORMATION AT HIGH SPEED

<b>AIRFLOW:</b>	5,160 cubic feet per minute
<b>ELECTRICITY USE:</b>	60 watts (excludes lights)
<b>AIRFLOW EFFICIENCY:</b>	86 cubic feet per minute per watt

#### LAMPING INFORMATION

18w LED Module, 3000K, 90 CRI,  
1400 lumens, dimmable.

PROGRESSLIGHTING.COM



Three-Speed Remote Included  
Full-range dimming for light  
Three-speed fan operation



Fan



Light



Dry  
Indoor only

# FRESNO

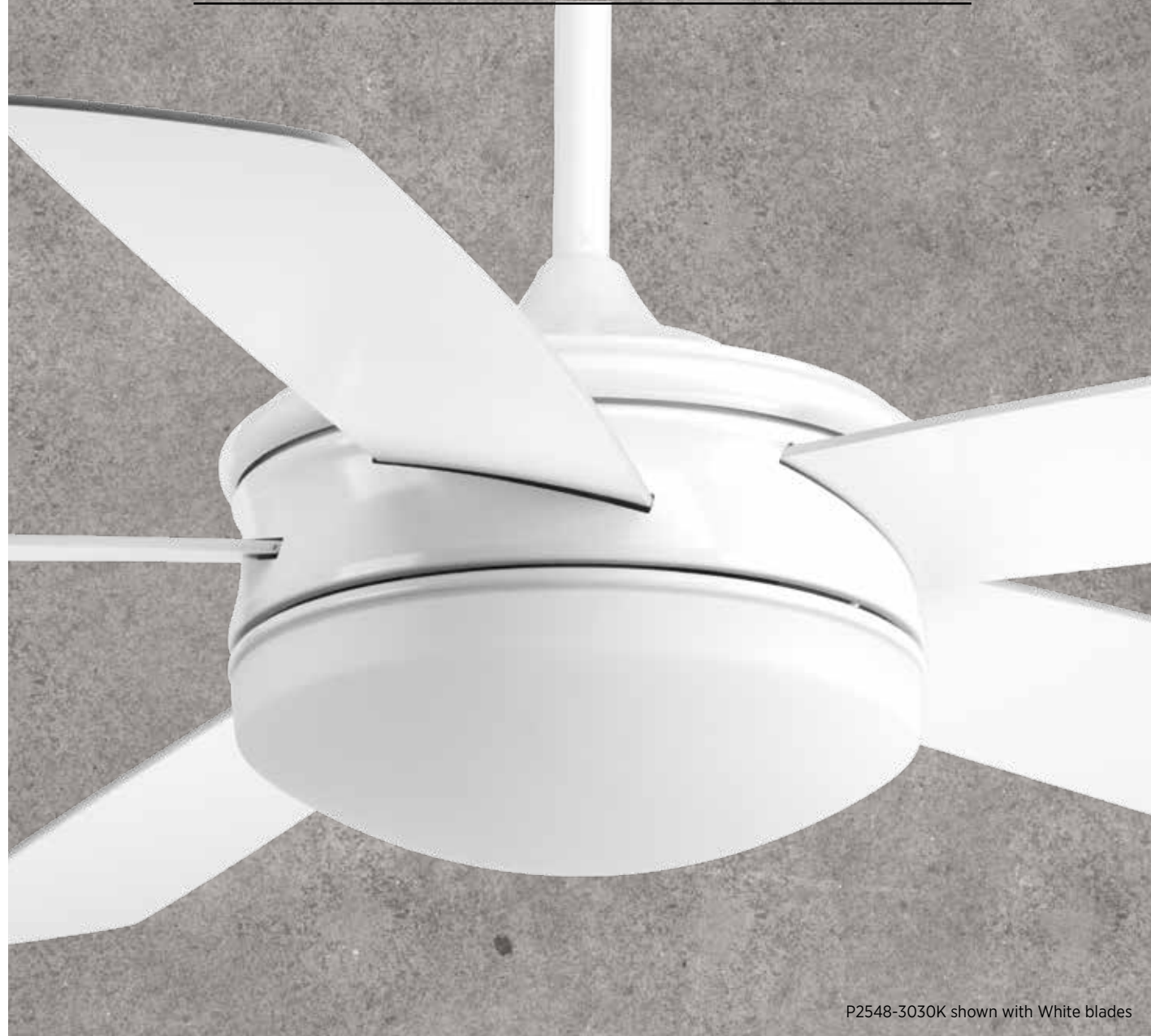

P2548-3030K shown with White blades

Five-blade 60" Fresno ceiling fan features an LED light source, offering both form and function with energy and cost-savings benefits. A white opal glass shade features an 18W dimmable, 3000K LED module. A remote control with full range dimming and remote control is included.

#### FEATURES

- Limited lifetime warranty
- Dual Mount (flat or sloped ceiling-17.5°)
- Reversible plywood blades
- White opal glass
- Remote control with batteries is included. Receiver mounted in motor.
- Remote may be replaced with P2631-30 wall control

#### SIZE

60" dia., 17-1/4" ht.  
80" lead wires

#### FINISHES

- Brushed Nickel - 09
- Antique Bronze - 20
- White - 30

PROGRESSLIGHTING.COM

#### P2548-0930K

Brushed Nickel shown  
with Silver blades



Black



Silver



#### P2548-2030K

Antique Bronze shown  
with Dark Walnut blades



Cherry



Dark Walnut



#### P2548-3030K

White shown  
with White blades



White



White



#### ENERGY INFORMATION AT HIGH SPEED

<b>AIRFLOW:</b>	5,718 cubic feet per minute
<b>ELECTRICITY USE:</b>	79 watts (excludes lights)
<b>AIRFLOW EFFICIENCY:</b>	72 cubic feet per minute per watt

#### LAMPING INFORMATION

18w LED Module, 3000K, 90 CRI,  
1400 lumens, dimmable.

PROGRESSLIGHTING.COM



Full Function Remote Control Included  
Full-range dimming for light  
Three-speed fan operation  
Reverse direction control



Fan



Light



Dry  
Indoor only

# TEMPT



P2578-1530K shown with Black blades

This five-blade 52" Tempt ceiling fan features a clear, double prismatic glass shade that is available in a Polished Chrome or Antique Bronze finish. A remote is included. Tempt features a dual mount system to offer greater flexibility when installing. The 17W dimmable, 3000K LED module provides energy and cost-savings benefits to the homeowner.

#### FEATURES

- Limited Lifetime Warranty
- Dual Mount (flat or sloped ceiling-20°)
- Reversible plywood blades
- Clear double prismatic glass shade
- Remote control with batteries is included
- Remote may be replaced with P2630-30 or P2630-95 wall control

#### SIZE

52" dia., 16-1/4" ht.  
80" lead wires

#### FINISHES

- Polished Chrome - 15
- Antique Bronze - 20

PROGRESSLIGHTING.COM

#### P2578-1530K

Polished Chrome shown  
with Medium Cherry blades



Medium Cherry



Black



#### P2578-2030K

Antique Bronze shown  
with American Walnut blades



Medium Cherry



American Walnut



#### ENERGY INFORMATION AT HIGH SPEED

<b>AIRFLOW:</b>	4,314 cubic feet per minute
<b>ELECTRICITY USE:</b>	63 watts (excludes lights)
<b>AIRFLOW EFFICIENCY:</b>	78 cubic feet per minute per watt

#### LAMPING INFORMATION

17w LED Module, 3000K, 90 CRI,  
1400 lumens, dimmable.

PROGRESSLIGHTING.COM



Fan



Light



Dry  
Indoor only



Remote Control Included  
Full-range dimming for light  
Three-speed fan operation

# VERADA



P2558-0930K shown with Medium Cherry blades

This five-blade 52" Verada ceiling fan combines a linen glass shade with a 17W LED source. Available in a Brushed Nickel or Antique Bronze finish. Verada features a dual mount system and a three-speed pull chain fan switch, as well as an on/off pull chain switch to operate the light. LED light kit features a 3000K color temperature.

#### FEATURES

- Limited Lifetime Warranty
- Dual Mount (flat or sloped ceiling-30°)
- Reversible plywood Blades
- Linen Glass shade
- 3 Speed pull chain switches
- Add a P2630-30 or P2630-95 wall control or P2614-01 hand-held remote control

#### SIZE

52" dia., 16" ht.  
80" lead wires

#### FINISHES

- Brushed Nickel - 09
- Antique Bronze - 20

PROGRESSLIGHTING.COM

#### P2558-0930K

Brushed Nickel with white linen glass shown with American Walnut blades



Medium Cherry



American Walnut



#### P2558-2030K

Antique Bronze with tea stained linen glass shown with Medium Cherry blades



Medium Cherry



American Walnut



#### ENERGY INFORMATION AT HIGH SPEED

<b>AIRFLOW:</b>	4,445 cubic feet per minute
<b>ELECTRICITY USE:</b>	65 watts (excludes lights)
<b>AIRFLOW EFFICIENCY:</b>	79 cubic feet per minute per watt

#### LAMPING INFORMATION

17w LED Module, 3000K, 90 CRI, 1400 lumens, dimmable.

PROGRESSLIGHTING.COM



Fan



Light



Dry  
Indoor only

# BILLOWS



P2552-80 shown with Toasted Oak blades

With a sophisticated and traditional design, the Billows offers both form and function with two energy efficient 10W LED lamps, featuring a 3000K color temperature. The 52" Billows ceiling fan features an LED light kit with white opal glass shade and five reversible blades. The fans are available in Brushed Nickel, Antique Bronze and Forged Black finishes.

#### FEATURES

- Limited lifetime warranty
- Dual Mount (flat or sloped ceiling-18.5°)
- Reversible plywood blades
- White opal glass
- Add a P2630-30 or P2630-95 wall control or P2662-01 hand-held remote control

#### SIZE

52" dia., 17-1/2" ht.  
80" lead wires

#### FINISHES

- Brushed Nickel - 09
- Antique Bronze - 20
- Forged Black - 80

PROGRESSLIGHTING.COM

#### P2552-09

Brushed Nickel shown  
with Silver blades



White Washed



Silver



#### P2552-20

Antique Bronze shown  
with American Walnut blades



Cherry



American Walnut



#### P2552-80

Forged Black shown  
with Toasted Oak blades



Black



Toasted Oak



#### ENERGY INFORMATION AT HIGH SPEED

<b>AIRFLOW:</b>	4,682 cubic feet per minute
<b>ELECTRICITY USE:</b>	59 watts (excludes lights)
<b>AIRFLOW EFFICIENCY:</b>	79 cubic feet per minute per watt

#### LAMPING INFORMATION

Two medium base, 3000K, LED lamps included.  
800 lumens/lamp, 90 CRI, dimmable (with added wall control or remote).

PROGRESSLIGHTING.COM



Fan



Light



Dry  
Indoor only

# SIGNATURE PLUS II



P2539-0930K shown with Silver blades

Five-blade 54" Signature Plus II ceiling fan features an integrated LED light source, offering both form and function with energy and cost-savings benefits. The light kit contains a white opal shatterproof shade and is comprised of a 17W dimmable 3000K LED module. A remote control is included and controls full range dimming and fan speed capabilities. Signature Plus II also has a reversible motor that can be accessed via a manual switch.

#### FEATURES

- Limited lifetime warranty
- 45° Canopy
- Downrod mount only
- Reversible MDF blades
- Opal shatterproof shade
- Remote control with batteries is included
- Remote may be replaced with P2630-30 or P2630-95 wall control

#### SIZE

54" dia., 15-1/2" ht.  
80" lead wires

#### FINISHES

- Brushed Nickel - 09
- Antique Bronze - 20
- White - 30

PROGRESSLIGHTING.COM

#### P2539-0930K

Brushed Nickel shown  
with Silver blades



Driftwood



Silver



#### P2539-2030K

Antique Bronze shown  
with Medium Cherry blades



Classic Walnut



Medium Cherry



#### P2539-3030K

White shown  
with White blades



White



White



#### ENERGY INFORMATION AT HIGH SPEED

<b>AIRFLOW:</b>	5,331 cubic feet per minute
<b>ELECTRICITY USE:</b>	65 watts (excludes lights)
<b>AIRFLOW EFFICIENCY:</b>	82 cubic feet per minute per watt

#### LAMPING INFORMATION

17w LED Module, 3000K, 90 CRI,  
1400 lumens, dimmable.

PROGRESSLIGHTING.COM



Remote Control Included  
Full-range dimming for light  
Three-speed fan operation



Fan



Light



Dry  
Indoor only



# SIGNATURE



P2521-80 shown with Dark Cherry blades. Includes reversible Dark Walnut blades.

A 52" Signature 5-blade fan features reversible blades and a 30-year limited warranty. A powerful AirPro motor features a 3-speed, triple-capacitor control that can also be reversed to provide year-round comfort. The Signature fan will also accept a universal light kit.

#### FEATURES

- 30-year limited warranty
- 45° Canopy
- Close-to-ceiling installation
- SureConnect® System
- Compatible with universal light kits
- Three speed pull-chain switch
- Add a P2630-30 or P2630-95 wall control or P2614-01 hand-held remote control

#### SIZE

52" dia., 14-5/8" ht.  
CTC 11-9/16" ht.  
80" lead wires

#### FINISHES

- Brushed Nickel - 09
- Antique Bronze - 20
- Forged Bronze - 77
- Forged Black - 80
- Antique Nickel - 81



**P2521-09**  
Brushed Nickel shown  
with White Blades



Natural Cherry White



**P2521-09CH**  
Brushed Nickel shown  
with Cherry Blades



Natural Cherry Cherry



**P2521-09WA**  
Brushed Nickel shown  
with Classic Walnut blades



Dark Walnut Classic Walnut



**P2521-20** shown with P2602-20WB light kit\*  
Antique Bronze shown with  
Classic Walnut blades



Classic Walnut Medium Cherry



**P2521-77**  
Forged Bronze shown  
with Classic Walnut blades



Classic Walnut Medium Cherry



**P2521-81**  
Antique Nickel shown  
with Medium Oak blades



Cherry Medium Oak

#### ENERGY INFORMATION AT HIGH SPEED

<b>AIRFLOW:</b>	4,701 cubic feet per minute
<b>ELECTRICITY USE:</b>	65 watts (excludes lights)
<b>AIRFLOW EFFICIENCY:</b>	84 cubic feet per minute per watt

\* Light kit sold separately.

PROGRESSLIGHTING.COM

#### CTC INSTALLATION

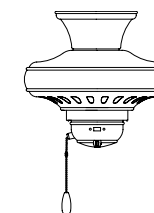

Fan



Dry  
Indoor only

# TREVINA II



P2556-2030K shown with Medium Cherry blades

A popular ceiling fan collection, the 52" Trevina II features three blades available in Brushed Nickel and Antique Bronze finishes. The LED version is also available in a White finish. Coolly modern, the Trevina II ceiling fan offers both form and function with an energy efficient 17W LED source with a 3000K-color temperature and also includes a wall control switch (LED model only).

### FEATURES

- Limited lifetime warranty (LED model)
- 30-year limited warranty (Incandescent model)
- Dual Mount (flat or sloped ceiling-30°)
- Close-to-ceiling installation
- Reversible plywood blades
- Etched opal glass
- Compatible with remote or hardwired wall controls (P2614-01, P2618-01, P2630, P2662-01 (sold separately))

### SIZE

52" dia., 15-3/4" ht.  
80" lead wires

### FINISHES

- Brushed Nickel - 09
- Antique Bronze - 20
- White - 30

PROGRESSLIGHTING.COM

**P2556-0930K**  
**P2538-09**  
*Brushed Nickel shown with Silver blades*



Silver

**P2556-2030K**  
**P2538-20**  
*Antique Bronze shown with Medium Cherry blades*



Medium Cherry

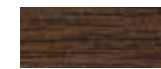

Classic Walnut

**P2556-3030K**  
*White shown with White blades*



White



Natural Cherry



## P2556-0930K / P2556-2030K / P2556-3030K

### ENERGY INFORMATION AT HIGH SPEED

**AIRFLOW:** 4,742 cubic feet per minute  
**ELECTRICITY USE:** 64 watts (excludes lights)  
**AIRFLOW EFFICIENCY:** 79 cubic feet per minute per watt

### LAMPING INFORMATION

17w LED Module, 3000K, 90 CRI, 1400 lumens, dimmable.

### CTC INSTALLATION

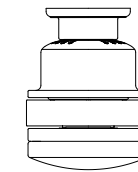

Fan



Light



Dry

Indoor only



Wall Control Included  
Full-range dimming for light  
Four-speed fan operation  
Includes switch plate cover

## P2538-09 / P2538-20

### ENERGY INFORMATION AT HIGH SPEED

**AIRFLOW:** 4,742 cubic feet per minute  
**ELECTRICITY USE:** 64 watts (excludes lights)  
**AIRFLOW EFFICIENCY:** 79 cubic feet per minute per watt

### LAMPING INFORMATION

Two medium base lamps, each 60w max. CFL lamps (included).

PROGRESSLIGHTING.COM



Fan



Dry

Indoor only

*This fan is not shipped with speed/lighting controls. Refer to the spec sheet for more information.*

Trevina 3-blade ceiling fan features an etched opal finish shade on the light kit and three Silver blades with the brushed nickel finish. An easy-to-assemble canopy system can be installed on vaulted ceilings up to 4:12 pitch. A full function remote control is included.

**FEATURES**

- 30-year limited warranty
- Installs to ceilings up to 25° (4:12 pitch)
- Etched opal glass
- Remote control with batteries is included
- Remote may be replaced with P2631-30 wall control

**SIZE**

52" dia., 18" ht.  
80" lead wires

**FINISHES**

- Brushed Nickel - 09



**P2514-09**  
Brushed Nickel shown  
with Silver blades



**P2514-09**  
Brushed Nickel shown  
with Silver blades

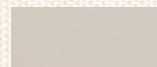

Silver

**ENERGY INFORMATION AT HIGH SPEED**

**AIRFLOW:** 4,109 cubic feet per minute  
**ELECTRICITY USE:** 53 watts (excludes lights)  
**AIRFLOW EFFICIENCY:** 79 cubic feet per minute per watt

**LAMPING INFORMATION**

One E-11 lamp, 100w max included,  
dimnable



Full Function Remote Included  
Full-range dimming for light  
Three-speed fan operation  
Reverse direction control



Fan



Dry  
Indoor only

The 52" Edgefield fan is energy efficient and lightweight. A DC motor provides ultra quiet operation and the efficiency of the latest fan technology along with the simple convenience of a four-speed pull chain switch. Edgefield features a reversible motor for year round comfort and is available in three finish options. Pair with a universal light kit for a more customized look.

**FEATURES**

- Limited lifetime warranty
- Dual Mount (flat or sloped ceiling-18.5°)
- DC motor
- MDF blades
- Compatible with universal light kits
- Three speed pull-chain switch
- Will not accept a wall or remote control

**SIZE**

52" dia., 14-9/16" ht.  
80" lead wires

**FINISHES**

- Brushed Nickel - 009
- White - 030
- Architectural Bronze - 129



**P250016-129**  
Architectural Bronze shown  
with Classic Walnut blades



**P250016-009**  
Brushed Nickel shown  
with American Walnut blades



American Walnut



Cherry



**P250016-030**  
White shown  
with White blades



White



White



**P250016-129**  
Architectural Bronze shown  
with Medium Cherry blades



Classic Walnut



Medium Cherry

**ENERGY INFORMATION AT HIGH SPEED**

**AIRFLOW:** 5,741 cubic feet per minute  
**ELECTRICITY USE:** 34 watts (excludes lights)  
**AIRFLOW EFFICIENCY:** 168 cubic feet per minute per watt



Fan



Dry  
Indoor only

# NORTH PARK

52" 4-blade North Park ceiling fan features distinctive, squared reversible blades. This contemporary styled fan offers great performance and value. The North Park fan features a powerful, 3-speed motor that can be reversed to provide year-round comfort. The North Park fan will also accept a universal light kit.

### FEATURES

- 30-year limited warranty
- 45° Canopy
- Close-to-ceiling installation
- SureConnect System
- Compatible with universal light kits
- Three speed pull-chain switch
- Add a P2630-30 or P2630-95 wall control or P2662-01 hand-held remote control

### SIZE

52" dia., 15-3/4" ht.  
CTC 11" ht.  
80" lead wires

### FINISHES

- Brushed Nickel - 09
- Antique Bronze - 20



**P2531-09**  
Brushed Nickel shown with Cherry blades



**P2531-09**  
Brushed Nickel shown with Natural Cherry blades



Natural Cherry    Cherry



**P2531-20**  
shown with P2654-01WB light kit\*  
Antique Bronze shown with Cherry blades



Classic Walnut    Cherry

#### ENERGY INFORMATION AT HIGH SPEED

**AIRFLOW:** 4,373 cubic feet per minute  
**ELECTRICITY USE:** 55 watts (excludes lights)  
**AIRFLOW EFFICIENCY:** 89 cubic feet per minute per watt

#### CTC INSTALLATION

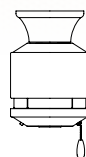

Fan



Dry  
Indoor only

\* Light kit sold separately.

# PERFORMANCE

This 52" Performance fan includes 5 reversible blades and a limited lifetime warranty. A powerful AirPro motor features a 3-speed, triple-capacitor control that can also be reversed to provide year-round comfort. The Performance fan will also accept a universal light kit.

### FEATURES

- Limited lifetime warranty
- 45° Canopy
- Close-to-ceiling installation
- SureConnect® System
- Compatible with universal light kits
- Three speed pull-chain switch
- Add a P2630-30 or P2630-95 wall control or P2662-01 hand-held remote control

### SIZE

52" dia., 15-1/4" ht.  
CTC 10-1/2" ht.  
80" lead wires

### FINISHES

- Brushed Nickel - 09
- Antique Bronze - 20
- White - 30



**P2503-09**  
Brushed Nickel shown with Cherry blades



**P2503-09**  
Brushed Nickel shown with Natural Cherry blades



Natural Cherry    Cherry



**P2503-20**  
shown with P2650-20TWB light kit\*  
Antique Bronze shown with Medium Cherry blades



Classic Walnut    Medium Cherry



**P2503-30W**  
White shown with White blades



White    White

#### ENERGY INFORMATION AT HIGH SPEED

**AIRFLOW:** 5,143 cubic feet per minute  
**ELECTRICITY USE:** 69 watts (excludes lights)  
**AIRFLOW EFFICIENCY:** 84 cubic feet per minute per watt

#### CTC INSTALLATION

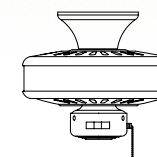

Fan



Dry  
Indoor only

\* Light kit sold separately.

## SIGNATURE PLUS

The Signature Plus ceiling fan is a 54" 5-blade fan with reversible blades that offers great performance and value. This contemporary-styled fan features a powerful, 3-speed motor that can be reversed to provide year-round comfort. Includes an innovative canopy system that can be installed on vaulted ceilings up to 12:12 pitch. The Signature Plus fan will also accept a universal light kit.

## FEATURES

- 30-year limited warranty
- 45° Canopy
- Downrod mount only
- Compatible with universal light kits
- Three speed pull-chain switch
- Add a P2630-30 or P2630-95 wall control or P2662-01 hand-held remote control

## SIZE

54" dia., 15" ht.  
80" lead wires

## FINISHES

- Brushed Nickel - 09
- Antique Bronze - 20
- White - 30



**P2530-20**  
Antique Bronze shown  
with Medium Cherry blades



**P2530-09**  
Brushed Nickel shown  
with Silver blades



Natural Cherry Silver



**P2530-20**  
Shown with P2645-01WB light kit\*  
Antique Bronze shown with Classic Walnut blades



Classic Walnut Medium Cherry



**P2530-30W**  
White shown  
with White blades



White White

## ENERGY INFORMATION AT HIGH SPEED

**AIRFLOW:** 4,716 cubic feet per minute  
**ELECTRICITY USE:** 65 watts (excludes lights)  
**AIRFLOW EFFICIENCY:** 73 cubic feet per minute per watt



Fan

Dry  
Indoor only

\* Light kit sold separately.

## 52" BUILDER FAN

This 52" AirPro fan features 5 reversible blades. A powerful AirPro motor contains a 3-speed, and a triple-capacitor that can also be reversed to provide year-round comfort. Includes an innovative canopy system that can be installed on vaulted ceilings up to 12:12 pitch. The Builder fan will also accept a universal light kit.

## FEATURES

- 30-year limited warranty
- 45° Canopy
- Close-to-ceiling installation
- SureConnect® System
- Compatible with universal light kits
- Add a P2630 wall control or P2662-01 hand-held remote control

## SIZE

52" dia., 13-1/2" ht.  
CTC 9-3/4" ht.  
80" lead wires

## FINISHES

- Brushed Nickel - 09
- Polished Chrome - 15
- Antique Bronze - 20
- White - 30
- Graphite - 143



**P2501-15**  
Polished Chrome shown  
with Driftwood blades



Black Driftwood



**P2501-09**  
Shown with P2602-09WB light kit\*  
Brushed Nickel shown with Cherry blades



Natural Cherry Cherry



**P2501-20**  
Antique Bronze shown  
with Medium Cherry blades



Medium Cherry Classic Walnut



**P2501-30**  
White shown  
with Washed Oak blades



White Washed Oak



**P2501-30W**  
White shown  
with White blades



White White



**P2501-143**  
Graphite shown  
with Black blades



Graphite Black

## ENERGY INFORMATION AT HIGH SPEED

**AIRFLOW:** 4,210 cubic feet per minute  
**ELECTRICITY USE:** 65 watts (excludes lights)  
**AIRFLOW EFFICIENCY:** 76 cubic feet per minute per watt

## CTC INSTALLATION

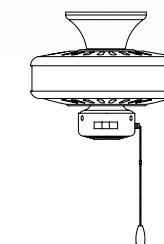

Fan

Dry  
Indoor only

\* Light kit sold separately.

# 52" BUILDER WITH LIGHT KIT

NEW

A 52" two-light, five-blade fan with reversible blades and a beautifully crafted etched white glass bowl. Powerful AirPro motor features 3-speed, triple-capacitor control that can also be reversed to provide year-round comfort. Two medium-based LED lamps are included, offering energy efficiency and cost savings benefits for the home, while a dual mount canopy accommodates flat or sloped ceilings.

## FEATURES

- 30-year limited warranty
- Dual Mount (flat or sloped ceiling-30°)
- MDF/Plywood hybrid blades
- Etched white glass shade
- Three speed pull-chain switch
- Add a P2630-30 or P2630-95 wall control or P2662-01 hand-held remote control

## SIZE

52" dia., 17-5/8" ht.  
80" lead wires

## FINISHES

- Brushed Nickel - 09
- White - 30
- Architectural Bronze - 129



**P2599-09**  
Brushed Nickel shown  
with Cherry blades



**P2599-09**  
Brushed Nickel shown  
with Natural Cherry blades



Natural Cherry Cherry



**P2599-30**  
White shown  
with White blades



White White



**P2599-129**  
Architectural Bronze shown  
with Classic Walnut blades



Classic Walnut Medium Cherry

## ENERGY INFORMATION AT HIGH SPEED

**AIRFLOW:** 4,474 cubic feet per minute  
**ELECTRICITY USE:** 65 watts (excludes lights)  
**AIRFLOW EFFICIENCY:** 68 cubic feet per minute per watt

## LAMPING INFORMATION

Two medium base, 3000K, LED lamps included.  
800 lumens/lamp, 80 CRI, non-dimmable.



Fan

Dry  
Indoor only

PROGRESSLIGHTING.COM

# 42" BUILDER FAN

42" AirPro ceiling fan with five reversible blades, an integral pull chain and a 15-year limited warranty. A powerful AirPro motor features a 3-speed, triple-capacitor control that can also be reversed to provide year-round comfort. The Builder fan will also accept a universal light kit.

## FEATURES

- 15-year limited warranty
- 23" Canopy
- Close-to-ceiling installation
- SureConnect® System
- Compatible with universal light kits
- Three speed pull-chain switch
- Add a P2630 wall control or P2662-01 hand-held remote control

## SIZE

42" dia., 12-3/8" ht.  
CTC 8-5/16" ht.  
72" lead wires

## FINISHES

- Brushed Nickel - 09
- Antique Bronze - 20
- White - 30



**P2500-09**  
Brushed Nickel shown  
with Natural Cherry blades



**P2500-09**  
Shown with P2600-09WB light kit\*  
Brushed Nickel shown with Cherry blades



Natural Cherry Cherry



**P2500-20**  
Antique Bronze shown  
with Classic Walnut blades



Classic Walnut Medium Cherry



**P2500-30**  
White shown  
with White Blades



White Washed Oak

## ENERGY INFORMATION AT HIGH SPEED

**AIRFLOW:** 3,053 cubic feet per minute  
**ELECTRICITY USE:** 46 watts (excludes lights)  
**AIRFLOW EFFICIENCY:** 67 cubic feet per minute per watt

\* Light kit sold separately.

PROGRESSLIGHTING.COM

## CTC INSTALLATION

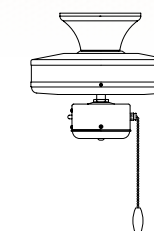

Fan

Dry  
Indoor only



P250008-009 shown with Silver blades

Enhance your home with the perfect mix of form and function with the 32" four-blade Drift fan. Ideal for smaller spaces, such as closets, mudrooms and laundry rooms, Drift features a powerful motor and a steep pitch to circulate a lot of air within a smaller space. Available in Brushed Nickel, Antique Bronze and White finishes, Drift offers a dual mount system and a three-speed pull chain fan switch.

**FEATURES**

- Limited lifetime warranty
- Dual Mount (flat or sloped ceiling-30°)
- Close-to-ceiling installation
- Reversible MDF blades
- Compatible with universal light kits
- Three speed pull-chain switch
- Add a P2630-30 or P2630-95 wall control or P2662-01 hand-held remote control

**SIZE**

32" dia., 14-3/8" ht.  
80" lead wires

**FINISHES**

- Brushed Nickel - 009
- White - 030
- Architectural Bronze - 129

PROGRESSLIGHTING.COM

**P250008-009**

Brushed Nickel shown  
with Silver blades



Driftwood



Silver

**P250008-030**

White shown  
with Driftwood blades



White



Driftwood

**P250008-129**

Architectural Bronze shown  
with Classic Walnut blades



Medium Cherry



Classic Walnut

**ENERGY INFORMATION AT HIGH SPEED**

<b>AIRFLOW:</b>	2,518 cubic feet per minute
<b>ELECTRICITY USE:</b>	35 watts (excludes lights)
<b>AIRFLOW EFFICIENCY:</b>	71 cubic feet per minute per watt

PROGRESSLIGHTING.COM

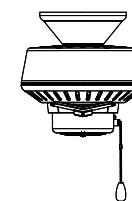
**CTC INSTALLATION**

Fan



Dry  
Indoor only

# BRADEN NEW



P2588-1290K shown with Classic Walnut blades

This Braden 56", three-blade, hugger-style ceiling fan features clean lines and a design that complements modern interiors. A shatterproof white opal glass shade contains an integrated 18W LED module, offering both form and function with energy and cost-savings benefits. Featuring a larger motor, Braden moves more air than a traditional hugger ceiling fan. A full function remote with batteries is included.

#### FEATURES

- Limited lifetime warranty
- Hugger low profile mounting
- Reversible plywood blades
- White opal glass shade
- Full function remote control with batteries is included
- Remote may be replaced with P2631-30 wall control

#### SIZE

56" dia., 9-7/8" ht.  
12" lead wires

#### FINISHES

- Brushed Nickel - 09
- Polished Chrome - 15
- Architectural Bronze - 129

PROGRESSLIGHTING.COM

#### P2588-0930K

Brushed Nickel shown  
with American Walnut blades



American Walnut



Silver



#### P2588-1530K

Polished Chrome shown  
with Black blades



American Walnut



Black



#### P2588-12930K

Architectural Bronze shown  
with Medium Cherry blades



Medium Cherry



Classic Walnut



#### ENERGY INFORMATION AT HIGH SPEED

<b>AIRFLOW:</b>	4,263 cubic feet per minute
<b>ELECTRICITY USE:</b>	55 watts (excludes lights)
<b>AIRFLOW EFFICIENCY:</b>	77 cubic feet per minute per watt

#### LAMPING INFORMATION

18w LED Module, 3000K, 90 CRI,  
1400 lumens, dimmable.

PROGRESSLIGHTING.COM



Canada



Fan



Light



Dry  
Indoor only



Full Function Remote Included  
Full-range dimming for light  
Three-speed fan operation  
Reverse direction control



# VOX FAN



P2572-2030K shown with American Walnut blades

Five-blade 52" Vox hugger-style ceiling fan features an LED light source, offering both form and function with energy and cost-savings benefits. A white opal glass shade contains a 17W dimmable, 3000K LED module. A full function remote control is included. The fan mounts close to the ceiling and is available in popular Brushed Nickel, Antique Bronze and White finishes.

#### FEATURES

- Limited Lifetime Warranty
- Hugger low profile mounting
- Non-reversible plywood blades
- White opal glass shade
- Full function remote control with batteries is included
- Remote may be replaced with P2631-30 wall control

#### SIZE

52" dia., 11-5/8" ht.

#### FINISHES

- Brushed Nickel - 09
- Antique Bronze - 20
- White - 30

PROGRESSLIGHTING.COM

#### P2572-0930K

Brushed Nickel shown  
with Medium Cherry blades



Medium Cherry



#### P2572-2030K

Antique Bronze shown  
with American Walnut blades



American Walnut



#### P2572-3030K

White shown  
with White blades



White



#### ENERGY INFORMATION AT HIGH SPEED

<b>AIRFLOW:</b>	4,276 cubic feet per minute
<b>ELECTRICITY USE:</b>	62 watts (excludes lights)
<b>AIRFLOW EFFICIENCY:</b>	68 cubic feet per minute per watt

#### LAMPING INFORMATION

17w LED Module, 3000K, 90 CRI, 1400 lumens, dimmable.

PROGRESSLIGHTING.COM



Full Function Remote Included  
Full-range dimming for light  
Three-speed fan operation  
Reverse direction control



Fan



Light



Dry  
Indoor only

## 52" HUGGER FAN

52" indoor hugger fan with five reversible blades in a Brushed Nickel or White finish. With an 11-degree pitch, the hugger-style housing permits fan installation on lower ceilings. A powerful AirPro motor features a 3-speed, triple-capacitor control that can also be reversed to provide year-round comfort. Includes a 15-year warranty and is compatible with universal light kits.

### FEATURES

- 15-year limited warranty
- Compatible with universal light kits
- Cannot be used with remote
- Add a P2630-30 or P2630-95 wall control

### SIZE

52" dia., 8-1/8" ht.

### FINISHES

- Brushed Nickel - 09
- White - 30



**P2525-09**  
Brushed Nickel shown  
with Cherry Blades



**P2525-09**  
shown with P2610-09WB light kit\*  
Brushed Nickel shown with Cherry Blades



Natural Cherry Cherry

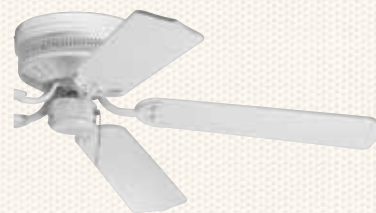

**P2525-30**  
White shown  
with White Blades



White White

### ENERGY INFORMATION AT HIGH SPEED

<b>AIRFLOW:</b>	3,229 cubic feet per minute
<b>ELECTRICITY USE:</b>	56 watts (excludes lights)
<b>AIRFLOW EFFICIENCY:</b>	58 cubic feet per minute per watt



Fan



Dry  
Indoor only

\* Light kit sold separately.

## 42" HUGGER FAN

42" indoor hugger fan with four reversible blades in a Brushed Nickel or White finish. With an 11-degree pitch, the hugger fan's powerful AirPro motor features a 3-speed, triple-capacitor control that can also be reversed to provide year-round comfort. Includes a 15-year warranty and is compatible with universal light kits.

### FEATURES

- 15-year limited warranty
- Hugger style housing, four blades
- Compatible with universal light kits
- Cannot be used with remote
- Add a P2630-30 or P2630-95 wall control

### SIZE

42" dia., 8-5/16" ht.

### FINISHES

- Brushed Nickel - 09
- White - 30

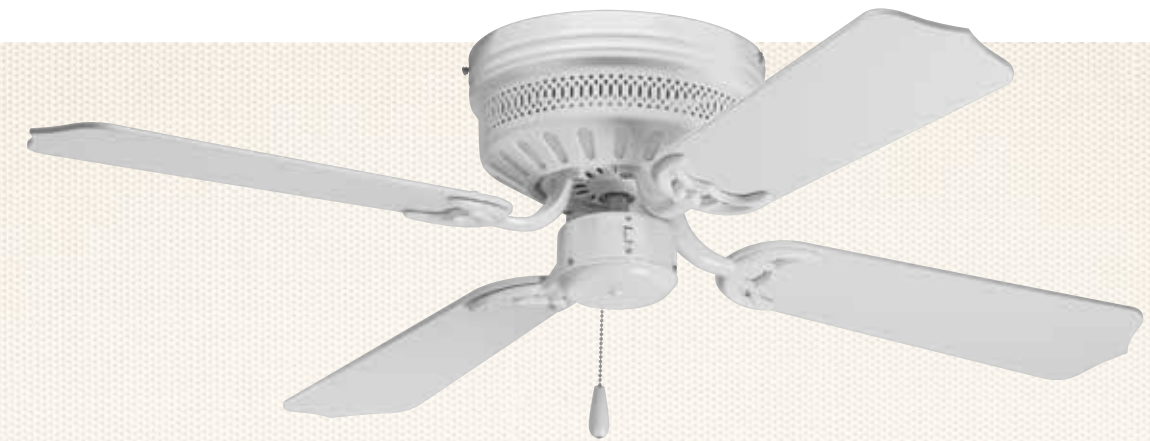

**P2524-30**  
White shown  
with White Blades



**P2524-09**  
shown with P2602-09WB light kit\*  
Brushed Nickel shown with Natural Cherry Blades



Natural Cherry Cherry

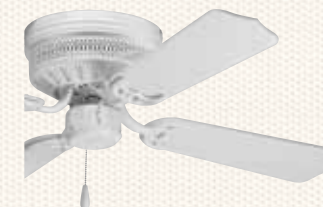

**P2524-30**  
White shown  
with White Blades



White White

### ENERGY INFORMATION AT HIGH SPEED

<b>AIRFLOW:</b>	2,056 cubic feet per minute
<b>ELECTRICITY USE:</b>	46 watts (excludes lights)
<b>AIRFLOW EFFICIENCY:</b>	45 cubic feet per minute per watt



Fan



Dry  
Indoor only

\* Light kit sold separately.

# Outdoor Ceiling Fans

## *ENHANCE OUTDOOR LIVING AREAS WITH CEILING FANS AND LIGHT KIT OPTIONS*

Whether enjoying a book on a cozy front porch setting or hosting a special event underneath an elegant pergola, ceiling fans provide a great way to create a comfortable and welcoming outdoor environment while enhancing aesthetic appeal. Extend outdoor activities after the sun goes down by selecting fans with light kit options.



**MARKET TREND** - It's important to know how to choose the correct outdoor ceiling fan. There are two options. Those that are UL listed for damp locations and those UL listed for wet locations. When installing a ceiling fan outdoors, building safety codes require that an outdoor ceiling fan with the correct UL approval rating is used.

*Featuring Montague Ceiling Fan*

# EDISTO NEW



P2596-8030K shown with Charcoal blades

The Edisto 54" two-blade outdoor ceiling fan combines a sleek, contemporary style with high-quality performance. A wire frame supports canvas wrapped blades that feature UV inhibitors to protect the fabric from fading in the sunlight. Three fan speeds and a reversible switch keep individuals cool in the summer and warm in the winter. A white opal glass shade contains an 18W LED module light kit, offering energy efficient and cost savings benefits.

#### FEATURES

- Limited lifetime warranty
- Dual Mount (flat or sloped ceiling-18.5°)
- Canvas wrapped blades
- White opal glass shade
- Remote control with batteries is included
- Damp Location Rated
- Remote may be replaced with P2630-30 or P2630-95 wall control

#### SIZE

54" dia., 14-7/8" ht.  
80" lead wires

#### FINISHES

- Forged Black - 80
- Antique Nickel - 81
- Architectural Bronze - 129

PROGRESSLIGHTING.COM

#### P2596-8030K

Forged Black shown  
with Charcoal Canvas blades



Charcoal



#### P2596-8130K

Antique Nickel shown  
with Oatmeal Canvas blades



Oatmeal



#### P2596-12930K

Architectural Bronze shown  
with Mushroom Canvas blades



Mushroom



#### ENERGY INFORMATION AT HIGH SPEED

<b>AIRFLOW:</b>	4,371 cubic feet per minute
<b>ELECTRICITY USE:</b>	65 watts (excludes lights)
<b>AIRFLOW EFFICIENCY:</b>	67 cubic feet per minute per watt

#### LAMPING INFORMATION

18w LED Module, 3000K, 90 CRI,  
1400 lumens, dimmable.

PROGRESSLIGHTING.COM



Three-Speed Remote Included  
Full-range dimming for light  
Three-speed fan operation



Fan



Light



Damp  
Indoor/Outdoor

# WHIRL



P2574-8130K shown with Driftwood blades

Refresh your indoor or covered outdoor living spaces with the crisp, clean style of the 60" Whirl fan. The stylish design comes in Antique Nickel, Antique Bronze and Forged Black finish options. The five-blade fan features an all weather damp location rating to accommodate a variety of settings throughout the home.

#### FEATURES

- Limited Lifetime Warranty
- Dual Mount (flat or sloped ceiling-18.5°)
- ABS all weather blades
- White Frosted Glass Shade
- Three speed pull-chain switch (fan)
- On/off pull-chain switch (light)
- Damp Location Rated
- Add a P2630-30 or P2630-95 wall control or P2662-01 hand-held remote control

#### SIZE

60" dia., 15-7/8" ht.  
80" lead wires

#### FINISHES

- Antique Bronze - 20
- Forged Black - 80
- Antique Nickel - 81

PROGRESSLIGHTING.COM

#### P2574-2030K

Antique Bronze shown  
with Walnut blades



Walnut



#### P2574-8030K

Forged Black shown  
with Toasted Oak blades



Toasted Oak



#### P2574-8130K

Antique Nickel shown  
with Driftwood blades



Driftwood



#### ENERGY INFORMATION AT HIGH SPEED

<b>AIRFLOW:</b>	6,549 cubic feet per minute
<b>ELECTRICITY USE:</b>	70 watts (excludes lights)
<b>AIRFLOW EFFICIENCY:</b>	94 cubic feet per minute per watt

#### LAMPING INFORMATION

18w LED Module, 3000K, 90 CRI,  
1400 lumens, dimmable.

PROGRESSLIGHTING.COM



Fan



Light



Damp  
Indoor/Outdoor

# SMYRNA



P2576-8030K shown with Toasted Oak blades

This 52" Smyrna ceiling fan features an LED light source, offering both form and function with energy and cost-savings benefits. The light kit contains a clear hammered glass shade and contains a 17W dimmable 3000K LED module. Includes a wall control switch for fan speed and light operation.

#### FEATURES

- Limited Lifetime Warranty
- Dual Mount (flat or sloped ceiling-30°)
- ABS all weather blades
- Clear Hammered glass shade
- Wet Location Rated

#### SIZE

52" dia., 19-1/2" ht.  
80" lead wires

#### FINISHES

- Antique Bronze - 20
- Forged Black - 80

PROGRESSLIGHTING.COM

#### P2576-2030K

Antique Bronze shown  
with Walnut blades



Walnut



#### P2576-8030K

Forged Black shown  
with Toasted Oak blades



Toasted Oak



#### ENERGY INFORMATION AT HIGH SPEED

<b>AIRFLOW:</b>	4,585 cubic feet per minute
<b>ELECTRICITY USE:</b>	58 watts (excludes lights)
<b>AIRFLOW EFFICIENCY:</b>	79 cubic feet per minute per watt

#### LAMPING INFORMATION

17w LED Module, 3000K, 90 CRI,  
1400 lumens, dimmable.

PROGRESSLIGHTING.COM



Wall Control Included  
Full-range dimming for light  
Four-speed fan operation  
Includes switch plate cover



Fan



Light



Wet  
Indoor/Outdoor

# MONTAGUE

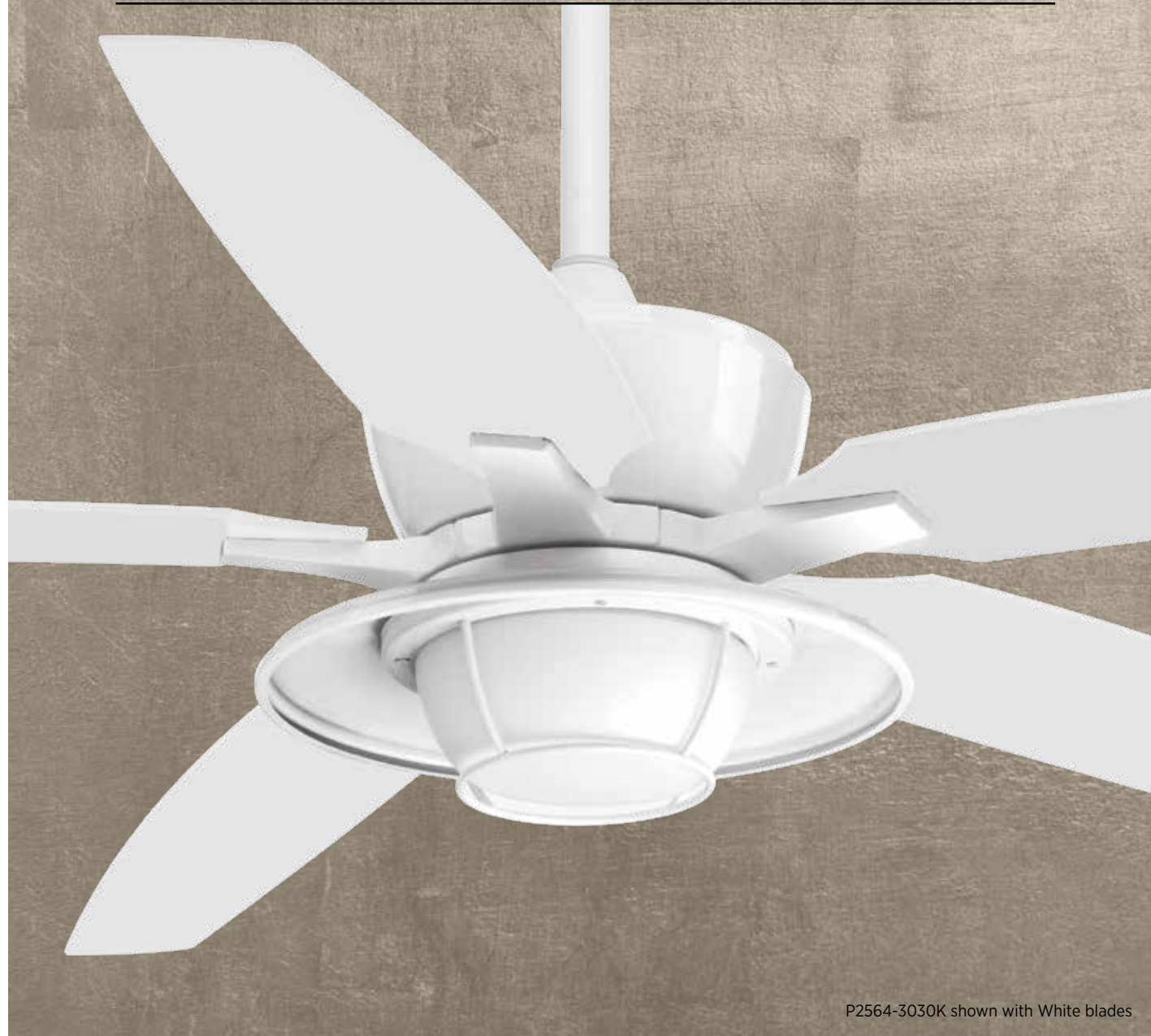

P2564-3030K shown with White blades

This five-blade 60" Montague ceiling fan features an all weather wet location rating to accommodate a variety of interior and exterior locations. The white opal glass shade contains a 18W dimmable, 3000K LED module, offering both form and function with energy and cost-savings benefits. A full function remote control is included.

#### FEATURES

- Limited Lifetime Warranty
- White Opal Glass Shade
- Dual Mount (flat or sloped ceiling-18.5°)
- ABS all weather blades
- Remote control with batteries is included
- Wet Location Rated
- Remote may be replaced with P2630-30 or P2630-95 wall control

#### SIZE

60" dia., 17-5/8" ht.  
80" lead wires

#### FINISHES

- Antique Bronze - 20
- White - 30
- Forged Black - 80

PROGRESSLIGHTING.COM

#### P2564-2030K

Antique Bronze shown  
with Walnut blades



Walnut



#### P2564-3030K

White shown  
with White blades



White



#### P2564-8030K

Forged Black shown  
with Toasted Oak blades



Toasted Oak



#### ENERGY INFORMATION AT HIGH SPEED

<b>AIRFLOW:</b>	6,693 cubic feet per minute
<b>ELECTRICITY USE:</b>	75 watts (excludes lights)
<b>AIRFLOW EFFICIENCY:</b>	89 cubic feet per minute per watt

#### LAMPING INFORMATION

18w LED Module, 3000K, 90 CRI,  
1400 lumens, dimmable.

PROGRESSLIGHTING.COM



Full Function Remote Included  
Full-range dimming for light  
Three-speed fan operation  
Reverse direction control



Fan



Light



Wet  
Indoor/Outdoor

# LAKEHURST



P2562-20 shown with Walnut blades

This five-blade 60" Lakehurst ceiling fan features an all weather wet location rating (ABS) to accommodate a variety of interior and exterior locations. The Lakehurst fan will accept a universal outdoor rated light kit. Features a dual mount system and a three-speed pull chain fan switch.

**FEATURES**

- Limited Lifetime Warranty
- Dual Mount (flat or sloped ceiling-18.5°)
- ABS all weather blades
- Compatible with universal light kits
- 3 Speed pull chain switch
- Wet Location Rated
- Add a P2630-30 or P2630-95 wall control or P2662-01 hand-held remote control

**SIZE**

60" dia., 15-3/4" ht.  
80" lead wires

**FINISHES**

- Antique Bronze - 20
- White - 30
- Forged Black - 80

PROGRESSLIGHTING.COM

**P2562-20**  
Antique Bronze shown with Walnut blades



Walnut



**P2562-30**  
White shown with White blades



White



**P2562-80**  
Forged Black shown with Toasted Oak blades



Toasted Oak



ENERGY INFORMATION AT HIGH SPEED

<b>AIRFLOW:</b>	6,440 cubic feet per minute
<b>ELECTRICITY USE:</b>	71 watts (excludes lights)
<b>AIRFLOW EFFICIENCY:</b>	91 cubic feet per minute per watt

PROGRESSLIGHTING.COM



Fan



Wet  
Indoor/Outdoor



# 54" PATIO FAN



P2533-20 shown with Toasted Oak blades

54" five-blade patio fan with Toasted Oak blades and an Antique Bronze finish. This AirPro Indoor/Outdoor ceiling fan offers great performance and value with a powerful, 3-speed motor that can be reversed to provide year-round comfort. Includes an innovative canopy system that can be installed on vaulted ceilings up to 12:12 pitch. The Patio fan will also accept a universal outdoor rated light kit.

#### FEATURES

- 30-year limited warranty
- 45° Canopy
- SureConnect® System
- ABS all-weather blades
- Compatible with universal light kits
- Wet location listed
- Add a P2630-30 or P2630-95 wall control or P2662-01 hand-held remote control

#### SIZE

54" dia., 18-1/4" ht.  
CTC 12-3/16" ht.  
80" lead wires

#### FINISHES

- Antique Bronze - 20

PROGRESSLIGHTING.COM

#### P2533-20

shown with P2636-20WB light kit\*  
Antique Bronze shown  
with Toasted Oak blades



Toasted Oak



#### ENERGY INFORMATION AT HIGH SPEED

**AIRFLOW:** 4,986 cubic feet per minute  
**ELECTRICITY USE:** 65 watts (excludes lights)  
**AIRFLOW EFFICIENCY:** 88 cubic feet per minute per watt

\* Light kit sold separately.

PROGRESSLIGHTING.COM

#### CTC INSTALLATION

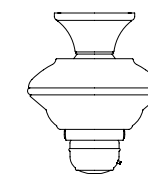

Fan



Wet  
Indoor/Outdoor

# 52" PATIO FAN

52" Indoor/Outdoor patio fan from AirPro. This fan includes five blades made with ABS all-weather material and a 15-year limited warranty. A powerful AirPro motor features a 3-speed, triple-capacitor control that can also be reversed to provide year-round comfort. A quick install canopy securely holds the fan for wiring during installation. The Patio fan will also accept a universal outdoor rated light kit.

### FEATURES

- 15-year limited warranty
- Dual Mount (flat or sloped ceiling-23°)
- Close-to-ceiling installation
- SureConnect® System
- Quick-Install canopy
- ABS all-weather blades
- Compatible with universal light kits
- Three speed pull-chain switch
- Wet location listed
- Add a P2630-30 or P2630-95 wall control or P2662-01 hand-held remote control

### SIZE

52" dia., 12-34" ht.  
CTC 9-11/16" ht.  
72" lead wires

### FINISHES

- Antique Bronze - 20
- White - 30
- Forged Black - 80
- Galvanized -141



**P2502-141**  
Galvanized shown with Silver blades

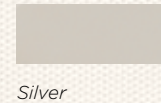

**P2502-20**  
Antique Bronze shown with Oak blades

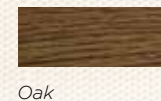

**P2502-30**  
White shown with White blades

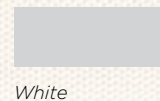

**P2502-80**  
shown with P2601-80WB light kit\*  
Forged Black shown with Toasted Oak blades



# DECORATIVE PATIO FAN

52" Indoor/Outdoor five-blade fan with all-weather ABS blades in palm-style design and a rich Antique Bronze finish. Three-speed motor offers great performance and value that can be reversed to provide year-round comfort. Antique Brass pull chain with medium oak fob complements the Washed Walnut blades. The Patio fan will also accept a universal outdoor rated light kit.

### FEATURES

- 15-year limited warranty
- 45° Canopy
- Close-to-ceiling installation
- SureConnect® System
- ABS all-weather blades
- Compatible with universal light kits
- Damp location listed
- Add a P2630-30 or P2630-95 wall control or P2662-01 hand-held remote control

### SIZE

52" dia., 17-3/8" ht.  
CTC 12-3/16" ht.  
80" lead wires

### FINISHES

- Antique Bronze - 20



**P2526-20**  
Antique Bronze shown with Washed Walnut blades



**P2526-20**  
shown with P2636-20WB light kit\*  
Antique Bronze shown with Washed Walnut blades



### ENERGY INFORMATION AT HIGH SPEED

**AIRFLOW:** 4,245 cubic feet per minute  
**ELECTRICITY USE:** 53 watts (excludes lights)  
**AIRFLOW EFFICIENCY:** 80 cubic feet per minute per watt

### CTC INSTALLATION

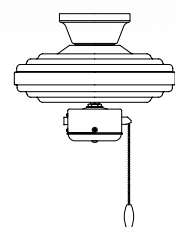

\* Light kit sold separately.

### ENERGY INFORMATION AT HIGH SPEED

**AIRFLOW:** 1,919 cubic feet per minute  
**ELECTRICITY USE:** 68 watts (excludes lights)  
**AIRFLOW EFFICIENCY:** 28 cubic feet per minute per watt

### CTC INSTALLATION

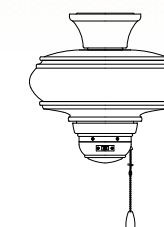

\* Light kit sold separately.

Universal-style with quick-connect wiring.

**SCHOOLHOUSE**

**P2601-20WB** Antique Bronze  
**P2601-30WB** White  
**P2601-80WB** Forged Black  
**P2601-141WB** Galvanized with opal glass.  
 8-1/2" dia., 7" ht.  
 One medium base, 3000K, LED lamp included.  
 800 lumens/lamp, 90 CRI. (dimnable)

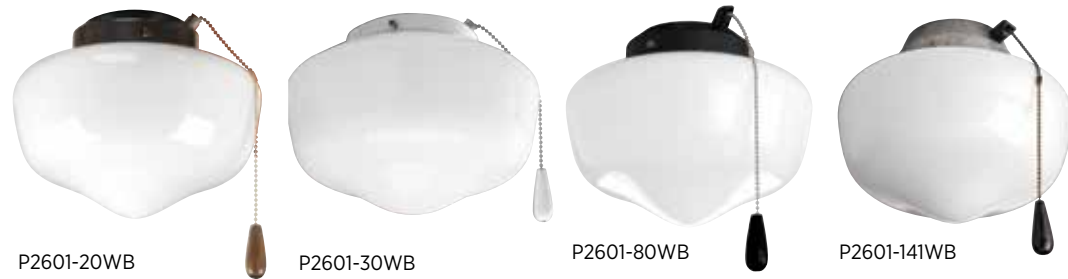

**Wet**  
Indoor/Outdoor

**LOW PROFILE**

**P2611-20WB** Antique Bronze  
**P2611-30WB** White  
**P2611-80WB** Forged Black with opal glass.  
 10-1/2" dia., 4-1/2" ht.  
 Two medium base, 3000K, LED lamp included.  
 800 lumens/lamp, 90 CRI. (dimnable)



**Wet**  
Indoor/Outdoor

**ASHMORE**

**P2636-20WB** Antique Bronze with frosted seeded glass.  
 11" dia., 8-1/4" ht.  
 Two medium base, 3000K, LED lamp included.  
 800 lumens/lamp, 90 CRI. (dimnable)



**Damp**  
Indoor/Outdoor

Universal-style light kit with quick-connect wiring.

**P2645-77WB** Forged Bronze with tea-stained glass.

**P2645-01WB** with etched glass.  
 Included Finials:  
 -09 Brushed Nickel  
 -20 Antique Bronze  
 -80 Forged Black  
 12" dia., 5-3/4" ht.  
 Two medium base, 3000K, LED lamps included.  
 800 lumens/lamp, 90 CRI. Indoor use only. (dimnable)



**Dry**  
Indoor only

**GATHER, BRAVO & JOY**

Universal-style light kit with quick-connect wiring.

**P2650-20TWB** Antique Bronze with tea-stained glass.

**P2650-01WB** with etched glass.  
 Included Finials:  
 -09 Brushed Nickel  
 -20 Antique Bronze  
 11" dia., 5-1/2" ht.  
 Two medium base, 3000K, LED lamps included.  
 800 lumens/lamp, 90 CRI. Indoor use only. (dimnable)



**Dry**  
Indoor only

**MADISON**

Universal-style with quick-connect wiring.

**P2623-09WB** Brushed Nickel  
**P2623-20WB** Antique Bronze with etched glass.  
 19" dia., 8" ht.  
 Three medium base, 3000K, LED lamps included.  
 800 lumens/lamp, 90 CRI. Indoor use only. (dimnable)



**Dry**  
Indoor only

# UNIVERSAL BOWL

Universal-style with quick-connect wiring.

**P2612-20TWB** Antique Bronze with tea-stained glass.

**P2612-01WB**

with alabaster glass.

Included Finials:

-09 Brushed Nickel

-20 Antique Bronze

-30 White

-15 Polished Chrome

-143 Graphite

10-3/4" dia., 5-1/2" ht.

Two medium base, 3000K,

LED lamps included.

800 lumens/lamp, 90 CRI.

Indoor use only. (dimnable)



JA8



Dry  
Indoor only



## WISTEN

Universal-style light kit with quick-connect wiring.

**P2649-01WB**

with etched glass.

Included Finials:

-09 Brushed Nickel

-20 Antique Bronze

11" dia., 6-1/4" ht.

Two medium base, 3000K,

LED lamps included.

800 lumens/lamp, 90 CRI.

Indoor use only. (dimnable)



JA8



Dry  
Indoor only



## NORTH PARK

Universal-style with quick-connect wiring.

**P2654-01WB**

with etched glass.

Included Finials:

-09 Brushed Nickel

-20 Antique Bronze

12-1/2" sq., 6-1/4" ht.

Two medium base, 3000K,

LED lamps included.

800 lumens/lamp, 90 CRI.

Indoor use only. (dimnable)



JA8



Dry  
Indoor only



# LED LIGHT KITS

Universal-style light kits with quick connect wiring.

**P2659-09** Brushed Nickel

**P2659-20** Antique Bronze

**P2659-30** White

with etched white glass.

12-1/4" dia., 4" ht.

One 16w, 3000K

LED module included.

1265 source lumens,

960 delivered lumens,

90 CRI. Indoor use only.

(dimnable)



JA8



Dry  
Indoor only



**P2660-01**

with etched alabaster glass.

Included Finials:

-09 Brushed Nickel

-20 Antique Bronze

-30 White

11-1/4" dia., 5-3/8" ht.

One 16w, 3000K

LED module included.

1241 source lumens,

1150 delivered lumens,

90 CRI. Indoor use only.

(dimnable)



JA8



Dry  
Indoor only



## TRINITY

Universal-style with quick-connect wiring.

**P2628-01WB**

with etched glass.

Included Finials:

-09 Brushed Nickel

-20 Antique Bronze

-30 White

-77 Forged Bronze

13-3/8" dia., 6-3/8" ht.

Two medium base, 3000K,

LED lamps included.

800 lumens/lamp, 90 CRI.

Indoor use only. (dimnable)



JA8



Dry  
Indoor only



# 102 FOUR LIGHT UNIVERSAL

LIGHT KITS

Universal-style with quick-connect wiring.

- P2643-09WB** Brushed Nickel
  - P2643-20WB** Antique Bronze
  - P2643-30WB** White with alabaster glass.
  - P2643-20TWB** Antique Bronze with tea stained alabaster glass.
- 13-5/8" dia., 7-3/4" ht.  
Four medium base, 3000K, LED lamps included.  
800 lumens/lamp, 90 CRI.  
Indoor use only. (dimnable)



P2643-09WB



P2643-20WB



P2643-30WB



P2643-20TWB

# THREE LIGHT UNIVERSAL

Universal-style with quick-connect wiring.

- P2642-09WB** Brushed Nickel
  - P2642-30WB** White with alabaster glass.
- 13-5/8" dia., 7-3/4" ht.  
Three medium base, 3000K, LED lamps included.  
800 lumens/lamp, 90 CRI.  
Indoor use only. (dimnable)



P2642-09WB

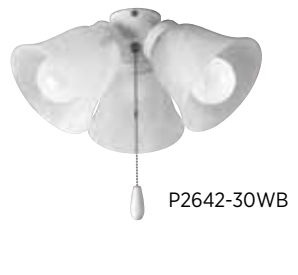

P2642-30WB

# LOW PROFILE

Universal-style with quick-connect wiring.

- P2602-09WB** Brushed Nickel
  - P2602-15WB** Polished Chrome
  - P2602-20WB** Antique Bronze
  - P2602-30WB** White
  - P2602-143WB** Graphite with white opal glass.
- 10-1/2" dia., 4-1/2" ht.  
Two medium base, 3000K, LED lamps included.  
800 lumens/lamp, 90 CRI.  
Indoor use only. (dimnable)



P2602-09WB



P2602-15WB



P2602-20WB



P2602-30WB



P2602-143WB

# 103 FOUR LIGHT ALABASTER

103

LIGHT KITS

Spring clip glass attachment. For use with P2500, P2501, P2502, P2524 and P2525.

- P2610-09WB** Brushed Nickel
  - P2610-15WB** Polished Chrome
  - P2610-20WB** Antique Bronze
  - P2610-30WB** White
  - P2610-143WB** Graphite with alabaster glass.
- 14-1/2" dia., 6-1/4" ht.  
Four medium base, 3000K, LED lamps included.  
800 lumens/lamp, 90 CRI.  
Indoor use only. (dimnable)



P2610-09WB



P2610-15WB



P2610-20WB



P2610-30WB



P2610-143WB

# THREE LIGHT ALABASTER

Spring clip glass attachment. For use with P2500, P2501, P2502, P2524 and P2525.

- P2600-09WB** Brushed Nickel
  - P2600-20WB** Antique Bronze
  - P2600-30WB** White with alabaster glass.
- 15" dia., 6-5/8" ht.  
Three medium base, 3000K, LED lamps included.  
800 lumens/lamp, 90 CRI.  
Indoor use only. (dimnable)



P2600-09WB



P2600-20WB



P2600-30WB

# SCHOOLHOUSE

Universal-style with quick-connect wiring.

- P2644-09WB** Brushed Nickel
  - P2644-30WB** White with white opal glass.
- 8-1/2" dia., 6-1/2" ht.  
One medium base, 3000K, LED lamp included.  
800 lumens/lamp, 90 CRI.  
Indoor use only. (dimnable)



P2644-09WB



P2644-30WB

3/4" diameter; approximately 1" outside diameter.

CEILING HT.	9'-10'	10'-11'	11'-12'	12'-14'	13'-15'	14'-16'	15'-17'
DOWNROD L.	12"	18"	24"	36"	48"	60"	72"
● Brushed Nickel	P2603-09	P2604-09	P2605-09	P2606-09	P2607-09	P2608-09	P2609-09
● Polished Chrome	P2603-15	P2604-15	P2605-15	P2606-15	P2607-15	P2608-15	P2609-15
● Antique Bronze	P2603-20	P2604-20	P2605-20	P2606-20	P2607-20	P2608-20	P2609-20
● White	P2603-30	P2604-30	P2605-30	P2606-30	P2607-30	P2608-30	P2609-30
● Forged Bronze	P2603-77	P2604-77	P2605-77	P2606-77	P2607-77	P2608-77	P2609-77
● Forged Black	P2603-80	P2604-80	P2605-80	P2606-80	P2607-80	P2608-80	P2609-80
● Antique Nickel	P2603-81	P2604-81	P2605-81	P2606-81	P2607-81	P2608-81	P2609-81
● Galvanized	P2603-141	P2604-141	P2605-141	P2606-141	P2607-141	-	-
● Graphite	P2603-143	P2604-143	P2605-143	P2606-143	P2607-143	P2608-143	P2609-143

### DOWNROD SELECTION GUIDE

Allow at least 7 feet (84 in.) from the floor to the bottom of the fan, with 8 or 9 feet being the ideal above-floor placement.

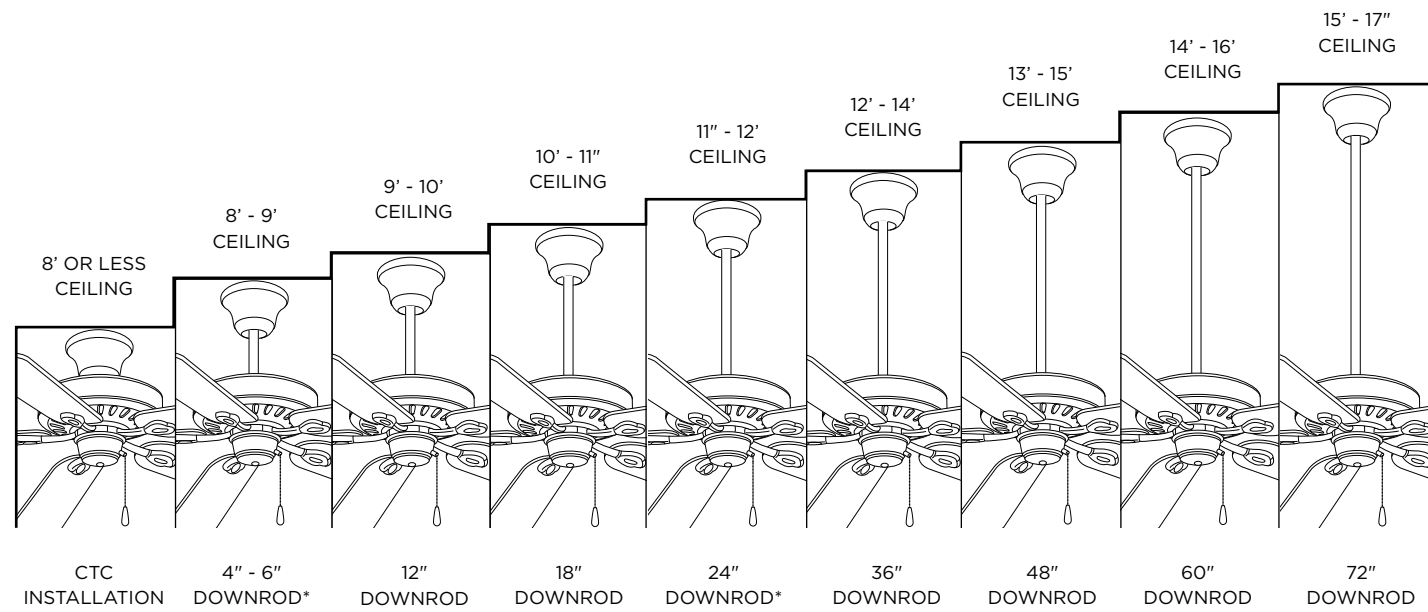

\* Average length downrod, included with each fan.



**P2662-01** Fan/Light Remote  
Universal remote operates three fan speeds and full-range dimming light control. Includes canopy receiver and wall storage bracket. Will work with LED lamps and modules. Featuring four "dip" switches and 16 code options to avoid the chance of interference from other remotes.



**P2663-01** Fan/Light Remote  
Universal remote with two, four or eight-hour timer option, operates three fan speeds and full-range dimming light control. Includes canopy receiver and wall storage bracket. Will work with LED lamps and modules. Featuring four "dip" switches and 16 code options to avoid the chance of interference from other remotes.



**P2618-01** Fan/Light Remote  
Provides fan speed and light control from convenient hand-held remote. Compatible with non-dimmable compact fluorescent lamps. For single pole applications. Receiver fits in fan canopy.



**P2661-01** Universal Fan/Light Remote  
Provides fan speed and full range light dimming control from a convenient hand held remote control. For single pole applications. Includes a wall plate for added storage convenience. Receiver fits in the fan canopy.



**P2665-30** White  
Universal remote includes a wall mount transmitter, ideal for multi-family applications, that operates three fan speeds and full-range dimming light control. Includes canopy receiver and wall storage bracket. Will work with LED lamps and modules. Featuring four "dip" switches and 16 code options to avoid the chance of interference from other remotes.



**P2631-30** White  
Full-function wall control transmitter (receiver sold with ceiling fan). Use with, or in place of, hand-held remote included with fans that have a downlight. Includes switch plate cover.



**P2630-95** Ivory  
Four-speed fan wall control with full-range light dimmer. Fits single-gang wall box; requires two circuits. Includes switch plate cover. Not for use with multiple fans.



**P2630-30** White  
Four-speed fan wall control with full-range light dimmer. Fits single-gang wall box; requires two circuits. Includes switch plate cover. Not for use with multiple fans.



**P2613-95** Ivory  
Four-speed fan wall control. Includes switch plate cover. Not for use with multiple fans.



**P2613-30** White  
Four-speed fan wall control. Includes switch plate cover. Not for use with multiple fans.



American Walnut



Antique Bronze



Architectural Bronze



Black



Brushed Nickel



Charcoal



Cherry



Classic Walnut



Dark Cherry



Dark Teak



Dark Walnut



Distressed Walnut



Driftwood

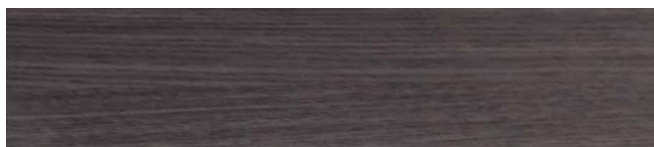

Graphite

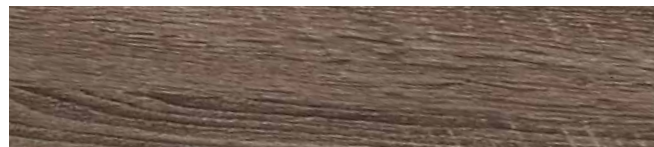

Gray Weathered Wood



Medium Cherry



Medium Oak



Mushroom



Natural Cherry



Oak

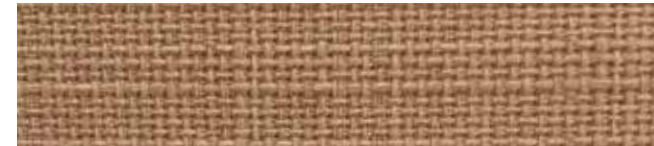

Oatmeal



Silver

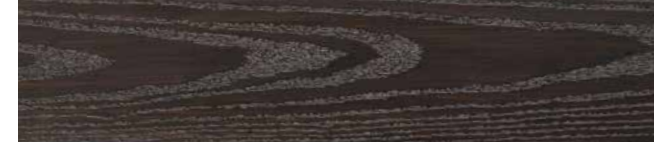

Toasted Oak



Walnut



Washed Oak



Washed Walnut

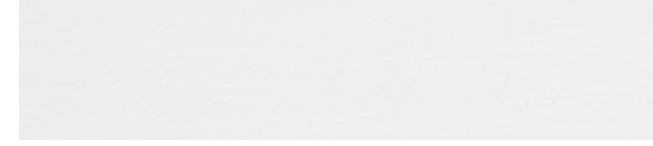

White



White Barnwood



White Washed



All finish representations are part of Progress Lighting's comprehensive design and specification program. Through extensive research, these finishes have been carefully chosen to complement all Progress Lighting products, including our extensive range of materials and accessory options.

These finish representations match actual finish colors as accurately as possible, and while every effort has been made to render colors accurately, they may vary slightly from the actual product, especially hand-painted finishes due to the nature of hand craftsmanship.

P2500-09 . . . . .73  
P2500-20 . . . . .73  
P2500-30 . . . . .73  
P250000-081 . . . . .15  
P250000-129 . . . . .15  
P250002-009-30 . . . . .17  
P250002-108-30 . . . . .17  
P250002-143-30 . . . . .17  
P250004-129 . . . . .33  
P250004-141 . . . . .33  
P250004-143 . . . . .33  
P250008-009 . . . . .75  
P250008-030 . . . . .75  
P250008-129 . . . . .75  
P250016-009 . . . . .67  
P250016-030 . . . . .67  
P250016-129 . . . . .67  
P2501-09 . . . . .71  
P2501-15 . . . . .71  
P2501-20 . . . . .71  
P2501-30 . . . . .71  
P2501-30W . . . . .71  
P2501-143 . . . . .71  
P2502-20 . . . . .96  
P2502-30 . . . . .96  
P2502-80 . . . . .96  
P2502-141 . . . . .96  
P2503-09 . . . . .69  
P2503-20 . . . . .69  
P2503-30W . . . . .69  
P2514-09 . . . . .66  
P2521-09 . . . . .63  
P2521-09CH . . . . .63  
P2521-09WA . . . . .63  
P2521-20 . . . . .63  
P2521-77 . . . . .63  
P2521-80 . . . . .62  
P2521-81 . . . . .63  
P2524-09 . . . . .81  
P2524-30 . . . . .81  
P2525-09 . . . . .80  
P2525-30 . . . . .80  
P2526-20 . . . . .97  
P2530-09 . . . . .70  
P2530-20 . . . . .70  
P2530-30W . . . . .70  
P2531-09 . . . . .68  
P2531-20 . . . . .68  
P2533-20 . . . . .95  
P2538-09 . . . . .65  
P2538-20 . . . . .65  
P2539-0930K . . . . .61  
P2539-2030K . . . . .61  
P2539-3030K . . . . .61  
P2540-2030K . . . . .43  
P2540-3030K . . . . .43  
P2540-14330K . . . . .43  
P2542-0930K . . . . .41  
P2542-2030K . . . . .41  
P2542-3030K . . . . .41  
P2544-0930K . . . . .45  
P2544-1530K . . . . .45

P2544-2030K . . . . .45  
P2546-09 . . . . .21  
P2546-20 . . . . .21  
P2548-0930K . . . . .53  
P2548-2030K . . . . .53  
P2548-3030K . . . . .53  
P2550-0930K . . . . .25  
P2550-2030K . . . . .25  
P2550-3030K . . . . .25  
P2552-09 . . . . .59  
P2552-20 . . . . .59  
P2552-80 . . . . .59  
P2554-0930K . . . . .27  
P2554-1530K . . . . .27  
P2554-2030K . . . . .27  
P2556-0930K . . . . .65  
P2556-2030K . . . . .64  
P2556-3030K . . . . .65  
P2558-0930K . . . . .57  
P2558-2030K . . . . .57  
P2560-09 . . . . .23  
P2560-20 . . . . .23  
P2562-20 . . . . .93  
P2562-30 . . . . .93  
P2562-80 . . . . .93  
P2564-2030K . . . . .91  
P2564-3030K . . . . .91  
P2564-8030K . . . . .91  
P2568-0930K . . . . .51  
P2568-1530K . . . . .51  
P2568-2030K . . . . .51  
P2570-09 . . . . .29  
P2570-15 . . . . .29  
P2570-143 . . . . .29  
P2572-0930K . . . . .79  
P2572-2030K . . . . .79  
P2572-3030K . . . . .79  
P2574-2030K . . . . .87  
P2574-8030K . . . . .87  
P2574-8130K . . . . .87  
P2576-2030K . . . . .89  
P2576-8030K . . . . .89  
P2578-1530K . . . . .55  
P2578-2030K . . . . .55  
P2582-0930K . . . . .49  
P2582-2030K . . . . .49  
P2582-14330K . . . . .49  
P2584-71 . . . . .37  
P2584-81 . . . . .37  
P2586-7130K . . . . .35  
P2586-8130K . . . . .35  
P2588-0930K . . . . .77  
P2588-1530K . . . . .77  
P2588-12930K . . . . .77  
P2590-28 . . . . .39  
P2590-80 . . . . .39  
P2590-129 . . . . .39  
P2592-0930K . . . . .31  
P2592-3130K . . . . .31  
P2592-12930K . . . . .31  
P2594-0930K . . . . .19  
P2594-12930K . . . . .19

P2596-8030K . . . . .85  
P2596-8130K . . . . .85  
P2596-12930K . . . . .85  
P2598-09 . . . . .47  
P2598-143 . . . . .47  
P2599-09 . . . . .72  
P2599-30 . . . . .72  
P2599-129 . . . . .72  
P2600-09WB . . . . .103  
P2600-20WB . . . . .103  
P2600-30WB . . . . .103  
P2601-20WB . . . . .98  
P2601-30WB . . . . .98  
P2601-80WB . . . . .98  
P2601-141WB . . . . .98  
P2602-09WB . . . . .102  
P2602-15WB . . . . .102  
P2602-20WB . . . . .102  
P2602-30WB . . . . .102  
P2602-143WB . . . . .102  
P2603-09 . . . . .104  
P2603-15 . . . . .104  
P2603-20 . . . . .104  
P2603-30 . . . . .104  
P2603-77 . . . . .104  
P2603-80 . . . . .104  
P2603-81 . . . . .104  
P2603-141 . . . . .104  
P2603-143 . . . . .104  
P2604-09 . . . . .104  
P2604-15 . . . . .104  
P2604-20 . . . . .104  
P2604-30 . . . . .104  
P2604-77 . . . . .104  
P2604-80 . . . . .104  
P2604-81 . . . . .104  
P2604-141 . . . . .104  
P2604-143 . . . . .104  
P2605-09 . . . . .104  
P2605-15 . . . . .104  
P2605-20 . . . . .104  
P2605-30 . . . . .104  
P2605-77 . . . . .104  
P2605-80 . . . . .104  
P2605-81 . . . . .104  
P2605-141 . . . . .104  
P2605-143 . . . . .104  
P2606-09 . . . . .104  
P2606-15 . . . . .104  
P2606-20 . . . . .104  
P2606-30 . . . . .104  
P2606-77 . . . . .104  
P2606-80 . . . . .104  
P2606-81 . . . . .104  
P2606-81 . . . . .104  
P2606-141 . . . . .104  
P2606-143 . . . . .104  
P2607-09 . . . . .104  
P2607-15 . . . . .104  
P2607-20 . . . . .104  
P2607-30 . . . . .104  
P2607-77 . . . . .104  
P2607-80 . . . . .104

P2607-81 . . . . .104  
P2607-141 . . . . .104  
P2607-143 . . . . .104  
P2608-09 . . . . .104  
P2608-15 . . . . .104  
P2608-20 . . . . .104  
P2608-30 . . . . .104  
P2608-77 . . . . .104  
P2608-80 . . . . .104  
P2608-81 . . . . .104  
P2608-143 . . . . .104  
P2609-09 . . . . .104  
P2609-15 . . . . .104  
P2609-20 . . . . .104  
P2609-30 . . . . .104  
P2609-77 . . . . .104  
P2609-80 . . . . .104  
P2609-81 . . . . .104  
P2609-143 . . . . .104  
P2610-09WB . . . . .103  
P2610-15WB . . . . .103  
P2610-20WB . . . . .103  
P2610-30WB . . . . .103  
P2610-143WB . . . . .103  
P2611-20WB . . . . .98  
P2611-30WB . . . . .98  
P2611-80WB . . . . .98  
P2612-01WB . . . . .100  
P2612-20TWB . . . . .100  
P2613-30 . . . . .105  
P2613-95 . . . . .105  
P2618-01 . . . . .105  
P2623-09WB . . . . .99  
P2623-20WB . . . . .99  
P2628-01WB . . . . .101  
P2630-30 . . . . .105  
P2630-95 . . . . .105  
P2631-30 . . . . .105  
P2636-20WB . . . . .98  
P2642-09WB . . . . .102  
P2642-30WB . . . . .102  
P2643-09WB . . . . .102  
P2643-20WB . . . . .102  
P2643-20TWB . . . . .102  
P2643-30WB . . . . .102  
P2644-09WB . . . . .103  
P2644-30WB . . . . .103  
P2645-01WB . . . . .99  
P2645-77WB . . . . .99  
P2649-01WB . . . . .100  
P2650-01WB . . . . .99  
P2650-20TWB . . . . .99  
P2654-01WB . . . . .100  
P2659-09 . . . . .101  
P2659-20 . . . . .101  
P2659-30 . . . . .101  
P2660-01 . . . . .101  
P2661-01 . . . . .105  
P2662-01 . . . . .105  
P2663-01 . . . . .105  
P2665-30 . . . . .105

## ICON INDEX



Products referencing this logo meet the energy efficiency requirements for ceiling fans or light fixtures set forth in ENERGY STAR® product specifications. Please refer to [www.energystar.gov](http://www.energystar.gov) for specific product qualifications and list of certified products.



The products with this logo have passed the cUL requirements and are available for sale in Canada. These products include the additional safety features needed to comply with the regulations in Canada. Items with the icon are listed with NRCAN.



Any fixture that has an **Integrated LED** that has been tested and listed in the California Appliance Database. Check for certified bulbs (lamps) or fixtures by searching the MAEDBS database. Go to: [cacertappliances.energy.ca.gov](http://cacertappliances.energy.ca.gov)



Products comply with the California Appliance Efficiency Regulations. Certified products are listed on the appliance efficiency database found at [www.appliances.energy.ca.gov](http://www.appliances.energy.ca.gov).



**Dry location, indoor only** fans should only be used indoors. Even if an outdoor area or screened-in porch is covered, the motor and the blades can be affected when exposed to humidity.



**Damp location, indoor/outdoor** fans may be used indoors or outdoors under covered porches and should not be subjected to water spray or rain.



**Wet location, indoor/outdoor** fans are designed for damp or wet locations. These products feature elements, such as moisture-resistant motors and all weather blades. Wet location fans may also be used indoors.

Every effort has been made to ensure the accuracy of information in this catalog. Progress Lighting reserves the right to make product changes from time to time, without prior notification, which may change the information provided in this catalog. Errors brought to our attention will be corrected in subsequent issues.

UL, CSA, or ETL Listed or Classified unless otherwise noted. Bulbs (lamps) not included with fixtures unless specified. Specifications subject to change without notice.

Metal finishes not specified as “solid” have quality plated or painted finishes.

Finish representations are high resolution digital reproductions, and, while every effort has been made to render colors accurately, they may vary slightly from the actual product, especially hand-painted finishes, due to the nature of hand craftsmanship.



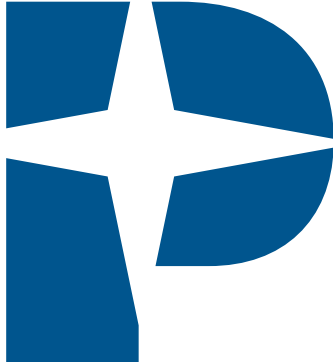

---

With over a century of lighting technology, leadership and engineering, Progress Lighting offers the highest quality in residential and commercial lighting solutions. We understand what it takes to be a leader: offering products that deliver aesthetic appeal, stellar performance, easy installation and value.

FOR MORE INFORMATION,  
CONTACT US.

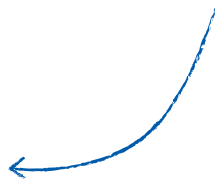

**PROGRESS LIGHTING**

701 Millennium Boulevard  
Greenville, SC 29607

[progresslighting.com](http://progresslighting.com)

