



the Power to Create Better Light™



# LED RETROFIT LIGHTING SOLUTIONS



[www.espentech.com](http://www.espentech.com)

# INTRODUCES NEW PRODUCTS!

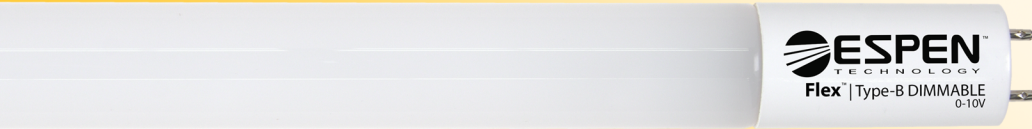

**0-10V DIMMING PG. 11**

**COMPACT LAMPS PG. 6**



**360° SIGN LAMPS PG. 17**



**HID REPLACEMENTS LAMPS PG. 18**



**UNIFLEX™ PG. 20**

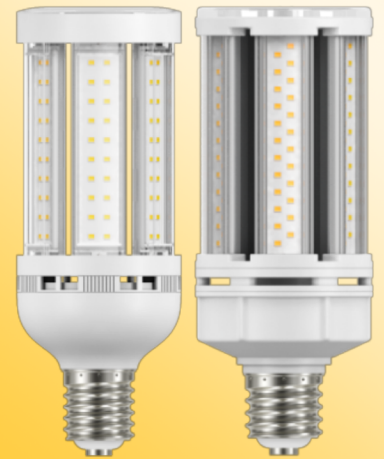

**CENTER BASKET TROFFER RETROFIT KIT PG. 36**



**STEP-DOWN TRANSFORMERS PG. 44**

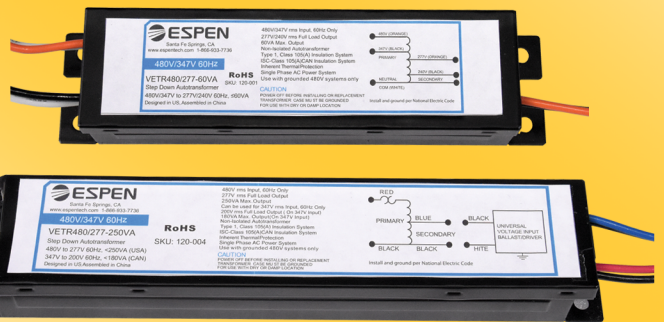

**HIGH BAY SENSORS PG. 45**



**0-10V DIMMERS PG. 46**

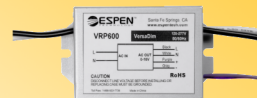

**versaDim™ RF WIRELESS CONTROL SYSTEM PG. 47**





Espen Technology is dedicated to delivering sustainable and environmentally progressive lighting solutions. As a manufacturer and designer of high efficiency lighting products, Espen continually strives to improve the efficiency of lighting technology. Our products reflect an emphasis on sustainability, quality, and reliability. Our product development is driven by a simple commitment: to improve people's lives and build a better future for generations to come.

Our Espen products are complemented by an industry-leading warranty policy. The goal is to offer our customers and end-users an invaluable asset: peace of mind. With an emphasis on quality and a focus on efficiency, Espen Technology's engineers have developed a whole line of LED drivers, lamps, modules, retrofit kits, emergency solutions and control systems that are worthy of the latest LED luminaries. High efficiency, advanced thermal management, increased life, and versatility in form create the ultimate LED systems for today's most advanced LED lighting. Stringent component qualification and quality control guarantee a long life and increased overall system longevity.



Not all products are qualified on the DLC QPL. To view our DLC qualified products, please consult the DLC Qualified Products List at [www.designlights.org/qpl](http://www.designlights.org/qpl)



# TABLE OF CONTENTS

## Type A, B and A+B Series

### RetroFlex™



TYPE - A

#### TYPE A, PLUG & PLAY, BALLAST COMPATIBLE LED LAMPS

- 1.....Introduction
- 2.....T5 Linear Lamps
- 3.....T8 Linear Lamps
- 5.....Slimline and HO Lamps
- 6.....Compact Lamps
- 7.....Drivers and Ballasts for Type A Lamps
- 8.....Emergency Ballasts for Type A Lamps

### Flex™



TYPE - B

#### TYPE B LED LAMPS

- 9.....Introduction
- 10.....T5 Lamps
- 11-12....T8 Lamps
- 13-14....Slimline and HO Lamps
- 15.....PLL Lamps
- 16.....Compact Lamps
- 17.....360° Sign Lamps
- 18.....HID Replacement Lamps
- 19.....Emergency Inverters for Type B Lamps

### UniFlex™



TYPE A+B

#### TYPE A + B LED LAMPS

- 20.....Introduction
- 21.....T8 Linear Lamps
- 22.....Ubent Lamps

# TABLE OF CONTENTS

## Type-C Series, Retrofit & Emergency Solutions



### TYPE C LED LAMPS WITH EXTERNAL DRIVER

- 24.....Introduction
- 25.....T5 Linear Lamps
- 26.....T8 Linear Lamps
- 27-28.....LED Drivers for Type C Lamps
- 29.....Emergency Drivers for Type C Lamps

TYPE - C

### VersaKIT™



### LED RETROFIT KITS

- 30.....Introduction
- 31.....Linear Module Retrofit Kits
- 34.....Panel Retrofit Kit
- 35-36.....Center Basket Troffer Retrofit Kit
- 37.....Channel Retrofit Kit
- 38.....LED Strip Retrofit Kit

RETROFIT KITS

### SENTINEL®



### EMERGENCY SOLUTIONS

- 39.....Introduction
- 40.....Emergency Back Up Kits
- 41.....Type-A Emergency Ballasts
- 42.....Type-B Emergency Inverters
- 43.....LED Emergency Drivers

Emergency Solutions

### CONTROLS



- 44.....Step-Down Transformers
- 45.....High Bay Sensors
- 46.....0-10V Dimmers
- 47.....versaDim RF Wireless Control System

CONTROLS

# RetroFlex™

PLUG & PLAY, BALLAST COMPATIBLE LED LAMPS | Type A

TYPE - A



### linearLED

Med, Bi-Pin, Single-Pin, Double-Recess Pin  
Long Life, Convenient Wiring



### RetroFlex led driver

Dedicated Driver, Instant Start  
Constant Current, 0-10V Dimming



### emergency ballast

Maintenance-Free, Long Life  
Hi-Temperature Ni-Cad Battery

# RetroFlex™

LED Solutions  
Plug and Play



Safety Coated, Shatter-Resistant Lamps



### ballast replacement

High Efficiency, Slim Profile, Instant Start,  
Program Start

## ABOUT ESPEN RETROFLEX LED LAMPS

Espen Retroflex LED lamps lead the industry with ballast compatible, plug & play technology. These high-performance lamps don't require any alteration to the fixture. The upgrade to LED technology is as simple as replacing the old fluorescent lamps with new Retroflex lamps. This saves you up to 50% of system power while maintaining or increasing illumination levels. These lamps work directly off your existing electronic ballasts, within your fixtures, and come in a range of shapes and sizes.

\*Please visit [www.espentech.com](http://www.espentech.com) for compatibility list.

# RetroFlex™ ArmorCoat™

Plug & Play Ballast Compatible LED T5 Lamps: Shatterproof



## FEATURES AND BENEFITS

- LED Replacement for T5 Fluorescent Lamps
- **ArmorCoat™** Shatterproof Coating (-AC)
- Works with fluorescent electronic ballast (**Programmed Start, Dimming**)
- Quick and Convenient Installation
- Utilizes Existing Shunted or Non-Shunted Tombstones
- Instant on, No delay
- Convenient and quick installation
- Frosted to Prevent Glare
- Suitable for Damp Locations
- Integrated Thermal Fuse Protection
- ETL Sanitation Listed - conforms to NSF/ANSI 2
- Maintains the original UL Certification of the Fixture
- Compatible with Controls and Sensors
- Rated for Use in Food Prep Areas and Refrigerated Food Displays
- -20° F to 130° F Ambient Operating Temp
- Glass Tube for Optimal Light Output and Heat Diffusion
- 5 Year Warranty
- 240° Wide Beam Angle
- Dimmable<sup>1</sup>



TYPE - A

Model No.	Replaces	Length (in)	Lamp Power (W)	System Power <sup>3</sup> (W)	Lumens <sup>3</sup> (lm)	Lamp Efficacy (lm/W)	Input Voltage <sup>4</sup> (V)	CCT (K)	CRI	Life (h)
<b>Linear T5 High Efficiency (HE)</b>										
L48T5HE/830/13G-EB-AC	F28T5HE	48	13	16 <sup>3</sup>	1800 <sup>3</sup>	139	120 - 277, 347 <sup>4</sup>	3000 <sup>5</sup>	83+	50000
L48T5HE/835/13G-EB-AC	F28T5HE	48	13	16 <sup>3</sup>	1800 <sup>3</sup>	139	120 - 277, 347 <sup>4</sup>	3500	83+	50000
L48T5HE/840/13G-EB-AC	F28T5HE	48	13	16 <sup>3</sup>	1800 <sup>3</sup>	139	120 - 277, 347 <sup>4</sup>	4000	83+	50000
L48T5HE/850/13G-EB-AC	F28T5HE	48	13	16 <sup>3</sup>	1800 <sup>3</sup>	139	120 - 277, 347 <sup>4</sup>	5000	83+	50000
<b>Linear T5 High Output (HO)</b>										
L24T5HO/830/9G-EB-AC	F24T5HO	24	91	2 <sup>3</sup>	960 <sup>3</sup>	107	120 - 277, 347 <sup>4</sup>	3000 <sup>5</sup>	83+	50000
L24T5HO/835/9G-EB-AC	F24T5HO	24	91	2 <sup>3</sup>	960 <sup>3</sup>	107	120 - 277, 347 <sup>4</sup>	3500	83+	50000
L24T5HO/840/9G-EB-AC	F24T5HO	24	91	2 <sup>3</sup>	960 <sup>3</sup>	107	120 - 277, 347 <sup>4</sup>	4000	83+	50000
L24T5HO/850/9G-EB-AC	F24T5HO	24	91	2 <sup>3</sup>	960 <sup>3</sup>	107	120 - 277, 347 <sup>4</sup>	5000	83+	50000
L36T5HO/830/18G-EB-AC <sup>2</sup>	F39T5HO	36	18	21 <sup>3</sup>	1680 <sup>3</sup>	93	120 - 277, 347 <sup>4</sup>	3000 <sup>5</sup>	83+	50000
L36T5HO/835/18G-EB-AC <sup>2</sup>	F39T5HO	36	18	21 <sup>3</sup>	1680 <sup>3</sup>	93	120 - 277, 347 <sup>4</sup>	3500	83+	50000
L36T5HO/840/18G-EB-AC <sup>2</sup>	F39T5HO	36	18	21 <sup>3</sup>	1680 <sup>3</sup>	93	120 - 277, 347 <sup>4</sup>	4000	83+	50000
L36T5HO/850/18G-EB-AC <sup>2</sup>	F39T5HO	36	18	21 <sup>3</sup>	1680 <sup>3</sup>	93	120 - 277, 347 <sup>4</sup>	5000	83+	50000
L48T5HO/830/24G-EB-AC	F54T5HO	48	24	27 <sup>3</sup>	3200 <sup>3</sup>	133	120 - 277, 347 <sup>4</sup>	3000 <sup>5</sup>	83+	50000
L48T5HO/835/24G-EB-AC	F54T5HO	48	24	27 <sup>3</sup>	3200 <sup>3</sup>	133	120 - 277, 347 <sup>4</sup>	3500	83+	50000
L48T5HO/840/24G-EB-AC	F54T5HO	48	24	27 <sup>3</sup>	3200 <sup>3</sup>	133	120 - 277, 347 <sup>4</sup>	4000	83+	50000
L48T5HO/850/24G-EB-AC	F54T5HO	48	24	27 <sup>3</sup>	3200 <sup>3</sup>	133	120 - 277, 347 <sup>4</sup>	5000	83+	50000
L48T5HO/830/24G-EB	F54T5HO	48	24	27 <sup>3</sup>	3200 <sup>3</sup>	133	120 - 277, 347 <sup>4</sup>	3000 <sup>5</sup>	83+	50000
L48T5HO/835/24G-EB	F54T5HO	48	24	27 <sup>3</sup>	3200 <sup>3</sup>	133	120 - 277, 347 <sup>4</sup>	3500	83+	50000
L48T5HO/840/24G-EB	F54T5HO	48	24	27 <sup>3</sup>	3200 <sup>3</sup>	133	120 - 277, 347 <sup>4</sup>	4000	83+	50000
L48T5HO/850/24G-EB	F54T5HO	48	24	27 <sup>3</sup>	3200 <sup>3</sup>	133	120 - 277, 347 <sup>4</sup>	5000	83+	50000

<sup>1</sup> Restrictions when dimming T5 High Output lamps. See [espentech.com](http://espentech.com) for ballast compatibility  
<sup>2</sup> Not DLC listed. DLC does not regulate 3 foot lamps.  
<sup>3</sup> System Power and Lumens based on normal ballast factor (1.0). Operation on low or high ballast factor will yield alternate specifications.  
<sup>4</sup> Input Voltage is dependent on ballast brand and model number. See [espentech.com](http://espentech.com) for ballast compatibility list.  
<sup>5</sup> 3000K CCT may be subject to lead times and availability.

# RetroFlex™

Plug & Play | Ballast Compatible LED T8 Lamp | Shatterproof

TYPE - A



## FEATURES AND BENEFITS

- LED Replacement for T8 Fluorescent Lamps
- **ArmorCoat™** Shatterproof Coating
- Works with fluorescent electronic ballast (**Instant Start, Programmed Start, Dimming**)<sup>1</sup>
- Quick and Convenient Installation
- Utilizes Existing Shunted or Non-Shunted Tombstones
- Instant on, No delay
- Convenient and quick installation
- Frosted to Prevent Glare
- Suitable for Damp Locations
- Integrated Thermal Fuse Protection
- ETL Sanitation Listed - conforms to NSF/ANSI 2
- Maintains the original UL Certification of the Fixture
- Compatible with Controls and Sensors
- Rated for Use in Food Prep Areas and Refrigerated Food Displays
- -20° F to 130° F Ambient Operating Temp
- Glass Tube for Optimal Light Output and Heat Diffusion
- 5 Year Warranty
- 325° Wide Beam Angle
- Dimmable<sup>1</sup>



Model No.	Replaces	Length (in)	Lamp Power (W)	System Power <sup>2</sup> (W)	Lumens <sup>2</sup> (lm)	Lamp Efficacy (lm/W)	Voltage <sup>3</sup> (V)	CCT (K)	CRI	Life (h)
<b>Linear T8</b>										
L48T8/830/12G-EB-AC	F32T8	48	12	14 <sup>2</sup>	1900 <sup>2</sup>	136	120 - 277, 347 <sup>3</sup>	3000 <sup>4</sup>	83+	50000
L48T8/835/12G-EB-AC	F32T8	48	12	14 <sup>2</sup>	1900 <sup>2</sup>	136	120 - 277, 347 <sup>3</sup>	3500	83+	50000
L48T8/840/12G-EB-AC	F32T8	48	12	14 <sup>2</sup>	1900 <sup>2</sup>	136	120 - 277, 347 <sup>3</sup>	4000	83+	50000
L48T8/850/12G-EB-AC	F32T8	48	12	14 <sup>2</sup>	1900 <sup>2</sup>	136	120 - 277, 347 <sup>3</sup>	5000	83+	50000
L48T8/830/15G-EB-AC	F32T8	48	15	19 <sup>2</sup>	2200 <sup>2</sup>	116	120 - 277, 347 <sup>3</sup>	3000 <sup>4</sup>	83+	50000
L48T8/835/15G-EB-AC	F32T8	48	15	19 <sup>2</sup>	2200 <sup>2</sup>	116	120 - 277, 347 <sup>3</sup>	3500	83+	50000
L48T8/840/15G-EB-AC	F32T8	48	15	19 <sup>2</sup>	2200 <sup>2</sup>	116	120 - 277, 347 <sup>3</sup>	4000	83+	50000
L48T8/850/15G-EB-AC	F32T8	48	15	19 <sup>2</sup>	2200 <sup>2</sup>	116	120 - 277, 347 <sup>3</sup>	5000	83+	50000

<sup>1</sup> See [espentech.com](http://espentech.com) for ballast compatibility list.  
<sup>2</sup> System Power and Lumens based on normal ballast factor (0.88). Operation on low or high ballast factor will yield alternate specifications.  
<sup>3</sup> Input Voltage is dependent on ballast brand and model number. See [espentech.com](http://espentech.com) for ballast compatibility list.  
<sup>4</sup> May be subject to lead times and availability.





# RetroFlex™

Glass Plug & Play | Ballast Compatible | LED T8 Lamps



## FEATURES AND BENEFITS

- No rewiring needed
- Works with fluorescent electronic ballast (**Instant Start, Programmed Start, Dimming**)<sup>1</sup>
- Long life / High CRI
- -20° F to 130° F Ambient Operating Temp
- Instant on, no delay
- Convenient and quick installation
- Utilizes existing instant start or rapid start sockets
- No Mercury, No UV
- Compatible with controls and sensors
- Works in cold temperature applications
- Glass tube for superior optical performance
- 325° Wide View Angle
- Dimmable
- 5 Year Warranty



TYPE - A

ORDER CODE	Replaces	Length (in)	Lamp Power (W)	System Power (W)	Lumens (lm)	Lamp Efficacy (lm/W)	Input Voltage (V)	CCT (K)	CRI	Life (h)
L24T8/830/8G-EB	F17T8 <sup>1</sup>	24	8	10 <sup>2</sup>	1100	110	120 - 277, 347 <sup>3</sup>	3000 <sup>4</sup>	83+	50000
L24T8/835/8G-EB	F17T8 <sup>1</sup>	24	8	10 <sup>2</sup>	1100	110	120 - 277, 347 <sup>3</sup>	3500	83+	50000
L24T8/840/8G-EB	F17T8 <sup>1</sup>	24	8	10 <sup>2</sup>	1100	110	120 - 277, 347 <sup>3</sup>	4000	83+	50000
L24T8/850/8G-EB	F17T8 <sup>1</sup>	24	8	10 <sup>2</sup>	1100	110	120 - 277, 347 <sup>3</sup>	5000	83+	50000
L36T8/830/10G-EB	F25T8 <sup>1</sup>	36	10	13 <sup>2</sup>	1600	160	120 - 277, 347 <sup>3</sup>	3000 <sup>4</sup>	83+	50000
L36T8/835/10G-EB	F25T8 <sup>1</sup>	36	10	13 <sup>2</sup>	1600	160	120 - 277, 347 <sup>3</sup>	3500	83+	50000
L36T8/840/10G-EB	F25T8 <sup>1</sup>	36	10	13 <sup>2</sup>	1600	160	120 - 277, 347 <sup>3</sup>	4000	83+	50000
L36T8/850/10G-EB	F25T8 <sup>1</sup>	36	10	13 <sup>2</sup>	1600	160	120 - 277, 347 <sup>3</sup>	5000	83+	50000

**Above Products: Transitioning to Type A + B Solutions, See page 21**

L48T8/830/10G-EB	F32T8 <sup>1</sup>	48	10	13 <sup>2</sup>	1600	160	120 - 277, 347 <sup>3</sup>	3000 <sup>4</sup>	83+	50000
L48T8/835/10G-EB	F32T8 <sup>1</sup>	48	10	13 <sup>2</sup>	1600	160	120 - 277, 347 <sup>3</sup>	3500	83+	50000
L48T8/840/10G-EB	F32T8 <sup>1</sup>	48	10	13 <sup>2</sup>	1600	160	120 - 277, 347 <sup>3</sup>	4000	83+	50000
L48T8/850/10G-EB	F32T8 <sup>1</sup>	48	10	13 <sup>2</sup>	1600	160	120 - 277, 347 <sup>3</sup>	5000	83+	50000
L48T8/830/12G-EB	F32T8 <sup>1</sup>	48	12	14 <sup>2</sup>	1800	150	120 - 277, 347 <sup>3</sup>	3000	83+	50000
L48T8/835/12G-EB	F32T8 <sup>1</sup>	48	12	14 <sup>2</sup>	1800	150	120 - 277, 347 <sup>3</sup>	3500	83+	50000
L48T8/840/12G-EB	F32T8 <sup>1</sup>	48	12	14 <sup>2</sup>	1800	150	120 - 277, 347 <sup>3</sup>	4000	83+	50000
L48T8/850/12G-EB	F32T8 <sup>1</sup>	48	12	14 <sup>2</sup>	1800	150	120 - 277, 347 <sup>3</sup>	5000	83+	50000
L48T8/830/14G-EB	F32T8 <sup>1</sup>	48	14	16 <sup>2</sup>	2100	143	120 - 277, 347 <sup>3</sup>	3000 <sup>4</sup>	83+	50000
L48T8/835/14G-EB	F32T8 <sup>1</sup>	48	14	16 <sup>2</sup>	2100	143	120 - 277, 347 <sup>3</sup>	3500	83+	50000
L48T8/840/14G-EB	F32T8 <sup>1</sup>	48	14	16 <sup>2</sup>	2100	143	120 - 277, 347 <sup>3</sup>	4000	83+	50000
L48T8/850/14G-EB	F32T8 <sup>1</sup>	48	14	16 <sup>2</sup>	2100	143	120 - 277, 347 <sup>3</sup>	5000	83+	50000

<sup>1</sup> See espentech.com for ballast compatibility list.  
<sup>2</sup> System Power and Lumens based on normal ballast factor (0.88). Operation on low or high ballast factor will yield alternate specifications.  
<sup>3</sup> Input Voltage is dependent on ballast brand and model number. See espentech.com for ballast compatibility list.  
<sup>4</sup> 3000K CCT may be subject to lead times and availability.

# RetroFlex™

Plug & Play Ballast Compatible LED T8 Lamps | Slimline

TYPE - A



Anti-Rotation Bracket



## FEATURES AND BENEFITS

- LED Replacement for T8 & T12 Fluorescent Lamps
- **ArmorCoat™** Shatterproof Coating
- Works with fluorescent electronic ballast (**Instant Start, Programmed Start, Dimming**)
- Quick and Convenient Installation
- Utilizes Existing Shunted or Non-Shunted Tombstones
- Instant on, No delay
- Convenient and quick installation
- Frosted to Prevent Glare
- Suitable for Damp Locations
- Integrated Thermal Fuse Protection
- Maintains the original UL Certification of the Fixture
- Compatible with Controls and Sensors
- Rated for Use in Food Prep Areas and Refrigerated Food Displays
- 5 Year Warranty
- 325° Wide Beam Angle
- Dimmable
- -20° F to 130° F Ambient Operating Temp
- Glass Tube for Optimal Light Output and Heat Diffusion
- **96" Lamps ONLY Compatible with ESPEN VE259MVHIP Ballasts**

Model No.	Replaces	Base Type	Length (in)	Lamp Power (W)	System Power <sup>2</sup> (W)	Lumens <sup>2</sup> (lm)	Lamp Efficacy (lm/W)	Input Voltage <sup>3</sup> (V)	CCT (K)	CRI	Life (h)
<b>Single Pin Linear T8</b>											
L96T8/830/24G-EB	F96T8, F96T12	FA8	96	24	27 <sup>1</sup>	3500 <sup>2</sup>	146	120 - 277, 347 <sup>3</sup>	3000 <sup>+</sup>	83+	50000
L96T8/835/24G-EB	F96T8, F96T12	FA8	96	24	27 <sup>1</sup>	3500 <sup>2</sup>	146	120 - 277, 347 <sup>3</sup>	3500	83+	50000
L96T8/840/24G-EB	F96T8, F96T12	FA8	96	24	27 <sup>1</sup>	3500 <sup>2</sup>	146	120 - 277, 347	4000	83+	50000
L96T8/850/24G-EB	F96T8, F96T12	FA8	96	24	27 <sup>1</sup>	3500 <sup>2</sup>	146	120 - 277, 347	5000	83+	50000

<sup>1</sup> System Power and Lumens based on normal ballast factor (0.88). Operation on low or high ballast factor will yield alternate specifications.  
<sup>2</sup> Input Voltage is dependent on ballast brand and model number. See [espentech.com](http://espentech.com) for ballast compatibility list.  
<sup>3</sup> 3000K and 3500K may be subject to lead times and availability.



# RetroFlex™

Plug & Play | Ballast Compatible | Compact LED Bulbs



## FEATURES AND BENEFITS

- Comply with UL 1993/UL18750
- Comply with FCC 47 PART 15 CLASS B
- Works with electronic ballast (instant start, rapid start and program start)
- No UV, No Mercury
- Quick Installation
- High Lumen
- Extended Life
- High Quality Color Rendering
- Five year Limited Warranty



Model No.	Replaces	Base Type	Length	Lamp Power (W)	System Power (W)	Lumens (lm)	Lamp Efficacy (lm/W)	Input Voltage (V)	CCT (K)	CRI	Life (h)
<b>CLQ Compact lamps</b>											
CLQ18WH/827-EB	26W	G24q	6.65	9	12	900	100	120 - 277 <sup>1</sup>	2700	82	50000
CLQ18WH/830-EB	26W	G24q	6.65	9	12	900	100	120 - 277 <sup>1</sup>	3000	82	50000
CLQ18WH/835-EB	26W	G24q	6.65	9	12	900	100	120 - 277 <sup>1</sup>	3500	82	50000
CLQ18WH/840-EB	26W	G24q	6.65	9	12	900	100	120 - 277 <sup>1</sup>	4000	82	50000
CLQ18WH/850-EB	26W	G24q	6.65	9	12	900	100	120 - 277 <sup>1</sup>	5000	82	50000
CLQ18WHV/827-EB	26W	G24q	4.68	9	12	900	100	120 - 277 <sup>1</sup>	2700	82	50000
CLQ18WHV/830-EB	26W	G24q	4.68	9	12	900	100	120 - 277 <sup>1</sup>	3000	82	50000
CLQ18WHV/835-EB	26W	G24q	4.68	9	12	900	100	120 - 277 <sup>1</sup>	3500	82	50000
CLQ18WHV/840-EB	26W	G24q	4.68	9	12	900	100	120 - 277 <sup>1</sup>	3000	82	50000
CLQ18WHV/850-EB	26W	G24q	4.68	9	12	900	100	120 - 277 <sup>1</sup>	3500	82	50000

TYPE - A



## FEATURES AND BENEFITS

- Comply with UL 1993/UL1598
- Comply with FCC 47 PART 15 CLASS B
- 18W/26W G24d magnetic ballast compatible
- No UV, No Mercury
- Quick Installation
- High Lumen
- Extended Life
- High Quality Color Rendering
- Five year Limited Warranty



Model No.	Replaces	Base Type	Length	Lamp Power (W)	System Power (W)	Lumens (lm)	Lamp Efficacy (lm/W)	Input Voltage (V)	CCT (K)	CRI	Life (h)
<b>CLD Compact lamps</b>											
CLD18WH/827-MB	26W	G24d	6.65	9	12	900	100	120 - 277 <sup>1</sup>	2700	82	50000
CLD18WH/830-MB	26W	G24d	6.65	9	12	900	100	120 - 277 <sup>1</sup>	3000	82	50000
CLD18WH/835-MB	26W	G24d	6.65	9	12	900	100	120 - 277 <sup>1</sup>	3500	82	50000
CLD18WH/840-MB	26W	G24d	6.65	9	12	900	100	120 - 277 <sup>1</sup>	4000	82	50000
CLD18WH/850-MB	26W	G24d	6.65	9	12	900	100	120 - 277 <sup>1</sup>	5000	82	50000
CLD18WHV/827-MB	26W	G24d	4.68	9	12	900	100	120 - 277 <sup>1</sup>	2700	82	50000
CLD18WHV/830-MB	26W	G24d	4.68	9	12	900	100	120 - 277 <sup>1</sup>	3000	82	50000
CLD18WHV/835-MB	26W	G24d	4.68	9	12	900	100	120 - 277 <sup>1</sup>	3500	82	50000
CLD18WHV/840-MB	26W	G24d	4.68	9	12	900	100	120 - 277 <sup>1</sup>	3000	82	50000
CLD18WHV/850-MB	26W	G24d	4.68	9	12	900	100	120 - 277 <sup>1</sup>	3500	82	50000

<sup>1</sup> Input Voltage is dependent on ballast brand and model number. See [espentech.com](http://espentech.com) for ballast compatibility list.

# RetroFlex™

LED Drivers & Ballasts for Type A Lamps

TYPE - A

## NON-DIMMABLE DRIVERS FEATURES AND BENEFITS

- Constant Current
- Universal Voltage (120-277V)
- 5 Year Warranty
- Energy Efficient Design
- Micro Case: Same mounting for T8 and T12 ballasts
- High Performance
- Model No.: VEL50BN-2C (2 LAMP)  
VEL100BN-4C (4 LAMP)
- 5 Year Limited Warranty



## DIMMABLE DRIVERS FEATURES AND BENEFITS

- Constant Current
- 0-10V Continuous Dimming: 10%-100%
- Universal Voltage (120-277V)
- Slim Profile
- 5 Year Warranty
- Model No.: VEL30BN-2C-10V (2 LAMP)  
VEL60BN-4C-10V (4 LAMP)



## ELECTRONIC BALLASTS FEATURES AND BENEFITS

- Full Ballast Line
- Slim Profile
- Lamp Auto Restrike
- High Efficiency
- Commercial Ballasts Backed by 5-year Warranty



Model No.	Type	Lamps	Voltage	Method
VE2P32MVHIPE	F17T8-F32T8	1 or 2	120-277V	Instant Start
VE4P32MVHIPE	F17T8-F32T8	3 or 4	120-277V	Instant Start
VE259MVHIP	F96T8	2	120-277V	Instant Start
VE254MVRHP	F54T5HO	2	120-277V	Program Start
VE454MVRHP	F54T5HO	4	120-277V	Program Start

SUGGESTED BALLAST REPLACEMENTS FOR RETROFLEX LED LAMPS.  
FOR MORE BALLAST OPTIONS PLEASE CHECK ESPEN WEBSITE WWW.ESPENTECH.COM

# RetroFlex™

## Type-A Emergency Ballasts for T5 and T8 Lamps

### FEATURES AND BENEFITS

TYPE - A



500 Lumens

#### VEM500DV-L - Emergency Ballast

- Dual Input Voltage (120/277V)
- Maintenance Free, Long Life
- High Temperature Ni-Cad Battery
- Durable, Heavy-Duty Steel Housing
- 1-lamp: 500 lumens
- 5 Year Warranty



700 Lumens

#### VEM700DV-L - Emergency Ballast

- Dual Input Voltage (120/277V)
- Maintenance Free, Long Life
- High Temperature Ni-Cad Battery
- Durable, Heavy-Duty Steel Housing
- 1-lamp: 700 lumens | 2-lamp: 700 lumens
- 5 Year Warranty



800 Lumens

#### VEM800DV-L - Emergency Ballast

- Dual Input Voltage (120/277V)
- Maintenance Free, Long Life
- High Temperature Ni-Cad Battery
- Durable, Heavy-Duty Steel Housing
- 1-lamp: 800 lumens
- Slim Design
- 5 Year Warranty

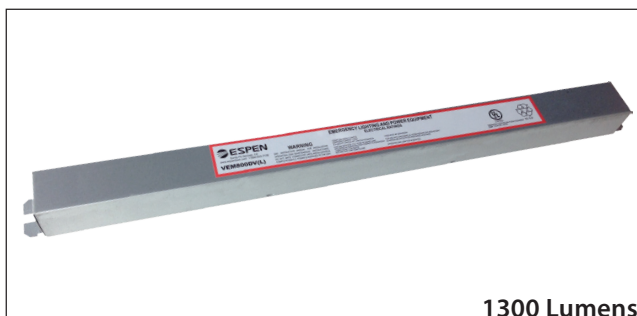

1300 Lumens

#### VEM1300DV-L - Emergency Ballast

- Dual Input Voltage (120/277V)
- Maintenance Free, Long Life
- High Temperature Ni-Cad Battery
- Durable, Heavy-Duty Steel Housing
- 1-lamp: 1,300 lumens | 2-lamp: 1,300 lumens
- Slim Design
- 5 Year Warranty



Model No.	Type	Lumens	Voltage (V)	Operation Hours	Case
VEM500DV-L	Emergency Ballast	500	120/277	90 mins	Regular
VEM700DV-L	Emergency Ballast	700	120/277	90 mins	Regular
VEM800DV-L	Emergency Ballast	800	120/277	90 mins	Slim
VEM1300DV-L	Emergency Ballast	1300	120/277	90 mins	Slim



### Compact LED

Internal Driver, Convenient Installation, Instant on with no delay or warm up time, High CRI, 5 year warranty



### Linear LED

Med. Bi-pin, Internal Driver, DLC Listed, Glass tube for superior optical performance, Utilizes unshunted (rapid start) sockets, Long Life \*Also available in 0-10V dimming

### 360° Sign Lamps LED

Double-sided design, Rotatable endcaps, Compatible with sensors, Utilizes R17d sockets, Input from both ends



### LED FT Lamps LED

Utilizes current 2G11 sockets, Internal Driver, Compatible with controls and sensors, Instant On



### Emergency Inverter

90 Minute Illumination Time



### HID Lamps LED

Approved for totally enclosed fixture, 4KV Surge protection, IP65 for wet location, High efficiency



### Espen Flex LED Lamps

Espen Flex LED lamps have an internal driver that frees linear luminaires from old fluorescent ballasts and lamps. The lamp works directly off of line input voltage 120/277V. Flex lamps make convenient and effective retrofit solutions for any old T12 system, especially with magnetic ballasts. Simply remove the old fluorescent ballast and wire line voltage directly to one side of the unshunted lamp holder. Flex lamps can save you up to 50% of system power, while maintaining or increasing illumination levels. Flex lamps come in a range of sizes, including linear 2ft, 3ft, 4ft, 5ft, 6ft, and 8ft.

**\*NEW Addition: HID lamps and Sign lamps**

TYPE - B

## AC Direct Input HO T5 Lamps | Double End Input



### FEATURES AND BENEFITS

- Double Ended Bypass Connection
- Internal Driver
- Glass Tube for Optimal Light Output and Heat Dissipation
- -20° F to 130° F Ambient Operating Temperature
- Frosted to Prevent Glare
- Suitable for Damp Locations
- 240° Wide Beam Angle
- 5 Year Warranty



### WIRING DIAGRAM

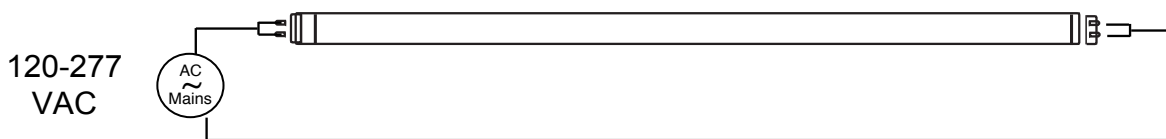

Model No.	Replaces	Length (in)	Lamp Power (W)	Lumens (lm)	Lamp Efficacy (lm/W)	Voltage (V)	CCT (K)	CRI	Life (h)
<b>HO Linear T5</b>									
L48T5/830/25G-ID DE	F54T5HO	48	25	3500	140	120 - 277	3000 <sup>1</sup>	80+	50000
L48T5/835/25G-ID DE	F54T5HO	48	25	3500	140	120 - 277	3500	80+	50000
L48T5/840/25G-ID DE	F54T5HO	48	25	3500	140	120 - 277	4000	80+	50000
L48T5/850/25G-ID DE	F54T5HO	48	25	3500	140	120 - 277	5000	80+	50000

<sup>1</sup> 3000K CCT may be subject to lead times and availability.

**TYPE - B**





### FEATURES AND BENEFITS

- Single Ended Bypass Connection with Non-Shunted Tombstones
- 0-10 Dimmable
- Internal Driver
- Glass Tube for Optimal Light Output and Heat Dissipation
- -20° F to 130° F Ambient Operating Temperature
- Frosted to Prevent Glare
- Suitable for Damp Locations
- 325° Wide Beam Angle
- 5 Year Warranty



**NO**  
Shunted  
Instant Start Socket



**YES**  
Unshunted  
Rapid Start Socket

### WIRING DIAGRAM

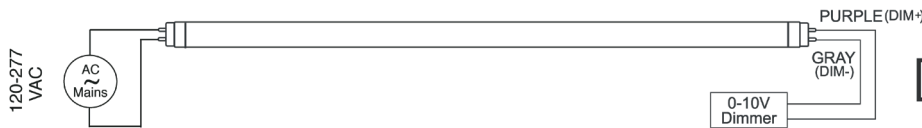

TYPE - B

Model No.	Replaces	Length (in)	Lamp Power (W)	Lumens (lm)	Lamp Efficacy (lm/W)	Input Voltage (V)	CCT (K)	CRI	Life (h)	
<b>Linear T8</b>										
L24T8/830/9G-ID-10V	F17T8	24	9	1100	122	120 - 277	3000 <sup>2</sup>	83+	50000	
L24T8/835/9G-ID-10V	F17T8	24	9	1100	122	120 - 277	3500	83+	50000	
L24T8/840/9G-ID-10V	F17T8	24	9	1100	122	120 - 277	4000	83+	50000	
L24T8/850/9G-ID-10V	F17T8	24	9	1100	122	120 - 277	5000	83+	50000	
L36T8/830/12G-ID-10V <sup>1</sup>	F25T8	36	12	1400	117	120 - 277	3000 <sup>2</sup>	83+	50000	
L36T8/835/12G-ID-10V <sup>1</sup>	F25T8	36	12	1400	117	120 - 277	3500	83+	50000	
L36T8/840/12G-ID-10V <sup>1</sup>	F25T8	36	12	1400	117	120 - 277	4000	83+	50000	
L36T8/850/12G-ID-10V <sup>1</sup>	F25T8	36	12	1400	117	120 - 277	5000	83+	50000	
L48T8/830/14G-ID-10V	F32T8	48	14	1800	129	120 - 277	3000 <sup>2</sup>	83+	50000	
L48T8/835/14G-ID-10V	F32T8	48	14	1800	129	120 - 277	3500	83+	50000	
L48T8/840/14G-ID-10V	F32T8	48	14	1800	129	120 - 277	4000	83+	50000	
L48T8/850/14G-ID-10V	F32T8	48	14	1800	129	120 - 277	5000	83+	50000	
L48T8/830/17G-ID-10V	F32T8	48	18	2200	129	120 - 277	3000 <sup>2</sup>	83+	50000	
L48T8/835/17G-ID-10V	F32T8	48	18	2200	129	120 - 277	3500	83+	50000	
L48T8/840/17G-ID-10V	F32T8	48	18	2200	129	120 - 277	4000	83+	50000	
L48T8/850/17G-ID-10V	F32T8	48	18	2200	129	120 - 277	5000	83+	50000	

<sup>1</sup> Not DLC listed.

<sup>2</sup> 3000K CCT may be subject to lead times and availability.



## Linear T8 Lamps | Double End Input



### FEATURES AND BENEFITS

- Double Ended Bypass Connection with Shunted or Non-Shunted Tombstones
- Internal Driver
- Glass Tube for Optimal Light Output and Heat Dissipation
- -20° F to 130° F Ambient Operating Temperature
- Instant on, No delay
- Convenient and quick installation
- Frosted to Prevent Glare
- Suitable for Damp Locations
- 325° Wide Beam Angle
- 5 Year Warranty

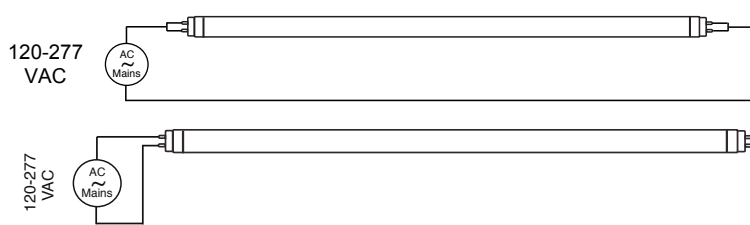

**YES**  
Shunted  
Instant Start Socket



**YES**  
Unshunted  
Rapid Start Socket

Model No.	Replaces	Length (in)	Lamp Power (W)	Lumens (lm)	Lamp Efficacy (lm/W)	Input Voltage (V)	CCT (K)	CRI	Life (h)
<b>Linear T8</b>									
L24T8/830/9G-ID DE	F17T8	24	9	1100	122	120 - 277	3000 <sup>1</sup>	83+	50000
L24T8/835/9G-ID DE	F17T8	24	9	1100	122	120 - 277	3500	83+	50000
L24T8/840/9G-ID DE	F17T8	24	9	1100	122	120 - 277	4000	83+	50000
L24T8/850/9G-ID DE	F17T8	24	9	1100	122	120 - 277	5000	83+	50000
L36T8/830/12G-ID DE	F25T8	36	12	1400	117	120 - 277	3000 <sup>1</sup>	83+	50000
L36T8/835/12G-ID DE	F25T8	36	12	1400	117	120 - 277	3500	83+	50000
L36T8/840/12G-ID DE	F25T8	36	12	1400	117	120 - 277	4000	83+	50000
L36T8/850/12G-ID DE	F25T8	36	12	1400	117	120 - 277	5000	83+	50000
<b>Above Products: Transitioning to Type A + B Solutions, See page 21</b>									
L48T8/830/14G-ID DE	F32T8	48	14	1800	129	120 - 277	3000	83+	50000
L48T8/835/14G-ID DE	F32T8	48	14	1800	129	120 - 277	3500 <sup>1</sup>	83+	50000
L48T8/840/14G-ID DE	F32T8	48	14	1800	129	120 - 277	4000	83+	50000
L48T8/850/14G-ID DE	F32T8	48	14	1800	129	120 - 277	5000	83+	50000
L48T8/830/17G-ID DE	F32T8	48	17	2200	122	120 - 277	3000 <sup>1</sup>	83+	50000
L48T8/835/17G-ID DE	F32T8	48	17	2200	122	120 - 277	3500	83+	50000
L48T8/840/17G-ID DE	F32T8	48	17	2200	122	120 - 277	4000	83+	50000
L48T8/850/17G-ID DE	F32T8	48	17	2200	122	120 - 277	5000	83+	50000

**TYPE - B**

<sup>1</sup> 3000K may be subject to lead times and availability.

# Flex™ ArmorCoat™



AC Direct Input Slimline LED T8 Lamps | Double End Input



## FEATURES AND BENEFITS

- Double Ended Bypass Connection
- Internal Driver
- **ArmorCoat™** Shatterproof Coating
- Glass Tube for Optimal Light Output and Heat Dissipation
- -20° F to 130° F Ambient Operating Temperature
- Bracket Included
- Frosted to Prevent Glare
- Suitable for Damp Locations
- 325° Wide Beam Angle
- 5 Year Warranty



## WIRING DIAGRAM

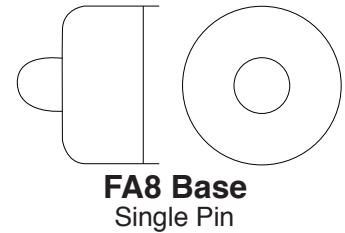
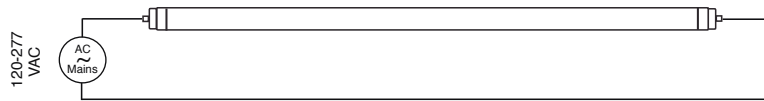

TYPE - B

Model No.	Base Type	Replaces	Length (in)	Lamp Power (W)	Lumens (lm)	Lamp Efficacy (lm/W)	Input Voltage (V)	CCT (K)	CRI	Life (h)
<b>Slimline Linear T8</b>										
L60T8SL/830/15G-ID DE	FA8	F60T8, F60T12	60	15	2200	147	120 - 277	3000 <sup>1</sup>	83+	50000
L60T8SL/835/15G-ID DE	FA8	F60T8, F60T12	60	15	2200	147	120 - 277	3500 <sup>1</sup>	83+	50000
L60T8SL/840/15G-ID DE	FA8	F60T8, F60T12	60	15	2200	147	120 - 277	4000 <sup>1</sup>	83+	50000
L60T8SL/850/15G-ID DE	FA8	F60T8, F60T12	60	15	2200	147	120 - 277	5000 <sup>1</sup>	83+	50000
L72T8SL/830/18G-ID DE	FA8	F72T8, F72T12	72	18	2700	150	120 - 277	3000 <sup>1</sup>	83+	50000
L72T8SL/835/18G-ID DE	FA8	F72T8, F72T12	72	18	2700	150	120 - 277	3500 <sup>1</sup>	83+	50000
L72T8SL/840/18G-ID DE	FA8	F72T8, F72T12	72	18	2700	150	120 - 277	4000 <sup>1</sup>	83+	50000
L72T8SL/850/18G-ID DE	FA8	F72T8, F72T12	72	18	2700	150	120 - 277	5000 <sup>1</sup>	83+	50000
L96T8/830/24G-ID DE	FA8	F96T8, F96T12	96	24	3500	146	120 - 277	3000 <sup>1</sup>	83+	50000
L96T8/835/24G-ID DE	FA8	F96T8, F96T12	96	24	3500	146	120 - 277	3500	83+	50000
L96T8/840/24G-ID DE	FA8	F96T8, F96T12	96	24	3500	146	120 - 277	4000	83+	50000
L96T8/850/24G-ID DE	FA8	F96T8, F96T12	96	24	3500	146	120 - 277	5000	83+	50000
L96T8HO/830/42G-ID DE	FA8	F96T8, F96T12	96	42	5500	131	120 - 277	3000 <sup>1</sup>	83+	50000
L96T8HO/835/42G-ID DE	FA8	F96T8, F96T12	96	42	5500	131	120 - 277	3500	83+	50000
L96T8HO/840/42G-ID DE	FA8	F96T8, F96T12	96	42	5500	131	120 - 277	4000	83+	50000
L96T8HO/850/42G-ID DE	FA8	F96T8, F96T12	96	42	5500	131	120 - 277	5000	83+	50000

<sup>1</sup> May be subject to lead times and availability.

# Flex™ ArmorCoat™

AC Direct Input HO/VHO LED T8 Lamps | Double End Input



## FEATURES AND BENEFITS

- Double Ended Bypass Connection
- Internal Driver
- **ArmorCoat™** Shatterproof Coating
- Glass Tube for Optimal Light Output and Heat Dissipation
- -20° F to 130° F Ambient Operating Temperature
- Integrated Thermal Fuse Protection
- Frosted to Prevent Glare
- Suitable for Damp Locations
- 325° Wide Beam Angle
- 5 Year Warranty



## WIRING DIAGRAM

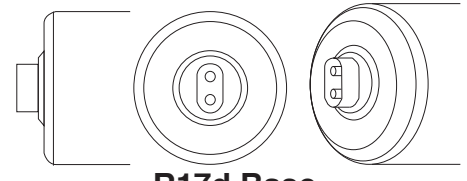
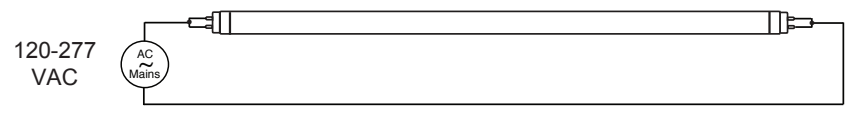

**R17d Base**  
Recessed Double Contact

**TYPE - B**

Model No.	Base Type	Replaces	Length (in)	Lamp Power (W)	Lumens (lm)	Lamp Efficacy (lm/W)	Input Voltage (V)	CCT (K)	CRI	Life (h)
<b>HO/VHO Linear T8</b>										
L60T8HO/830/15G-ID DE	R17d	F60T12 HO/VHO	60	15	2200	147	120 - 277	3000 <sup>1</sup>	83+	50000
L60T8HO/835/15G-ID DE	R17d	F60T12 HO/VHO	60	15	2200	147	120 - 277	3500 <sup>1</sup>	83+	50000
L60T8HO/840/15G-ID DE	R17d	F60T12 HO/VHO	60	15	2200	147	120 - 277	4000 <sup>1</sup>	83+	50000
L60T8HO/850/15G-ID DE	R17d	F60T12 HO/VHO	60	15	2200	147	120 - 277	5000 <sup>1</sup>	83+	50000
L72T8HO/830/18G-ID DE	R17d	F72T12 HO/VHO	72	18	2700	150	120 - 277	3000 <sup>1</sup>	83+	50000
L72T8HO/835/18G-ID DE	R17d	F72T12 HO/VHO	72	18	2700	150	120 - 277	3500 <sup>1</sup>	83+	50000
L72T8HO/840/18G-ID DE	R17d	F72T12 HO/VHO	72	18	2700	150	120 - 277	4000 <sup>1</sup>	83+	50000
L72T8HO/850/18G-ID DE	R17d	F72T12 HO/VHO	72	18	2700	150	120 - 277	5000 <sup>1</sup>	83+	50000
L96T8HO/830/42G-ID DE	R17d	F96T8, F96T12 HO/VHO	96	42	5500	131	120 - 277	3000 <sup>1</sup>	83+	50000
L96T8HO/835/42G-ID DE	R17d	F96T8, F96T12 HO/VHO	96	42	5500	131	120 - 277	3500	83+	50000
L96T8HO/840/42G-ID DE	R17d	F96T8, F96T12 HO/VHO	96	42	5500	131	120 - 277	4000	83+	50000
L96T8HO/850/42G-ID DE	R17d	F96T8, F96T12 HO/VHO	96	42	5500	131	120 - 277	5000	83+	50000

<sup>1</sup> May be subject to lead times and availability.

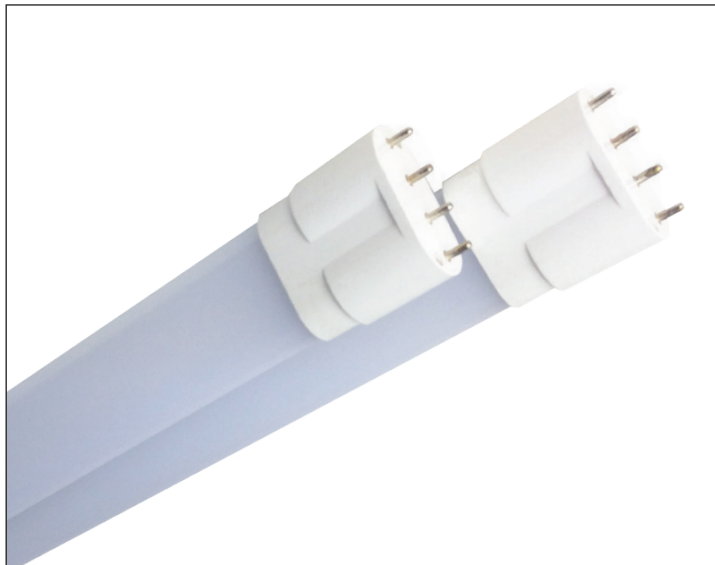

### FEATURES AND BENEFITS

- Internal Driver
- Smooth, Consistent Light
- UL for Safety
- No UV, No Mercury
- Long Life
- High CRI
- Instant on, no delay or warm up time
- Convenient and quick installation
- Utilizes current lamp sockets
- Compatible with controls and sensors
- -20° F to 130° F Ambient Operating Temperature
- 5 Year Warranty



TYPE - B

Model No.	Replaces	Lamp Power (W)	Lumens (lm)	Lamp Efficacy (lm/W)	Input Voltage (V)	CCT (K)	CRI	Life (h)
<b>Compact LED Lamps</b>								
LT18W/835-ID	FT18W	8	640	80	120 - 277	3500	83+	50000
LT18W/840-ID	FT18W	8	640	80	120 - 277	4000	83+	50000
LT18W/850-ID	FT18W	8	640	80	120 - 277	5000	83+	50000
LT24W/835-ID	FT24W	10	800	80	120 - 277	3500	83+	50000
LT24W/840-ID	FT24W	10	800	80	120 - 277	4000	83+	50000
LT24W/850-ID	FT24W	10	800	80	120 - 277	5000	83+	50000
LT36W/835-ID	FT36W	15	1200	80	120 - 277	3500	83+	50000
LT36W/840-ID	FT36W	15	1200	80	120 - 277	4000	83+	50000
LT36W/850-ID	FT36W	15	1200	80	120 - 277	5000	83+	50000
LT40W/835-ID	FT40W/FT55W	18	1800	80	120 - 277	3500	83+	50000
LT40W/840-ID	FT40W/FT55W	18	1800	80	120 - 277	4000	83+	50000
LT40W/850-ID	FT40W/FT55W	18	1800	80	120 - 277	5000	83+	50000

### WIRING DIAGRAM

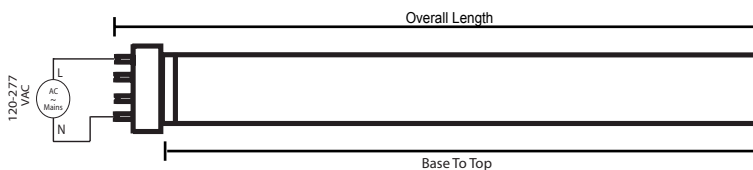

LT series	Overall Length (mm)	Base Face to Top (mm)
<b>Dimensions</b>		
LT40	540	493
LT36	421	374
LT24	326	278
LT18	231	183

## AC Direct Input Compact LED Lamps | Single End Input



CLD18WH



CLD18WV

### FEATURES AND BENEFITS

- Compatible with 2-Pin and 4-Pin Sockets
- Internal Driver
- -20° F to 130° F Ambient Operating Temperature
- Frosted to Prevent Glare
- Suitable for Damp Locations
- 5 Year Warranty



Model No.	Replaces	Lamp Power (W)	Lumens (lm)	Lamp Efficacy (lm/W)	Input Voltage (V)	CCT (K)	CRI	Life (h)
<b>Compact LED Lamps</b>								
CLD18WH/830-ID	18W, 26W, 32W, 42W CFQ	8	950	118	120 - 277	3000 <sup>1</sup>	83+	50000
CLD18WH/835-ID	18W, 26W, 32W, 42W CFQ	8	950	118	120 - 277	3500	83+	50000
CLD18WH/840-ID	18W, 26W, 32W, 42W CFQ	8	950	118	120 - 277	4000	83+	50000
CLD18WH/850-ID	18W, 26W, 32W, 42W CFQ	8	950	118	120 - 277	5000	83+	50000
CLD18WV/830-ID	18W, 26W, 32W, 42W CFQ	8	950	118	120 - 277	3000 <sup>1</sup>	83+	50000
CLD18WV/835-ID	18W, 26W, 32W, 42W CFQ	8	950	118	120 - 277	3500	83+	50000
CLD18WV/840-ID	18W, 26W, 32W, 42W CFQ	8	950	118	120 - 277	4000	83+	50000
CLD18WV/850-ID	18W, 26W, 32W, 42W CFQ	8	950	118	120 - 277	5000	83+	50000

<sup>1</sup> 3000K may be subject to lead times and availability.



TYPE - B

## 360° Sign Lamps



### FEATURES AND BENEFITS

- Double-sided Design Sign Light
- 360° Beam Angle
- Rotatable End Caps
- Internal Driver
- Compatible with Sensors
- Instant On, No Delay or Warm Up Time
- Convenient and Quick Installation
- Input from Both Ends
- Utilizes R17d Sockets
- Works in Cold Temperature Applications
- Plastic tube is shatterproof
- No UV, No Mercury
- UL for Safety
- High CRI
- 5 Year Warranty



Model No.	Length (in)	Base Type	Lamp Wattage	Input Voltage (V)	CCT (K)	Initial Lumens	CRI	Beam Angle	Lamp Efficacy (lm/W)	Power Factor	THD
<b>360° Sign Lamps</b>											
LS48T8HO/840/21P-ID DE	48	R17d	21	120 - 277	4000	2500	83+	360	120	>0.90	<20%
LS48T8HO/865/21P-ID DE	48	R17d	21	120 - 277	6500	2500	83+	360	120	>0.90	<20%
LS60T8HO/840/25P-ID DE	60	R17d	25	120 - 277	4000	3000	83+	360	120	>0.90	<20%
LS60T8HO/865/25P-ID DE	60	R17d	25	120 - 277	6500	3000	83+	360	120	>0.90	<20%
LS72T8HO/840/32P-ID DE	72	R17d	32	120 - 277	4000	3840	83+	360	120	>0.90	<20%
LS72T8HO/865/32P-ID DE	72	R17d	32	120 - 277	6500	3840	83+	360	120	>0.90	<20%
LS96T8HO/840/42P-ID DE	96	R17d	42	120 - 277	4000	5000	83+	360	120	>0.90	<20%
LS96T8HO/865/42P-ID DE	96	R17d	42	120 - 277	6500	5000	83+	360	120	>0.90	<20%

TYPE - B

### WIRING DIAGRAM

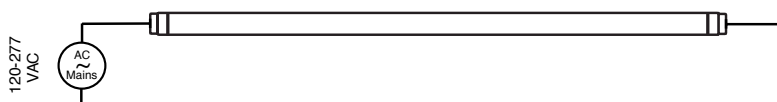

## HID Replacement Lamps



### FEATURES AND BENEFITS

- High Efficiency, >130lm/w
- Damp location HID, 4KV Surge Protection
- Wet location HID, IP65, 4KV Surge Protection
- Approved for Totally Enclosed Fixture
- Excellent Thermal Design of Chimney Effect
- Voltage 120-277V
- Internal Driver
- Smooth, Consistent Light
- UL for Safety
- No UV, No Mercury
- Long Life
- High CRI
- Convenient and Quick Installation
- 5 Year Warranty
- Superior Wide View Angle



Damp Location HID Lamp						
Model No.	Watt	Equal to HID	Lumen	CRI	Base	Dimensions (in)
HDE70/8XX/18W-ID	18	70	2300	80	E26	Dia. 2.36 X 6.81
HDE100/8XX/27W-ID	27	100	3510	80	E26	Dia. 2.76 X 7.24
HDM100/8XX/27W-ID	27	100	3510	80	E39	Dia. 2.76 X 7.60
HDE150/8XX/36W-ID	36	150	4680	80	E26	Dia. 3.54 X 9.41
HDM150/8XX/36W-ID	36	150	4680	80	E39	Dia. 3.54 X 9.41
HDE175/8XX/45W-ID	45	175	6000	80	E26	Dia. 3.54 X 9.41
HDM175/8XX/45W-ID	45	175	6000	80	E39	Dia. 3.54 X 9.41
HDE250/8XX/54W-ID	54	250	7020	80	E26	Dia. 3.54 X 9.29
HDM250/8XX/54W-ID	54	250	7020	80	E39	Dia. 3.54 X 9.65
HDM320/8XX/80W-ID	80	320	10400	80	E39	Dia. 4.88 X 10.20
HDM400/8XX/100W-ID	100	400	13000	80	E39	Dia. 5.91 X 10.59

Wet Location HID Lamps IP65						
Model No.	Watt	Equal to HID	Lumen	CRI	Base	Dimensions (in)
HDE70/8XX/18W-ID WP	18	70	2300	80	E26	Dia. 2.76 X 6.89
HDE100/8XX/27W-ID WP	27	100	3510	80	E26	Dia. 2.76 X 7.48
HDE150/8XX/36W-ID WP	36	150	4680	80	E26	Dia. 3.54 X 8.66
HDM150/8XX/36W-ID WP	36	150	4680	80	E39	Dia. 2.76 X 9.02
HDE175/8XX/45W-ID WP	45	175	6000	80	E26	Dia. 3.54 X 9.25
HDM175/8XX/45W-ID WP	45	175	6000	80	E39	Dia. 2.76 X 9.61
HDE250/8XX/54W-ID WP	54	250	7020	80	E26	Dia. 3.54 X 9.84
HDM250/8XX/54W-ID WP	54	250	7020	80	E39	Dia. 3.54 X 10.20
HDM320/8XX/80W-ID WP	80	320	10400	80	E39	Dia. 4.33 X 10.59
HDM400/8XX/100W-ID WP	100	400	13000	80	E39	Dia. 5.12 X 10.94

TYPE - B

## Type B Emergency LED Inverter



**VEMB20W**  
20W

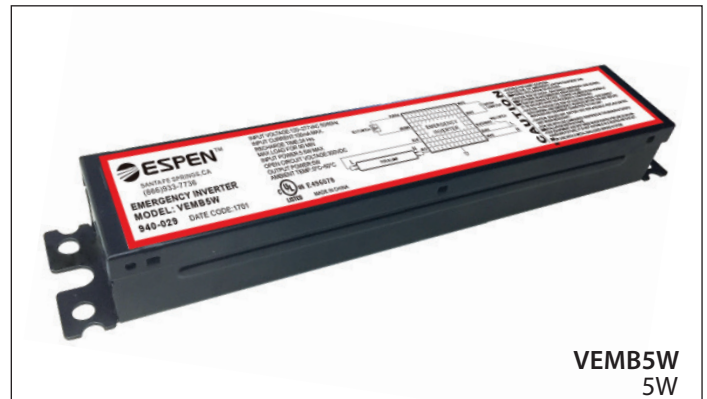

**VEMB5W**  
5W

### FEATURES AND BENEFITS

- Operates Espen Type B T5 & T8 LED Lamps
- Illuminates Most LEDs at Full Brightness, Up to 20W
- 32° F to 122° F Ambient Operating Temperature
- Durable Steel Housing Contains LED Driver & Battery
- Suitable for Damp Locations
- 90 Minute Illumination Time
- Nickel-Cadmium Rechargeable Battery
- LED Test Switch Included
- UL924, NFPA 101 Life Safety Code, NEC & OSHA Compliant
- 5 Year Warranty

### FEATURES AND BENEFITS

- Operates Espen Type B T5 & T8 LED Lamps on pgs 12, 16 & 18
- Provides 5W of power for a minimum of 90 minutes
- 32° F to 122° F Ambient Operating Temperature
- Durable Steel Housing Contains LED Driver & Battery
- Suitable for Damp Locations
- Lithium-Ion Rechargeable Battery
- LED Test Switch Included
- UL924 & FCC Compliant
- 5 Year Warranty



TYPE - B

### DIMENSIONS

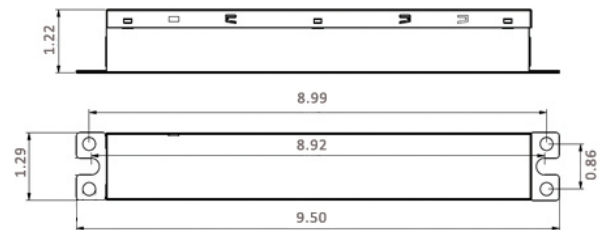
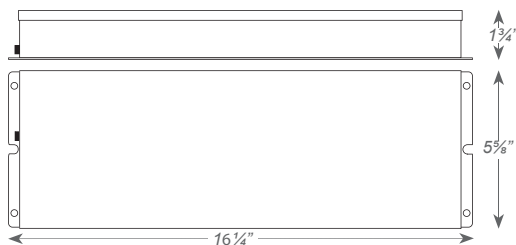

### WIRING DIAGRAM

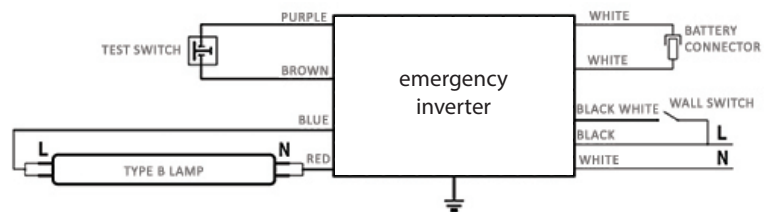
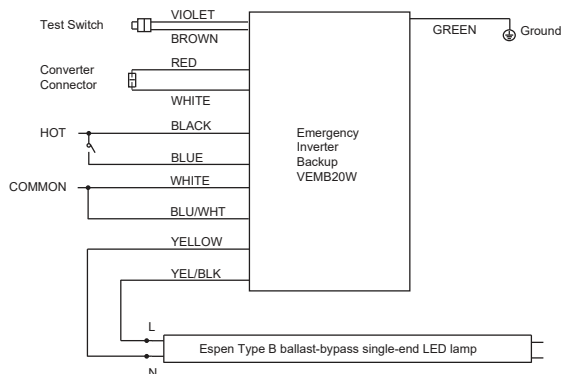

Model No.	Input Voltage (V)	Output Voltage (V)	Output Power (W)
<b>Type B Emergency LED Driver</b>			
VEMB20W+	120-277	OCV 320VDC	20
VEMB5W	120-277	OCV 300VDC	5

+ May be subject to lead times and availability.



# UniFlex™

Type A + B LED T8 Lamps



## T8 Linear Lamps LED

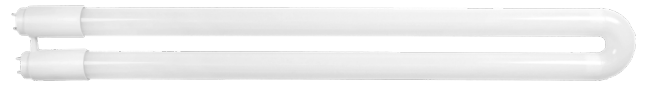
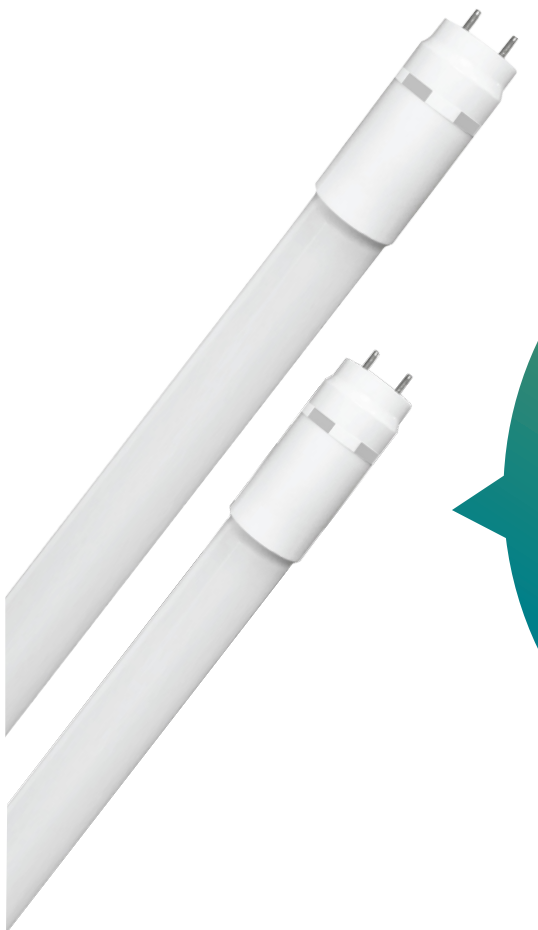

**UniFlex™**  
LED Solutions  
Ballast Compatible  
and AC Direct

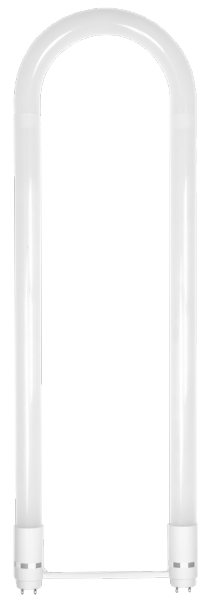

## U-Bent Lamps LED

### UniFlex - Type A+B Solution

UniFlex is a line of Hybrid Type A+B LED linear tubes, with industry-leading performance. The lamps can work with an existing fluorescent ballast, as 'plug-n-play', or directly on line voltage if the old ballast is bypassed. For Type A operation, the lamps work with fluorescent electronic ballasts, both instant start and programmed start. For Type B operation, UniFlex lamps have an internal driver that accepts 120-277 VAC, double-ended input. UniFlex works with existing instant start or rapid start sockets and are compatible with dimming ballasts, controls, and sensors. UniFlex lamps are offered in U-Bent, 2', 3', and 4' configurations.

TYPE A+B

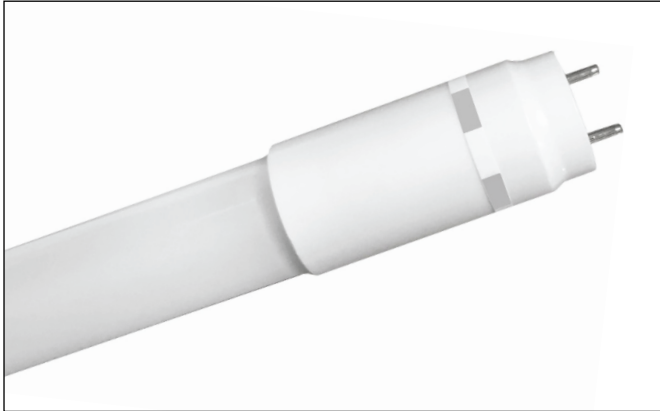

### FEATURES AND BENEFITS

#### Type-A Application:

- Works on existing compatible Electronic Ballast
- Instant Start and Program Rapid Start Electronic Ballast

#### Type-B Application:

- Internal Drive To Be Wired Directly To Sockets
- 120 or 277 Volts Application
- See wiring diagram for Double Ended installation

- Long life | High CRI
- Instant on, No delay
- Convenient and quick installation
- Works with dimming ballast
- Compatible with controls and sensors
- Works in cold temperature applications
- 5 Year Warranty

### WIRING DIAGRAM

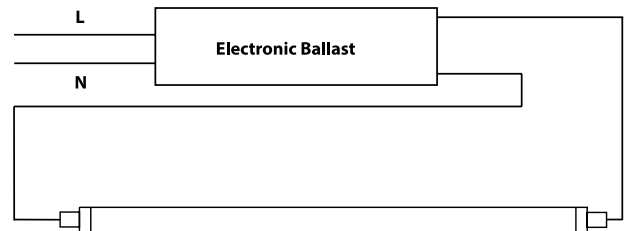
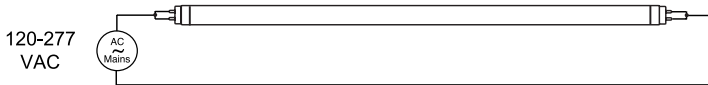

Model No.	Length (in)	Power Direct AC (W)	Power w/Ballast (W)	Input Voltage	CCT	Lumens (lm)	CRI	Beam Angle	Lamp Efficacy Direct AC	Lamp Efficacy w/Ballast	Life (h)
L24T8/830/9G-AB	24	9	12	120-277	3000 <sup>2</sup>	1350	83	325	150	112	50000
L24T8/835/9G-AB	24	9	12	120-277	3500	1350	83	325	150	112	50000
L24T8/840/9G-AB	24	9	12	120-277	4000	1350	83	325	150	112	50000
L24T8/850/9G-AB	24	9	12	120-277	5000	1350	83	325	150	112	50000
L36T8/830/11G-AB	36	11	14	120-277	3000 <sup>2</sup>	1650	83	325	150	115	50000
L36T8/835/11G-AB	36	11	14	120-277	3500	1650	83	325	150	115	50000
L36T8/840/11G-AB	36	11	14	120-277	4000	1650	83	325	150	115	50000
L36T8/850/11G-AB	36	11	14	120-277	5000	1650	83	325	150	115	50000
L48T8/830/12G-AB	48	12	15	120-277	3000 <sup>2</sup>	1800	83	325	150	120	50000
L48T8/835/12G-AB	48	12	15	120-277	3500	1800	83	325	150	120	50000
L48T8/840/12G-AB	48	12	15	120-277	4000	1800	83	325	150	120	50000
L48T8/850/12G-AB	48	12	15	120-277	5000	1800	83	325	150	120	50000

<sup>1</sup> See [espentech.com](http://espentech.com) for ballast compatibility list.

<sup>2</sup> 3000K may be subject to lead times and availability



### FEATURES AND BENEFITS

- Type A and B Lamp
- Internal driver for direct 120-277 VAC Input
- Double ended Type-B Input
- Works with fluorescent electronic ballast (Instant Start and Programmed Start)
- Long life | High CRI
- Instant on, No delay
- Convenient and quick installation
- Utilizes existing instant start or rapid start sockets
- Works with dimming ballast
- Compatible with controls and sensors
- Works in cold temperature applications
- 5 Year Warranty

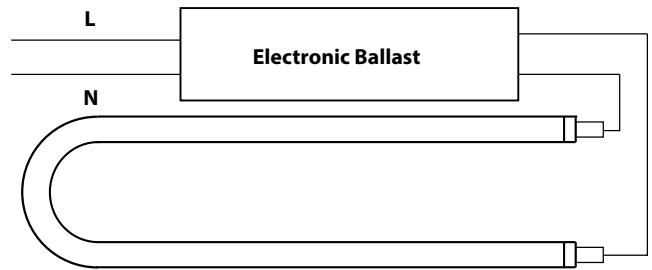
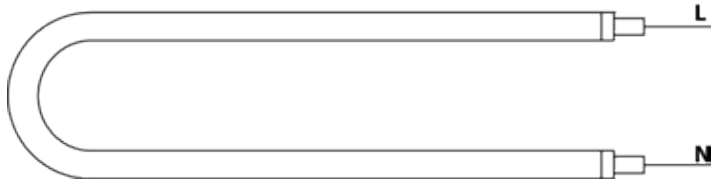

Model No.	Length (in)	Width (in)	Power Direct AC (W)	Power w/Ballast (W)	Input Voltage	CCT	Lumens (lm)	CRI	Beam Angle	Lamp Efficacy Direct AC	Lamp Efficacy w/Ballast	Life (h)
LB31T8U/830/13P-AB	24	1-5/8	13	16	120-277V	3000K <sup>3</sup>	1800	83	240°	138 <sup>1</sup>	112.5 <sup>1</sup>	50000
LB31T8U/835/13P-AB	24	1-5/8	13	16	120-277V	3500K	1800	83	240°	138 <sup>1</sup>	112.5 <sup>1</sup>	50000
LB31T8U/840/13P-AB	24	1-5/8	13	16	120-277V	4000K	1800	83	240°	138 <sup>1</sup>	112.5 <sup>1</sup>	50000
LB31T8U/850/13P-AB	24	1-5/8	13	16	120-277V	5000K	1800	83	240°	138 <sup>1</sup>	112.5 <sup>1</sup>	50000
LB48T8U6/830/13P-AB	24	6	13	16	120-277V	3000K <sup>3</sup>	1800	83	240°	138 <sup>1</sup>	128 <sup>1</sup>	50000
LB48T8U6/835/13P-AB	24	6	13	16	120-277V	3500K	1800	83	240°	138 <sup>1</sup>	128 <sup>1</sup>	50000
LB48T8U6/840/13P-AB	24	6	13	16	120-277V	4000K	1800	83	240°	138 <sup>1</sup>	128 <sup>1</sup>	50000
LB48T8U6/850/13P-AB	24	6	13	16	120-277V	5000K	1800	83	240°	138 <sup>1</sup>	128 <sup>1</sup>	50000

<sup>1</sup> Calculation based on (lm/W)  
<sup>2</sup> See espentech.com for ballast compatibility list.  
<sup>3</sup> 3000K CCT may be subject to lead times and availability

TYPE A+B



**LED  
RETROFIT  
LIGHTING  
SOLUTIONS**

LED LAMP WITH EXTERNAL DRIVER | Type C



**driver** LED

Constant Current  
Multi-Channel 0-10V & power line dimming  
Available in Programmable & Field Adjustable

**linear** LED

G13 or G5, External Driver  
Dimmable, Long Life, Convenient Wiring



TYPE - C



**LED**  
**programmer**

Adjusts drivers' power, current,  
dimming levels and delay timer



**emergency**  
**driver**

Constant light output,  
Auto LED load sensing

**ESPEN CORETECH LED SYSTEM**

LED lamps with external driver for full controllability Espen's CoreTech LED system consists of industry-leading LED lamps and programmable multi-channel drivers. The CoreTech system utilizes the exact same wiring diagram as fluorescent ballasts. The upgrade is handled the same as replacing an electronic ballast and lamps. Your facility can save up to 50% of system power while maintaining or increasing illumination levels.

The CoreTech multi-channel design permits all lamps to work independently to prevent total darkness when one lamp fails. The user-friendly programmability allows you to set the same system for normal output, high output, or low output, to match your application requirements.

LED T5 HE & HO LAMP WITH EXTERNAL DRIVER | Type C

TYPE - C



FEATURES AND BENEFITS

- No Polarity, Lamp Ends Can Be Reversed
- Compatible with Controls and Sensors
- Glass Tube for Optimal Light Output and Heat Dissipation
- 50,000 Hours Life with No Limitation on On/Off Cycles
- -20° F to 130° F Ambient Operating Temperature
- 1 or 2 Lamps Compatible with Espen VPL50 LED Driver<sup>1</sup>
- 3 or 4 Lamps Compatible with Espen VPL100 LED Driver<sup>1</sup>
- 240° Wide Beam Angle
- Dimmable
- 5 Year Warranty



Model No.	Length (in)	Driver Current	Replaces	Lamp Power (W)	System Power (W)	Lumens (lm)	Lamp Efficacy (lm/W)	Lamp Voltage (V)	CCT (K)	CRI	Life (h)	Current Settings
<b>Linear T8</b>												
L24T5/830/11G-XT	24	Normal	F14T5HE	9	12	1300	144	120 - 277	3000+	82+	50000	360mA
		High	F24T5HO	12	15	1700	142					500mA
L24T5/835/11G-XT	24	Normal	F14T5HE	9	12	1300	144	120 - 277	3500	82+	50000	360mA
		High	F24T5HO	12	15	1700	142					500mA
L24T5/840/11G-XT	24	Normal	F14T5HE	9	12	1300	144	120 - 277	4000	82+	50000	360mA
		High	F24T5HO	12	15	1700	142					500mA
L24T5/850/11G-XT	24	Normal	F14T5HE	9	12	1300	144	120 - 277	5000	82+	50000	360mA
		High	F24T5HO	12	15	1700	142					500mA
L36T5/830/18G-XT	36	Normal	F21T5HE	13	16	1900	146	120 - 277	3000+	82+	50000	360mA
		High	F39T5HO	18	21	2500	139					500mA
L36T5/835/18G-XT	36	Normal	F21T5HE	13	16	1900	146	120 - 277	3500	82+	50000	360mA
		High	F39T5HO	18	21	2500	139					500mA
L36T5/840/18G-XT	36	Normal	F21T5HE	13	16	1900	146	120 - 277	4000	82+	50000	360mA
		High	F39T5HO	18	21	2500	139					500mA
L36T5/850/18G-XT	36	Normal	F21T5HE	13	16	1900	146	120 - 277	5000	82+	50000	360mA
		High	F39T5HO	18	21	2500	139					500mA
L48T5/830/24G-XT	48	Normal	F28T5HE	15	18	2300	153	120 - 277	3000+	82+	50000	360mA
		High	F54T5HO	24	27	3300	138					500mA
L48T5/835/24G-XT	48	Normal	F28T5HE	15	18	2300	153	120 - 277	3500	82+	50000	360mA
		High	F54T5HO	24	27	3300	138					500mA
L48T5/840/24G-XT	48	Normal	F28T5HE	15	18	2300	153	120 - 277	4000	82+	50000	360mA
		High	F54T5HO	24	27	3300	138					500mA
L48T5/850/24G-XT	48	Normal	F28T5HE	15	18	2300	153	120 - 277	5000	82+	50000	360mA
		High	F54T5HO	24	27	3300	138					500mA

<sup>1</sup> See VPL50 and VPL100 specifications.

+ 3000K CCT may be subject to lead times and availability.

LED T8 LAMP WITH EXTERNAL DRIVER | Type C



FEATURES AND BENEFITS

- No Polarity, Lamp Ends Can Be Reversed
- -20° F to 130° F Ambient Operating Temperature
- Glass Tube for Optimal Light Output and Heat Dissipation
- 50,000 Hours Life with No Limitation on On/Off Cycles
- 1 or 2 Lamps Compatible with Espen VPL50 LED Driver<sup>1</sup>
- 3 or 4 Lamps Compatible with Espen VPL100 LED Driver<sup>1</sup>
- 325° Wide Beam Angle
- Dimmable
- 5 Year Warranty



TYPE - C

Model No.	Length (in)	Driver Current	Replaces	Lamp Power (W)	System Power (W)	Lumens (lm)	Lamp Efficacy (lm/W)	Lamp Voltage (V)	CCT (K)	CRI	Life (h)	Current Settings
<b>Linear T8</b>												
L24T8/830/8G-XT	24	Normal	F17T8	8	11	1200	150	120 - 277	3000 <sup>2</sup>	82+	50000	300mA
		High		10	13	1400	140					360mA
L24T8/835/8G-XT	24	Normal	F17T8	8	11	1200	150	120 - 277	3500	82+	50000	300mA
		High		10	13	1400	140					360mA
L24T8/840/8G-XT	24	Normal	F17T8	8	11	1200	150	120 - 277	4000	82+	50000	300mA
		High		10	13	1400	140					360mA
L24T8/850/8G-XT	24	Normal	F17T8	8	11	1200	150	120 - 277	5000	82+	50000	300mA
		High		10	13	1400	140					360mA
L36T8/830/11G-XT	36	Normal	F25T8	11	14	1600	145	120 - 277	3000 <sup>2</sup>	82+	50000	300mA
		High		13	16	1900	146					360mA
L36T8/835/11G-XT	36	Normal	F25T8	11	14	1600	145	120 - 277	3500	82+	50000	300mA
		High		13	16	1900	146					360mA
L36T8/840/11G-XT	36	Normal	F25T8	11	14	1600	145	120 - 277	4000	82+	50000	300mA
		High		13	16	1900	146					360mA
L36T8/850/11G-XT	36	Normal	F25T8	11	14	1600	145	120 - 277	5000	82+	50000	300mA
		High		13	16	1900	146					360mA
L48T8/830/15G-XT	48	Normal	F32T8	12	15	1800	150	120 - 277	3000 <sup>2</sup>	82+	50000	300mA
		High		15	18	2200	146					360mA
L48T8/835/15G-XT	48	Normal	F32T8	12	15	1800	150	120 - 277	3500	82+	50000	300mA
		High		15	18	2200	146					360mA
L48T8/840/15G-XT	48	Normal	F32T8	12	15	1800	150	120 - 277	4000	82+	50000	300mA
		High		15	18	2200	146					360mA
L48T8/850/15G-XT	48	Normal	F32T8	12	15	1800	150	120 - 277	5000	82+	50000	300mA
		High		15	18	2200	146					360mA

<sup>1</sup> See VPL50 and VPL100 specifications.  
<sup>2</sup> May be subject to lead times and availability.

Programmable LED Driver for Type-C LED's | Type C

TYPE - C



FEATURES AND BENEFITS

- Programmable Drive Current Range (300 - 600mA)
- For Use with 1 or 2 Espen CoreTech™ LED T5 or T8 Lamps
- Constant Current | 2 Channels
- Output Voltage: 25-50V DC
- Universal Voltage (120 - 277V)
- Dimmable
- Suitable for Damp Locations
- 5 Year Warranty



- Programmable Drive Current Range (200 - 500mA)
- For Use with 3 or 4 Espen CoreTech™ LED T5 or T8 Lamps
- Constant Current | 4 Channels
- Output Voltage: 25-50V DC
- Universal Voltage (120 - 277V)
- Dimmable
- Suitable for Damp Locations
- 5 Year Warranty



2 LAMP WIRING DIAGRAM

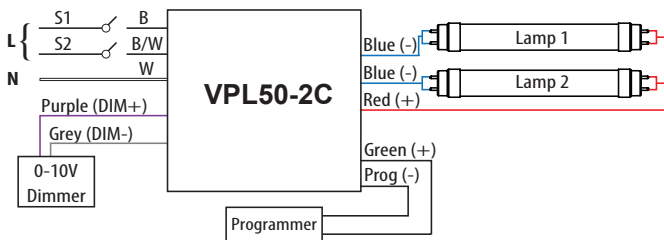

Light Level	S1	S2
100%	ON	ON
50%*	ON	OFF
25%*	OFF	ON
0%	OFF	OFF

\*Programmable For Dual-Relay Dimming

4 LAMP WIRING DIAGRAM

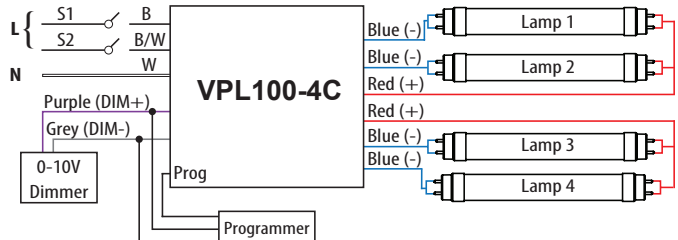

Light Level	S1	S2
100%	ON	ON
50%*	ON	OFF
25%*	OFF	ON
0%	OFF	OFF

\*Programmable For Dual-Relay Dimming

Model No.	Output Current	Driver Type	Max Wattage (W)	No. of Channels	Input Voltage (V)	Dimming
<b>Programmable LED Driver</b>						
VPL50-2C	Programmable	Constant Current	50	2	120 - 277	0 -10V or A/B
VPL100-4C	Programmable	Constant Current	80	4	120 - 277	0 -10V or A/B

See espentech.com for CoreTech™ and VersaLinear™ specifications.



Field Adjustable LED Driver for Type-C LED's | Type C



TYPE - C

FEATURES AND BENEFITS

- Programmable Drive Current Range (300/600mA)
- For Use with 1 or 2 Espen CoreTech™ LED T5 or T8 Lamps
- Constant Current | 2 Channels
- Output Voltage: 20-46V DC
- Universal Voltage (120 - 277V)
- Dimmable
- Suitable for Damp Locations
- 5 Year Warranty



- Programmable Drive Current Range (300/360mA)
- For Use with 3 or 4 Espen CoreTech™ LED T5 or T8 Lamps
- Constant Current | 4 Channels
- Output Voltage: 20-46V DC
- Universal Voltage (120 - 277V)
- Dimmable
- Suitable for Damp Locations
- 5 Year Warranty



2 LAMP WIRING DIAGRAM

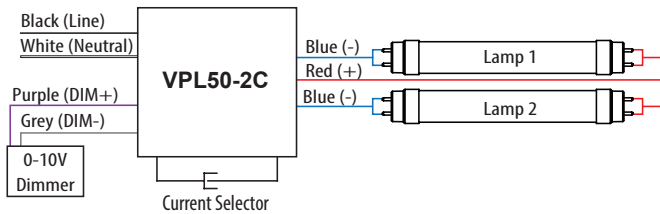

Current Selector Close = (300mA)

4 LAMP WIRING DIAGRAM

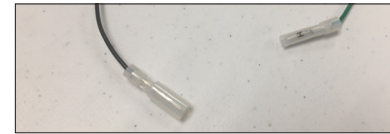
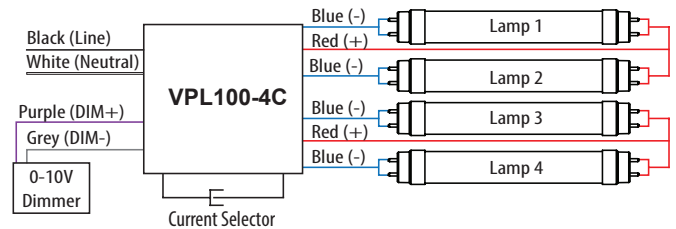

Current Selector Open = (360mA)

Model No.	Output Current	Driver Type	Max Wattage (W)	No. of Channels	Input Voltage (V)	Dimming
Programmable LED Driver						
VPL50-2C-030/036	Field Adjustable	Constant Current	33	2	120 - 277	0 -10V
VPL100-4C-030/036	Field Adjustable	Constant Current	66	4	120 - 277	0 -10V

See espentech.com for CoreTech™ and VersaLinear™ specifications.

# Emergency LED Driver

TYPE - C

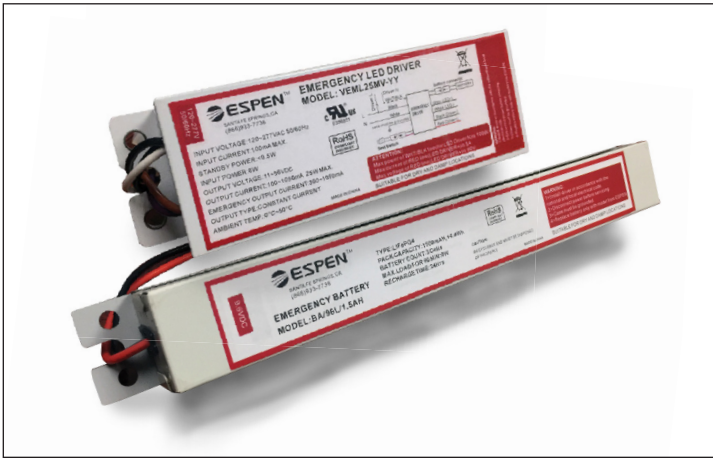

## FEATURES AND BENEFITS

- Constant light output
- Auto LED load sensing
- Universal Input (120-277V)
- Complete Thermal Solution
- Heavy duty battery
- Programmable for Lumen Output
- UL Recognized
- 5 Year Warranty



### Wiring Diagram:

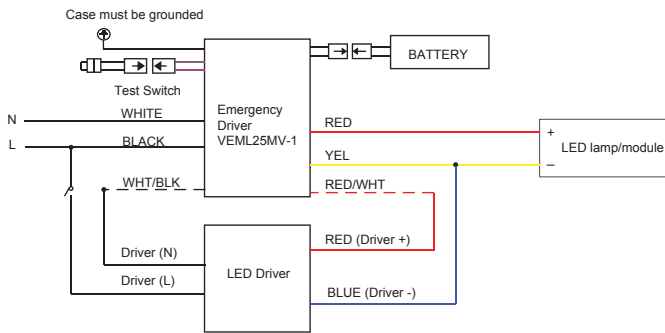

### Wattage Adjustment (dip switch):

Dip Switch Setting	Emergency Mode Output Power	Emergency Mode Output Voltage	Emergency Mode Output Current	Battery Charging Current
	5W	12-50V	416-100mA	60mA
	10W	12-50V	830-200mA	100mA
	15W	12-50V	1250-300mA	160mA
	20W (VEML20MV-1) 25W (VEML25MV-1)	12-50V	1400-400mA 2084-500mA	210mA 210mA

Model No.	Battery Package	Max Load for 90 Min
<b>Emergency LED Driver</b>		
VEML20MV-1	BA/96L/1.0AH5	W
	BA/96L/2.0AH	10W
	BA/96L/3.0AH	15W
	BA/96L/6.0AH	20W
VEML25MV-1	BA/96L/1.0AH5	W
	BA/96L/2.0AH	10W
	BA/96L/3.0AH	15W
	BA/96L/6.0AH	25W



### Model No.

### Description

EML25-PLATE

Emergency driver back plate  
Pre-wired and mounted  
emergency driver and battery  
unit in one plate.

# versaKIT™

LED Retrofit Kits | LED Retrofit Solutions



## Troffer Kit <sup>LED</sup>

LED Center Basket  
Available in 2' x 2' and 2' x 4' Sizes

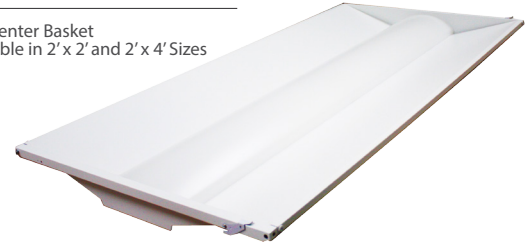

## versaLinear <sup>LED</sup>

Designed to Achieve High Lumen Output  
Each Kit Includes LED Modules Paired  
with an LED Driver

## emergency driver

90 Minute Illumination Time  
5 Year Warranty  
Universal Input (120-277V)



## Panel Kit <sup>LED</sup>

Ultra-Thin LED Panel  
Available in 2' x 2' and 2' x 4' Sizes



**versaKIT™**

RETROFIT KITS

## Channel Kit <sup>LED</sup>

High Efficiency LED Module & LED Driver  
Provides Uniform Ambient Lighting



## versaKIT Strips <sup>LED</sup>

Converts 8ft T12 or T8 Fluorescent  
Strip Lights to the latest 4ft LED Technology  
Holds Two Rows of Two LED T8 Lamps  
Compatible with Type-A, Type-B, & Type-C Lamps for Rebate Programs



### LED Retrofit Solutions

The VersaKit family includes more than 50 models of LED linear retrofit kits. Many of the VersaKit retrofit kits create the look of a completely new fixture, but without the labor of replacing the fixture. Utilizing the existing housing drops installation time to just minutes, and the ceiling doesn't need to be disturbed. The VersaKit retrofit kit family includes: Flat Panel Retrofit Kits, 8' Channel Retrofit Kits, LED Channel Retrofit Kits, and Troffer Retrofit Kits.

# versaKIT™ versaLinear™

LED Linear Module Retrofit Kits

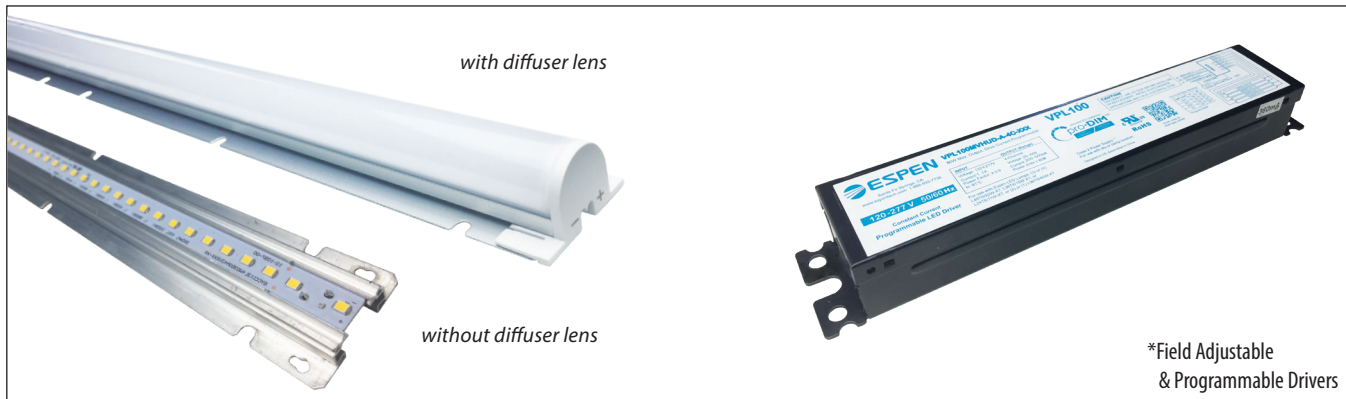

## FEATURES AND BENEFITS

- Designed to Achieve High Lumen Output
- Each Kit Includes LED Modules Paired with an LED Driver
- LED Modules Feature Durable Aluminium Structures
- Magnetic Backing for Easier Installation
- Available with Frosted Diffuser Lens or No Diffuser Lens
- Kits Retrofit 2, 3 and 4 foot T5 and T8 Fixtures
- -20° F to 130° F Ambient Operating Temperature
- End-to-End Lighting with No Dark Spots
- 120 - 277V Input Voltage
- 80+ CRI
- 50,000 Hours Life
- Dimmable
- 5 Year Warranty

RETROFIT KITS



### 2 LAMP WIRING DIAGRAM

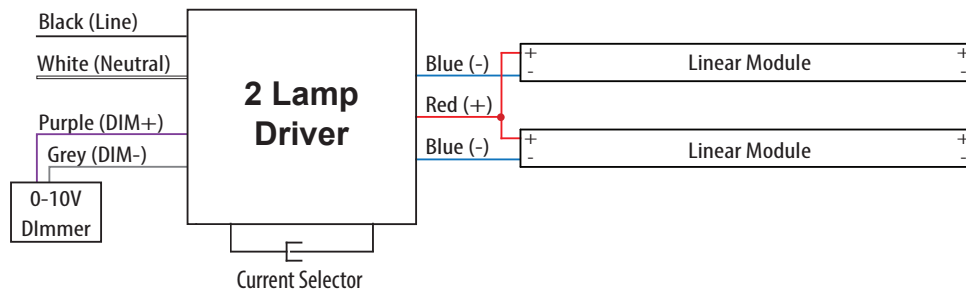

### 4 LAMP WIRING DIAGRAM

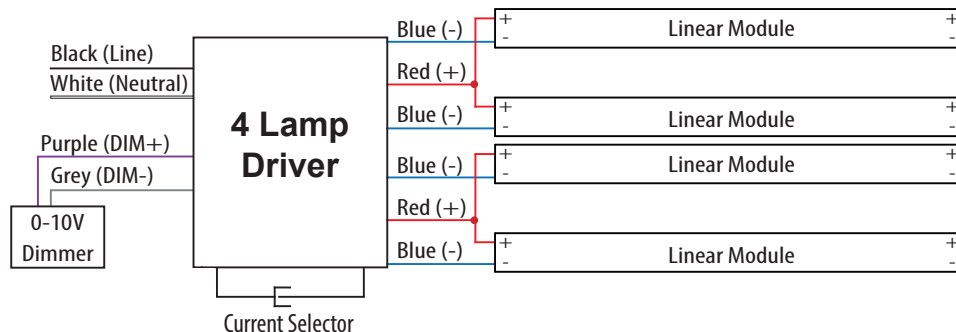

# versaKIT™ versaLinear™

## LED Linear Module Retrofit Kits

RETROFIT KITS

Espen Model No.	DLC Model No.	Replaces	Diffuser Lens	No. of Modules Included	Driver Included	Driver Current	System Power (W)	System Lumens (lm)	System Efficacy (lm/W)
<b>2 Foot HE - High Efficiency</b>									
VEKM-L21C/8XX <sup>1,2</sup>	D546-1M-302C	1 x F17T8	No	1	VPL50	High	12	1500	125
						Normal	10	1250	125
VEKM-L21F/8XX <sup>1,2</sup>	D546-1M-302F	1 x F17T8	Yes	1	VPL50	High	12	1250	104
						Normal	10	1050	105
VEKM-L22C/8XX <sup>1,2</sup>	D546-2M-302C	2 x F17T8	No	2	VPL50	High	24	3000	125
						Normal	20	2500	125
VEKM-L22F/8XX <sup>1,2</sup>	D546-2M-302F	2 x F17T8	Yes	2	VPL50	High	24	2550	105
						Normal	20	2100	105
VEKM-L23C/8XX <sup>1,2</sup>	D547-3M-302C	3 x F17T8	No	3	VPL100	High	34	4300	126
						Normal	28	3600	129
VEKM-L23F/8XX <sup>1,2</sup>	D547-3M-302F	3 x F17T8	Yes	3	VPL100	High	34	3550	104
						Normal	28	3000	107
VEKM-L24C/8XX <sup>1,2</sup>	D547-4M-302C	4 x F17T8	No	4	VPL100	High	43	5600	130
						Normal	36	4700	131
VEKM-L24F/8XX <sup>1,2</sup>	D547-4M-302F	4 x F17T8	Yes	4	VPL100	High	43	4600	107
						Normal	36	3900	108
<b>3 Foot HE - High Efficiency</b>									
VEKM-L31C/8XX <sup>1,2</sup>	D546-1M-303C	1 x F25T8	No	1	VPL50	High	16	2100	131
						Normal	13	1750	135
VEKM-L31F/8XX <sup>1,2</sup>	D546-1M-303F	1 x F25T8	Yes	1	VPL50	High	16	1700	106
						Normal	13	1400	108
VEKM-L32C/8XX <sup>1,2</sup>	D546-2M-303C	2 x F25T8	No	2	VPL50	High	32	4250	133
						Normal	26	3500	135
VEKM-L32F/8XX <sup>1,2</sup>	D546-2M-303F	2 x F25T8	Yes	2	VPL50	High	32	3400	106
						Normal	26	2800	108
VEKM-L33C/8XX <sup>1,2</sup>	D547-3M-303C	3 x F25T8	No	3	VPL100	High	46	6100	133
						Normal	38	5000	132
VEKM-L33F/8XX <sup>1,2</sup>	D547-3M-303F	3 x F25T8	Yes	3	VPL100	High	46	5050	110
						Normal	38	4200	111
VEKM-L34C/8XX <sup>1,2</sup>	D547-4M-303C	4 x F25T8	No	4	VPL100	High	60	8000	133
						Normal	50	6500	130
VEKM-L34F/8XX <sup>1,2</sup>	D547-4M-303F	4 x F25T8	Yes	4	VPL100	High	60	6500	108
						Normal	50	5400	108

<sup>1</sup> XX = 30, 35, 40 or 50  
 30 = 3000K, 35 = 3500K, 40 = 4000K and 50 = 5000K (3000K may be subject to lead times and availability.)  
<sup>2</sup> Not DLC listed. See 4 foot modules for DLC listed modules.

# versaKIT™ versaLinear™

## LED Linear Module Retrofit Kits

RETROFIT KITS

Espen Model No.	DLC Model No.	Replaces	Diffuser Lens	Quantity of Modules Included	Driver Included	Drive Current	System Power (W)	System Lumens (lm)	System Efficacy (lm/W)
<b>4 Foot HE - High Efficiency</b>									
VEKM-L41C/8XX <sup>1,2</sup>	D546-1M-304C	1 x F32T8	No	1	VPL50	High	18	2300	128
						Normal	14	1850	132
VEKM-L41F/8XX <sup>1,2</sup>	D546-1M-304F	1 x F32T8	Yes	1	VPL50	High	18	1850	103
						Normal	14	1550	111
VEKM-L42C/8XX <sup>1,3</sup>	D546-2M-304C	2 x F32T8	No	2	VPL50	High	35	4600	131
						Normal	27	3700	137
VEKM-L42F/8XX <sup>1,3</sup>	D546-2M-304F	2 x F32T8	Yes	2	VPL50	High	35	3900	111
						Normal	27	3100	115
VEKM-L43C/8XX <sup>1,2</sup>	D547-3M-304C	3 x F32T8	No	3	VPL100	High	50	6900	138
						Normal	39	5550	142
VEKM-L43F/8XX <sup>1,2</sup>	D547-3M-304F	3 x F32T8	Yes	3	VPL100	High	50	5850	117
						Normal	39	4600	118
VEKM-L44C/8XX <sup>1,4</sup>	D547-4M-304C	4 x F32T8	No	4	VPL100	High	65	9250	142
						Normal	51	7400	145
VEKM-L44F/8XX <sup>1,4</sup>	D547-4M-304F	4 x F32T8	Yes	4	VPL100	High	65	7800	120
						Normal	51	6150	121
<b>4 Foot HO - High Output</b>									
VEKM-L41C/HO/8XX <sup>1,2</sup>	D546-1M-304C/HO	1 x 4'HO	No	1	VPL50	Normal	26	4000	150
VEKM-L41F/HO/8XX <sup>1,2</sup>	D546-1M-304F/HO	1 x 4'HO	Yes	1	VPL50	Normal	26	3400	130
VEKM-L42C/HO/8XX <sup>1,2</sup>	D547-2M-304C/HO	2 x 4'HO	No	2	VPL100	Normal	52	8000	150
VEKM-L42F/HO/8XX <sup>1,2</sup>	D547-2M-304F/HO	2 x 4'HO	Yes	2	VPL100	Normal	52	6800	130
<b>4 Foot VHO - Very High Output</b>									
VEKM-L41C/VHO/8XX <sup>1,2</sup>	D547-1M-304C/VHO	1 x 4'VHO	No	1	VPL100	Normal	52	8200	155
VEKM-L41F/VHO/8XX <sup>1,2</sup>	D547-1M-304F/VHO	1 x 4'VHO	Yes	1	VPL100	Normal	52	7000	135

<sup>1</sup> XX = 30, 35, 40 or 50  
30 = 3000K, 35 = 3500K, 40 = 4000K and 50 = 5000K (3000K may be subject to lead times and availability.)  
<sup>2</sup> Not DLC listed. See 4 foot modules for DLC listed modules.

<sup>3</sup> DLC listed.  
<sup>4</sup> DLC pending.

# versaKIT™

## LED Flat Panel Retrofit Kits



### FEATURES AND BENEFITS

- Ultra-Thin LED Panel
- Utilizes Existing Housing to Reduce Installation Time and Cost of Labor
- Edge-Lit Technology for Even Ambient Lighting
- -20° F to 130° F Ambient Operating Temperature
- Available in 2' x 2' and 2' x 4' Sizes
- Installation Brackets Included (*as seen on page 32*)
- Dimmable (0-10V Dimming)
- UL Recognized
- 5 Year Warranty



### Installation Brackets

for versaKIT Panel & versaKIT Troffer



RETROFIT KITS

Model No.	Retrofits	Power (W)	Lumens (lm)	Efficacy (lm/W)	Voltage (V)	CCT (K)	CRI	Life (h)
<b>DLC Premium</b>								
VEKT-P2X2/830	2 x 2 Troffer	22	2750	125	120 - 277	3000 <sup>1</sup>	80+	50000
VEKT-P2X2/835	2 x 2 Troffer	22	2750	125	120 - 277	3500	80+	50000
VEKT-P2X2/840	2 x 2 Troffer	22	2750	125	120 - 277	4000	80+	50000
VEKT-P2X2/850	2 x 2 Troffer	22	2750	125	120 - 277	5000	80+	50000
VEKT-P2X4/830	2 x 4 Troffer	36	4500	125	120 - 277	3000 <sup>+</sup>	80+	50000
VEKT-P2X4/835	2 x 4 Troffer	36	4500	125	120 - 277	3500	80+	50000
VEKT-P2X4/840	2 x 4 Troffer	36	4500	125	120 - 277	4000	80+	50000
VEKT-P2X4/850	2 x 4 Troffer	36	4500	125	120 - 277	5000	80+	50000
<b>DLC Standard</b>								
VEKT-P2X2/830	2 x 2 Troffer	22	2200	100	120 - 277	3000 <sup>1</sup>	80+	50000
VEKT-P2X2/835	2 x 2 Troffer	22	2200	100	120 - 277	3500	80+	50000
VEKT-P2X2/840	2 x 2 Troffer	22	2200	100	120 - 277	4000	80+	50000
VEKT-P2X2/850	2 x 2 Troffer	22	2200	100	120 - 277	5000	80+	50000
VEKT-P2X4/830	2 x 4 Troffer	36	3600	100	120 - 277	3000 <sup>1</sup>	80+	50000
VEKT-P2X4/835	2 x 4 Troffer	36	3600	100	120 - 277	3500	80+	50000
VEKT-P2X4/840	2 x 4 Troffer	36	3600	100	120 - 277	4000	80+	50000
VEKT-P2X4/850	2 x 4 Troffer	36	3600	100	120 - 277	5000	80+	50000

<sup>1</sup> 3000K CCT may be subject to lead times and availability.



### FEATURES AND BENEFITS

- Central Basket Design
- Quick & Easy Installation
- Utilizes Existing Housing to Reduce Installation Time and Cost of Labor
- -20° F to 130° F Ambient Operating Temperature
- Center Diffuser Snaps in Place
- Reflective Surface for Uniform Distribution of Light
- Dimmable (0-10V Dimming)
- 5 Year Warranty



RETROFIT KITS

### Installation Brackets

for versaKIT Panel & versaKIT Troffer

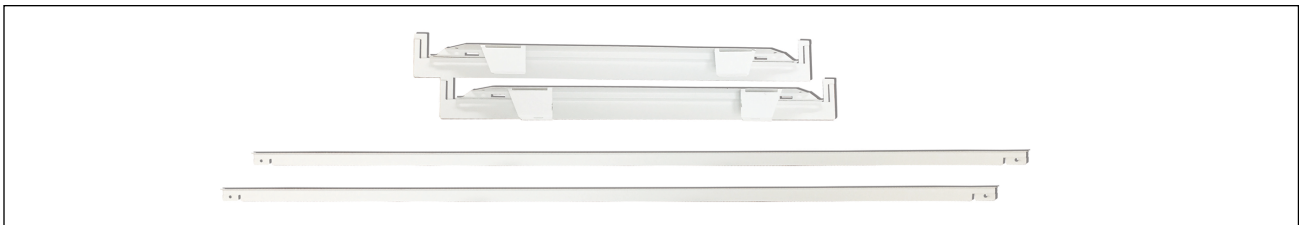

Model No.	Application	Power (W)	Lumens (lm)	Efficacy (lm/W)	Voltage (V)	CCT (K)	CRI	Life (h)
VEKT2X2H/830	2 X 2 Troffer	22	2750	125	120 - 277	3000 <sup>1</sup>	80+	50000
VEKT2X2H/835	2 X 2 Troffer	22	2750	125	120 - 277	3500	80+	50000
VEKT2X2H/840	2 X 2 Troffer	22	2750	125	120 - 277	4000	80+	50000
VEKT2X2H/850	2 X 2 Troffer	22	2750	125	120 - 277	5000	80+	50000
VEKT1X4L/830	1 x 4 Troffer	23	3000	130	120 - 277	3000 <sup>1</sup>	80+	50000
VEKT1X4L/835	1 x 4 Troffer	23	3000	130	120 - 277	3500	80+	50000
VEKT1X4L/840	1 x 4 Troffer	23	3000	130	120 - 277	4000	80+	50000
VEKT1X4L/850	1 x 4 Troffer	23	3000	130	120 - 277	5000	80+	50000
VEKT2X4/830/23	2 x 4 Troffer	23	2990	130	120 - 277	3000 <sup>1</sup>	80+	50000
VEKT2X4/835/23	2 x 4 Troffer	23	2990	130	120 - 277	3500	80+	50000
VEKT2X4/840/23	2 x 4 Troffer	23	2990	130	120 - 277	4000	80+	50000
VEKT2X4/850/23	2 x 4 Troffer	23	2990	130	120 - 277	5000	80+	50000
VEKT2X4L/830	2 X 4 Troffer	36	4500	125	120 - 277	3000 <sup>1</sup>	80+	50000
VEKT2X4L/835	2 X 4 Troffer	36	4500	125	120 - 277	3500	80+	50000
VEKT2X4L/840	2 X 4 Troffer	36	4500	125	120 - 277	4000	80+	50000
VEKT2X4L/850	2 X 4 Troffer	36	4500	125	120 - 277	5000	80+	50000

<sup>1</sup> 3000K CCT may be subject to lead times and availability.



# versaKIT™

## LED Center Basket 3-Level Troffer Retrofit Kits

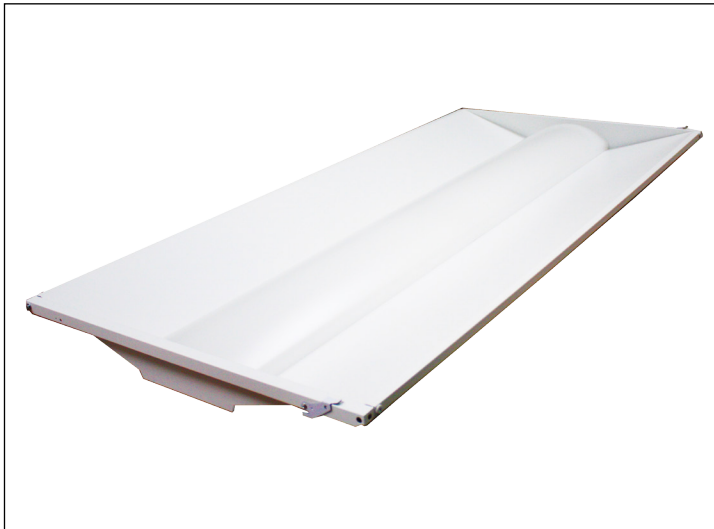

### FEATURES AND BENEFITS

- Central Basket Design
- Quick & Easy Installation
- 3-Level Selectable Current Setting
- Utilizes Existing Housing to Reduce Installation Time and Cost of Labor
- -20° F to 130° F Ambient Operating Temperature
- Center Diffuser Snaps in Place
- Reflective Surface for Uniform Distribution of Light
- Dimmable (0-10V Dimming), Dim-To-Off
- Dim-To-Off Optional



### Installation Brackets

versaKIT Troffer

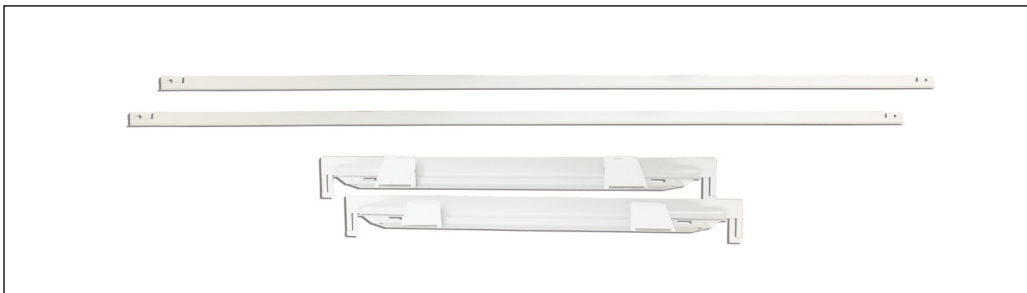

### Dial Settings

3-Level Current Settings

<b>VEKT2X2H</b>	390mA	<input type="checkbox"/>
	470mA	<input type="checkbox"/>
	540mA	<input type="checkbox"/>
<b>VEKT2X4L</b>	600mA	<input type="checkbox"/>
	670mA	<input type="checkbox"/>
	750mA	<input type="checkbox"/>

RETROFIT KITS

Model No.	Application	Current Setting	Power (W)	Lumens (lm)	Efficacy (lm/W)	Voltage (V)	CRI	Life (h)
<b>Troffer Retrofit Kit</b>								
VEKT2X2H-8XX (16W/19W/22W)	2 X 2	390mA	16	2000	125	120-277	80+	50000
	2 X 2	470mA	19	2350	125	120-277	80+	50000
	2 X 2	540mA	22	2750	125	120-277	80+	50000
VEKT2X4L-8XX (29W/32W/36W)	2 X 4	600mA	29	3625	125	120-277	80+	50000
	2 X 4	670mA	32	4000	125	120-277	80+	50000
	2 X 4	750mA	36	4500	125	120-277	80+	50000

<sup>1</sup> XX = 30, 35, 40 or 50  
30 = 3000K, 35 = 3500K, 40 = 4000K and 50 = 5000K (3000K may be subjected to lead times and availability)

# versaKIT™ Channel

## LED Channel Retrofit Kits



### FEATURES AND BENEFITS

- Utilizes Existing Housing to Reduce Installation Time and Cost of Labor
- Diffuser Lens Provides Uniform Ambient Lighting and Reduces Glare
- High Efficiency LED Module and LED Driver
- -20° F to 130° F Ambient Operating Temperature
- Dimmable (0-10V Dimming)
- Suitable for Damp Locations
- 5 Year Warranty



RETROFIT KITS

Model No.	Retrofits	Length (ft)	Power (W)	Lumens (lm)	Efficacy (lm/W)	Input Voltage (V)	CCT (K)	CRI	Life (h)
<b>For T8 or Slim Line Applications</b>									
VEKL4F/23-830	4' Channel	4	23	3000	130	120 - 277	3000 <sup>+</sup>	80+	50000
VEKL4F/23-835	4' Channel	4	23	3000	130	120 - 277	3500	80+	50000
VEKL4F/23-840	4' Channel	4	23	3000	130	120 - 277	4000	80+	50000
VEKL4F/23-850	4' Channel	4	23	3000	130	120 - 277	5000	80+	50000
VEKL8F/46-830	8' Channel	8	46	5980	130	120 - 277	3000 <sup>+</sup>	80+	50000
VEKL8F/46-835	8' Channel	8	46	5980	130	120 - 277	3500	80+	50000
VEKL8F/46-840	8' Channel	8	46	5980	130	120 - 277	4000	80+	50000
VEKL8F/46-850	8' Channel	8	46	5980	130	120 - 277	5000	80+	50000
<b>For HO or VHO Line Applications</b>									
VEKL4F/40-830	4' Channel	4	40	5240	131	120 - 277	3000 <sup>+</sup>	80+	50000
VEKL4F/40-835	4' Channel	4	40	5240	131	120 - 277	3500	80+	50000
VEKL4F/40-840	4' Channel	4	40	5240	131	120 - 277	4000	80+	50000
VEKL4F/40-850	4' Channel	4	40	5240	131	120 - 277	5000	80+	50000
VEKL8F/90-830	8' Channel	8	90	11440	127	120 - 277	3000 <sup>+</sup>	80+	50000
VEKL8F/90-835	8' Channel	8	90	11440	127	120 - 277	3500	80+	50000
VEKL8F/90-840	8' Channel	8	90	11440	127	120 - 277	4000	80+	50000
VEKL8F/90-850	8' Channel	8	90	11440	127	120 - 277	5000	80+	50000

+ 3000K CCT may be subject to lead times and availability.

# versaKIT™ Strip

## LED Strip Retrofit Kits



### FEATURES AND BENEFITS

- Converts 8 Foot T12 or T8 Fluorescent Strip Lights to the Latest 4 Foot LED Technology
- Holds Two Rows of Two LED T8 Lamps
- Compatible with Type A, B, & C Lamps for Rebate Programs
- Can Reduce Energy Costs Up to 50% While Still Maintaining Existing Light Levels
- 5 Year Warranty

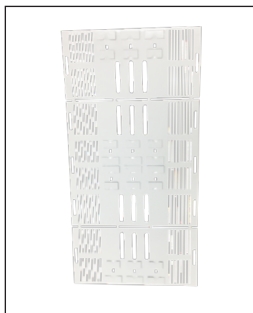

[1] Universal Socket Plate

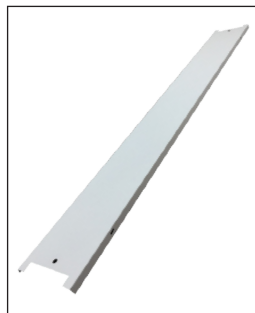

[2] Ballast Cover (white)



[8] Screws



[4] Quarter Turn Fasteners



[8] Sockets

RETROFIT KITS

Model No.	Socket Type	Case Qty.
<b>8 Foot Channel Retrofit Kits for Linear LED Lamps</b>		
RXS8-432-USP-WH/10 PACK	Shunted	10
RXS8(NS)-432-USP-WH/10 PACK	Non-Shunted	10

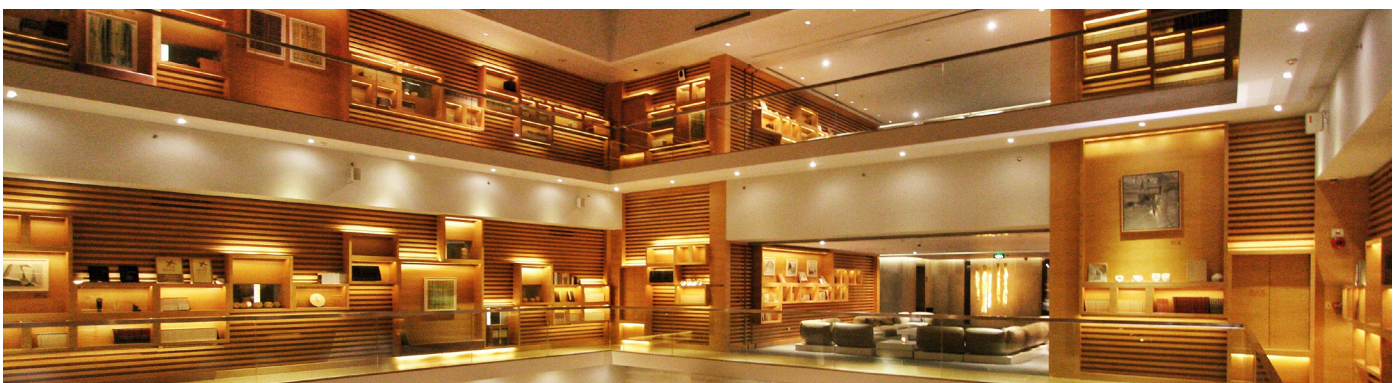

## Type A Emergency Ballasts

Long Life / 120-277V  
Heavy Duty Steel Housing



## Type B Emergency Inverters

90-Minute Illumination Time  
Durable Steel Housing



# Sentinel®

## Emergency Solutions For Type A, B, & C

## Type C Emergency Drivers

90-Minute Illumination Time  
Durable Steel Housing



## Emergency Back-Up Kits

Standalone Kits with LED Module  
90-Minute Illumination Time

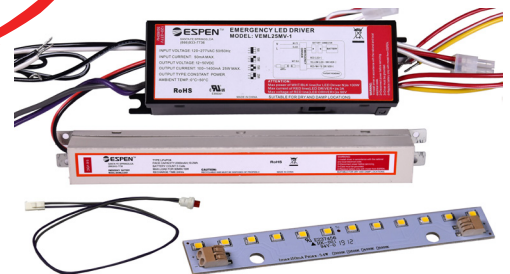

EMERGENCY SOLUTIONS

The Sentinel family of LED emergency ballasts, inverters, and drivers provide a complete set of emergency back up solutions for Types A, B, and C LED retrofit products. When AC power fails, Sentinel LED battery back up products switch to emergency mode and keep LED retrofit products illuminated at a reduced lumen output for a minimum of 90 minutes. The Sentinel emergency ballasts are for Type A lamps. The Sentinel emergency inverters are for Type B lamps. While the Sentinel emergency drivers are for Type C lamps, retrofit kits, and fixtures. Sentinel LED emergency back ups are suitable for use in new fixtures or retrofit applications, and most models include: LED charging indicator light, single-pole test switch, and installation hardware.

\*Please visit [www.espentech.com](http://www.espentech.com) for compatibility list.

# Sentinel®

## Emergency Back-Up Kits



### Constant Wattage LED

#### FEATURES AND BENEFITS

- Constant Wattage & Light Output
- High Efficacy LED Module
- Does not Affect Existing Lighting Fixture / Luminaire
- UL Listed

#### DIMENSIONS

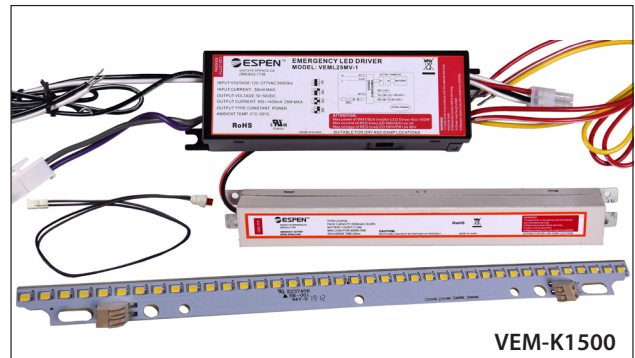
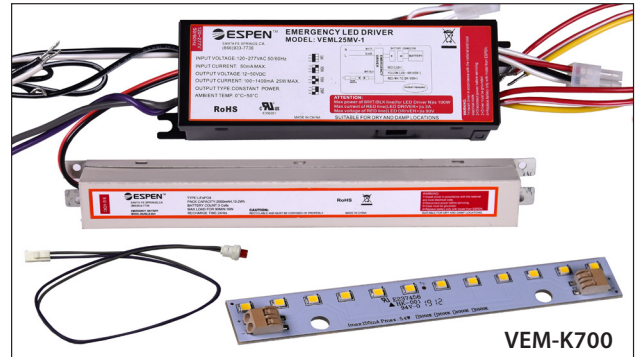
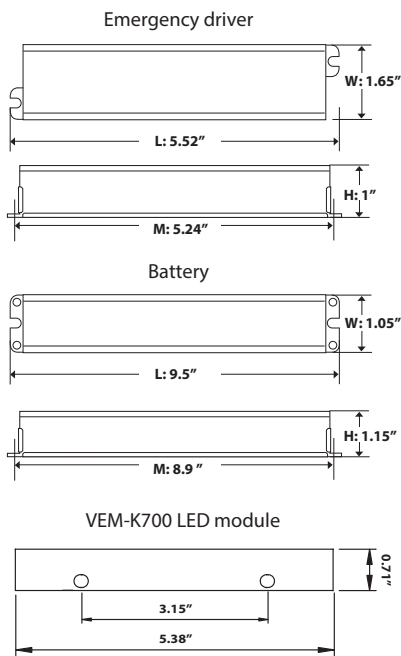

#### WIRING DIAGRAM

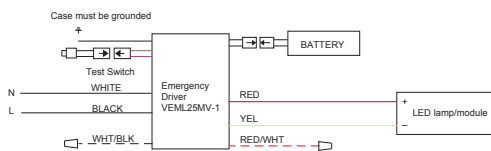

Model #	Dip Switch Setting	Emergency Mode Output Power	Emergency Mode Output Voltage	Emergency Mode Output Current	Battery Charging Current
VEM-K700		5W	12-50V	416-100mA	60mA
VEM-K1500		10W	12-50V	830-200mA	100mA

Model No.	Lumens (90min)	Wattage	Module Information
VEM-K700	700lm	5W	VLM0605L/850 5W, 5000K, CRI80
VEM-K1500	1500lm	10W	VLM1207L/850 10W, 5000K, CRI80

EMERGENCY SOLUTIONS

# Sentinel®



## TYPE A Emergency Ballasts for T5 and T8 Lamps

### FEATURES AND BENEFITS



500 Lumens

#### VEM500DV-L - Emergency Ballast

- Dual Input Voltage (120/277V)
- Maintenance Free, Long Life
- High Temperature Ni-Cad Battery
- Durable, Heavy-Duty Steel Housing
- 1-lamp: 500 lumens
- 5 Year Warranty



700 Lumens

#### VEM700DV-L - Emergency Ballast

- Dual Input Voltage (120/277V)
- Maintenance Free, Long Life
- High Temperature Ni-Cad Battery
- Durable, Heavy-Duty Steel Housing
- 1-lamp: 700 lumens | 2-lamp: 700 lumens
- 5 Year Warranty



800 Lumens

#### VEM800DV-L - Emergency Ballast

- Dual Input Voltage (120/277V)
- Maintenance Free, Long Life
- High Temperature Ni-Cad Battery
- Durable, Heavy-Duty Steel Housing
- 1-lamp: 800 lumens
- Slim Design
- 5 Year Warranty

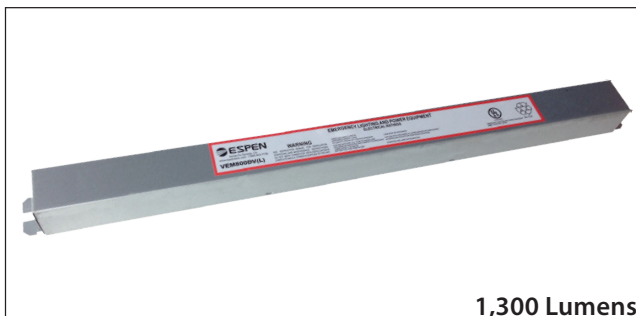

1,300 Lumens

#### VEM1300DV-L - Emergency Ballast

- Dual Input Voltage (120/277V)
- Maintenance Free, Long Life
- High Temperature Ni-Cad Battery
- Durable, Heavy-Duty Steel Housing
- 1-lamp: 1,300 lumens | 2-lamp: 1,300 lumens
- Slim Design
- 5 Year Warranty



EMERGENCY SOLUTIONS

Model No.	Type	Lumens	Voltage (V)	Operation Hours	Case
VEM500DV-L	Emergency Ballast	500	120/277	90 mins	Regular
VEM700DV-L	Emergency Ballast	700	120/277	90 mins	Regular
VEM800DV-L	Emergency Ballast	800	120/277	90 mins	Slim
VEM1300DV-L	Emergency Ballast	1300	120/277	90 mins	Slim

# Sentinel®

## TYPE B Emergency Inverters



VEMB20W  
20W

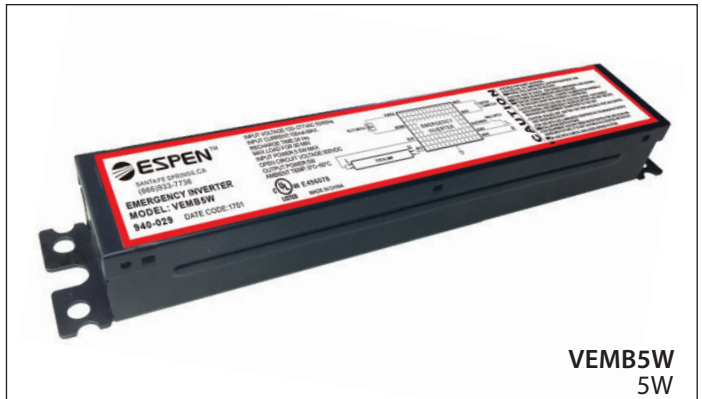

VEMB5W  
5W

### FEATURES AND BENEFITS

- Operates Espen Type B T5 & T8 LED Lamps
- Illuminates Most LEDs at Full Brightness, Up to 20W
- 32° F to 122° F Ambient Operating Temperature
- Durable Steel Housing Contains LED Driver & Battery
- Suitable for Damp Locations
- 90 Minute Illumination Time
- Nickel-Cadmium Rechargeable Battery
- LED Test Switch Included
- UL924, NFPA 101 Life Safety Code, NEC & OSHA Compliant
- 5 Year Warranty

### FEATURES AND BENEFITS

- Operates Espen Type B T5 & T8 LED Lamps
- Provides 5W of power for a minimum of 90 minutes
- 32° F to 122° F Ambient Operating Temperature
- Durable Steel Housing Contains LED Driver & Battery
- Suitable for Damp Locations
- Lithium-Ion Rechargeable Battery
- LED Test Switch Included
- UL924 & FCC Compliant
- 5 Year Warranty



### DIMENSIONS

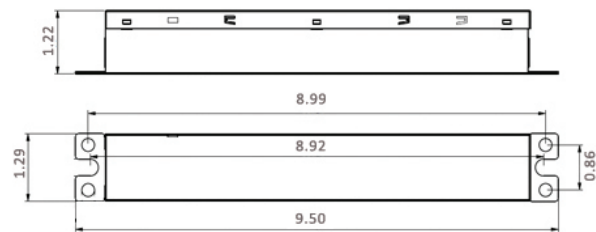
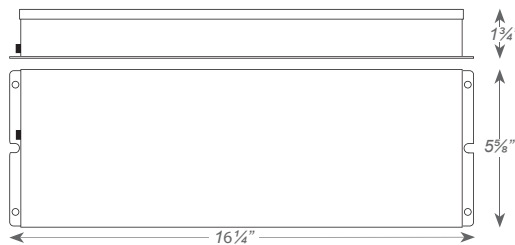

### WIRING DIAGRAM

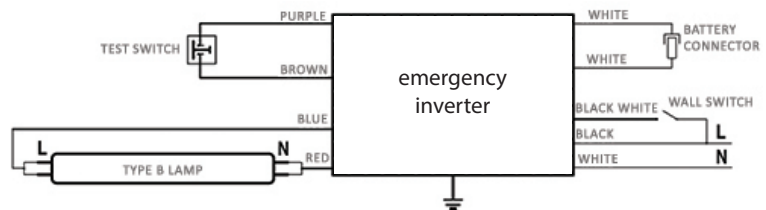
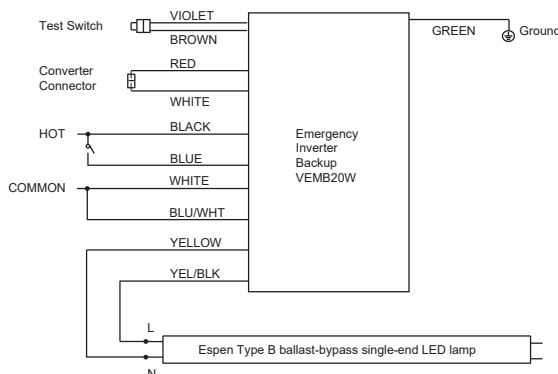

Model No.	Input Voltage (V)	Output Voltage (V)	Output Power (W)
<b>Type B Emergency LED Driver</b>			
VEMB20W+	120-277	OCV 320VDC	20
VEMB5W	120-277	OCV 300VDC	5

EMERGENCY SOLUTIONS

# Sentinel®



## Type C Emergency LED Driver

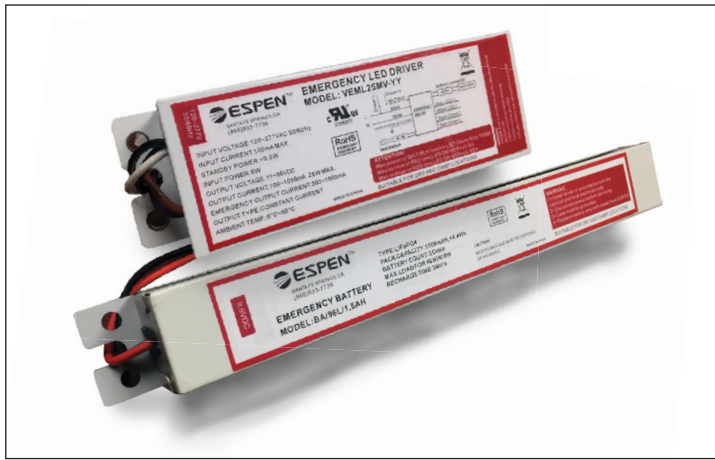

### FEATURES AND BENEFITS

- Constant light output
- Auto LED load sensing
- Universal Input (120-277V)
- Complete Thermal Solution
- Heavy duty battery
- Programmable for Lumen Output
- UL Recognized



### Wiring Diagram:

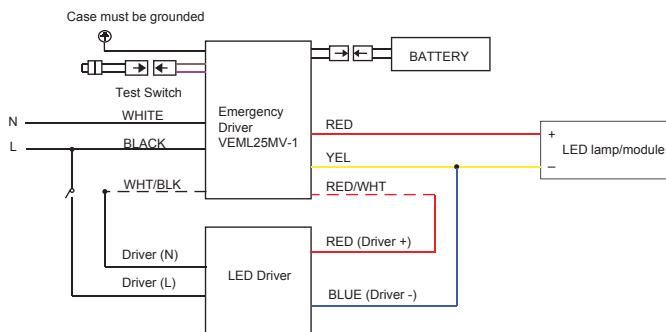

### Wattage Adjustment (dip switch):

Dip Switch Setting	Emergency Mode Output Power	Emergency Mode Output Voltage	Emergency Mode Output Current	Battery Charging Current
	5W	12-50V	416-100mA	60mA
	10W	12-50V	830-200mA	100mA
	15W	12-50V	1250-300mA	160mA
	20W (VEML20MV-1) 25W (VEML25MV-1)	12-50V	1400-400mA 2084-500mA	210mA

EMERGENCY SOLUTIONS

Model No.	Battery Package	Max Load for 90 Min
<b>Emergency LED Driver</b>		
VEML20MV-1	BA/96L/1.0AH5	W
	BA/96L/2.0AH	10W
	BA/96L/3.0AH	15W
	BA/96L/6.0AH	20W
VEML25MV-1	BA/96L/1.0AH5	W
	BA/96L/2.0AH	10W
	BA/96L/3.0AH	15W
	BA/96L/6.0AH	25W



### Model No.

### Description

EML25-PLATE

Emergency driver back plate  
Pre-wired and mounted  
emergency driver and battery  
unit in one plate.



# Step-Down Transformer

## Non-Isolated Autotransformer

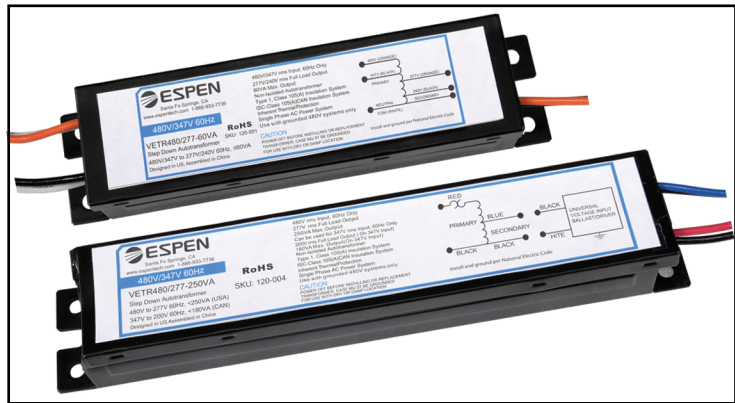

### PRODUCT FEATURES

- Non-isolated autotransformer
- UL listed
- Thermally protected (auto reset)
- Max case temperature 105C
- Sound rated A
- 5 year limited warranty
- Designed for lighting applications
- LED
- Electronic ballasts
- HID
- Low profile cases

### APPLICATION NOTES

- Supply current frequency 60Hz
- Do not use on ungrounded systems

Model Number	Input			Output		Physical Properties	
	Voltage	Current at Max Load	Power at Max Load	Output Voltage	Max Load (VA)	Case	Wiring Diagram
VETR480/277-60VA	480/347	0.125/0.172	66W	277/240	60	A	WD-1
VETR480/277-110VA	480/347	0.229/0.317	125W	277/240	110	B	WD-1
VETR480/277-250VA	480/347	0.520	275W	277/200	250/180	B	WD-2
VETR480/277-375VA	480/347	0.781	410W	277/200	375/270	C	WD-2

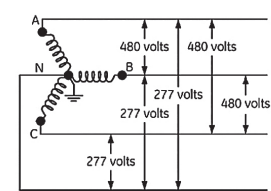

WYE

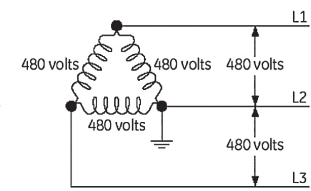

DELTA

### Why do we use VA instead of Watts when setting Step-Down Transformer loads?

The power in watts is the real power drawn by the equipment. Volt-Amps (VA) are called the "apparent power" and is the product of the voltage applied to the equipment times the current drawn by the equipment.

\*Use one of these formulas to determine the missing quantity:

Watts = VA \* Power factor or VA = Watts / Power Factor

\*For example to find VA of a 240W load with a .98PF is 240/.98 = 244VA for sizing your Step-Down Transformer

### PHYSICAL PARAMETERS

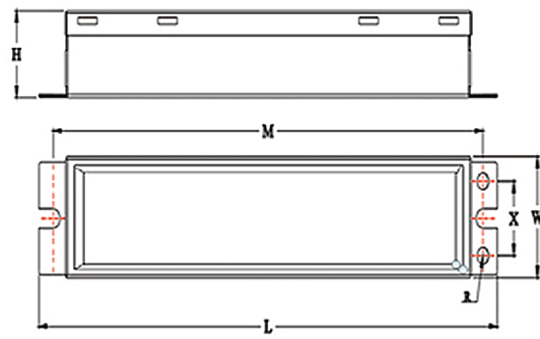

### CASE DIMENSIONS IN INCHES

Case	A	B	C
L	7.20	9.49	11.70
M	6.61	8.90	11.14
W	1.73	1.73	1.73
X	1.06	1.06	1.06
H	1.30	1.30	1.30
R	1.30	1.30	1.30
Lead Lengths	15"/16AWG	14"/16AWG	14"/16AWG

### WIRING DIAGRAMS

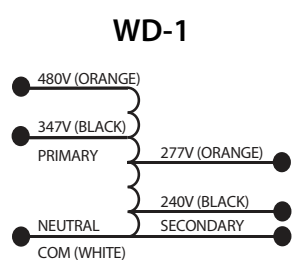

VETR480/277-60VA & VETR480/277-110VA  
Cap all unused wires

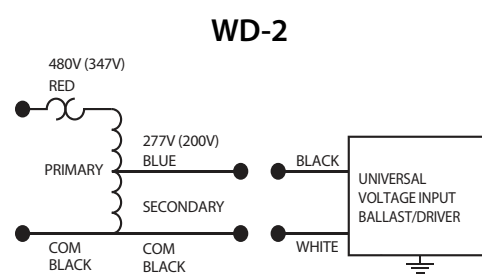

VETR480/277-250VA & VETR480/277-375VA

# Controls

## High Bay Sensors

### PRODUCT SPECIFICATIONS

#### OCCUPANCY SENSOR

#### 360° HIGH BAY PASSIVE INFRARED (PIR) FIXTURE MOUNT

#### FMH-6A-MV (UM)



FMH-6A-MV

L1 (Low bay)

L2 (High bay)

#### SPECIFICATIONS

Voltage:	120/277VAC, 60 Hz
Load Requirement:	800VA @120VAC* 1200VA @277VAC* * Fluorescent Ballasts No Min
Load Horsepower:	1/6HP
Time Delay Adjustment:	Fixed 15 seconds to 30 minutes
Operating Temperature:	32° to 131° F (0° to 55° C)
Humidity Range:	0% to 90% RH, non-condensing
Coverage Range:	High Bay mounting heights up to 30 ft mounting/360° field
Terminal Line:	Black - Hot, White - Neutral, Red - Load

The FMH-6A-MV (UM) Occupancy Sensor is designed to mount directly onto a luminaire and is ideal for high mounted areas such as warehouses, manufacturing facilities, and other high ceiling applications.

Other mounting options include: Ceiling mount, J-Box Mount

#### OPERATION

The sensor detects changes in the infrared energy given off by occupants as they move within the field-of-view. When occupancy is detected, a self-contained relay switches the connected lighting load on. The sensor is line powered and can switch line voltage. An internal timer, factory set at 15 seconds, keeps the lights on during brief periods of inactivity.

#### OPERATIONAL MODES

Auto ON, Auto OFF

#### COVERAGE AREA

Best choice for 15 to 30 ft mounting heights. 15 to 20 ft radial coverage overlaps area lit by a typical high bay fixture (refer to Fig. A)

#### TYPICAL APPLICATIONS

- Warehouses
- Gymnasiums
- Manufacturing Facilities
- Industrial Facilities

#### FEATURES

- PIR Occupancy Detection
- Self Contained Relay, no Power Pack needed
- Adjustable Time Delay: 15 sec - 30 mins
- Frequency: 50/60Hz
- UL, cUL
- CA Title 24 Compliant
- 5 Year Warranty

#### WIRING DIAGRAMS

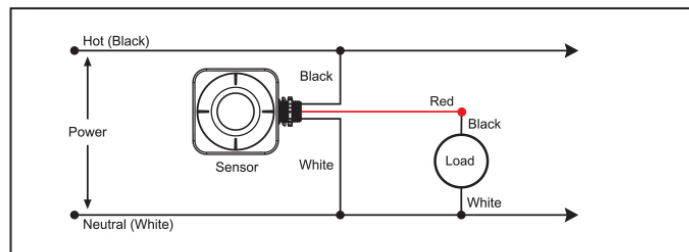

# Controls

## 0-10V Dimmers



### PRODUCT SPECIFICATION

#### GENERAL CHARACTERISTICS

<b>Switch Type VED1-10V</b>	<b>Single-Pole</b>
Switch	Standard ON/OFF
Dimmer	Slide
Voltage	120-277VAC, 50-60Hz
Load Rating	720VA
Load Type	Electronic 0-10VDC Fluorescent Ballast and 0-10VDC LED Power Supply

#### VED1-10V

Application	Single-Pole 0-10V dimmer
Color	White

#### VED3-10V

Application	3-Way 0-10V dimmer
Color	White

### FEATURES AND BENEFITS

- UL and cUL Listed for Safety
- Smooth Slide Dimming Control
- Full-range Dimming
- Min. and Max. Dimming Range Adjustable
- Operating Temperature: 32° to 104°
- Five Year Warranty

#### WIRING DIAGRAM: VED1-10V

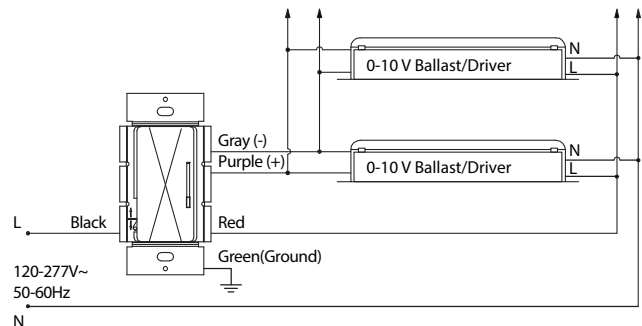

#### GENERAL CHARACTERISTICS

<b>Switch Type VED3-10V</b>	<b>3-WAY 0-10V Dimmer</b>
Switch	Standard ON/OFF
Dimmer	Slide
Voltage	120-277VAC, 50-60Hz
Load Rating	720VA
Load Type	Electronic 0-10VDC Fluorescent Ballast and 0-10VDC LED Power Supply

#### WIRING DIAGRAM: VED3-10V

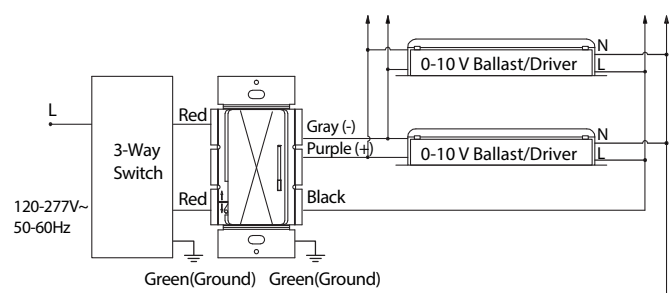

### DIMENSION LAYOUT

<b>DIMENSIONS</b>	
Length (inches)	<b>4.14</b>
Width (inches)	<b>2.13</b>
Depth (inches)	<b>1.66</b>

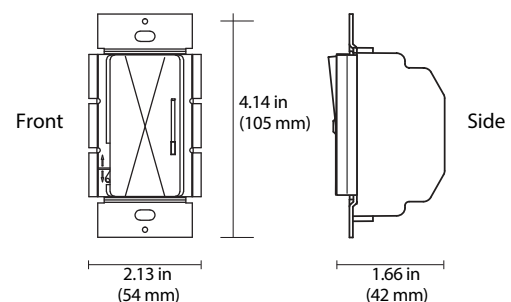

# Controls

## versaDim RF System

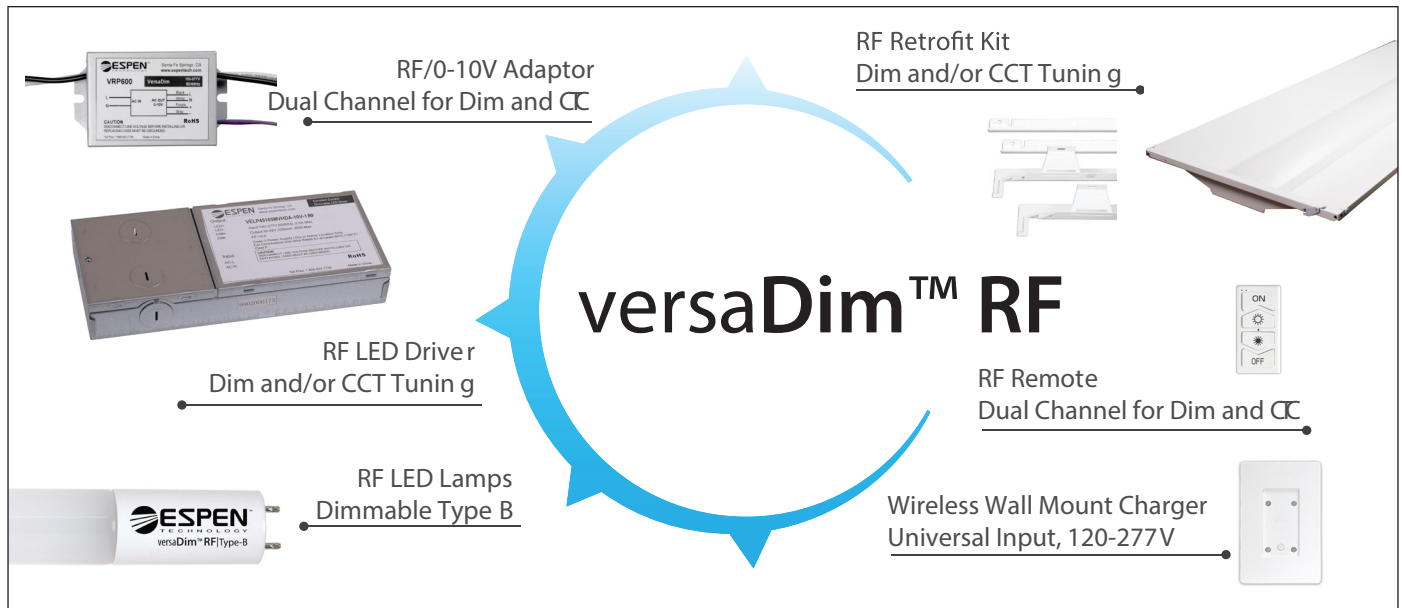

### FEATURES AND BENEFITS

- Dual Channel for Dimming and CCT Tuning
- Wall Mount Wireless Charger
- Adapter to Convert Current Fixtures to RF
- Dual Channel Drivers for New Fixtures
- Dimmable Type B Lamps
- Universal 120-277V Input
- Capable of Zoning Control
- Emergency Switch
- Highly Secure System
- UL Certified

### How it works

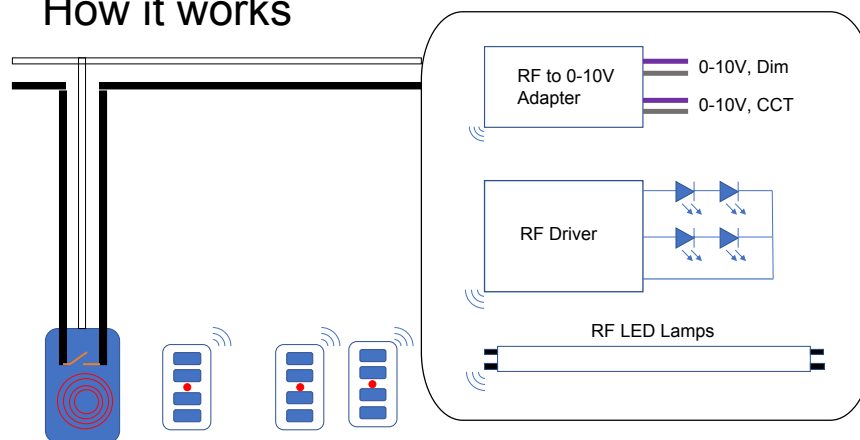

The versaDim™ RF System solves the problem of overly complex and expensive wireless controls. The system enables simple, low-cost dimming and CCT selection using a handheld RF remote. The remote has a wall dock that wirelessly recharges the remote.

THE  
POWER  
TO CREATE  
BETTER  
LIGHT







the Power to Create Better Light™

RETROFIT LIGHTING SOLUTIONS

**HEADQUARTERS**

Espen Technology Inc.  
12257 Florence Ave  
Santa Fe Springs, CA 90670, USA

**WAREHOUSE**

Espen Technology Inc.  
1350 Brookville Way, Suite F  
Indianapolis, IN 46239, USA

**SALES/CUSTOMER SERVICE**

Toll Free Tel.: (866) 933-7736  
Toll Free Fax: (888) 503-7736  
Tel.: (562) 529-2938  
Fax: (562) 529-2978

**CONNECT:**



[facebook.com/espentech](https://facebook.com/espentech)  
[twitter.com/espentech](https://twitter.com/espentech)  
[youtube.com/espentechnology](https://youtube.com/espentechnology)  
[linkedin.com/company/espen-technology](https://linkedin.com/company/espen-technology)  
[instagram.com/espentechnology](https://instagram.com/espentechnology)

**EMAIL**

[info@espentech.com](mailto:info@espentech.com)

**WEBSITE**

[www.espentech.com](http://www.espentech.com)

© 2019 Espen Technology, Inc.

All rights reserved. Reproduction in whole or part is prohibited without the prior written consent of the copyright owner. The information presented in this document does not form part of any quotation or contract, is believed to be accurate and reliable and may be changed without notice. No liability will be accepted by the publisher for any consequence of its use.

ESLED0419