

INTERNATIONAL TRANSFORMERS



Acme Electric's broad selection of
CSA energy efficient transformers



What is CSA C802.2 Compliant?

On January 1, 2005, the Canadian Energy Efficiency Act - Energy Efficiency Regulation (SOR/94-651) went into effect. The law mandates that certain 1-2 kV class dry-type distribution transformers meet the minimum efficiency guidelines outlined by CSA C802.2 -2002 efficiency standards.

More than 25 years ago Acme Electric envisioned the development of a transformer that provided customers maximum efficiency and cost effectiveness. Operating at a higher efficiency than standard transformers, the Acme Opti-Miser® dry-type distribution transformer could provide thousands of dollars in cost savings.

Acme Electric is proud to introduce its line of CSA C802.2 compliant transformers. These transformers are designed to not only meet, but also to exceed the stringent standards.

Acme Electric has a full line of CSA C802.2 compliant transformers to meet the needs and demands of our customers. Acme Electric offers one of the broadest CSA C802.2 compliant transformer lines in the industry, which includes General Purpose, Low Temperature Rise, K-Factor, and Copper Wound products.



**ENCAPSULATED****Single Phase, .05 to .150 kVA****Features**

- UL listed, CSA certified and UL-3R enclosure meets or exceeds all listing criteria including NEMA, ANSI and OSHA standards.
- Easy and convenient installation to meet your requirements, the transformer can be mounted in any position.
- Long Life UL class 130°C insulation system. Transformers can be banked for three phase service.
- Large wiring compartment, no conduit or pull boxes required. Front access for wiring ease. Wiring compartment remains cool.
- Completely enclosed UL-3R enclosure for indoor/outdoor service. Rugged non-ventilated construction.
- Plenty of knockouts for multi-directional entry.
- All copper lead wire terminations.
- Ground studs for use with non-metallic conduit.

ENCAPSULATED**Single Phase, .250 to 25 kVA**

- Installation keyhole mounting slots for mounting bolts prior to installation. Mounting slots are accessible from the front. Lifting ears are included on 3 to 25 kVA units.
- Wiring flexible copper leadwire terminations for easy connections outside the front access wiring compartment. Dual size knockouts in both sides and the bottom of the wiring compartment for greater wiring convenience and flexibility.

Features

- UL listed, CSA certified and UL-3R enclosures meets or exceeds all listing criteria including NEMA, ANSI and OSHA standards.
- Shielded for cleaner power.
- Encapsulated and completely enclosed design electrical grade silica and resin compounds completely enclose the core and coil to seal out all moisture and air. UL Type 3R enclosure for indoor or outdoor service. Encapsulation eliminates corrosion and insulation deterioration.
- Quiet operation with sound levels well below NEMA standards.
- Long life UL class 155°C insulation system. 115°C rise thru .750 kVA; 180°C insulation system, 115°C rise, 1 kVA and above.
- Available in 316 Stainless Steel



ENCAPSULATED

Three Phase, 3 to 75 kVA

Applications

- Harsh industrial locations
- Corrosive chemical exposure
- Waste water treatment facilities
- Coastal or marine applications with high salt mist
- Any application where painted cold roll steel is not adequate

Features

- UL listed, CSA certified and UL-3R enclosure meets or exceeds all listing criteria including NEMA, ANSI and OSHA standards.
- UL Class 180°C insulation system. 115°C rise.
- Extra large front access wiring compartment through 9 kVA; top access through 75 kVA for easier installation and cooler case temperatures.
- Completely enclosed — suitable for indoor/outdoor service. Consult selection charts for details. Excellent for dust or lint laden atmosphere.
- Encapsulated — electrical grade silica and resin compound completely encloses the core and coil. Encapsulation seals out all moisture and air, eliminating corrosion and insulation deterioration.
- High efficiency and excellent regulation.
- Sound levels below NEMA standards.
- Keyhole mounting slots permit installation of mounting bolts prior to hanging transformer and are accessible from the front. Lifting ears for easy installation.
- Wiring connections can be made outside of wiring compartment due to the use of flexible leads.
- 3-9 kVA provided with dual size knockouts in sides and bottom of wiring compartment.
- Termination — copper lead wire.
- Electrostatic shielding provided on all 60 Hz isolation transformers.
- Available in 316 Stainless Steel



VENTILATED**Single Phase 37.5 to 250 kVA, Three Phase 15 to 1000 kVA****Features**

- With weather shield, UL Type 3R enclosure or Type 2 enclosure without weather shield. UL listed and CSA certified.
- UL Class 220°C insulation system, 150°C rise.
- Extra large wiring compartment for easier installation and cooler case temperatures.
- NEMA standard bus bar terminals, no special tools needed to make clearly marked connections. Tap changing easily accomplished with jumpers.
- Aluminum windings for increased insulation life, cooler operation, lower losses.
- Noise and vibration isolating pads standard to assure quiet operation.
- Large permanently legible nameplates on front.
- Single phase units can be banked for 3 phase service.
- All units have ground studs for use with non-metallic conduit.
- Suitable for wall or "trapeze" mounting. Wall brackets are available for units up to 50 kVA single and 75 kVA three phase.
- Other models are available with class 220°C insulation and either 115°C or 80°C rise operating temperature.





SINGLE PHASE

120/208/240/277 PRIMARY VOLTS — 120/240 SECONDARY VOLTS — 1Ø, 60 Hz

kVA	Catalog Number	Height (Inches)(Cm.)	Width (Inches)(Cm.)	Depth (Inches)(Cm.)	Weight (Lbs.)(Kg.)	Mounting Type (Wall)(Floor)	Knockouts (Inches)(Cm.)	Weather Shield	Wiring Diagrams	Design Figures
1.0	T279740S	10.50 (26.7)	5.50 (14.0)	5.13 (13.0)	23 (10.4)	W	0.50-0.75 (1.3-1.9)	NA	23	B
1.5	T279741S	11.62 (29.5)	5.50 (14.0)	5.13 (13.0)	30 (13.6)	W	0.50-0.75 (1.3-1.9)	NA	23	B
2.0	T279742S	13.00 (33.0)	5.50 (14.0)	5.13 (13.0)	37 (16.8)	W	0.50-0.75 (1.3-1.9)	NA	23	B
3.0	T279743S	11.50 (29.2)	10.31 (26.2)	7.13 (18.1)	55 (24.9)	W	0.75-1.25 (1.9-3.2)	NA	23	C
5.0	T279744S	14.38 (36.5)	10.31 (26.2)	7.13 (18.1)	75 (34.0)	W	0.75-1.25 (1.9-3.2)	NA	23	C
7.5	T279745S	15.19 (38.6)	13.50 (34.3)	10.84 (27.5)	105 (47.6)	W	0.75-1.25 (1.9-3.2)	NA	63	D
10.0	T279746S	15.19 (38.6)	13.50 (34.3)	10.84 (27.5)	124 (56.2)	W	0.75-1.25 (1.9-3.2)	NA	63	D
15.0	T279747S	16.94 (43.0)	14.12 (35.9)	11.59 (29.4)	171 (77.6)	W	1.00-1.50 (2.5-3.8)	NA	63	D
25.0	T279748S	18.44 (46.8)	16.13 (41.0)	13.34 (33.9)	261 (118.4)	W	1.00-1.50 (2.5-3.8)	NA	63	D

190/200/208/220 X 380/400/416/440 PRIMARY VOLTS — 110/220 SECONDARY VOLTS — 1Ø, 50/60 Hz

EXPORT MODEL

kVA	Catalog Number	Height (Inches)(Cm.)	Width (Inches)(Cm.)	Depth (Inches)(Cm.)	Weight (Lbs.)(Kg.)	Mounting Type (Wall)(Floor)	Knockouts (Inches)(Cm.)	Weather Shield	Wiring Diagrams	Design Figures
*1.0	TF279300S	10.50 (26.7)	5.50 (14.0)	5.13 (13.0)	24 (10.9)	W	0.50-0.75 (1.3-1.9)	NA	65	B
*2.0	TF279301S	13.00 (33.0)	5.50 (14.0)	5.13 (13.0)	38 (17.2)	W	0.50-0.75 (1.3-1.9)	NA	65	B
*3.0	TF279302S	11.50 (29.2)	10.31 (26.2)	7.13 (18.1)	55 (24.9)	W	0.75-1.25 (1.9-3.2)	NA	65	C
*5.0	TF279303S	14.38 (36.5)	10.31 (26.2)	7.13 (18.1)	75 (34.0)	W	0.75-1.25 (1.9-3.2)	NA	65	C
*7.5	TF279304S	15.19 (38.6)	13.50 (34.3)	10.84 (27.5)	115 (52.2)	W	0.75-1.25 (1.9-3.2)	NA	65	D

*CE Marked

190/200/208/220 X 380/400/416/440 PRIMARY VOLTS — 120/240 SECONDARY VOLTS — 1Ø, 50/60 Hz

EXPORT MODEL

kVA	Catalog Number	Height (Inches)(Cm.)	Width (Inches)(Cm.)	Depth (Inches)(Cm.)	Weight (Lbs.)(Kg.)	Mounting Type (Wall)(Floor)	Knockouts (Inches)(Cm.)	Weather Shield	Wiring Diagrams	Design Figures
*1.0	TF217437S	10.50 (26.7)	5.50 (14.0)	5.13 (13.0)	24 (10.9)	W	0.50-0.75 (1.3-1.9)	NA	14	B
*2.0	TF217439S	13.00 (33.0)	5.50 (14.0)	5.13 (13.0)	38 (17.2)	W	0.50-0.75 (1.3-1.9)	NA	14	B
*3.0	TF249873S	11.50 (29.2)	10.31 (26.2)	7.13 (18.1)	55 (24.9)	W	0.75-1.25 (1.9-3.2)	NA	14	C
*5.0	TF252520S	14.38 (36.5)	10.31 (26.2)	7.13 (18.1)	75 (34.0)	W	0.75-1.25 (1.9-3.2)	NA	14	C
*7.5	TF252794S	15.19 (38.6)	13.50 (34.3)	10.84 (27.5)	115 (52.2)	W	0.75-1.25 (1.9-3.2)	NA	14	D
*10.0	TF252795S	15.19 (38.6)	13.50 (34.3)	10.84 (27.5)	125 (56.7)	W	0.75-1.25 (1.9-3.2)	NA	14	D
*15.0	TF252796S	16.94 (43.0)	14.12 (35.9)	11.59 (29.4)	170 (77.1)	W	1.00-1.50 (2.5-3.8)	NA	14	D
*25.0	TF252797S	18.44 (46.8)	16.13 (41.0)	13.34 (33.9)	300 (136.0)	W	1.00-1.50 (2.5-3.8)	NA	14	D

*CE Marked



190/208/220/240 X 380/416/440/480 PRIMARY VOLTS — 120/240 SECONDARY VOLTS — 1Ø, 50/60 Hz

EXPORT MODEL

kVA	Catalog Number	Height (Inches)(Cm.)	Width (Inches)(Cm.)	Depth (Inches)(Cm.)	Weight (Lbs.)(Kg.)	Mounting Type (Wall)(Floor)	Knockouts (Inches)(Cm.)	Weather Shield	Wiring Diagrams	Design Figures
*1.0	TF279260S	10.50 (26.7)	5.50 (14.0)	5.13 (13.0)	24 (10.9)	W	0.50-0.75 (1.3-1.9)	NA	64	B
*2.0	TF279261S	13.00 (33.0)	5.50 (14.0)	5.13 (13.0)	38 (17.2)	W	0.50-0.75 (1.3-1.9)	NA	64	B
*3.0	TF279262S	11.50 (29.2)	10.31 (26.2)	7.13 (18.1)	55 (24.9)	W	0.75-1.25 (1.9-3.2)	NA	64	C
*5.0	TF279263S	14.38 (36.5)	10.31 (26.2)	7.13 (18.1)	75 (34.0)	W	0.75-1.25 (1.9-3.2)	NA	64	C
*7.5	TF279264S	15.19 (38.6)	13.50 (34.3)	10.84 (27.5)	115 (52.2)	W	0.75-1.25 (1.9-3.2)	NA	64	D
*10.0	TF279265S	15.19 (38.6)	13.50 (34.3)	10.84 (27.5)	125 (56.7)	W	0.75-1.25 (1.9-3.2)	NA	64	D
*15.0	TF279266S	16.94 (43.0)	14.12 (35.9)	11.59 (29.4)	170 (77.1)	W	1.00-1.50 (2.5-3.8)	NA	64	D
*25.0	TF279267S	18.44 (46.8)	16.13 (41.0)	13.34 (33.9)	300 (136.1)	W	1.00-1.50 (2.5-3.8)	NA	64	D

*CE Marked

208 PRIMARY VOLTS — 120/240 SECONDARY VOLTS — THREE WINDINGS — 1Ø, 60 Hz

kVA	Catalog Number	Height (Inches)(Cm.)	Width (Inches)(Cm.)	Depth (Inches)(Cm.)	Weight (Lbs.)(Kg.)	Mounting Type (Wall)(Floor)	Knockouts (Inches)(Cm.)	Weather Shield	Wiring Diagrams	Design Figures
37.5	TI536491S	25.50 (64.8)	24.40 (62.0)	19.40 (49.3)	257 (117.0)	F	N/A	WSA1	58	E
50.0	TI536503S	25.50 (64.8)	24.40 (62.0)	19.40 (49.3)	340 (154.2)	F	N/A	WSA1	17	E
75.0	TI536513S	35.40 (89.9)	31.90 (81.0)	26.88 (68.2)	420 (190.5)	F	N/A	WSA3	17	E

240 PRIMARY VOLTS — 120/240 SECONDARY VOLTS — 1Ø, 60 Hz

AUTO-TRANSFORMERS

kVA	Catalog Number	Height (Inches)(Cm.)	Width (Inches)(Cm.)	Depth (Inches)(Cm.)	Weight (Lbs.)(Kg.)	Mounting Type (Wall)(Floor)	Knockouts (Inches)(Cm.)	Weather Shield	Wiring Diagrams	Design Figures
1.0	T253060	9.06 (23.0)	4.37 (11.1)	4.20 (10.7)	15 (6.8)	W	0.50-0.75 (1.3-1.9)	NA	12	B
1.5	T253061	9.68 (24.6)	4.50 (11.4)	4.51 (11.5)	19 (8.6)	W	0.50-0.75 (1.3-1.9)	NA	12	B
2.0	T253062	10.50 (26.7)	5.50 (14.0)	5.13 (13.0)	24 (10.9)	W	0.50-0.75 (1.3-1.9)	NA	12	B
3.0	T253063	11.62 (29.5)	5.50 (14.0)	5.13 (13.0)	30 (13.6)	W	0.50-0.75 (1.3-1.9)	NA	12	B
5.0	T253064	13.00 (33.0)	5.50 (14.0)	5.13 (13.0)	38 (17.2)	W	0.50-0.75 (1.3-1.9)	NA	12	B
7.5	T253065	11.50 (29.2)	10.31 (26.2)	7.13 (18.1)	55 (24.9)	W	0.75-1.25 (1.9-3.2)	NA	12	C
10.0	T253066	15.19 (38.6)	13.50 (34.3)	10.84 (27.5)	115 (52.2)	W	0.75-1.25 (1.9-3.2)	NA	12	D
15.0	T253067	15.19 (38.6)	13.50 (34.3)	10.84 (27.5)	115 (52.2)	W	0.75-1.25 (1.9-3.2)	NA	12	D



240 X 480 PRIMARY VOLTS — 120/240 SECONDARY VOLTS — FOUR WINDINGS — 1Ø, 60 Hz

kVA	Catalog Number	Height (Inches)(Cm.)	Width (Inches)(Cm.)	Depth (Inches)(Cm.)	Weight (Lbs.)(Kg.)	Mounting Type (Wall)(Floor)	Knockouts (Inches)(Cm.)	Weather Shield	Wiring Diagrams	Design Figures
.05	T153004	6.41 (16.3)	3.14 (8.0)	3.05 (7.7)	4 (1.8)	W	0.875 (2.2)	NA	1	A
.10	T153005	7.16 (18.2)	3.89 (9.9)	3.67 (9.3)	5 (2.3)	W	0.875 (2.2)	NA	1	A
.15	T153006	7.16 (18.2)	3.89 (9.9)	3.67 (9.3)	7 (3.2)	W	0.875 (2.2)	NA	1	A
.25	T253007S	8.68 (22.0)	4.08 (10.4)	3.88 (9.9)	10 (4.5)	W	0.50-0.75 (1.3-1.9)	NA	2	B
.50	T253008S	9.06 (23.0)	4.37 (11.1)	4.20 (10.7)	15 (6.8)	W	0.50-0.75 (1.3-1.9)	NA	2	B
.75	T253009S	9.68 (24.6)	4.75 (12.1)	4.50 (11.4)	19 (8.6)	W	0.50-0.75 (1.3-1.9)	NA	2	B
1.00	T253010S	10.50 (26.7)	5.50 (14.0)	5.13 (13.0)	24 (10.9)	W	0.50-0.75 (1.3-1.9)	NA	2	B
1.50	T253011S	11.62 (29.5)	5.50 (14.0)	5.13 (13.0)	30 (13.6)	W	0.50-0.75 (1.3-1.9)	NA	2	B
2.00	T253012S	13.00 (33.0)	5.50 (14.0)	5.13 (13.0)	38 (17.2)	W	0.50-0.75 (1.3-1.9)	NA	2	B
3.00	T253013S	11.50 (29.2)	10.31 (26.2)	7.13 (18.1)	55 (24.9)	W	0.75-1.25 (1.9-3.2)	NA	2	C
3.00	T2530134S	11.50 (29.2)	10.31 (26.2)	7.13 (18.1)	55 (24.9)	W	0.75-1.25 (1.9-3.2)	NA	3	C
5.00	T253014S	14.38 (36.5)	10.31 (26.2)	7.13 (18.1)	75 (34.0)	W	0.75-1.25 (1.9-3.2)	NA	2	C
5.00	T2530144S	14.38 (36.5)	10.31 (26.2)	7.13 (18.1)	75 (34.0)	W	0.75-1.25 (1.9-3.2)	NA	3	C
7.50	T2535153S	15.19 (38.6)	13.50 (34.3)	10.84 (27.5)	115 (52.2)	W	0.75-1.25 (1.9-3.2)	NA	4	D
10.00	T2535163S	15.19 (38.6)	13.50 (34.3)	10.84 (27.5)	125 (56.7)	W	0.75-1.25 (1.9-3.2)	NA	4	D
15.00	T2535173S	16.94 (43.0)	14.12 (35.9)	11.59 (29.4)	170 (77.1)	W	1.00-1.50 (2.5-3.8)	NA	4	D
25.00	T2535183S	18.44 (46.8)	16.13 (41.0)	13.34 (33.9)	250 (113.0)	W	1.00-1.50 (2.5-3.8)	NA	4	D
37.50	Ti530193S	25.50 (64.8)	24.39 (61.9)	19.37 (49.2)	280 (127.0)	F	NA	WSA1	5	E
50.00	Ti530203S	25.50 (64.8)	24.39 (61.9)	19.37 (49.2)	350 (158.8)	F	NA	WSA1	5	E
75.00	Ti530213S	35.47 (90.1)	31.90 (81.0)	26.88 (68.3)	430 (195.0)	F	NA	WSA3	5	E
100.00	Ti530223S	41.52 (105.4)	32.90 (83.5)	29.87 (75.9)	525 (238.0)	F	NA	WSA4	5	E
167.00	Ti530233S	45.60 (115.8)	39.50 (100.3)	35.50 (90.1)	1050 (476.3)	F	NA	WSA5	5	E
250.00	Ti530243S	45.60 (115.8)	39.50 (100.3)	35.50 (90.1)	1440 (653.2)	F	NA	WSA5	5	E

Notes: 0.05 through 25.0 kVA encapsulated (exempt from C802.2), 37.5 through 250.0 kVA C802.2 compliant

240 X 480 PRIMARY VOLTS — 120/240 SECONDARY VOLTS — FOUR WINDINGS — 1Ø, 60 Hz

316 STAINLESS STEEL

kVA	Catalog Number	Height (Inches)(Cm.)	Width (Inches)(Cm.)	Depth (Inches)(Cm.)	Weight (Lbs.)(Kg.)	Mounting Type (Wall)(Floor)	Knockouts (Inches)(Cm.)	Weather Shield	Wiring Diagrams	Design Figures
0.25	T253007SS	8.68 (22.0)	4.08 (10.4)	3.88 (9.9)	10 (4.5)	W	NA	NA	2	B
0.50	T253008SS	9.06 (23.0)	4.37 (11.1)	4.20 (10.7)	15 (6.8)	W	NA	NA	2	B
0.75	T253009SS	9.68 (24.6)	4.75 (12.1)	4.50 (11.4)	19 (8.6)	W	NA	NA	2	B
1.00	T253010SS	10.50 (26.7)	5.50 (14.0)	5.13 (13.0)	24 (10.9)	W	NA	NA	2	B
1.50	T253011SS	11.62 (29.5)	5.50 (14.0)	5.13 (13.0)	30 (13.6)	W	NA	NA	2	B
2.00	T253012SS	13.00 (33.0)	5.50 (14.0)	5.13 (13.0)	38 (17.2)	W	NA	NA	2	B
3.00	T253013SS	11.50 (29.2)	10.31 (26.2)	7.13 (18.1)	55 (24.9)	W	NA	NA	3	C
5.00	T253014SS	14.38 (36.5)	10.31 (26.2)	7.13 (18.1)	75 (34.0)	W	NA	NA	3	C
7.50	T253515SS	15.19 (38.6)	13.50 (34.3)	10.84 (27.5)	115 (52.2)	W	NA	NA	4	D
10.00	T253516SS	15.19 (38.6)	13.50 (34.3)	10.84 (27.5)	125 (56.7)	W	NA	NA	4	D
15.00	T253517SS	16.94 (43.0)	14.12 (35.9)	11.59 (29.4)	170 (77.1)	W	NA	NA	4	D
25.00	T253518SS	18.44 (46.8)	16.13 (41.0)	13.34 (33.9)	250 (113.0)	W	NA	NA	4	D



240 X 480 PRIMARY VOLTS — COPPER WINDINGS — 120/240 SECONDARY VOLTS — FOUR WINDINGS — 1Ø, 60 Hz

kVA	Catalog Number	Height (Inches)(Cm.)	Width (Inches)(Cm.)	Depth (Inches)(Cm.)	Weight (Lbs.)(Kg.)	Mounting Type (Wall)(Floor)	Knockouts (Inches)(Cm.)	Weather Shield	Wiring Diagrams	Design Figures
7.50	TC535153S	15.19 (38.6)	13.50 (34.3)	10.84 (27.5)	100 (45.4)	W	0.75-1.25 (1.9-3.2)	NA	4	D
10.00	TC535163S	15.19 (38.6)	13.50 (34.3)	10.84 (27.5)	120 (54.4)	W	0.75-1.25 (1.9-3.2)	NA	4	D
15.00	TC535173S	16.94 (43.0)	14.12 (35.9)	11.59 (29.4)	160 (72.6)	W	1.00-1.50 (2.5-3.8)	NA	4	D
25.00	TC535183S	18.44 (46.8)	16.13 (41.0)	13.34 (33.9)	250 (113.0)	W	1.00-1.50 (2.5-3.8)	NA	4	D
37.50	TIC530193S	25.50 (64.8)	24.39 (61.9)	19.37 (49.2)	295 (133.8)	F	NA	WSA1	5	E
50.00	TIC530203S	25.50 (64.8)	24.39 (61.9)	19.37 (49.2)	378 (172.0)	F	NA	WSA1	5	E

Notes: 7.5 through 25.0 kVA encapsulated (exempt from C802.2), 37.5 through 50.0 kVA C802.2 compliant

NON-VENTILATED TRANSFORMERS — 240 X 480 PRIMARY VOLTS — 120/240 SECONDARY VOLTS — FOUR WINDINGS — 1Ø, 60 Hz

kVA	Catalog Number	Height (Inches)(Cm.)	Width (Inches)(Cm.)	Depth (Inches)(Cm.)	Weight (Lbs.)(Kg.)	Mounting Type (Wall)(Floor)	Knockouts (Inches)(Cm.)	Weather Shield	Wiring Diagrams	Design Figures
37.50	TE2530193S	35.47 (90.1)	31.90 (81.0)	26.90 (68.3)	430 (195.0)	F	NA	NA	5	H
50.00	TE2530203S	35.47 (90.1)	31.90 (81.0)	26.90 (68.3)	430 (195.0)	F	NA	NA	5	H
75.00	TE2A530213S	35.47 (90.1)	31.90 (81.0)	26.90 (68.3)	525 (238.0)	F	NA	NA	5	H
100.00	TE1530223S	42.00 (106.7)	40.00 (101.6)	30.00 (76.2)	775 (352.0)	F	NA	NA	5	H

Notes: 37.5 through 100.0 kVA non-ventilated (exempt from C802.2)





277/480 PRIMARY VOLTS — 208/277 SECONDARY VOLTS — 1Ø, 60 Hz

kVA	Catalog Number	Height (Inches)(Cm.)	Width (Inches)(Cm.)	Depth (Inches)(Cm.)	Weight (Lbs.)(Kg.)	Mounting Type (Wall)(Floor)	Knockouts (Inches)(Cm.)	Weather Shield	Wiring Diagrams	Design Figures
0.25	GP12250S	8.68 (22.0)	4.08 (10.4)	3.88 (9.9)	12 (5.4)	W	0.50-0.75 (1.3-1.9)	NA	78	B
0.50	GP12500S	9.06 (23.0)	4.37 (11.1)	4.20 (10.7)	19 (8.6)	W	0.50-0.75 (1.3-1.9)	NA	78	B
1.00	GP121000S	10.50 (26.7)	5.50 (14.0)	5.13 (13.0)	30 (13.6)	W	0.50-0.75 (1.3-1.9)	NA	78	B
3.00	GP123000S	11.50 (29.2)	10.31 (26.2)	7.13 (18.1)	58 (26.3)	W	0.75-1.25 (1.9-3.2)	NA	78	C
5.00	GP125000S	14.38 (36.5)	10.31 (26.2)	7.13 (18.1)	80 (36.3)	W	0.75-1.25 (1.9-3.2)	NA	78	C
10.00	GP1210000S	15.19 (38.6)	13.50 (34.3)	10.84 (27.5)	125 (56.7)	W	0.75-1.25 (1.9-3.2)	NA	78	D
15.00	GP1215000S	16.94 (43.0)	14.12 (35.9)	11.59 (29.4)	161 (70.0)	W	1.00-1.50 (2.5-3.8)	NA	79	D

600 PRIMARY VOLTS — 120/240 SECONDARY VOLTS — THREE WINDINGS — 1Ø, 60 Hz

kVA	Catalog Number	Height (Inches)(Cm.)	Width (Inches)(Cm.)	Depth (Inches)(Cm.)	Weight (Lbs.)(Kg.)	Mounting Type (Wall)(Floor)	Knockouts (Inches)(Cm.)	Weather Shield	Wiring Diagrams	Design Figures
.05	T153104	6.41 (16.3)	3.14 (8.0)	3.05 (7.7)	4 (1.8)	W	0.875 (2.2)	NA	8	A
.10	T153105	7.16 (18.2)	3.89 (9.9)	3.67 (9.3)	5 (2.3)	W	0.875 (2.2)	NA	8	A
.15	T153106	7.16 (18.2)	3.89 (9.9)	3.67 (9.3)	7 (3.2)	W	0.875 (2.2)	NA	8	A
.25	T253107S	8.68 (22.0)	4.08 (10.4)	3.88 (9.9)	10 (4.5)	W	0.50-0.75 (1.3-1.9)	NA	9	B
.50	T253108S	9.06 (23.0)	4.37 (11.1)	4.20 (10.7)	15 (6.8)	W	0.50-0.75 (1.3-1.9)	NA	9	B
.75	T253109S	9.68 (24.6)	4.75 (12.1)	4.50 (11.4)	19 (8.6)	W	0.50-0.75 (1.3-1.9)	NA	9	B
1.00	T253110S	10.50 (26.7)	5.50 (14.0)	5.13 (13.0)	24 (10.9)	W	0.50-0.75 (1.3-1.9)	NA	9	B
1.50	T253111S	11.62 (29.5)	5.50 (14.0)	5.13 (13.0)	30 (13.6)	W	0.50-0.75 (1.3-1.9)	NA	9	B
2.00	T253112S	13.00 (33.0)	5.50 (14.0)	5.13 (13.0)	38 (17.2)	W	0.50-0.75 (1.3-1.9)	NA	9	B
3.00	T2531131S	11.50 (29.2)	10.31 (26.2)	7.13 (18.1)	55 (24.9)	W	0.75-1.25 (1.9-3.2)	NA	10	C
5.00	T2531141S	14.38 (36.5)	10.31 (26.2)	7.13 (18.1)	75 (34.0)	W	0.75-1.25 (1.9-3.2)	NA	10	C
7.50	T2536151S	15.19 (38.6)	13.50 (34.3)	10.84 (27.5)	115 (52.2)	W	0.75-1.25 (1.9-3.2)	NA	10	D
10.00	T2536161S	15.19 (38.6)	13.50 (34.3)	10.84 (27.5)	125 (56.7)	W	0.75-1.25 (1.9-3.2)	NA	10	D
15.00	T2536171S	16.94 (43.0)	14.12 (35.9)	11.59 (29.4)	170 (77.1)	W	1.00-1.50 (2.5-3.8)	NA	10	D
25.00	T2536181S	18.44 (46.8)	16.13 (41.0)	13.34 (33.9)	250 (113.0)	W	1.00-1.50 (2.5-3.8)	NA	10	D
37.50	TI531193S	25.50 (64.8)	24.40 (62.0)	19.40 (49.3)	275 (125.0)	F	NA	WSA1	11	E
50.00	TI531203S	29.90 (76.0)	28.15 (71.5)	22.37 (56.8)	340 (154.0)	F	NA	WSA2	11	E
75.00	TI531213S	35.47 (90.0)	31.90 (81.0)	26.88 (68.3)	430 (195.0)	F	NA	WSA3	11	E
100.00	TI531223S	41.52 (105.4)	32.90 (83.5)	29.87 (75.9)	525 (238.0)	F	NA	WSA4	11	E
167.00	TI531233S	45.60 (115.8)	39.5 (100.3)	35.5 (90.2)	1050 (476.3)	F	NA	WSA5	11	E

Notes: 0.05 kVA through 25.0 kVA encapsulated (exempt from C802.2), 37.5 through 167.0 kVA C802.2 compliant



THREE PHASE

190/200/208/220/240 DELTA PRIMARY VOLTS — 400Y/231 SECONDARY VOLTS — 3Ø, 60 Hz

kVA	Catalog Number	Height (Inches)(Cm.)	Width (Inches)(Cm.)	Depth (Inches)(Cm.)	Weight (Lbs.)(Kg.)	Mounting Type (Wall)(Floor)	Knockouts (Inches)(Cm.)	Weather Shield	Wiring Diagrams	Design Figures
15.0	T379083S	18.86 (47.9)	20.30 (51.6)	9.03 (22.9)	300 (136.1)	F	NA	NA	75	I
30.0	T179085S	29.90 (75.9)	28.15 (71.5)	22.37 (56.8)	511 (231.8)	F	NA	WSA2	74	E
45.0	T179087S	25.50 (64.8)	24.39 (62.0)	19.37 (49.2)	540 (244.9)	F	NA	WSA1	74	E
75.0	T179088S	35.90 (91.2)	31.90 (81.0)	26.88 (68.3)	703 (318.9)	F	NA	WSA3	74	E

Notes: 15.0 kVA unit encapsulated (C802.2 exempt), 30.0 through 75.0 kVA units C802.2 compliant

208 DELTA PRIMARY VOLTS — 208Y/120 SECONDARY VOLTS — 3Ø, 60 Hz

kVA	Catalog Number	Height (Inches)(Cm.)	Width (Inches)(Cm.)	Depth (Inches)(Cm.)	Weight (Lbs.)(Kg.)	Mounting Type (Wall)(Floor)	Knockouts (Inches)(Cm.)	Weather Shield	Wiring Diagrams	Design Figures
3.0	T2A792681S	10.38 (26.4)	12.37 (31.4)	7.47 (19.0)	75 (34.0)	W	0.75-1.25 (1.9-3.2)	NA	60	F
6.0	T2A792691S	11.83 (30.0)	14.17 (36.0)	8.82 (22.4)	140 (63.5)	W	0.75-1.25 (1.9-3.2)	NA	60	F
9.0	T2A792701S	14.03 (36.0)	17.77 (45.1)	11.52 (29.3)	180 (81.6)	W	0.75-1.25 (1.9-3.2)	NA	60	F
15.0	T3792711S	18.86 (48.0)	20.30 (51.6)	9.03 (22.9)	245 (111.0)	F	NA	NA	60	I
30.0	T1792724S	25.50 (64.8)	24.39 (61.9)	19.37 (49.2)	300 (136.0)	F	NA	WSA1	61	E
45.0	T1792734S	25.48 (64.7)	24.39 (61.9)	19.37 (49.2)	365 (166.0)	F	NA	WSA1	61	E
75.0	T1792744S	29.41 (74.7)	28.15 (71.5)	22.37 (56.8)	500 (227.0)	F	NA	WSA2	61	E

Notes: 3.0 through 15.0 kVA units are encapsulated (C802.2 exempt), 30.0 through 75.0 kVA units are C802.2 compliant

208 DELTA PRIMARY VOLTS — 480Y/277 SECONDARY VOLTS — 3Ø, 60 Hz

kVA	Catalog Number	Height (Inches)(Cm.)	Width (Inches)(Cm.)	Depth (Inches)(Cm.)	Weight (Lbs.)(Kg.)	Mounting Type (Wall)(Floor)	Knockouts (Inches)(Cm.)	Weather Shield	Wiring Diagrams	Design Figures
15.0	T3793671S	18.86 (48.0)	20.30 (51.6)	9.03 (22.9)	245 (111.0)	F	NA	NA	48	I
30.0	T1793684S	25.50 (64.8)	24.40 (62.0)	19.40 (49.3)	330 (150.0)	F	NA	WSA1	46	E
45.0	T1793694S	25.50 (64.8)	24.40 (62.0)	19.40 (49.3)	400 (181.0)	F	NA	WSA1	46	E
75.0	T1793704S	29.41 (74.7)	28.15 (71.5)	22.37 (56.8)	530 (240.0)	F	NA	WSA2	46	E
112.5	T1793714S	35.47 (90.1)	31.90 (81.0)	26.90 (68.3)	750 (340.0)	F	NA	WSA3	46	E
150.0	T1793724S	41.52 (105.5)	32.90 (83.6)	29.87 (75.9)	950 (430.9)	F	NA	WSA4	46	E
225.0	T1793734S	41.52 (105.5)	32.90 (83.6)	29.87 (75.9)	1200 (544.0)	F	NA	WSA4	46	E
300.0	T1793744S	45.60 (115.8)	39.50 (100.3)	35.50 (90.2)	1550 (703.0)	F	NA	WSA5	46	E

Notes: 15 kVA unit encapsulated (exempt from C802.2), 30 through 300 kVA C802.2 compliant

240 DELTA PRIMARY VOLTS — 208Y/120 SECONDARY VOLTS — 3Ø, 60 Hz

kVA	Catalog Number	Height (Inches)(Cm.)	Width (Inches)(Cm.)	Depth (Inches)(Cm.)	Weight (Lbs.)(Kg.)	Mounting Type (Wall)(Floor)	Knockouts (Inches)(Cm.)	Weather Shield	Wiring Diagrams	Design Figures
9.0	T2A533601S	14.03 (36.0)	17.77 (45.1)	11.52 (29.3)	180 (81.6)	W	0.75-1.25 (1.9-3.2)	NA	18	F
15.0	T3533611S	18.86 (48.0)	20.30 (51.6)	9.03 (23.0)	250 (113.0)	F	NA	NA	18	I
30.0	T1533624S	25.50 (64.8)	24.39 (61.9)	19.37 (49.2)	325 (147.0)	F	NA	WSA1	19	E
45.0	T1533634S	25.50 (64.8)	24.39 (61.9)	19.37 (49.2)	350 (158.8)	F	NA	WSA1	19	E
75.0	T1533644S	29.41 (74.7)	28.15 (71.5)	22.37 (56.8)	450 (204.1)	F	NA	WSA2	19	E
112.5	T1533654S	35.47 (90.1)	31.90 (81.0)	26.88 (68.3)	696 (294.8)	F	NA	WSA3	19	E
150.0	T1533664S	41.52 (105.5)	32.90 (84.0)	29.87 (75.9)	978 (412.8)	F	NA	WSA4	19	E
225.0	T1533674S	41.52 (105.5)	32.90 (84.0)	29.87 (75.9)	1200 (544.0)	F	NA	WSA4	19	E

Notes: 9.0 through 15.0 kVA units encapsulated (exempt from C802.2), 30 kVA through 225 kVA C802.2 compliant



240 DELTA PRIMARY VOLTS — 480Y/277 SECONDARY VOLTS — 3Ø, 60 Hz

kVA	Catalog Number	Height (Inches)(Cm.)	Width (Inches)(Cm.)	Depth (Inches)(Cm.)	Weight (Lbs.)(Kg.)	Mounting Type (Wall)(Floor)	Knockouts (Inches)(Cm.)	Weather Shield	Wiring Diagrams	Design Figures
15.0	T3796931S	18.86 (48.0)	20.30 (51.6)	9.03 (22.9)	245 (111.1)	F	NA	NA	70	I
30.0	T1796944S	25.50 (64.8)	24.39 (61.9)	19.37 (49.2)	330 (149.7)	F	NA	WSA1	71	E
45.0	T1796954S	25.48 (64.7)	24.39 (61.9)	19.37 (49.2)	380 (172.4)	F	NA	WSA1	71	E
75.0	T1796964S	29.41 (74.7)	28.15 (71.5)	22.37 (56.8)	455 (206.4)	F	NA	WSA2	71	E
112.5	T1796974S	35.47 (90.1)	31.90 (81.0)	26.88 (68.3)	687 (311.6)	F	NA	WSA3	71	E
150.0	T1796984S	41.52 (105.5)	32.90 (83.6)	29.87 (75.9)	973 (441.3)	F	NA	WSA4	71	E

Notes: 15 kVA unit encapsulated (C802.2 exempt), 30.0 through 150.0 kVA C802.2 compliant

380 DELTA PRIMARY VOLTS — 220Y/127 SECONDARY VOLTS — 3Ø, 50 Hz

kVA	Catalog Number	Height (Inches)(Cm.)	Width (Inches)(Cm.)	Depth (Inches)(Cm.)	Weight (Lbs.)(Kg.)	Mounting Type (Wall)(Floor)	Knockouts (Inches)(Cm.)	Weather Shield	Wiring Diagrams	Design Figures
15.0	T3795511S	20.80 (52.8)	20.90 (53.1)	10.20 (25.9)	435 (197.3)	F	NA	NA	24	I
30.0	T2A795523S	25.50 (64.8)	24.40 (62.0)	19.40 (49.3)	365 (165.6)	F	NA	WSA1	20	E
45.0	T2A795533S	29.41 (74.7)	28.15 (71.5)	22.37 (56.8)	468 (212.3)	F	NA	WSA2	20	E
75.0	T2A795543S	35.47 (90.1)	31.90 (80.0)	26.88 (68.3)	693 (314.3)	F	NA	WSA3	20	E
112.5	T2A795553S	41.52 (105.5)	32.90 (83.6)	29.87 (75.9)	970 (440.0)	F	NA	WSA4	20	E

Notes: 50 Hz units (C802.2 exempt)

440 DELTA PRIMARY VOLTS — 220Y/127 SECONDARY VOLTS — 3Ø, 50 Hz

kVA	Catalog Number	Height (Inches)(Cm.)	Width (Inches)(Cm.)	Depth (Inches)(Cm.)	Weight (Lbs.)(Kg.)	Mounting Type (Wall)(Floor)	Knockouts (Inches)(Cm.)	Weather Shield	Wiring Diagrams	Design Figures
10.0	TF220105S	18.90 (48.0)	20.30 (51.6)	9.00 (22.9)	245 (111.1)	F	NA	NA	73	I
15.0	TF220155S	25.50 (64.8)	24.40 (62.0)	19.40 (49.3)	291 (132.0)	F	NA	WSA1	73	E
25.0	TF220255S	25.50 (64.8)	24.40 (62.0)	19.40 (49.3)	375 (170.1)	F	NA	WSA1	73	E
50.0	TF220505S	29.41 (74.7)	28.15 (71.5)	22.37 (56.8)	437 (198.2)	F	NA	WSA2	73	E

Notes: 50 Hz units (C802.2 exempt)

480 DELTA PRIMARY VOLTS — 208Y/120 SECONDARY VOLTS — MAY BE USED ON A 4 WIRE 480Y/277 VOLT SUPPLY – 3Ø, 60 Hz

kVA	Catalog Number	Height (Inches)(Cm.)	Width (Inches)(Cm.)	Depth (Inches)(Cm.)	Weight (Lbs.)(Kg.)	Mounting Type (Wall)(Floor)	Knockouts (Inches)(Cm.)	Weather Shield	Wiring Diagrams	Design Figures
3.0	T2A533081S	10.38 (26.4)	12.37 (31.4)	7.47 (19.0)	75 (34.0)	W	0.75-1.25 (1.9-3.2)	NA	21	F
6.0	T2A533091S	11.83 (30.0)	14.17 (36.0)	8.82 (22.4)	140 (63.5)	W	0.75-1.25 (1.9-3.2)	NA	21	F
9.0	T2A533101S	14.03 (36.0)	17.77 (45.1)	11.52 (29.3)	180 (81.6)	W	0.75-1.25 (1.9-3.2)	NA	21	F
15.0	T3533111S	18.86 (48.0)	20.30 (51.6)	9.03 (22.9)	250 (113.0)	F	NA	NA	21	I
30.0	T1533123S	25.50 (64.8)	24.39 (61.9)	19.37 (49.2)	290 (132.0)	F	NA	WSA1	22	E
45.0	T1533133S	25.50 (64.7)	24.39 (61.9)	19.37 (49.2)	400 (181.0)	F	NA	WSA1	22	E
75.0	T1533143S	29.41 (74.7)	28.15 (71.5)	22.37 (56.8)	500 (226.8)	F	NA	WSA2	22	E
112.5	T1533153S	35.47 (90.1)	31.90 (81.0)	26.88 (68.3)	750 (340.0)	F	NA	WSA3	22	E
150.0	T1533163S	41.52 (105.5)	32.90 (83.6)	29.87 (75.9)	970 (440.0)	F	NA	WSA4	22	E
225.0	T11533173S	41.52 (105.5)	32.90 (83.6)	29.87 (75.9)	1200 (544.0)	F	NA	WSA4	22	E
300.0	T1533183S	45.60 (115.8)	39.50 (100.3)	35.50 (90.2)	1550 (703.0)	F	NA	WSA5	22	E
500.0	T11533193S	57.80 (146.8)	45.60 (115.8)	41.50 (105.4)	2480 (1125.0)	F	NA	WSA7	22	G
750.0	T11533213S	62.80 (159.5)	54.00 (137.2)	41.50 (105.4)	3600 (1633.0)	F	NA	WSA6	22	G
1000.0	T11533222S	62.80 (159.5)	54.00 (137.2)	41.50 (105.4)	4300 (1950.0)	F	NA	WSA6	80	G

Notes: 3.0 through 15.0 kVA units encapsulated (exempt from C802.2), 30.0 through 1000.0 kVA C802.2 compliant



480 DELTA PRIMARY VOLTS — COPPER WINDINGS — 208Y/120 SECONDARY VOLTS, 150°C RISE — 3Ø, 60 Hz

kVA	Catalog Number	Height (Inches)(Cm.)	Width (Inches)(Cm.)	Depth (Inches)(Cm.)	Weight (Lbs.)(Kg.)	Mounting Type (Wall)(Floor)	Knockouts (Inches)(Cm.)	Weather Shield	Wiring Diagrams	Design Figures
15.0	TC533111S*	18.90 (48.0)	20.30 (51.6)	9.00 (22.9)	245 (111.1)	F	NA	NA	21	I
30.0	TIC533123S	25.50 (64.8)	24.40 (62.0)	19.40 (49.3)	346 (157.0)	F	NA	WSA1	22	E
45.0	TIC533133S	25.50 (64.8)	24.40 (62.0)	19.40 (49.3)	397 (180.1)	F	NA	WSA1	22	E
75.0	TIC533143S	29.41 (74.7)	28.15 (71.5)	22.37 (56.8)	521 (236.3)	F	NA	WSA2	22	E
112.5	TIC533153S	35.47 (90.1)	31.90 (81.0)	26.88 (68.3)	766 (347.5)	F	NA	WSA3	22	E
150.0	TIC533163S	41.52 (105.5)	32.90 (83.6)	29.87 (75.9)	1026 (465.4)	F	NA	WSA4	22	E
225.0	TIC533173S	41.52 (105.5)	32.90 (83.6)	29.87 (75.9)	1300 (589.7)	F	NA	WSA4	22	E
300.0	TIC533183S	45.60 (115.8)	39.50 (100.3)	35.50 (90.2)	1551 (703.5)	F	NA	WSA5	22	E
500.0	TIC533193S	57.80 (146.8)	45.00 (114.3)	41.50 (105.4)	2819 (1278.7)	F	NA	WSA7	22	E

* NOTE: TC533111S—Encapsulated, 115° C Rise, 180°C Insulation (C802.2 exempt), 30.0 through 500 kVA C802.2 compliant

115°C RISE

480 DELTA PRIMARY VOLTS — 208Y/120 SECONDARY VOLTS — MAY BE USED ON A 4 WIRE 480Y/277 VOLT SUPPLY — 3Ø, 60 Hz

kVA	Catalog Number	Height (Inches)(Cm.)	Width (Inches)(Cm.)	Depth (Inches)(Cm.)	Weight (Lbs.)(Kg.)	Mounting Type (Wall)(Floor)	Knockouts (Inches)(Cm.)	Weather Shield	Wiring Diagrams	Design Figures
30.0	TI533121S	29.48 (74.9)	28.15 (71.5)	22.37 (56.8)	360 (163.3)	F	NA	WSA2	22	E
45.0	TI533131S	29.48 (74.9)	28.15 (71.5)	22.37 (56.8)	417 (189.2)	F	NA	WSA2	22	E
75.0	TI533141S	35.47 (90.1)	31.90 (81.0)	26.88 (68.3)	536 (243.1)	F	NA	WSA3	22	E
112.5	TI533151S	41.50 (105.4)	32.90 (83.6)	29.90 (75.9)	760 (344.7)	F	NA	WSA4	22	E
150.0	TI533161S	41.50 (105.4)	32.90 (83.6)	29.90 (75.9)	950 (430.9)	F	NA	WSA4	22	E
225.0	TI533171S	45.59 (115.8)	39.50 (100.3)	35.50 (90.2)	1567 (712.3)	F	NA	WSA5	22	E
300.0	TI533181S	45.59 (115.8)	39.50 (100.3)	35.50 (90.2)	1553 (705.9)	F	NA	WSA5	22	E
500.0	TI533191S	57.84 (146.9)	45.50 (115.6)	41.50 (105.4)	2808 (1276.4)	F	NA	WSA7	22	G

80°C RISE

480 DELTA PRIMARY VOLTS — 208Y/120 SECONDARY VOLTS — MAY BE USED ON A 4 WIRE 480Y/277 VOLT SUPPLY — 3Ø, 60 Hz

kVA	Catalog Number	Height (Inches)(Cm.)	Width (Inches)(Cm.)	Depth (Inches)(Cm.)	Weight (Lbs.)(Kg.)	Mounting Type (Wall)(Floor)	Knockouts (Inches)(Cm.)	Weather Shield	Wiring Diagrams	Design Figures
30.0	TI533128S	25.49 (64.7)	24.39 (61.9)	19.37 (49.2)	364 (165.1)	F	NA	WSA1	22	E
45.0	TI533138S	29.48 (74.9)	28.15 (71.5)	22.37 (56.8)	500 (226.8)	F	NA	WSA2	22	E
75.0	TI533148S	35.90 (91.2)	31.90 (81.0)	26.88 (68.3)	698 (316.6)	F	NA	WSA3	22	E
112.5	TI533158S	41.50 (105.4)	32.90 (83.6)	29.90 (75.9)	963 (437.7)	F	NA	WSA4	22	E
150.0	TI533168S	41.50 (105.4)	32.90 (83.6)	29.90 (75.9)	1145 (520.4)	F	NA	WSA4	22	E
225.0	TI533171S	45.59 (115.8)	39.50 (100.3)	35.50 (90.2)	1567 (712.3)	F	NA	WSA5	22	E
300.0	TI533181S	45.59 (115.8)	39.50 (100.3)	35.50 (90.2)	1553 (705.9)	F	NA	WSA5	22	E
500.0	TI533191S	57.84 (146.9)	45.50 (115.6)	41.50 (105.4)	2808 (1276.4)	F	NA	WSA7	22	G

ENCAPSULATED TRANSFORMERS, 115°C RISE

480 DELTA PRIMARY VOLTS — 208Y/120 SECONDARY VOLTS — 3Ø, 60 Hz

kVA	Catalog Number	Height (Inches)(Cm.)	Width (Inches)(Cm.)	Depth (Inches)(Cm.)	Weight (Lbs.)(Kg.)	Mounting Type (Wall)(Floor)	Knockouts (Inches)(Cm.)	Weather Shield	Wiring Diagrams	Design Figures
30.0	T3793123S	24.81 (63.0)	27.13 (68.9)	11.14 (28.3)	613 (278.1)	F	NA	NA	22-I	22-I
45.0	T3793133S	25.31 (64.3)	30.18 (76.7)	12.76 (32.4)	780 (354.0)	F	NA	NA	22-I	22-I
75.0	T3793143S	26.82 (68.1)	34.68 (88.1)	15.25 (38.7)	1126 (511.0)	F	NA	NA	22-I	22-I

Notes: 30.0 through 75.0 kVA encapsulated (C802.2 exempt)



**316 STAINLESS STEEL
ENCAPSULATED TRANSFORMERS, 115° C RISE, 480 DELTA PRIMARY VOLTS — 208Y/120 SECONDARY VOLTS — 3Ø, 60 Hz**

kVA	Catalog Number	Height (Inches)(Cm.)	Width (Inches)(Cm.)	Depth (Inches)(Cm.)	Weight (Lbs.)(Kg.)	Mounting Type (Wall)(Floor)	Knockouts (Inches)(Cm.)	Weather Shield	Wiring Diagrams	Design Figures
3.0	T2A53308SS	10.38 (26.4)	12.37 (31.4)	7.47 (19.0)	75 (34.0)	W	NA	NA	21	F
6.0	T2A53309SS	11.83 (30.0)	14.17 (36.0)	8.82 (22.4)	140 (63.5)	W	NA	NA	21	F
9.0	T2A53310SS	14.03 (35.6)	17.77 (45.1)	11.52 (29.3)	180 (81.6)	W	NA	NA	21	F
15.0	T353311SS	18.86 (47.9)	20.30 (51.6)	9.03 (22.9)	250 (113.0)	F	NA	NA	21	I
30.0	T379312SS	24.81 (63.0)	27.13 (68.9)	11.14 (28.3)	613 (278.1)	F	NA	NA	22	I
45.0	T379313SS	25.31 (64.3)	30.18 (76.7)	12.76 (32.4)	780 (354.0)	F	NA	NA	22	I
75.0	T379314SS	26.82 (68.1)	34.68 (88.1)	15.25 (38.7)	1126 (511.0)	F	NA	NA	22	I

Notes: 3.0 through 75.0 kVA units encapsulated (C802.2 exempt)

**480 DELTA PRIMARY VOLTS — 240 DELTA / 120 TAP SECONDARY VOLTS
MAY BE USED ON A 4 WIRE 480Y/277 VOLT SUPPLY — 3Ø, 60 Hz**

kVA	Catalog Number	Height (Inches)(Cm.)	Width (Inches)(Cm.)	Depth (Inches)(Cm.)	Weight (Lbs.)(Kg.)	Mounting Type (Wall)(Floor)	Knockouts (Inches)(Cm.)	Weather Shield	Wiring Diagrams	Design Figures
3.0	T2A533281S	10.38 (26.4)	12.37 (31.4)	7.47 (19.0)	75 (34.0)	W	0.75-1.25 (1.9-3.2)	NA	25	F
6.0	T2A533291S	11.83 (30.0)	14.17 (36.0)	8.82 (22.4)	140 (63.5)	W	0.75-1.25 (1.9-3.2)	NA	25	F
9.0	T2A533401S	14.03 (36.0)	17.77 (45.1)	11.52 (29.3)	180 (81.6)	W	0.75-1.25 (1.9-3.2)	NA	25	F
15.0	T3-533411S	18.86 (47.9)	20.30 (51.6)	9.03 (22.9)	250 (113.0)	F	NA	NA	25	I
30.0	TI1533423S	25.50 (64.8)	24.39 (61.9)	19.37 (49.2)	325 (147.0)	F	NA	WSA1	26	E
45.0	TI1533433S	25.50 (64.8)	24.39 (61.9)	19.37 (49.2)	400 (181.0)	F	NA	WSA1	26	E
75.0	TI1533443S	29.41 (74.7)	28.15 (71.5)	22.37 (56.8)	500 (226.8)	F	NA	WSA2	26	E
112.5	TI1533453S	35.47 (91.2)	31.90 (81.0)	26.88 (68.3)	750 (340.0)	F	NA	WSA3	26	E
150.0	TI1533463S	41.52 (105.5)	32.90 (83.6)	29.87 (75.9)	1125 (510.0)	F	NA	WSA4	26	E
225.0	TI1533473S	41.52 (105.5)	32.90 (83.6)	29.87 (75.9)	1200 (544.0)	F	NA	WSA4	26	E
300.0	TI1533483S	45.60 (115.8)	39.50 (100.3)	35.50 (90.2)	1550 (703.0)	F	NA	WSA5	26	G
500.0	TI1533493S	62.00 (157.5)	54.00 (137.2)	42.00 (106.7)	2675 (1213.0)	F	NA	WSA7	26	G
750.0	TI1533503S	62.80 (159.5)	54.00 (137.2)	41.50 (105.4)	3408 (1545.8)	F	NA	WSA6	26	G

Notes: 3.0 through 15.0 kVA units encapsulated (C802.2 exempt), 30.0 through 750.0 kVA C802.2 compliant. 3.0 kVA through 750.0 kVA provided with 120V lighting tap limited to 5% of nameplate rating.

**480 DELTA PRIMARY VOLTS — 480Y/277 SECONDARY VOLTS
MAY BE USED ON A 4 WIRE 480Y/277 VOLT SUPPLY — 3Ø, 60 Hz**

kVA	Catalog Number	Height (Inches)(Cm.)	Width (Inches)(Cm.)	Depth (Inches)(Cm.)	Weight (Lbs.)(Kg.)	Mounting Type (Wall)(Floor)	Knockouts (Inches)(Cm.)	Weather Shield	Wiring Diagrams	Design Figures
15.0	T335000153S	18.86 (48.0)	20.30 (51.6)	9.03 (22.9)	250 (113.0)	F	NA	NA	31	I
30.0	TI35000303S	29.41 (74.7)	28.15 (71.5)	22.37 (56.8)	325 (147.0)	F	NA	WSA2	31	E
45.0	TI135000453S	29.41 (74.7)	28.15 (71.5)	22.37 (56.8)	400 (181.0)	F	NA	WSA2	31	E
75.0	TI35000753S	29.41 (74.7)	28.15 (71.5)	22.37 (56.8)	600 (272.0)	F	NA	WSA2	31	E
112.5	TI35001123S	35.47 (90.1)	31.90 (81.0)	26.88 (68.3)	710 (322.0)	F	NA	WSA3	31	E
150.0	TI35001503S	41.52 (105.5)	32.90 (83.6)	29.87 (75.9)	1155 (524.0)	F	NA	WSA4	31	E
225.0	TI35002253S	41.52 (105.5)	32.90 (83.6)	29.87 (75.9)	1210 (548.8)	F	NA	WSA4	31	E
300.0	TI35003003S	45.60 (115.8)	39.50 (100.3)	35.50 (90.2)	1600 (726.0)	F	NA	WSA5	31	E

Notes: 15.0 kVA unit encapsulated (C802.2 exempt), 30.0 through 300.0 kVA C802.2 compliant



600 DELTA PRIMARY VOLTS — 208Y/120 SECONDARY VOLTS — 3Ø, 60 Hz

kVA	Catalog Number	Height (Inches)(Cm.)	Width (Inches)(Cm.)	Depth (Inches)(Cm.)	Weight (Lbs.)(Kg.)	Mounting Type (Wall)(Floor)	Knockouts (Inches)(Cm.)	Weather Shield	Wiring Diagrams	Design Figures
3.0	T2A793301S	10.38 (26.4)	12.37 (31.4)	7.47 (19.0)	75 (34.0)	W	0.75-1.25 (1.9-3.2)	NA	28	F
6.0	T2A793311S	11.83 (30.0)	14.17 (36.0)	8.82 (22.4)	140 (63.5)	W	0.75-1.25 (1.9-3.2)	NA	28	F
9.0	T2A793321S	14.03 (36.0)	17.77 (45.1)	11.52 (29.3)	180 (81.6)	W	0.75-1.25 (1.9-3.2)	NA	28	F
15.0	T3793331S	18.86 (47.9)	20.30 (51.6)	9.03 (22.9)	250 (113.0)	F	NA	NA	28	I
30.0	TI131023S	25.50 (64.8)	24.39 (61.9)	19.37 (49.2)	325 (147.0)	F	NA	WSA1	29	E
45.0	TI131033S	25.50 (64.8)	24.39 (61.9)	19.37 (49.2)	400 (181.0)	F	NA	WSA1	29	E
75.0	TI131043S	29.41 (74.7)	28.15 (71.5)	22.37 (56.8)	600 (272.0)	F	NA	WSA2	29	E
112.5	TI131053S	35.47 (90.1)	31.90 (81.0)	26.88 (68.3)	750 (340.0)	F	NA	WSA3	29	E
150.0	TI131063S	41.52 (105.5)	32.90 (83.6)	29.87 (75.9)	970 (440)	F	NA	WSA4	29	E
225.0	TI131073S	41.52 (105.5)	32.90 (83.6)	29.87 (75.9)	1200 (544)	F	NA	WSA4	29	E
300.0	TI130993S	45.60 (115.8)	39.50 (100.3)	35.50 (90.2)	1550 (703.0)	F	NA	WSA5	29	E
500.0	TI131123S	57.84 (146.9)	45.00 (114.3)	41.50 (105.4)	2480 (1125.0)	F	NA	WSA7	29	E
750.0	TI131133S	62.84 (159.6)	54.00 (137.2)	41.50 (105.4)	3600 (1633.0)	F	NA	WSA6	29	E

Notes: 3.0 through 15.0 kVA encapsulated (C802.2 exempt), 30.0 through 75.0 kVA C802.2 compliant

600 DELTA PRIMARY VOLTS — 240 DELTA/120 TAP SECONDARY VOLTS — 3Ø, 60 Hz

kVA	Catalog Number	Height (Inches)(Cm.)	Width (Inches)(Cm.)	Depth (Inches)(Cm.)	Weight (Lbs.)(Kg.)	Mounting Type (Wall)(Floor)	Knockouts (Inches)(Cm.)	Weather Shield	Wiring Diagrams	Design Figures
30.0	TI131423S	25.50 (64.8)	24.39 (61.9)	19.37 (49.2)	299 (135.6)	F	NA	WSA1	69	E
45.0	TI131433S	25.48 (64.7)	24.39 (61.9)	19.37 (49.2)	353 (160.1)	F	NA	WSA1	69	E
75.0	TI131443S	29.41 (74.7)	28.15 (71.5)	22.37 (56.8)	463 (210.0)	F	NA	WSA2	69	E

600 DELTA PRIMARY VOLTS — 480Y/277 SECONDARY VOLTS — 3Ø, 60 Hz

kVA	Catalog Number	Height (Inches)(Cm.)	Width (Inches)(Cm.)	Depth (Inches)(Cm.)	Weight (Lbs.)(Kg.)	Mounting Type (Wall)(Floor)	Knockouts (Inches)(Cm.)	Weather Shield	Wiring Diagrams	Design Figures
3.0	T2A795161S	10.38 (26.4)	12.37 (31.4)	7.47 (19.0)	75 (34.0)	W	0.75-1.25 (1.9-3.2)	NA	55	F
6.0	T2A795171S	11.83 (30.0)	14.17 (36.0)	8.82 (22.4)	140 (63.5)	W	0.75-1.25 (1.9-3.2)	NA	55	F
9.0	T2A795181S	14.03 (38.8)	17.77 (45.1)	11.52 (29.3)	180 (81.6)	W	0.75-1.25 (1.9-3.2)	NA	55	F
15.0	T3795191S	18.86 (47.9)	20.30 (51.6)	9.03 (22.9)	250 (113.0)	F	NA	NA	55	I
30.0	TI795203S	29.41 (74.7)	28.15 (71.5)	22.37 (56.8)	400 (181.0)	F	NA	WSA2	51	E
45.0	TI795213S	29.41 (74.7)	28.15 (71.5)	22.37 (56.8)	425 (193.0)	F	NA	WSA2	51	E
75.0	TI795223S	29.41 (74.7)	28.15 (71.5)	22.37 (56.8)	700 (318.0)	F	NA	WSA2	51	E
112.5	TI795233S	35.47 (90.1)	31.90 (81.0)	26.88 (68.3)	750 (340.0)	F	NA	WSA3	51	E
150.0	TI795243S	41.52 (105.5)	32.90 (83.6)	29.87 (75.9)	1125 (510.0)	F	NA	WSA4	51	E

Notes: 3.0 through 15.0 kVA units are encapsulated (C802.2 exempt), 30.0 through 150.0 kVA are C802.2 compliant

**AUTO-TRANSFORMERS 600 PRIMARY VOLTS — 480 SECONDARY VOLTS — 3Ø, 60 Hz
480 PRIMARY VOLTS — 380 SECONDARY VOLTS — 3Ø, 50/60 Hz ALTERNATE RATING**

kVA		Catalog Number	Height (Inches)(Cm.)	Width (Inches)(Cm.)	Depth (Inches)(Cm.)	Weight (Lbs.)(Kg.)	Mounting Type (Wall)(Floor)	Knockouts (Inches)(Cm.)	Weather Shield	Wiring Diagrams	Design Figures
Primary 600V Secondary 480V	Primary 480V Secondary 380V										
15.0	12.0	T2527031	15.21 (38.6)	19.25 (48.9)	7.37 (18.7)	104 (47.2)	W	NA	NA	56	F
30.0	24.0	T2527051	15.21 (38.6)	19.25 (48.9)	7.37 (18.7)	152 (68.9)	W	NA	NA	56	F
45.0	36.0	T2527071	15.21 (38.6)	19.25 (48.9)	7.37 (18.7)	156 (70.8)	W	NA	NA	56	F
75.0	60.0	T3527101	18.86 (47.9)	20.30 (51.6)	9.03 (22.9)	300 (136.1)	F	NA	NA	56	I
112.5	90.0	T2A527121	25.50 (64.8)	24.40 (62.0)	19.40 (49.3)	325 (147.0)	F	NA	WSA1	57	E
150.0	120.0	T2A527131	25.50 (64.8)	24.40 (62.0)	19.40 (49.3)	350 (158.8)	F	NA	WSA1	57	E
225.0	180.0	T2A527151	29.41 (74.7)	28.15 (71.5)	22.37 (56.8)	600 (272.0)	F	NA	WSA2	57	E
300.0	240.0	T2A527171	29.41 (74.7)	28.15 (71.5)	22.37 (56.8)	650 (294.8)	F	NA	WSA2	57	E
450.0	360.0	T2A527181	35.47 (90.1)	31.90 (81.0)	26.88 (68.3)	750 (340.0)	F	NA	WSA3	57	E
500.0	400.0	T2A527191	35.47 (90.1)	31.90 (81.0)	26.88 (68.3)	790 (358.3)	F	NA	WSA3	57	E

Notes: Auto-Transformers C802.2 exempt

HARMONIC MITIGATING TRANSFORMERS

Many of today's electronic devices are non-linear loads generating high levels of harmonic currents that are then fed back onto your distribution system. This waveform distortion results in overheating of motors and transformers, increased neutral currents and malfunction/damage to other equipment on the line.

Acme Electric introduces a line of harmonic mitigating transformers that combine the technologies shown in our non-linear load (K-Factor) transformers. Where conventional K-Factor transformers "deal" with harmonics, containing them within the transformer and preventing them from going further upstream; harmonic mitigating transformers eliminate harmonics by pitting them against themselves. This technology not only results in "cleaner power" but also provides the most energy efficient means to deal with harmonic problems.

Available in sizes ranging from 30 thru 225 kVA, with copper windings and a variety of other design options and accessories, Acme harmonic mitigating transformers offer you reduced transformer heat, reduced voltage distortion due to 3rd order harmonics, higher efficiency.

Features

- Unlike K-rated transformers, Harmonic Mitigating transformers actually treat the triplen harmonics in the secondary winding
- Reduce supply voltage flat topping caused by non-linear loads
- Improve overall power factor of supply system
- Suitable for K-Factor loads
- Improved energy efficiency
- Copper conductor construction

Applications

- Financial facilities
- Educational facilities
- TV Broadcast facilities
- Office buildings
- Hospitals
- Health care facilities

480 DELTA PRIMARY VOLTS — 208Y/120 SECONDARY VOLTS

kVA	Catalog Number	Height (Inches)(Cm.)	Width (Inches)(Cm.)	Depth (Inches)(Cm.)	Weight (Lbs.)(Kg.)	Mounting Type (Wall)(Floor)	Weather Shield	Wiring Diagrams	Design Figures
30.0	CMTI533124S	29.90 (75.9)	28.15 (71.5)	22.37 (56.8)	535 (242.7)	F	WSA2	81	E
45.0	CMTI533134S	29.90 (75.9)	28.15 (71.5)	22.37 (56.8)	600 (272.2)	F	WSA2	81	E
75.0	CMTI533144S	35.90 (91.2)	31.90 (81.0)	26.88 (68.3)	760 (344.7)	F	WSA3	81	E
112.5	CMTI533154S	41.52 (105.5)	32.90 (83.6)	29.88 (75.9)	1180 (535.2)	F	WSA4	81	E
150.0	CMTI533164S	41.52 (105.5)	32.90 (83.6)	29.88 (75.9)	1340 (607.8)	F	WSA4	81	E
225.0	CMTI533174S	41.52 (105.5)	32.90 (83.6)	29.88 (75.9)	1970 (893.6)	F	WSA4	81	E





NON-LINEAR LOAD® ISOLATION TRANSFORMERS

Non-linear loads generate high levels of harmonic currents. When supplying power to these loads, a special transformer design is necessary.

Typical non-linear loads include desktop computers, AC variable speed drives, HID lighting, electronic ballasts, inverters and welders. Of these non-linear loads, the major source of harmonic currents is the switch mode power supply found in desktop computers, data processors and other office equipment.

Acme non-linear load isolation transformers use special winding techniques to minimize eddy current losses generated by harmonic currents. A double-sized neutral conductor handles the excessive neutral current found in non-linear load applications.

The amount of harmonics produced by a given load is represented by the term “K” factor. The larger the “K” factor, the more harmonics are present. Linear loads have a “K” factor of 1; switch mode power supplies typically have a “K” factor as high as 20.

Acme non-linear load isolation transformers are shielded for cleaner power and carry the Acme exclusive 10-year limited warranty.

K-Factor/Type of Load

- K-1** Resistance heating
Incandescent lighting Motors
Transformers, control/distribution
- K-4** Welders
Induction heaters
HID lighting
Fluorescent lighting
Solid state controls
- K-13** Telecommunications equipment
Branch Circuits in classrooms
and health care facilities
- K-20** Main frame computers
Variable speed drives
Branch circuits with exclusive loads of data
processing equipment
Desktop computers

Features

- Available in K-factors of 4, 13 and 20. Consult factory for other K-factors.
- 150°C, 115°C and 80°C temperature rise units.
- 10-year limited warranty.
- UL Listed and CSA Certified.
- Available in 480V and 600V primary, 15 through 600 kVA.
- Primary taps: (2) 2½% ANFC, (4) 2½% BNFC.
- Aluminum windings

208 DELTA PRIMARY VOLTS — 208Y/120 SECONDARY VOLTS — 3Ø, 60 Hz; K FACTOR 13,150°C RISE

kVA	Catalog Number	Height (Inches)(Cm.)	Width (Inches)(Cm.)	Depth (Inches)(Cm.)	Weight (Lbs.)(Kg.)	Mounting Type (Wall)(Floor)	Weather Shield	Wiring Diagrams	Design Figures
15.0	TINS01792714S	25.50 (64.8)	24.90 (62.0)	19.37 (49.2)	320 (145.1)	F	WSA1	61	E
30.0	TINS01792724S	25.50 (64.8)	24.90 (62.0)	19.37 (49.2)	366 (166.0)	F	WSA1	61	E
45.0	TINS01792734S	29.40 (74.7)	28.15 (71.5)	22.37 (56.8)	522 (236.8)	F	WSA2	61	E
75.0	TINS01792744S	35.40 (89.9)	31.90 (81.0)	26.87 (68.2)	667 (302.6)	F	WSA3	61	E

480 DELTA PRIMARY VOLTS — 208Y/120 SECONDARY VOLTS — 3Ø, 60 Hz; K FACTOR 20,150°C RISE

kVA	Catalog Number	Height (Inches)(Cm.)	Width (Inches)(Cm.)	Depth (Inches)(Cm.)	Weight (Lbs.)(Kg.)	Mounting Type (Wall)(Floor)	Weather Shield	Wiring Diagrams	Design Figures
15.0	TINS02533113S	25.50 (64.8)	24.40 (62.0)	19.40 (49.3)	325 (147.0)	F	WSA1	22	E
30.0	TINS02533123S	25.50 (64.8)	24.40 (62.0)	19.40 (49.3)	420 (191.0)	F	WSA1	22	E
45.0	TINS02533133S	35.90 (91.2)	31.90 (81.0)	26.88 (68.3)	575 (261.0)	F	WSA3	22	E
75.0	TINS02533143S	35.90 (91.2)	31.90 (81.0)	26.88 (68.3)	620 (281.0)	F	WSA3	22	E
112.5	TINS02533153S	41.52 (105.5)	32.90 (83.6)	29.88 (75.9)	1200 (544.0)	F	WSA4	22	E
150.0	TINS02533163S	41.52 (105.5)	32.90 (83.6)	29.88 (75.9)	1700 (771.0)	F	WSA4	22	E
225.0	TINS02533173S	45.60 (115.8)	39.50 (100.3)	35.50 (90.2)	2165 (982.0)	F	WSA5	22	G



480 DELTA PRIMARY VOLTS — 208Y/120 SECONDARY VOLTS — 3Ø, 60 Hz; K FACTOR 13,150°C RISE

kVA	Catalog Number	Height (Inches)(Cm.)	Width (Inches)(Cm.)	Depth (Inches)(Cm.)	Weight (Lbs.)(Kg.)	Mounting Type (Wall)(Floor)	Weather Shield	Wiring Diagrams	Design Figures
15.0	TINS01533113S	25.50 (64.8)	24.40 (62.0)	19.40 (49.3)	325 (147.0)	F	WSA1	22	E
30.0	TINS01533123S	29.90 (75.9)	28.15 (71.5)	22.37 (56.8)	360 (163.0)	F	WSA2	22	E
45.0	TINS01533133S	29.90 (75.9)	28.15 (71.5)	22.37 (56.8)	440 (200.0)	F	WSA2	22	E
75.0	TINS01533143S	35.90 (91.2)	31.90 (81.0)	26.88 (68.3)	600 (272.0)	F	WSA3	22	E
112.5	TINS01533153S	41.52 (105.5)	32.90 (83.6)	29.88 (75.9)	870 (395.0)	F	WSA4	22	E
150.0	TINS01533163S	41.52 (105.5)	32.90 (83.6)	29.88 (75.9)	1500 (680.0)	F	WSA4	22	E
225.0	TINS11533173S	45.60 (115.8)	39.50 (100.3)	35.50 (90.2)	1550 (703.0)	F	WSA5	22	E

480 DELTA PRIMARY VOLTS — 208Y/120 SECONDARY VOLTS — 3Ø, 60 Hz; K FACTOR 13,115°C RISE

kVA	Catalog Number	Height (Inches)(Cm.)	Width (Inches)(Cm.)	Depth (Inches)(Cm.)	Weight (Lbs.)(Kg.)	Mounting Type (Wall)(Floor)	Weather Shield	Wiring Diagrams	Design Figures
15.0	TINS01533111S	25.50 (64.8)	24.40 (62.0)	19.40 (49.3)	325 (147.0)	F	WSA1	22	E
30.0	TINS01533121S	29.90 (75.9)	28.20 (71.6)	22.40 (56.9)	400 (181.0)	F	WSA2	22	E
45.0	TINS01533131S	35.90 (91.2)	31.90 (81.0)	26.90 (68.3)	575 (261.0)	F	WSA3	22	E
75.0	TINS01533141S	35.90 (91.2)	31.90 (81.0)	26.90 (68.3)	750 (340.0)	F	WSA3	22	E
112.5	TINS01533151S	41.50 (105.4)	32.90 (83.6)	29.90 (75.9)	1120 (508.0)	F	WSA4	22	E
150.0	TINS01533161S	41.50 (105.4)	32.90 (83.6)	29.90 (75.9)	1200 (544.0)	F	WSA4	22	E

For Additional Low Temperature Rise 115° and 80° C Units Consult Factory

480 DELTA PRIMARY VOLTS — 208Y/120 SECONDARY VOLTS — 3Ø, 60 Hz; K FACTOR 4,150°C RISE

kVA	Catalog Number	Height (Inches)(Cm.)	Width (Inches)(Cm.)	Depth (Inches)(Cm.)	Weight (Lbs.)(Kg.)	Mounting Type (Wall)(Floor)	Weather Shield	Wiring Diagrams	Design Figures
15.0	TINS00533113S	25.50 (64.8)	24.40 (62.0)	19.40 (49.3)	325 (147.0)	F	WSA1	22	E
30.0	TINS00533123S	29.90 (75.9)	28.15 (71.5)	22.37 (56.8)	345 (157.0)	F	WSA2	22	E
45.0	TINS00533133S	29.90 (75.9)	28.15 (71.5)	22.37 (56.8)	430 (195.0)	F	WSA2	22	E
75.0	TINS00533143S	35.90 (91.2)	31.90 (81.0)	26.88 (68.3)	560 (254.0)	F	WSA3	22	E
112.5	TINS00533153S	41.52 (105.5)	32.90 (83.6)	29.88 (75.9)	875 (397.0)	F	WSA4	22	E
150.0	TINS00533163S	41.52 (105.5)	32.90 (83.6)	29.88 (75.9)	1550 (703.0)	F	WSA4	22	E
225.0	TINS10533173S	45.60 (115.8)	39.50 (100.3)	35.50 (90.2)	1600 (725.8)	F	WSA5	22	E



These drawings are for reference only.
Contact factory for certified drawings.

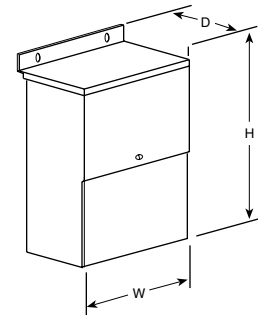

Design A

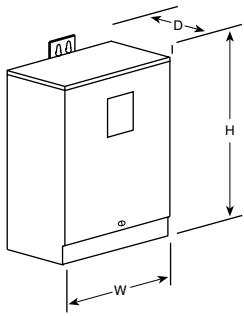

Design B

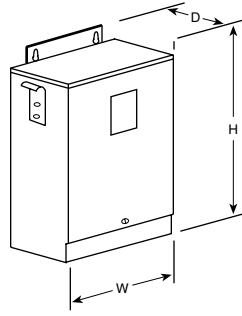

Design C

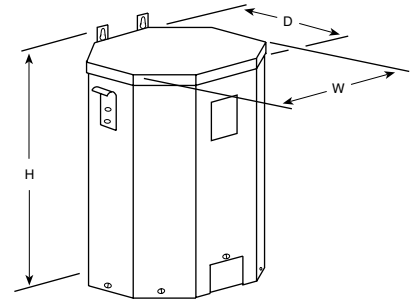

Design D

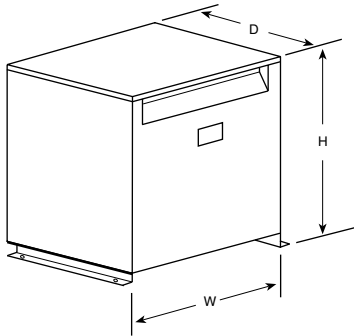

Design E

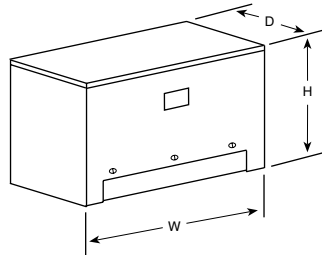

Design F

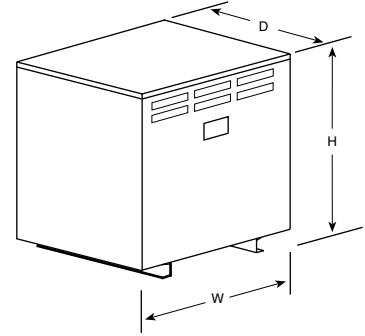

Design G

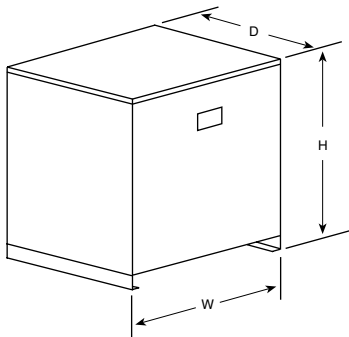

Design H

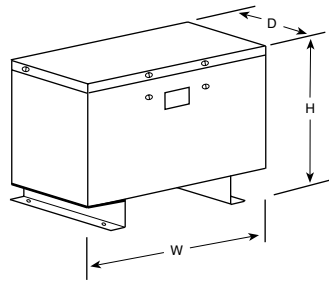

Design I

1

PRIMARY: 240 X 480
SECONDARY: 120/240
TAPS: None

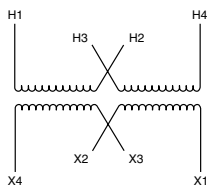

Primary Volts	Connect Primary Lines To	Inter-Connect	Connect Secondary Lines To
480	H1-H4	H2 to H3	
240	H1-H3 & H2-H4		

Secondary Volts

240		X2 to X3	X1-X4
120/240		X2 to X3	X1-X2-X4
120		X1 to X3 X2 to X4	X1-X4

2

PRIMARY: 240 X 480
SECONDARY: 120/240
TAPS: None

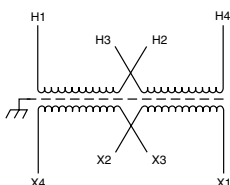

Primary Volts	Connect Primary Lines To	Inter-Connect	Connect Secondary Lines To
480	H1-H4	H2 to H3	
240	H1-H3 & H2-H4		

Secondary Volts

240		X2 to X3	X1-X4
120/240		X2 to X3	X1-X2-X4
120		X1 to X3 X2 to X4	X1-X4

3

PRIMARY: 240 X 480
SECONDARY: 120/240
TAPS: 2, 2 1/2% ANFC, 2, 2 1/2% BNFC

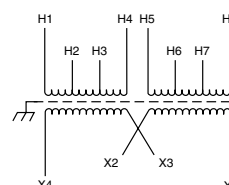

Primary Volts	Connect Primary Lines To	Inter-Connect	Connect Secondary Lines To
252	H1-H8	H1 to H5 H4 to H8	
240	H1-H7	H1 to H5 H3 to H7	
228	H1-H6	H1 to H5 H2 to H6	
504	H1-H8	H4 to H5	
492	H1-H8	H3 to H5	
480	H1-H7	H3 to H5	
468	H1-H7	H2 to H5	
456	H1-H6	H2 to H5	

Secondary Volts

240		X2 to X3	X1-X4
120/240		X2 to X3	X1-X2-X4
120		X1 to X3 X2 to X4	X1-X4

4

PRIMARY: 240 X 480
SECONDARY: 120/240
2, 2 1/2% ANFC, 4, 2 1/2% BNFC

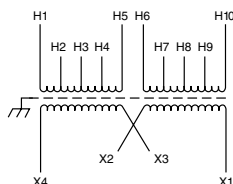

Primary Volts	Connect Primary Lines To	Inter-Connect	Connect Secondary Lines To
216	H1-H10	H1 to H9 H10 to H2	
228	H1-H10	H1 to H8 H10 to H3	
240	H1-H10	H1 to H7 H10 to H4	
252	H1-H10	H1 to H6 H10 to H5	
432	H1-H10	H2 to H9	
444	H1-H10	H3 to H9	
456	H1-H10	H3 to H8	
468	H1-H10	H4 to H8	
480	H1-H10	H4 to H7	
492	H1-H10	H5 to H7	
504	H1-H10	H5 to H6	

Secondary Volts

240		X2 to X3	X1-X4
120/240		X2 to X3	X1-X3-X4
120		X1 to X3 X2 to X4	X1-X4

5

PRIMARY: 240 X 480
SECONDARY: 120/240
TAPS: 2, 2 1/2% ANFC, 2, 2 1/2% BNFC

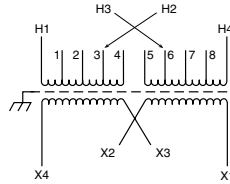

Primary Volts	Connect Primary Lines To	Inter-Connect	Connect Secondary Lines To
216	H1-H4	H1, H3, 8 & H2, H4, 1	
228	H1-H4	H1, H3, 7 & H2, H4, 2	
240	H1-H4	H1, H3, 6 & H2, H4, 3	
252	H1-H4	H1, H3, 5 & H2, H4, 4	
432	H1-H4	H2, 1 & H3, 8	
444	H1-H4	H2, 2 & H3, 8	
456	H1-H4	H2, 2 & H3, 7	
468	H1-H4	H2, 3 & H3, 7	
480	H1-H4	H2, 3 & H3, 6	
492	H1-H4	H2, 4 & H3, 6	
504	H1-H4	H2, 4 & H3, 5	

Secondary Volts

240		X2 to X3	X1-X4
120/240		X2 to X3	X1-X2-X4
120		X1 to X3 X2 to X4	X1-X4

8

PRIMARY: 600
SECONDARY: 120/240
TAPS: None

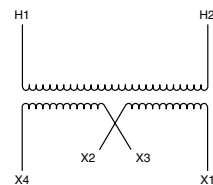

Primary Volts	Connect Primary Lines To	Inter-Connect	Connect Secondary Lines To
600	H1-H2		

Secondary Volts

240		X2 to X3	X1-X4
120/240		X2 to X3	X1-X2-X4
120		X1 to X3 X2 to X4	X1-X4

9 PRIMARY: 600
SECONDARY: 120/240
TAPS: None

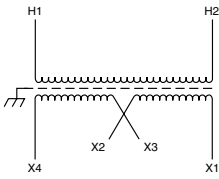

Primary Volts	Connect Primary Lines To	Inter-Connect	Connect Secondary Lines To
600	H1-H2		
Secondary Volts			
240		X2 to X3	X1-X4
120/240		X2 to X3	X1-X2-X4
120		X1 to X3 X2 to X4	X1-X4

12 PRIMARY: 240
SECONDARY: 120/240
TAPS: None

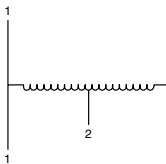

Primary Volts	Connect Primary Lines To	Inter-Connect	Connect Secondary Lines To
240	1-3		
Secondary Volts			
240			1-3
120			1-2 or 2-3
120/240			1-2-3

18 PRIMARY: 240 Volts Delta
SECONDARY: 208Y/120 Volts
TAPS: 2, 5% BNFC

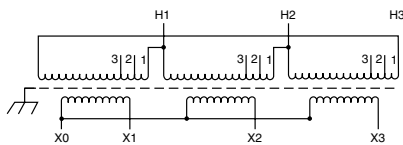

Primary Volts	Connect Primary Lines To	Inter-Connect	Connect Secondary Lines To
240	H1, H2, H3	1	
228	H1, H2, H3	2	
216	H1, H2, H3	3	
Secondary Volts			
208			X1, X2, X3
120			X1 to X0 X2 to X0 X3 to X0
1 phase			

10 PRIMARY: 600
SECONDARY: 120/240
TAPS: 2, 5% BNFC

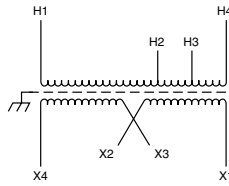

Primary Volts	Connect Primary Lines To	Inter-Connect	Connect Secondary Lines To
600	H1-H4		
570	H1-H3		
540	H1-H2		
Secondary Volts			
240		X2 to X3	X1-X4
120/240		X2 to X3	X1-X2-X4
120		X1 to X3 X2 to X4	X1-X4

14 EXPORT MODEL
PRIMARY: 190-220 x 380-440
SECONDARY: 120/240

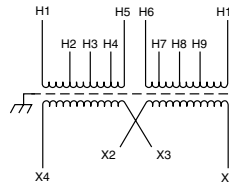

Primary Volts	Connect Primary Lines To	Inter-Connect	Connect Secondary Lines To
190	H1 & H7	H1 to H6 H2 to H7	
200	H1 & H8	H1 to H6 H3 to H8	
208	H1 & H9	H1 to H6 H4 to H9	
220	H1 & H10	H1 to H6 H5 to H10	
380	H1 & H7	H2 & H6	
400	H1 & H8	H3 & H6	
416	H1 & H9	H4 & H6	
440	H1 & H10	H5 & H6	
Secondary Volts			
240		X2 to X3	X1-X4
120/240		X2 to X3	X1-X2-X4
120		X1 to X3 X2 to X4	X1-X4

11 PRIMARY: 600
SECONDARY: 120/240
TAPS: 2, 2 1/2% ANFC, 4, 2 1/2% BNFC

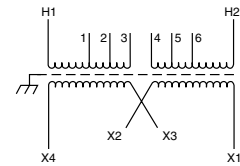

Primary Volts	Connect Primary Lines To	Inter-Connect	Connect Secondary Lines To
540	H1-H2	1-6	
555	H1-H2	1-5	
570	H1-H2	2-6	
585	H1-H2	2-5	
600	H1-H2	3-5	
615	H1-H2	2-4	
635	H1-H2	3-4	
Secondary Volts			
240		X2 to X3	X1-X4
120/240		X2 to X3	X1-X2-X4
120		X1 to X3 X2 to X4	X1-X4

17 PRIMARY: 208 Volts
SECONDARY: 120/240 Volts
TAPS:

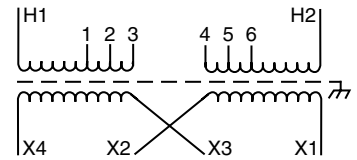

Primary Volts	Connect Primary Lines To	Inter-Connect	Connect Secondary Lines To
218	H1 & H2	3 to 4	
213	H1 & H2	2 to 4	
208	H1 & H2	3 to 5	
203	H1 & H2	2 to 5	
198	H1 & H2	1 to 5	
192	H1 & H2	2 to 6	
187	H1 & H2	1 to 6	
Secondary Volts			
240		X2 to X3	X1-X4
120/240		X2 to X3	X1-X2-X4
120		X1 to X3 X2 to X4	X1-X4

19 PRIMARY: 240 Volts Delta
SECONDARY: 208Y/120 Volts
TAPS: 2, 2 1/2% ANFC, 2, 2 1/2% BNFC

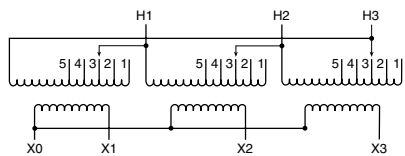

Primary Volts	Connect Primary Lines To	Inter-Connect	Connect Secondary Lines To
252	H1, H2, H3	1	
246	H1, H2, H3	2	
240	H1, H2, H3	3	
234	H1, H2, H3	4	
228	H1, H2, H3	5	

Secondary Volts

208			X1, X2, X3
120 1 phase			X1 to X0 X2 to X0 X3 to X0

22 PRIMARY: 480 Volts Delta
SECONDARY: 208Y/120 Volts
TAPS: 2, 2 1/2% ANFC, 4, 2 1/2% BNFC

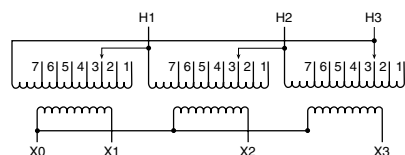

Primary Volts	Connect Primary Lines To	Inter-Connect	Connect Secondary Lines To
504	H1, H2, H3	1	
492	H1, H2, H3	2	
480	H1, H2, H3	3	
468	H1, H2, H3	4	
456	H1, H2, H3	5	
444	H1, H2, H3	6	
432	H1, H2, H3	7	

Secondary Volts

208			X1, X2, X3
120 1 phase			X1 to X0 X2 to X0 X3 to X0

20 PRIMARY: 380 Volts Delta
SECONDARY: 220Y/127 Volts
TAPS: 2, 2 1/2% ANFC, 4, 2 1/2% BNF

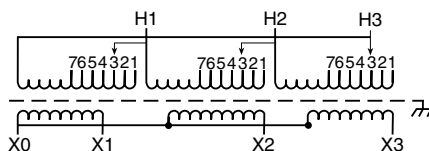

Primary Volts	Connect Primary Lines To	Inter-Connect	Connect Secondary Lines To
399	H1, H2, H3	1	
390	H1, H2, H3	2	
380	H1, H2, H3	3	
371	H1, H2, H3	4	
361	H1, H2, H3	5	
352	H1, H2, H3	6	
342	H1, H2, H3	7	

Secondary Volts

220			X1, X2, X3
127 1 phase			X1 to X0 X2 to X0 X3 to X0

23 PRIMARY: 120/208/240/277 Volts
SECONDARY: 120/240 Volts

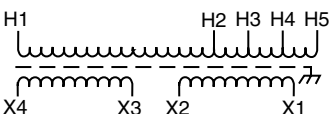

Primary Volts	Connect Primary Lines To	Inter-Connect	Connect Secondary Lines To
277	H1, H5		
240	H1, H4		
208	H1, H3		
120	H1, H2		

Secondary Volts

120		X1 to X3 X2 to X4	X1-X4
120/240		X2 to X3	X1-X2-X4
240		X2 to X3	X1-X4

21 PRIMARY: 480 Volts Delta
SECONDARY: 208Y/120 Volts
TAPS: 2, 5% BNFC

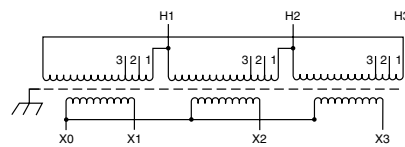

Primary Volts	Connect Primary Lines To	Inter-Connect	Connect Secondary Lines To
480	H1, H2, H3	1	
456	H1, H2, H3	2	
432	H1, H2, H3	3	

Secondary Volts

208			X1, X2, X3
120 1 phase			X1 to X0 X2 to X0 X3 to X0

24 PRIMARY: 380 Volts Delta
SECONDARY: 220Y/127 Volts
TAPS: 2, 5% BNFC

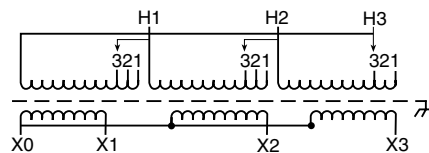

Primary Volts	Connect Primary Lines To	Inter-Connect	Connect Secondary Lines To
380	H1, H2, H3	1	
361	H1, H2, H3	2	
342	H1, H2, H3	3	

Secondary Volts

220			X1, X2, X3
127 1 phase			X1 to X0 X2 to X0 X3 to X0

25 PRIMARY: 480 Volts Delta
SECONDARY: 240 Volts Delta/120 Volts
TAPS: 2, 5% BNFC

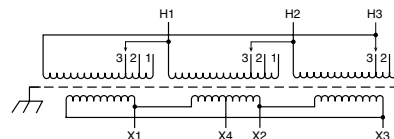

Primary Volts	Connect Primary Lines To	Inter-Connect	Connect Secondary Lines To
480	H1, H2, H3	1	
456	H1, H2, H3	2	
432	H1, H2, H3	3	

Secondary Volts

240			X1, X2, X3
120			X1, X4 or X2, X4

26 PRIMARY: 480 Volts Delta
SECONDARY: 240 Volts Delta/120 Volts
TAPS: 2, 2 1/2% ANFC, 4, 2 1/2% BNFC

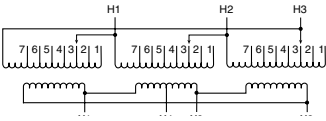

Primary Volts	Connect Primary Lines To	Inter-Connect	Connect Secondary Lines To
504	H1, H2, H3	1	
492	H1, H2, H3	2	
480	H1, H2, H3	3	
468	H1, H2, H3	4	
456	H1, H2, H3	5	
444	H1, H2, H3	6	
432	H1, H2, H3	7	
Secondary Volts			
240			X1, X2, X3
120			X1, X4 or X2, X4

31 PRIMARY: 480 Volts Delta
SECONDARY: 480Y/277 Volts
TAPS: 2, 2 1/2% ANFC, 4, 2 1/2% BNFC

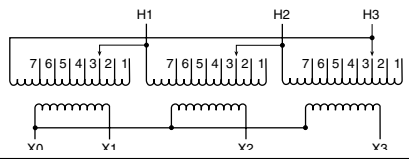

Primary Volts	Connect Primary Lines To	Inter-Connect	Connect Secondary Lines To
504	H1, H2, H3	1	
492	H1, H2, H3	2	
480	H1, H2, H3	3	
468	H1, H2, H3	4	
456	H1, H2, H3	5	
444	H1, H2, H3	6	
432	H1, H2, H3	7	
Secondary Volts			
480			X1, X2, X3
277 1 phase			X1 to X0 X2 to X0 X3 to X0

28 PRIMARY: 600 Volts Delta
SECONDARY: 208Y/120 Volts
TAPS: 2, 5% BNFC

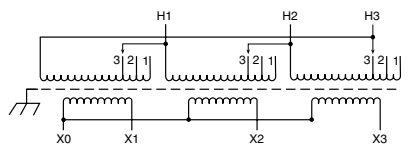

Primary Volts	Connect Primary Lines To	Inter-Connect	Connect Secondary Lines To
600	H1, H2, H3	1	
570	H1, H2, H3	2	
540	H1, H2, H3	3	
Secondary Volts			
208			X1, X2, X3
120 1 phase			X1 to X0 X2 to X0 X3 to X0

46 PRIMARY: 208 Volts Delta
SECONDARY: 480Y/277 Volts
TAPS: 2, 2 1/2% ANFC, 2, 2 1/2% BNFC

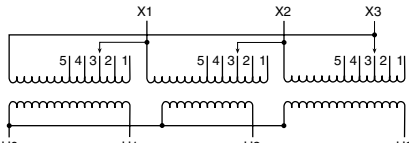

Primary Volts	Connect Primary Lines To	Inter-Connect	Connect Secondary Lines To
218	X1, X2, X3	1	
213	X1, X2, X3	2	
208	X1, X2, X3	3	
203	X1, X2, X3	4	
198	X1, X2, X3	5	
Secondary Volts			
480			H1, H2, H3
277 1 phase			H1 to H0 H2 to H0 H3 to H0

51 PRIMARY: 600 Volts Delta
SECONDARY: 480Y/277 Volts
TAPS: 2, 2 1/2% ANFC, 4, 2 1/2% BNFC

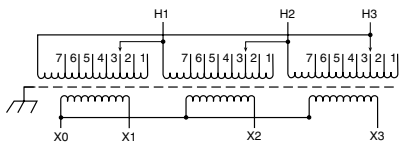

Primary Volts	Connect Primary Lines To	Inter-Connect	Connect Secondary Lines To
630	H1, H2, H3	1	
615	H1, H2, H3	2	
600	H1, H2, H3	3	
585	H1, H2, H3	4	
570	H1, H2, H3	5	
555	H1, H2, H3	6	
540	H1, H2, H3	7	
Secondary Volts			
480			X1, X2, X3
277 1 phase			X1 to X0 X2 to X0 X3 to X0

29 PRIMARY: 600 Volts Delta
SECONDARY: 208Y/120 Volts
TAPS: 2, 2 1/2% ANFC, 4, 2 1/2% BNFC

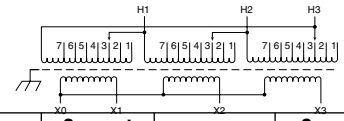

Primary Volts	Connect Primary Lines To	Inter-Connect	Connect Secondary Lines To
630	H1, H2, H3	1	
615	H1, H2, H3	2	
600	H1, H2, H3	3	
585	H1, H2, H3	4	
570	H1, H2, H3	5	
555	H1, H2, H3	6	
540	H1, H2, H3	7	
Secondary Volts			
208			X1, X2, X3
120 1 phase			X1 to X0 X2 to X0 X3 to X0

48 PRIMARY: 208 Volts Delta
SECONDARY: 480Y/277 Volts
TAPS: 2, 5% BNFC

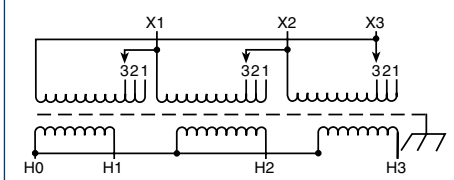

Primary Volts	Connect Primary Lines To	Inter-Connect	Connect Secondary Lines To
208	X1, X2, X3	1	
198	X1, X2, X3	2	
187	X1, X2, X3	3	
Secondary Volts			
480			H1, H2, H3
277 1 phase			H1 to H0 H2 to H0 H3 to H0

55 PRIMARY: 600 Volts Delta
SECONDARY: 480Y/277 Volts
TAPS: 2, 5% BNFC

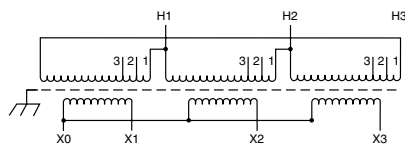

Primary Volts	Connect Primary Lines To	Inter-Connect	Connect Secondary Lines To
600	H1, H2, H3	1	
570	H1, H2, H3	2	
540	H1, H2, H3	3	

Secondary Volts			
480			X1, X2, X3
277 1 phase			X1 to X0 X2 to X0 X3 to X0

56 PRIMARY: 600 Volts
SECONDARY: 480 Volts
TAPS: 2, 5% BNFC

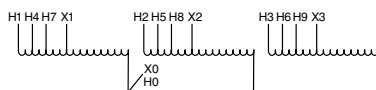

Primary Volts	Alt Rating	Connect Primary Lines To	Inter-Connect	Connect Secondary Lines To
600	480	H1, H2, H3		
570	456	H4, H5, H6		
540	432	H7, H8, H9		

Secondary Volts				
480	380			X1, X2, X3
277 1 phase	220 1 phase			X1 to X0 X2 to X0 X3 to X0

57 PRIMARY: 600 Volts
SECONDARY: 480 Volts
TAPS: 2, 5% BNFC

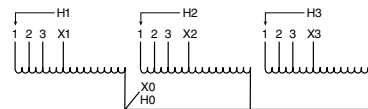

Primary Volts	Alt Rating	Connect Primary Lines To	Inter-Connect	Connect Secondary Lines To
600	480	H1, H2, H3	1	
570	456	H1, H2, H3	2	
540	432	H1, H2, H3	3	

Secondary Volts				
480	380			X1, X2, X3
277 1 phase	220 1 phase			X1 to X0 X2 to X0 X3 to X0

58 PRIMARY: 208 Volts
SECONDARY: 120/240 Volts
TAPS: 2, 5% BNFC

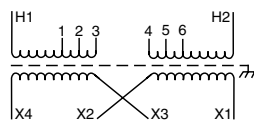

Primary Volts	Connect Primary Lines To	Inter-Connect	Connect Secondary Lines To
208	H1 & H2	3 to 4	
198	H1 & H2	2 to 5	
187	H1 & H2	1 to 6	

Secondary Volts			
240		X2 to X3	X1-X4
120/240		X2 to X3	X1-X2-X4
120		X1 to X3 X2 to X4	X1-X4

60 PRIMARY: 208 Volts Delta
SECONDARY: 208Y/120 Volts
TAPS: 2-5% BNFC

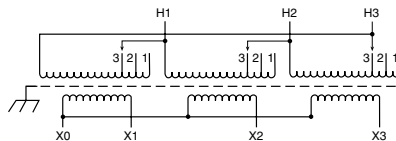

Primary Volts	%	Connect Leads to Tap No.
208	100	1
198	95	2
187	90	3

Secondary Volts		
208		X1, X2, X3
120 1 phase		X1 & X0 X2 & X0 X3 & X0

61 PRIMARY: 208 Volts Delta
SECONDARY: 208Y/120 Volts
TAPS: 2-2 1/2% ANFC and 2-2 1/2% BNFC

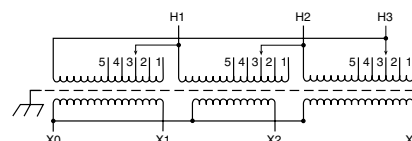

Primary Volts	%	Connect Leads to Tap No.
218	105	1
213	102.5	2
208	100	3
203	97.5	4
198	95	5

Secondary Volts		
208		X1, X2, X3
120 1 phase		X1 & X0 X2 & X0 X3 & X0

63 PRIMARY: 120/208/240/277 Volts
SECONDARY: 120/240 Volts

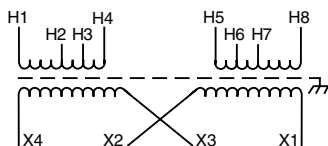

Primary Volts	Connect Primary Lines To	Inter-Connect	Connect Secondary Lines To
120	H1 & H8	H1 to H6 H3 to H8	
208	H1 & H8	H2 to H7	
240	H1 & H8	H3 to H6	
277	H1 & H8	H4 to H5	

Secondary Volts			
240		X2 to X3	X1 & X4
120/240		X2 to X3	X1, X3, X4
120		X1 to X3 X2 to X4	X1 & X4

64

**PRIMARY: 190/208/220/240 x
380/416/440/480 Volts
SECONDARY: 120/240 Volts**

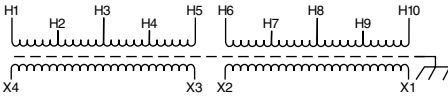

Primary Volts	Connect Primary Lines To	Inter-Connect	Connect Secondary Lines To
190	H1 & H7	H1 to H6 H2 to H7	
208	H1 & H8	H1 to H6 H3 to H8	
220	H1 & H9	H1 to H6 H4 to H9	
240	H1 & H10	H1 to H6 H5 to H10	
380	H1 & H7	H2 to H6	
416	H1 & H8	H3 to H6	
440	H1 & H9	H4 to H6	
480	H1 & H10	H5 to H6	

Secondary Volts			
240		X2 to X3	X1 - X4
120/240		X2 to X3	X1- X2 - X4
120		X1 to X3 X2 to X4	X1 - X4

70

**PRIMARY: 240 Volts Delta
SECONDARY: 480Y/277 Volts
TAPS: 2, 5% BNFC**

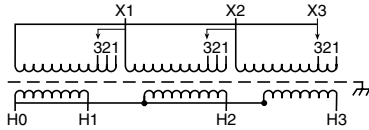

Primary Volts	%	Connect Leads to Tap No.
240	100	1
228	95	2
216	90	3

Secondary Volts		
480		H1, H2, H3
277 1 phase		H1 to H0 H2 to H0 H3 to H0

65

**PRIMARY: 190/200/208/220 x
380/400/416/440 Volts
SECONDARY: 110/220 Volts**

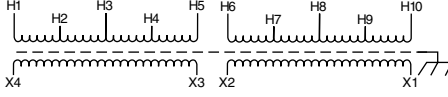

Primary Volts	Connect Primary Lines To	Inter-Connect	Connect Secondary Lines To
190	H1 & H7	H1 to H6 H2 to H7	
200	H1 & H8	H1 to H6 H3 to H8	
208	H1 & H9	H1 to H6 H4 to H9	
220	H1 & H10	H1 to H6 H5 to H10	
380	H1 & H7	H2 to H6	
400	H1 & H8	H3 to H6	
415	H1 & H9	H4 to H6	
440	H1 & H10	H5 to H6	

Secondary Volts			
220		X2 to X3	X1-X4
110/220		X2 to X3	X1-X2-X4
110		X1 to X3 X2 to X4	X1-X4

71

**PRIMARY: 240 Volts Delta
SECONDARY: 480Y/277 Volts
TAPS: 2, 2 1/2% ANFC & BNFC**

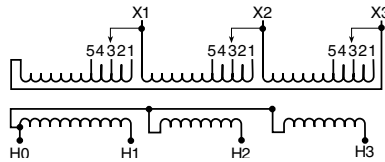

Primary Volts	Connect Primary Lines To	Inter-Connect	Connect Secondary Lines To
252	X1, X2, X3	1	
246	X1, X2, X3	2	
240	X1, X2, X3	3	
234	X1, X2, X3	4	
228	X1, X2, X3	5	

Secondary Volts			
480			H1, H2, H3
277 1 phase			H1 to H0 H2 to H0 H3 to H0

69

**PRIMARY: 600 Volts Delta
SECONDARY: 240 Delta/120 Volts
TAPS: 2, 2 1/2% ANFC, 4, 2 1/2% BNFC**

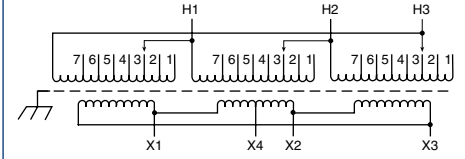

Primary Volts	%	Connect Leads to Tap No.
630	105	1
615	102.5	2
600	100	3
585	97.5	4
570	95	5
555	92.5	6
540	90	7

Secondary Volts		
240		X1, X2, X3
120		X1, X4, or X2, X4

74

**PRIMARY: 190/200/210/220/
230/240 Volts Delta
SECONDARY: 400Y/231 Volts**

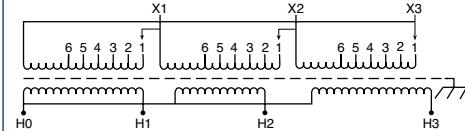

Primary Volts	Connect Primary Lines To	Inter-Connect	Connect Secondary Lines To
240	X1, X2, X3	1	
230	X1, X2, X3	2	
220	X1, X2, X3	3	
210	X1, X2, X3	4	
200	X1, X2, X3	5	
190	X1, X2, X3	6	

Secondary Volts			
400			H1, H2, H3
231 1 phase			H1 to H0 H2 to H0 H3 to H0

75 PRIMARY: 190/200/210/220/
230/240 Volts Delta
SECONDARY: 400Y/231 Volts

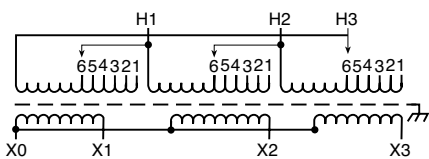

Primary Volts	Connect Primary Lines To	Inter-Connect	Connect Secondary Lines To
240	H1, H2, H3	1	
230	H1, H2, H3	2	
220	H1, H2, H3	3	
210	H1, H2, H3	4	
200	H1, H2, H3	5	
190	H1, H2, H3	6	

Secondary Volts

400			X1, X2, X3
231 1 phase			X1 to X0 X2 to X0 X3 to X0

79 PRIMARY: 277/480 Volts
SECONDARY: 208/277 Volts
TAPS: NONE

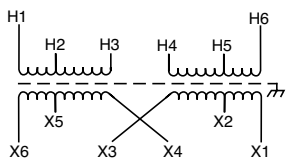

Primary Volts	Connect Primary Lines To	Inter-Connect	Connect Secondary Lines To
277	H1 - H5	H2 to H4	
480	H1 - H6	H3 to H4	

Secondary Volts

208		X2 to X4	X1 - X5
277		X3 to X4	X1 - X6

76 PRIMARY: 400 Volts Delta
SECONDARY: 240 Volts Delta/120 Volts
TAPS: 2, 5% BNFC

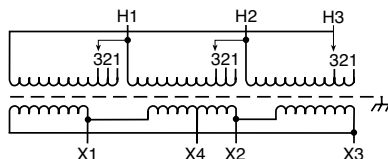

Primary Volts	Connect Primary Lines To	Inter-Connect	Connect Secondary Lines To
400	H1, H2, H3	1	
380	H1, H2, H3	2	
360	H1, H2, H3	3	

Secondary Volts

240			X1, X2, X3
120			X1 to X4 or X2 to X4

80 PRIMARY: 480 Volts Delta
SECONDARY: 208Y/120 Volts
TAPS: 1-5% ANFC & 1-5% BNFC

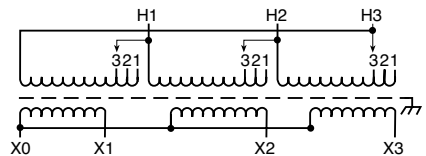

Primary Volts	Connect Primary Lines To	Inter-Connect	Connect Secondary Lines To
504	H1, H2, H3	1	
480	H1, H2, H3	2	
456	H1, H2, H3	3	

Secondary Volts

208			X1, X2, X3
120 1 phase			X1 to X0 X2 to X0 X3 to X0

78 PRIMARY: 277/480 Volts
SECONDARY: 208/277 Volts
TAPS: NONE

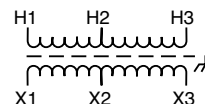

Primary Volts	Connect Primary Lines To	Inter-Connect	Connect Secondary Lines To
277	H1 & H2		
480	H1 & H3		

Secondary Volts

208			X1 to X2
277			X1 to X3

81 PRIMARY: 480 Volts Delta
SECONDARY: 208Y/120 Volts
TAPS: 2, 2 1/2% ANFC, 2, 2 1/2% BNFC

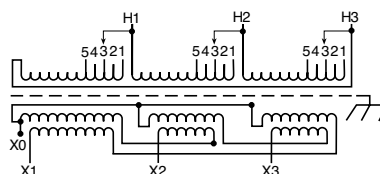

Primary Volts	Connect Primary Lines To	Inter-Connect	Connect Secondary Lines To
504	H1, H2, H3	1	
492	H1, H2, H3	2	
480	H1, H2, H3	3	
468	H1, H2, H3	4	
456	H1, H2, H3	5	

Secondary Volts

208			X1, X2, X3
120 1 phase			X1 to X0 X2 to X0 X3 to X0

Wall Mounting Brackets

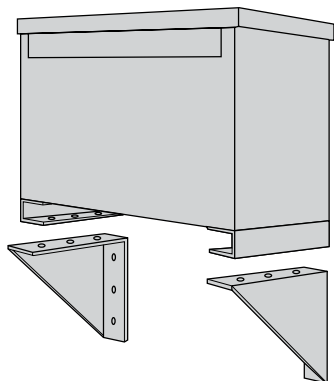

Required on:

Ventilated Units:

1Ø, 37.5 and 50 kVA
3Ø, 30, 45 and 75 kVA

Catalog Number: PL-79912

Encapsulated Units:

3Ø dit., 11 kVA — 20 kVA
3Ø std. distribution — 15 kVA

Catalog Number: PL-79911

Wall mounting brackets are not required on:

1Ø units — 25 kVA and below
3Ø units — 9 kVA and below

Suffix Tap Arrangement	
- 1S	Two 5% (-) BNFC Taps
- 2S	One 5% (+) ANFC Tap and One 5% (-) BNFC Tap
- 3S	Two 2-1/2% (+) ANFC Taps and Four 2-1/2%(-) BNFC Taps
- 4S	Two 2-1/2% (+) ANFC Taps and Two 2-1/2% (-) BNFC Taps
- 5S	Two 5% (+) ANFC Taps and Two 5% (-) BNFC Taps

The catalog number suffix provides tap information as outlined in chart below:

If the catalog number has no suffix, there are no taps available.

EXAMPLE: TP530193S

The suffix 3S indicates the unit has two 2.5% (+) ANFC taps and four 2.5% (-) BNFC taps.

Lug Kits

Acme’s mechanical transformer lug kits contain all of the hardware necessary to provide satisfactory transformer terminations. Lug kits are available in sizes from 27kVA to 660 kVA.

Acme lugs are of the dual rated single pole solderless type, made from high strength aluminum alloy. To provide the best in low contact resistance, all lugs in these kits are plated.

Catalog No.	Transformer kVA Size	Wire Range Al or Cu	Kit Contains		
			Qty	Nuts & Bolts	Qty
Lug 1	37 1/2 1-phase	2 -14	8	1/4 - 20 x 3/4	8
	27 - 45 3-phase	250 mcm - 6	4		
Lug 2	50 - 75 1-phase	250 mcm - 6	12	1/4 - 20 x 3/4	8
	51 - 118 3-phase				
Lug 3	100 -167 1-phase	250 mcm - 6	3	1/4 - 20 x 3/4	3
	145 - 300 3-phase	600 mcm - 2	22		
Lug 4	440 - 660 3-phase	600 mcm - 2	29	3/8 - 16 x 2	8

Weather Shields

Catalog No.	Approx. Ship Weight Lbs. (Kg.)
WSA1	6 (2.7)
WSA2	7 (3.2)
WSA3	8 (3.6)
WSA4	8 (3.6)
WSA5	10 (4.5)
WSA6	10 (4.5)
WSA8	7 (3.2)
WSA53	7 (3.2)
WSA58	10 (4.5)
WSA60	9.5 (4.3)
WSB1	31 (14.1)
WSB2	31 (14.1)
WSB3	30 (13.6)
WSB4	32 (14.5)
WSB5	35 (15.9)

Spare Parts

TOP COVER

CATALOG NO.	APPROX. SHIP WEIGHT Lbs. (Kg.)
SA1701319	14 (6.4)
SA2701319	16 (7.3)
SA3701319	20 (9.1)
SA4701319	34 (15.4)
SA6701319	17 (7.7)

SIDE PANEL

CATALOG NO.	APPROX. SHIP WEIGHT Lbs. (Kg.)
SA1701320	11 (5.0)
SA2701320	13 (5.9)
SA3701320	19 (8.6)
SA4701320	34 (15.4)

FRONT/REAR PANEL

CATALOG NO.	APPROX. SHIP WEIGHT Lbs. (Kg.)
SA1701321	13 (5.9)
SA2701321	15 (6.8)
SA3701321	21 (9.5)
SA4701321	35 (15.9)
SA7701321	16 (7.3)



N85 W12545 Westbrook Crossing
Menomonee Falls, WI 53051
800.334.5214

hubbell-acmeelectric.com



Hubbell Canada Inc.
905-839-1138

Hubbell de Mexico, S.A. de C.V.
52-55-9151-9999

ACM_BRO_025_1116