



GREENCREATIVE

 LAMPS



**CATALOG**



GREENCREATIVE

### Your partner for professional lighting solutions

GREEN CREATIVE, founded in 2010, is a major solid-state lighting development and manufacturing company based in the San Francisco Bay area. The company offers a comprehensive line of high-performance LED lighting solutions which has been widely adopted by some of the largest companies in the world.



### Bringing you the latest in LED technology

Anchored by strong integrated R&D capabilities and patented technology, GREEN CREATIVE's innovation, performance and reliability have been recognized year after year by the Illuminating Engineering Society Progress Report, the LEDs Magazine Sapphire Awards, Edison Report, NAILD and more.

### A complete line with national & international distribution

GREEN CREATIVE's full product line of ENERGY STAR®, DLC®, TITLE 20 & JA8 certified indoor retrofit and new construction lighting solutions serves the Retail, Hospitality, Food & Beverage, Office, Education & Industrial sectors through multiple distribution centers and sales networks across the USA.



# TABLE OF CONTENTS

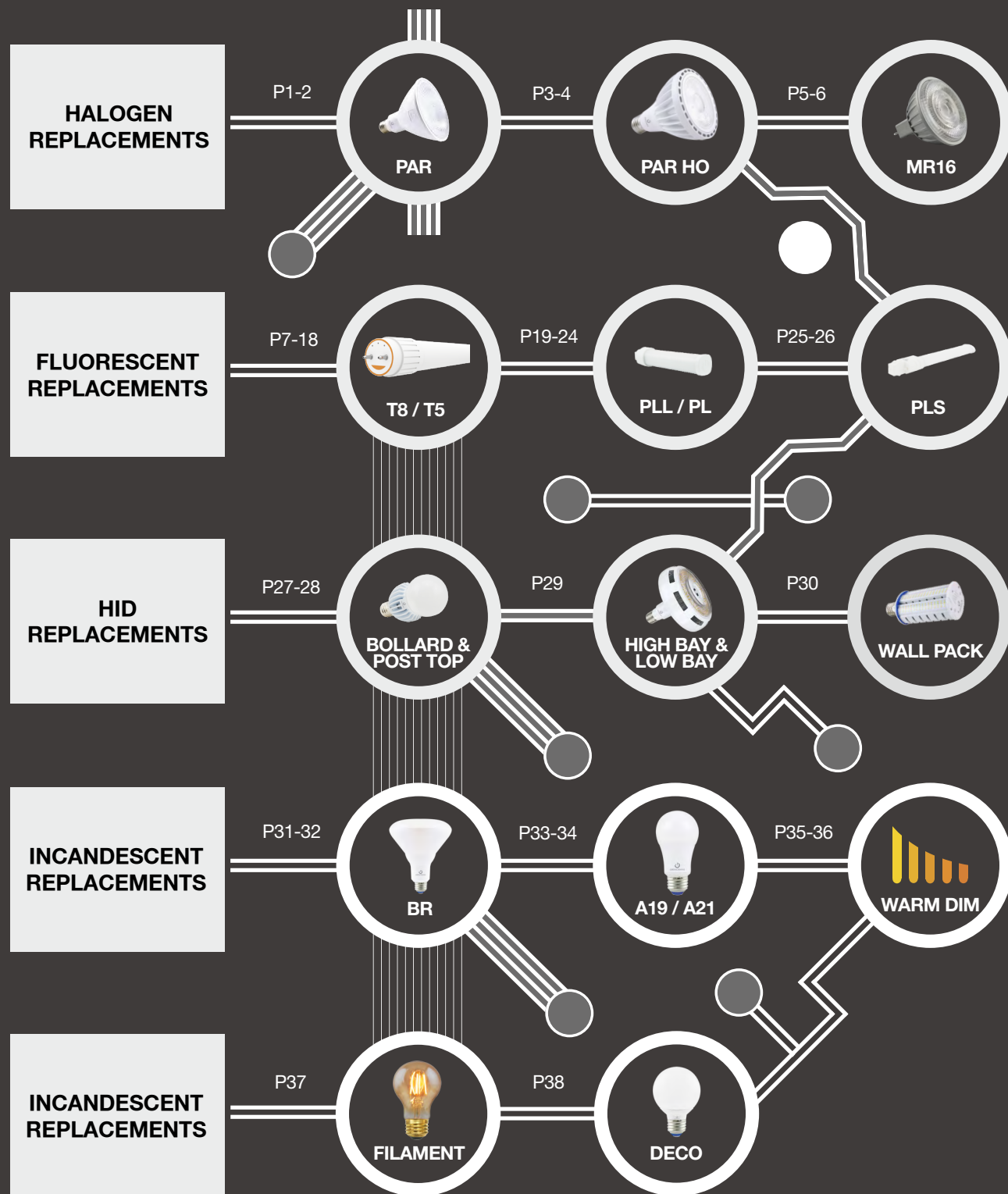

# 2019 FEATURED PRODUCTS



## PAR HO SERIES

Very high lumen & candela output  
 Exceptional color rendering CRI 92  
 Direct line voltage 120-277V  
 Narrow Flood / Flood beam angles



## MR16 HIGH CRI SERIES

Suitable for use in totally enclosed fixtures  
 Exceptional color rendering CRI 92  
 Tight LED binning for consistent CCT  
 Spot / Narrow Flood / Flood beam angles



## VALUE SELECT TUBE SERIES

T5 DIR - 4' HE/HO  
 T8 DIR - 4'  
 Deliver great value through quality  
 performance and price



## EXTERNAL TUBE SERIES

T8 - 2' / 3' / 4' / Ubent;  
 T5HE - 2' / 3' / 4'  
 T5HO - 4'  
 0-10V dimmable external driver

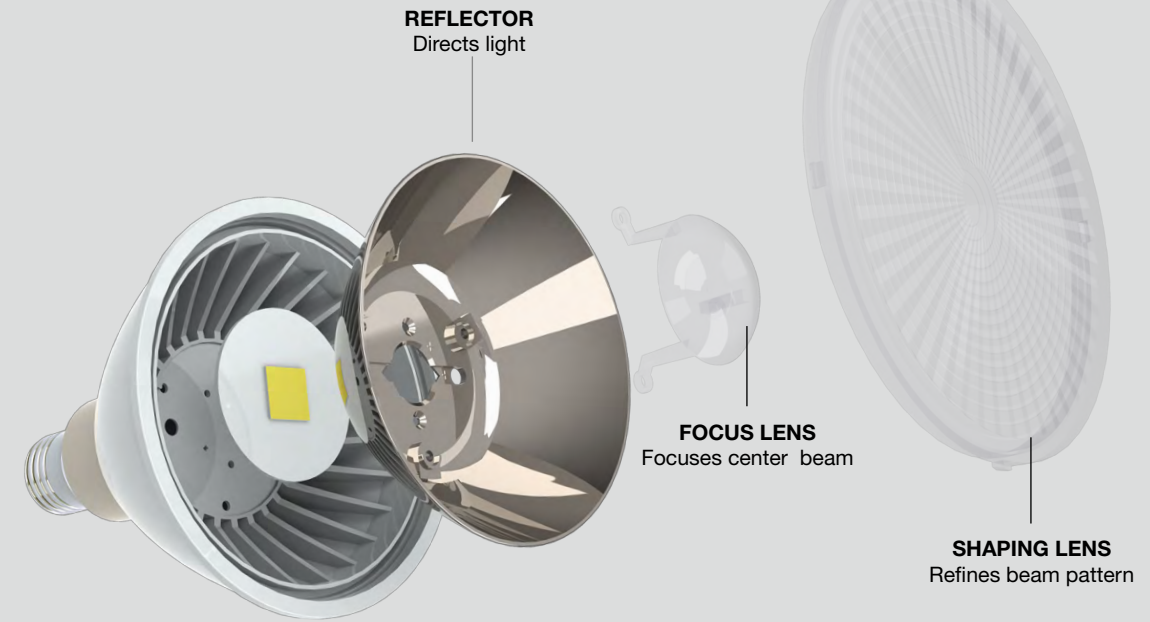

### SPECIFICATIONS

| Product | Model                  | CCT   | Lumens | CRI (typ.) | LPW | CBCP  | Dim | Equiv. | Beam Angle | Life (hrs) | Voltage  | Encl. | ES |
|---------|------------------------|-------|--------|------------|-----|-------|-----|--------|------------|------------|----------|-------|----|
| 58104   | 8PAR20DIM/927SP15      | 2700K | 535    | 92         | 67  | 5,300 | Yes | 50W    | 15°        | 50,000     | 120V     | Yes   | ✓  |
| 58105   | 8PAR20DIM/927NF25      | 2700K | 535    | 92         | 67  | 2,700 | Yes | 50W    | 25°        | 50,000     | 120V     | Yes   | ✓  |
| 58106   | 8PAR20DIM/927FL40      | 2700K | 535    | 92         | 67  | 1,170 | Yes | 50W    | 40°        | 50,000     | 120V     | Yes   | ✓  |
| 58107   | 8PAR20DIM/930SP15      | 3000K | 550    | 92         | 69  | 5,400 | Yes | 50W    | 15°        | 50,000     | 120V     | Yes   | ✓  |
| 58108   | 8PAR20DIM/930NF25      | 3000K | 550    | 92         | 69  | 2,800 | Yes | 50W    | 25°        | 50,000     | 120V     | Yes   | ✓  |
| 58109   | 8PAR20DIM/930FL40      | 3000K | 550    | 92         | 69  | 1,200 | Yes | 50W    | 40°        | 50,000     | 120V     | Yes   | ✓  |
| 58112   | 8PAR20DIM/940FL40      | 4000K | 570    | 92         | 71  | 1,250 | Yes | 50W    | 40°        | 50,000     | 120V     | Yes   | ✓  |
| 97901   | 8PAR20DIM/930FL40/B •  | 3000K | 550    | 92         | 69  | 1,200 | Yes | 50W    | 40°        | 50,000     | 120V     | Yes   | ✓  |
| 58113   | 13PAR30DIM/927SP15     | 2700K | 870    | 92         | 67  | 7,800 | Yes | 75W    | 15°        | 50,000     | 120V     | Yes   | ✓  |
| 58114   | 13PAR30DIM/927NF25     | 2700K | 1,000  | 92         | 77  | 4,500 | Yes | 90W    | 25°        | 50,000     | 120V     | Yes   | ✓  |
| 58115   | 13PAR30DIM/927FL40     | 2700K | 1,000  | 92         | 77  | 2,200 | Yes | 90W    | 40°        | 50,000     | 120V     | Yes   | ✓  |
| 58116   | 13PAR30DIM/930SP15     | 3000K | 880    | 92         | 68  | 8,000 | Yes | 75W    | 15°        | 50,000     | 120V     | Yes   | ✓  |
| 58117   | 13PAR30DIM/930NF25     | 3000K | 1,050  | 92         | 81  | 4,700 | Yes | 90W    | 25°        | 50,000     | 120V     | Yes   | ✓  |
| 58118   | 13PAR30DIM/930FL40     | 3000K | 1,050  | 92         | 81  | 2,300 | Yes | 90W    | 40°        | 50,000     | 120V     | Yes   | ✓  |
| 58121   | 13PAR30DIM/940FL40     | 4000K | 1,100  | 92         | 85  | 2,500 | Yes | 90W    | 40°        | 50,000     | 120V     | Yes   | ✓  |
| 97902   | 13PAR30DIM/930FL40/B • | 3000K | 1,050  | 92         | 81  | 2,300 | Yes | 90W    | 40°        | 50,000     | 120V     | Yes   | ✓  |
| 58127   | 13PAR30/930FL40/277V   | 3000K | 1,050  | 92         | 81  | 2,300 | No  | 90W    | 40°        | 50,000     | 120-277V | Yes   | ✓  |
| 58130   | 13PAR30/940FL40/277V   | 4000K | 1,100  | 92         | 85  | 2,500 | No  | 90W    | 40°        | 50,000     | 120-277V | Yes   | ✓  |

• Black finish

### SPECIFICATIONS

| Product | Model                    | CCT   | Lumens | CRI (typ.) | LPW | CBCP   | Dim | Equiv. | Beam Angle | Life (hrs) | Voltage  | Encl. | ES |
|---------|--------------------------|-------|--------|------------|-----|--------|-----|--------|------------|------------|----------|-------|----|
| 58140   | 13PAR30SNDIM/927SP15     | 2700K | 870    | 92         | 67  | 7,800  | Yes | 75W    | 15°        | 50,000     | 120V     | Yes   | ✓  |
| 58141   | 13PAR30SNDIM/927NF25     | 2700K | 1,000  | 92         | 77  | 4,500  | Yes | 90W    | 25°        | 50,000     | 120V     | Yes   | ✓  |
| 58142   | 13PAR30SNDIM/927FL40     | 2700K | 1,000  | 92         | 77  | 2,200  | Yes | 90W    | 40°        | 50,000     | 120V     | Yes   | ✓  |
| 58143   | 13PAR30SNDIM/930SP15     | 3000K | 880    | 92         | 68  | 8,000  | Yes | 75W    | 15°        | 50,000     | 120V     | Yes   | ✓  |
| 58144   | 13PAR30SNDIM/930NF25     | 3000K | 1,050  | 92         | 81  | 4,700  | Yes | 90W    | 25°        | 50,000     | 120V     | Yes   | ✓  |
| 58145   | 13PAR30SNDIM/930FL40     | 3000K | 1,050  | 92         | 81  | 2,300  | Yes | 90W    | 40°        | 50,000     | 120V     | Yes   | ✓  |
| 58148   | 13PAR30SNDIM/940FL40     | 4000K | 1,100  | 92         | 85  | 2,500  | Yes | 90W    | 40°        | 50,000     | 120V     | Yes   | ✓  |
| 97903   | 13PAR30SNDIM/930FL40/B • | 3000K | 1,050  | 92         | 81  | 2,300  | Yes | 90W    | 40°        | 50,000     | 120V     | Yes   | ✓  |
| 58149   | 17PAR38DIM/927SP15       | 2700K | 1,150  | 92         | 68  | 12,200 | Yes | 120W   | 15°        | 50,000     | 120V     | Yes   | ✓  |
| 58150   | 17PAR38DIM/927NF25       | 2700K | 1,400  | 92         | 82  | 7,300  | Yes | 120W   | 25°        | 50,000     | 120V     | Yes   | ✓  |
| 58151   | 17PAR38DIM/927FL40       | 2700K | 1,400  | 92         | 82  | 3,100  | Yes | 120W   | 40°        | 50,000     | 120V     | Yes   | ✓  |
| 58152   | 17PAR38DIM/930SP15       | 3000K | 1,200  | 92         | 71  | 12,500 | Yes | 120W   | 15°        | 50,000     | 120V     | Yes   | ✓  |
| 58153   | 17PAR38DIM/930NF25       | 3000K | 1,430  | 92         | 84  | 7,500  | Yes | 120W   | 25°        | 50,000     | 120V     | Yes   | ✓  |
| 58154   | 17PAR38DIM/930FL40       | 3000K | 1,430  | 92         | 84  | 3,200  | Yes | 120W   | 40°        | 50,000     | 120V     | Yes   | ✓  |
| 58157   | 17PAR38DIM/940FL40       | 4000K | 1,450  | 92         | 85  | 3,300  | Yes | 120W   | 40°        | 50,000     | 120V     | Yes   | ✓  |
| 97904   | 17PAR38DIM/930NF25/B •   | 3000K | 1,430  | 92         | 84  | 7,500  | Yes | 120W   | 25°        | 50,000     | 120V     | Yes   | ✓  |
| 97905   | 17PAR38DIM/930FL40/B •   | 3000K | 1,430  | 92         | 84  | 3,200  | Yes | 120W   | 40°        | 50,000     | 120V     | Yes   | ✓  |
| 58172   | 17PAR38DIM/930FL40/GU24  | 3000K | 1,430  | 92         | 84  | 3,200  | Yes | 120W   | 40°        | 50,000     | 120V     | Yes   | ✓  |
| 58163   | 17PAR38/930FL40/277V     | 3000K | 1,430  | 92         | 84  | 3,200  | No  | 120W   | 40°        | 50,000     | 120-277V | Yes   | ✓  |
| 58166   | 17PAR38/940FL40/277V     | 4000K | 1,450  | 92         | 85  | 3,300  | No  | 120W   | 40°        | 50,000     | 120-277V | Yes   | ✓  |

• Black finish

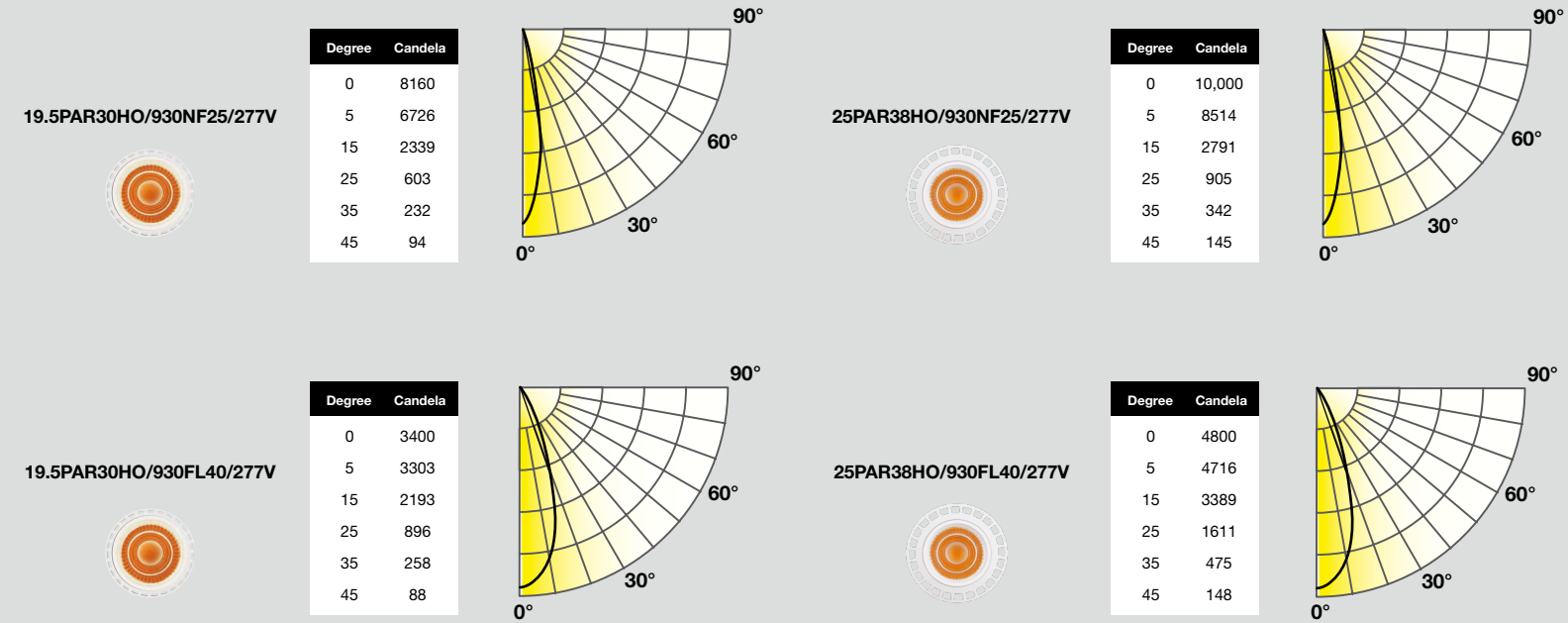

- Very high candela output PAR HO to replace 75W/250W halogen
- Exceptional color rendering CRI 92
- Richer reds and natural skin tones (R9 57, R13 91)
- Direct line voltage 120-277V - Not compatible with ballasts

## SPECIFICATIONS

| Product | Model                    | CCT   | Lumens | CRI (typ.) | LPW | CBCP   | Dim | Equiv. | Beam Angle | Life (hrs) | Voltage  | Encl. | ES |
|---------|--------------------------|-------|--------|------------|-----|--------|-----|--------|------------|------------|----------|-------|----|
| 98206   | 19.5PAR30HO/930NF25/277V | 3000K | 1,700  | 92         | 87  | 8,160  | No  | 75W    | 25°        | 50,000     | 120-277V | No    | ✓  |
| 98207   | 19.5PAR30HO/930FL40/277V | 3000K | 1,700  | 92         | 87  | 3,400  | No  | 75W    | 40°        | 50,000     | 120-277V | No    | ✓  |
| 98208   | 19.5PAR30HO/940NF25/277V | 4000K | 1,700  | 92         | 87  | 8,160  | No  | 75W    | 25°        | 50,000     | 120-277V | No    | ✓  |
| 98209   | 19.5PAR30HO/940FL40/277V | 4000K | 1,700  | 92         | 87  | 3,400  | No  | 75W    | 40°        | 50,000     | 120-277V | No    | ✓  |
| 98223   | 25PAR38HO/927NF25/277V   | 2700K | 2,400  | 92         | 96  | 10,000 | No  | 250W   | 25°        | 50,000     | 120-277V | No    | ✓  |
| 98210   | 25PAR38HO/930NF25/277V   | 3000K | 2,500  | 92         | 100 | 10,200 | No  | 250W   | 25°        | 50,000     | 120-277V | No    | ✓  |
| 98211   | 25PAR38HO/930FL40/277V   | 3000K | 2,500  | 92         | 100 | 4,800  | No  | 250W   | 40°        | 50,000     | 120-277V | No    | ✓  |
| 98212   | 25PAR38HO/940NF25/277V   | 4000K | 2,500  | 92         | 100 | 10,000 | No  | 250W   | 25°        | 40,000     | 120-277V | No    | ✓  |
| 98213   | 25PAR38HO/940FL40/277V   | 4000K | 2,500  | 92         | 100 | 4,800  | No  | 250W   | 40°        | 40,000     | 120-277V | No    | ✓  |

## PAR HO - High CRI

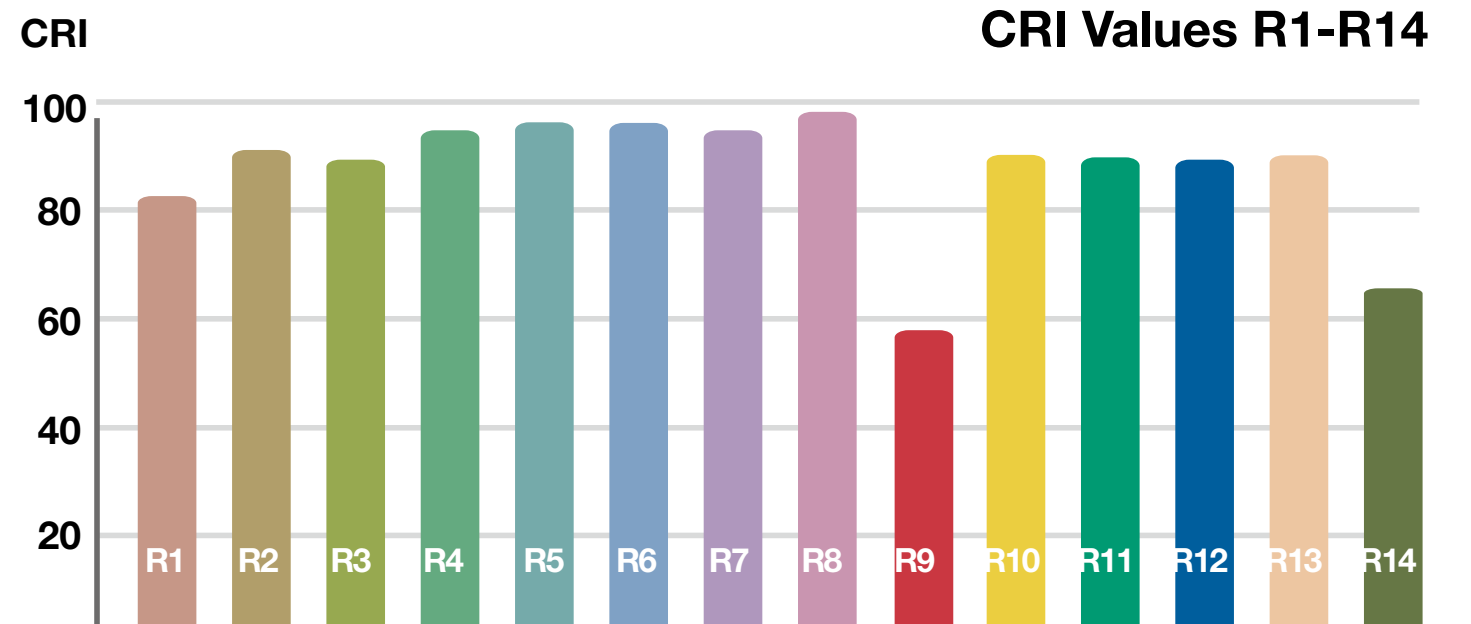



- Suitable to replace 50W, 75W Halogen MR16 lamps
- Exceptional color rendering CRI 92
- Richer reds and natural skin tones (R9 53, R13 93)
- Suitable for use in totally enclosed fixtures

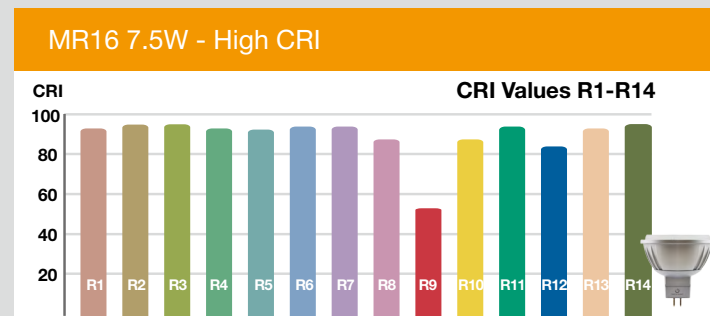

- Suitable to replace 20W, 35W, 50W, 60W Halogen MR16 lamps
- Compatible with most low-voltage electronic transformers
- Smooth dimming with most electronic low-voltage dimming controls
- Suitable for use in totally enclosed fixtures

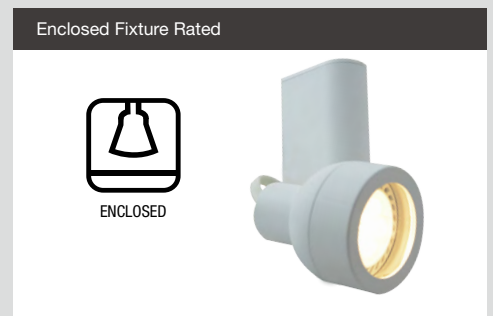

| SPECIFICATIONS |                    |       |        |            |     |       |     |        |            |            |         |       |                |
|----------------|--------------------|-------|--------|------------|-----|-------|-----|--------|------------|------------|---------|-------|----------------|
| Product        | Model              | CCT   | Lumens | CRI (typ.) | LPW | CBCP  | Dim | Equiv. | Beam Angle | Life (hrs) | Voltage | Encl. | ES / JA8 / T20 |
| 98151          | 5.5GU10DIM/927FL35 | 2700K | 450    | 92         | 82  | 800   | Yes | 50W    | 35°        | 25,000     | 120V    | Yes   | ✓/✓/✓          |
| 98152          | 5.5GU10DIM/930FL35 | 3000K | 470    | 92         | 85  | 850   | Yes | 50W    | 35°        | 25,000     | 120V    | Yes   | ✓/✓/✓          |
| 98153          | 7MR16DIM/927FL35   | 2700K | 530    | 92         | 76  | 1,350 | Yes | 50W    | 35°        | 25,000     | 12V     | Yes   | ✓/✓/✓          |
| 98154          | 7MR16DIM/930FL35   | 3000K | 550    | 92         | 79  | 1,400 | Yes | 50W    | 35°        | 25,000     | 12V     | Yes   | ✓/✓/✓          |
| 98155          | 7MR16DIM/940FL35   | 4000K | 570    | 92         | 81  | 1,450 | Yes | 50W    | 35°        | 25,000     | 12V     | Yes   | ✓/N.A./✓       |
| 98481          | 7MR16DIM/927SP15   | 2700K | 580    | 92         | 83  | 5,850 | Yes | 75W    | 15°        | 25,000     | 12V     | Yes   | ✓/✓/✓          |
| 98482          | 7.5MR16DIM/927NF25 | 2700K | 580    | 92         | 77  | 2,800 | Yes | 75W    | 25°        | 25,000     | 12V     | Yes   | ✓/✓/✓          |
| 98483          | 7.5MR16DIM/927FL35 | 2700K | 580    | 92         | 77  | 1,600 | Yes | 75W    | 35°        | 25,000     | 12V     | Yes   | ✓/✓/✓          |
| 98484          | 7MR16DIM/930SP15   | 3000K | 580    | 92         | 83  | 5,850 | Yes | 75W    | 15°        | 25,000     | 12V     | Yes   | ✓/✓/✓          |
| 98485          | 7.5MR16DIM/930NF25 | 3000K | 580    | 92         | 77  | 2,800 | Yes | 75W    | 25°        | 25,000     | 12V     | Yes   | ✓/✓/✓          |
| 98486          | 7.5MR16DIM/930FL35 | 3000K | 580    | 92         | 77  | 2,800 | Yes | 75W    | 25°        | 25,000     | 12V     | Yes   | ✓/✓/✓          |

| SPECIFICATIONS |                        |       |        |            |     |       |     |        |            |            |         |       |      |  |
|----------------|------------------------|-------|--------|------------|-----|-------|-----|--------|------------|------------|---------|-------|------|--|
| Product        | Model                  | CCT   | Lumens | CRI (typ.) | LPW | CBCP  | Dim | Equiv. | Beam Angle | Life (hrs) | Voltage | Encl. | ES   |  |
| 40713          | 3MR11/827NF30          | 2700K | 200    | 82         | 67  | 600   | No  | 20W    | 30°        | 25,000     | 12V     | Yes   | N.A. |  |
| 40715          | 3MR11/840NF30          | 4000K | 220    | 82         | 73  | 620   | No  | 20W    | 30°        | 25,000     | 12V     | Yes   | N.A. |  |
| 58285          | 6MR16DIM/827FL35/35W/R | 2700K | 425    | 82         | 71  | 910   | Yes | 35W    | 35°        | 25,000     | 120V    | Yes   | ✓    |  |
| 58286          | 6MR16DIM/830FL35/35W/R | 3000K | 450    | 82         | 75  | 910   | Yes | 35W    | 35°        | 25,000     | 120V    | Yes   | ✓    |  |
| 57984          | 6MR16DIM/827FL35/R     | 2700K | 480    | 82         | 80  | 1,350 | Yes | 50W    | 35°        | 25,000     | 12V     | Yes   | ✓    |  |
| 57985          | 6MR16DIM/830FL35/R     | 3000K | 500    | 82         | 83  | 1,400 | Yes | 50W    | 35°        | 25,000     | 12V     | Yes   | ✓    |  |
| 57986          | 6MR16DIM/840FL35/R     | 4000K | 520    | 82         | 86  | 1,450 | Yes | 50W    | 35°        | 25,000     | 12V     | Yes   | ✓    |  |
| 57987          | 6GU10DIM/827FL35/R     | 2700K | 480    | 82         | 80  | 1,000 | Yes | 50W    | 35°        | 25,000     | 120V    | Yes   | ✓    |  |
| 57988          | 6GU10DIM/830FL35/R     | 3000K | 500    | 82         | 83  | 1,050 | Yes | 50W    | 35°        | 25,000     | 120V    | Yes   | ✓    |  |
| 57990          | 6PAR16DIM/827FL35/R    | 2700K | 480    | 82         | 80  | 1,000 | Yes | 60W    | 35°        | 25,000     | 120V    | Yes   | ✓    |  |
| 57991          | 6PAR16DIM/830FL35/R    | 3000K | 500    | 82         | 83  | 1,050 | Yes | 60W    | 35°        | 25,000     | 120V    | Yes   | ✓    |  |

# T8 DIR LINE



DIRect

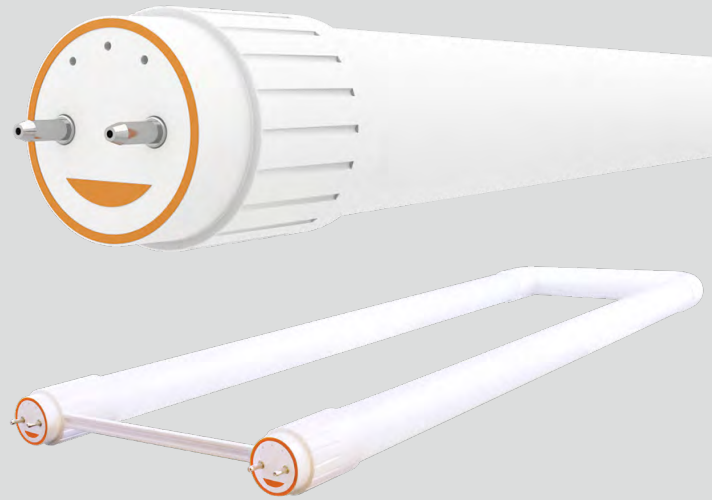

Compatible with Electronic Ballasts - Dimmable

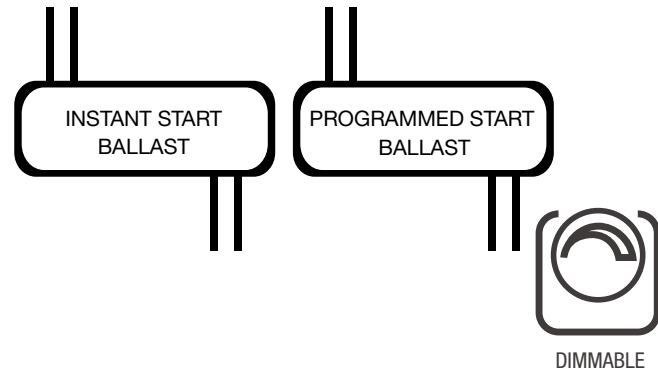

Extra Wide Beam Design - End-to-End Lighting

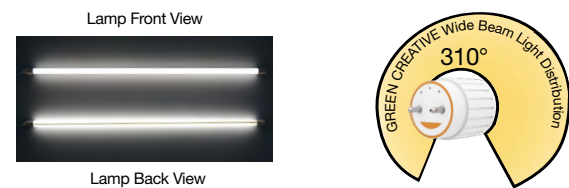

- Easy to install – Plug & play direct
- Instant Start & Programmed Start ballast compatible
- 0-10V dimming ballast compatible
- Meets NSF requirements (use of a shatter guard required)

## SPECIFICATIONS

| Product | Model                | CCT   | Lumens | CRI (typ.) | LPW | Dim | Equiv. | Beam Angle | Life (hrs) | Voltage  | Encl. | DLC |
|---------|----------------------|-------|--------|------------|-----|-----|--------|------------|------------|----------|-------|-----|
| 97841   | 8T8/2F/830/DIR/R     | 3000K | 1,300  | 82         | 163 | Yes | 17W    | 160°       | 50,000     | 120-277V | Yes   | ✓   |
| 97842   | 8T8/2F/835/DIR/R     | 3500K | 1,300  | 82         | 163 | Yes | 17W    | 160°       | 50,000     | 120-277V | Yes   | ✓   |
| 97843   | 8T8/2F/840/DIR/R     | 4000K | 1,300  | 82         | 163 | Yes | 17W    | 160°       | 50,000     | 120-277V | Yes   | ✓   |
| 98352   | 8T8/3F/830/DIR/R     | 3000K | 1,200  | 82         | 150 | Yes | 25W    | 160°       | 50,000     | 120-277V | Yes   | ✓   |
| 98353   | 8T8/3F/835/DIR/R     | 3500K | 1,200  | 82         | 150 | Yes | 25W    | 160°       | 50,000     | 120-277V | Yes   | ✓   |
| 98354   | 8T8/3F/840/DIR/R     | 4000K | 1,250  | 82         | 156 | Yes | 25W    | 160°       | 50,000     | 120-277V | Yes   | ✓   |
| 28397   | 10.5T8/4F/830/DIR/RC | 3000K | 1,650  | 82         | 157 | Yes | 32W    | 160°       | 50,000     | 120-277V | Yes   | ✓   |
| 28398   | 10.5T8/4F/835/DIR/RC | 3500K | 1,650  | 82         | 157 | Yes | 32W    | 160°       | 50,000     | 120-277V | Yes   | ✓   |
| 28399   | 10.5T8/4F/840/DIR/RC | 4000K | 1,700  | 82         | 162 | Yes | 32W    | 160°       | 50,000     | 120-277V | Yes   | ✓   |
| 28400   | 10.5T8/4F/850/DIR/RC | 5000K | 1,700  | 82         | 162 | Yes | 32W    | 160°       | 50,000     | 120-277V | Yes   | ✓   |
| 28403   | 13T8/4F/840/DIR/R    | 4000K | 2,050  | 82         | 158 | Yes | 32W    | 160°       | 50,000     | 120-277V | Yes   | ✓   |
| 28404   | 13T8/4F/850/DIR/R    | 5000K | 2,050  | 82         | 158 | Yes | 32W    | 160°       | 50,000     | 120-277V | Yes   | ✓   |
| 97958   | 16T8U6/830/DIR       | 3000K | 2,200  | 82         | 138 | Yes | 32W    | 140°       | 50,000     | 120-277V | Yes   | ✓   |
| 97959   | 16T8U6/840/DIR       | 4000K | 2,200  | 82         | 138 | Yes | 32W    | 140°       | 50,000     | 120-277V | Yes   | ✓   |
| 97960   | 16T8U6/850/DIR       | 5000K | 2,250  | 82         | 141 | Yes | 32W    | 140°       | 50,000     | 120-277V | Yes   | ✓   |

# T5 DIR LINE



DIRect



Compatible with Electronic Ballasts - Dimmable

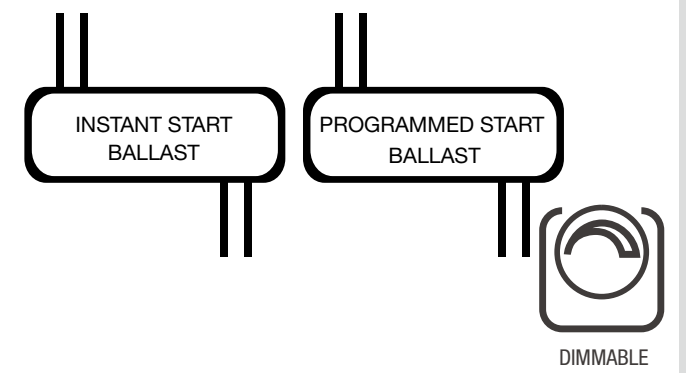

- Easy to install – Plug & play direct
- Instant Start & Programmed Start ballast compatible
- Plastic construction meets NSF requirements
- 0-10V dimming ballast compatible

## SPECIFICATIONS

| Product | Model               | CCT   | Lumens | CRI (typ.) | LPW | Dim | Equiv. | Beam Angle | Life (hrs) | Voltage  | Encl. | DLC  |
|---------|---------------------|-------|--------|------------|-----|-----|--------|------------|------------|----------|-------|------|
| 57958   | 8T5HE/2F/830/DIR    | 3000K | 950    | 82         | 119 | Yes | 14W    | 120°       | 50,000     | 120-277V | Yes   | N.A. |
| 57959   | 8T5HE/2F/835/DIR    | 3500K | 950    | 82         | 119 | Yes | 14W    | 120°       | 50,000     | 120-277V | Yes   | N.A. |
| 57960   | 8T5HE/2F/840/DIR    | 4000K | 1,020  | 82         | 128 | Yes | 14W    | 120°       | 50,000     | 120-277V | Yes   | N.A. |
| 57954   | 12T5HE/3F/830/DIR   | 3000K | 1,420  | 82         | 118 | Yes | 21W    | 120°       | 50,000     | 120-277V | Yes   | N.A. |
| 57955   | 12T5HE/3F/835/DIR   | 3500K | 1,420  | 82         | 118 | Yes | 21W    | 120°       | 50,000     | 120-277V | Yes   | N.A. |
| 57956   | 12T5HE/3F/840/DIR   | 4000K | 1,500  | 82         | 125 | Yes | 21W    | 120°       | 50,000     | 120-277V | Yes   | N.A. |
| 97929   | 15T5HE/4F/830/DIR/R | 3000K | 2,200  | 82         | 147 | Yes | 28W    | 120°       | 50,000     | 120-277V | Yes   | ✓    |
| 97930   | 15T5HE/4F/835/DIR/R | 3500K | 2,200  | 82         | 147 | Yes | 28W    | 120°       | 50,000     | 120-277V | Yes   | ✓    |
| 97931   | 15T5HE/4F/840/DIR/R | 4000K | 2,250  | 82         | 150 | Yes | 28W    | 120°       | 50,000     | 120-277V | Yes   | ✓    |
| 97932   | 15T5HE/4F/850/DIR/R | 5000K | 2,250  | 82         | 150 | Yes | 28W    | 120°       | 50,000     | 120-277V | Yes   | ✓    |
| 98165   | 10.5T5HO/2F/830/DIR | 3000K | 1,500  | 82         | 143 | Yes | 24W    | 120°       | 50,000     | 120-277V | Yes   | N.A. |
| 98166   | 10.5T5HO/2F/835/DIR | 3500K | 1,500  | 82         | 143 | Yes | 24W    | 120°       | 50,000     | 120-277V | Yes   | N.A. |
| 98167   | 10.5T5HO/2F/840/DIR | 4000K | 1,600  | 82         | 152 | Yes | 24W    | 120°       | 50,000     | 120-277V | Yes   | N.A. |
| 98168   | 14.5T5HO/3F/830/DIR | 3000K | 2,050  | 82         | 142 | Yes | 39W    | 120°       | 50,000     | 120-277V | Yes   | N.A. |
| 98169   | 14.5T5HO/3F/835/DIR | 3500K | 2,050  | 82         | 142 | Yes | 39W    | 120°       | 50,000     | 120-277V | Yes   | N.A. |
| 98170   | 14.5T5HO/3F/840/DIR | 4000K | 2,200  | 82         | 152 | Yes | 39W    | 120°       | 50,000     | 120-277V | Yes   | N.A. |
| 97924   | 24T5HO/4F/830/DIR/R | 3000K | 3,450  | 82         | 144 | Yes | 54W    | 120°       | 50,000     | 120-277V | Yes   | ✓    |
| 97925   | 24T5HO/4F/835/DIR/R | 3500K | 3,450  | 82         | 144 | Yes | 54W    | 120°       | 50,000     | 120-277V | Yes   | ✓    |
| 97926   | 24T5HO/4F/840/DIR/R | 4000K | 3,500  | 82         | 146 | Yes | 54W    | 120°       | 50,000     | 120-277V | Yes   | ✓    |
| 97927   | 24T5HO/4F/850/DIR/R | 5000K | 3,500  | 82         | 146 | Yes | 54W    | 120°       | 50,000     | 120-277V | Yes   | ✓    |

# T8 DIR VALUE SELECT LINE

# T5 DIR VALUE SELECT LINE

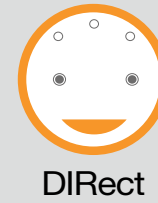

- Easy to install – Plug & play direct
- Instant Start ballast compatible
- Meets NSF Requirements (use of a shatter guard required)

- Easy to install – Plug & play direct
- Instant Start & Programmed Start ballast compatible
- Glass construction
- 0-10V dimming ballast compatible

## SPECIFICATIONS

| Product | Model                | CCT   | Lumens | CRI (typ.) | LPW | Dim | Equiv. | Beam Angle | Life (hrs) | Voltage  | Encl. | DLC |
|---------|----------------------|-------|--------|------------|-----|-----|--------|------------|------------|----------|-------|-----|
| 98551   | 10.5T8/4F/830/IS/DIR | 3000K | 1,600  | 82         | 152 | No  | 32W    | 160°       | 50,000     | 120-277V | Yes   | ✓   |
| 98552   | 10.5T8/4F/835/IS/DIR | 3500K | 1,600  | 82         | 152 | No  | 32W    | 160°       | 50,000     | 120-277V | Yes   | ✓   |
| 98553   | 10.5T8/4F/840/IS/DIR | 4000K | 1,650  | 82         | 157 | No  | 32W    | 160°       | 50,000     | 120-277V | Yes   | ✓   |
| 98554   | 10.5T8/4F/850/IS/DIR | 5000K | 1,650  | 82         | 157 | No  | 32W    | 160°       | 50,000     | 120-277V | Yes   | ✓   |
| 98557   | 13T8/4F/840/IS/DIR   | 4000K | 2,000  | 82         | 154 | No  | 32W    | 160°       | 50,000     | 120-277V | Yes   | ✓   |
| 98558   | 13T8/4F/850/IS/DIR   | 5000K | 2,000  | 82         | 154 | No  | 32W    | 160°       | 50,000     | 120-277V | Yes   | ✓   |

## SPECIFICATIONS

| Product | Model                | CCT   | Lumens | CRI (typ.) | LPW | Dim | Equiv. | Beam Angle | Life (hrs) | Voltage  | Encl. | DLC |
|---------|----------------------|-------|--------|------------|-----|-----|--------|------------|------------|----------|-------|-----|
| 98490   | 15T5HE/4F/830/GL/DIR | 3000K | 2,200  | 82         | 142 | Yes | 28W    | 120°       | 50,000     | 120-277V | Yes   | ✓   |
| 98491   | 15T5HE/4F/835/GL/DIR | 3500K | 2,200  | 82         | 142 | Yes | 28W    | 120°       | 50,000     | 120-277V | Yes   | ✓   |
| 98492   | 15T5HE/4F/840/GL/DIR | 4000K | 2,250  | 82         | 152 | Yes | 28W    | 120°       | 50,000     | 120-277V | Yes   | ✓   |
| 98494   | 24T5HO/4F/830/GL/DIR | 3000K | 3,450  | 82         | 144 | Yes | 54W    | 120°       | 50,000     | 120-277V | Yes   | ✓   |
| 98495   | 24T5HO/4F/835/GL/DIR | 3500K | 3,450  | 82         | 144 | Yes | 54W    | 120°       | 50,000     | 120-277V | Yes   | ✓   |
| 98496   | 24T5HO/4F/840/GL/DIR | 4000K | 3,500  | 82         | 146 | Yes | 54W    | 120°       | 50,000     | 120-277V | Yes   | ✓   |
| 98497   | 24T5HO/4F/850/GL/DIR | 5000K | 3,500  | 82         | 146 | Yes | 54W    | 120°       | 50,000     | 120-277V | Yes   | ✓   |





BYPass

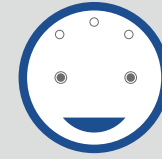

BYPass



FLICKER FREE

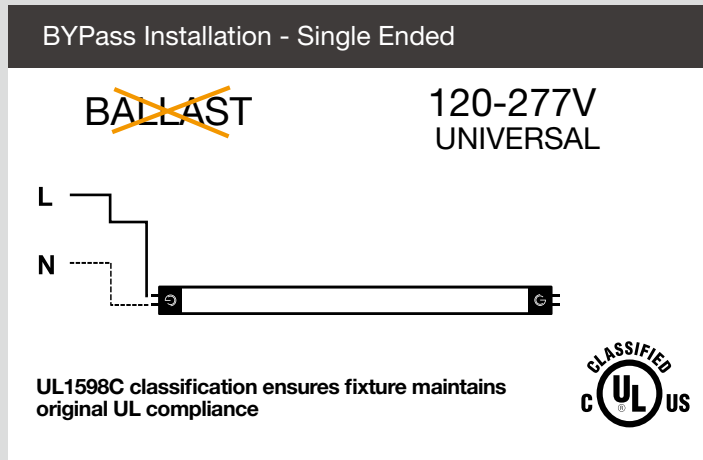

- Integral driver suitable for 120-277V
- Compatible with non-shunted lamp holders only
- Extra high efficacy series up to 167LPW available
- Meets NSF requirements (use of a shatter guard required)

| SPECIFICATIONS |                    |       |        |            |     |     |        |            |            |          |       |      |
|----------------|--------------------|-------|--------|------------|-----|-----|--------|------------|------------|----------|-------|------|
| Product        | Model              | CCT   | Lumens | CRI (typ.) | LPW | Dim | Equiv. | Beam Angle | Life (hrs) | Voltage  | Encl. | DLC  |
| 28413          | 8T8/2F/830/BYP/R   | 3000K | 1,000  | 82         | 125 | No  | 17W    | 160°       | 50,000     | 120-277V | Yes   | ✓    |
| 28414          | 8T8/2F/835/BYP/R   | 3500K | 1,050  | 82         | 131 | No  | 17W    | 160°       | 50,000     | 120-277V | Yes   | ✓    |
| 28415          | 8T8/2F/840/BYP/R   | 4000K | 1,050  | 82         | 131 | No  | 17W    | 160°       | 50,000     | 120-277V | Yes   | ✓    |
| 97893          | 12T8/3F/830/BYP/R  | 3000K | 1,500  | 82         | 125 | No  | 25W    | 160°       | 50,000     | 120-277V | Yes   | ✓    |
| 97894          | 12T8/3F/835/BYP/R  | 3500K | 1,500  | 82         | 125 | No  | 25W    | 160°       | 50,000     | 120-277V | Yes   | ✓    |
| 97895          | 12T8/3F/840/BYP/R  | 4000K | 1,550  | 82         | 129 | No  | 25W    | 160°       | 50,000     | 120-277V | Yes   | ✓    |
| 28405          | 13T8/4F/830/BYP/R  | 3000K | 1,650  | 82         | 123 | No  | 32W    | 160°       | 50,000     | 120-277V | Yes   | ✓    |
| 28406          | 13T8/4F/835/BYP/R  | 3500K | 1,650  | 82         | 127 | No  | 32W    | 160°       | 50,000     | 120-277V | Yes   | ✓    |
| 28407          | 13T8/4F/840/BYP/R  | 4000K | 1,700  | 82         | 131 | No  | 32W    | 160°       | 50,000     | 120-277V | Yes   | ✓    |
| 28408          | 13T8/4F/850/BYP/R  | 5000K | 1,700  | 82         | 131 | No  | 32W    | 160°       | 50,000     | 120-277V | Yes   | ✓    |
| 28411          | 16T8/4F/840/BYP/R  | 4000K | 2,050  | 82         | 128 | No  | 32W    | 160°       | 50,000     | 120-277V | Yes   | ✓    |
| 28412          | 16T8/4F/850/BYP/R  | 5000K | 2,050  | 82         | 128 | No  | 32W    | 160°       | 50,000     | 120-277V | Yes   | ✓    |
| 98379          | 10.5T8/4F/830/BYP  | 3000K | 1,650  | 82         | 157 | No  | 32W    | 160°       | 50,000     | 120-277V | Yes   | ✓    |
| 98380          | 10.5T8/4F/835/BYP  | 3500K | 1,650  | 82         | 157 | No  | 32W    | 160°       | 50,000     | 120-277V | Yes   | ✓    |
| 98381          | 10.5T8/4F/840/BYP  | 4000K | 1,750  | 82         | 167 | No  | 32W    | 160°       | 50,000     | 120-277V | Yes   | ✓    |
| 98382          | 10.5T8/4F/850/BYP  | 5000K | 1,750  | 82         | 167 | No  | 32W    | 160°       | 50,000     | 120-277V | Yes   | ✓    |
| 98473          | 14.5T8/4F/840/BYP  | 4000K | 2,200  | 82         | 152 | No  | 32W    | 160°       | 50,000     | 120-277V | Yes   | ✓    |
| 98474          | 14.5T8/4F/850/BYP  | 5000K | 2,200  | 82         | 152 | No  | 32W    | 160°       | 50,000     | 120-277V | Yes   | ✓    |
| 98162          | 17T8U6/830/BYP     | 3000K | 2,100  | 82         | 124 | No  | 32W    | 140°       | 50,000     | 120-277V | Yes   | ✓    |
| 98163          | 17T8U6/840/BYP     | 4000K | 2,300  | 82         | 135 | No  | 32W    | 140°       | 50,000     | 120-277V | Yes   | ✓    |
| 98164          | 17T8U6/850/BYP     | 5000K | 2,300  | 82         | 135 | No  | 32W    | 140°       | 50,000     | 120-277V | Yes   | ✓    |
| 57840          | 17.5T8/4F/GOLD/BYP | N.A.  | 1,100  | 82         | 63  | No  | 32W    | 160°       | 50,000     | 120-277V | Yes   | N.A. |

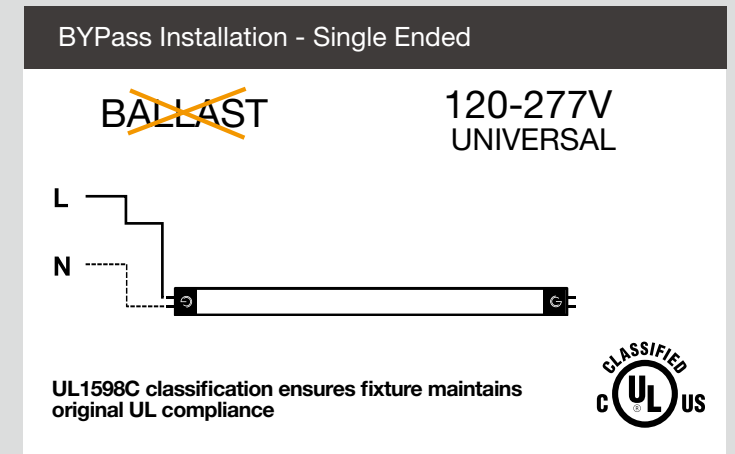

- Integral driver suitable for 120-277V
- Flicker Free light output
- Suitable for use in totally enclosed fixtures
- Meets NSF requirements (use of a shatter guard required)



| SPECIFICATIONS |                    |       |        |            |     |     |        |            |            |          |       |     |
|----------------|--------------------|-------|--------|------------|-----|-----|--------|------------|------------|----------|-------|-----|
| Product        | Model              | CCT   | Lumens | CRI (typ.) | LPW | Dim | Equiv. | Beam Angle | Life (hrs) | Voltage  | Encl. | DLC |
| 98191          | 8T8/2F/830/BYP/FF  | 3000K | 1,000  | 82         | 125 | No  | 17W    | 160°       | 50,000     | 120-277V | Yes   | ✓   |
| 98192          | 8T8/2F/835/BYP/FF  | 3500K | 1,050  | 82         | 131 | No  | 17W    | 160°       | 50,000     | 120-277V | Yes   | ✓   |
| 98193          | 8T8/2F/840/BYP/FF  | 4000K | 1,050  | 82         | 131 | No  | 17W    | 160°       | 50,000     | 120-277V | Yes   | ✓   |
| 98194          | 12T8/3F/830/BYP/FF | 3000K | 1,500  | 82         | 125 | No  | 25W    | 160°       | 50,000     | 120-277V | Yes   | ✓   |
| 98195          | 12T8/3F/835/BYP/FF | 3500K | 1,500  | 82         | 125 | No  | 25W    | 160°       | 50,000     | 120-277V | Yes   | ✓   |
| 98196          | 12T8/3F/840/BYP/FF | 4000K | 1,550  | 82         | 129 | No  | 25W    | 160°       | 50,000     | 120-277V | Yes   | ✓   |
| 98197          | 13T8/4F/830/BYP/FF | 3000K | 1,600  | 82         | 123 | No  | 32W    | 160°       | 50,000     | 120-277V | Yes   | ✓   |
| 98198          | 13T8/4F/835/BYP/FF | 3500K | 1,650  | 82         | 127 | No  | 32W    | 160°       | 50,000     | 120-277V | Yes   | ✓   |
| 98199          | 13T8/4F/840/BYP/FF | 4000K | 1,700  | 82         | 131 | No  | 32W    | 160°       | 50,000     | 120-277V | Yes   | ✓   |
| 98200          | 13T8/4F/850/BYP/FF | 5000K | 1,700  | 82         | 131 | No  | 32W    | 160°       | 50,000     | 120-277V | Yes   | ✓   |
| 98201          | 16T8/4F/840/BYP/FF | 4000K | 2,050  | 82         | 128 | No  | 32W    | 160°       | 50,000     | 120-277V | Yes   | ✓   |
| 98202          | 16T8/4F/850/BYP/FF | 5000K | 2,050  | 82         | 128 | No  | 32W    | 160°       | 50,000     | 120-277V | Yes   | ✓   |

# T8 BYP LINE - DIMMABLE

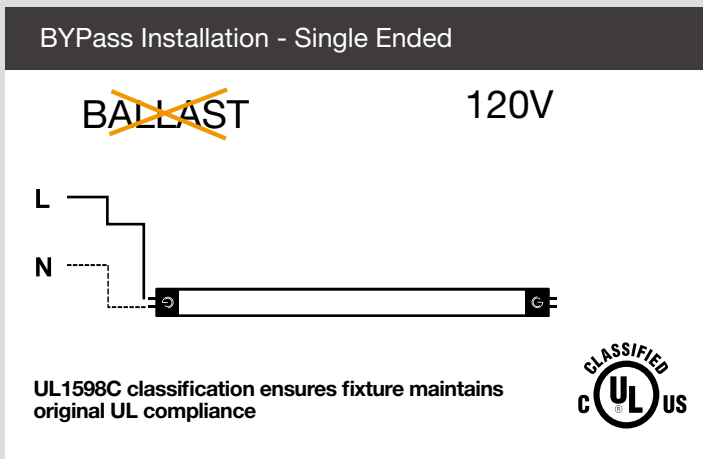

- Integral driver suitable for 120V
- Replaces 32W T8 Fluorescent lamps
- High efficacy up to 138 LPW
- Compatible with most phase dimmers

## SPECIFICATIONS

| Product | Model               | CCT   | Lumens | CRI (typ.) | LPW | Dim | Equiv. | Beam Angle | Life (hrs) | Voltage | Encl. | DLC |
|---------|---------------------|-------|--------|------------|-----|-----|--------|------------|------------|---------|-------|-----|
| 98372   | 13T8/4F/DIM/830/BYP | 3000K | 1,700  | 82         | 128 | Yes | 32W    | 160°       | 50,000     | 120V    | Yes   | ✓   |
| 98373   | 13T8/4F/DIM/835/BYP | 3500K | 1,700  | 82         | 128 | Yes | 32W    | 160°       | 50,000     | 120V    | Yes   | ✓   |
| 98374   | 13T8/4F/DIM/840/BYP | 4000K | 1,800  | 82         | 138 | Yes | 32W    | 160°       | 50,000     | 120V    | Yes   | ✓   |
| 98375   | 13T8/4F/DIM/850/BYP | 5000K | 1,800  | 82         | 138 | Yes | 32W    | 160°       | 50,000     | 120V    | Yes   | ✓   |

# T5 BYP LINE

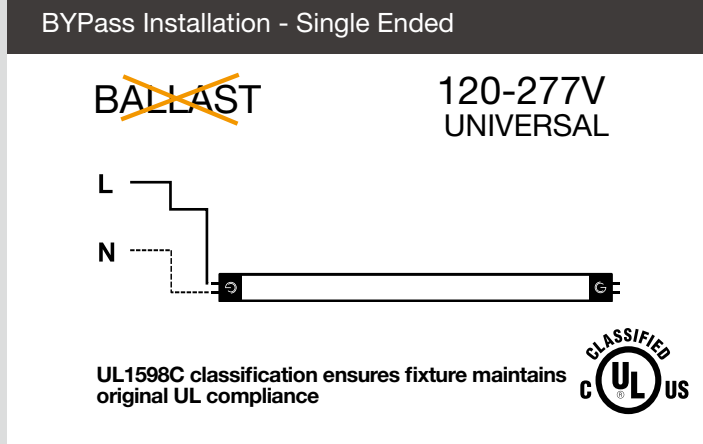

- Integral driver suitable for 120-277V
- Wide beam design 270° light emitting area
- Suitable for use in totally enclosed fixtures
- Plastic construction meets NSF requirements

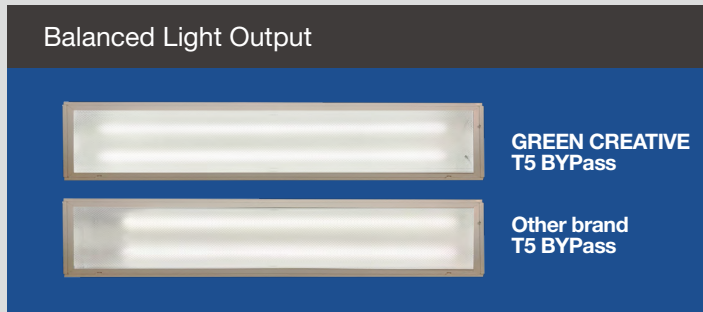

## SPECIFICATIONS

| Product | Model               | CCT   | Lumens | CRI (typ.) | LPW | Dim | Equiv. | Beam Angle | Life (hrs) | Voltage  | Encl. | DLC  |
|---------|---------------------|-------|--------|------------|-----|-----|--------|------------|------------|----------|-------|------|
| 98287   | 9.5T5HE/2F/830/BYP  | 3000K | 1,100  | 82         | 116 | No  | 14W    | 120°       | 50,000     | 120-277V | Yes   | N.A. |
| 98288   | 9.5T5HE/2F/835/BYP  | 3500K | 1,150  | 82         | 121 | No  | 14W    | 120°       | 50,000     | 120-277V | Yes   | N.A. |
| 98289   | 9.5T5HE/2F/840/BYP  | 4000K | 1,200  | 82         | 126 | No  | 14W    | 120°       | 50,000     | 120-277V | Yes   | N.A. |
| 98290   | 12T5HE/3F/830/BYP   | 3000K | 1,350  | 82         | 113 | No  | 21W    | 120°       | 50,000     | 120-277V | Yes   | N.A. |
| 98291   | 12T5HE/3F/835/BYP   | 3500K | 1,400  | 82         | 117 | No  | 21W    | 120°       | 50,000     | 120-277V | Yes   | N.A. |
| 98292   | 12T5HE/3F/840/BYP   | 4000K | 1,500  | 82         | 125 | No  | 21W    | 120°       | 50,000     | 120-277V | Yes   | N.A. |
| 98293   | 14.5T5HE/4F/830/BYP | 3000K | 1,750  | 82         | 121 | No  | 28W    | 120°       | 50,000     | 120-277V | Yes   | ✓    |
| 98294   | 14.5T5HE/4F/835/BYP | 3500K | 1,800  | 82         | 124 | No  | 28W    | 120°       | 50,000     | 120-277V | Yes   | ✓    |
| 98295   | 14.5T5HE/4F/840/BYP | 4000K | 2,000  | 82         | 138 | No  | 28W    | 120°       | 50,000     | 120-277V | Yes   | ✓    |
| 98296   | 11.5T5HO/2F/830/BYP | 3000K | 1,350  | 82         | 117 | No  | 24W    | 120°       | 50,000     | 120-277V | Yes   | N.A. |
| 98297   | 11.5T5HO/2F/835/BYP | 3500K | 1,400  | 82         | 122 | No  | 24W    | 120°       | 50,000     | 120-277V | Yes   | N.A. |
| 98298   | 11.5T5HO/2F/840/BYP | 4000K | 1,500  | 82         | 130 | No  | 24W    | 120°       | 50,000     | 120-277V | Yes   | N.A. |
| 98299   | 14.5T5HO/3F/830/BYP | 3000K | 1,800  | 82         | 124 | No  | 39W    | 120°       | 50,000     | 120-277V | Yes   | N.A. |
| 98300   | 14.5T5HO/3F/835/BYP | 3500K | 1,850  | 82         | 128 | No  | 39W    | 120°       | 50,000     | 120-277V | Yes   | N.A. |
| 98301   | 14.5T5HO/3F/840/BYP | 4000K | 1,900  | 82         | 131 | No  | 39W    | 120°       | 50,000     | 120-277V | Yes   | N.A. |
| 98302   | 25T5HO/4F/830/BYP   | 3000K | 3,200  | 82         | 128 | No  | 54W    | 120°       | 50,000     | 120-277V | Yes   | ✓    |
| 98303   | 25T5HO/4F/835/BYP   | 3500K | 3,200  | 82         | 128 | No  | 54W    | 120°       | 50,000     | 120-277V | Yes   | ✓    |
| 98304   | 25T5HO/4F/840/BYP   | 4000K | 3,200  | 82         | 128 | No  | 54W    | 120°       | 50,000     | 120-277V | Yes   | ✓    |
| 98305   | 25T5HO/4F/850/BYP   | 5000K | 3,200  | 82         | 128 | No  | 54W    | 120°       | 50,000     | 120-277V | Yes   | ✓    |



BYPass



BYPass

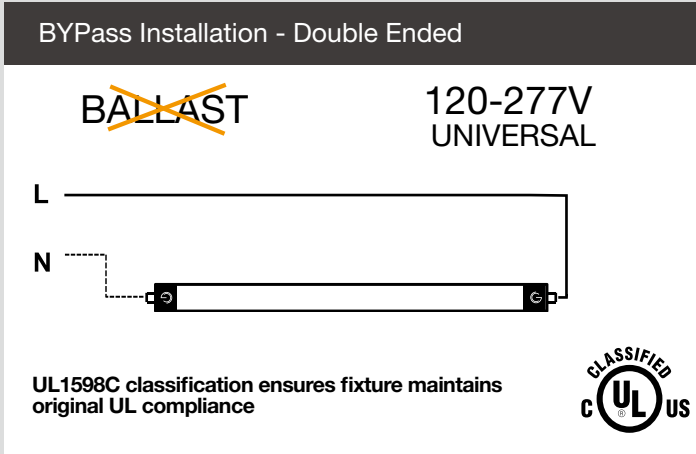

Utilizes Existing Non-Shunted or Shunted Lampholders

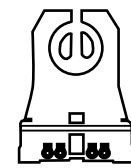

Non-Shunted

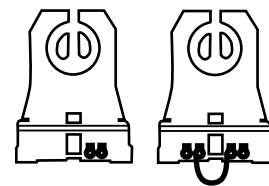

Shunted

- Double-ended bypass installation – Wired at both ends
- Utilizes existing lampholders – Non-shunted or shunted
- Extra high efficacy series up to 148LPW available
- Meets NSF requirements (use of a shatter guard required)

| SPECIFICATIONS |                      |       |        |            |     |     |        |            |            |          |       |     |
|----------------|----------------------|-------|--------|------------|-----|-----|--------|------------|------------|----------|-------|-----|
| Product        | Model                | CCT   | Lumens | CRI (typ.) | LPW | Dim | Equiv. | Beam Angle | Life (hrs) | Voltage  | Encl. | DLC |
| 97934          | 8.5T8/2F/830/DEB/RC  | 3000K | 1,050  | 82         | 124 | No  | 17W    | 160°       | 50,000     | 120-277V | Yes   | ✓   |
| 97935          | 8.5T8/2F/835/DEB/RC  | 3500K | 1,050  | 82         | 124 | No  | 17W    | 160°       | 50,000     | 120-277V | Yes   | ✓   |
| 97936          | 8.5T8/2F/840/DEB/RC  | 4000K | 1,100  | 82         | 129 | No  | 17W    | 160°       | 50,000     | 120-277V | Yes   | ✓   |
| 98340          | 12T8/3F/830/DEB/R    | 3000K | 1,400  | 82         | 117 | No  | 25W    | 160°       | 50,000     | 120-277V | Yes   | ✓   |
| 98341          | 12T8/3F/835/DEB/R    | 3500K | 1,400  | 82         | 117 | No  | 25W    | 160°       | 50,000     | 120-277V | Yes   | ✓   |
| 98342          | 12T8/3F/840/DEB/R    | 4000K | 1,450  | 82         | 121 | No  | 25W    | 160°       | 50,000     | 120-277V | Yes   | ✓   |
| 98435          | 14T8/4F/830/DEB      | 3000K | 1,700  | 82         | 121 | No  | 25W    | 160°       | 50,000     | 120-277V | Yes   | ✓   |
| 98436          | 14T8/4F/835/DEB      | 3500K | 1,700  | 82         | 124 | No  | 32W    | 160°       | 50,000     | 120-277V | Yes   | ✓   |
| 98437          | 14T8/4F/840/DEB      | 4000K | 1,800  | 82         | 129 | No  | 32W    | 160°       | 50,000     | 120-277V | Yes   | ✓   |
| 98438          | 14T8/4F/850/DEB      | 5000K | 1,800  | 82         | 129 | No  | 32W    | 160°       | 50,000     | 120-277V | Yes   | ✓   |
| 98433          | 17T8/4F/840/DEB      | 4000K | 2,200  | 82         | 117 | No  | 25W    | 160°       | 50,000     | 120-277V | Yes   | ✓   |
| 98434          | 17T8/4F/850/DEB      | 5000K | 2,200  | 82         | 117 | No  | 25W    | 160°       | 50,000     | 120-277V | Yes   | ✓   |
| 58272          | 11.5T8/4F/830/DEB/RC | 3000K | 1,650  | 82         | 143 | No  | 32W    | 160°       | 50,000     | 120-277V | Yes   | ✓   |
| 58273          | 11.5T8/4F/835/DEB/RC | 3500K | 1,650  | 82         | 143 | No  | 32W    | 160°       | 50,000     | 120-277V | Yes   | ✓   |
| 58274          | 11.5T8/4F/840/DEB/RC | 4000K | 1,700  | 82         | 148 | No  | 32W    | 160°       | 50,000     | 120-277V | Yes   | ✓   |
| 58275          | 11.5T8/4F/850/DEB/RC | 5000K | 1,700  | 82         | 148 | No  | 32W    | 160°       | 50,000     | 120-277V | Yes   | ✓   |
| 58270          | 14.5T8/4F/840/DEB/RC | 4000K | 2,100  | 82         | 145 | No  | 32W    | 160°       | 50,000     | 120-277V | Yes   | ✓   |
| 58271          | 14.5T8/4F/850/DEB/RC | 5000K | 2,100  | 82         | 145 | No  | 32W    | 160°       | 50,000     | 120-277V | Yes   | ✓   |



R17d



Fa8

- Integral driver suitable for 120-277V
- Replaces 8ft F96T8/F96T12 Fluorescent lamps
- Available in Single pin & Recessed Double Contact pin
- Double ended installation, no need to change existing sockets

| SPECIFICATIONS |                      |       |        |            |     |     |              |            |            |          |       |      |
|----------------|----------------------|-------|--------|------------|-----|-----|--------------|------------|------------|----------|-------|------|
| Product        | Model                | CCT   | Lumens | CRI (typ.) | LPW | Dim | Equiv.       | Beam Angle | Life (hrs) | Voltage  | Encl. | DLC  |
| 34869          | 43T8/8F/840/DEB/Fa8  | 4000K | 5,500  | 82         | 128 | No  | F96T8 F96T12 | 160°       | 50,000     | 120-277V | Yes   | ✓    |
| 34870          | 43T8/8F/850/DEB/Fa8  | 5000K | 5,500  | 82         | 128 | No  | F96T8 F96T12 | 160°       | 50,000     | 120-277V | Yes   | ✓    |
| 34871          | 43T8/8F/840/DEB/R17d | 4000K | 5,500  | 82         | 128 | No  | F96T8 F96T12 | 160°       | 50,000     | 120-277V | Yes   | N.A. |
| 34872          | 43T8/8F/850/DEB/R17d | 5000K | 5,500  | 82         | 128 | No  | F96T8 F96T12 | 160°       | 50,000     | 120-277V | Yes   | N.A. |

# T8 EXT LINE



EXTERNAL  
Driver



# T5 EXT LINE



EXTERNAL  
Driver

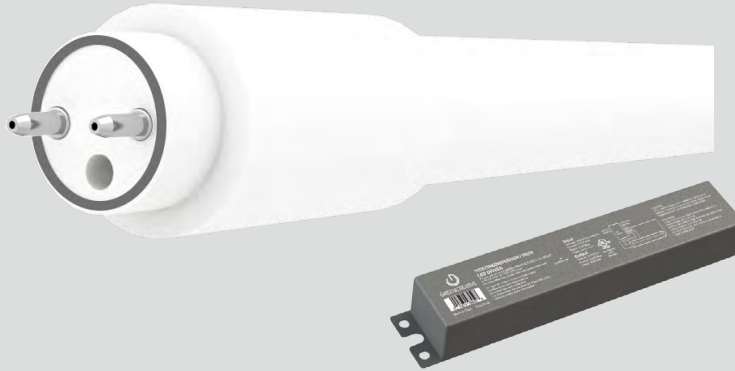

- Compatible with external drivers only
- Dimmable
- Utilizes existing lamp holders – shunted or non-shunted
- Meets NSF requirements (use of a shatter guard required)

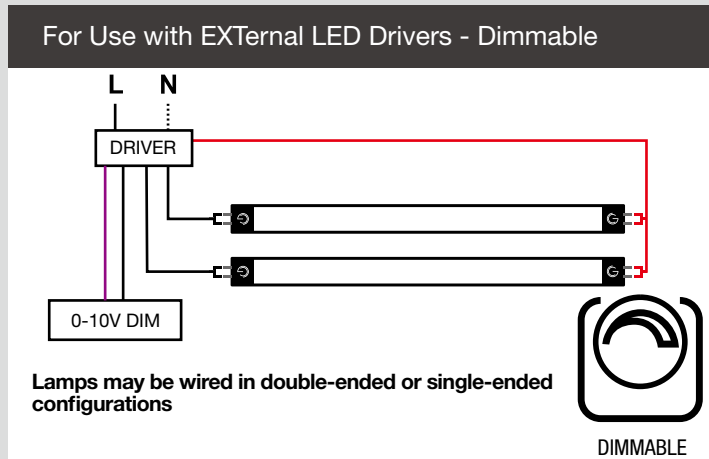

| SPECIFICATIONS |                      |   |        |            |     |     |        |            |            |          |       |     |
|----------------|----------------------|---|--------|------------|-----|-----|--------|------------|------------|----------|-------|-----|
| Product        | Model                | CCT   | Lumens | CRI (typ.) | LPW | Dim | Equiv. | Beam Angle | Life (hrs) | Voltage  | Encl. | DLC |
| 98325          | 9.5T8/2F/830/EXT     | 3000K   | 1,350  | 82         | 142 | Yes | 17W    | 160°       | 50,000     | 120-277V | Yes   | ✓   |
| 98326          | 9.5T8/2F/835/EXT     | 3500K   | 1,400  | 82         | 147 | Yes | 17W    | 160°       | 50,000     | 120-277V | Yes   | ✓   |
| 98327          | 9.5T8/2F/840/EXT     | 4000K   | 1,500  | 82         | 158 | Yes | 17W    | 160°       | 50,000     | 120-277V | Yes   | ✓   |
| 98328          | 10.5T8/3F/830/EXT    | 3000K   | 1,450  | 82         | 138 | Yes | 25W    | 160°       | 50,000     | 120-277V | Yes   | ✓   |
| 98329          | 10.5T8/3F/835/EXT    | 3500K   | 1,500  | 82         | 143 | Yes | 25W    | 160°       | 50,000     | 120-277V | Yes   | ✓   |
| 98330          | 10.5T8/3F/840/EXT    | 4000K   | 1,600  | 82         | 152 | Yes | 25W    | 160°       | 50,000     | 120-277V | Yes   | ✓   |
| 98331          | 11.5T8/4F/830/EXT    | 3000K   | 1,600  | 82         | 139 | Yes | 32W    | 160°       | 50,000     | 120-277V | Yes   | ✓   |
| 98332          | 11.5T8/4F/835/EXT    | 3500K   | 1,650  | 82         | 143 | Yes | 32W    | 160°       | 50,000     | 120-277V | Yes   | ✓   |
| 98333          | 11.5T8/4F/840/EXT    | 4000K   | 1,700  | 82         | 148 | Yes | 32W    | 160°       | 50,000     | 120-277V | Yes   | ✓   |
| 98334          | 11.5T8/4F/850/EXT    | 5000K   | 1,700  | 82         | 148 | Yes | 32W    | 160°       | 50,000     | 120-277V | Yes   | ✓   |
| 98335          | 14T8/4F/840/EXT      | 4000K   | 2,050  | 82         | 146 | Yes | 32W    | 160°       | 50,000     | 120-277V | Yes   | ✓   |
| 98336          | 14T8/4F/850/EXT      | 5000K   | 2,050  | 82         | 146 | Yes | 32W    | 160°       | 50,000     | 120-277V | Yes   | ✓   |
| 98337          | 14.5T8U6/830/EXT     | 3000K   | 2,000  | 82         | 138 | Yes | 32W    | 140°       | 50,000     | 120-277V | Yes   | ✓   |
| 98338          | 14.5T8U6/840/EXT     | 4000K   | 2,200  | 82         | 152 | Yes | 32W    | 140°       | 50,000     | 120-277V | Yes   | ✓   |
| 98339          | 14.5T8U6/850/EXT     | 5000K   | 2,200  | 82         | 152 | Yes | 32W    | 140°       | 50,000     | 120-277V | Yes   | ✓   |
| 98259          | 15T8T5HEDRIVER/2CH/R | 120-277V with 0-10V Dimming External LED Driver for Use with 1-2 T8/T5 HE Lamps |        |            |     |     |        |            |            |          |       |     |
| 98260          | 15T8T5HEDRIVER/4CH/R | 120-277V with 0-10V Dimming External LED Driver for Use with 3-4 T8/T5 HE Lamps |        |            |     |     |        |            |            |          |       |     |

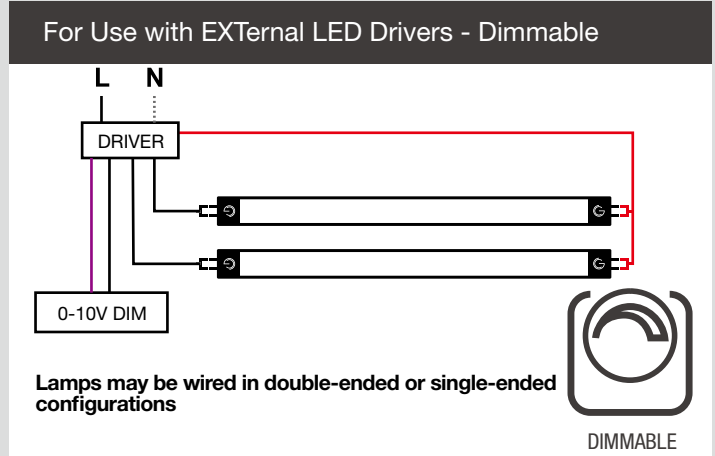

- Compatible with external drivers only
- Dimmable
- Utilizes existing lamp holders – shunted or non-shunted
- Plastic construction meets NSF requirements

| SPECIFICATIONS |                      |   |        |            |     |     |        |            |            |          |       |      |
|----------------|----------------------|---|--------|------------|-----|-----|--------|------------|------------|----------|-------|------|
| Product        | Model                | CCT   | Lumens | CRI (typ.) | LPW | Dim | Equiv. | Beam Angle | Life (hrs) | Voltage  | Encl. | DLC  |
| 98306          | 9.5T5HE/2F/830/EXT   | 3000K   | 1,350  | 82         | 142 | Yes | 14W    | 120°       | 50,000     | 120-277V | Yes   | N.A. |
| 98307          | 9.5T5HE/2F/835/EXT   | 3500K   | 1,400  | 82         | 147 | Yes | 14W    | 120°       | 50,000     | 120-277V | Yes   | N.A. |
| 98308          | 9.5T5HE/2F/840/EXT   | 4000K   | 1,500  | 82         | 158 | Yes | 14W    | 120°       | 50,000     | 120-277V | Yes   | N.A. |
| 98309          | 11T5HE/3F/830/EXT    | 3000K   | 1,500  | 82         | 136 | Yes | 21W    | 120°       | 50,000     | 120-277V | Yes   | N.A. |
| 98310          | 11T5HE/3F/835/EXT    | 3500K   | 1,550  | 82         | 141 | Yes | 21W    | 120°       | 50,000     | 120-277V | Yes   | N.A. |
| 98311          | 11T5HE/3F/840/EXT    | 4000K   | 1,600  | 82         | 150 | Yes | 21W    | 120°       | 50,000     | 120-277V | Yes   | N.A. |
| 98312          | 13.5T5HE/4F/830/EXT  | 3000K   | 1,800  | 82         | 133 | Yes | 28W    | 120°       | 50,000     | 120-277V | Yes   | ✓    |
| 98313          | 13.5T5HE/4F/835/EXT  | 3500K   | 1,850  | 82         | 137 | Yes | 28W    | 120°       | 50,000     | 120-277V | Yes   | ✓    |
| 98314          | 13.5T5HE/4F/840/EXT  | 4000K   | 2,000  | 82         | 148 | Yes | 28W    | 120°       | 50,000     | 120-277V | Yes   | ✓    |
| 98321          | 22T5HO/4F/830/EXT    | 3000K   | 3,200  | 82         | 145 | Yes | 54W    | 120°       | 50,000     | 120-277V | Yes   | ✓    |
| 98322          | 22T5HO/4F/835/EXT    | 3500K   | 3,200  | 82         | 145 | Yes | 54W    | 120°       | 50,000     | 120-277V | Yes   | ✓    |
| 98323          | 22T5HO/4F/840/EXT    | 4000K   | 3,400  | 82         | 155 | Yes | 54W    | 120°       | 50,000     | 120-277V | Yes   | ✓    |
| 98324          | 22T5HO/4F/850/EXT    | 5000K   | 3,400  | 82         | 155 | Yes | 54W    | 120°       | 50,000     | 120-277V | Yes   | ✓    |
| 98259          | 15T8T5HEDRIVER/2CH/R | 120-277V with 0-10V Dimming External LED Driver for Use with 1-2 T8/T5 HE Lamps |        |            |     |     |        |            |            |          |       |      |
| 98260          | 15T8T5HEDRIVER/4CH/R | 120-277V with 0-10V Dimming External LED Driver for Use with 3-4 T8/T5 HE Lamps |        |            |     |     |        |            |            |          |       |      |
| 98261          | 24T5HODRIVER/2CH/R   | 120-277V with 0-10V Dimming External LED Driver for Use with 1-2 T5 HO Lamps    |        |            |     |     |        |            |            |          |       |      |
| 98262          | 24T5HODRIVER/4CH/R   | 120-277V with 0-10V Dimming External LED Driver for Use with 3-4 T5 HO Lamps    |        |            |     |     |        |            |            |          |       |      |

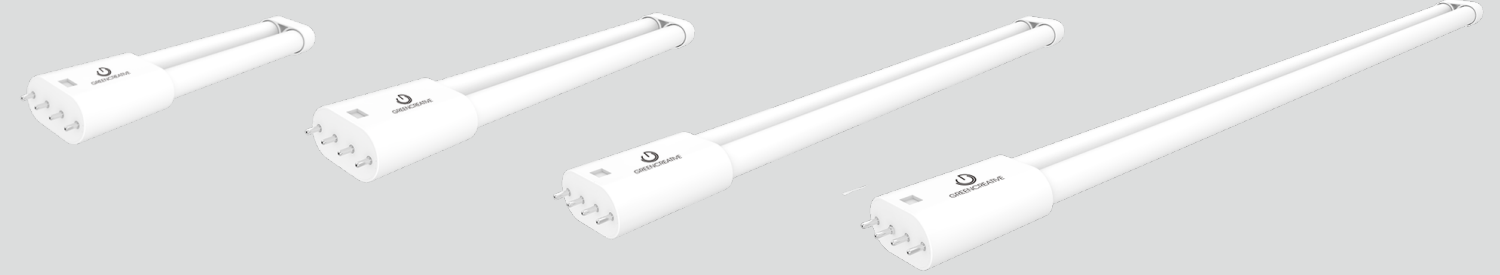
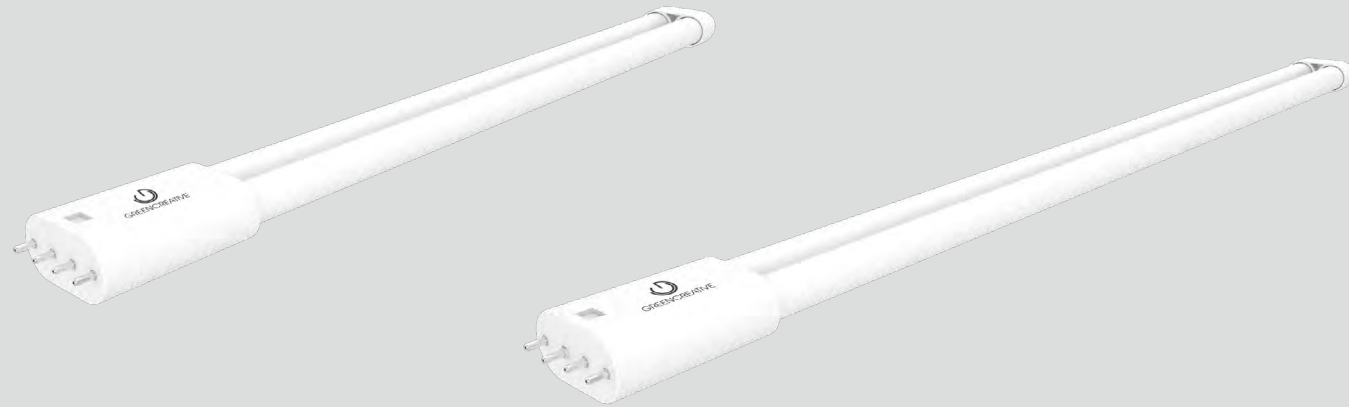

### Compatible with Electronic Ballasts



- Easy to install – Plug & play direct
- Instant Start & Programmed Start ballast compatible
- Plastic film prevents glass from shattering
- Installs into 2G11 sockets with existing ballast

- Integral driver suitable for 120-277V
- Replaces 18W / 24W / 36W / 40W 4-pin (2G11) CFL lamps
- High efficacy up to 138 LPW
- 16W / 17W models suitable for use in enclosed fixture

### BYPass Installation

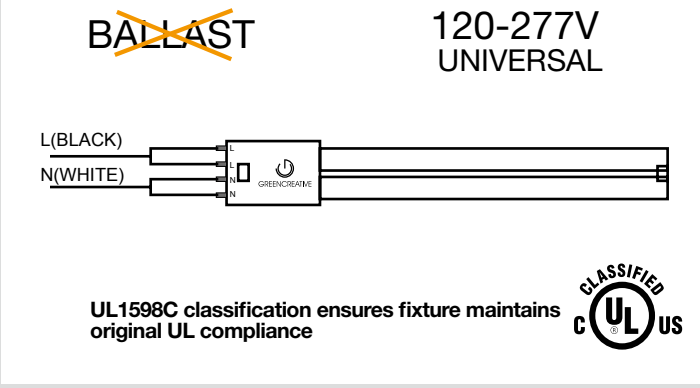

### SPECIFICATIONS

| Product | Model              | CCT   | Lumens | CRI (typ.) | LPW | Dim | Equiv. | Beam Angle | Life (hrs) | Voltage  | Encl. | DLC  |
|---------|--------------------|-------|--------|------------|-----|-----|--------|------------|------------|----------|-------|------|
| 98477   | 13PLL/830/GL/DIR   | 3000K | 2,050  | 82         | 158 | No  | 40W    | 160°       | 50,000     | 120-277V | Yes   | ✓    |
| 98478   | 13PLL/835/GL/DIR   | 3500K | 2,100  | 82         | 162 | No  | 40W    | 160°       | 50,000     | 120-277V | Yes   | ✓    |
| 98479   | 13PLL/840/GL/DIR   | 4000K | 2,100  | 82         | 162 | No  | 40W    | 160°       | 50,000     | 120-277V | Yes   | ✓    |
| 98488   | 14.5PLL/835/GL/DIR | 3500K | 1,950  | 82         | 134 | No  | 36W    | 160°       | 50,000     | 120-277V | Yes   | N.A. |
| 98489   | 14.5PLL/840/GL/DIR | 4000K | 2,000  | 82         | 138 | No  | 36W    | 160°       | 50,000     | 120-277V | Yes   | N.A. |

### SPECIFICATIONS

| Product | Model             | CCT   | Lumens | CRI (typ.) | LPW | Dim | Equiv. | Beam Angle | Life (hrs) | Voltage  | Encl. | DLC  |
|---------|-------------------|-------|--------|------------|-----|-----|--------|------------|------------|----------|-------|------|
| 34858   | 8.5PLL/835/GL/BYP | 3500K | 950    | 82         | 112 | No  | 18W    | 160°       | 50,000     | 120-277V | No    | N.A. |
| 34859   | 8.5PLL/840/GL/BYP | 4000K | 980    | 82         | 115 | No  | 18W    | 160°       | 50,000     | 120-277V | No    | N.A. |
| 34861   | 10PLL/835/GL/BYP  | 3500K | 1,200  | 82         | 120 | No  | 24W    | 160°       | 50,000     | 120-277V | No    | N.A. |
| 34862   | 10PLL/840/GL/BYP  | 4000K | 1,250  | 82         | 125 | No  | 24W    | 160°       | 50,000     | 120-277V | No    | N.A. |
| 34864   | 16PLL/835/GL/BYP  | 3500K | 1,950  | 82         | 122 | No  | 36W    | 160°       | 50,000     | 120-277V | Yes   | N.A. |
| 34865   | 16PLL/840/GL/BYP  | 4000K | 2,000  | 82         | 125 | No  | 36W    | 160°       | 50,000     | 120-277V | Yes   | N.A. |
| 34866   | 17PLL/830/GL/BYP  | 3000K | 2,050  | 82         | 121 | No  | 40W    | 160°       | 50,000     | 120-277V | Yes   | July |
| 34867   | 17PLL/835/GL/BYP  | 3500K | 2,150  | 82         | 126 | No  | 40W    | 160°       | 50,000     | 120-277V | Yes   | July |
| 34868   | 17PLL/840/GL/BYP  | 4000K | 2,200  | 82         | 129 | No  | 40W    | 160°       | 50,000     | 120-277V | Yes   | July |



| High Flexibility - Ballast Adaptive Technology |        |           |
|--|--------|-----------|
| Ballast Type                                   | Lumens | Bare Lamp |
| 13W  | 600    | 4.5W      |
| 18W  | 700    | 5.5W      |
| 26W  | 1020   | 8.5W      |

**PL H 8.5W DIR**

- Plug & play direct – Electronic ballast compatible
- Compatible with G24q & GX24q installations
- 310° rotatable base to maximize lamp performance in fixture
- 0-10V dimming ballast compatible
- Ballast Adaptive Technology allows one LED lamp to be powered by a range of fluorescent ballasts instead of restricting to one wattage rating

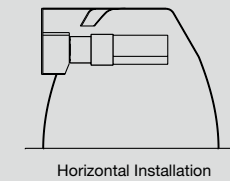

| SPECIFICATIONS |                   |       |        |            |     |     |        |            |            |          |       |      |
|----------------|-------------------|-------|--------|------------|-----|-----|--------|------------|------------|----------|-------|------|
| Product        | Model             | CCT   | Lumens | CRI (typ.) | LPW | Dim | Equiv. | Beam Angle | Life (hrs) | Voltage  | Encl. | DLC  |
| 57895          | 5.5PLH/827/DIR/RC | 2700K | 520    | 82         | 95  | Yes | 13-18W | 110°       | 50,000     | 120-277V | No    | N.A. |
| 57896          | 5.5PLH/830/DIR/RC | 3000K | 550    | 82         | 100 | Yes | 13-18W | 110°       | 50,000     | 120-277V | No    | N.A. |
| 57897          | 5.5PLH/835/DIR/RC | 3500K | 550    | 82         | 100 | Yes | 13-18W | 110°       | 50,000     | 120-277V | No    | N.A. |
| 57898          | 5.5PLH/840/DIR/RC | 4000K | 560    | 82         | 102 | Yes | 13-18W | 110°       | 50,000     | 120-277V | No    | N.A. |
| 28366          | 8.5PLH/827/DIR/R  | 2700K | 870    | 82         | 102 | Yes | 26W    | 110°       | 50,000     | 120-277V | No    | ✓    |
| 28367          | 8.5PLH/830/DIR/R  | 3000K | 950    | 82         | 112 | Yes | 26W    | 110°       | 50,000     | 120-277V | No    | ✓    |
| 28368          | 8.5PLH/835/DIR/R  | 3500K | 950    | 82         | 112 | Yes | 26W    | 110°       | 50,000     | 120-277V | No    | ✓    |
| 28369          | 8.5PLH/840/DIR/R  | 4000K | 1,020  | 82         | 120 | Yes | 26W    | 110°       | 50,000     | 120-277V | No    | ✓    |
| 57903          | 10.5PLH/930/DIR   | 3000K | 890    | 92         | 85  | Yes | 26W    | 110°       | 50,000     | 120-277V | No    | N.A. |
| 98244          | 14.5PLH/830/DIR   | 3000K | 1,700  | 82         | 117 | Yes | 42W    | 110°       | 50,000     | 120-277V | No    | N.A. |
| 98245          | 14.5PLH/835/DIR   | 3500K | 1,750  | 82         | 121 | Yes | 42W    | 110°       | 50,000     | 120-277V | No    | N.A. |
| 98246          | 14.5PLH/840/DIR   | 4000K | 1,800  | 82         | 124 | Yes | 42W    | 110°       | 50,000     | 120-277V | No    | N.A. |



| High Flexibility - Ballast Adaptive Technology |        |           |
|--|--------|-----------|
| Ballast Type                                   | Lumens | Bare Lamp |
| 13W  | 590    | 5W        |
| 18W  | 820    | 6W        |
| 26W  | 1020   | 9.5W      |

**PL V 9.5W DIR**

- Plug & play direct – Electronic ballast compatible
- Compatible with G24q & GX24q installations
- Patented design
- 0-10V dimming ballast compatible
- Ballast Adaptive Technology allows one LED lamp to be powered by a range of fluorescent ballasts instead of restricting to one wattage rating

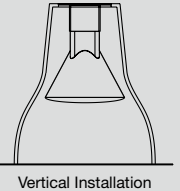

| SPECIFICATIONS |                   |       |        |            |     |     |        |            |            |          |       |      |
|----------------|-------------------|-------|--------|------------|-----|-----|--------|------------|------------|----------|-------|------|
| Product        | Model             | CCT   | Lumens | CRI (typ.) | LPW | Dim | Equiv. | Beam Angle | Life (hrs) | Voltage  | Encl. | DLC  |
| 28370          | 6PLV/827/DIR/R    | 2700K | 600    | 82         | 100 | Yes | 13-18W | 120°       | 50,000     | 120-277V | No    | N.A. |
| 28371          | 6PLV/830/DIR/R    | 3000K | 620    | 82         | 103 | Yes | 13-18W | 120°       | 50,000     | 120-277V | No    | N.A. |
| 28372          | 6PLV/835/DIR/R    | 3500K | 620    | 82         | 103 | Yes | 13-18W | 120°       | 50,000     | 120-277V | No    | N.A. |
| 28373          | 6PLV/840/DIR/R    | 4000K | 640    | 82         | 107 | Yes | 13-18W | 120°       | 50,000     | 120-277V | No    | N.A. |
| 28374          | 9.5PLV/827/DIR/R  | 2700K | 950    | 82         | 100 | Yes | 26W    | 120°       | 50,000     | 120-277V | No    | ✓    |
| 28375          | 9.5PLV/830/DIR/RC | 3000K | 1,000  | 82         | 105 | Yes | 26W    | 120°       | 50,000     | 120-277V | No    | ✓    |
| 28376          | 9.5PLV/835/DIR/RC | 3500K | 1,000  | 82         | 105 | Yes | 26W    | 120°       | 50,000     | 120-277V | No    | ✓    |
| 28377          | 9.5PLV/840/DIR/RC | 4000K | 1,020  | 82         | 107 | Yes | 26W    | 120°       | 50,000     | 120-277V | No    | ✓    |
| 57918          | 11PLV/930/DIR     | 3000K | 920    | 92         | 84  | Yes | 26W    | 120°       | 50,000     | 120-277V | No    | N.A. |
| 98248          | 17PLV/830/DIR     | 3000K | 1,900  | 82         | 112 | Yes | 42W    | 110°       | 50,000     | 120-277V | No    | ✓    |
| 98249          | 17PLV/835/DIR     | 3500K | 1,950  | 82         | 115 | Yes | 42W    | 110°       | 50,000     | 120-277V | No    | ✓    |
| 98250          | 17PLV/840/DIR     | 4000K | 2,000  | 82         | 118 | Yes | 42W    | 110°       | 50,000     | 120-277V | No    | ✓    |



**Hybrid Installation**

MAGNETIC  
BALLAST  
COMPATIBLE

120-  
277V  
UNIVERSAL

**Note PL H 15.5W BYP is not compatible with magnetic ballasts**

- **HYBRid installation - DIRect or BYPass**
- **Compatible with magnetic ballasts - DIRect installation**
- **Built-in universal voltage driver - BYPass installation**
- **310° rotatable base to maximize lamp performance in fixture**
- **E26 & GU24 versions available**

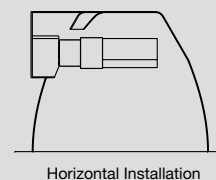

| SPECIFICATIONS |                     |       |        |            |     |     |        |            |            |          |       |      |
|----------------|---------------------|-------|--------|------------|-----|-----|--------|------------|------------|----------|-------|------|
| Product        | Model               | CCT   | Lumens | CRI (typ.) | LPW | Dim | Equiv. | Beam Angle | Life (hrs) | Voltage  | Encl. | DLC  |
| 98391          | 5.5PLH/835/HYBM     | 3500K | 550    | 82         | 100 | Yes | 13-18W | 110°       | 50,000     | 120-277V | No    | N.A. |
| 98392          | 5.5PLH/840/HYBM     | 4000K | 560    | 82         | 102 | Yes | 13-18W | 110°       | 50,000     | 120-277V | No    | N.A. |
| 98393          | 5.5PLH/830/BYP/E26  | 3000K | 550    | 82         | 100 | Yes | 13W    | 110°       | 50,000     | 120-277V | No    | N.A. |
| 98394          | 5.5PLH/835/BYP/E26  | 3500K | 550    | 82         | 100 | Yes | 13W    | 110°       | 50,000     | 120-277V | No    | N.A. |
| 98395          | 5.5PLH/840/BYP/E26  | 4000K | 560    | 82         | 102 | Yes | 13W    | 110°       | 50,000     | 120-277V | No    | N.A. |
| 98396          | 5.5PLH/830/BYP/GU24 | 3000K | 550    | 82         | 100 | Yes | 13W    | 110°       | 50,000     | 120-277V | No    | N.A. |
| 98397          | 5.5PLH/835/BYP/GU24 | 3500K | 550    | 82         | 100 | Yes | 13W    | 110°       | 50,000     | 120-277V | No    | N.A. |
| 98398          | 5.5PLH/840/BYP/GU24 | 4000K | 560    | 82         | 102 | Yes | 13W    | 110°       | 50,000     | 120-277V | No    | N.A. |
| 98399          | 8PLH/827/HYBM       | 2700K | 870    | 82         | 108 | Yes | 26W    | 110°       | 50,000     | 120-277V | No    | N.A. |
| 98400          | 8PLH/830/HYBM       | 3000K | 920    | 82         | 115 | Yes | 26W    | 110°       | 50,000     | 120-277V | No    | N.A. |
| 98401          | 8PLH/835/HYBM       | 3500K | 920    | 82         | 115 | Yes | 26W    | 110°       | 50,000     | 120-277V | No    | N.A. |
| 98402          | 8PLH/840/HYBM       | 4000K | 950    | 82         | 119 | Yes | 26W    | 110°       | 50,000     | 120-277V | No    | N.A. |
| 98252          | 15.5PLH/830/BYP     | 3000K | 1,700  | 82         | 110 | Yes | 42W    | 110°       | 50,000     | 120-277V | No    | N.A. |
| 98253          | 15.5PLH/835/BYP     | 3500K | 1,750  | 82         | 113 | Yes | 42W    | 110°       | 50,000     | 120-277V | No    | N.A. |
| 98254          | 15.5PLH/840/BYP     | 4000K | 1,800  | 82         | 116 | Yes | 42W    | 110°       | 50,000     | 120-277V | No    | N.A. |

\* Note PL H 15.5W BYP operates on line voltage only and is not compatible with magnetic ballasts



**Hybrid Installation**

MAGNETIC  
BALLAST  
COMPATIBLE

120-  
277V  
UNIVERSAL

**Note PL V 16.5W BYP is not compatible with magnetic ballasts**

- **HYBRid installation - DIRect or BYPass**
- **Compatible with magnetic ballasts - DIRect installation**
- **Built-in universal voltage driver - BYPass installation**
- **Patented design**

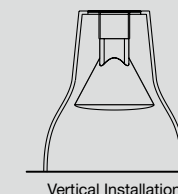

| SPECIFICATIONS |                 |       |        |            |     |     |        |            |            |          |       |      |
|----------------|-----------------|-------|--------|------------|-----|-----|--------|------------|------------|----------|-------|------|
| Product        | Model           | CCT   | Lumens | CRI (typ.) | LPW | Dim | Equiv. | Beam Angle | Life (hrs) | Voltage  | Encl. | DLC  |
| 98385          | 5.5PLV/835/HYBM | 3500K | 600    | 82         | 109 | No  | 13-18W | 120°       | 50,000     | 120-277V | No    | N.A. |
| 98386          | 5.5PLV/840/HYBM | 4000K | 620    | 82         | 113 | No  | 13-18W | 120°       | 50,000     | 120-277V | No    | N.A. |
| 98387          | 8.5PLV/827/HYBM | 2700K | 950    | 82         | 112 | No  | 26W    | 120°       | 50,000     | 120-277V | No    | N.A. |
| 98388          | 8.5PLV/830/HYBM | 3000K | 1,000  | 82         | 118 | No  | 26W    | 120°       | 50,000     | 120-277V | No    | N.A. |
| 98389          | 8.5PLV/835/HYBM | 3500K | 1,000  | 82         | 118 | No  | 26W    | 120°       | 50,000     | 120-277V | No    | N.A. |
| 98390          | 8.5PLV/840/HYBM | 4000K | 1,020  | 82         | 120 | No  | 26W    | 120°       | 50,000     | 120-277V | No    | N.A. |
| 98256          | 16.5PLV/830/BYP | 3000K | 1,800  | 82         | 109 | No  | 42W    | 120°       | 50,000     | 120-277V | No    | N.A. |
| 98257          | 16.5PLV/835/BYP | 3500K | 1,850  | 82         | 112 | No  | 42W    | 120°       | 50,000     | 120-277V | No    | N.A. |
| 98258          | 16.5PLV/840/BYP | 4000K | 1,900  | 82         | 115 | No  | 42W    | 120°       | 50,000     | 120-277V | No    | N.A. |

\* Note PL V 16.5W BYP operates on line voltage only and is not compatible with magnetic ballasts

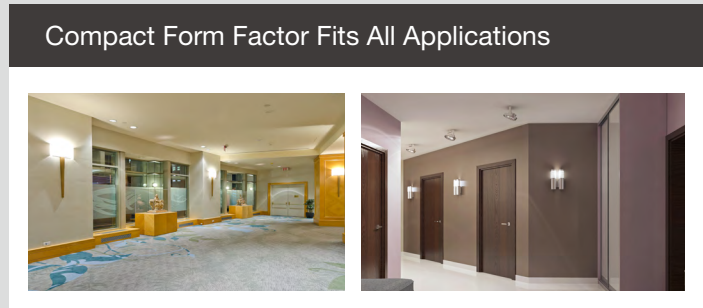
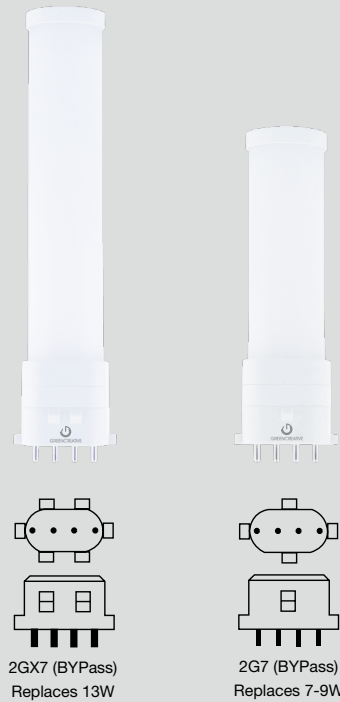

- **BYPass installation – Requires bypassing the ballast**
- **Suitable for use in totally enclosed fixtures**
- **180° rotatable base**
- **Compact form factor fits most fixtures**

| SPECIFICATIONS |                     |       |        |            |     |     |        |            |            |          |       |
|----------------|---------------------|-------|--------|------------|-----|-----|--------|------------|------------|----------|-------|
| Product        | Model               | CCT   | Lumens | CRI (typ.) | LPW | Dim | Equiv. | Beam Angle | Life (hrs) | Voltage  | Encl. |
| 57818          | 3.5PLS/835/BYP/2G7  | 3500K | 300    | 82         | 86  | No  | 7-9W   | 180°       | 50,000     | 120-277V | Yes   |
| 57826          | 5.5PLS/835/BYP/2GX7 | 3500K | 500    | 82         | 91  | No  | 13W    | 180°       | 50,000     | 120-277V | Yes   |

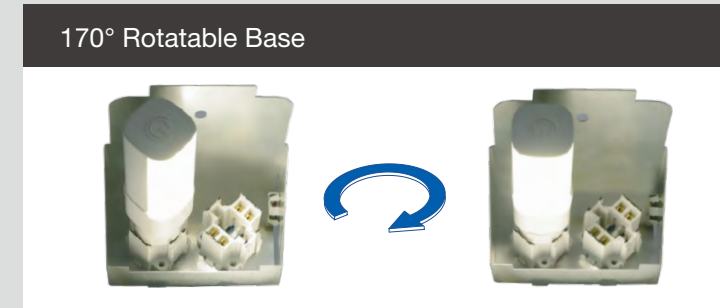
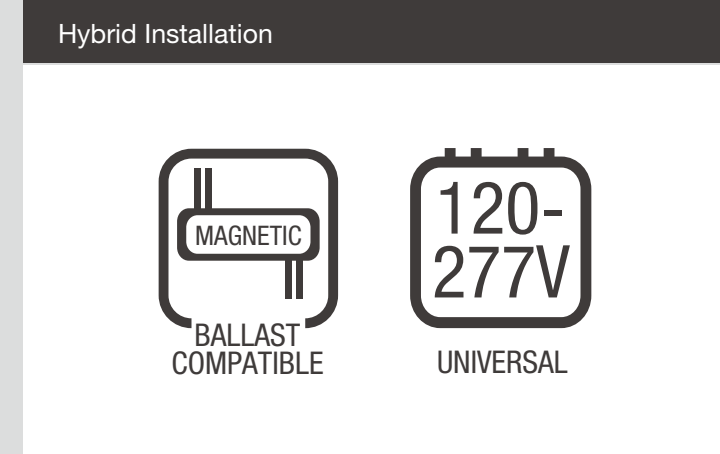

- **HYBrid installation - DIRECT or BYPass**
- **Compatible with magnetic ballasts - DIRECT installation**
- **Built-in universal voltage driver - BYPass installation**
- **Exceptional efficacy**

| SPECIFICATIONS |                      |       |        |            |     |     |        |            |            |          |       |
|----------------|----------------------|-------|--------|------------|-----|-----|--------|------------|------------|----------|-------|
| Product        | Model                | CCT   | Lumens | CRI (typ.) | LPW | Dim | Equiv. | Beam Angle | Life (hrs) | Voltage  | Encl. |
| 57812          | 3.5PLS/827/HYB/G23   | 2700K | 280    | 82         | 80  | No  | 7-9W   | 120°       | 50,000     | 120-277V | Yes   |
| 57813          | 3.5PLS/830/HYB/G23   | 3000K | 280    | 82         | 80  | No  | 7-9W   | 120°       | 50,000     | 120-277V | Yes   |
| 57814          | 3.5PLS/835/HYB/G23   | 3500K | 300    | 82         | 86  | No  | 7-9W   | 120°       | 50,000     | 120-277V | Yes   |
| 57815          | 3.5PLS/840/HYB/G23   | 4000K | 300    | 82         | 86  | No  | 7-9W   | 120°       | 50,000     | 120-277V | Yes   |
| 98403          | 5.5PLSV/827/HYB/GX23 | 2700K | 570    | 82         | 104 | No  | 13W    | 120°       | 50,000     | 120-277V | No    |
| 98404          | 5.5PLSV/830/HYB/GX23 | 3000K | 600    | 82         | 109 | No  | 13W    | 120°       | 50,000     | 120-277V | No    |
| 98405          | 5.5PLSV/835/HYB/GX23 | 3500K | 600    | 82         | 109 | No  | 13W    | 120°       | 50,000     | 120-277V | No    |
| 98406          | 5.5PLSV/840/HYB/GX23 | 4000K | 620    | 82         | 113 | No  | 13W    | 120°       | 50,000     | 120-277V | No    |
| 98407          | 5.5PLSH/827/HYB/GX23 | 2700K | 520    | 82         | 95  | No  | 13W    | 110°       | 50,000     | 120-277V | No    |
| 98408          | 5.5PLSH/830/HYB/GX23 | 3000K | 550    | 82         | 100 | No  | 13W    | 110°       | 50,000     | 120-277V | No    |
| 98409          | 5.5PLSH/835/HYB/GX23 | 3500K | 550    | 82         | 100 | No  | 13W    | 110°       | 50,000     | 120-277V | No    |
| 98410          | 5.5PLSH/840/HYB/GX23 | 4000K | 560    | 82         | 102 | No  | 13W    | 110°       | 50,000     | 120-277V | No    |
| 57820          | 5.5PLS/827/HYB/GX23  | 2700K | 450    | 82         | 82  | No  | 13W    | 120°       | 50,000     | 120-277V | Yes   |
| 57821          | 5.5PLS/830/HYB/GX23  | 3000K | 500    | 82         | 91  | No  | 13W    | 120°       | 50,000     | 120-277V | Yes   |
| 57822          | 5.5PLS/835/HYB/GX23  | 3500K | 500    | 82         | 91  | No  | 13W    | 120°       | 50,000     | 120-277V | Yes   |
| 57823          | 5.5PLS/840/HYB/GX23  | 4000K | 520    | 82         | 95  | No  | 13W    | 120°       | 50,000     | 120-277V | Yes   |



# HID BOLLARD LINE



Designed for Bollard & Post Top Applications



HID Replacements



**25W: 70-100W**  
**16.5W: 50-70W**  
**HID**  
**120-277V**

- Integral driver suitable for 120-277V
- E26 base – ENERGY STAR® certified
- EX39 base – DLC® qualified
- Suitable for use in totally enclosed fixtures

| SPECIFICATIONS |                     |  |        |            |     |     |             |            |            |          |          |
|----------------|---------------------|--|--------|------------|-----|-----|-------------|------------|------------|----------|----------|
| Product        | Model               | CCT  | Lumens | CRI (typ.) | LPW | Dim | Equiv.      | Beam Angle | Life (hrs) | Voltage  | ES / DLC |
| 58238          | 16.5A21/830/277V    | 3000K  | 2,000  | 82         | 121 | No  | 125W Inc.   | 330°       | 40,000     | 120-277V | ✓ / N.A. |
| 58239          | 16.5A21/840/277V    | 4000K  | 2,000  | 82         | 121 | No  | 125W Inc.   | 330°       | 40,000     | 120-277V | ✓ / N.A. |
| 58240          | 16.5A21/850/277V    | 5000K  | 2,050  | 82         | 124 | No  | 125W Inc.   | 330°       | 40,000     | 120-277V | ✓ / N.A. |
| 97972          | 25HID/830/277V/E26  | 3000K  | 3,200  | 82         | 128 | No  | 200W Inc.   | 290°       | 50,000     | 120-277V | ✓ / N.A. |
| 97973          | 25HID/840/277V/E26  | 4000K  | 3,300  | 82         | 132 | No  | 200W Inc.   | 290°       | 50,000     | 120-277V | ✓ / N.A. |
| 97974          | 25HID/850/277V/E26  | 5000K  | 3,400  | 82         | 136 | No  | 200W Inc.   | 290°       | 50,000     | 120-277V | ✓ / N.A. |
| 97968          | 25HID/830/277V/EX39 | 3000K  | 3,200  | 82         | 128 | No  | 70-100W HID | 290°       | 50,000     | 120-277V | N.A. / ✓ |
| 97969          | 25HID/840/277V/EX39 | 4000K  | 3,300  | 82         | 132 | No  | 70-100W HID | 290°       | 50,000     | 120-277V | N.A. / ✓ |
| 97970          | 25HID/850/277V/EX39 | 5000K  | 3,400  | 82         | 136 | No  | 70-100W HID | 290°       | 50,000     | 120-277V | N.A. / ✓ |
| 16325          | E26 EXTENDER        | E26 Lamp Extender Adds 1.30" (33mm) to Lamp Height |        |            |     |     |             |            |            |          |          |
| 97718          | 10SURGE/277V        | 10kV Surge Protector                               |        |            |     |     |             |            |            |          |          |

# HID POST TOP LINE



Designed for Post Top Applications



- Integral driver suitable for 120-277V
- Fully omnidirectional beam angle
- Compatible with EX39 & E39 sockets
- Suitable for use in totally enclosed fixtures

| SPECIFICATIONS |                      |                      |        |            |     |     |              |            |            |          |       |      |
|----------------|----------------------|----------------------|--------|------------|-----|-----|--------------|------------|------------|----------|-------|------|
| Product        | Model                | CCT                  | Lumens | CRI (typ.) | LPW | Dim | Equiv.       | Beam Angle | Life (hrs) | Voltage  | Encl. | DLC  |
| 98087          | 37HID/830/277V/E26   | 3000K                | 4,700  | 82         | 127 | No  | 100-175W HID | 320°       | 50,000     | 120-277V | Yes   | N.A. |
| 98088          | 37HID/840/277V/E26   | 4000K                | 5,200  | 82         | 141 | No  | 100-175W HID | 320°       | 50,000     | 120-277V | Yes   | N.A. |
| 98089          | 37HID/850/277V/E26   | 5000K                | 5,200  | 82         | 141 | No  | 100-175W HID | 320°       | 50,000     | 120-277V | Yes   | N.A. |
| 98084          | 37HID/830/277V/EX39  | 3000K                | 4,700  | 82         | 127 | No  | 100-175W HID | 320°       | 50,000     | 120-277V | Yes   | ✓    |
| 98085          | 37HID/840/277V/EX39  | 4000K                | 5,200  | 82         | 141 | No  | 100-175W HID | 320°       | 50,000     | 120-277V | Yes   | ✓    |
| 98086          | 37HID/850/277V/EX39  | 5000K                | 5,200  | 82         | 141 | No  | 100-175W HID | 320°       | 50,000     | 120-277V | Yes   | ✓    |
| 98090          | 54HID/830/277V/EX39  | 3000K                | 7,300  | 82         | 135 | No  | 175-250W HID | 320°       | 50,000     | 120-277V | Yes   | ✓    |
| 98091          | 54HID/840/277V/EX39  | 4000K                | 7,550  | 82         | 140 | No  | 175-250W HID | 320°       | 50,000     | 120-277V | Yes   | ✓    |
| 98092          | 54HID/850/277V/EX39  | 5000K                | 7,550  | 82         | 140 | No  | 175-250W HID | 320°       | 50,000     | 120-277V | Yes   | ✓    |
| 98097          | 68HID/840/277V/EX39  | 4000K                | 9,500  | 82         | 140 | No  | 175-250W HID | 320°       | 50,000     | 120-277V | Yes   | ✓    |
| 98098          | 68HID/850/277V/EX39  | 5000K                | 9,500  | 82         | 140 | No  | 175-250W HID | 320°       | 50,000     | 120-277V | Yes   | ✓    |
| 98100          | 100HID/840/277V/EX39 | 4000K                | 14,000 | 82         | 140 | No  | 250-400W HID | 320°       | 50,000     | 120-277V | Yes   | ✓    |
| 98101          | 100HID/850/277V/EX39 | 5000K                | 14,000 | 82         | 140 | No  | 250-400W HID | 320°       | 50,000     | 120-277V | Yes   | ✓    |
| 97718          | 10SURGE/277V         | 10kV Surge Protector |        |            |     |     |              |            |            |          |       |      |

# HID HIGH BAY / LOW BAY LINE

# HID WALL PACK LINE



E26 Version Available

## Designed for High Bay & Low Bay Applications

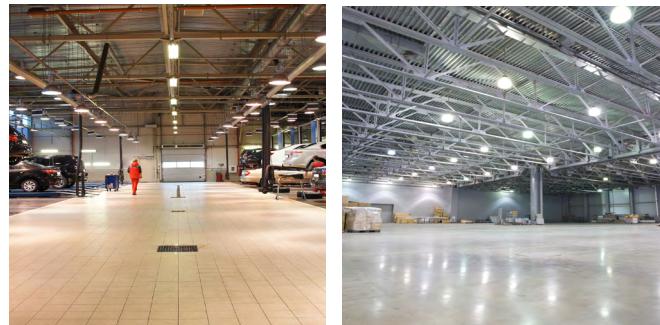

## Intentional Uplighting

All High Bay and Low Bay products feature a ring of LEDs mounted around the base to provide visible uplighting for improved aesthetics and comfort



- Integral driver suitable for 120-277V
- Visible uplighting
- Compatible with EX39 & E39 sockets
- Exceptional efficacy >126 LPW

| SPECIFICATIONS |                      |       |        |            |     |     |              |            |            |          |       |      |
|----------------|----------------------|-------|--------|------------|-----|-----|--------------|------------|------------|----------|-------|------|
| Product        | Model                | CCT   | Lumens | CRI (typ.) | LPW | Dim | Equiv.       | Beam Angle | Life (hrs) | Voltage  | Encl. | DLC  |
| 98121          | 35HIDLB/840/BYP/E26  | 4000K | 4,400  | 82         | 126 | No  | 100-175W HID | 110°       | 50,000     | 120-277V | No    | N.A. |
| 98122          | 35HIDLB/850/BYP/E26  | 5000K | 4,400  | 82         | 126 | No  | 100-175W HID | 110°       | 50,000     | 120-277V | No    | N.A. |
| 98118          | 35HIDLB/840/BYP/EX39 | 4000K | 4,400  | 82         | 126 | No  | 100-175W HID | 110°       | 50,000     | 120-277V | No    | ✓    |
| 98119          | 35HIDLB/850/BYP/EX39 | 5000K | 4,400  | 82         | 126 | No  | 100-175W HID | 110°       | 50,000     | 120-277V | No    | ✓    |
| 98124          | 65HIDHB/840/BYP/EX39 | 4000K | 8,600  | 82         | 132 | No  | 175-250W HID | 110°       | 50,000     | 120-277V | No    | ✓    |
| 98125          | 65HIDHB/850/BYP/EX39 | 5000K | 8,600  | 82         | 132 | No  | 175-250W HID | 110°       | 50,000     | 120-277V | No    | ✓    |
| 98127          | 90HIDHB/840/BYP/EX39 | 4000K | 12,400 | 82         | 138 | No  | 250-400W HID | 110°       | 50,000     | 120-277V | No    | ✓    |
| 98128          | 90HIDHB/850/BYP/EX39 | 5000K | 12,400 | 82         | 138 | No  | 250-400W HID | 110°       | 50,000     | 120-277V | No    | ✓    |



E26 Version Available

## Designed for Wall Pack Applications

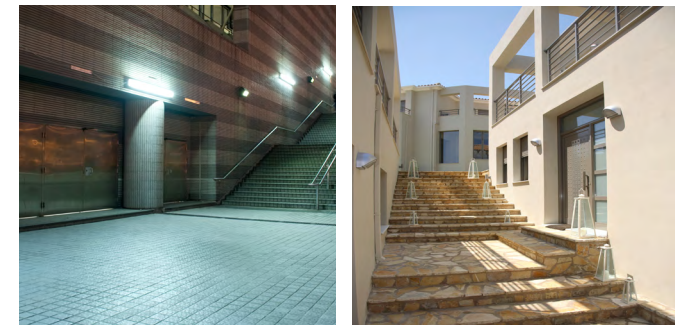

## 350° Rotatable Base



Horizontal lamp supports included



- Integral driver suitable for 120-277V
- Designed for horizontally-mounted wall pack applications
- Exceptional efficacy >140 LPW
- Suitable for use in totally enclosed fixtures

| SPECIFICATIONS |                       |       |        |            |     |     |              |            |            |          |       |      |  |
|----------------|-----------------------|-------|--------|------------|-----|-----|--------------|------------|------------|----------|-------|------|--|
| Product        | Model                 | CCT   | Lumens | CRI (typ.) | LPW | Dim | Equiv.       | Beam Angle | Life (hrs) | Voltage  | Encl. | DLC  |  |
| 98179          | 20HIDWP/840/277V/E26  | 4000K | 2,800  | 82         | 140 | No  | 70-100W HID  | 120°       | 50,000     | 120-277V | Yes   | N.A. |  |
| 98180          | 20HIDWP/850/277V/E26  | 5000K | 2,800  | 82         | 140 | No  | 70-100W HID  | 120°       | 50,000     | 120-277V | Yes   | N.A. |  |
| 98183          | 40HIDWP/840/277V/E26  | 4000K | 5,800  | 82         | 145 | No  | 100-175W HID | 120°       | 50,000     | 120-277V | Yes   | N.A. |  |
| 98184          | 40HIDWP/850/277V/E26  | 5000K | 5,800  | 82         | 145 | No  | 100-175W HID | 120°       | 50,000     | 120-277V | Yes   | N.A. |  |
| 98185          | 40HIDWP/840/277V/EX39 | 4000K | 5,800  | 82         | 145 | No  | 100-175W HID | 120°       | 50,000     | 120-277V | Yes   | ✓    |  |
| 98186          | 40HIDWP/850/277V/EX39 | 5000K | 5,800  | 82         | 145 | No  | 100-175W HID | 120°       | 50,000     | 120-277V | Yes   | ✓    |  |
| 98189          | 54HIDWP/840/277V/EX39 | 4000K | 7,800  | 82         | 144 | No  | 175-250W HID | 120°       | 50,000     | 120-277V | Yes   | ✓    |  |
| 98190          | 54HIDWP/850/277V/EX39 | 5000K | 7,800  | 82         | 144 | No  | 175-250W HID | 120°       | 50,000     | 120-277V | Yes   | ✓    |  |

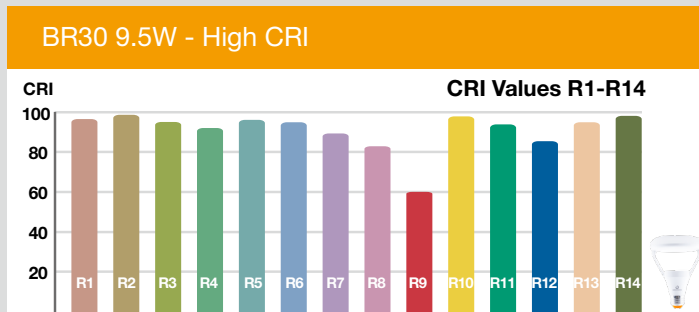

- Revolutionary CLOUD design
- 60% lighter due to environmentally friendly construction
- BR30 high CRI & GU24 versions available
- Suitable for use in totally enclosed fixtures



- Suitable to replace 45W, 65W, 75W, 85W incandescent
- Energy efficient and environmentally friendly
- Providing a comfortable diffused level of light
- Smooth dimming with existing dimmers

SPECIFICATIONS

| Product | Model               | CCT   | Lumens | CRI (typ.) | LPW | Dim | Equiv. | Beam Angle | Life (hrs) | Voltage | Encl. | ES / JA8 / T20 |
|---------|---------------------|-------|--------|------------|-----|-----|--------|------------|------------|---------|-------|----------------|
| 98023   | 9.5BR30DIM/927/R    | 2700K | 700    | 92         | 74  | Yes | 65W    | 110°       | 25,000     | 120V    | Yes   | ✓/✓/✓/✓        |
| 98024   | 9.5BR30DIM/927/GU24 | 2700K | 700    | 92         | 74  | Yes | 65W    | 110°       | 25,000     | 120V    | Yes   | ✓/✓/✓/✓        |

SPECIFICATIONS

| Product | Model           | CCT   | Lumens | CRI (typ.) | LPW | Dim | Equiv. | Beam Angle | Life (hrs) | Voltage | Encl. | ES |
|---------|-----------------|-------|--------|------------|-----|-----|--------|------------|------------|---------|-------|----|
| 98460   | 7.5R20DIM/827   | 2700K | 525    | 82         | 70  | Yes | 45W    | 120°       | 25,000     | 120V    | Yes   | ✓  |
| 98461   | 9BR30DIM/827    | 2700K | 650    | 82         | 72  | Yes | 65W    | 120°       | 25,000     | 120V    | Yes   | ✓  |
| 98462   | 9BR30DIM/830    | 3000K | 650    | 82         | 72  | Yes | 65W    | 120°       | 25,000     | 120V    | Yes   | ✓  |
| 98463   | 9BR30DIM/840    | 4000K | 650    | 82         | 72  | Yes | 65W    | 120°       | 25,000     | 120V    | Yes   | ✓  |
| 98464   | 11BR40DIM/827   | 2700K | 950    | 82         | 86  | Yes | 75W    | 120°       | 25,000     | 120V    | Yes   | ✓  |
| 98465   | 11BR40DIM/830   | 3000K | 950    | 82         | 86  | Yes | 75W    | 120°       | 25,000     | 120V    | Yes   | ✓  |
| 98466   | 15.5BR40DIM/827 | 2700K | 1,100  | 82         | 71  | Yes | 85W    | 120°       | 25,000     | 120V    | No    | ✓  |
| 98467   | 15.5BR40DIM/830 | 3000K | 1,100  | 82         | 71  | Yes | 85W    | 120°       | 25,000     | 120V    | No    | ✓  |

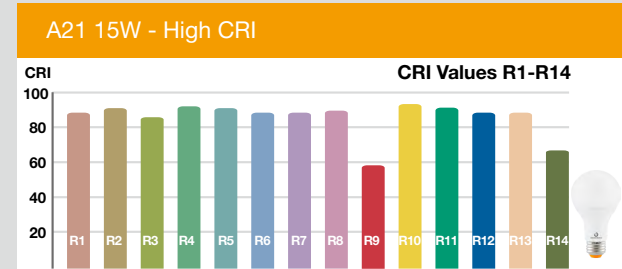

- Suitable to replace 60W, 75W, 100W Incandescent
- High CRI and R values (R9 57, R13 95)
- Suitable for use in totally enclosed fixtures
- 120-277V universal voltage 60W replacements

| SPECIFICATIONS |                    |       |        |            |     |     |        |            |            |          |       |                |
|----------------|--------------------|-------|--------|------------|-----|-----|--------|------------|------------|----------|-------|----------------|
| Product        | Model              | CCT   | Lumens | CRI (typ.) | LPW | Dim | Equiv. | Beam Angle | Life (hrs) | Voltage  | Encl. | ES / JA8 / T20 |
| 98559          | 9A19DIM/927        | 2700K | 800    | 92         | 89  | Yes | 60W    | 240°       | 25,000     | 120V     | Yes   | ✓/✓/✓          |
| 98560          | 9A19DIM/930        | 3000K | 820    | 92         | 91  | Yes | 60W    | 240°       | 25,000     | 120V     | Yes   | ✓/N.A./✓       |
| 98561          | 9A19DIM/940        | 4000K | 860    | 92         | 96  | Yes | 60W    | 240°       | 25,000     | 120V     | Yes   | ✓/N.A./✓       |
| 98565          | 9A19DIM/927/GU24/R | 2700K | 800    | 92         | 89  | Yes | 60W    | 240°       | 25,000     | 120V     | Yes   | ✓/✓/✓          |
| 98562          | 9A19/927/277V      | 2700K | 1,100  | 92         | 89  | No  | 60W    | 300°       | 25,000     | 120-277V | Yes   | ✓/N.A./N.A.    |
| 98563          | 9A19/930/277V      | 3000K | 800    | 92         | 91  | No  | 60W    | 300°       | 25,000     | 120-277V | Yes   | ✓/N.A./N.A.    |
| 98564          | 9A19/940/277V      | 4000K | 820    | 92         | 96  | No  | 60W    | 300°       | 25,000     | 120-277V | Yes   | ✓/N.A./N.A.    |
| 98141          | 11A19DIM/927       | 2700K | 1,100  | 92         | 100 | Yes | 75W    | 240°       | 25,000     | 120V     | Yes   | ✓/N.A./✓       |
| 98142          | 11A19DIM/930       | 3000K | 1,150  | 92         | 105 | Yes | 75W    | 240°       | 25,000     | 120V     | Yes   | ✓/N.A./✓       |
| 98143          | 11A19DIM/940       | 4000K | 1,200  | 92         | 109 | Yes | 75W    | 240°       | 25,000     | 120V     | Yes   | ✓/N.A./✓       |
| 98147          | 15A21DIM/927/N     | 2700K | 1,600  | 92         | 107 | Yes | 100W   | 240°       | 25,000     | 120V     | Yes   | ✓/✓/✓          |
| 98148          | 15A21DIM/930/N     | 3000K | 1,650  | 92         | 110 | Yes | 100W   | 240°       | 25,000     | 120V     | Yes   | ✓/N.A./✓       |
| 98149          | 15A21DIM/940/N     | 4000K | 1,700  | 92         | 113 | Yes | 100W   | 240°       | 25,000     | 120V     | Yes   | ✓/N.A./✓       |



- Suitable to replace 40W, 60W, 75W, 100W Incandescent
- Comfortable warm diffused light
- Tight LED binning for consistent CCT across all lamps
- Smooth dimming with existing dimmers

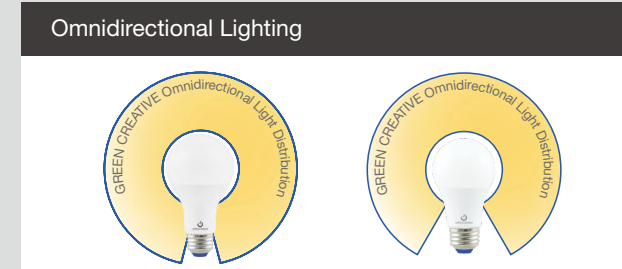

| SPECIFICATIONS |                    |       |        |            |     |     |        |            |            |         |       |    |
|----------------|--------------------|-------|--------|------------|-----|-----|--------|------------|------------|---------|-------|----|
| Product        | Model              | CCT   | Lumens | CRI (typ.) | LPW | Dim | Equiv. | Beam Angle | Life (hrs) | Voltage | Encl. | ES |
| 97985          | 6A19DIM/827/R      | 2700K | 480    | 82         | 80  | Yes | 40W    | 220°       | 25,000     | 120V    | No    | ✓  |
| 97986          | 6A19DIM/830/R      | 3000K | 480    | 82         | 80  | Yes | 40W    | 220°       | 25,000     | 120V    | No    | ✓  |
| 98011          | 8A19DIM/827/R      | 2700K | 800    | 82         | 100 | Yes | 60W    | 220°       | 25,000     | 120V    | No    | ✓  |
| 98012          | 8A19DIM/830/R      | 3000K | 800    | 82         | 100 | Yes | 60W    | 220°       | 25,000     | 120V    | No    | ✓  |
| 98013          | 8A19DIM/840/R      | 4000K | 800    | 82         | 100 | Yes | 60W    | 220°       | 25,000     | 120V    | No    | ✓  |
| 97908          | 9A19DIM/827/GU24/R | 2700K | 800    | 82         | 89  | Yes | 60W    | 240°       | 25,000     | 120V    | Yes   | ✓  |
| 97909          | 9A19DIM/830/GU24/R | 3000K | 820    | 82         | 91  | Yes | 60W    | 240°       | 25,000     | 120V    | Yes   | ✓  |
| 97910          | 9A19DIM/840/GU24/R | 4000K | 860    | 82         | 96  | Yes | 60W    | 240°       | 25,000     | 120V    | Yes   | ✓  |
| 98138          | 11A19DIM/827       | 2700K | 1100   | 82         | 100 | Yes | 75W    | 240°       | 25,000     | 120V    | Yes   | ✓  |
| 98139          | 11A19DIM/830       | 3000K | 1150   | 82         | 105 | Yes | 75W    | 240°       | 25,000     | 120V    | Yes   | ✓  |
| 98140          | 11A19DIM/840       | 4000K | 1200   | 82         | 109 | Yes | 75W    | 240°       | 25,000     | 120V    | Yes   | ✓  |
| 98144          | 15A21DIM/827       | 2700K | 1600   | 82         | 107 | Yes | 100W   | 240°       | 25,000     | 120V    | Yes   | ✓  |
| 98145          | 15A21DIM/830       | 3000K | 1650   | 82         | 110 | Yes | 100W   | 240°       | 25,000     | 120V    | Yes   | ✓  |
| 98146          | 15A21DIM/840       | 4000K | 1700   | 82         | 113 | Yes | 100W   | 240°       | 25,000     | 120V    | Yes   | ✓  |
| 98150          | 15A21DIM/827/GU24  | 2700K | 1600   | 82         | 107 | Yes | 100W   | 240°       | 25,000     | 120V    | Yes   | ✓  |
| 98083          | 14A19/827/3WAY     | 2700K | 1,000  | 82         | 125 | No  | 75W    | 230°       | 15,000     | 120V    | No    | ✓  |
|                |                    |       | 500    |            | 125 |     | 40W    |            |            |         |       |    |
|                |                    |       | 1,500  |            | 107 |     | 100W   |            |            |         |       |    |

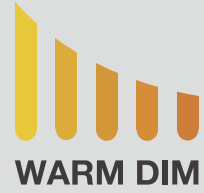

All Warm Dim Lamps Feature 2700K-2200K CCT Dimming



### Lighting for Any Occasion



### 2700K-2200K Warm Dim

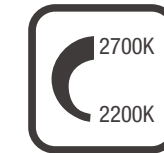

WARM DIM

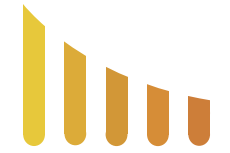

WARM DIM

- Smooth dimming from 2700K-2200K CCT
- Traditional incandescent style dimming
- Exceptional efficacy
- Available in Downlight, BR, A19 & Candle lamps

### SPECIFICATIONS

| Product | Model             | CCT         | Lumens | CRI (typ.) | LPW | Dim | Equiv. | Beam Angle | Life (hrs) | Voltage | Encl. | ES |
|---------|-------------------|-------------|--------|------------|-----|-----|--------|------------|------------|---------|-------|----|
| 57884   | 5B11DIM/8CCTD     | 2200K-2700K | 300    | 82         | 60  | Yes | 40W    | 230°       | 25,000     | 120V    | Yes   | ✓  |
| 58001   | 6.5R20DIM/8CCTD   | 2200K-2700K | 500    | 82         | 77  | Yes | 45W    | 110°       | 25,000     | 120V    | Yes   | ✓  |
| 57885   | 9BR30DIM/8CCTD    | 2200K-2700K | 650    | 82         | 72  | Yes | 65W    | 110°       | 25,000     | 120V    | Yes   | ✓  |
| 57883   | 9.5A19DIM/8CCTD   | 2200K-2700K | 800    | 82         | 84  | Yes | 60W    | 330°       | 25,000     | 120V    | Yes   | ✓  |
| 58002   | 10.5BR40DIM/8CCTD | 2200K-2700K | 735    | 82         | 70  | Yes | 65W    | 110°       | 25,000     | 120V    | Yes   | ✓  |
| 58100   | 11DL6DIM/8CCTD    | 2200K-2700K | 770    | 82         | 70  | Yes | 65W    | 110°       | 40,000     | 120V    | N.A.  | ✓  |

### CREATE THE PERFECT AMBIENCE



These GREEN CREATIVE lamps feature 2700K-2200K CCT dimming designed to replicate the warm dimming effect of traditional incandescent light sources. As the lamp dims, its CCT gradually warms, helping to create the perfect ambience for all occasions.

# FILAMENT LINE



Suitable for All Decorative Applications



- Micro-designed driver - No heatsink required
- Comfortable warm diffused light
- Smooth dimming with existing installations
- Silver bowl design helps redirect light and minimizes glare

## SPECIFICATIONS

| Product | Model                | CCT   | Lumens | CRI (typ.) | LPW | Dim | Equiv. | Beam Angle | Life (hrs) | Voltage | Finish      | ES / T20    |
|---------|----------------------|-------|--------|------------|-----|-----|--------|------------|------------|---------|-------------|-------------|
| 98458   | 1FS14/820/A          | 2000K | 35     | 82         | 75  | Yes | 10W    | 300°       | 15,000     | 120V    | Amber       | N.A. / N.A. |
| 98457   | 1FS14/827            | 2700K | 55     | 82         | 37  | Yes | 10W    | 300°       | 15,000     | 120V    | Clear       | N.A. / N.A. |
| 98459   | 3FT6DIM/820/A        | 2000K | 110    | 82         | 71  | Yes | 25W    | 300°       | 15,000     | 120V    | Amber       | N.A. / N.A. |
| 57946   | 3.5FT10DIM/822/A     | 2200K | 250    | 82         | 90  | Yes | 25W    | 330°       | 15,000     | 120V    | Amber       | N.A. / N.A. |
| 98240   | 4.5FBA11DIM/820/FT/A | 2000K | 240    | 82         | 68  | Yes | 40W    | 300°       | 15,000     | 120V    | Amber       | N.A. / N.A. |
| 98241   | 3.3FB11DIM/927       | 2700K | 300    | 92         | 90  | Yes | 40W    | 300°       | 15,000     | 120V    | Clear       | ✓ / ✓       |
| 98242   | 3.3FB11DIM/927/E26   | 2700K | 300    | 92         | 107 | Yes | 40W    | 300°       | 15,000     | 120V    | Clear       | ✓ / ✓       |
| 98456   | 3.8FB11DIM/827/FR    | 2700K | 300    | 82         | 80  | Yes | 40W    | 300°       | 15,000     | 120V    | Frosted     | N.A. / N.A. |
| 98454   | 5FB11DIM/827         | 2700K | 500    | 82         | 107 | Yes | 60W    | 300°       | 15,000     | 120V    | Clear       | N.A. / N.A. |
| 98455   | 5FB11DIM/827/E26     | 2700K | 500    | 82         | 93  | Yes | 60W    | 300°       | 15,000     | 120V    | Clear       | ✓ / N.A.    |
| 98239   | 4FST19DIM/820/A      | 2000K | 300    | 82         | 90  | Yes | 40W    | 300°       | 15,000     | 120V    | Amber       | N.A. / N.A. |
| 98357   | 5FA19DIM/820/A       | 2000K | 340    | 82         | 92  | Yes | 40W    | 300°       | 15,000     | 120V    | Amber       | N.A. / N.A. |
| 98376   | 5FA19DIM/827         | 2700K | 450    | 82         | 63  | Yes | 40W    | 300°       | 15,000     | 120V    | Clear       | N.A. / N.A. |
| 98450   | 5FA19DIM/827/FR      | 2700K | 450    | 82         | 89  | Yes | 40W    | 300°       | 15,000     | 120V    | Frosted     | N.A. / N.A. |
| 98448   | 7.5FA19DIM/820/A     | 2000K | 600    | 82         | 94  | Yes | 60W    | 300°       | 15,000     | 120V    | Amber       | N.A. / N.A. |
| 98278   | 7.5FA19DIM/827       | 2700K | 800    | 82         | 91  | Yes | 60W    | 300°       | 15,000     | 120V    | Clear       | ✓ / N.A.    |
| 98449   | 7.5FA19DIM/827/FR    | 2700K | 800    | 82         | 91  | Yes | 60W    | 300°       | 15,000     | 120V    | Frosted     | N.A. / N.A. |
| 98358   | 7.5FA19DIM/827/SB    | 2700K | 700    | 82         | 53  | Yes | 60W    | N.A.       | 15,000     | 120V    | Silver Bowl | N.A. / N.A. |
| 98279   | 9FA19DIM/927         | 2700K | 810    | 92         | 79  | Yes | 60W    | 300°       | 15,000     | 120V    | Clear       | ✓ / ✓       |
| 98453   | 4FG16.5DIM/820/A     | 2000K | 250    | 82         | 100 | Yes | 40W    | 300°       | 15,000     | 120V    | Amber       | N.A. / N.A. |
| 98451   | 4FG16.5DIM/827       | 2700K | 350    | 82         | 100 | Yes | 40W    | 300°       | 15,000     | 120V    | Clear       | N.A. / N.A. |
| 98452   | 4FG16.5DIM/827/E26   | 2700K | 350    | 82         | 88  | Yes | 40W    | 300°       | 15,000     | 120V    | Clear       | N.A. / N.A. |
| 98378   | 4FG25DIM/820/A       | 2000K | 250    | 82         | 88  | Yes | 40W    | 300°       | 15,000     | 120V    | Amber       | N.A. / N.A. |
| 97826   | 4.5FG25DIM/827/SB    | 2700K | 400    | 82         | 63  | Yes | 40W    | N.A.       | 15,000     | 120V    | Silver Bowl | N.A. / N.A. |
| 98377   | 3.8FG25DIM/927       | 2700K | 350    | 92         | 55  | No  | 40W    | 300°       | 15,000     | 120V    | Clear       | ✓ / ✓       |
| 57945   | 5FG40DIM/827         | 2700K | 470    | 82         | 35  | No  | 40W    | 330°       | 15,000     | 120V    | Clear       | ✓ / N.A.    |

# DECORATIVE LINE



Suitable for All Decorative Applications

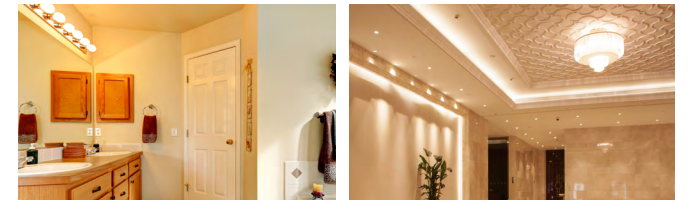

- 40W incandescent replacements
- Perfect decorative retrofit needs
- Omnidirectional: 275° beam angle
- Powerful 450 lumens in 2700K

## SPECIFICATIONS

| Product | Model         | CCT   | Lumens | CRI (typ.) | LPW | Dim | Equiv. | Beam Angle | Life (hrs) | Voltage | Encl. | ES |
|---------|---------------|-------|--------|------------|-----|-----|--------|------------|------------|---------|-------|----|
| 97729   | 6G25DIM/827/R | 2700K | 450    | 82         | 75  | Yes | 40W    | 275°       | 25,000     | 120V    | No    | ✓  |

**V2019.2**

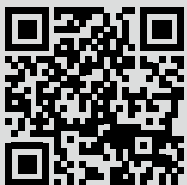

**Tel / Fax: (866) 774-5433**

**info@greencreative.com**

**www.greencreative.com**

 / GREENCREATIVELED

 / GClightingLED

 / GREEN CREATIVE



**GREENCREATIVE**