



Energy Star & DLC Product Guide

FOR COMMERCIAL AND RESIDENTIAL APPLICATIONS



WWW.IUSEELITE.COM





Elite Products Rebate Programs

Depending on your location, you may be eligible for a sizeable rebate when installing LED solutions in your existing facility or new construction project. Rebates may be available for a variety of LED replacements.

Often, rebate and incentive programs have requirements products must meet in order to qualify for funds. They may require a certain wattage, shape, warranty or listing by an organization such as Energy Star or Design Lights Consortium (DLC).

Elite Lighting Energy Star and DLC certify products help you to get approve for those rebate program.

Check our new Utility Rebate Calculator Tool to find rebate information and programs available for our products:

<http://www.iuseelite.com/rebate>



JAB
JABE

elite
LED LIGHTING



RL431 - UNIVERSAL LED RETROFIT DIE-CAST ALUMINUM LENSED WHITE BAFFLE

FITS IN MOST 4" REGULAR INCANDESCENT HOUSINGS

BAFFLE

4" **650** **27K, 30K** **90**
LUMENS CCT CRI



EXAMPLE: RL431-650L-DIMTR-120-30K-90-W-WH

SERIES	LUMENS	CCT	CRI	FINISH
RL431	650L-DIMTR-120	27K 30K 35K 40K	90+	W-WH



RL428 - UNIVERSAL LED RETROFIT DIE-CAST ALUMINUM LENSED WHITE REFLECTOR

FITS IN MOST 4" REGULAR INCANDESCENT HOUSINGS

REFLECTOR

4" **650** **27K, 30K** **90**
LUMENS CCT CRI



EXAMPLE: RL428-650L-DIMTR-120-30K-90-W-WH

SERIES	LUMENS	CCT	CRI	FINISH
RL428	650L-DIMTR-120 650L-277(Not dimmable)	27K 30K 35K 40K 50K	90+	W-WH



REL437 - ECONOMY UNIVERSAL LED RETROFIT DIE-CAST ALUMINUM LENSED WHITE BAFFLE

FITS IN MOST 4" REGULAR INCANDESCENT HOUSINGS

REFLECTOR

4" **700** **27K, 30K** **90**
LUMENS CCT CRI

1100

EXAMPLE: REL437-700L-DIMTR-120-30K-90-W-WH

SERIES	LUMENS	CCT	CRI	FINISH
REL437	700L-DIMTR-120 1100L-DIMTR-120	27K (700L only) 30K 35K 40K 50K	90+	W-WH



RL485 - UNIVERSAL LED RETROFIT SQUARE DOWNLIGHTING

FITS IN MOST 4" REGULAR INCANDESCENT HOUSINGS

REFLECTOR

4" **650** **27K, 30K** **90**
LUMENS CCT CRI



EXAMPLE: RL485-650L-DIMTR-120-90-30K-W-WH

SERIES	LUMENS	CCT	CRI	FINISH
RL485	650L-DIMTR-120	27K 30K 40K 50K	90+	W-WH



RL432 - 4" LED RETROFIT DIE-CAST ALUMINUM LENSED STEPPED BAFFLE

FITS IN MOST 4" REGULAR INCANDESCENT HOUSINGS

BAFFLE

4" **700** **27K, 30K** **90**
LUMENS CCT CRI



EXAMPLE: RL432-700L-DIMTR-120-30K-90-W-WH

SERIES	LUMENS	CCT	CRI	FINISH
RL432	700L-DIMTR-120	27K 30K 35K 40K 50K	90+	W-WH



NEW
ADJUSTABLE
DESIGN

RL481 - SQUARE ADJUSTABLE LED RETROFIT MODULE

FITS IN MOST 4" REGULAR INCANDESCENT HOUSINGS

ADJUSTABLE

4" **650** **27K, 30K** **90**
LUMENS LUMENS CCT CRI
35K, 40K, 50K



EXAMPLE: RL481-650L-DIMTR-120-90-30K-W-WH

SERIES	LUMENS	CCT	CRI	FINISH
RL481	650L-DIMTR-120	27K 30K 35K 40K 50K	90+	WH SN BK



NEW
ADJUSTABLE
DESIGN

RL461 - ROUND ADJUSTABLE LED RETROFIT MODULE

FITS IN MOST 4" REGULAR INCANDESCENT HOUSINGS

REFLECTOR

4" **650** **27K, 30K** **90**
LUMENS LUMENS CCT CRI
35K, 40K, 50K



EXAMPLE: RL461-650L-DIMTR-120-30K-90-WH

SERIES	LUMENS	CCT	CRI	FINISH
RL461	RL461-650L-DIMTR-120	27K 30K 35K 40K 50K	90+	WH SN BK



NEW
ADJUSTABLE
DESIGN

RL403 - 4" LED RETROFIT 38° BEAM ANGLE DOWNLIGHT

FITS IN MOST 4" REGULAR INCANDESCENT HOUSINGS

REFLECTOR

4" **600** **27K, 30K** **90**
LUMENS LUMENS CCT CRI
35K, 40K, 50K



EXAMPLE: RL403-700L-DIMTR-120-30K-90-W-WH

SERIES	LUMENS	CCT	CRI	FINISH
REL403	600L-DIMTR-120	27K 30K 35K 40K 50K	90+	W-WH



NEW
ADJUSTABLE
DESIGN

RL465 - 4" LED ADJUSTABLE RETROFIT 24°, 38°, 60° BEAM ANGLE

FITS IN MOST 4" REGULAR INCANDESCENT HOUSINGS

ADJUSTABLE

4" **650** **27K, 30K** **90**
LUMENS LUMENS CCT CRI
35K, 40K, 50K



EXAMPLE: RL465-650L-DIMTR-120-90-30K-W-WH

SERIES	LUMENS	CCT	CRI	FINISH
RL465	650L-DIMTR-120	27K 30K 35K 40K 50K	90+	WH SN



RL531 - UNIVERSAL LED RETROFIT DIE-CAST ALUMINUM LENSED WHITE BAFFLE

FITS IN MOST 5" REGULAR INCANDESCENT HOUSINGS

BAFFLE

5" **950** **27K, 30K** **90**
LUMENS CCT CRI



EXAMPLE: RL531-650L-DIMTR-120-30K-90-W-WH

SERIES	LUMENS	CCT	CRI	FINISH
RL531	950L-DIMTR-120	27K 30K 35K 40K	90+	W-WH



RL528 - UNIVERSAL LED RETROFIT DIE-CAST ALUMINUM LENSED WHITE REFLECTOR

FITS IN MOST 5" REGULAR INCANDESCENT HOUSINGS

REFLECTOR

5" **950** **27K, 30K** **90**
LUMENS CCT CRI



EXAMPLE: RL528-950L-DIMTR-120-30K-90-W-WH

SERIES	LUMENS	CCT	CRI	FINISH
RL528	950L-DIMTR-120	27K 30K 35K 40K 50K	90+	W-WH



RL530 - 5" LED RETROFIT DIE-CAST ALUMINUM LENSED STEPPED BAFFLE

FITS IN MOST 5" REGULAR INCANDESCENT HOUSINGS

BAFFLE

5" **900** **27K, 30K** **85+**
LUMENS CCT CRI



EXAMPLE: RL530-900L-DIMTR-120-30K-90-W-WH

SERIES	LUMENS	CCT	CRI	FINISH
RL530	650L-DIMTR-120 900L-DIMTR-120	27K 30K 35K 40K 50K	90+	W-WH



RL507 - ULTRA-THIN LED RETROFIT MODULE

FITS IN MOST 5" REGULAR INCANDESCENT HOUSINGS

REFLECTOR

5" **900** **27K, 30K** **85+**
LUMENS CCT CRI



EXAMPLE: RL507-900L-DIMTR-120-30K-90-W-WH

SERIES	LUMENS	CCT	CRI	FINISH
RL507	650L-DIMTR-120 900L-DIMTR-120	27K 30K 35K 40K 50K	90+	W-WH



REL537 - ECONOMY UNIVERSAL LED RETROFIT DIE-CAST ALUMINUM LENSED WHITE BAFFLE

FITS IN MOST 5" REGULAR INCANDESCENT HOUSINGS

BAFFLE

5" **950** **27K, 30K** **90**
LUMENS CCT CRI



EXAMPLE: REL537-950L-DIMTR-120-30K-90-W-WH

SERIES	LUMENS	CCT	CRI	FINISH
REL537	950L-DIMTR-120 1200L-DIMTR-120	27K 30K 35K (900L only) 40K 50K	90+	W-WH

COLOR CLIP ON TRIM INSERTS NOW AVAILABLE

Get a 4", 5" or 6" Standard white trim and choose between our 14 insert color options



RL631

Universal LED Retrofit Die-cast Aluminum Lensed White Baffle

AVAILABLE COLOR INSERTS FOR RL631 - 6" RETROFIT

REFLECTORS



RL631-RT-SHZ-WH



RL631-RT-RG-WH



RL631-RT-CP-CP



RL631-RT-BZ-BZ



RL631-RT-CL-WH



RL631-RT-SHZ-SHZ



RL631-RT-MB-WH



RL631-RT-SN-SN



RL631-RT-MB-BK



RL631-RT-CL-CH

BAFFLES



RL631-BT-P-BK



RL631-BT-BZ-BZ



RL631-BT-SN-SN



RL631-BT-P-WH



RL531

Universal LED Retrofit Die-cast Aluminum Lensed White Baffle

AVAILABLE COLOR INSERTS FOR RL531 - 5" RETROFIT

REFLECTORS



RL531-RT-SHZ-WH



RL531-RT-RG-WH



RL531-RT-CP-CP



RL531-RT-BZ-BZ



RL531-RT-CL-WH



RL531-RT-SHZ-SHZ



RL531-RT-MB-WH



RL531-RT-SN-SN



RL531-RT-MB-BK



RL531-RT-CL-CH

BAFFLES



RL531-BT-P-BK



RL531-BT-BZ-BZ



RL531-BT-SN-SN



RL531-BT-P-WH



RL431

Universal LED Retrofit Die-cast Aluminum Lensed White Baffle

AVAILABLE COLOR INSERTS FOR RL431 - 4" RETROFIT

REFLECTORS



RL431-RT-SHZ-WH



RL431-RT-RG-WH



RL431-RT-CP-CP



RL431-RT-BZ-BZ



RL431-RT-CL-WH



RL431-RT-SHZ-SHZ



RL431-RT-MB-WH



RL431-RT-SN-SN



RL431-RT-MB-BK



RL431-RT-CL-CH

BAFFLES



RL431-BT-P-BK



RL431-BT-BZ-BZ



RL431-BT-SN-SN



RL431-BT-P-WH

THIN RETROFIT MODULES



RL477 - ULTRA-THIN LED RETROFIT MODULE

1" THICK LED FIXTURE WITH HIGHER BRIGHTNESS

REFLECTOR

4" **600** **27K** **90**
LUMENS CCT CRI



EXAMPLE: RL477-600L-DIMTR-120-30K-90-W-WH

SERIES	LUMENS	CCT	CRI	FINISH
RL477	600L-DIMTR-120	27K 30K 40K	90+	WH BR BK BN



RL677 - ULTRA-THIN LED RETROFIT MODULE

1" THICK LED FIXTURE WITH HIGHER BRIGHTNESS

ULTRA THIN LED

6" **850** **27K** **90**
LUMENS CCT CRI



EXAMPLE: RL677-850L-DIMTR-120-30K-90-W-WH

SERIES	LUMENS	CCT	CRI	FINISH
RL677	850L-DIMTR-120	27K 30K 40K	90+	WH BR BK BN



RL475 - ULTRA-THIN LED RETROFIT MODULE

1" THICK LED FIXTURE WITH HIGHER BRIGHTNESS

REFLECTOR

4" **700** **27K, 30K** **90**
LUMENS CCT CRI



EXAMPLE: RL475-700L-DIMTR-120-30K-90-W-WH

SERIES	LUMENS	CCT	CRI	FINISH
RL475	550L-DIMTR-120 700L-DIMTR-120	27K 30K 35K 40K 50K	90+	WH



RL675 - ULTRA-THIN LED RETROFIT MODULE

1" THICK LED FIXTURE WITH HIGHER BRIGHTNESS

ULTRA THIN LED

6" **900** **27K, 30K** **90**
LUMENS CCT CRI



EXAMPLE: RL675-900L-DIMTR-120-30K-90-W-WH

SERIES	LUMENS	CCT	CRI	FINISH
RL675	900L-DIMTR-120	27K 30K 35K 40K 50K	90+	WH



RL373 - 3" RECESSED GIMBAL SLIM LED

1-3/4" THIN LED FIXTURE WITH HIGHER BRIGHTNESS

ULTRA THIN LED

3" **600** **30K, 40K, 50K** **90**
LUMENS CCT CRI



EXAMPLE: RL373-600L-DIMTR-120-30K-90-W-WH

SERIES	LUMENS	CCT	CRI	FINISH
RL373	600L-DIMTR-120	30K 40K 50K	90+	WH BN BK



RL670 - UNIVERSAL RECESSED AND SURFACE MOUNT LED MODULE

FITS 4", 5" AND 6" HOUSINGS AND 4" J-BOX

SURFACE MOUNT

6" **1000** **27K** **90**
LUMENS CCT CRI



EXAMPLE: RL670-1000L-DIMTR-120-30K-90W-WH

SERIES	LUMENS	CCT	CRI	FINISH
RL670	1000L-DIMTR-120	27K 30K 40K	90+	W-WH

SURFACE MOUNT RETROFIT MODULE



RL591 - ROUND LED SLIM SURFACE MOUNT DIMMABLE FIXTURE
1" THICK SURFACE LED FIXTURE

REFLECTOR

4" **600** **30K, 40K** **90**
LUMENS CCT CRI



EXAMPLE: RL591-600L-DIMTR-120-30K-90-W-WH

SERIES	LUMENS	CCT	CRI	FINISH
RL591	600L-DIMTR-120	30K 40K	90+	WH



RL595 - SQUARE LED SLIM SURFACE MOUNT DIMMABLE FIXTURE
1" THICK SURFACE LED FIXTURE

ULTRA THIN LED

6" **600** **30K, 40K** **90**
LUMENS CCT CRI



EXAMPLE: RL595-600L-DIMTR-120-30K-90-W-WH

SERIES	LUMENS	CCT	CRI	FINISH
RL595	600L-DIMTR-120	30K 40K	90+	WH



RL791 - Round LED Slim Surface Mount Dimmable Fixture
1" THICK SURFACE LED FIXTURE

SURFACE MOUNT

6" **900** **30K, 40K** **90**
LUMENS CCT CRI



EXAMPLE: RL791-900L-DIMTR-120-30K-90W-WH

SERIES	LUMENS	CCT	CRI	FINISH
RL791	900L-DIMTR-120	30K 40K	90+	W-WH



RL795 - ROUND LED SLIM SURFACE MOUNT DIMMABLE FIXTURE
1" THICK SURFACE LED FIXTURE

REFLECTOR

7" **900** **30K, 40K** **90**
LUMENS CCT CRI



EXAMPLE: RL795-900L-DIMTR-120-30K-90-W-WH

SERIES	LUMENS	CCT	CRI	FINISH
RL795	900L-DIMTR-120	30K 40K	90+	WH



RL991 - SQUARE LED SLIM SURFACE MOUNT DIMMABLE FIXTURE
1" THICK SURFACE LED FIXTURE

ULTRA THIN LED

9" **1200** **30K, 40K** **90**
LUMENS CCT CRI



EXAMPLE: RL991-1200L-DIMTR-120-30K-90-W-WH

SERIES	LUMENS	CCT	CRI	FINISH
RL991	1200L-DIMTR-120	30K 40K	90+	WH



RL995 - Round LED Slim Surface Mount Dimmable Fixture
1" THICK SURFACE LED FIXTURE

SURFACE MOUNT

9" **1200** **30K, 40K** **90**
LUMENS CCT CRI



EXAMPLE: RL995-1200L-DIMTR-120-30K-90W-WH

SERIES	LUMENS	CCT	CRI	FINISH
RL995	1200L-DIMTR-120	30K 40K	90+	W-WH

6"

6" LED RETROFIT MODULE



RL631 - UNIVERSAL LED RETROFIT DIE-CAST ALUMINUM LENSED WHITE BAFFLE

FITS IN MOST 6" REGULAR INCANDESCENT HOUSINGS

BAFFLE

6" **950** **27K, 30K** **90**
LUMENS 35K, 40K CCT CRI



EXAMPLE: RL631-950L-DIMTR-120-30K-90-W-WH

SERIES	LUMENS	CCT	CRI	FINISH
RL631	950L-DIMTR-120	27K 30K 35K 40K	90+	W-WH



RL628 - UNIVERSAL LED RETROFIT DIE-CAST ALUMINUM LENSED WHITE REFLECTOR

FITS IN MOST 6" REGULAR INCANDESCENT HOUSINGS

REFLECTOR

6" **950** **27K, 30K** **90**
LUMENS 35K, 40K, 50K CCT CRI



EXAMPLE: RL628-950L-DIMTR-120-30K-90-W-WH

SERIES	LUMENS	CCT	CRI	FINISH
RL628	950L-DIMTR-120	27K 30K 35K 40K 50K	90+	W-WH



REL637 - ECONOMY UNIVERSAL LED RETROFIT DIE-CAST ALUMINUM LENSED WHITE BAFFLE

FITS IN MOST 6" REGULAR INCANDESCENT HOUSINGS

BAFFLE

6" **950** **27K, 30K** **90**
LUMENS 35K, 40K, 50K CCT CRI

1200
LUMENS



EXAMPLE: REL637-950L-DIMTR-120-30K-90-W-WH

SERIES	LUMENS	CCT	CRI	FINISH
REL637	950L-DIMTR-120 1200L-DIMTR-120	27K 30K 35K 40K 50K	90+	W-WH



RL664 - UNIVERSAL 6"- ADJUSTABLE LED RETROFIT MODULE

FITS IN MOST 6" REGULAR INCANDESCENT HOUSINGS

REFLECTOR

6" **900** **27K, 30K** **90**
LUMENS 35K, 40K, 50K CCT CRI



EXAMPLE: RL664-900L-DIMTR-120-90-30K-W-WH

SERIES	LUMENS	CCT	CRI	FINISH
RL664	900L-DIMTR-120	27K 30K 35K 40K 50K	90+	WH



RL665 - 6" LED ADJUSTABLE RETROFIT 24°, 38°, 60° BEAM ANGLE

FITS IN MOST 6" REGULAR INCANDESCENT HOUSINGS

REFLECTOR

6" **1100** **27K, 30K** **90**
LUMENS 35K, 40K, 50K CCT CRI



EXAMPLE: RL665-1100L-DIMTR-120-90-30K-W-WH

SERIES	LUMENS	CCT	CRI	FINISH
RL665	1100L-DIMTR-120	27K 30K 35K 40K 50K	90+	WH SN

NEW ADJUSTABLE DESIGN

NEW

90 CRI

6"

LED DIMMABLE
100% to 10%

RL641

6" LED Retrofit Baffle Lighting Module With Junction Box

1150 LUMENS

Example: RL641-1150L-DIM10-MVOLT-40K-90-WH

CATALOG

RL641-1150L-DIM10-MVOLT

CCT

35K-(3500K)

40K-(4000K)

CRI

90

FINISH

W-WH

NEW

90 CRI

8"

LED DIMMABLE
100% to 10%

RL841

8" LED Retrofit Baffle Lighting Module With Junction Box

2500 LUMENS

Example: RL841-2500L-DIM10-MVOLT-40K-90-W-WH

CATALOG

RL841-2500L-DIM10-MVOLT

CCT

35K-(3500K)

40K-(4000K)

CRI

90

FINISH

W-WH



RL607 - 6" LED RETROFIT DIE-CAST ALUMINUM LENSED REFLECTOR TRIM

FITS IN MOST 6" REGULAR INCANDESCENT HOUSINGS

REFLECTOR

6" **1200** **27K, 30K** **90**
LUMENS **35K, 40K, 50K** CRI



EXAMPLE: RL607-900L-DIMTR-120-30K-90-W-WH

SERIES	LUMENS	CCT	CRI	FINISH
RL607	750L-DIMTR-120 900L-DIMTR-120 1200L-DIMTR-120	27K 30K 35K 40K 50K	90+	W-WH



RL630 - 6" LED RETROFIT DIE-CAST ALUMINUM LENSED BAFFLE TRIM

FITS IN MOST 6" REGULAR INCANDESCENT HOUSINGS

BAFFLE

6" **750** **27K, 30K** **90**
LUMENS **35K, 40K, 50K** CRI



EXAMPLE: RL630-750L-DIMTR-120-30K-90-W-WH

SERIES	LUMENS	CCT	CRI	FINISH
RL630	750L-DIMTR-120 900L-DIMTR-120 1200L-DIMTR-120	27K 30K 35K 40K 50K	90+	W-WH



RL663 - UNIVERSAL 6" ADJUSTABLE LED RETROFIT MODULE

FITS IN MOST 6" REGULAR INCANDESCENT HOUSINGS

BAFFLE

6" **750** **27K, 30K** **85+**
LUMENS **35K, 40K, 50K** **90+**
CRI



EXAMPLE: RL663-750L-DIMTR-120-30K-90-W-WH

SERIES	LUMENS	CCT	CRI	FINISH
RL663	750L-DIMTR-120	27K 30K 35K 40K 50K	85+ 90+	W-WH



REL625 - UNIVERSAL 6", 5" LED RETROFIT MODULE

FITS IN MOST 6" AND 5" REGULAR INCANDESCENT HOUSINGS

REFLECTOR

6" **750** **30K, 35K** **90**
LUMENS **40K, 50K** CRI



EXAMPLE: RL625-750L-DIMTR-120-30K-90-W-WH

SERIES	LUMENS	CCT	CRI	FINISH
RL625	750L-DIMTR-120	30K 35K 40K 50K	90+	W-WH



RL685 - UNIVERSAL LED RETROFIT SQUARE DOWNLIGHTING

FITS IN MOST 6" REGULAR INCANDESCENT HOUSINGS

REFLECTOR

6" **950** **27K, 30K** **90**
LUMENS **40K, 50K** CRI



EXAMPLE: RL685-950L-DIMTR-120-90-30K-W-WH

SERIES	LUMENS	CCT	CRI	FINISH
RL685	950L-DIMTR-120	27K 30K 40K 50K	90+	W-WH



RL632 - UNIVERSAL 6" LED RETROFIT MODULE

FITS IN MOST 6" REGULAR INCANDESCENT HOUSINGS

REFLECTOR

6" **950** **27K, 30K** **90**
LUMENS **35K, 40K, 50K** CRI



EXAMPLE: RL632-950L-DIMTR-120-90-30K-W-WH

SERIES	LUMENS	CCT	CRI	FINISH
RL632	950L-DIMTR-120	27K 30K 35K 40K 50K	90+	W-WH



B6IC-LED - 6" NEW CONSTRUCTION IC LED HOUSING

NEW CONSTRUCTION

6" 900 LUMENS

B6IC-LED
6" LED IC Housing



EXAMPLE: B6IC-LED-650L-DIM10-MVOLT-MD-30K-AT

SERIES	LUMENS	OPTICS	CCT	CRI	AIR-SHUT
B6IC-LED	650L-DIMTR-120	MD (MEDIUM)	27K 30K 35K 40K 50K	85+ 90+	AT
	650L-LUTH-120				EMERGENCY
	650L-LUTH-277				EMG
	650-DIM10-MVOLT				
	900L-DIMTR-120				
	900L-LUTH-120				
900L-LUTH-277					
900L-DIM10-MVOLT					

* Check next page for available trim options
Add selected trim part number at the end



B6RIC-LED - 6" REMODEL IC LED HOUSING

REMODEL

6" 900 LUMENS

B6RIC-LED
6" LED IC Remodel Housing



EXAMPLE: B6RIC-LED-650L-DIM10-MVOLT-MD-30K-AT-L631-W

SERIES	LUMENS	OPTICS	CCT	CRI	AIR-SHUT
B6RIC-LED	650L-DIMTR-120	MD (MEDIUM)	27K 30K 35K 40K 50K	85+ 90+	AT
	650L-LUTH-120				EMERGENCY
	650L-LUTH-277				EMG
	650-DIM10-MVOLT				
	900L-DIMTR-120				
	900L-LUTH-120				
900L-LUTH-277					
900L-DIM10-MVOLT					

* Check next page for available trim options
Add selected trim part number at the end

5" LED RECESSED DOWNLIGHT

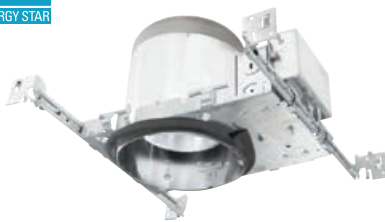

B5IC-LED - 5" REMODEL IC LED HOUSING

NEW CONSTRUCTION

5" 900 LUMENS

B5IC-LED
5" LED IC Housing



EXAMPLE: B5IC-LED-650L-DIM10-MVOLT-MD-30K-AT

SERIES	LUMENS	OPTICS	CCT	CRI	AIR-SHUT
B5IC-LED	650L-DIMTR-120	MD (MEDIUM)	27K 30K 35K 40K 50K	85+ 90+	AT
	650L-LUTH-120				EMERGENCY
	650L-LUTH-277				EMG
	650-DIM10-MVOLT				
	900L-DIMTR-120				
	900L-LUTH-120				
900L-LUTH-277					
900L-DIM10-MVOLT					

* Check next page for available trim options
Add selected trim part number at the end



B25IC-LED - 5 INCH NEW CONSTRUCTION IC LED SHALLOW HOUSING

NEW CONSTRUCTION

5" 650 LUMENS

B25IC-LED
5" LED IC Housing



EXAMPLE: LED25IC-LED-650L-DIM10-MVOLT-MD-30K-AT

SERIES	LUMENS	OPTICS	CCT	CRI	AIR-SHUT
B25IC-LED	650L-DIMTR-120	MD (MEDIUM)	27K 30K 35K 40K 50K	85+ 90+	AT
	650L-LUTH-120				EMERGENCY
	650L-LUTH-277				EMG
	650-DIM10-MVOLT				

* Check next page for available trim options
Add selected trim part number at the end

Trims are available in 5" and 6". Just include the aperture of the trim in the empty space to specify the trim size. For example L531W-WH.

BAFFLE TRIM OPTIONS



L631W-WH
PHENOLIC STEPPED BAFFLE



L631P-BK
PHENOLIC STEPPED BAFFLE



L631SN-SN
METAL STEPPED BAFFLE



L631CP-CP
METAL STEPPED BAFFLE



L631BZ-BZ
METAL STEPPED BAFFLE

REFLECTOR TRIM OPTIONS



L607CL-WH
REFLECTOR



L607SN-SN
REFLECTOR



L607MB-WH
REFLECTOR



L607RG-WH
REFLECTOR



L607SHZ-WH
REFLECTOR



L607BZ-BZ
REFLECTOR



L607CP-CP
REFLECTOR



L607W-WH
REFLECTOR

LENSED BAFFLE TRIMS



L656W-WH
BAFFLE WITH FROSTED DOME SHOWER LENS



L676W-WH
BAFFLE WITH FROSTED LENS



L675W-WH
BAFFLE WITH PRISMATIC LENS



L635W-WH
BAFFLE WITH ALBALITE LENS



L636W-WH
BAFFLE WITH FRESNEL LENS



BAFFLE FINISH:
BZ CP SN W P



RING FINISH:
BK WH CH PB SN CP BZ



LENSED REFLECTOR TRIMS



L657CL-WH
REFLECTOR WITH FROSTED DOME SHOWER LENS



L659CL-WH
REFLECTOR WITH FROSTED LENS



L658CL-WH
REFLECTOR WITH PRISMATIC LENS



L641CL-WH
REFLECTOR WITH ALBALITE LENS



L642CL-WH
REFLECTOR WITH FRESNEL LENS



BAFFLE FINISH:
BZ CP SN W P



RING FINISH:
BK WH CH PB SN CP BZ



LENSED TRIMS



L652WH
SMOOTH FROSTED LENS



L612WH
SMOOTH FROSTED DOME LENS



L606WH/L606L
METAL/PLASTIC DROP OPAL LENS



L645WH
DESIGNER POINT LENS



L601WH/L601L
METAL/PLASTIC ALBALITE LENS



L605WH/L605L
METAL/PLASTIC FRESNEL LENS



RING FINISH:
BK WH CH PB SN CP BZ



SQUARE LENSED TRIMS



L688WH
SQUARE ALBALITE LENS



L685WH
SQUARE FRESNEL LENS



L696WH
SQUARE DESIGNER FROSTED LENS



L680WH
SQUARE DESIGNER POINT LENS



L681BZ-WH
SQUARE BAFFLE



L687CP-WH
SQUARE REFLECTOR



RING FINISH:
BK WH CH PB SN CP BZ



LED2-4-IC - 4" NEW CONSTRUCTION IC LED DOWNLIGHT

NEW CONSTRUCTION

UP TO
4" 600 LUMENS

LED2-4-IC
4" LED IC Housing



EXAMPLE: LED2-4-IC-600L-AT/LED2-1401-600L-ND-30K-90

SERIES	LUMENS	AIR-SHUT	TRIM	OPTICS	CCT	CRI
LED2-4-IC	600L-DIMTR-120	AT	LED2-1401 LED2-1405	ND	27K	85+
	600L-LUTH-120			(Narrow)	30K	90+
	600L-LUTH-277			MD	35K	
	600-DIM10-MVOLT			(Medium)	40K	
				WD	50K	
				(Wide)		

* Check next page for available trim options
Add selected trim part number at the end



LED2-4 - 4" NEW CONSTRUCTION LED DOWNLIGHT

NEW CONSTRUCTION

UP TO
4" 600 LUMENS

LED2-4
4" LED Housing



EXAMPLE: LED2-4-600L-AT/LED2-1401-600L-ND-30K-90

SERIES	LUMENS	AIR-SHUT	TRIM	OPTICS	CCT	CRI
LED2-4	600L-DIMTR-120	AT	LED2-1401 LED2-1405	ND	27K	85+
	600L-LUTH-120			(Narrow)	30K	90+
	600L-LUTH-277			MD	35K	
	600-DIM10-MVOLT			(Medium)	40K	
				WD	50K	
				(Wide)		

* Check next page for available trim options
Add selected trim part number at the end



LED2-4-R - 4" REMODEL LED DOWNLIGHT

REMODEL

UP TO
4" 600 LUMENS

LED2-4-R
4" LED Remodel Housing



EXAMPLE: LED2-4-R-600L-AT/LED2-1401-600L-ND-30K-W-WH

SERIES	LUMENS	AIR-SHUT	TRIM	OPTICS	CCT	CRI
LED2-4-R	600L-DIMTR-120	AT	LED2-1401 LED2-1405	ND	27K	85+
	600L-LUTH-120			(Narrow)	30K	90+
	600L-LUTH-277			MD	35K	
	600-DIM10-MVOLT			(Medium)	40K	
				WD	50K	
				(Wide)		

* Check next page for available trim options
Add selected trim part number at the end

3" LED RECESSED DOWNLIGHT



LED2-3-IC - 3" NEW CONSTRUCTION IC LED DOWNLIGHT

NEW CONSTRUCTION

UP TO
3" 500 LUMENS

LED2-3-IC
3" LED IC Housing



EXAMPLE: LED2-3-IC-500L-AT/LED2-1301-500L-ND-30K-W-WH

SERIES	LUMENS	AIR-SHUT	TRIM	OPTICS	CCT	CRI
LED2-3-IC	500L-DIMTR-120	AT	LED2-1301 LED2-1302 LED2-1362	ND	27K	85+
	500L-LUTH-120			(Narrow)	30K	90+
	500L-LUTH-277			MD	35K	
	500-DIM10-MVOLT			(Medium)	40K	
				WD	50K	
				(Wide)		

* Check next page for available trim options
Add selected trim part number at the end



LED2-3 - 3" NEW CONSTRUCTION LED DOWNLIGHT

NEW CONSTRUCTION

UP TO
3" 500 LUMENS

LED2-3
3" LED Housing



EXAMPLE: LED2-3-600L-AT/LED2-1301-500L-ND-30K-W-WH

SERIES	LUMENS	AIR-SHUT	TRIM	OPTICS	CCT	CRI
LED2-3-R	500L-DIMTR-120	AT	LED2-1401 LED2-1405	ND	27K	85+
	500L-LUTH-120			(Narrow)	30K	90+
	500L-LUTH-277			MD	35K	
	500-DIM10-MVOLT			(Medium)	40K	
				WD	50K	
				(Wide)		

* Check next page for available trim options
Add selected trim part number at the end

¹Add the corresponding color letters to specifies the trim color trims are available in 27K, 30K, 35K, 40K and 50K

⁴ Include the aperture (**4" OR 3"**) of the trim in the empty space to specify the trim size. For example **LED2-1401-600L**

BAFFLE TRIM OPTIONS

All trims available in Narrow Distribution(ND) and Medium Distribution (MD)

LED2-1401-600L-ND-30K-1 (Narrow Distribution trims)

LED2-1405-600L-MD-30K-1 (Medium Distribution trims) **LENSED**



W-WH (White-White)



P-WH (Black-White)



SN-SN (Satin Nickel)



CP-CP (Cooper-Cooper)



BZ-BZ (Bronze-Bronze)



P-BK (Black-Black)

REFLECTOR TRIM OPTIONS

All trims available in Narrow Distribution(ND) and Medium Distribution (MD)

LED2-1402-600L-ND-30K-1 (Narrow Distribution trims)

LED2-1428-600L-MD-30K-1 (Medium Distribution trims) **LENSED**



CL-WH (Clear-White)



BZ-BZ (Bronze-Bronze)



W-WH (White-White)



CP-CP (Cooper-Cooper)



SN-SN (Satin Nickel)



MB-WH (Black-White)



CL-CH (Clear-Chrome)



RG-WH (Gold-White)



MB-BK (Black-Black)

4" AVAILABLE TRIMS OPTIONS



LED2-1414-600L-ND-30K-WH

PINHOLE WITH NARROW LIGHT DISTRIBUTION



LED2-1403-600L-30K-WH

ONE PIECE SLOT APERTURE



LED2-1437-600L-MD-30K-1

SMOOTH FROST SHOWER LITE WITH MEDIUM LIGHT DISTRIBUTION



LED2-1462-600L-MD-30K-1

SEMI-FROSTED SHOWER TRIM WITH MEDIUM LIGHT DISTRIBUTION

Color Availables: BZ, WH, CP, CH, BK, SN

Color Availables: CL-BZ, CL-WH, CL-CP, CL-CH, CL-BK, CL-SN



LED2-1416-600L-MD-30K-1

BAFFLE WALL WASH WITH MEDIUM LIGHT DISTRIBUTION

Color Availables: W-WH, P-W-WH, SN-SN-WH, CP-CP-WH, BZ-BZ-WH, P-BK-WH



LED2-1407-600L-MD-30K-1

REFLECTOR WALL WASH WITH MEDIUM LIGHT DISTRIBUTION

Color Availables: CP-W-WH, MB-BK-WH, RG-W-WH, CP-CP-WH, CL-SN-WH, BZ-BZ-WH, W-W-WH, CL-CH-WH, SN-SN-WH



LED2-1406-600L-MD-30K-1

SURFACE ADJUSTABLE (90° TILT, 359° ROTATION)

LED2-1406 AVAILABLE COLORS:



LED2-1496-600L-MD-30K-1

SQUARE BAFFLE W/ SQUARE TRIM RING

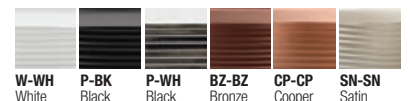



HH4-LED - 4 INCH ARCHITECTURAL HIGH LUMEN LED DOWNLIGHT

UP TO
2000
LUMENS

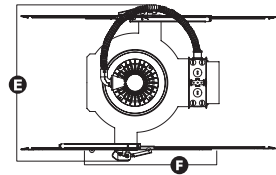
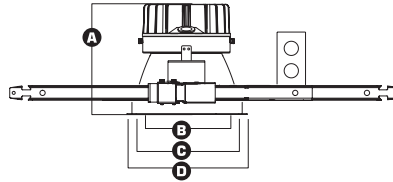
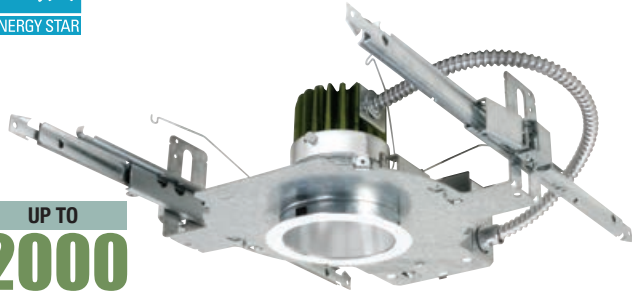

- A** Height = 5-3/4"
- B** Trim Aperture = 4"
- C** Cut-out = 4-1/2"
- D** Trim Outside Dia. = 5-1/2"
- E** Width = 16"
- F** Length = 12"12"

DESCRIPTION - 4" LED dedicated Architectural New Construction Downlight with integral LED heat management casting and driver (installed on junction box). Available in 900 lumens, 1200 lumens, 1500 lumens & 2000 lumens. ELITE's eco-friendly MAXILUME LED system is Energy Star and California Title 24 compliant and features 70% lumen maintenance at 50,000hrs of life. Our lighting adds comfort to any environment while using 50% less energy than the common CFL downlight.

Example: **HH4-LED-900L-DIM10-120-MD-30K-90**

TYPE	LUMENS/DRIVER				VOLTAGE	OPTICS	CCT	CRI
	900L SERIES	1200L SERIES	1500L SERIES	2000L SERIES				
HH4-LED	<input type="checkbox"/> 900L-DIM10	<input type="checkbox"/> 1200L-DIM10	<input type="checkbox"/> 1500L-DIM10	<input type="checkbox"/> 2000L-DIM10	<input type="checkbox"/> 120 <input type="checkbox"/> 277	<input type="checkbox"/> WD (60°-70°) <input type="checkbox"/> MD (50°-55°) <input type="checkbox"/> ND (30°-40°)	<input type="checkbox"/> 27K <input type="checkbox"/> 30K <input type="checkbox"/> 35K <input type="checkbox"/> 40K <input type="checkbox"/> 50K ² (85+CRI only)	<input type="checkbox"/> 85+ <input type="checkbox"/> 90+



HH4ADJ-LED - 4 INCH ARCHITECTURAL HIGH LUMEN ADJUSTABLE LED WALL WASH DOWNLIGHT

UP TO
2000
LUMENS

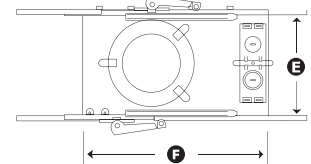
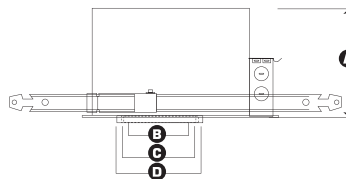

- A** Height = 7-1/4"
- B** Trim Aperture = 4"
- C** Cut-out = 4-3/8"
- D** Trim Outside Dia. = 4-7/8"
- E** Width = 7-5/8"
- F** Length = 12-1/4"

DESCRIPTION - 4" LED dedicated Architectural New Construction Adjustable Wall Wash Downlight with integral LED heat management casting and driver (installed on junction box). Available in 900 lumens, 1200 lumens, 1500 lumens & 2000 lumens. ELITE's eco-friendly MAXILUME LED system is Energy Star and California Title 24 compliant and features 70% lumen maintenance at 50,000hrs of life. Our lighting adds comfort to any environment while using 50% less energy than the common CFL downlight.

Example: **HH4ADJ-LED-900L-DIM10-120-MD-30K-90**

TYPE	LUMENS/DRIVER				VOLTAGE	OPTICS	CCT	CRI
	900L SERIES	1200L SERIES	1500L SERIES	2000L SERIES				
HH4ADJ-LED	<input type="checkbox"/> 900L-DIM10	<input type="checkbox"/> 1200L-DIM10	<input type="checkbox"/> 1500L-DIM10	<input type="checkbox"/> 2000L-DIM10	<input type="checkbox"/> 120 <input type="checkbox"/> 277	<input type="checkbox"/> WD (60°-70°) <input type="checkbox"/> MD (50°-55°) <input type="checkbox"/> ND (30°-40°)	<input type="checkbox"/> 27K <input type="checkbox"/> 30K <input type="checkbox"/> 35K <input type="checkbox"/> 40K <input type="checkbox"/> 50K ² (85+CRI only)	<input type="checkbox"/> 85+ <input type="checkbox"/> 90+





HHJ4-LED - 4 INCH ARCHITECTURAL HIGH LUMEN LED RETROFIT DOWNLIGHT

UP TO
2000
LUMENS



- A** Height = 5-3/4"
- B** Trim Aperture = 4"
- C** Cut-out = 4-1/2"
- D** Trim Outside Dia. = 5-1/2"

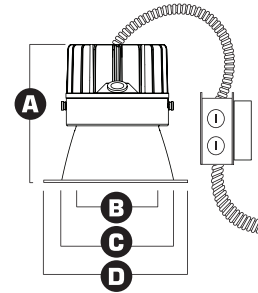

DESCRIPTION - 4" LED dedicated Architectural Retrofit Downlight with integral LED heat management casting and driver (installed on junction box). Available in 900 lumens, 1200 lumens, 1500 lumens & 2000 lumens. ELITE's eco-friendly MAXILUME LED system is Energy Star and California Title 24 compliant and features 70% lumen maintenance at 50,000hrs of life. Our lighting adds comfort to any environment while using 50% less energy than the common CFL downlight.

Example: **HHJ4-LED-900L-DIM10-120-MD-30K-90**

TYPE	LUMENS/DRIVER				VOLTAGE	OPTICS	CCT	CRI
	900L SERIES	1200L SERIES	1500L SERIES	2000L SERIES				
HHJ4-LED	<input type="checkbox"/> 900L-DIM10	<input type="checkbox"/> 1200L-DIM10	<input type="checkbox"/> 1500L-DIM10	<input type="checkbox"/> 2000L-DIM10	<input type="checkbox"/> 120 <input type="checkbox"/> 277	<input type="checkbox"/> WD (60°-70°) <input type="checkbox"/> MD (50°-55°) <input type="checkbox"/> ND (30°-40°)	<input type="checkbox"/> 27K <input type="checkbox"/> 30K <input type="checkbox"/> 35K <input type="checkbox"/> 40K <input type="checkbox"/> 50K ² (85+CRI only)	<input type="checkbox"/> 85+ <input type="checkbox"/> 90+



HHR4-LED - 4 INCH ARCHITECTURAL HIGH LUMEN LED REMODEL DOWNLIGHT

UP TO
2000
LUMENS

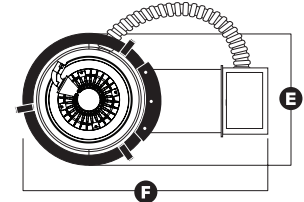
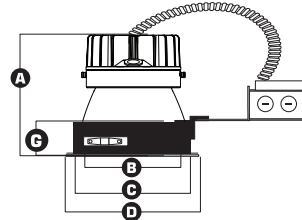

- A** Height = 5-3/4"
- B** Trim Aperture = 6"
- C** Cut-out = 6-3/4"
- D** Trim Outside Dia. = 7-3/8"
- E** Width = 7-1/2"
- F** Length = 12-3/4"
- G** Flange = 1-1/2"

DESCRIPTION - 4" LED dedicated Architectural Remodel Downlight with integral LED heat management casting and driver (installed on junction box). Available in 900 lumens, 1200 lumens, 1500 lumens & 2000 lumens. ELITE's eco-friendly MAXILUME LED system is Energy Star and California Title 24 compliant and features 70% lumen maintenance at 50,000hrs of life. Our lighting adds comfort to any environment while using 50% less energy than the common CFL downlight.

Example: **HHR4-LED-900L-DIM10-120-MD-30K-90**

TYPE	LUMENS/DRIVER				VOLTAGE	OPTICS	CCT	CRI
	900L SERIES	1200L SERIES	1500L SERIES	2000L SERIES				
HHR4-LED	<input type="checkbox"/> 900L-DIM10	<input type="checkbox"/> 1200L-DIM10	<input type="checkbox"/> 1500L-DIM10	<input type="checkbox"/> 2000L-DIM10	<input type="checkbox"/> 120 <input type="checkbox"/> 277	<input type="checkbox"/> WD (60°-70°) <input type="checkbox"/> MD (50°-55°) <input type="checkbox"/> ND (30°-40°)	<input type="checkbox"/> 27K <input type="checkbox"/> 30K <input type="checkbox"/> 35K <input type="checkbox"/> 40K <input type="checkbox"/> 50K ² (85+CRI only)	<input type="checkbox"/> 85+ <input type="checkbox"/> 90+





HH6-LED - 6 INCH ARCHITECTURAL HIGH LUMEN LED DOWNLIGHT

UP TO
4000
LUMENS

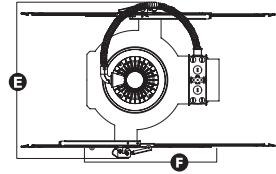
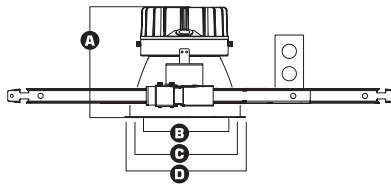

- A** Height = 5-3/4"
- B** Trim Aperture = 6"
- C** Cut-out = 6-3/4"
- D** Trim Outside Dia. = 7-3/8"
- E** Width = 16"
- F** Length = 20"-33"

DESCRIPTION - 6" LED dedicated Architectural New Construction Downlight with integral LED heat management casting and driver (installed on junction box). Available in 900 lumens, 1200 lumens, 1500 lumens, 2000 lumens, 3000 lumens & 4000 lumens. ELITE's eco-friendly MAXILUME LED system is Energy Star and California Title 24 compliant and features 70% lumen maintenance at 50,000hrs of life. Our lighting adds comfort to any environment while using 50% less energy than the common CFL downlight.

Example: **HH6-LED-900L-DIM10-120-MD-30K-90**

TYPE	LUMENS/DRIVER				VOLTAGE	OPTICS	CCT	CRI
	900L SERIES	1200L SERIES	1500L SERIES	2000L SERIES				
HH6-LED	<input type="checkbox"/> 900L-DIM10	<input type="checkbox"/> 1200L-DIM10	<input type="checkbox"/> 1500L-DIM10	<input type="checkbox"/> 2000L-DIM10	<input type="checkbox"/> 120 <input type="checkbox"/> 277	<input type="checkbox"/> WD (60°-70°) <input type="checkbox"/> MD (50°-55°) <input type="checkbox"/> ND (30°-40°)	<input type="checkbox"/> 27K <input type="checkbox"/> 30K <input type="checkbox"/> 35K <input type="checkbox"/> 40K <input type="checkbox"/> 50K ² (85+CRI only)	<input type="checkbox"/> 85+ <input type="checkbox"/> 90+
	<input type="checkbox"/> 300L SERIES	<input type="checkbox"/> 4000L SERIES						
	<input type="checkbox"/> 3000L-DIM10	<input type="checkbox"/> 4000L-DIM10						



HHJ6-LED - 6 INCH ARCHITECTURAL HIGH LUMEN LED RETROFIT DOWNLIGHT

UP TO
4000
LUMENS

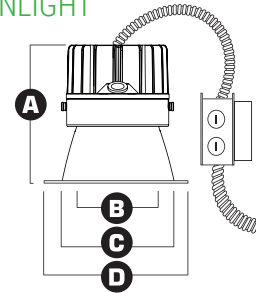

- A** Height = 5-3/4"
- B** Trim Aperture = 6"
- C** Cut-out = 6-3/4"
- D** Trim Outside Dia. = 7-3/8"

Example: **HHJ6-LED-900L-DIM10-120-MD-30K-90**

TYPE	LUMENS/DRIVER				VOLTAGE	OPTICS	CCT	CRI
	900L SERIES	1200L SERIES	1500L SERIES	2000L SERIES				
HHJ6-LED	<input type="checkbox"/> 900L-DIM10	<input type="checkbox"/> 1200L-DIM10	<input type="checkbox"/> 1500L-DIM10	<input type="checkbox"/> 2000L-DIM10	<input type="checkbox"/> 120 <input type="checkbox"/> 277	<input type="checkbox"/> WD (60°-70°) <input type="checkbox"/> MD (50°-55°) <input type="checkbox"/> ND (30°-40°)	<input type="checkbox"/> 27K <input type="checkbox"/> 30K <input type="checkbox"/> 35K <input type="checkbox"/> 40K <input type="checkbox"/> 50K ² (85+CRI only)	<input type="checkbox"/> 85+ <input type="checkbox"/> 90+
	<input type="checkbox"/> 300L SERIES	<input type="checkbox"/> 4000L SERIES						
	<input type="checkbox"/> 3000L-DIM10	<input type="checkbox"/> 4000L-DIM10						



HHR6-LED - 6 INCH ARCHITECTURAL HIGH LUMEN LED REMODEL DOWNLIGHT

UP TO
4000
LUMENS

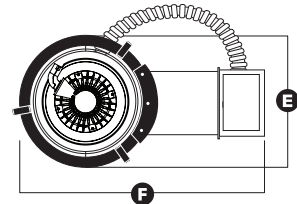
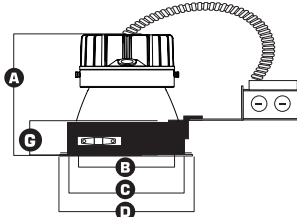

- A** Height = 5-3/4"
- B** Trim Aperture = 6"
- C** Cut-out = 6-3/4"
- D** Trim Outside Dia. = 7-3/8"
- E** Width = 7-1/2"
- F** Length = 12-3/4"
- G** Flange = 1-1/2"

Example: **HHR6-LED-900L-DIM10-120-MD-30K-90**

TYPE	LUMENS/DRIVER				VOLTAGE	OPTICS	CCT	CRI
	900L SERIES	1200L SERIES	1500L SERIES	2000L SERIES				
HHR6-LED	<input type="checkbox"/> 900L-DIM10	<input type="checkbox"/> 1200L-DIM10	<input type="checkbox"/> 1500L-DIM10	<input type="checkbox"/> 2000L-DIM10	<input type="checkbox"/> 120 <input type="checkbox"/> 277	<input type="checkbox"/> WD (60°-70°) <input type="checkbox"/> MD (50°-55°) <input type="checkbox"/> ND (30°-40°)	<input type="checkbox"/> 27K <input type="checkbox"/> 30K <input type="checkbox"/> 35K <input type="checkbox"/> 40K <input type="checkbox"/> 50K ² (85+CRI only)	<input type="checkbox"/> 85+ <input type="checkbox"/> 90+
	<input type="checkbox"/> 300L SERIES	<input type="checkbox"/> 4000L SERIES						
	<input type="checkbox"/> 3000L-DIM10	<input type="checkbox"/> 4000L-DIM10						



6" LED ARCHITECTURAL DOWNLIGHT

6"



HH6ADJ-LED - 6 INCH ARCHITECTURAL HIGH LUMEN ADJUSTABLE LED WALL WASH DOWNLIGHT

UP TO
4000
LUMENS

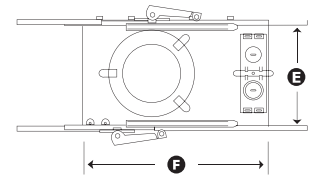
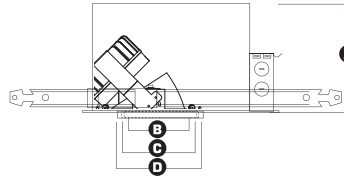

- A** Height = 7-3/4"
- B** Trim Aperture = 6"
- C** Cut-out = 6-1/2"
- D** Trim Outside Dia. = 7-7/8"
- E** Width = 10"
- F** Length = 12-1/2"

Example: **HH6ADJ-LED-900L-DIM10-120-MD-30K-90**

TYPE	LUMENS/DRIVER				VOLTAGE	OPTICS	CCT	CRI
	900L SERIES	1200L SERIES	1500L SERIES	2000L SERIES				
HH6ADJ-LED	<input type="checkbox"/> 900L-DIM10	<input type="checkbox"/> 1200L-DIM10	<input type="checkbox"/> 1500L-DIM10	<input type="checkbox"/> 2000L-DIM10	<input type="checkbox"/> 120 <input type="checkbox"/> 277	<input type="checkbox"/> WD (60°-70°) <input type="checkbox"/> MD (50°-55°) <input type="checkbox"/> ND (30°-40°)	<input type="checkbox"/> 27K <input type="checkbox"/> 30K <input type="checkbox"/> 35K <input type="checkbox"/> 40K <input type="checkbox"/> 50K ² (85+CRI only)	<input type="checkbox"/> 85+ <input type="checkbox"/> 90+
	300L SERIES		4000L SERIES					
	<input type="checkbox"/> 3000L-DIM10	<input type="checkbox"/> 4000L-DIM10						



HH6IC-LED - 6 INCH ARCHITECTURAL HIGH LUMEN LED IC DOWNLIGHT

UP TO
2000
LUMENS **IC RATED**

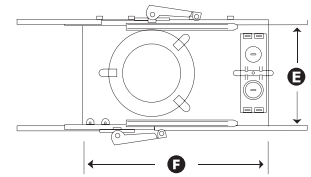
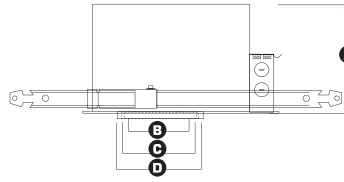

- A** Height = 7-3/4"
- B** Trim Aperture = 6"
- C** Cut-out = 6-1/2"
- D** Trim Outside Dia. = 7-7/8"
- E** Width = 10"
- F** Length = 12-1/2"

Example: **HH6IC-LED-900L-DIM10-120-MD-30K-90**

TYPE	LUMENS/DRIVER				VOLTAGE	OPTICS	CCT	CRI
	900L SERIES	1200L SERIES	1500L SERIES	2000L SERIES				
HH6IC-LED	<input type="checkbox"/> 900L-DIM10	<input type="checkbox"/> 1200L-DIM10	<input type="checkbox"/> 1500L-DIM10	<input type="checkbox"/> 2000L-DIM10	<input type="checkbox"/> 120 <input type="checkbox"/> 277	<input type="checkbox"/> WD (60°-70°) <input type="checkbox"/> MD (50°-55°) <input type="checkbox"/> ND (30°-40°)	<input type="checkbox"/> 27K <input type="checkbox"/> 30K <input type="checkbox"/> 35K <input type="checkbox"/> 40K <input type="checkbox"/> 50K ² (85+CRI only)	<input type="checkbox"/> 85+ <input type="checkbox"/> 90+
	300L SERIES		4000L SERIES					
	<input type="checkbox"/> 3000L-DIM10	<input type="checkbox"/> 4000L-DIM10						



6" SQUARE LED RECESSED ARCHITECTURAL DOWNLIGHT



HH6SQ-LED - 6 INCH ARCHITECTURAL LED SQUARE DOWNLIGHT

UP TO
3000
LUMENS

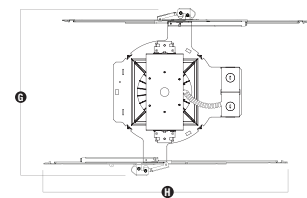
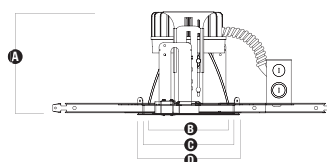
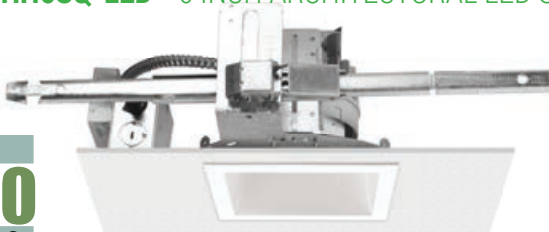

- A** Height = 7-3/8"
- B** Trim Aperture = 6"
- C** Cut-out = 6-1/2"
- D** Trim Outside Dia. = 7-1/8"
- E** Width = 16"
- F** Length (Bar Hanger) =Max: 32" Min: 21"

Example: **HH6SQ-LED-900L-DIM10-120-MD-30K-90**

TYPE	LUMENS/DRIVER				VOLTAGE	OPTICS	CCT	CRI
	900L SERIES	1200L SERIES	1500L SERIES	2000L SERIES				
HH6SQ-LED	<input type="checkbox"/> 900L-DIM10	<input type="checkbox"/> 1200L-DIM10	<input type="checkbox"/> 1500L-DIM10	<input type="checkbox"/> 2000L-DIM10	<input type="checkbox"/> 120 <input type="checkbox"/> 277	<input type="checkbox"/> WD (60°-70°) <input type="checkbox"/> MD (50°-55°) <input type="checkbox"/> ND (30°-40°)	<input type="checkbox"/> 27K <input type="checkbox"/> 30K <input type="checkbox"/> 35K <input type="checkbox"/> 40K <input type="checkbox"/> 50K ² (85+CRI only)	<input type="checkbox"/> 85+ <input type="checkbox"/> 90+
	300L SERIES		4000L SERIES					
	<input type="checkbox"/> 3000L-DIM10							



8"

8" LED ARCHITECTURAL DOWNLIGHT



HH8-LED - 8 INCH ARCHITECTURAL HIGH LUMEN LED DOWNLIGHT

UP TO
6000
LUMENS

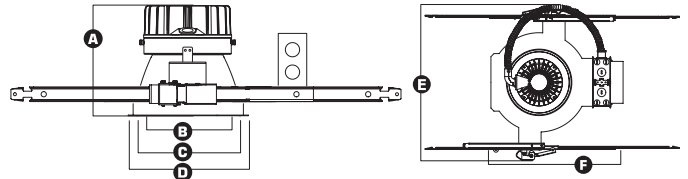

- A** Height (6000L/8000L) = 9-5/8"
- A** Height (Up to 4000L) = 7-1/8"
- B** Trim Aperture = 7-3/4"
- C** Cut-out = 8-1/2"
- D** Trim Outside Dia. = 9-1/8"
- E** Width = 16"
- F** Length = 20"-33"

DESCRIPTION - 8" LED dedicated Architectural New Construction Downlight with integral LED heat management casting and driver (installed on junction box). Available in 900, 1200, 2000, 3000, 4000, 6000 & 8000 lumens. ELITE's eco-friendly MAXILUME LED system is Energy Star and California Title 24 compliant and features 70% lumen maintenance at 50,000hrs of life. Our lighting adds comfort to any environment while using 50% less energy than the common CFL downlight.

Example: **HH8-LED-900L-DIM10-120-MD-30K-90**

TYPE	LUMENS/DRIVER				VOLTAGE	OPTICS	CCT	CRI
	900L SERIES	1200L SERIES	1500L SERIES	2000L SERIES				
HH8-LED	<input type="checkbox"/> 900L-DIM10	<input type="checkbox"/> 1200L-DIM10	<input type="checkbox"/> 1500L-DIM10	<input type="checkbox"/> 2000L-DIM10	<input type="checkbox"/> 120 <input type="checkbox"/> 277	<input type="checkbox"/> WD (60°-70°) <input type="checkbox"/> MD (50°-55°) <input type="checkbox"/> ND (30°-40°)	<input type="checkbox"/> 27K <input type="checkbox"/> 30K <input type="checkbox"/> 35K <input type="checkbox"/> 40K <input type="checkbox"/> 50K ² (85+CRI only)	<input type="checkbox"/> 85+ <input type="checkbox"/> 90+
	300L SERIES	4000L SERIES	6000L SERIES					
	<input type="checkbox"/> 3000L-DIM10	<input type="checkbox"/> 4000L-DIM10	<input type="checkbox"/> 6000L-DIM10					



HHJ8-LED - 8 INCH ARCHITECTURAL HIGH LUMEN LED RETROFIT DOWNLIGHT

UP TO
6000
LUMENS

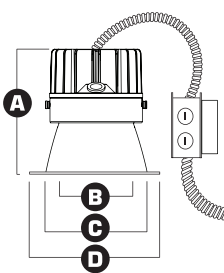

- A** Height (6000L/8000L) = 9-5/8"
- A** Height (Up to 4000L) = 7-1/8"
- B** Trim Aperture = 7-3/4"
- C** Cut-out = 8-1/2"
- D** Trim Outside Dia. = 9-1/8"

Example: **HHJ8-LED-900L-DIM10-120-MD-30K-90**

TYPE	LUMENS/DRIVER				VOLTAGE	OPTICS	CCT	CRI
	900L SERIES	1200L SERIES	1500L SERIES	2000L SERIES				
HHJ8-LED	<input type="checkbox"/> 900L-DIM10	<input type="checkbox"/> 1200L-DIM10	<input type="checkbox"/> 1500L-DIM10	<input type="checkbox"/> 2000L-DIM10	<input type="checkbox"/> 120 <input type="checkbox"/> 277	<input type="checkbox"/> WD (60°-70°) <input type="checkbox"/> MD (50°-55°) <input type="checkbox"/> ND (30°-40°)	<input type="checkbox"/> 27K <input type="checkbox"/> 30K <input type="checkbox"/> 35K <input type="checkbox"/> 40K <input type="checkbox"/> 50K ² (85+CRI only)	<input type="checkbox"/> 85+ <input type="checkbox"/> 90+
	300L SERIES	4000L SERIES	6000L SERIES					
	<input type="checkbox"/> 3000L-DIM10	<input type="checkbox"/> 4000L-DIM10	<input type="checkbox"/> 6000L-DIM10					



HHR8-LED - 8 INCH ARCHITECTURAL HIGH LUMEN LED REMODEL DOWNLIGHT

UP TO
6000
LUMENS

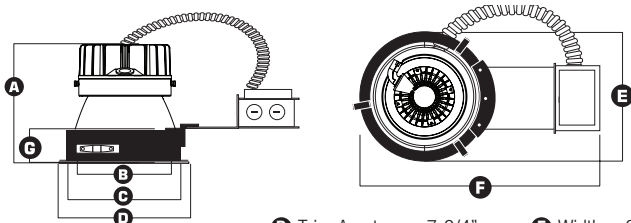

- A** Height (6000L/8000L) = 9-5/8"
- A** Height (Up to 4000L) = 7-1/8"
- B** Trim Aperture = 7-3/4"
- C** Cut-out = 8-1/2"
- D** Trim Outside Dia. = 9-1/8"
- E** Width = 8-3/4"
- F** Length = 14-1/4"
- G** Flange = 2-1/4"

Example: **HHR8-LED-900L-DIM10-120-MD-30K-90**

TYPE	LUMENS/DRIVER				VOLTAGE	OPTICS	CCT	CRI
	900L SERIES	1200L SERIES	1500L SERIES	2000L SERIES				
HHR8-LED	<input type="checkbox"/> 900L-DIM10	<input type="checkbox"/> 1200L-DIM10	<input type="checkbox"/> 1500L-DIM10	<input type="checkbox"/> 2000L-DIM10	<input type="checkbox"/> 120 <input type="checkbox"/> 277	<input type="checkbox"/> WD (60°-70°) <input type="checkbox"/> MD (50°-55°) <input type="checkbox"/> ND (30°-40°)	<input type="checkbox"/> 27K <input type="checkbox"/> 30K <input type="checkbox"/> 35K <input type="checkbox"/> 40K <input type="checkbox"/> 50K ² (85+CRI only)	<input type="checkbox"/> 85+ <input type="checkbox"/> 90+
	300L SERIES	4000L SERIES	6000L SERIES					
	<input type="checkbox"/> 3000L-DIM10	<input type="checkbox"/> 4000L-DIM10	<input type="checkbox"/> 6000L-DIM10					





HH5-LED - 5 INCH ARCHITECTURAL HIGH LUMEN LED DOWNLIGHT

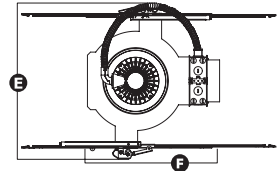
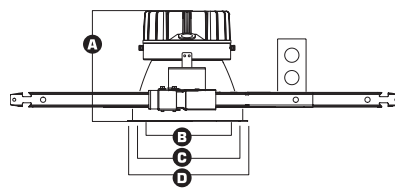

- A** Height = 5-3/4"
- B** Trim Aperture = 5"
- C** Cut-out = 5-3/4"
- D** Trim Outside Dia. = 6-3/8"
- E** Width = 10-1/8"
- F** Length = 18-1/8"

UP TO
2000
LUMENS

DESCRIPTION - 5" LED dedicated Architectural Retrofit Downlight with integral LED heat management casting and driver (installed on junction box). Available in 900 lumens, 1200 lumens, 1500 lumens & 2000 lumens. ELITE's eco-friendly MAXILUME LED system is Energy Star and California Title 24 compliant and features 70% lumen maintenance at 50,000hrs of life. Our lighting adds comfort to any environment while using 50% less energy than the common CFL downlight.

Example: **HH5-LED-900L-DIM10-120-MD-30K-90**

TYPE	LUMENS/DRIVER				VOLTAGE	OPTICS	CCT	CRI
	900L SERIES	1200L SERIES	1500L SERIES	2000L SERIES				
HH5-LED	<input type="checkbox"/> 900L-DIM10	<input type="checkbox"/> 1200L-DIM10	<input type="checkbox"/> 1500L-DIM10	<input type="checkbox"/> 2000L-DIM10	<input type="checkbox"/> 120 <input type="checkbox"/> 277	<input type="checkbox"/> WD (60°-70°) <input type="checkbox"/> MD (50°-55°) <input type="checkbox"/> ND (30°-40°)	<input type="checkbox"/> 27K <input type="checkbox"/> 30K <input type="checkbox"/> 35K <input type="checkbox"/> 40K <input type="checkbox"/> 50K ² (85+CRI only)	<input type="checkbox"/> 85+ <input type="checkbox"/> 90+



HHJ5-LED - 5 INCH ARCHITECTURAL HIGH LUMEN LED RETROFIT DOWNLIGHT

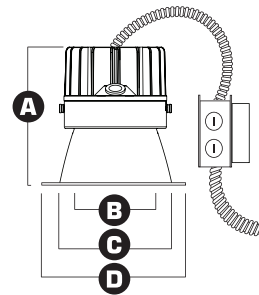

- A** Height = 5-3/4"
- B** Trim Aperture = 5"
- C** Cut-out = 5-1/2"
- D** Trim Outside Dia. = 6-3/8"

UP TO
2000
LUMENS

DESCRIPTION - 5" LED dedicated Architectural Retrofit Downlight with integral LED heat management casting and driver (installed on junction box). Available in 900 lumens, 1200 lumens, 1500 lumens & 2000 lumens. ELITE's eco-friendly MAXILUME LED system is Energy Star and California Title 24 compliant and features 70% lumen maintenance at 50,000hrs of life. Our lighting adds comfort to any environment while using 50% less energy than the common CFL downlight.

Example: **HHJ5-LED-900L-DIM10-120-MD-30K-90**

TYPE	LUMENS/DRIVER				VOLTAGE	OPTICS	CCT	CRI
	900L SERIES	1200L SERIES	1500L SERIES	2000L SERIES				
HHJ5-LED	<input type="checkbox"/> 900L-DIM10	<input type="checkbox"/> 1200L-DIM10	<input type="checkbox"/> 1500L-DIM10	<input type="checkbox"/> 2000L-DIM10	<input type="checkbox"/> 120 <input type="checkbox"/> 277	<input type="checkbox"/> WD (60°-70°) <input type="checkbox"/> MD (50°-55°) <input type="checkbox"/> ND (30°-40°)	<input type="checkbox"/> 27K <input type="checkbox"/> 30K <input type="checkbox"/> 35K <input type="checkbox"/> 40K <input type="checkbox"/> 50K ² (85+CRI only)	<input type="checkbox"/> 85+ <input type="checkbox"/> 90+



4", 5", 6" & 8" HH SERIES TRIM OPTIONS

For 4", 5", 6" & 8" optics, replace "_" in the optic's part number with 4, 5, 6 or 8.
 Example: HH8-8501 for the 8" trim option.

DESIGN OPTIONS



HH_ - _501
Reflector with Diffuse Lens



HH_ - _509
Deco Glass Reflector with Diffuse Lens



HH_ - _521
Standard Ring Glass Reflector with Diffuse Lens



HH_ - _528(WH)
Reflector with Aluminum Disk & Diffuse Lens-White



HH_ - _507
Wall Wash Reflector with Diffuse Lens



HH_ - _510
Double Ring Glass Reflector with Diffuse Lens



HH_ - _523
Prismo Deco Ring Glass with Diffuse Lens



HH_ - _528(AL)
Reflector w/ Aluminum Disk & Diffuse Lens Aluminum



HH_ - _541(CL)
Reflector w/ Frosted Cylindrical Glass



HH_ - _577
Double Wall Wash Reflector with Diffuse Lens



HH_ - _511
Triple Ring Glass Reflector with Diffuse Lens



HH_ - _522
Euro Deco Ring Glass with Diffuse Lens

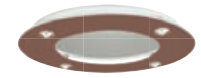

HH_ - _528(BZ)
Reflector with Aluminum Disk & Diffuse Lens Bronze



HH_ - _525
Central Etched Float Glass with Diffuse Lens

COLOR OPTIONS

REFLECTOR - RING FINISH



CL - WH
Specular Clear Reflector/ Self Flanged White Trim Ring



WT - WH
(Wheat Reflector/ Self Flanged White Trim Ring)



W - WH
(White Reflector/ Self Flanged White Trim Ring)



CL - SCH
(Specular Clear Reflector/ Self Flanged White Trim Ring)



SHZ - WH
(Satin Haze Reflector/ Self Flanged White Trim Ring)



SHZ - SHZ
(Satin Haze Refl./ Self Flanged Satin Haze Trim Ring)



MB - WH
(Black Reflector/ Self Flanged White Trim Ring)

TRIM LESS OPTIONS

COLOR OPTIONS



CL
Specular Clear Reflector



SHZ
Satin Haze Reflector

UNDERCABINET & SURFACE MOUNT LIGHTING



EU-LED SERIES - LED UNDERCABINET FIXTURE POLYCARBONATE W/ UV RADIATION PROTECTION

9" | **12"** | **18"** | **24"** | **34"** | **42"** | **46"**
300L | **450L** | **600L** | **900L** | **1300L** | **1600L** | **1800L**

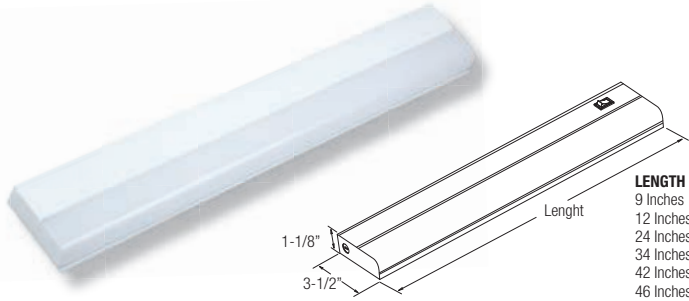

EXAMPLE: EU-LED-24-900L-30K

PART NUMBER	DIMMING	CCT
EU-LED-9-300L (9" - 300 lumens)	DIMTR-120	30K
EU-LED-12-450L (12" - 450 lumens)		35K
EU-LED-18-600L (18" - 600 lumens)		40K
EU-LED-24-900L (24" - 900 lumens)		50K
EU-LED-34-1300L (34" - 1300 lumens)		
EU-LED-42-1600L (42" - 1600 lumens)		
EU-LED-46-1800L (46" - 1800 lumens)		



OMSD1-LED - LED FLUSH MOUNT FIXTURE

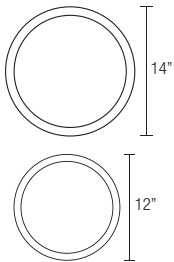

PART NUMBER	LUMES/ VOLTAGE	CCT
OMSD1-LED-12 (12")	1400L-120	27K
		30K
OMSD1-LED-14 (14")	1600L-120	35K
OMSD1-LED-18 (18")	1800L-120	40K
		50K

WATTAGE: 1400L / 1600L

CRI: 90+

FINISH: BN

GLASS TYPE: OPAL

HEIGHT: 3"



OMSD2-LED - LED FLUSH MOUNT FIXTURE

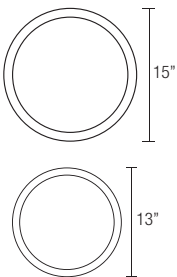

PART NUMBER	LUMES/ VOLTAGE	CCT
OMSD2-LED-13 (13")	1000L-120	27K
		30K
		35K
OMSD2-LED-15 (15")	1200L-120	40K
		50K

WATTAGE: 1000L / 1200L

CRI: 90+

FINISH: BN

GLASS TYPE: OPAL

HEIGHT: 4.75"



OWP-SL-102-LED - POLYCARBONATE SLIMLINE WALL PACK



PART NUMBER	LUMES/ VOLTAGE	CCT
OWP-SL-102-LED	700L-MVOLT	30K
		40K



ORACLE LIGHTING DLC RATED PRODUCTS



**HIGH PERFORMANCE AND ENERGY EFFICIENT
COMMERCIAL DOWNLIGHTING**



LED RECESSED LINEAR LIGHTING

24-ODVH-LED

2 X 4 Foot LED Recessed Volumetric Luminaire



4000
LUMENS

5000
LUMENS

6000
LUMENS

7000
LUMENS

8000
LUMENS

4000L

24-ODVH-LED-4000L-DIM10-MVOLT-30K
24-ODVH-LED-4000L-DIM10-MVOLT-35K
24-ODVH-LED-4000L-DIM10-MVOLT-40K
24-ODVH-LED-4000L-DIM10-MVOLT-50K

5000L

24-ODVH-LED-5000L-DIM10-MVOLT-30K
24-ODVH-LED-5000L-DIM10-MVOLT-35K
24-ODVH-LED-5000L-DIM10-MVOLT-40K
24-ODVH-LED-5000L-DIM10-MVOLT-50K

6000L

24-ODVH-LED-6000L-DIM10-MVOLT-30K
24-ODVH-LED-6000L-DIM10-MVOLT-35K
24-ODVH-LED-6000L-DIM10-MVOLT-40K
24-ODVH-LED-6000L-DIM10-MVOLT-50K

7000L

24-ODVH-LED-7000L-DIM10-MVOLT-30K
24-ODVH-LED-7000L-DIM10-MVOLT-35K
24-ODVH-LED-7000L-DIM10-MVOLT-40K
24-ODVH-LED-7000L-DIM10-MVOLT-50K

8000L

24-ODVH-LED-8000L-DIM10-MVOLT-30K
24-ODVH-LED-8000L-DIM10-MVOLT-35K
24-ODVH-LED-8000L-DIM10-MVOLT-40K
24-ODVH-LED-8000L-DIM10-MVOLT-50K

22-ODVH-LED

2 X 2 Foot LED Recessed Volumetric Luminaire



2400
LUMENS

3400
LUMENS

4000
LUMENS

5000
LUMENS

2400L

22-ODVH-LED-2400L-DIM10-MVOLT-30K
22-ODVH-LED-2400L-DIM10-MVOLT-35K
22-ODVH-LED-2400L-DIM10-MVOLT-40K
22-ODVH-LED-2400L-DIM10-MVOLT-50K

3400L

22-ODVH-LED-3400L-DIM10-MVOLT-30K
22-ODVH-LED-3400L-DIM10-MVOLT-35K
22-ODVH-LED-3400L-DIM10-MVOLT-40K
22-ODVH-LED-3400L-DIM10-MVOLT-50K

4000L

22-ODVH-LED-4000L-DIM10-MVOLT-30K
22-ODVH-LED-4000L-DIM10-MVOLT-35K
22-ODVH-LED-4000L-DIM10-MVOLT-40K
22-ODVH-LED-4000L-DIM10-MVOLT-50K

5000L

22-ODVH-LED-5000L-DIM10-MVOLT-30K
22-ODVH-LED-5000L-DIM10-MVOLT-35K
22-ODVH-LED-5000L-DIM10-MVOLT-40K
22-ODVH-LED-5000L-DIM10-MVOLT-50K

14-ODVH-LED

1X 4 Foot LED Recessed Volumetric Luminaire



2400
LUMENS

3400
LUMENS

4000
LUMENS

5000
LUMENS

2400L

14-ODVH-LED-2400L-DIM10-MVOLT-30K
14-ODVH-LED-2400L-DIM10-MVOLT-35K
14-ODVH-LED-2400L-DIM10-MVOLT-40K
14-ODVH-LED-2400L-DIM10-MVOLT-50K

3400L

14-ODVH-LED-3400L-DIM10-MVOLT-30K
14-ODVH-LED-3400L-DIM10-MVOLT-35K
14-ODVH-LED-3400L-DIM10-MVOLT-40K
14-ODVH-LED-3400L-DIM10-MVOLT-50K

4000L

14-ODVH-LED-4000L-DIM10-MVOLT-30K
14-ODVH-LED-4000L-DIM10-MVOLT-35K
14-ODVH-LED-4000L-DIM10-MVOLT-40K
14-ODVH-LED-4000L-DIM10-MVOLT-50K

5000L

14-ODVH-LED-5000L-DIM10-MVOLT-30K
14-ODVH-LED-5000L-DIM10-MVOLT-35K
14-ODVH-LED-5000L-DIM10-MVOLT-40K
14-ODVH-LED-5000L-DIM10-MVOLT-50K

LED RECESSED LINEAR LIGHTING

24-NV-LED

2 X 4 Foot LED Recessed Volumetric Luminaire



4000
LUMENS

5000
LUMENS

6000
LUMENS

7000
LUMENS

8000
LUMENS

4000L

24-NV-LED-4000L-DIM10-MVOLT-30K
24-NV-LED-4000L-DIM10-MVOLT-35K
24-NV-LED-4000L-DIM10-MVOLT-40K
24-NV-LED-4000L-DIM10-MVOLT-50K

5000L

24-NV-LED-5000L-DIM10-MVOLT-30K
24-NV-LED-5000L-DIM10-MVOLT-35K
24-NV-LED-5000L-DIM10-MVOLT-40K
24-NV-LED-5000L-DIM10-MVOLT-50K

6000L

24-NV-LED-6000L-DIM10-MVOLT-30K
24-NV-LED-6000L-DIM10-MVOLT-35K
24-NV-LED-6000L-DIM10-MVOLT-40K
24-NV-LED-6000L-DIM10-MVOLT-50K

7000L

24-NV-LED-7000L-DIM10-MVOLT-30K
24-NV-LED-7000L-DIM10-MVOLT-35K
24-NV-LED-7000L-DIM10-MVOLT-40K
24-NV-LED-7000L-DIM10-MVOLT-50K

8000L

24-NV-LED-8000L-DIM10-MVOLT-30K
24-NV-LED-8000L-DIM10-MVOLT-35K
24-NV-LED-8000L-DIM10-MVOLT-40K
24-NV-LED-8000L-DIM10-MVOLT-50K

22-NV-LED

2 X 2 Foot LED Recessed Volumetric Luminaire



2400
LUMENS

3400
LUMENS

4000
LUMENS

5000
LUMENS

2400L

22-NV-LED-2400L-DIM10-MVOLT-30K
22-NV-LED-2400L-DIM10-MVOLT-35K
22-NV-LED-2400L-DIM10-MVOLT-40K
22-NV-LED-2400L-DIM10-MVOLT-50K

3400L

22-NV-LED-3400L-DIM10-MVOLT-30K
22-NV-LED-3400L-DIM10-MVOLT-35K
22-NV-LED-3400L-DIM10-MVOLT-40K
22-NV-LED-3400L-DIM10-MVOLT-50K

4000L

22-NV-LED-4000L-DIM10-MVOLT-30K
22-NV-LED-4000L-DIM10-MVOLT-35K
22-NV-LED-4000L-DIM10-MVOLT-40K
22-NV-LED-4000L-DIM10-MVOLT-50K

5000L

22-NV-LED-5000L-DIM10-MVOLT-30K
22-NV-LED-5000L-DIM10-MVOLT-35K
22-NV-LED-5000L-DIM10-MVOLT-40K
22-NV-LED-5000L-DIM10-MVOLT-50K

LED RECESSED LINEAR LIGHTING

24-OVHP-LED

2 X 4 LED Shallow Recessed Volumetric Luminaire



4000
LUMENS

5000
LUMENS

6000
LUMENS

7000
LUMENS

8000
LUMENS

4000L	24-OVHP-LED-4000L-DIM10-MVOLT-30K	8000L	24-OVHP-LED-8000L-DIM10-MVOLT-30K
	24-OVHP-LED-4000L-DIM10-MVOLT-35K		24-OVHP-LED-8000L-DIM10-MVOLT-35K
	24-OVHP-LED-4000L-DIM10-MVOLT-40K		24-OVHP-LED-8000L-DIM10-MVOLT-40K
	24-OVHP-LED-4000L-DIM10-MVOLT-50K		24-OVHP-LED-8000L-DIM10-MVOLT-50K
5000L	24-OVHP-LED-5000L-DIM10-MVOLT-30K		
	24-OVHP-LED-5000L-DIM10-MVOLT-35K		
	24-OVHP-LED-5000L-DIM10-MVOLT-40K		
	24-OVHP-LED-5000L-DIM10-MVOLT-50K		
6000L	24-OVHP-LED-6000L-DIM10-MVOLT-30K		
	24-OVHP-LED-6000L-DIM10-MVOLT-35K		
	24-OVHP-LED-6000L-DIM10-MVOLT-40K		
	24-OVHP-LED-6000L-DIM10-MVOLT-50K		
7000L	24-OVHP-LED-7000L-DIM10-MVOLT-30K		
	24-OVHP-LED-7000L-DIM10-MVOLT-35K		
	24-OVHP-LED-7000L-DIM10-MVOLT-40K		
	24-OVHP-LED-7000L-DIM10-MVOLT-50K		

22-OVHP-LED

2 X 2 LED Shallow Recessed Volumetric Luminaire



2400
LUMENS

3400
LUMENS

4000
LUMENS

5000
LUMENS

2400L	22-OVHP-LED-2400L-DIM10-MVOLT-30K		
	22-OVHP-LED-2400L-DIM10-MVOLT-35K		
	22-OVHP-LED-2400L-DIM10-MVOLT-40K		
	22-OVHP-LED-2400L-DIM10-MVOLT-50K		
3400L	22-OVHP-LED-3400L-DIM10-MVOLT-30K		
	22-OVHP-LED-3400L-DIM10-MVOLT-35K		
	22-OVHP-LED-3400L-DIM10-MVOLT-40K		
	22-OVHP-LED-3400L-DIM10-MVOLT-50K		
4000L	22-OVHP-LED-4000L-DIM10-MVOLT-30K		
	22-OVHP-LED-4000L-DIM10-MVOLT-35K		
	22-OVHP-LED-4000L-DIM10-MVOLT-40K		
	22-OVHP-LED-4000L-DIM10-MVOLT-50K		
5000L	22-OVHP-LED-5000L-DIM10-MVOLT-30K		
	22-OVHP-LED-5000L-DIM10-MVOLT-35K		
	22-OVHP-LED-5000L-DIM10-MVOLT-40K		
	22-OVHP-LED-5000L-DIM10-MVOLT-50K		

14-OVHP-LED

1 X 4 LED Shallow Recessed Volumetric Luminaire



2400
LUMENS

3400
LUMENS

4000
LUMENS

5000
LUMENS

2400L	14-OVHP-LED-2400L-DIM10-MVOLT-30K		
	14-OVHP-LED-2400L-DIM10-MVOLT-35K		
	14-OVHP-LED-2400L-DIM10-MVOLT-40K		
	14-OVHP-LED-2400L-DIM10-MVOLT-50K		
3400L	14-OVHP-LED-3400L-DIM10-MVOLT-30K		
	14-OVHP-LED-3400L-DIM10-MVOLT-35K		
	14-OVHP-LED-3400L-DIM10-MVOLT-40K		
	14-OVHP-LED-3400L-DIM10-MVOLT-50K		
4000L	14-OVHP-LED-4000L-DIM10-MVOLT-30K		
	14-OVHP-LED-4000L-DIM10-MVOLT-35K		
	14-OVHP-LED-4000L-DIM10-MVOLT-40K		
	14-OVHP-LED-4000L-DIM10-MVOLT-50K		
5000L	14-OVHP-LED-5000L-DIM10-MVOLT-30K		
	14-OVHP-LED-5000L-DIM10-MVOLT-35K		
	14-OVHP-LED-5000L-DIM10-MVOLT-40K		
	14-OVHP-LED-5000L-DIM10-MVOLT-50K		

LED RECESSED LINEAR LIGHTING

24-OD1V-LED (Center Mount Flat "HT" Lens)

2 X 4 Foot LED Recessed Volumetric



4000 LUMENS	5000 LUMENS	6000 LUMENS
7000 LUMENS	8000 LUMENS	

4000L	24-OD1V-LED-4000L-DIM10-MVOLT-30K	8000L	24-OD1V-LED-8000L-DIM10-MVOLT-30K
	24-OD1V-LED-4000L-DIM10-MVOLT-35K		24-OD1V-LED-8000L-DIM10-MVOLT-35K
	24-OD1V-LED-4000L-DIM10-MVOLT-40K		24-OD1V-LED-8000L-DIM10-MVOLT-40K
	24-OD1V-LED-4000L-DIM10-MVOLT-50K		24-OD1V-LED-8000L-DIM10-MVOLT-50K
5000L	24-OD1V-LED-5000L-DIM10-MVOLT-30K		
	24-OD1V-LED-5000L-DIM10-MVOLT-35K		
	24-OD1V-LED-5000L-DIM10-MVOLT-40K		
	24-OD1V-LED-5000L-DIM10-MVOLT-50K		
6000L	24-OD1V-LED-6000L-DIM10-MVOLT-30K		
	24-OD1V-LED-6000L-DIM10-MVOLT-35K		
	24-OD1V-LED-6000L-DIM10-MVOLT-40K		
	24-OD1V-LED-6000L-DIM10-MVOLT-50K		
7000L	24-OD1V-LED-7000L-DIM10-MVOLT-30K		
	24-OD1V-LED-7000L-DIM10-MVOLT-35K		
	24-OD1V-LED-7000L-DIM10-MVOLT-40K		
	24-OD1V-LED-7000L-DIM10-MVOLT-50K		

22-OD1V-LED (Center Mount Flat "HT" Lens)

2 X 2 Foot LED Recessed Volumetric



2400 LUMENS	3400 LUMENS
4000 LUMENS	5000 LUMENS

2400L	22-OD1V-LED-2400L-DIM10-MVOLT-30K
	22-OD1V-LED-2400L-DIM10-MVOLT-35K
	22-OD1V-LED-2400L-DIM10-MVOLT-40K
	22-OD1V-LED-2400L-DIM10-MVOLT-50K
3400L	22-OD1V-LED-3400L-DIM10-MVOLT-30K
	22-OD1V-LED-3400L-DIM10-MVOLT-35K
	22-OD1V-LED-3400L-DIM10-MVOLT-40K
	22-OD1V-LED-3400L-DIM10-MVOLT-50K
4000L	22-OD1V-LED-4000L-DIM10-MVOLT-30K
	22-OD1V-LED-4000L-DIM10-MVOLT-35K
	22-OD1V-LED-4000L-DIM10-MVOLT-40K
	22-OD1V-LED-4000L-DIM10-MVOLT-50K
5000L	22-OD1V-LED-5000L-DIM10-MVOLT-30K
	22-OD1V-LED-5000L-DIM10-MVOLT-35K
	22-OD1V-LED-5000L-DIM10-MVOLT-40K
	22-OD1V-LED-5000L-DIM10-MVOLT-50K

LED RECESSED LINEAR LIGHTING

24-OT-LED

2 X 4 Foot LED Recessed Troffer Luminaire



4000
LUMENS

5000
LUMENS

6000
LUMENS

7000
LUMENS

8000
LUMENS

4000L

24-OT-LED-4000L-DIM10-MVOLT-30K
24-OT-LED-4000L-DIM10-MVOLT-35K
24-OT-LED-4000L-DIM10-MVOLT-40K
24-OT-LED-4000L-DIM10-MVOLT-50K

5000L

24-OT-LED-5000L-DIM10-MVOLT-30K
24-OT-LED-5000L-DIM10-MVOLT-35K
24-OT-LED-5000L-DIM10-MVOLT-40K
24-OT-LED-5000L-DIM10-MVOLT-50K

6000L

24-OT-LED-6000L-DIM10-MVOLT-30K
24-OT-LED-6000L-DIM10-MVOLT-35K
24-OT-LED-6000L-DIM10-MVOLT-40K
24-OT-LED-6000L-DIM10-MVOLT-50K

7000L

24-OT-LED-7000L-DIM10-MVOLT-30K
24-OT-LED-7000L-DIM10-MVOLT-35K
24-OT-LED-7000L-DIM10-MVOLT-40K
24-OT-LED-7000L-DIM10-MVOLT-50K

8000L

24-OT-LED-8000L-DIM10-MVOLT-30K
24-OT-LED-8000L-DIM10-MVOLT-35K
24-OT-LED-8000L-DIM10-MVOLT-40K
24-OT-LED-8000L-DIM10-MVOLT-50K

22-OT-LED

2 X 2 Foot LED Recessed Troffer Luminaire



2400
LUMENS

3400
LUMENS

4000
LUMENS

5000
LUMENS

2400L

22-OT-LED-2400L-DIM10-MVOLT-30K
22-OT-LED-2400L-DIM10-MVOLT-35K
22-OT-LED-2400L-DIM10-MVOLT-40K
22-OT-LED-2400L-DIM10-MVOLT-50K

3400L

22-OT-LED-3400L-DIM10-MVOLT-30K
22-OT-LED-3400L-DIM10-MVOLT-35K
22-OT-LED-3400L-DIM10-MVOLT-40K
22-OT-LED-3400L-DIM10-MVOLT-50K

4000L

22-OT-LED-4000L-DIM10-MVOLT-30K
22-OT-LED-4000L-DIM10-MVOLT-35K
22-OT-LED-4000L-DIM10-MVOLT-40K
22-OT-LED-4000L-DIM10-MVOLT-50K

5000L

22-OT-LED-5000L-DIM10-MVOLT-30K
22-OT-LED-5000L-DIM10-MVOLT-35K
22-OT-LED-5000L-DIM10-MVOLT-40K
22-OT-LED-5000L-DIM10-MVOLT-50K

14-OT-LED

1 X 4 Foot LED Recessed Troffer Luminaire



2400
LUMENS

3400
LUMENS

4000
LUMENS

5000
LUMENS

2400L

14-OT-LED-2400L-DIM10-MVOLT-30K
14-OT-LED-2400L-DIM10-MVOLT-35K
14-OT-LED-2400L-DIM10-MVOLT-40K
14-OT-LED-2400L-DIM10-MVOLT-50K

3400L

14-OT-LED-3400L-DIM10-MVOLT-30K
14-OT-LED-3400L-DIM10-MVOLT-35K
14-OT-LED-3400L-DIM10-MVOLT-40K
14-OT-LED-3400L-DIM10-MVOLT-50K

4000L

14-OT-LED-4000L-DIM10-MVOLT-30K
14-OT-LED-4000L-DIM10-MVOLT-35K
14-OT-LED-4000L-DIM10-MVOLT-40K
14-OT-LED-4000L-DIM10-MVOLT-50K

5000L

14-OT-LED-5000L-DIM10-MVOLT-30K
14-OT-LED-5000L-DIM10-MVOLT-35K
14-OT-LED-5000L-DIM10-MVOLT-40K
14-OT-LED-5000L-DIM10-MVOLT-50K

LED RECESSED LINEAR LIGHTING

24-OSMT-LED

2 X 2 LED Surface Mount Specification Grade Troffer



4000
LUMENS

5000
LUMENS

6000
LUMENS

7000
LUMENS

8000
LUMENS

4000L	24-OSMT-LED-4000L-DIM10-MVOLT-30K	8000L	24-OSMT-LED-8000L-DIM10-MVOLT-30K
	24-OSMT-LED-4000L-DIM10-MVOLT-35K		24-OSMT-LED-8000L-DIM10-MVOLT-35K
	24-OSMT-LED-4000L-DIM10-MVOLT-40K		24-OSMT-LED-8000L-DIM10-MVOLT-40K
	24-OSMT-LED-4000L-DIM10-MVOLT-50K		24-OSMT-LED-8000L-DIM10-MVOLT-50K
5000L	24-OSMT-LED-5000L-DIM10-MVOLT-30K	7000L	24-OSMT-LED-7000L-DIM10-MVOLT-30K
	24-OSMT-LED-5000L-DIM10-MVOLT-35K		24-OSMT-LED-7000L-DIM10-MVOLT-35K
	24-OSMT-LED-5000L-DIM10-MVOLT-40K		24-OSMT-LED-7000L-DIM10-MVOLT-40K
	24-OSMT-LED-5000L-DIM10-MVOLT-50K		24-OSMT-LED-7000L-DIM10-MVOLT-50K
6000L	24-OSMT-LED-6000L-DIM10-MVOLT-30K		
	24-OSMT-LED-6000L-DIM10-MVOLT-35K		
	24-OSMT-LED-6000L-DIM10-MVOLT-40K		
	24-OSMT-LED-6000L-DIM10-MVOLT-50K		

22-OSMT-LED

2 X 2 LED Surface Mount Specification Grade Troffer



2400
LUMENS

3400
LUMENS

4000
LUMENS

5000
LUMENS

2400L	22-OSMT-LED-2400L-DIM10-MVOLT-30K	5000L	22-OSMT-LED-5000L-DIM10-MVOLT-30K
	22-OSMT-LED-2400L-DIM10-MVOLT-35K		22-OSMT-LED-5000L-DIM10-MVOLT-35K
	22-OSMT-LED-2400L-DIM10-MVOLT-40K		22-OSMT-LED-5000L-DIM10-MVOLT-40K
	22-OSMT-LED-2400L-DIM10-MVOLT-50K		22-OSMT-LED-5000L-DIM10-MVOLT-50K
3400L	22-OSMT-LED-3400L-DIM10-MVOLT-30K		
	22-OSMT-LED-3400L-DIM10-MVOLT-35K		
	22-OSMT-LED-3400L-DIM10-MVOLT-40K		
	22-OSMT-LED-3400L-DIM10-MVOLT-50K		
4000L	22-OSMT-LED-4000L-DIM10-MVOLT-30K		
	22-OSMT-LED-4000L-DIM10-MVOLT-35K		
	22-OSMT-LED-4000L-DIM10-MVOLT-40K		
	22-OSMT-LED-4000L-DIM10-MVOLT-50K		

14-OSMT-LED

1 X 4 LED Surface Mount Specification Grade Troffer



2400
LUMENS

3400
LUMENS

4000
LUMENS

5000
LUMENS

2400L	14-OSMT-LED-2400L-DIM10-MVOLT-30K	5000L	14-OSMT-LED-5000L-DIM10-MVOLT-30K
	14-OSMT-LED-2400L-DIM10-MVOLT-35K		14-OSMT-LED-5000L-DIM10-MVOLT-35K
	14-OSMT-LED-2400L-DIM10-MVOLT-40K		14-OSMT-LED-5000L-DIM10-MVOLT-40K
	14-OSMT-LED-2400L-DIM10-MVOLT-50K		14-OSMT-LED-5000L-DIM10-MVOLT-50K
3400L	14-OSMT-LED-3400L-DIM10-MVOLT-30K		
	14-OSMT-LED-3400L-DIM10-MVOLT-35K		
	14-OSMT-LED-3400L-DIM10-MVOLT-40K		
	14-OSMT-LED-3400L-DIM10-MVOLT-50K		
4000L	14-OSMT-LED-4000L-DIM10-MVOLT-30K		
	14-OSMT-LED-4000L-DIM10-MVOLT-35K		
	14-OSMT-LED-4000L-DIM10-MVOLT-40K		
	14-OSMT-LED-4000L-DIM10-MVOLT-50K		

LED FLAT PANEL SERIES

24-FPL1-LED

2 X 4 Foot LED Flat Panel



3000
LUMENS

3500
LUMENS

4000
LUMENS

5000
LUMENS

3000L

- 24-FPL1-LED-3000L-DIM10-MVOLT-30K
- 24-FPL1-LED-3000L-DIM10-MVOLT-35K
- 24-FPL1-LED-3000L-DIM10-MVOLT-40K
- 24-FPL1-LED-3000L-DIM10-MVOLT-50K

3500L

- 24-FPL1-LED-3500L-DIM10-MVOLT-30K
- 24-FPL1-LED-3500L-DIM10-MVOLT-35K
- 24-FPL1-LED-3500L-DIM10-MVOLT-40K
- 24-FPL1-LED-3500L-DIM10-MVOLT-50K

4000L

- 24-FPL1-LED-4000L-DIM10-MVOLT-30K
- 24-FPL1-LED-4000L-DIM10-MVOLT-35K
- 24-FPL1-LED-4000L-DIM10-MVOLT-40K
- 24-FPL1-LED-4000L-DIM10-MVOLT-50K

5000L

- 24-FPL1-LED-5000L-DIM10-MVOLT-30K
- 24-FPL1-LED-5000L-DIM10-MVOLT-35K
- 24-FPL1-LED-5000L-DIM10-MVOLT-40K
- 24-FPL1-LED-5000L-DIM10-MVOLT-50K

22-FPL1-LED

2 X 2 Foot LED Flat Panel



2000
LUMENS

3000
LUMENS

3500
LUMENS

4000
LUMENS

2000L

- 22-FPL1-LED-2000L-DIM10-MVOLT-30K
- 22-FPL1-LED-2000L-DIM10-MVOLT-35K
- 22-FPL1-LED-2000L-DIM10-MVOLT-40K
- 22-FPL1-LED-2000L-DIM10-MVOLT-50K

3000L

- 22-FPL1-LED-3000L-DIM10-MVOLT-30K
- 22-FPL1-LED-3000L-DIM10-MVOLT-35K
- 22-FPL1-LED-3000L-DIM10-MVOLT-40K
- 22-FPL1-LED-3000L-DIM10-MVOLT-50K

3500L

- 22-FPL1-LED-3500L-DIM10-MVOLT-30K
- 22-FPL1-LED-3500L-DIM10-MVOLT-35K
- 22-FPL1-LED-3500L-DIM10-MVOLT-40K
- 22-FPL1-LED-3500L-DIM10-MVOLT-50K

4000L

- 22-FPL1-LED-4000L-DIM10-MVOLT-30K
- 22-FPL1-LED-4000L-DIM10-MVOLT-35K
- 22-FPL1-LED-4000L-DIM10-MVOLT-40K
- 22-FPL1-LED-4000L-DIM10-MVOLT-50K

14-FPL1-LED

1 X 4 Foot LED Flat Panel



3000
LUMENS

4000
LUMENS

5000
LUMENS

3000L

- 14-FPL1-LED-3000L-DIM10-MVOLT-30K
- 14-FPL1-LED-3000L-DIM10-MVOLT-35K
- 14-FPL1-LED-3000L-DIM10-MVOLT-40K
- 14-FPL1-LED-3000L-DIM10-MVOLT-50K

4000L

- 14-FPL1-LED-4000L-DIM10-MVOLT-30K
- 14-FPL1-LED-4000L-DIM10-MVOLT-35K
- 14-FPL1-LED-4000L-DIM10-MVOLT-40K
- 14-FPL1-LED-4000L-DIM10-MVOLT-50K

5000L

- 14-FPL1-LED-5000L-DIM10-MVOLT-30K
- 14-FPL1-LED-5000L-DIM10-MVOLT-35K
- 14-FPL1-LED-5000L-DIM10-MVOLT-40K
- 14-FPL1-LED-5000L-DIM10-MVOLT-50K

24-FPL1-P4-LED

2 X 4 Foot LED Flat Panel



6000L

24-FPL-P4-LED-6000L-DIM10-MVOLT-40K
24-FPL-P4-LED-6000L-DIM10-MVOLT-50K



6000
LUMENS

22-FPL1-P4-LED

2 X 2 Foot LED Flat Panel



5000L

22-FPL-P4-LED-5000L-DIM10-MVOLT-40K
22-FPL-P4-LED-5000L-DIM10-MVOLT-50K



5000
LUMENS

SURFACE MOUNT OPTIONS



24-FPL1-LED-SMK



22-FPL1-LED-SMK



14-FPL1-LED-SMK

CB2-LED

LED Cool Beam High Bay (Full Body Specification Grade)



13000
LUMENS

26000
LUMENS

13000L
CB2-LED-13000L-DIM10-MVOLT-WD-40K
CB2-LED-13000L-DIM10-MVOLT-WD-50K
CB2-LED-13000L-DIM10-MVOLT-WD-57K

26000L
CB2-LED-26000L-DIM10-MVOLT-WD-40K
CB2-LED-26000L-DIM10-MVOLT-WD-50K
CB2-LED-26000L-DIM10-MVOLT-WD-57K

CB3-LED

LED Cool Beam High Bay (Full Body Specification Grade)



11000
LUMENS

18000
LUMENS

22500
LUMENS

11000L
CB3-LED-11000L-DIM10-MVOLT-AD-40K
CB3-LED-11000L-DIM10-MVOLT-AD-50K
CB3-LED-11000L-DIM10-MVOLT-GD-40K
CB3-LED-11000L-DIM10-MVOLT-GD-50K
CB3-LED-11000L-DIM10-MVOLT-MD-40K
CB3-LED-11000L-DIM10-MVOLT-MD-50K

18000L
CB3-LED-18000L-DIM10-MVOLT-AD-40K
CB3-LED-18000L-DIM10-MVOLT-AD-50K
CB3-LED-18000L-DIM10-MVOLT-GD-40K
CB3-LED-18000L-DIM10-MVOLT-GD-50K
CB3-LED-18000L-DIM10-MVOLT-MD-40K
CB3-LED-18000L-DIM10-MVOLT-MD-50K

22500L
CB3-LED-22500L-DIM10-MVOLT-AD-40K
CB3-LED-22500L-DIM10-MVOLT-AD-50K
CB3-LED-22500L-DIM10-MVOLT-GD-40K
CB3-LED-22500L-DIM10-MVOLT-GD-50K
CB3-LED-22500L-DIM10-MVOLT-MD-40K
CB3-LED-22500L-DIM10-MVOLT-MD-50K

HIGH BAY OPTICS

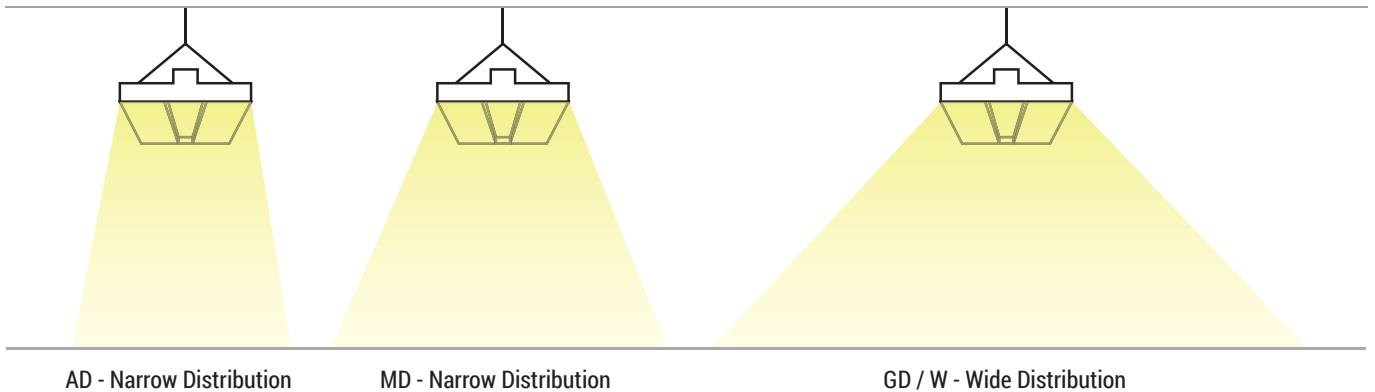

CB4-LED

LED Cool Beam High Bay (Full Body Specification Grade)



10000
LUMENS
14000
LUMENS

12000
LUMENS
16000
LUMENS

- 10000L** CB4-LED-10000L-DIM10-MVOLT-W-30K
CB4-LED-10000L-DIM10-MVOLT-W-35K
CB4-LED-10000L-DIM10-MVOLT-W-40K
CB4-LED-10000L-DIM10-MVOLT-W-50K
- 12000L** CB4-LED-12000L-DIM10-MVOLT-W-30K
CB4-LED-12000L-DIM10-MVOLT-W-35K
CB4-LED-12000L-DIM10-MVOLT-W-40K
CB4-LED-12000L-DIM10-MVOLT-W-50K
- 14000L** CB4-LED-14000L-DIM10-MVOLT-W-30K
CB4-LED-14000L-DIM10-MVOLT-W-35K
CB4-LED-14000L-DIM10-MVOLT-W-40K
CB4-LED-14000L-DIM10-MVOLT-W-50K
- 16000L** CB4-LED-16000L-DIM10-MVOLT-W-30K
CB4-LED-16000L-DIM10-MVOLT-W-35K
CB4-LED-16000L-DIM10-MVOLT-W-40K
CB4-LED-16000L-DIM10-MVOLT-W-50K

CB6-LED

LED Cool Beam High Bay (Full Body Specification Grade)



20000
LUMENS

24000
LUMENS

30000
LUMENS

- 20000L** CB6-LED-20000L-DIM10-MVOLT-W-30K
CB6-LED-20000L-DIM10-MVOLT-W-35K
CB6-LED-20000L-DIM10-MVOLT-W-40K
CB6-LED-20000L-DIM10-MVOLT-W-50K
- 24000L** CB6-LED-24000L-DIM10-MVOLT-W-30K
CB6-LED-24000L-DIM10-MVOLT-W-35K
CB6-LED-24000L-DIM10-MVOLT-W-40K
CB6-LED-24000L-DIM10-MVOLT-W-50K
- 30000L** CB6-LED-30000L-DIM10-MVOLT-W-30K
CB6-LED-30000L-DIM10-MVOLT-W-35K
CB6-LED-30000L-DIM10-MVOLT-W-40K
CB6-LED-30000L-DIM10-MVOLT-W-50K

CB12-LED

LED Cool Beam High Bay (Full Body Specification Grade)



36000
LUMENS

48000
LUMENS

- 36000L** CB12-LED-36000L-DIM10-MVOLT-W-30K
CB12-LED-36000L-DIM10-MVOLT-W-35K
CB12-LED-36000L-DIM10-MVOLT-W-40K
CB12-LED-36000L-DIM10-MVOLT-W-50K
- 48000L** CB12-LED-48000L-DIM10-MVOLT-W-30K
CB12-LED-48000L-DIM10-MVOLT-W-35K
CB12-LED-48000L-DIM10-MVOLT-W-40K
CB12-LED-48000L-DIM10-MVOLT-W-50K

2-OC1-LED

2' LED General Lighting Linear Curve Luminaire



2000
LUMENS

3000
LUMENS

4000
LUMENS

2000L 2-OC1-LED-2000L-DIM10-MVOLT-30K
2-OC1-LED-2000L-DIM10-MVOLT-35K
2-OC1-LED-2000L-DIM10-MVOLT-40K
2-OC1-LED-2000L-DIM10-MVOLT-50K

3000L 2-OC1-LED-3000L-DIM10-MVOLT-30K
2-OC1-LED-3000L-DIM10-MVOLT-35K
2-OC1-LED-3000L-DIM10-MVOLT-40K
2-OC1-LED-3000L-DIM10-MVOLT-50K

4000L 2-OC1-LED-4000L-DIM10-MVOLT-30K
2-OC1-LED-4000L-DIM10-MVOLT-35K
2-OC1-LED-4000L-DIM10-MVOLT-40K
2-OC1-LED-4000L-DIM10-MVOLT-50K

4-OC1-LED

4' LED General Lighting Linear Curve Luminaire



2000
LUMENS

3000
LUMENS

4000
LUMENS

5000
LUMENS

6000
LUMENS

7000
LUMENS

8000
LUMENS

2000L 4-OC1-LED-2000L-DIM10-MVOLT-30K
4-OC1-LED-2000L-DIM10-MVOLT-35K
4-OC1-LED-2000L-DIM10-MVOLT-40K
4-OC1-LED-2000L-DIM10-MVOLT-50K

3000L 4-OC1-LED-3000L-DIM10-MVOLT-30K
4-OC1-LED-3000L-DIM10-MVOLT-35K
4-OC1-LED-3000L-DIM10-MVOLT-40K
4-OC1-LED-3000L-DIM10-MVOLT-50K

4000L 4-OC1-LED-4000L-DIM10-MVOLT-30K
4-OC1-LED-4000L-DIM10-MVOLT-35K
4-OC1-LED-4000L-DIM10-MVOLT-40K
4-OC1-LED-4000L-DIM10-MVOLT-50K

5000L 4-OC1-LED-5000L-DIM10-MVOLT-30K
4-OC1-LED-5000L-DIM10-MVOLT-35K
4-OC1-LED-5000L-DIM10-MVOLT-40K
4-OC1-LED-5000L-DIM10-MVOLT-50K

6000L 4-OC1-LED-6000L-DIM10-MVOLT-30K
4-OC1-LED-6000L-DIM10-MVOLT-35K
4-OC1-LED-6000L-DIM10-MVOLT-40K
4-OC1-LED-6000L-DIM10-MVOLT-50K

7000L 4-OC1-LED-7000L-DIM10-MVOLT-30K
4-OC1-LED-7000L-DIM10-MVOLT-35K
4-OC1-LED-7000L-DIM10-MVOLT-40K
4-OC1-LED-7000L-DIM10-MVOLT-50K

8000L 4-OC1-LED-8000L-DIM10-MVOLT-30K
4-OC1-LED-8000L-DIM10-MVOLT-35K
4-OC1-LED-8000L-DIM10-MVOLT-40K
4-OC1-LED-8000L-DIM10-MVOLT-50K

8-OC1-LED

8' LED General Lighting Linear Curve Luminaire



4000
LUMENS

8000
LUMENS

12000
LUMENS

16000
LUMENS

4000L 8-OC1-LED-4000L-DIM10-MVOLT-30K
8-OC1-LED-4000L-DIM10-MVOLT-35K
8-OC1-LED-4000L-DIM10-MVOLT-40K
8-OC1-LED-4000L-DIM10-MVOLT-50K

8000L 8-OC1-LED-8000L-DIM10-MVOLT-30K
8-OC1-LED-8000L-DIM10-MVOLT-35K
8-OC1-LED-8000L-DIM10-MVOLT-40K
8-OC1-LED-8000L-DIM10-MVOLT-50K

12000L 8-OC1-LED-12000L-DIM10-MVOLT-30K
8-OC1-LED-12000L-DIM10-MVOLT-35K
8-OC1-LED-12000L-DIM10-MVOLT-40K
8-OC1-LED-12000L-DIM10-MVOLT-50K

16000L 8-OC1-LED-16000L-DIM10-MVOLT-30K
8-OC1-LED-16000L-DIM10-MVOLT-35K
8-OC1-LED-16000L-DIM10-MVOLT-40K
8-OC1-LED-16000L-DIM10-MVOLT-50K

2-OC4-LED

2' LED General Lighting Linear Curve Luminaire



2000
LUMENS

3000
LUMENS

4000
LUMENS

2000L
2-OC4-LED-2000L-DIM10-MVOLT-30K
2-OC4-LED-2000L-DIM10-MVOLT-35K
2-OC4-LED-2000L-DIM10-MVOLT-40K
2-OC4-LED-2000L-DIM10-MVOLT-50K

3000L
2-OC4-LED-3000L-DIM10-MVOLT-30K
2-OC4-LED-3000L-DIM10-MVOLT-35K
2-OC4-LED-3000L-DIM10-MVOLT-40K
2-OC4-LED-3000L-DIM10-MVOLT-50K

4000L
2-OC4-LED-4000L-DIM10-MVOLT-30K
2-OC4-LED-4000L-DIM10-MVOLT-35K
2-OC4-LED-4000L-DIM10-MVOLT-40K
2-OC4-LED-4000L-DIM10-MVOLT-50K

4-OC4-LED

4' LED General Lighting Linear Curve Luminaire



2000
LUMENS

3000
LUMENS

4000
LUMENS

5000
LUMENS

6000
LUMENS

7000
LUMENS

8000
LUMENS

2000L
4-OC4-LED-2000L-DIM10-MVOLT-30K
4-OC4-LED-2000L-DIM10-MVOLT-35K
4-OC4-LED-2000L-DIM10-MVOLT-40K
4-OC4-LED-2000L-DIM10-MVOLT-50K

3000L
4-OC4-LED-3000L-DIM10-MVOLT-30K
4-OC4-LED-3000L-DIM10-MVOLT-35K
4-OC4-LED-3000L-DIM10-MVOLT-40K
4-OC4-LED-3000L-DIM10-MVOLT-50K

4000L
4-OC4-LED-4000L-DIM10-MVOLT-30K
4-OC4-LED-4000L-DIM10-MVOLT-35K
4-OC4-LED-4000L-DIM10-MVOLT-40K
4-OC4-LED-4000L-DIM10-MVOLT-50K

5000L
4-OC4-LED-5000L-DIM10-MVOLT-30K
4-OC4-LED-5000L-DIM10-MVOLT-35K
4-OC4-LED-5000L-DIM10-MVOLT-40K
4-OC4-LED-5000L-DIM10-MVOLT-50K

6000L
4-OC4-LED-6000L-DIM10-MVOLT-30K
4-OC4-LED-6000L-DIM10-MVOLT-35K
4-OC4-LED-6000L-DIM10-MVOLT-40K
4-OC4-LED-6000L-DIM10-MVOLT-50K

7000L
4-OC4-LED-7000L-DIM10-MVOLT-30K
4-OC4-LED-7000L-DIM10-MVOLT-35K
4-OC4-LED-7000L-DIM10-MVOLT-40K
4-OC4-LED-7000L-DIM10-MVOLT-50K

8000L
4-OC4-LED-8000L-DIM10-MVOLT-30K
4-OC4-LED-8000L-DIM10-MVOLT-35K
4-OC4-LED-8000L-DIM10-MVOLT-40K
4-OC4-LED-8000L-DIM10-MVOLT-50K

8-OC4-LED

8' LED General Lighting Linear Curve Luminaire



4000
LUMENS

8000
LUMENS

12000
LUMENS

16000
LUMENS

4000L
8-OC4-LED-4000L-DIM10-MVOLT-30K
8-OC4-LED-4000L-DIM10-MVOLT-35K
8-OC4-LED-4000L-DIM10-MVOLT-40K
8-OC4-LED-4000L-DIM10-MVOLT-50K

8000L
8-OC4-LED-8000L-DIM10-MVOLT-30K
8-OC4-LED-8000L-DIM10-MVOLT-35K
8-OC4-LED-8000L-DIM10-MVOLT-40K
8-OC4-LED-8000L-DIM10-MVOLT-50K

12000L
8-OC4-LED-12000L-DIM10-MVOLT-30K
8-OC4-LED-12000L-DIM10-MVOLT-35K
8-OC4-LED-12000L-DIM10-MVOLT-40K
8-OC4-LED-12000L-DIM10-MVOLT-50K

16000L
8-OC4-LED-16000L-DIM10-MVOLT-30K
8-OC4-LED-16000L-DIM10-MVOLT-35K
8-OC4-LED-16000L-DIM10-MVOLT-40K
8-OC4-LED-16000L-DIM10-MVOLT-50K

4-OLS-D-LED-2

4' LED Architectural Suspended Direct Linear



LUMENS/FOOT
500
 LUMENS
750
 LUMENS
1000
 LUMENS



- 500L**
 - 4-OLS-D-LED-2-500L-DIM10-MVOLT-30K
 - 4-OLS-D-LED-2-500L-DIM10-MVOLT-35K
 - 4-OLS-D-LED-2-500L-DIM10-MVOLT-40K
 - 4-OLS-D-LED-2-500L-DIM10-MVOLT-50K
- 750L**
 - 4-OLS-D-LED-2-750L-DIM10-MVOLT-30K
 - 4-OLS-D-LED-2-750L-DIM10-MVOLT-35K
 - 4-OLS-D-LED-2-750L-DIM10-MVOLT-40K
 - 4-OLS-D-LED-2-750L-DIM10-MVOLT-50K
- 1000L**
 - 4-OLS-D-LED-2-1000L-DIM10-MVOLT-30K
 - 4-OLS-D-LED-2-1000L-DIM10-MVOLT-35K
 - 4-OLS-D-LED-2-1000L-DIM10-MVOLT-40K
 - 4-OLS-D-LED-2-1000L-DIM10-MVOLT-50K

4-OLS-DI-LED-2

4' LED Architectural Suspended Direct/Indirect Linear



LUMENS/FOOT
500
 LUMENS
750
 LUMENS
1000
 LUMENS



- 500L**
 - 4-OLS-DI-LED-2-500L-DIM10-MVOLT-30K
 - 4-OLS-DI-LED-2-500L-DIM10-MVOLT-35K
 - 4-OLS-DI-LED-2-500L-DIM10-MVOLT-40K
 - 4-OLS-DI-LED-2-500L-DIM10-MVOLT-50K
- 750L**
 - 4-OLS-DI-LED-2-750L-DIM10-MVOLT-30K
 - 4-OLS-DI-LED-2-750L-DIM10-MVOLT-35K
 - 4-OLS-DI-LED-2-750L-DIM10-MVOLT-40K
 - 4-OLS-DI-LED-2-750L-DIM10-MVOLT-50K
- 1000L**
 - 4-OLS-DI-LED-2-1000L-DIM10-MVOLT-30K
 - 4-OLS-DI-LED-2-1000L-DIM10-MVOLT-35K
 - 4-OLS-DI-LED-2-1000L-DIM10-MVOLT-40K
 - 4-OLS-DI-LED-2-1000L-DIM10-MVOLT-50K

4-OLS-WD-LED-2

4' LED Architectural Wall Mount Direct Linear



LUMENS/FOOT
500
 LUMENS
750
 LUMENS
1000
 LUMENS



- 500L**
 - 4-OLS-WD-LED-2-500L-DIM10-MVOLT-30K
 - 4-OLS-WD-LED-2-500L-DIM10-MVOLT-35K
 - 4-OLS-WD-LED-2-500L-DIM10-MVOLT-40K
 - 4-OLS-WD-LED-2-500L-DIM10-MVOLT-50K
- 750L**
 - 4-OLS-WD-LED-2-750L-DIM10-MVOLT-30K
 - 4-OLS-WD-LED-2-750L-DIM10-MVOLT-35K
 - 4-OLS-WD-LED-2-750L-DIM10-MVOLT-40K
 - 4-OLS-WD-LED-2-750L-DIM10-MVOLT-50K
- 1000L**
 - 4-OLS-WD-LED-2-1000L-DIM10-MVOLT-30K
 - 4-OLS-WD-LED-2-1000L-DIM10-MVOLT-35K
 - 4-OLS-WD-LED-2-1000L-DIM10-MVOLT-40K
 - 4-OLS-WD-LED-2-1000L-DIM10-MVOLT-50K

4-OLS-D-LED-4

4' LED Architectural Suspended Direct Linear

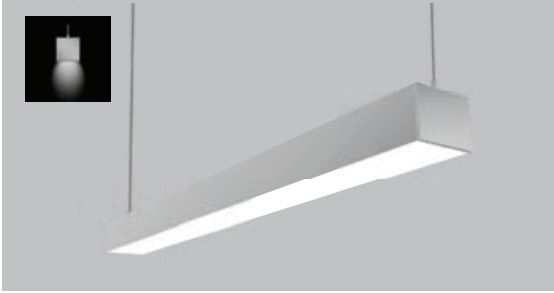

LUMENS/FOOT	
500 LUMENS	750 LUMENS
1000 LUMENS	



- 500L**
 - 4-OLS-D-LED-4-500L-DIM10-MVOLT-30K
 - 4-OLS-D-LED-4-500L-DIM10-MVOLT-35K
 - 4-OLS-D-LED-4-500L-DIM10-MVOLT-40K
 - 4-OLS-D-LED-4-500L-DIM10-MVOLT-50K
- 750L**
 - 4-OLS-D-LED-4-750L-DIM10-MVOLT-30K
 - 4-OLS-D-LED-4-750L-DIM10-MVOLT-35K
 - 4-OLS-D-LED-4-750L-DIM10-MVOLT-40K
 - 4-OLS-D-LED-4-750L-DIM10-MVOLT-50K
- 1000L**
 - 4-OLS-D-LED-4-1000L-DIM10-MVOLT-30K
 - 4-OLS-D-LED-4-1000L-DIM10-MVOLT-35K
 - 4-OLS-D-LED-4-1000L-DIM10-MVOLT-40K
 - 4-OLS-D-LED-4-1000L-DIM10-MVOLT-50K

4-OLS-DI-LED-4

4' LED Architectural Suspended Direct/Indirect Linear

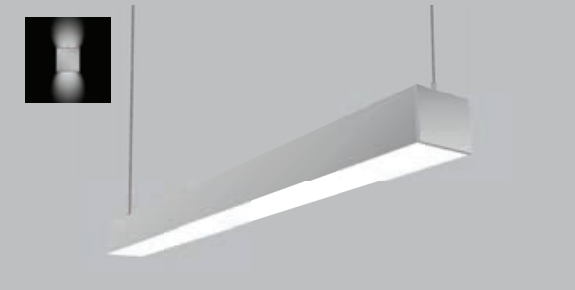

LUMENS/FOOT	
500 LUMENS	750 LUMENS
1000 LUMENS	



- 500L**
 - 4-OLS-DI-LED-4-500L-DIM10-MVOLT-30K
 - 4-OLS-DI-LED-4-500L-DIM10-MVOLT-35K
 - 4-OLS-DI-LED-4-500L-DIM10-MVOLT-40K
 - 4-OLS-DI-LED-4-500L-DIM10-MVOLT-50K
- 750L**
 - 4-OLS-DI-LED-4-750L-DIM10-MVOLT-30K
 - 4-OLS-DI-LED-4-750L-DIM10-MVOLT-35K
 - 4-OLS-DI-LED-4-750L-DIM10-MVOLT-40K
 - 4-OLS-DI-LED-4-750L-DIM10-MVOLT-50K
- 1000L**
 - 4-OLS-DI-LED-4-1000L-DIM10-MVOLT-30K
 - 4-OLS-DI-LED-4-1000L-DIM10-MVOLT-35K
 - 4-OLS-DI-LED-4-1000L-DIM10-MVOLT-40K
 - 4-OLS-DI-LED-4-1000L-DIM10-MVOLT-50K

4-OLS-WD-LED-4

4' LED Architectural Wall Mount Direct Linear

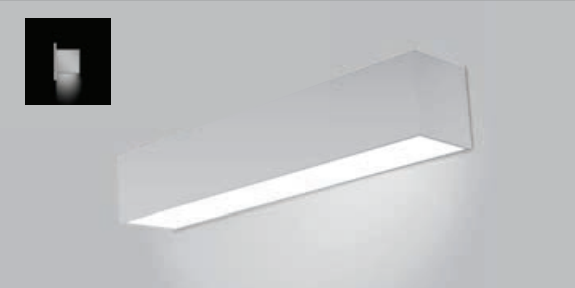

LUMENS/FOOT	
500 LUMENS	750 LUMENS
1000 LUMENS	



- 500L**
 - 4-OLS-WD-LED-4-500L-DIM10-MVOLT-30K
 - 4-OLS-WD-LED-4-500L-DIM10-MVOLT-35K
 - 4-OLS-WD-LED-4-500L-DIM10-MVOLT-40K
 - 4-OLS-WD-LED-4-500L-DIM10-MVOLT-50K
- 750L**
 - 4-OLS-WD-LED-4-750L-DIM10-MVOLT-30K
 - 4-OLS-WD-LED-4-750L-DIM10-MVOLT-35K
 - 4-OLS-WD-LED-4-750L-DIM10-MVOLT-40K
 - 4-OLS-WD-LED-4-750L-DIM10-MVOLT-50K
- 1000L**
 - 4-OLS-WD-LED-4-1000L-DIM10-MVOLT-30K
 - 4-OLS-WD-LED-4-1000L-DIM10-MVOLT-35K
 - 4-OLS-WD-LED-4-1000L-DIM10-MVOLT-40K
 - 4-OLS-WD-LED-4-1000L-DIM10-MVOLT-50K

4-OLS-WDI-LED-2

4' LED Architectural Wall Mount Direct Linear/ Indirect



LUMENS/FOOT	
500 LUMENS	750 LUMENS
1000 LUMENS	



- 500L**
 - 4-OLS-WDI-LED-2-500L-DIM10-MVOLT-30K
 - 4-OLS-WDI-LED-2-500L-DIM10-MVOLT-35K
 - 4-OLS-WDI-LED-2-500L-DIM10-MVOLT-40K
 - 4-OLS-WDI-LED-2-500L-DIM10-MVOLT-50K
- 750L**
 - 4-OLS-WDI-LED-2-750L-DIM10-MVOLT-30K
 - 4-OLS-WDI-LED-2-750L-DIM10-MVOLT-35K
 - 4-OLS-WDI-LED-2-750L-DIM10-MVOLT-40K
 - 4-OLS-WDI-LED-2-750L-DIM10-MVOLT-50K
- 1000L**
 - 4-OLS-WDI-LED-2-1000L-DIM10-MVOLT-30K
 - 4-OLS-WDI-LED-2-1000L-DIM10-MVOLT-35K
 - 4-OLS-WDI-LED-2-1000L-DIM10-MVOLT-40K
 - 4-OLS-WDI-LED-2-1000L-DIM10-MVOLT-50K

4-OLS-R-LED-2

4' LED Architectural Recessed Linear



LUMENS/FOOT	
500 LUMENS	750 LUMENS
1000 LUMENS	

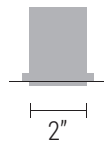

- 500L**
 - 4-OLS-R-LED-2-500L-DIM10-MVOLT-30K
 - 4-OLS-R-LED-2-500L-DIM10-MVOLT-35K
 - 4-OLS-R-LED-2-500L-DIM10-MVOLT-40K
 - 4-OLS-R-LED-2-500L-DIM10-MVOLT-50K
- 750L**
 - 4-OLS-R-LED-2-750L-DIM10-MVOLT-30K
 - 4-OLS-R-LED-2-750L-DIM10-MVOLT-35K
 - 4-OLS-R-LED-2-750L-DIM10-MVOLT-40K
 - 4-OLS-R-LED-2-750L-DIM10-MVOLT-50K
- 1000L**
 - 4-OLS-R-LED-2-1000L-DIM10-MVOLT-30K
 - 4-OLS-R-LED-2-1000L-DIM10-MVOLT-35K
 - 4-OLS-R-LED-2-1000L-DIM10-MVOLT-40K
 - 4-OLS-R-LED-2-1000L-DIM10-MVOLT-50K

4-OLS-WDI-LED-4

4' LED Architectural Wall Mount Direct Linear/ Indirect



LUMENS/FOOT	
500 LUMENS	750 LUMENS
1000 LUMENS	



- 500L**
 - 4-OLS-WDI-LED-4-500L-DIM10-MVOLT-30K
 - 4-OLS-WDI-LED-4-500L-DIM10-MVOLT-35K
 - 4-OLS-WDI-LED-4-500L-DIM10-MVOLT-40K
 - 4-OLS-WDI-LED-4-500L-DIM10-MVOLT-50K
- 750L**
 - 4-OLS-WDI-LED-4-750L-DIM10-MVOLT-30K
 - 4-OLS-WDI-LED-4-750L-DIM10-MVOLT-35K
 - 4-OLS-WDI-LED-4-750L-DIM10-MVOLT-40K
 - 4-OLS-WDI-LED-4-750L-DIM10-MVOLT-50K
- 1000L**
 - 4-OLS-WDI-LED-4-1000L-DIM10-MVOLT-30K
 - 4-OLS-WDI-LED-4-1000L-DIM10-MVOLT-35K
 - 4-OLS-WDI-LED-4-1000L-DIM10-MVOLT-40K
 - 4-OLS-WDI-LED-4-1000L-DIM10-MVOLT-50K

4-OLS-R-LED-4

4' LED Architectural Recessed Linear



LUMENS/FOOT	
500 LUMENS	750 LUMENS
1000 LUMENS	

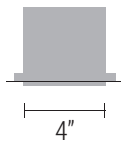

- 500L**
 - 4-OLS-R-LED-4-500L-DIM10-MVOLT-30K
 - 4-OLS-R-LED-4-500L-DIM10-MVOLT-35K
 - 4-OLS-R-LED-4-500L-DIM10-MVOLT-40K
 - 4-OLS-R-LED-4-500L-DIM10-MVOLT-50K
- 750L**
 - 4-OLS-R-LED-4-750L-DIM10-MVOLT-30K
 - 4-OLS-R-LED-4-750L-DIM10-MVOLT-35K
 - 4-OLS-R-LED-4-750L-DIM10-MVOLT-40K
 - 4-OLS-R-LED-4-750L-DIM10-MVOLT-50K
- 1000L**
 - 4-OLS-R-LED-4-1000L-DIM10-MVOLT-30K
 - 4-OLS-R-LED-4-1000L-DIM10-MVOLT-35K
 - 4-OLS-R-LED-4-1000L-DIM10-MVOLT-40K
 - 4-OLS-R-LED-4-1000L-DIM10-MVOLT-50K

8-ASI5-LED - 8' Architectural LED Suspended Linear Direct/Indirect System

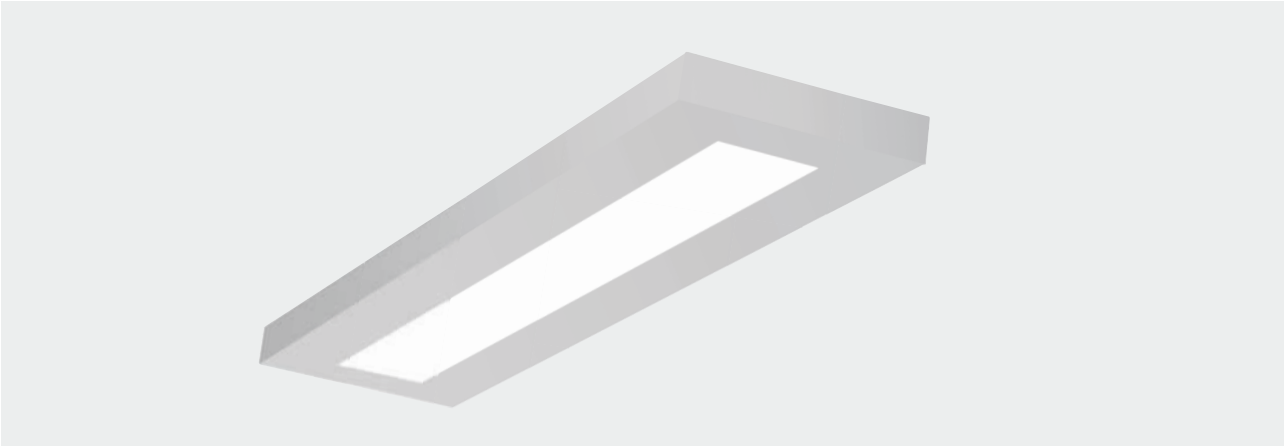

4000 LUMENS	5000 LUMENS	6000 LUMENS	7000 LUMENS	8000 LUMENS	9000 LUMENS
10000 LUMENS	11000 LUMENS	12000 LUMENS	13000 LUMENS	14000 LUMENS	

4000L
8-ASI5-LED-4000L-DIM10-MVOLT-30K
8-ASI5-LED-4000L-DIM10-MVOLT-50K
8-ASI5-LED-4000L-DIM10-MVOLT-40K
8-ASI5-LED-4000L-DIM10-MVOLT-35K

9000L
8-ASI5-LED-9000L-DIM10-MVOLT-30K
8-ASI5-LED-9000L-DIM10-MVOLT-50K
8-ASI5-LED-9000L-DIM10-MVOLT-40K
8-ASI5-LED-9000L-DIM10-MVOLT-35K

5000L
8-ASI5-LED-5000L-DIM10-MVOLT-30K
8-ASI5-LED-5000L-DIM10-MVOLT-40K
8-ASI5-LED-5000L-DIM10-MVOLT-35K
8-ASI5-LED-5000L-DIM10-MVOLT-50K

10000L
8-ASI5-LED-10000L-DIM10-MVOLT-30K
8-ASI5-LED-10000L-DIM10-MVOLT-40K
8-ASI5-LED-10000L-DIM10-MVOLT-35K
8-ASI5-LED-10000L-DIM10-MVOLT-50K

6000L
8-ASI5-LED-6000L-DIM10-MVOLT-35K
8-ASI5-LED-6000L-DIM10-MVOLT-30K
8-ASI5-LED-6000L-DIM10-MVOLT-50K
8-ASI5-LED-6000L-DIM10-MVOLT-40K

11000L
8-ASI5-LED-11000L-DIM10-MVOLT-35K
8-ASI5-LED-11000L-DIM10-MVOLT-30K
8-ASI5-LED-11000L-DIM10-MVOLT-50K
8-ASI5-LED-11000L-DIM10-MVOLT-40K

7000L
8-ASI5-LED-7000L-DIM10-MVOLT-35K
8-ASI5-LED-7000L-DIM10-MVOLT-40K
8-ASI5-LED-7000L-DIM10-MVOLT-50K
8-ASI5-LED-7000L-DIM10-MVOLT-30K

12000L
8-ASI5-LED-12000L-DIM10-MVOLT-35K
8-ASI5-LED-12000L-DIM10-MVOLT-40K
8-ASI5-LED-12000L-DIM10-MVOLT-50K
8-ASI5-LED-12000L-DIM10-MVOLT-30K

8000L
8-ASI5-LED-8000L-DIM10-MVOLT-35K
8-ASI5-LED-8000L-DIM10-MVOLT-40K
8-ASI5-LED-8000L-DIM10-MVOLT-50K
8-ASI5-LED-8000L-DIM10-MVOLT-30K

13000L
8-ASI5-LED-13000L-DIM10-MVOLT-35K
8-ASI5-LED-13000L-DIM10-MVOLT-40K
8-ASI5-LED-13000L-DIM10-MVOLT-50K
8-ASI5-LED-13000L-DIM10-MVOLT-30K

14000L
8-ASI5-LED-14000L-DIM10-MVOLT-35K
8-ASI5-LED-14000L-DIM10-MVOLT-40K
8-ASI5-LED-14000L-DIM10-MVOLT-50K
8-ASI5-LED-14000L-DIM10-MVOLT-30K

4-ASI5-LED - 4' Architectural LED Suspended Linear Direct/Indirect System

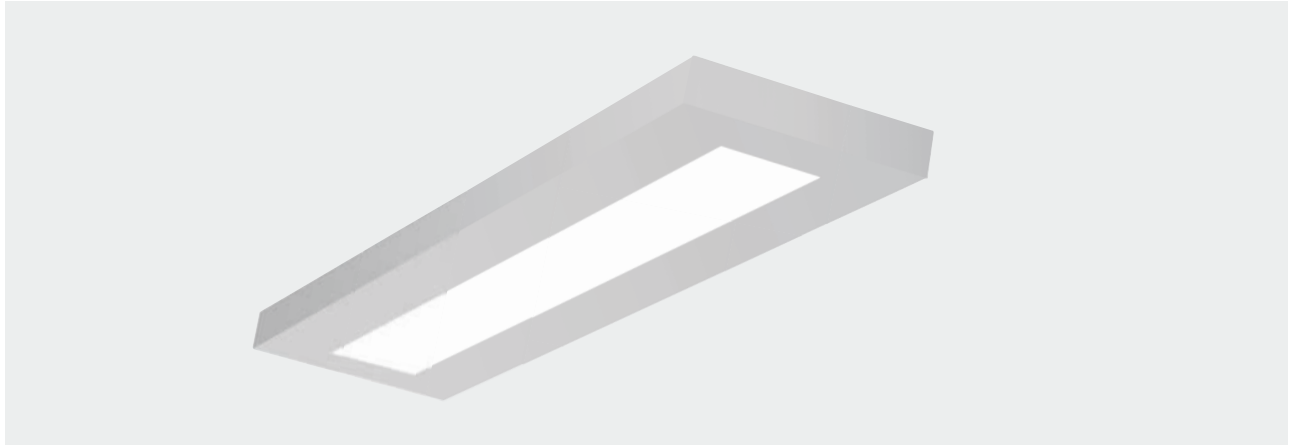

2000
LUMENS

3000
LUMENS

4000
LUMENS

5000
LUMENS

6000
LUMENS

7000
LUMENS

2000L

- 4-ASI5-LED-2000L-DIM10-MVOLT-30K
- 4-ASI5-LED-2000L-DIM10-MVOLT-50K
- 4-ASI5-LED-2000L-DIM10-MVOLT-40K
- 4-ASI5-LED-2000L-DIM10-MVOLT-35K

3000L

- 4-ASI5-LED-3000L-DIM10-MVOLT-30K
- 4-ASI5-LED-3000L-DIM10-MVOLT-40K
- 4-ASI5-LED-3000L-DIM10-MVOLT-35K
- 4-ASI5-LED-3000L-DIM10-MVOLT-50K

4000L

- 4-ASI5-LED-4000L-DIM10-MVOLT-35K
- 4-ASI5-LED-4000L-DIM10-MVOLT-30K
- 4-ASI5-LED-4000L-DIM10-MVOLT-50K
- 4-ASI5-LED-4000L-DIM10-MVOLT-40K

5000L

- 4-ASI5-LED-5000L-DIM10-MVOLT-30K
- 4-ASI5-LED-5000L-DIM10-MVOLT-50K
- 4-ASI5-LED-5000L-DIM10-MVOLT-40K
- 4-ASI5-LED-5000L-DIM10-MVOLT-35K

6000L

- 4-ASI5-LED-6000L-DIM10-MVOLT-30K
- 4-ASI5-LED-6000L-DIM10-MVOLT-40K
- 4-ASI5-LED-6000L-DIM10-MVOLT-35K
- 4-ASI5-LED-6000L-DIM10-MVOLT-50K

7000L

- 4-ASI5-LED-7000L-DIM10-MVOLT-35K
- 4-ASI5-LED-7000L-DIM10-MVOLT-30K
- 4-ASI5-LED-7000L-DIM10-MVOLT-50K
- 4-ASI5-LED-7000L-DIM10-MVOLT-40K

HD1B-LED - Hydro Beam LED IP & Nema Rated High Bay Wide Body



5000 LUMENS | **7000** LUMENS | **10000** LUMENS | **12000** LUMENS | **15000** LUMENS | **20000** LUMENS | **23000** LUMENS | **28000** LUMENS

5000L HD1B-LED-5000L-DIM10-MVOLT-30K
 HD1B-LED-5000L-DIM10-MVOLT-50K
 HD1B-LED-5000L-DIM10-MVOLT-40K
 HD1B-LED-5000L-DIM10-MVOLT-35K

7000L HD1B-LED-7000L-DIM10-MVOLT-30K
 HD1B-LED-7000L-DIM10-MVOLT-40K
 HD1B-LED-7000L-DIM10-MVOLT-35K
 HD1B-LED-7000L-DIM10-MVOLT-50K

10000L HD1B-LED-10000L-DIM10-MVOLT-35K
 HD1B-LED-10000L-DIM10-MVOLT-30K
 HD1B-LED-10000L-DIM10-MVOLT-50K
 HD1B-LED-10000L-DIM10-MVOLT-40K

12000L HD1B-LED-12000L-DIM10-MVOLT-35K
 HD1B-LED-12000L-DIM10-MVOLT-40K
 HD1B-LED-12000L-DIM10-MVOLT-50K
 HD1B-LED-12000L-DIM10-MVOLT-30K

15000L HD1B-LED-15000L-DIM10-MVOLT-30K
 HD1B-LED-15000L-DIM10-MVOLT-50K
 HD1B-LED-15000L-DIM10-MVOLT-40K
 HD1B-LED-15000L-DIM10-MVOLT-35K

20000L HD1B-LED-20000L-DIM10-MVOLT-30K
 HD1B-LED-20000L-DIM10-MVOLT-40K
 HD1B-LED-20000L-DIM10-MVOLT-35K
 HD1B-LED-20000L-DIM10-MVOLT-50K

23000L HD1B-LED-23000L-DIM10-MVOLT-35K
 HD1B-LED-23000L-DIM10-MVOLT-30K
 HD1B-LED-23000L-DIM10-MVOLT-50K
 HD1B-LED-23000L-DIM10-MVOLT-40K

28000L HD1B-LED-28000L-DIM10-MVOLT-35K
 HD1B-LED-28000L-DIM10-MVOLT-40K
 HD1B-LED-28000L-DIM10-MVOLT-50K
 HD1B-LED-28000L-DIM10-MVOLT-30K

2-OW1IP-LED

2 feet LED vapor tight series

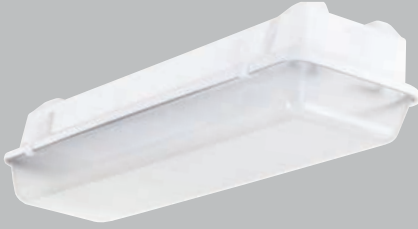

2000
LUMENS

3000
LUMENS

- 2000L** 2-OW1IP-LED-2000L-DIM10-MVOLT-30K
- 2-OW1IP-LED-2000L-DIM10-MVOLT-35K
- 2-OW1IP-LED-2000L-DIM10-MVOLT-40K
- 2-OW1IP-LED-2000L-DIM10-MVOLT-50K

- 3000L** 2-OW1IP-LED-3000L-DIM10-MVOLT-30K
- 2-OW1IP-LED-3000L-DIM10-MVOLT-35K
- 2-OW1IP-LED-3000L-DIM10-MVOLT-40K
- 2-OW1IP-LED-3000L-DIM10-MVOLT-50K

4-OW1IP-LED

4 feet LED vapor tight series

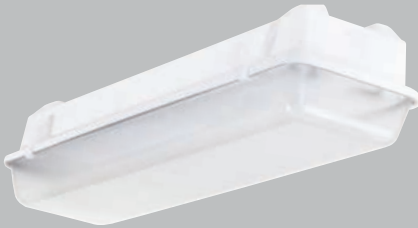

2000
LUMENS

3000
LUMENS

4000
LUMENS

5000
LUMENS

6000
LUMENS

- 2000L** 4-OW1IP-LED-2000L-DIM10-MVOLT-30K
- 4-OW1IP-LED-2000L-DIM10-MVOLT-35K
- 4-OW1IP-LED-2000L-DIM10-MVOLT-40K
- 4-OW1IP-LED-2000L-DIM10-MVOLT-50K

- 3000L** 4-OW1IP-LED-3000L-DIM10-MVOLT-30K
- 4-OW1IP-LED-3000L-DIM10-MVOLT-35K
- 4-OW1IP-LED-3000L-DIM10-MVOLT-40K
- 4-OW1IP-LED-3000L-DIM10-MVOLT-50K

- 4000L** 4-OW1IP-LED-4000L-DIM10-MVOLT-30K
- 4-OW1IP-LED-4000L-DIM10-MVOLT-35K
- 4-OW1IP-LED-4000L-DIM10-MVOLT-40K
- 4-OW1IP-LED-4000L-DIM10-MVOLT-50K

- 5000L** 4-OW1IP-LED-5000L-DIM10-MVOLT-30K
- 4-OW1IP-LED-5000L-DIM10-MVOLT-35K
- 4-OW1IP-LED-5000L-DIM10-MVOLT-40K
- 4-OW1IP-LED-5000L-DIM10-MVOLT-50K

- 6000L** 4-OW1IP-LED-6000L-DIM10-MVOLT-30K
- 4-OW1IP-LED-6000L-DIM10-MVOLT-35K
- 4-OW1IP-LED-6000L-DIM10-MVOLT-40K
- 4-OW1IP-LED-6000L-DIM10-MVOLT-50K

8-OW1IP-LED

8 feet LED vapor tight series

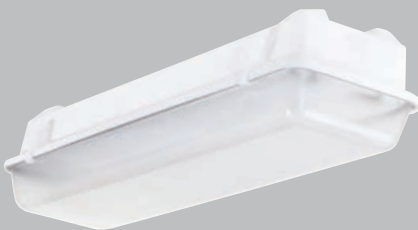

4000
LUMENS

6000
LUMENS

8000
LUMENS

10000
LUMENS

12000
LUMENS

- 4000L** 8-OW1IP-LED-4000L-DIM10-MVOLT-30K
- 8-OW1IP-LED-4000L-DIM10-MVOLT-35K
- 8-OW1IP-LED-4000L-DIM10-MVOLT-40K
- 8-OW1IP-LED-4000L-DIM10-MVOLT-50K

- 6000L** 8-OW1IP-LED-6000L-DIM10-MVOLT-30K
- 8-OW1IP-LED-6000L-DIM10-MVOLT-35K
- 8-OW1IP-LED-6000L-DIM10-MVOLT-40K
- 8-OW1IP-LED-6000L-DIM10-MVOLT-50K

- 8000L** 8-OW1IP-LED-8000L-DIM10-MVOLT-30K
- 8-OW1IP-LED-8000L-DIM10-MVOLT-35K
- 8-OW1IP-LED-8000L-DIM10-MVOLT-40K
- 8-OW1IP-LED-8000L-DIM10-MVOLT-50K

- 10000L** 8-OW1IP-LED-10000L-DIM10-MVOLT-30K
- 8-OW1IP-LED-10000L-DIM10-MVOLT-35K
- 8-OW1IP-LED-10000L-DIM10-MVOLT-40K
- 8-OW1IP-LED-10000L-DIM10-MVOLT-50K

- 12000L** 8-OW1IP-LED-12000L-DIM10-MVOLT-30K
- 8-OW1IP-LED-12000L-DIM10-MVOLT-35K
- 8-OW1IP-LED-12000L-DIM10-MVOLT-40K
- 8-OW1IP-LED-12000L-DIM10-MVOLT-50K

24-OVHP-RTK-LED

LED troffer retrofit kit



4000
LUMENS

5000
LUMENS

6000
LUMENS

4000L

24-OVHP-RTK-LED-4000L-DIMST-MVOLT-30K
24-OVHP-RTK-LED-4000L-DIMST-MVOLT-35K
24-OVHP-RTK-LED-4000L-DIMST-MVOLT-40K
24-OVHP-RTK-LED-4000L-DIMST-MVOLT-50K

5000L

24-OVHP-RTK-LED-5000L-DIMST-MVOLT-30K
24-OVHP-RTK-LED-5000L-DIMST-MVOLT-35K
24-OVHP-RTK-LED-5000L-DIMST-MVOLT-40K
24-OVHP-RTK-LED-5000L-DIMST-MVOLT-50K

6000L

24-OVHP-RTK-LED-6000L-DIMST-MVOLT-30K
24-OVHP-RTK-LED-6000L-DIMST-MVOLT-35K
24-OVHP-RTK-LED-6000L-DIMST-MVOLT-40K
24-OVHP-RTK-LED-6000L-DIMST-MVOLT-50K

22-OVHP-RTK-LED

LED troffer retrofit kit



4000
LUMENS

4000L

22-OVHP-RTK-LED-4000L-DIMST-MVOLT-30K
22-OVHP-RTK-LED-4000L-DIMST-MVOLT-35K
22-OVHP-RTK-LED-4000L-DIMST-MVOLT-40K
22-OVHP-RTK-LED-4000L-DIMST-MVOLT-50K

4-OEC-LED

4 feet general linear lighting series



4000
LUMENS

2000L

- 4-OEC-LED-4000L-DIM10-MVOLT-35K
- 4-OEC-LED-4000L-DIM10-MVOLT-35K
- 4-OEC-LED-4000L-DIM10-MVOLT-35K

4-OWS-LED

4 feet LED vapor tight series



4000
LUMENS

2000L

- 4-OWS-LED-4000L-DIM10-MVOLT-35K
- 4-OWS-LED-4000L-DIM10-MVOLT-40K
- 4-OWS-LED-4000L-DIM10-MVOLT-50K



OWP-FC-201-LED

LED Medium Full Cut-Off Wall Pack

4000 | **6000** | **41K** | **50K**
LUMENS | LUMENS | CCT

PROUDLY ASSEMBLED in AMERICA

FOR WET LOCATION



OWP-FC-201-4000L-MVOLT-41K-BZ
OWP-FC-201-4000L-MVOLT-50K-BZ
OWP-FC-201-6000L-MVOLT-41K-BZ
OWP-FC-201-6000L-MVOLT-50K-BZ

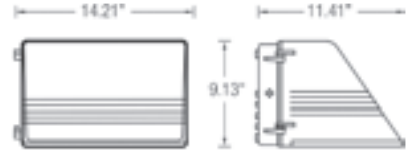

OWP-NC-201-LED

LED Medium Full Cut-Off Wall Pack

4000 | **6000** | **41K** | **50K**
LUMENS | LUMENS | CCT

PROUDLY ASSEMBLED in AMERICA

FOR WET LOCATION



OWP-NC-201-4000L-MVOLT-41K-BZ
OWP-NC-201-4000L-MVOLT-50K-BZ
OWP-NC-201-6000L-MVOLT-41K-BZ
OWP-NC-201-6000L-MVOLT-50K-BZ

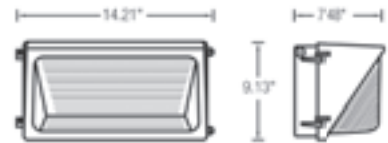

OVR-101-LED

LED CANOPY

4000 | **6000** | **40K** | **50K**
LUMENS | LUMENS | CCT

PROUDLY ASSEMBLED in AMERICA

FOR WET LOCATION



OVR-101-LED-4000L-MVOLT-75-40K
OVR-101-LED-4000L-MVOLT-75-50K
OVR-101-LED-6000L-MVOLT-75-50K
OVR-101-LED-6000L-MVOLT-75-50K

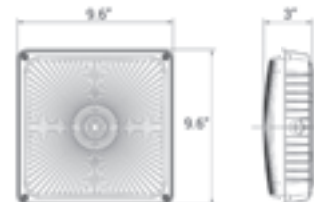



OFL-R-101-LED

LED Medium Full Cut-Off Wall Pack

3300
LUMENS

40K | 50K
CCT



OFL-R-101-LED-3300L-MVOLT-NFL-40K
OFL-R-101-LED-3300L-MVOLT-NFL-50K



OFL-SL-102-LED

LED Medium Full Cut-Off Wall Pack

1500
LUMENS

30K | 40K | 50K
CCT



OFL-SL-102-LED-1500L-MVOLT-30K
OFL-SL-102-LED-1500L-MVOLT-40K
OFL-SL-102-LED-1500L-MVOLT-50K



OWP-SL-101-LED

LED CANOPY

2700
LUMENS

30K | 40K | 50K
CCT



OWP-SL-101-LED-2700L-MVOLT-30K
OWP-SL-101-LED-2700L-MVOLT-40K
OWP-SL-101-LED-2700L-MVOLT-50K

CONTROL OPTIONS

EASYFIT by EnOcean

Self-powered sensors and switches, combined with LED fixture controllers and a commissioning tool, permit easy configuration, intelligent local control, and seamless integration into building automation systems.

Controls Options to be Installed on the Fixture



LEDRU
LED Relay Zone Controller 0-10V



LEDDU
LED Zone Controller 0-10V

Controls Provided by EnOcean

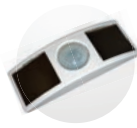

EOSCU
Occupancy sensor
Ceiling Mount



EOSWU
Occupancy sensor
Wall Mount



ELLSU
Daylight sensor
Ceiling Mount



ESRPU/EDRPU
Wall Switches



LEWITON
Wall Switches
902 MHz category



NWC 300U
Navigan Wireless
Commissioner

PHILIPS

Philips EasySense sensors provide luminaire-level control with Occupancy sensing, Daylight harvesting, and Field task tuning.

Controls Installed on the Fixture



SRB-LD
Fixture will be Shipped Sensor Ready with SRB-LD Bridge. Fixture will be Compatible with EasySense Sensor SNS200-CMD which can be Added in the Field for Remote Mounting. Fixture May Only be Controlled with Philips Field App or Wireless Switches or any 0-10V Wall Box Dimmer.



SRB-LD-SNS200-CMD
Fixture Will be Shipped Sensor Ready with PHILIPS SRB-LD Bridge and EasySense SNS200-CMD Sensor which is Included to be Remote Mounted. Fixture May Only be Controlled with Philips Field App or Wireless Switches or any 0-10V Wall Box Dimmer.



PHILIPS-XSR-SNS200-CMD
Fixture will be Shipped Sensor Ready with PHILIPS-XSR driver and EasySense SNS200-CMD Sensor which is Included to be Remote Mounted. Fixture May Only be Controlled with Philips Field App or Wireless Switches



SRB-LD-SNS200
Fixture Will be Shipped with EasySense SNS200 Sensor installed and PHILIPS SRB-LD Bridge. Fixture May Only be Controlled with Philips Field App or Wireless Switches or any 0-10V Wall Box Dimmer.

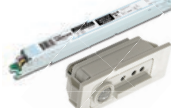

PHILIPS-XSR-SNS200
Fixture will be Shipped with EasySense SNS200 Sensor installed and PHILIPS-XSR driver. Fixture May Only be Controlled with Philips Field App or Wireless Switches.

Controls Provided by Philips



ZBT-S1AWH
Illumra Wireless Switches



ZBT-S2AWH
Illumra Wireless Switches



Philips Field App

enlighted

Enlighted Smart Sensors features digital motion, ambient light, and temperature sensing, the device provides autonomous fixture-level control

Controls Installed on the Fixture



CU-E3-1R + SU-4E-00
Fixture Will be Shipped with Enlighted SU-4E-00 Sensor installed and Enlighted CU-E3-1R Control Unit Power Pack. Fixture May be Controlled with Enlighted Gateway, Energy Manager or Enlighted Room Controller WS-2-00



PHILIPS-XSR-CS-D2
Fixture Will be Shipped with Enlighted CS-D2 Two-wire sensor installed and PHILIPS-XSR driver. Fixture May be Controlled with Enlighted Gateway, Energy Manager or Enlighted Room Controller WS-2-00



PHILIPS-XSR-FS-D22
Fixture Will be Shipped with Enlighted FS-D22 Two-wire sensor installed and PHILIPS-XSR driver. Fixture May be Controlled with Enlighted Gateway, Energy Manager or Enlighted Room Controller WS-2-00



PHILIPS-XSR
Fixture Will be Shipped Sensor Ready with PHILIPS-XSR driver. Fixtures will be compatible with Enlighted CS-D2 Two-wire sensor which can be Added in the Field for Remote Mounting. Fixture May be Controlled with Enlighted Gateway, Energy Manager or Enlighted Room Controller WS-2-00.

CU-E3-1R
Fixture Will be Shipped Sensor Ready with Enlighted CU-E3-1R Control Unit Power Pack. Fixture will be compatible with Enlighted SU-4E-00 Sensor which can be Added in the Field Remote Mounting. Fixture May be Controlled with Enlighted Gateway, Energy Manager or Enlighted Room Controller WS-2-00

Controls Provided by Enlighted



Wireless
Gateway

Ethernet



Energy Manager



WS-2-00
Enlighted Room
Controller

LUTRON

Controls Installed on the Fixture



FCJS-010

Fixture Will be Shipped LUTRON VIVE Enabled with LUTRON FCJS-010 0-10V Control Module Installed on the Fixture. Fixtures will be compatible with Lutron FC-SENSOR Occupancy/Daylight Sensor or FC-VSENSOR Vacancy/Daylight Sensor which can be Added in the Field for Remote Mounting. Fixture May be Controlled with any Vive control systems. Fixtures must be ordered with a 0-10V Driver.



FCJS-ECO

Fixture Will be Shipped LUTRON VIVE Enabled with LUTRON FCJS-ECO EcoSystem Control Module Control Module Installed on the Fixture. Fixtures will be compatible with Lutron FC-SENSOR Occupancy/Daylight Sensor or FC-VSENSOR Vacancy/Daylight Sensor which can be Added in the Field for Remote Mounting. Fixture May be Controlled with any Vive control systems. Fixtures must be ordered with a Lutron Driver.



**FCJS-010 +
DFCSJ-OEM-RF**

Fixture Will be Shipped LUTRON VIVE Enabled with LUTRON FCJS-010 0-10V Control Module and DFCSJ-OEM-RF* Vive Integral Fixture Control (RF Only) Installed on the Fixture. Fixture May be Controlled with any Vive control systems. Fixtures must be ordered with a 0-10V Driver.



**FCJS-010 +
DFCSJ-OEM-OCC**

Fixture Will be Shipped LUTRON VIVE Enabled with LUTRON FCJS-010 0-10V Control Module and DFCSJ-OEM-OCC* Vive Integral Fixture Control (with Sensing) Installed on the Fixture. Fixture May be Controlled with any Vive control systems. Fixtures must be ordered with a 0-10V Driver.



**FCJS-ECO +
DFCSJ-OEM-RF**

Fixture Will be Shipped LUTRON VIVE Enabled with LUTRON FCJS-ECO EcoSystem Control Module Control Module and DFCSJ-OEM-RF* Vive Integral Fixture Control (RF Only) Installed on the Fixture. Fixture May be Controlled with any Vive control systems. Fixtures must be ordered with a Lutron Driver.



**FCJS-ECO +
DFCSJ-OEM-OCC**

Fixture Will be Shipped LUTRON VIVE Enabled with LUTRON FCJS-ECO EcoSystem Control Module Control Module and DFCSJ-OEM-OCC* Vive Integral Fixture Control (with Sensing) Installed on the Fixture. Fixture May be Controlled with any Vive control systems. Fixtures must be ordered with a Lutron Driver.

Controls Provided by Lutron



Vive Wireless Hub



Ceiling Mount
Occupancy/Daylight
Sensor



DayLight
Sensor



Pico
Remote



Wall Mount
Occupancy Sensor



Wall Mount
Switch



Ceiling Mount
Occupancy Sensor



FOR A BETTER WORLD





The products shown in this catalog are covered by USA and international patents. Specifications are subject to change without prior notice.

Elite Lighting reserves the right to make any changes in the design, construction and listing approval of the products listed in this catalog which may be required by law or by the rules of any regulatory body or at its discretion.

Dimensions and specifications are subject to change without prior notice.

Not responsible for any typographical errors.

Wattage and specifications may be different for products supplied in CANADA.

Main Office: Los Angeles, CA

• **WWW.IUSEELITE.COM**

• Tel: **1-323-888-1973 / 1-877-375-5555**

• Fax: **1-323-888-1977 / 1-877-375-3333**

© Copyright 2017. Elite Lighting. All Rights Reserved / Rev1.0-2017