

**Superstrut®**

# **Superstrut® Metal Framing System**

**In this section...**



## **Superstrut® Metal Framing System**

Overview .....	B-106-B-109
Channels .....	B-110-B-111
Threaded Products and Hardware .....	B-112-B-117
Fittings and Brackets .....	B-118-B-125
Concrete Inserts .....	B-126-B-127
Beam Clamps .....	B-128-B-135
Pipe Straps, Conduit Clamps and Hangers .....	B-136-B-182
Surface Raceway and Lighting Systems.....	B-183-B-187
Slotted Angle Metal Framing .....	B-188-B-189
Special Metals and Finishes .....	B-190-B-198
Technical Information .....	B-199-B-220

**Thomas & Betts**

[www.tnb.com](http://www.tnb.com)

## Overview



## New Trivalent GoldGalv® Finish Is RoHS Compliant

Thomas & Betts is proud to introduce the new and improved Trivalent GoldGalv® finish. GoldGalv® finish is a combination of .5 mils electro-plated zinc and a gold Trivalent Chromium finish.

- **Gold Trivalent Chromium Finish** — The new GoldGalv® finish features a Trivalent Chromium formulation that provides all the features and protection of Hexavalent Chromium (CR VI) without the use of this chemical compound. Hexavalent Chromium is restricted by some standards such as the European Union directive on the restriction of the use of certain hazardous substances in electrical and electronic equipment (RoHS).
- **RoHS Compliant** — One great feature for the new Trivalent Chromium formulation is RoHS compliance. Because Hexavalent Chromium is a substance that is restricted by RoHS, moving away from a Hexavalent formulation to the new Trivalent formulation will make the performance of GoldGalv® coating available to customers affected by RoHS and other standards like RoHS around the world.
- **Trivalent GoldGalv® Finish Is OSHA Safe** — The Hexavalent formulation of the GoldGalv® finish is safe with regard to the revised 2006 OSHA standard. This new Trivalent formulation of the GoldGalv® finish does not contain any Hexavalent Chromium and therefore does not fall under the scope of the OSHA standard at all. As a result, the new Trivalent GoldGalv® finish, just like the Hexavalent GoldGalv® finish, is OSHA compliant.
- **ASTM B633 Specification** — The improved GoldGalv® finish is applied in compliance with ASTM B633 coating, the same standard as used previously. This standard outlines electro-deposited coatings of zinc on steel.



**Thomas & Betts**

**United States**  
Tel: 901.252.8000  
800.816.7809  
Fax: 901.252.1354

**Technical Services**  
Tel: 888.862.3289

[www.tnb.com](http://www.tnb.com)

## Overview

### Finishes

#### GoldGalv®

The standard GoldGalv® finish is made up of a multi-step zinc electrogalvanizing process. The Trivalent Chromium finish is applied over the zinc, producing a chemically bonded non-porous barrier for protection from moisture and air. The .5 mil electro-plated zinc and gold Trivalent Chromium finish provides all of the features and protection of Hexavalent Chromium without the use of the chemical.



Metal Framing & Cable Tray — Superstrut® Metal Framing System

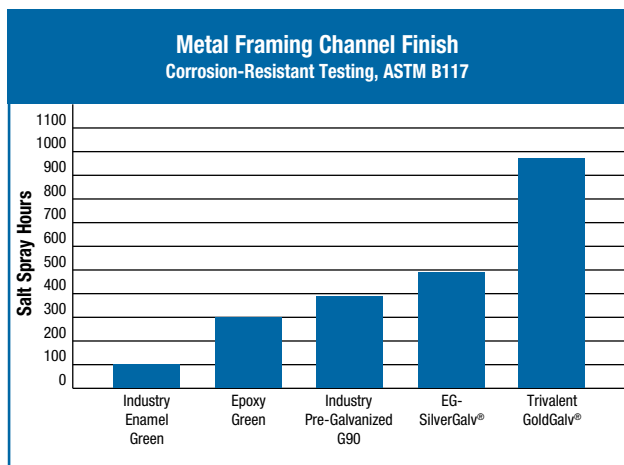
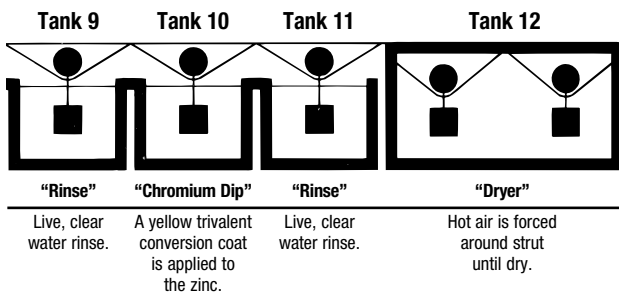
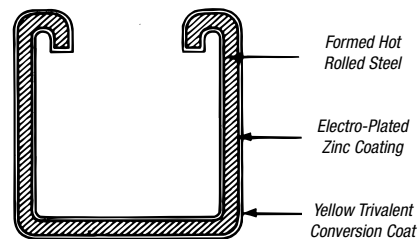
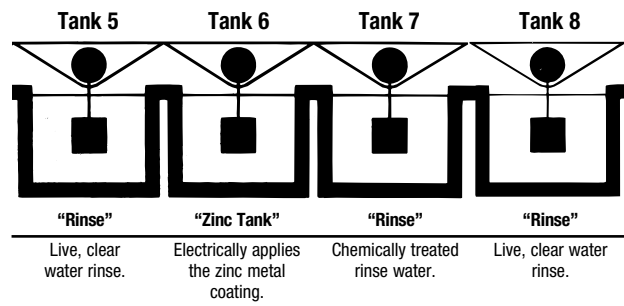
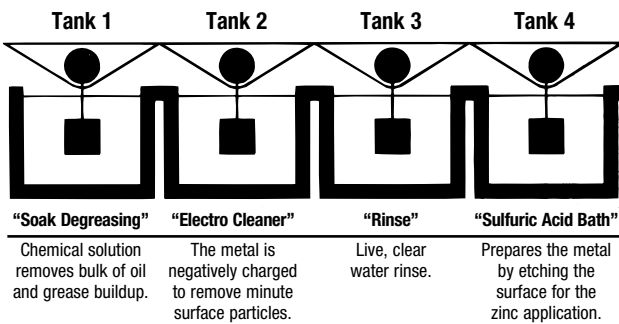

## Overview

### Outperforms the Competition

#### Superstrut® SilverGalv®

The Superstrut® SilverGalv® finish is a post-fabrication, 12-step electrogalvanizing process that applies a clear conversion coat over .5 mils of zinc. This process provides a strong, cohesive molecular bond that locks out moisture and superior corrosion resistance over standard G90 pre-galvanized channel.

- **No More White Rust** — With pre-galvanized struts, a common quality issue is the formation of white rust on the zinc finish. With SilverGalv®, a clear conversion coat is applied over the zinc to seal it and stop the formation of white rust.
- **Strong Abrasion Resistance** — The SilverGalv® finish won't chip or peel like a green painted strut product. It stands up to rough handling.
- **Superior Corrosion Protection** — One hallmark of the SilverGalv® finish is the superior corrosion protection it provides. In the ASTM B117 salt spray test, the new SilverGalv® finish provided improved protection as compared to painted finishes or G90 Pre-Galvanized. This outstanding corrosion protection means more versatile installations and more service life for SilverGalv® finished products.
- **Punched Holes and Cut Ends Are Protected** — Unlike a pre-galvanized finish where bare steel holes and cuts have no corrosion protection, SilverGalv® protects every portion of the strut. Because the SilverGalv® finish is applied after fabrication, all punched holes and cut ends share a consistent quality with the rest of the material — even after cutting or fabricating. SilverGalv® will continue to protect with its sacrificial zinc process.
- **Paintable Surface** — The new SilverGalv® finish provides a non-porous and non-crystalline surface. Not only does this feature provide enhanced corrosion protection, but also provides an excellent bond for the paint of your choice.
- **Clean Finish** — SilverGalv® ensures a finished product that leaves no residue on your hands. In the SilverGalv® process, a zinc finish is applied after fabrication. As a result, all of the oil and grime that accumulates during manufacturing gets thoroughly cleaned off during the plating process.
- **Great Electrical Conductivity** — Unlike paint or enamel, the SilverGalv® surface offers a minimum of electrical resistance, so electrical applications are easily grounded when grounding is needed.



#### Complete Offering of SilverGalv® Fittings and Accessories

Mismatched strut assemblies are a thing of the past with Superstrut SilverGalv. With a complete line of channel, hardware, fittings, hangers and pipe straps, all components have the same electrogalvanized finish for consistent performance and uniform aesthetics.

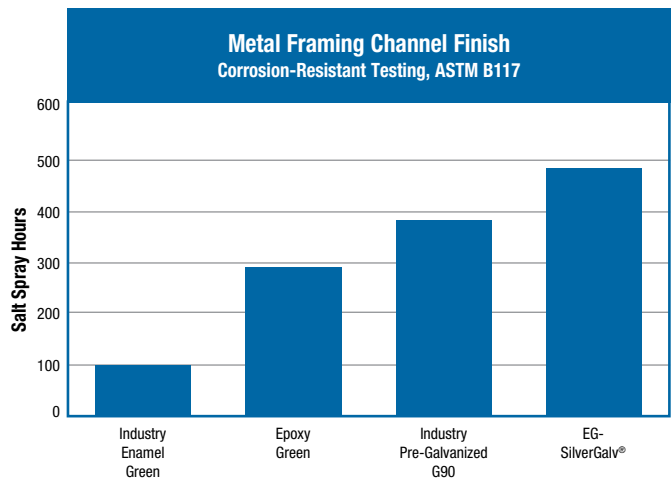

## Overview

### Finishes (continued)

#### GoldGalv®

The standard GoldGalv® finish is made up of a multi-step electrogalvanizing and zinc trivalent chromium process. The trivalent chromium finish is applied over the zinc, producing a chemically bonded non-porous barrier for protection from moisture and air. The .5 mil electro-plated zinc and gold trivalent chromium finish provides all of the features and protection of hexavalent chromium without the use of the chemical.

#### SilverGalv® (Suffix EG)

Often referred to as "zinc plated" or "electroplated zinc," the steel and .5 mils of zinc are bonded by an electrolysis process. This is the identical process used in the Superstrut GoldGalv® finish without the numerous benefits of the gold-colored trivalent chromium conversion coat (see GoldGalv® finish for more information). Electrogalvanizing is most commonly applied to small fittings, hardware and threaded products.

#### Green or White Urethane Powder Coated (Suffix GR or WH)

Urethane powder resins are applied electrostatically to the steel after fabrication. Once the material is completely covered with the powder-form urethane, it proceeds through a 400° baking process for ten minutes, creating a chemical bond. This results in a minimum of 1.5 mil thickness of urethane coating, providing excellent resistance to chipping or peeling.

#### Pregalvanized (Suffix PG)

A zinc coating is applied by hot-dipping the steel coil at the mill prior to fabrication. Once the material is worked by roll-forming, cutting or punching, minimal protection is provided for raw edges. This weakness is typical with pre-coated material and affects the channel section around holes, extreme ends and the edges of the "U" shape lips. Superstrut pregalvanized material is in conformance with ASTM A-525/G-90 specification standards, representing 0.90 ounces of zinc per square foot of steel. This finish is often referred to as "hot-dipped mill galvanized" or "mill galvanized."

#### Hot-Dipped Galvanized (Suffix HDG)

The material is zinc coated after fabrication, providing total product protection on all surfaces. The fabricated channel or fitting is suspended and then dipped into tanks of hot zinc for a prolonged period, creating a coherent bond. The result is superior corrosion resistance as compared to pregalvanized material. Hot-dipped galvanizing is not recommended for threaded products, because the thickness of the zinc coating will often disrupt the threads. Superstrut hot-dipped galvanized is in conformance with ASTM Specifications A-123 (formerly A-386) and A-153. Superstrut channels maintain a minimum 1.5 ounces of zinc per square foot of steel or 2.5 mils (ASTM A-123, Thickness Grade 65). This finish is also referred to as "hot-dipped galvanized after fabrication."

#### PVC Coated (Suffix PVC)

A polyvinyl chloride (PVC) plastic coating is fused to the channel, fitting or accessory after fabrication by immersing the part in fluidized PVC tanks. The fused-melt mixed powder PVC coating thickness is 15 mils (.015") plus or minus five mils. PVC material is a thermoplastic and will soften in high temperature. An inherent weakness with PVC coatings occurs when field alterations are applied, such as cutting or drilling. These acts disrupt the sealed PVC product and warrant field touch-up. Thomas & Betts cannot be held responsible for field-altered PVC coated products.

#### Copper Plated ("T" inserted as the second digit of the part number; Example: CTL-710-2)

Plain steel proceeds through a series of rinse tanks to clean the material surface. Once cleaned, the fabricated part is etched by dipping into an acid pickle bath to prepare the surface for adhesion. Copper is electrically applied by submerging in a copper bath. To seal the finish, the product continues to a sealer tank and is then dried by forced hot air.

#### Black (Suffix B)

A black finish is raw steel with only a light oil finish as supplied by the steel manufacturer. There is no protection against red rust.

#### Stainless Steel (Suffix SS)

Superstrut channel is supplied in type 304 stainless steel when required. Type 316 stainless steel may be available upon request.

#### Aluminum (Suffix AL)

Superstrut channel and hardware are available in aluminum.

**Warning:** Load tables, charts and design criteria provided in this catalog are intended as guides only. Selection of proper product, installation intervals, erection and placement are the responsibility of the user.

Superstrut® products are intended to be used for the support and bracing of fixtures, cable, pipe and conduit. Improper use or installation may result in injury to persons or damage of property.

Material and finish specifications are subject to change without notice.



## Channels

### Standard Channels

#### Material

Channels are cold formed from hot-rolled pickled and oiled strip steel.

#### Material Thickness

All Series 1200 12 gauge material

All Series 1400 14 gauge material

#### Standard Lengths

Standard lengths for channel are 10 ft. and 20 ft.

Standard length tolerance  $\pm \frac{1}{8}$ ".

Shorter lengths are available at a small cutting charge.

GoldGalv® hardware finish is standard for all Superstrut products. This is a multi-process finish of electro-plated zinc, followed by gold colored trivalent chromium to give excellent corrosion resistance and superior paint base. See **pages B-106-B-107** for a complete description of the GoldGalv® hardware finish. GoldGalv® hardware will be furnished if no other finish is specified.

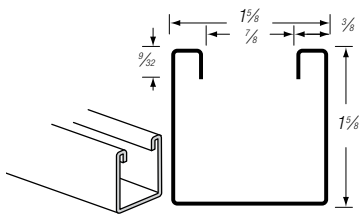

**A-1200**

Channel available in Solid, Half Slot, Punched, Slotted and Knockout configurations.  
Wt./Ft. 1.90 lbs.

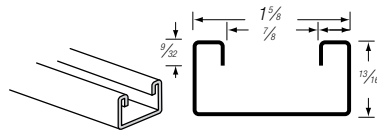

**B-1200**

Channel available in Solid, Half Slot, Punched and Slotted configurations.  
Wt./Ft. 1.28 lbs.

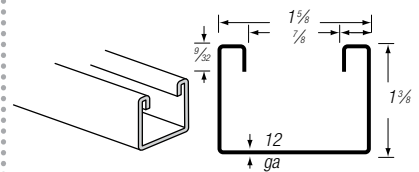

**C-1200**

Channel available in Solid, Half Slot and Punched configurations.  
Wt./Ft. 1.70 lbs.

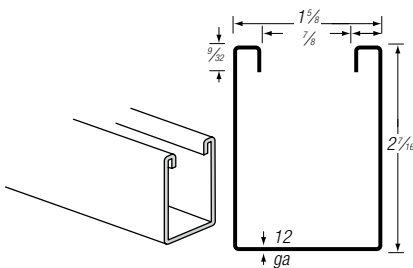

**E-1200**

Channel available in Solid, Half Slot and Punched configurations.  
Wt./Ft. 2.47 lbs.

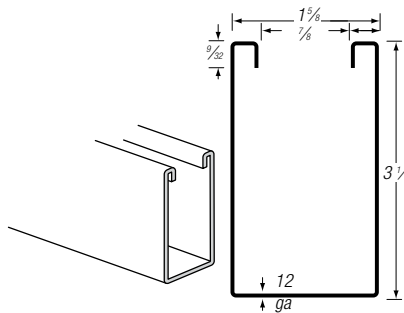

**H-1200**

Channel available in Solid, Half Slot and Punched configurations.  
Wt./Ft. 3.05 lbs.

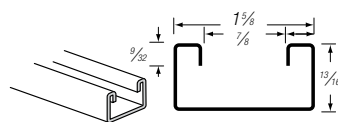

**B-1400**

Channel available in Solid, Half Slot, Punched and Slotted configurations.  
Wt./Ft. 0.90 lbs.

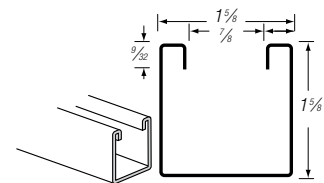

**A-1400**

Channel available in Solid, Half Slot, Punched, Slotted and Knockout configurations.  
Wt./Ft. 1.40 lbs.

## Channels

### Superstrut® Channels — Welding Combinations

All Superstrut® Channels are available in a variety of combinations — some are shown here.

Multiple channels are spot welded on 3" centers.

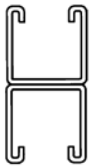

2\*

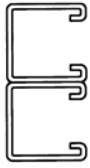

2-A



2-B

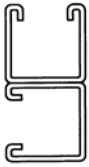

2-C

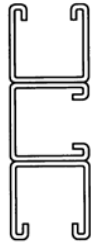

3-A



3-B

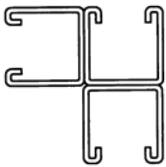

3-C

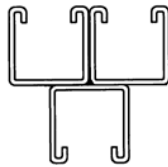

3-D

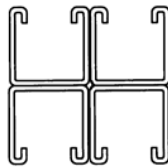

4

#### How to Order

10 and 20 ft. lengths — steel. Special lengths may be ordered.

Replace the 3 last digits of the regular channel catalog number with the designation of the desired combination.

#### Examples:

Two A-1200 channels back to back are ordered as A-1202.  
Two A-1200 channels back to side are ordered as A-1202-C.

Specify desired finish or material.

\*\*"A" and "B" Series back-to-back combinations are joined using Thomas & Betts' steel rivet joining process. The riveted channel is offered in standard GoldGalv®, stainless steel, painted, pre-galvanized and hot-dip galvanized finishes.

### Hole Configurations Half-Slot Channel

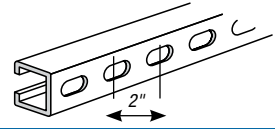

CAT. NO.	DIM. (IN.)	GA.	STD. CTN.
A-1200-HS	1½ x 1½	12	*
B-1200-HS	1½ x 1⅜	12	*
C-1200-HS	1½ x 1½	12	500
E-1200-HS	1½ x 2⅞	12	500
H-1200-HS	1½ x 3¼	12	*
A-1400-HS	1½ x 1½	14	*
B-1400-HS	1½ x 1⅜	14	500

⅜" x 1⅞" slots on 2" centers.

\* Standard lengths 10 ft. and 20 ft. for standard cartons.

Please consult your local T&B representative.

### Slotted Channel

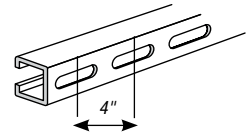

CAT. NO.	DIM. (IN.)	GA.	STD. CTN.
A-1200-S	1½ x 1½	12	*
B-1200-S	1½ x 1⅜	12	*
A-1400-S	1½ x 1½	14	*
B-1400-S	1½ x 1⅜	14	*

⅞" x 3" slots on 4" centers.

\* Standard lengths 10 ft. and 20 ft. for standard carton.

Please consult your local T&B representative.

### Punched Channel

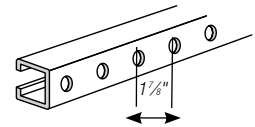

CAT. NO.	DIM. (IN.)	GA.	STD. CTN.
A-1200-P	1½ x 1½	12	500
B-1200-P	1½ x 1⅜	12	500
H-1200-P	1½ x 1⅜	12	500
A-1400-P	1½ x 1½	14	500
B-1400-P	1½ x 1⅜	14	500

⅞" holes on 1½" centers.

Available in 10 & 20 ft. lengths.

### Channel with Knockouts

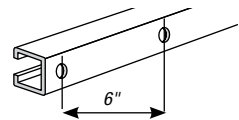

CAT. NO.	DIM. (IN.)	GA.	STD. CTN.
A-1200-KO	1½ x 1½	12	*
A-1400-KO	1½ x 1½	14	*

KO for ½" conduit.

Please consult your local T&B representative.

Standard Finish — GoldGalv® brand.

## Threaded Products and Hardware

### Trapnut® Strut Fastener

The unique scissor action of the Trapnut® Strut Fastener closes at any desired position on the threaded rod. Once closed, precision threads trap the threaded rod for a sturdy hold that can be adjusted up or down for fine-tune positioning. While the versatile Trapnut has a locking pin that holds it in the desired position, it can also be removed and reused.



Standard method using nuts and washers.



New method using Trapnut® Strut Fastener.

Unlike a hex nut, there is no need to thread the Trapnut® from either end of the rod, saving valuable time on the job. While the Trapnut® Strut Fastener is a time-saver for new construction, it is invaluable for retro-fit applications. Rather than disassembling an existing trapeze to run additional conduit above it, the Trapnut® fastener can be clamped between the existing trapeze and the beam clamp for a speedy retro-fit solution. It's ideal for applications where the rod ends are not accessible.

The Trapnut® fastener has a sturdy steel construction that is load bearing, so you can be confident of a solid installation. And, the Trapnut® fastener functions as a hex nut, square washer and flat washer combined, so there are fewer parts to keep up with on the job.



CAT. NO. H 122 3/8  
Trapnut® Strut  
Fastener GoldGalv®



CAT. NO. H 122 3/8 EG  
Trapnut® Strut  
Fastener SilverGalv®

**NEW!**

ELECTRICAL  
Contracting Products  
2006 INNOVATION  
AWARD WINNER



#### Easy to Install



#### 1 Hold in the open position.

- No need to thread the Trapnut® fastener from either end of the rod — saving valuable time
- Perfect for retro-fit applications where the rod ends are not accessible



#### 2 Insert the bottom plate on the rod and close the top plate.

- Precision threads trap the threaded rod for a sturdy hold that can be adjusted up or down for fine-tune positioning
- Functions as a hex nut, square washer and flat washer combined



#### 3 Press the pin with pliers.

- Locking pin holds it in the desired position
- Can be removed and reused

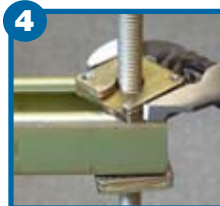

#### 4 Tighten to the desired position with pliers.

- Can be adjusted up or down for fine-tuned positioning
- Sturdy steel construction that is load bearing
- Sized to provide custom fit for either 1 1/8" or 1 1/2" strut systems

CAT. NO.	DESCRIPTION	SIZE (IN.)	DESIGN LOAD LBS.	STD. CTN.
H 122 1/4	1/4" GoldGalv®	1/4	150	50
H 122 3/8	3/8" GoldGalv®	3/8	590	50
H 122 1/2	1/2" GoldGalv®	1/2	1,080	50
H 122 1/4 EG	1/4" SilverGalv®	1/4	150	50
H 122 3/8 EG	3/8" SilverGalv®	3/8	590	50
H 122 1/2 EG	1/2" SilverGalv®	1/2	1,080	50
H 122 1/4 SS6	1/4" Type 316 Stainless Steel	1/4	150	50
H 122 3/8 SS6	3/8" Type 316 Stainless Steel	3/8	590	50
H 122 1/2 SS6	1/2" Type 316 Stainless Steel	1/2	1,080	50



## Threaded Products and Hardware

### Handle Retrofit Trapeze Applications with Ease!

#### Trap-Eze™ Connector

The innovative Trap-Eze™ Connector changes a time-consuming retrofit trapeze application into a streamlined process. Using a Trapnut® Strut Fastener, the new Trap-Eze™ Connector can be easily installed above or to the side of an existing assembly, eliminating the need to disassemble and reassemble the trapeze. It is designed for use with shorter strut lengths that can vary in length by as much as an inch, so the strut can be rough cut versus labor-intense precision cuts.

- Easily installs above or to the side of an existing assembly, eliminating the need to disassemble and reassemble the trapeze
- Connectors can be reused upon disassembly of a trapeze
- Designed for either 3/8" and 1/2" threaded rod
- Designed for use with the innovative Trapnut® Strut Fastener, which can take up to 43% less time than standard nuts and washers on retrofit trapeze applications
- View window provides safety zone for strut length

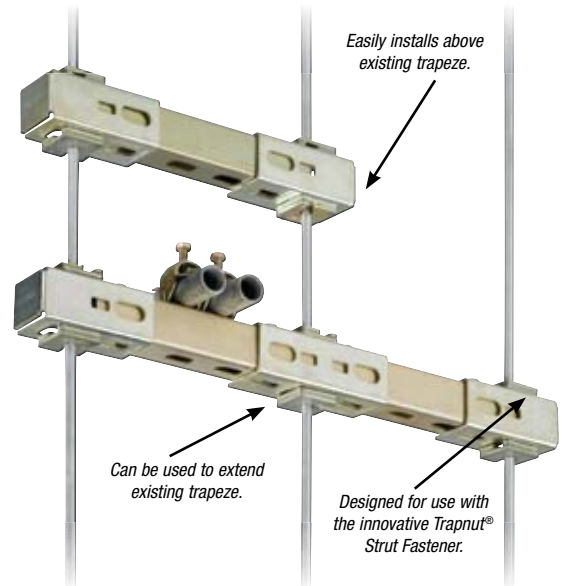

View window provides strut length safety zone for rough cuts versus precision cuts.



Unique safety slot maintains bracket position on threaded rod and prevents disengagement of the trapeze system.

CAT. NO.	DESCRIPTION	STD. CTN.
<b>For Superstrut® or other 1 1/4" Strut</b>		
AB221	Trap-Eze™ End Connector GoldGalv®	20
AB222	Trap-Eze™ Mid Connector GoldGalv®	10
AB221EG	Trap-Eze™ End Connector SilverGalv®	20
AB222EG	Trap-Eze™ Mid Connector SilverGalv®	10
<b>For 1 1/2" Kindorf Channels</b>		
B998	Trap-Eze™ End Connector Galv-Krom®	20
B999	Trap-Eze™ Mid Connector Galv-Krom®	10
B998EG	Trap-Eze™ End Connector SilverGalv®	20
B999EG	Trap-Eze™ Mid Connector SilverGalv®	10

#### Square Washer



AB-241

CAT. NO.	BOLT SIZE (IN.)	STD. CTN.
AB-241-1/4	1/4	100
AB-241-5/16	5/16	100
AB-241-3/8	3/8	100
AB-241-1/2	1/2	100
AB-241-5/8	5/8	100
AB-241-3/4	3/4	50

#### Located Square Washer



AB-241L

CAT. NO.	BOLT SIZE (IN.)	STD. CTN.
AB-241L-1/4	1/4	100
AB-241L-5/16	5/16	100
AB-241L-3/8	3/8	100
AB-241L-1/2	1/2	100
AB-241L-5/8	5/8	100

## Threaded Products and Hardware

### Channel Nuts

Superstrut® channel nuts are manufactured from mild steel and are case hardened.

#### Design Data

Superstrut® self-aligning channel nuts are designed to provide resistance to pull out and resistance to side slip in excess of the full strength of the channels with which they are used. The extreme resistance to side slip results from the unique design of the alternate teeth, spaced and designed to develop a wedging action that increases with pressure or load.

#### Load Ratings for 1/4", 3/8" and 1/2" Strut Nuts used in Superstrut®

CHANNEL NUT SIZES (IN.)	SLIP TEST RATING	PULL TEST RATING
1/4	300	500
3/8	750	1,000
1/2	1,200	2,000

*If connections will be subjected to dynamic or seismic loading conditions, contact the factory for design assistance.*

1. All ratings have safety factor of 3 applied.
2. Load ratings are for Static Applications.

### UC-100 Universal Cone Nut

Eliminates the inventory and installation hassles of conventional spring nuts. Fits all 1 1/2" channel, regardless of depth, with a simple twist of your thumb. Pliable nylon cone secures the nut in place through the entire range of construction site temperatures.

#### Screw Threads

THREAD SIZE (IN.)	1/4	3/8	1/2
THREADS PER INCH	20	16	13
DESIGN TORQUE (FT.-LBS.)	6	19	50

*Standard Finish – GoldGalv®, unless otherwise stated.*

All threaded products are American Standard thread, free fit class 2. GoldGalv® hardware finish is standard for all Superstrut® products. This is a multi-process finish of electro-plated zinc, followed by gold-colored trivalent chromium to give excellent corrosion resistance and a superior paint base. See **pages B-106–B-107** for a complete description of the GoldGalv® hardware finish.

**Note:** Standard Spring and Springless Nuts are supplied with a silver electro-galvanized (EG) finish. These items are not visible in a gold system and are universal with other systems' finishes and colorations.

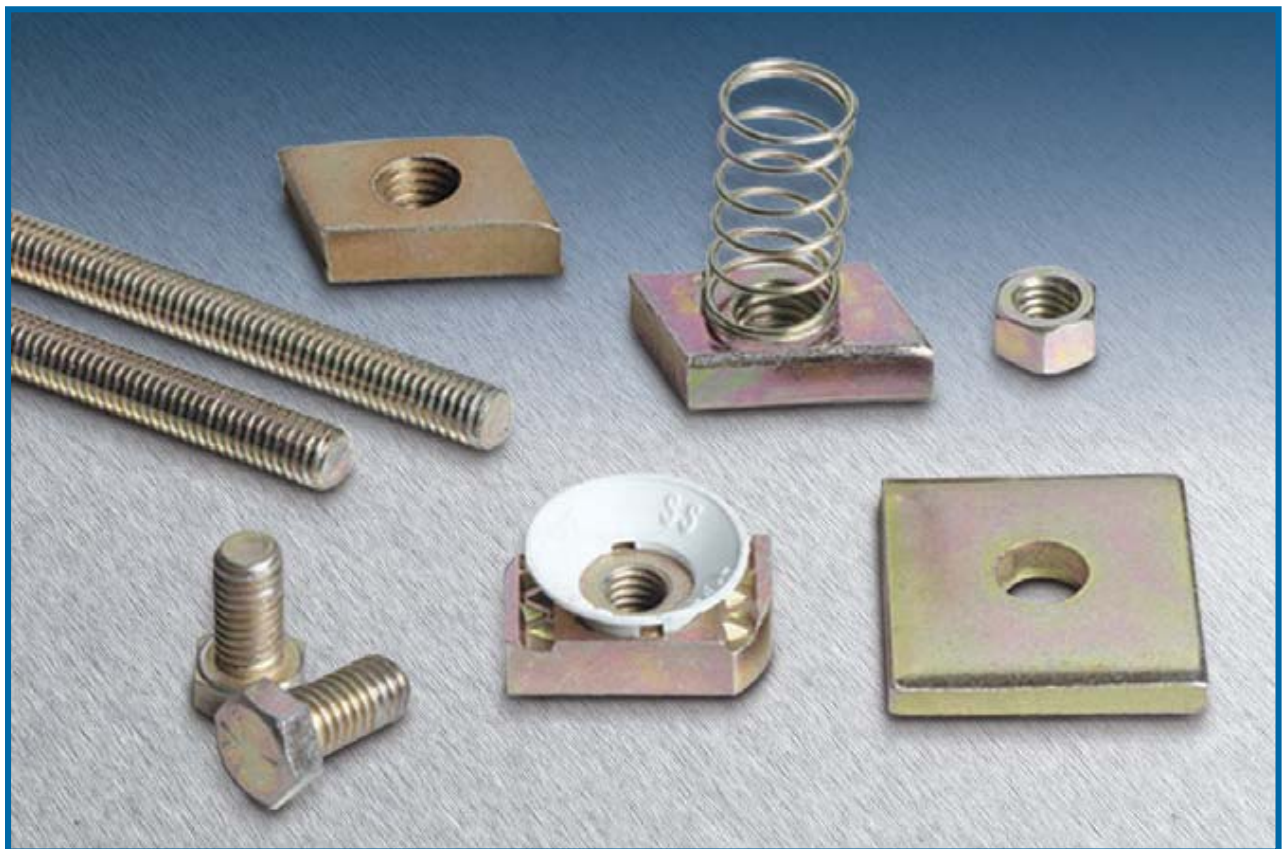

## Threaded Products and Hardware

### A-100 Regular Spring Nut

Sizes: 1/4", 5/16", 3/8", 1/2", 5/8", 3/4" & 7/8"

Nut is square over 1/2" size.  
For all "A" and "C" series channel and inserts.



### E-145 Standard Hex Nut

Sizes: 1/4", 3/8", 1/2", 5/8", 3/4", 7/8" & 1"

GoldGalv® Finish.



### E-151-D Wood Screw Drive

Size A: 1/4"

Size B: 2"

Max. Rec. Load: 100 lbs.

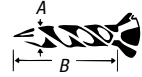

### AB-100 Springless Nut

Sizes: 1/4", 5/16", 3/8", 1/2", 5/8" & 3/4"

Nut is square over 1/2" size.  
For use with all channels.  
Silver Electroplated Finish.

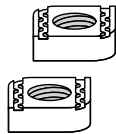

### E-146 Standard Square Nut

Sizes: 1/4", 5/16", 3/8", 1/2" & 5/8"

GoldGalv® Finish.



### ES-142 Seismic Stiffener Nut

Size: ES-142-1/2 x 1 1/2"

Bolt Dia.: 1/2"

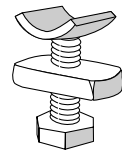

### AC-100 Springless Nut

Sizes: 1/4", 3/8", 1/2", 5/8" & 3/4"

Nut is square over 1/2" size.  
For all "A", "C", "E" and "H" series channel and inserts.

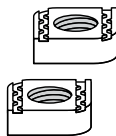

### E-147 Flat Steel Washer

Sizes: 1/4", 5/16", 3/8", 1/2", 5/8", 3/4" & 7/8"

GoldGalv® Finish.



### ES-145 Swivel Nut and Jam Nut Combinations

Sizes: 3/8" & 1/2"

GoldGalv® Finish.

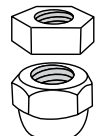

### B-100 Short Spring Nut

Sizes: 1/4", 5/16", 3/8" & 1/2"

Nut is square over 1/2" size.  
For all "B" series channel and inserts.

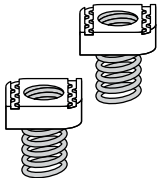

### E-148 Lock Washer

Sizes: 1/4", 3/8", 1/2" & 5/8"

GoldGalv® Finish.



### H-100 Long Spring Nut

Sizes: 3/8", 1/2" & 5/8"

Nut is square over 1/2" size.  
For all "E" and "H" series channel and inserts.

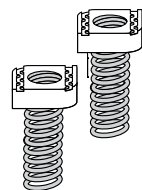

### CM-100 Nylon Cone Nut

Sizes: 1/4", 3/8" & 1/2"

For all 1 1/8" channel.

\*Will not fit "B" series channel.

GoldGalv® Finish



### E-149 Slotted Hex Indented Head Machine Screw

Sizes: 1/4" x 3/4", 1/4" x 1", 5/16" x 1 1/4" & 3/8" x 1 1/4"

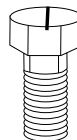

### UC-100 Universal Nylon Cone Nut

Sizes: 1/4", 3/8" & 1/2"

For all 1 1/8" & 1 1/2" channels.  
May be used with ALL strut depths. Can be used for CM-100, A-100, B-100 & AB-100 Series.

GoldGalv® Finish.

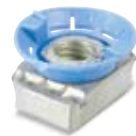

### E-142 Hex Head Cap Screw

Sizes: 1/4" x 1", 1/4" x 1 1/2", 3/8" x 1", 3/8" x 1 1/2", 1/2" x 1 5/16" & 1/2" x 1 1/2"

See price sheet for additional sizes.



### E-150-S Lag Bolt Screw

Size: 3/8" & 1/2"

Drill Size: 1/4" & 1 1/32"

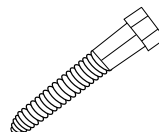

## Threaded Products and Hardware

### Fender Washer

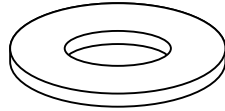

EF-147

CAT. NO.	SIZE (IN.)	DIA. (IN.)	HOLE STD. (IN.)	STD. CTN.
EF147 1/4	1/4	1 1/4	3/16	100
EF-147-3/8	3/8	1 1/2	7/16	100
EF-147-1/2	1/2	2	9/16	100

### Springless Stud Nut

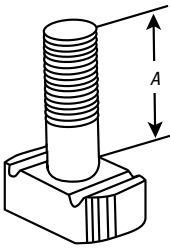

A-177 to A-180

CAT. NO.	BOLT DIA. (IN.)	LENGTH A (IN.)	STD. CTN.
A177 1/4 1	1/4	1	50
A-177-1/4 X 1-1/4	1/4	1 1/4	250
A-179-3/8 X 1	3/8	1	250
A-179-3/8 X 1-1/4	3/8	1 1/4	50
A-180-1/2 X 1*	1/2	1	250
A-180-1/2 X 1-1/4*	1/2	1 1/4	250

\* Cannot be used with "B" Series channel.

### Regular Spring Stud Nut

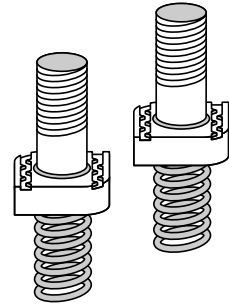

A-182 to A-185

CAT. NO.	BOLT DIA. (IN.)	LENGTH A (IN.)	STD. CTN.
A182 1/4 1	1/4	1	250
A-182-1/4 X 1-1/4	1/4	1 1/4	250
A-184-3/8 X 1	3/8	1	50
A-184-3/8 X 1-1/4	3/8	1 1/4	50
A-185-1/2 X 1	1/2	1	50
A-185-1/2 X 1-1/4	1/2	1 1/4	50

For all "A" and "C" series channels.

Standard Finish – GoldGalv®, unless otherwise stated.

### Swivel Eye

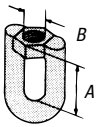

E-120

CAT. NO.	A (IN.)	B (IN.)	DESIGN LOAD LBS.	STD. CTN.
E120 3/8	1 3/8	3/8	1,000	25
E120 1/2	1 1/2	1/2	1,800	25

### Swivel Joint

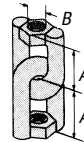

E-122

CAT. NO.	A (IN.)	B (IN.)	DESIGN LOAD LBS.	STD. CTN.
E122 3/8	1 3/8	3/8	1,000	25
E-122-1/2	1 1/2	1/2	1,800	10

Standard Finish – GoldGalv®, unless otherwise stated.

### Swivel Eye with Stud

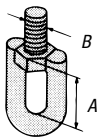

E-130

CAT. NO.	A (IN.)	B (IN.)	DESIGN LOAD LBS.	STD. CTN.
E130 3/8	1 3/8	3/8	1,000	25
E-130-1/2	1 1/2	1/2	1,800	25

### Swivel Joint with Stud

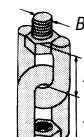

E-131

CAT. NO.	A (IN.)	B (IN.)	DESIGN LOAD LBS.	STD. CTN.
E131 3/8	1 3/8	3/8	1,000	25
E-131-1/2	1 1/2	1/2	1,800	10

Standard Finish – GoldGalv®, unless otherwise stated.

## Threaded Products and Hardware

### E-151 — Coach Screw Rod

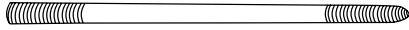

- Black available upon request
- Machine-threaded opposite end, carbon steel
- Order by Cat. No., rod size and rod length

CAT. NO.	ROD SIZE (IN.)	STANDARD ROD LENGTHS	STD. CTN.
E-151-3/8	3/8"	4, 6, 8, 10, 12	100
E-151-1/2	1/2"	4, 6, 8, 10	100

### H104-EG Hanger Rod, Continuous Thread — SilverGalv®



CAT. NO.	SIZE	WT./LBS. PER 100 PCS.
H104 1/4X6-EG		73
H104 1/4X10-EG	1/4"-20	124
H104 1/4X12-EG		148
H104 3/8X6-EG		172
H104 3/8X10-EG	3/8"-16	293
H104 3/8X12-EG		348
H104 1/2X6-EG		313
H104 1/2X10-EG	1/2"-13	530
H104 1/2X12-EG		648
H104 5/8X6-EG		510
H104 5/8X10-EG	5/8"-11	850
H104 5/8X12-EG		1,020

Suffix indicates rod size and length.

### H104 Hanger Rod, Continuous Thread — GoldGalv®



H-104 Series Rod



CAT. NO.	SIZE	WT./LBS. PER 100 PCS.
H104 1/4X6		73
H104 1/4X10	1/4"-20	124
H104 1/4X12		148
H104 3/8X6		172
H104 3/8X10	3/8"-16	293
H104 3/8X12		348
H104 1/2X6		313
H104 1/2X10	1/2"-13	530
H104 1/2X12		648
H104 5/8X6		510
H104 5/8X10	5/8"-11	850
H104 5/8X12		1,020

Suffix indicates rod size and length.

### Standard Rod Coupling

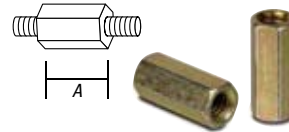

CAT. NO.	ROD SIZE (IN.)	A (IN.)	STD. CTN.
H119-1/4	1/4"	7/8"	50
H119-5/16	5/16"	7/8"	50
H119-3/8	3/8"	1 1/8"	50
H119-1/2	1/2"	1 1/4"	50
H119-5/8	5/8"	2 1/8"	50
H119-3/4	3/4"	2 1/4"	50
H119-7/8	7/8"	2 1/2"	50
H119-1	1"	2 3/4"	50

Standard Finish — GoldGalv®, unless otherwise stated.

### Reducing Rod Coupling

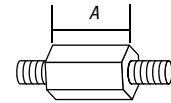

CAT. NO.	ROD SIZE (IN.)	A (IN.)	STD. CTN.
H119-1/4X3/8	1/4"-3/8"	1 1/2"	50
H119-3/8X1/2	3/8"-1/2"	1 1/4"	50
H119-1/2X5/8	1/2"-5/8"	1 1/4"	50
H119-5/8X3/4	5/8"-3/4"	1 1/2"	50
H119-3/4X7/8	3/4"-7/8"	1 1/4"	50

Standard Finish — GoldGalv®, unless otherwise stated.

### U-571, U-572 Conduit Clamp

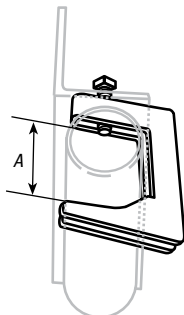

U-571, U-572

CAT. NO.	CONDUIT SIZE (IN.)	MAX. FLANGE THICKNESS (IN.)	DIM. A (IN.)	STD. CTN.
U-571	1/2"	1	1 3/4"	25
U-571	3/4"	3/4"	1 3/4"	25
U-571	1"	1/2"	1 3/4"	25
U-572	3/4"	1 1/2"	2 1/2"	25
U-572	1"	1 1/4"	2 1/2"	25
U-572	1 1/4"	1	2 1/2"	25
U-572	1 1/2"	5/8"	2 1/2"	25

Standard Finish — GoldGalv® brand.

For attaching 1/2" thru 1 1/2" conduit to beam, channel, angle or column. Secures conduit to the support parallel or at right angles to it.

5/16" set screw, 12 ga. material.

## Fittings and Brackets

### Fittings and Brackets — Series 200



#### Material

Superstrut® fittings and brackets are manufactured from hot rolled carbon steel.

#### Dimensions

The following standard dimensions apply to all fittings except as indicated on the individual drawings.

- Hole spacing:  $\frac{1}{16}$ " from end of fittings
- Hole spacing:  $1\frac{1}{8}$ " centers
- Hole size:  $\frac{9}{16}$ " diameter
- Material:  $1\frac{1}{8}$ " wide
- Material:  $\frac{1}{4}$ " thickness

#### Application Instructions

Parts drawings illustrate a typical use for the fitting, and in many cases other uses for the part are appropriate.

#### Design Data

Ratings vary when used with 12 or 14 gauge channel and are shown for each channel material.

GoldGalv® hardware finish is standard for all Superstrut® products. This is a multi-process finish of electro-plated zinc, followed by gold-colored trivalent chromium to give excellent corrosion resistance and a superior paint base. See **pages B-106-B-107** for complete description of the GoldGalv® hardware finish. GoldGalv® hardware will be furnished if no other finish is specified.

#### Nuts and Bolts Required

Unless otherwise noted, nuts and bolts for use with fittings and brackets should be ordered separately.

The standard bolt for the  $\frac{9}{16}$ " hole is a  $\frac{1}{2}$ " hex head cap screw  $1\frac{5}{16}$ " long. The  $1\frac{5}{16}$ " length may be used with all series channel.

Standard Finish — GoldGalv®, unless otherwise stated.

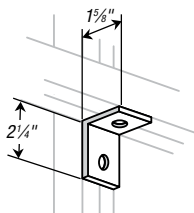

CAT. NO. AB201

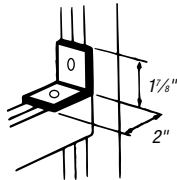

CAT. NO. AB202

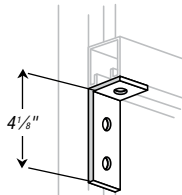

CAT. NO. AB203

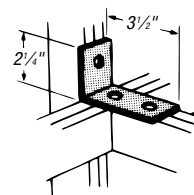

CAT. NO. AB204

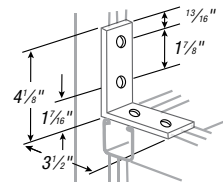

CAT. NO. AB205

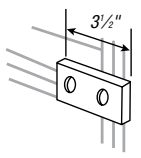

CAT. NO. AB206

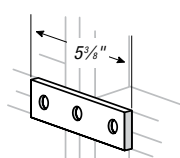

CAT. NO. AB207

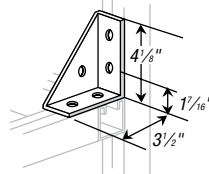

CAT. NO. AB213

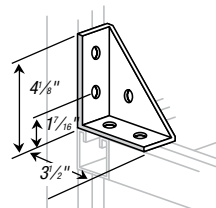

CAT. NO. AB214

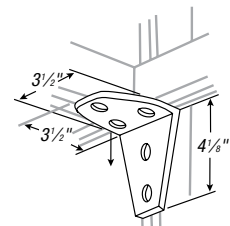

CAT. NO. AB216

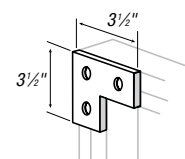

CAT. NO. AB219

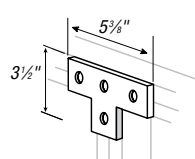

CAT. NO. AB220

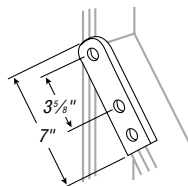

CAT. NO. AB240

#### Standard Dimensions

- Hole Spacing:  $\frac{1}{16}$ " From End
- Hole Spacing:  $1\frac{1}{8}$ " Centers
- Hole Size:  $\frac{9}{16}$ " Diameter
- Material:  $1\frac{1}{8}$ " Width
- Material:  $\frac{1}{4}$ " Thick

Standard Finish — GoldGalv®, unless otherwise stated.  
Add EG suffix for SilverGalv® Finish

## Fittings and Brackets

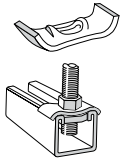

**CAT. NO. AB-242**  
For use with either 3/8" or 1/2" hanger rod

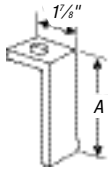

**CAT. NO. AB252**

CAT. NO.	A (IN.)	STD. CTN.
AB252 1	3 7/8"	10
AB252 2	5 7/8"	10
AB252 3	7 7/8"	10
AB252 4	9 7/8"	10

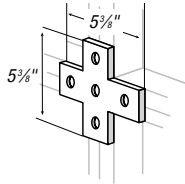

**CAT. NO. AB253**

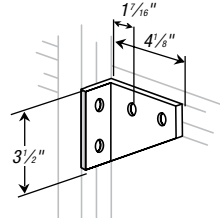

**CAT. NO. AB254 L**

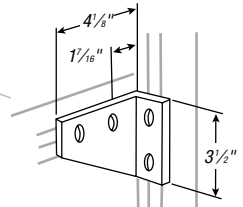

**CAT. NO. AB254 R**

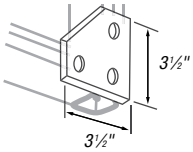

**CAT. NO. AB255**

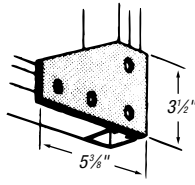

**CAT. NO. AB257**

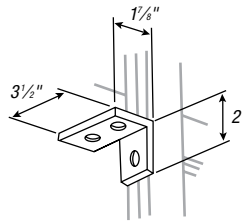

**CAT. NO. AB260 L**

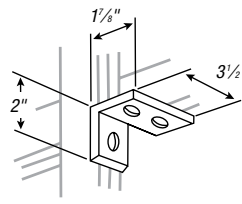

**CAT. NO. AB260 R**

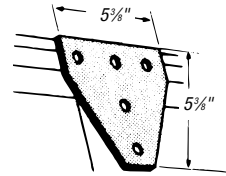

**CAT. NO. AB261**

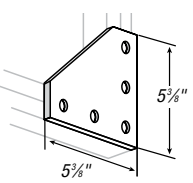

**CAT. NO. AB263**

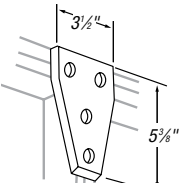

**CAT. NO. AB265**

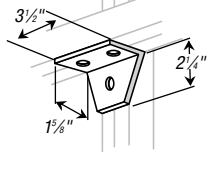

**CAT. NO. AB274**

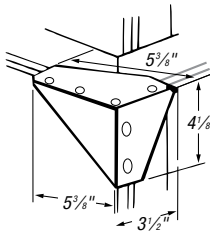

**CAT. NO. AB284 L**

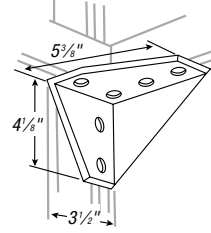

**CAT. NO. AB284 R**

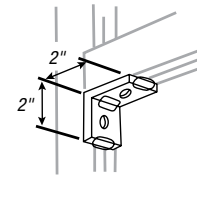

**CAT. NO. AB299**

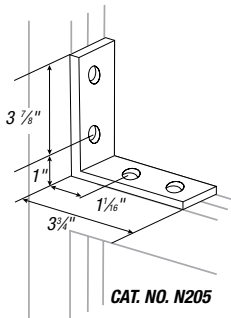

**CAT. NO. N205**

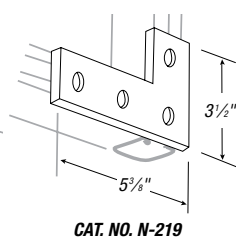

**CAT. NO. N-219**

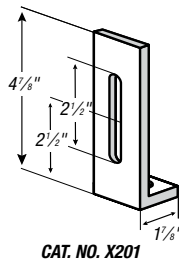

**CAT. NO. X201**

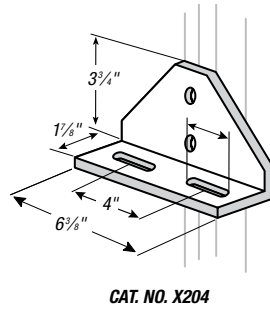

**CAT. NO. X204**  
Slot size is 9/16" x 1 1/2"

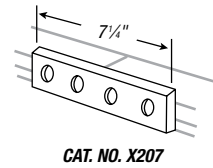

**CAT. NO. X207**

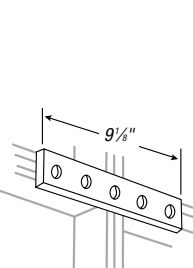

**CAT. NO. X208**

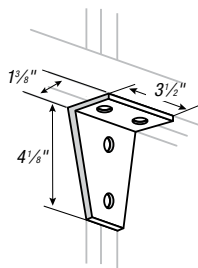

**CAT. NO. X289**

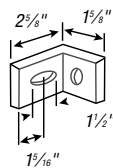

**CAT. NO. X299**

### Standard Dimensions

- Hole Spacing: 1 1/8" From End
- Hole Spacing: 1 1/8" Centers
- Hole Size : 9/16" Diameter
- Material: 1 1/2" Width
- Material: 1/4" Thick

Standard Finish — GoldGalv®, unless otherwise stated.  
Add EG suffix for SilverGalv® Finish

## Fittings and Brackets

### Z Shape Fittings

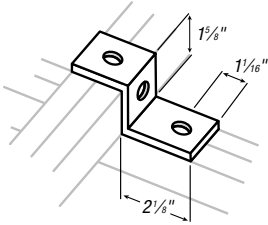

**CAT. NO. A209**  
For attaching "A" series channel.

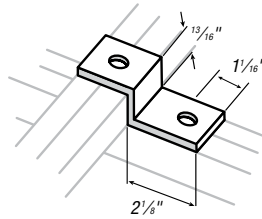

**CAT. NO. B209**  
For attaching "B" series channel.

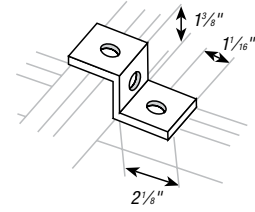

**CAT. NO. C209**  
For attaching "C" series channel.

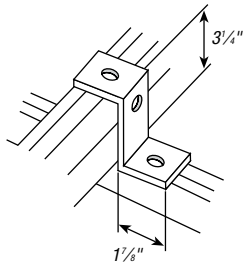

**CAT. NO. CZ209**  
For attaching "A" back to back.

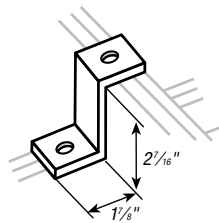

**CAT. NO. EZ209**  
For attaching "E" series channel.

#### ..... Standard Dimensions .....

- Hole Spacing: 1 1/16" From End
- Hole Spacing: 1 1/8" Centers
- Hole Size: 1" Diameter
- Material: 1 1/2" Width
- Material: 1/4" Thick

Standard Finish — GoldGalv®, unless otherwise stated.  
Add EG suffix for SilverGalv® Finish

### Wing Shape Fittings

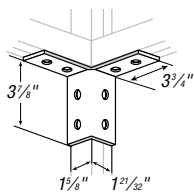

**CAT. NO. A217**

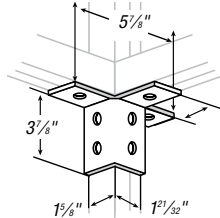

**CAT. NO. A218**

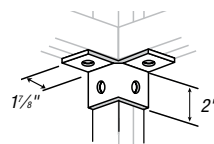

**CAT. NO. AW204**

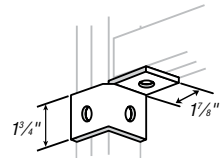

**CAT. NO. AW205 L**

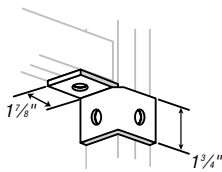

**CAT. NO. AW205-R**

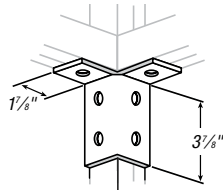

**CAT. NO. AW214**

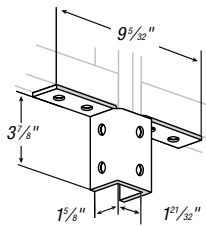

**CAT. NO. AW219**

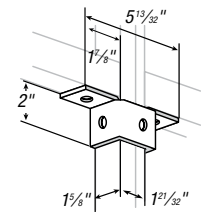

**CAT. NO. AW220**

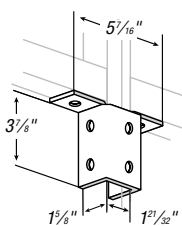

**CAT. NO. AW224**

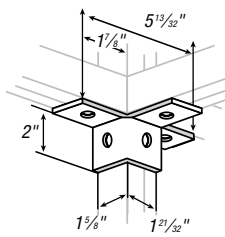

**CAT. NO. AW226**

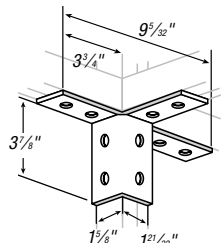

**CAT. NO. AW228**

#### ..... Standard Dimensions .....

- Hole Spacing: 1 1/16" From End
- Hole Spacing: 1 1/8" Centers
- Hole Size: 1" Diameter
- Material: 1 1/2" Width
- Material: 1/4" Thick

Standard Finish — GoldGalv®, unless otherwise stated.  
Add EG suffix for SilverGalv® Finish



## Fittings and Brackets

### U Shape Fittings

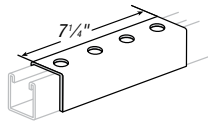

**CAT. NO. A208**  
Does not include strut nut or bolts. For "A" series channel.

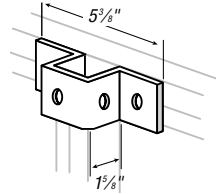

**CAT. NO. A210**  
For attaching "A" series channel

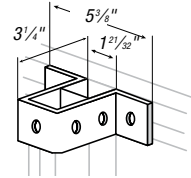

**CAT. NO. A211**  
For attaching "A" series channel.

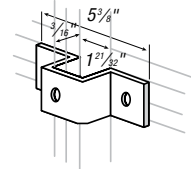

**CAT. NO. B210**

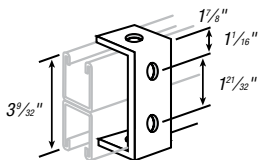

**CAT. NO. AB245**

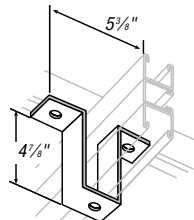

**CAT. NO. AN211**

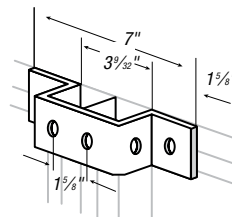

**CAT. NO. A212**

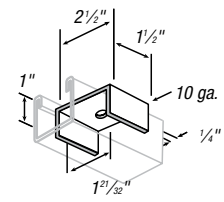

**CAT. NO. AB-288**

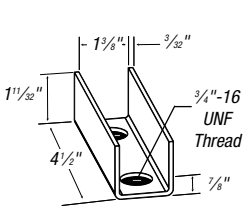

**CAT. NO. A-213**

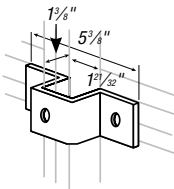

**CAT. NO. C210**  
For attaching "C" series channel.

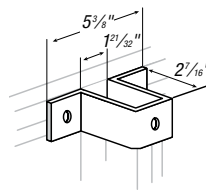

**CAT. NO. E210**  
For attaching "E" series channel.

#### Standard Dimensions

- Hole Spacing: 1 1/16" From End
- Hole Spacing: 1 1/8" Centers
- Hole Size: 1" Diameter
- Material: 1 5/8" Width
- Material: 1/4" Thick

Standard Finish – GoldGalv®, unless otherwise stated.  
Add EG suffix for SilverGalv® Finish

### Angular Fittings

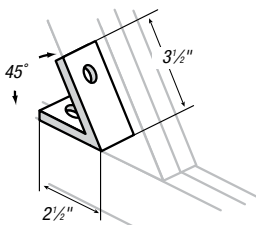

**CAT. NO. AB225**

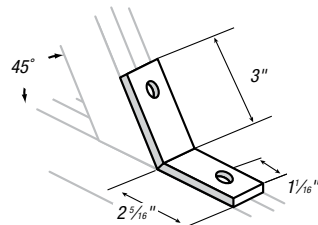

**CAT. NO. AB227**

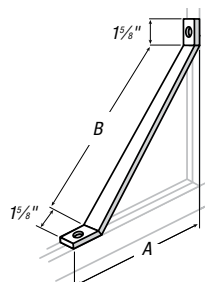

**CAT. NO. AB-239**

CAT. NO.	A (IN.)	B (IN.)	STD. CTN.
AB239 1	7 1/16	8 1/2	15
AB-239-2	13 3/4	17	10
AB-239-3	19 3/4	25 1/2	10

Standard Finish – GoldGalv®, unless otherwise stated.  
Add EG suffix for SilverGalv® Finish

## Fittings and Brackets

### Post Bases

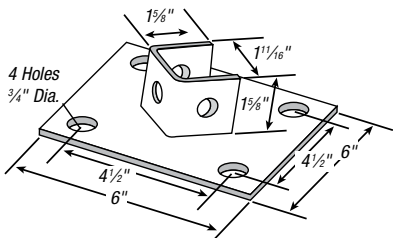

CAT. NO. AP-231

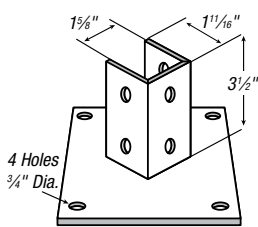

CAT. NO. AP-232

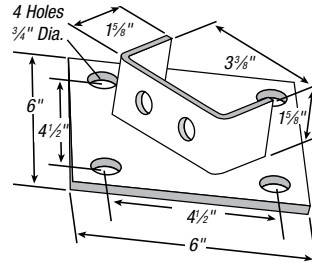

CAT. NO. AP-234

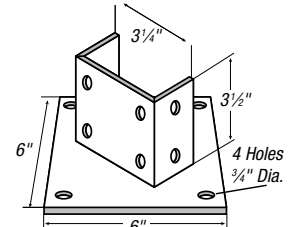

CAT. NO. AP-235

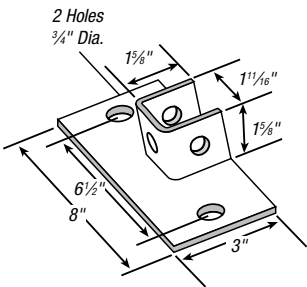

CAT. NO. AP-231FL

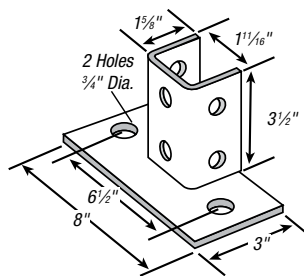

CAT. NO. AP-232FL

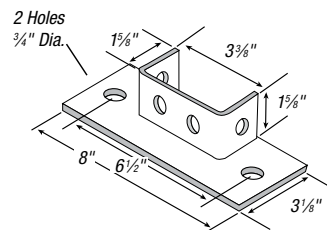

CAT. NO. AP-234FL

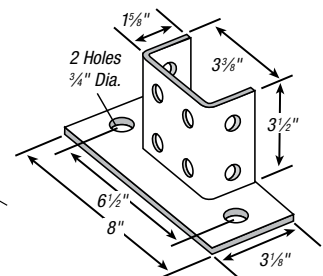

CAT. NO. AP-235FL

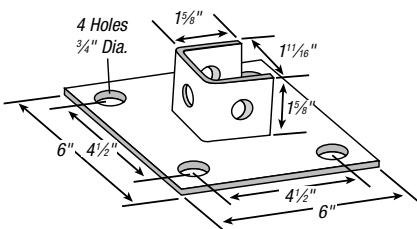

CAT. NO. AP-231SQ

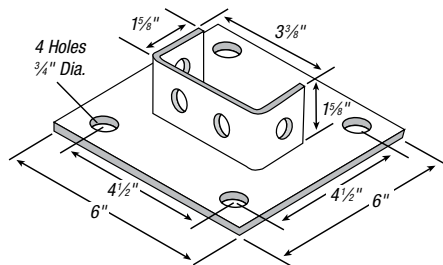

CAT. NO. AP-234SQ

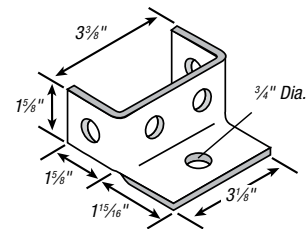

CAT. NO. AW-239

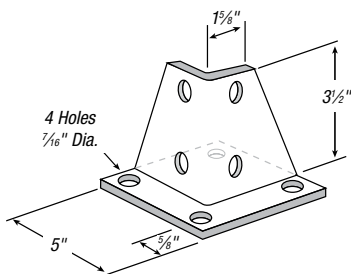

CAT. NO. AP-206

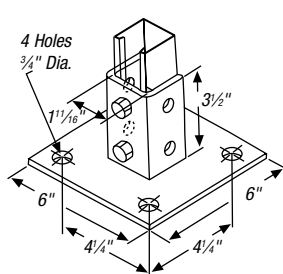

CAT. NO. AP-232SQ

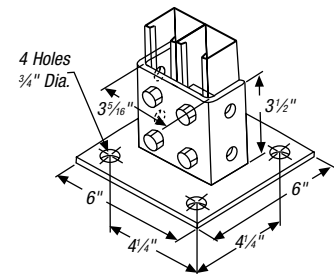

CAT. NO. AP-235SQ

Standard Finish — GoldGalv®, unless otherwise stated.  
Add EG suffix for SilverGalv® Finish

## Fittings and Brackets

### Special Application Fittings

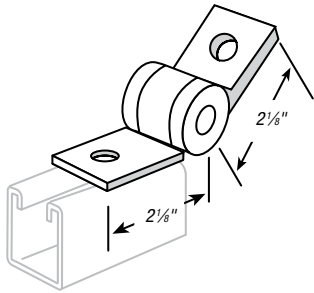

CAT. NO. Q202

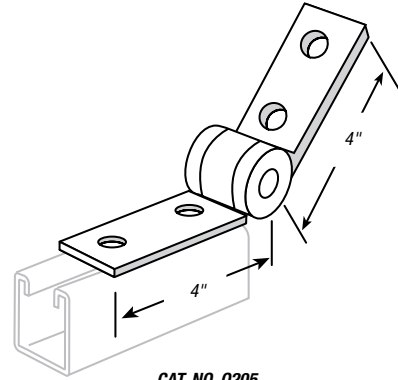

CAT. NO. Q205

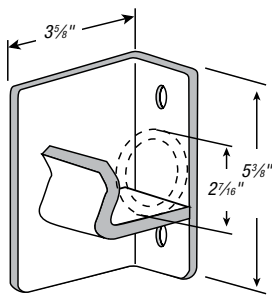

CAT. NO. Q255  
For 2" standard pipe.  
Load 1,500 lbs.

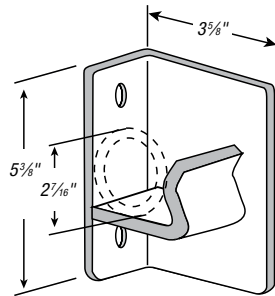

CAT. NO. Q256  
For 2" standard pipe.  
Load 1,500 lbs.

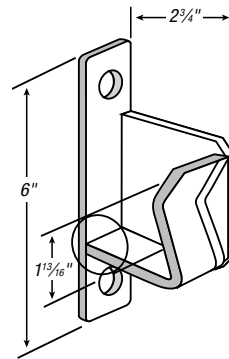

CAT. NO. Q253  
For 1 1/4" standard pipe.  
Load 1,500 lbs.

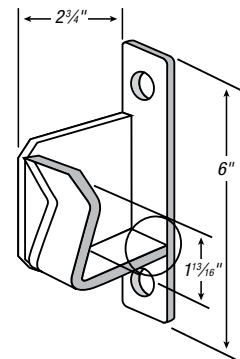

CAT. NO. Q254  
For 1 1/4" standard pipe.  
Load 1,500 lbs.

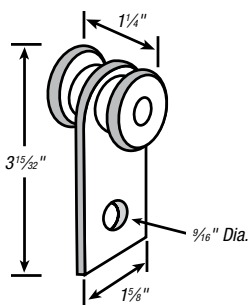

CAT. NO. TR292  
Frictionless needle bearings.  
Design load: 500 lbs.  
Safety factor of 5.

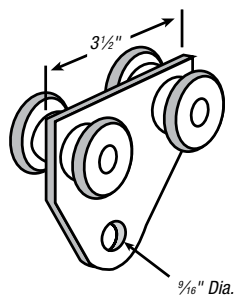

CAT. NO. TR294  
Frictionless needle bearings.  
Design load: 1,000 lbs.  
Safety factor of 5.

#### Standard Dimensions

- Hole Spacing: 13/16" From End
- Hole Spacing: 1 7/8" Centers
- Hole Size: 9/16" Diameter
- Material: 1 5/8" Width
- Material: 1/4" Thick

Standard Finish – GoldGalv®, unless otherwise stated.  
Add EG suffix for SilverGalv® Finish

## Fittings and Brackets

### Special Application Fittings (continued)

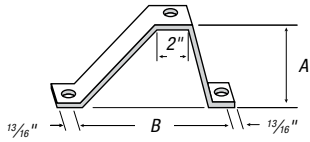

**AN-270**

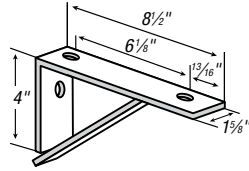

**S204**

Design Uniform Load/lbs.  
A-1,200 650  
A-1,400 500

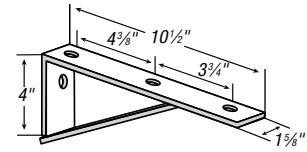

**S205**

Design Uniform Load/lbs.  
A-1,200 650  
A-1,400 500

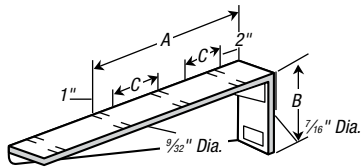

**S-201-L and R**

R as shown — L opposite hand.  
12 ga. steel. Design Uniform Load/lbs.  
A-1,200 250  
A-1,400 200

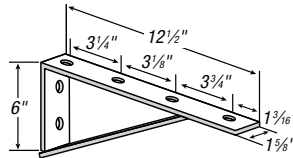

**S217**

Design Uniform Load/lbs.  
A-1,200 750  
A-1,400 650

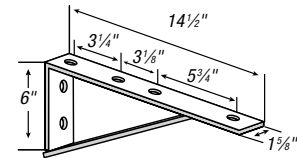

**S218**

Design Uniform Load/lbs.  
A-1,200 750  
A-1,400 650

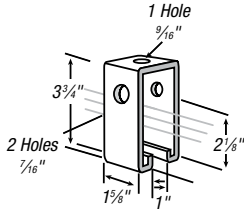

**TS-272**

Track Support  
Requires 3/8" x 2 1/2" bolt and nut (not included).  
Design load: 1,000 lbs.

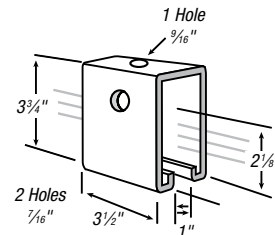

**TS273**

Track Support  
For uses over channel splice. Requires 3/8" x 2 1/2" bolt and nut (not included).  
Design load: 2,000 lbs.

Standard Finish — GoldGalv®, unless otherwise stated.  
Add EG suffix for SilverGalv® Finish

#### Standard Dimensions

- Hole Spacing: 1 3/16" From End
- Hole Spacing: 1 7/8" Centers
- Hole Size: 9/16" Diameter
- Material: 1 1/8" Width
- Material: 1/4" Thick

CAT. NO.	A (IN.)	B (IN.)	C (IN.)	STD. CTN.
S201-L6 or R6	6	1 1/16	3	25
S201-L8 or R8	8	2 1/16	5	25
S201-L10 or R10	10	2 15/16	7	5
S201-L12 or R12	12	3 1/16	3	5
S201-L14 or R14	14	3 15/16	4	5
S201-L16 or R16	16	4 1/16	5	15
S201-L18 or R18	18	4 15/16	6	5
S201-L20 or R20	20	5 1/16	7	10

CAT. NO.	A (IN.)	B (IN.)	STD. CTN.
AN-270-1	2 3/8	6	10
AN-270-2	4 3/8	8	10
AN-270-3	6 3/8	10	10
AN-270-4	8 3/8	12	15
AN-270-5	10 3/8	14	10

## Fittings and Brackets

### Brackets

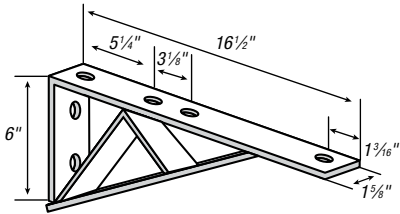

**S222**  
Design Uniform Load/lbs.  
A-1,200 1,000  
A-1,400 750

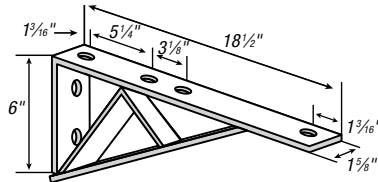

**S226**  
Design Uniform Load/lbs.  
A-1,200 1,000  
A-1,400 750

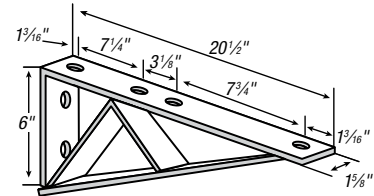

**S236**  
Design Uniform Load/lbs.  
A-1,200 800  
A-1,400 650

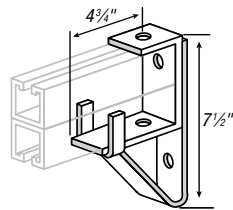

**S248**  
Design Moment  
(channel upright as shown)  
When supported by  
A-1,200 10,800 inch lbs.  
A-1,400 7,550 inch lbs.  
Applies to fitting only, not to the arm.  
For  
A-1,200  
A-1,400

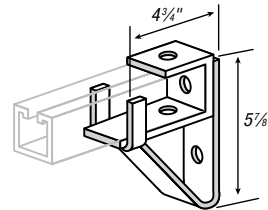

**S247**  
Design Moment  
(channel upright as shown)  
When supported by  
A-1,200 5,250 inch lbs.  
A-1,400 3,650 inch lbs.  
Applies to fitting only, not to the arm.  
For  
A-1,200 B-1,202  
A-1,400 B-1,402

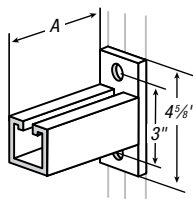

**S-250**  
May be installed inverted with no change in load ratings. Strut section made from half slot channel.  
Sizes: 6", 12", 18" & 24"

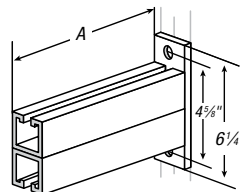

**S-251**  
Strut section made from half slot channel.  
Sizes: 12", 18", 24", 30" & 36"

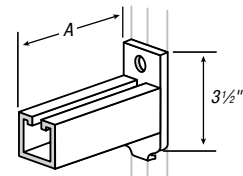

**S-256**  
When installed in inverted position reduce load rating 40%. Strut section made from half slot channel.  
Sizes: 6", 12", 18" & 24"

CAT. NO.	A (IN.)	DESIGN LOAD LBS.	STD. CTN.
S250 6	6	1,500	1
S-250-12	12	800	1
S-250-18	18	550	1
S-250-24	24	400	1

CAT. NO.	A (IN.)	DESIGN LOAD LBS.	STD. CTN.
S-251-12	12	1,650	1
S-251-18	18	1,050	1
S-251-24	24	800	1
S-251-30	30	650	1
S-251-36	36	500	1

CAT. NO.	A (IN.)	DESIGN LOAD LBS.	STD. CTN.
S256 6	6	1,000	1
S-256-12	12	500	1
S-256-18	18	300	1
S-256-24	24	250	1

Standard Finish GoldGalv®, unless otherwise stated.  
Add EG suffix for SilverGalv® Finish

## Concrete Inserts

### Concrete Inserts (Series 300/400)

Standard lengths 10 ft. and 20 ft. length tolerance  $\frac{3}{16}$ ". Assemblies available in any length from 12" to 20 ft. Consult factory.

Insert with end caps and foam filler strip installed.

#### Material:

B-302 and C-302 Insert Channel — 12 ga. steel.

B-804 and C-804 End Caps — 12 ga. steel.

Superstrut® continuous insert channel is cold formed from 12 gauge hot-rolled strip steel in two basic sizes as follows:

#### CAT. NO. B-302

$1\frac{5}{8}$ " x  $1\frac{3}{16}$ " dim.       $\frac{7}{8}$ " slot

#### CAT. NO. C-302

$1\frac{5}{8}$ " x  $1\frac{3}{8}$ " dim.       $\frac{7}{8}$ " slot

#### Finishes

Product is available in GoldGalv® pre-galvanized (PG), hot-dipped galvanized (HDG) and stainless steel (SS). Contact your T&B Sales team for delivery and pricing.

Standard lengths are 10 ft. and 20 ft. Product is supplied with foam filler and end caps to prevent seepage of concrete into channel.

#### Application

For casting into concrete walls, floors or ceilings to provide attachment anywhere along the continuous slot.

#### Design Data

Load ratings as shown have a safety factor of 3 in 3,000 lb. hard rock concrete. Where "good" concrete does not exist, the load ratings shall not apply.

GoldGalv® hardware finish is standard for all Superstrut® products. This is a multi-process finish of electro-plated zinc, followed by gold-colored trivalent chromium to give excellent corrosion resistance and a superior paint base. See pages B-106–B-107 for a complete description of the GoldGalv® hardware finish. GoldGalv® hardware will be furnished if no other finish is specified.

*Standard Finish — GoldGalv®, unless otherwise stated.*

#### Design Load lbs.

2,000 lbs. per foot in 3,000 lbs. hard rock concrete with a safety factor of 2.

**NOTE:** B-302 and C-302 are furnished with:

- A.** Concrete safe tape applied to interior of channel to cover holes.
- B.** Styrene insert between tape and  $\frac{7}{8}$ " continuous opening.
- C.** Two end caps on either side of strut to prevent concrete seepage.

CAT. NO.	DESCRIPTION
B-302*	Insert channel 12 ga. steel — $\frac{13}{16}$ " depth
C-302*	Insert channel 12 ga. steel — $1\frac{3}{8}$ " depth
B804	End cap in B Series Concrete Insert
C-804	End cap in C Series Concrete Insert

\*Add suffix -10 for 10' lengths and -20 for 20' lengths

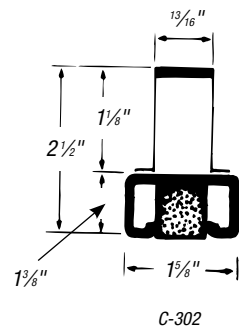
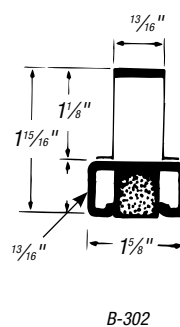
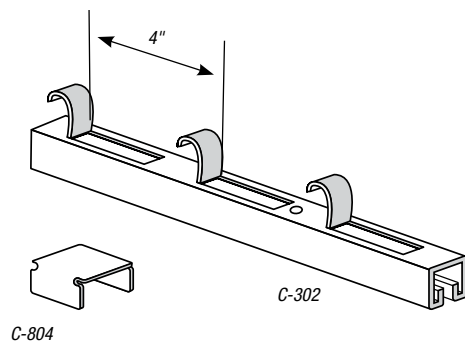
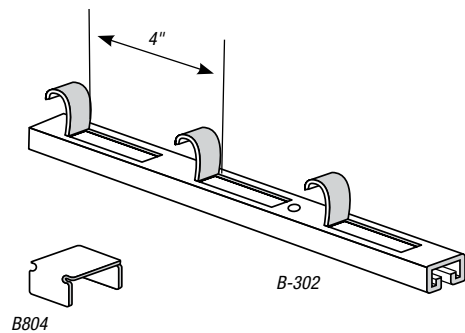
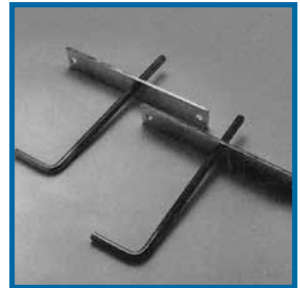
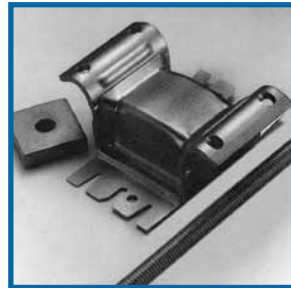

## Concrete Inserts

### 450 — End Cap

CAT. NO.	FOR CHANNEL	X (IN.)	MATERIAL	STD. CTN.
C-450TB	C-1,200	3	12 ga.	100

Does not come in pairs, order number of total pieces required.

Inserts may be assembled from short pieces of channel by use of end caps.

Order closure strip separately.

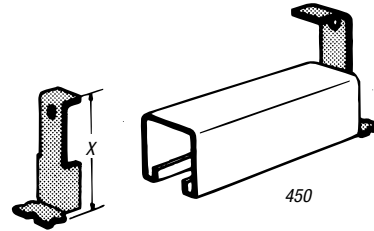

### 452-TB — Spot Insert — Top is Deep Drawn Cup

- An insert with a knockout saves covering the opening. Accommodates hanger rod sizes from 1/4" through 7/8" by means of an AB-102 insert nut
- Design load: 1,350 lbs. in 3,000 lb. hard rock concrete with a safety factor of 3
- Order AB-102 nut separately

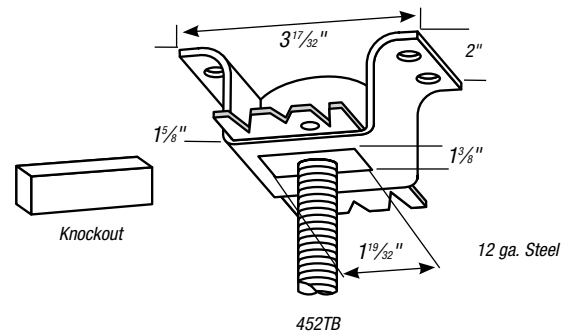

### AB-102 — Unhardened Square Nut

CAT. NO.	SIZE (IN.)	STD. CTN.
AB102 1/4	1/4	50
AB-102-3/8	3/8	100
AB-102-1/2	1/2	100
AB-102-5/8	5/8	50
AB-1002-3/4	3/4	50
AB-102-7/8	7/8	50

For use with Spot Insert Cat. No. 452.

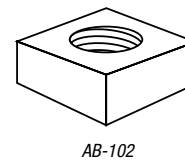

### C475 — Metal Deck Ceiling Bolt

Metal Deck Ceiling Bolts are used with our Figure 123. Rod Couplings ordered separately. Made special to customer order.

**Material:** Steel

**Finish:** Standard Finish — GoldGalv®  
Black (add suffix "-B")  
Electro-Galvanized (add suffix "-EG")

**Ordering:** Specify size, dimension "A", catalog number and finish.

CAT. NO.	WT. EACH	A (IN.)	B (IN.)	C (IN.)	MAX. LOAD (LBS.)
C475 3/8	.75	S	3/8	1	610
C475 1/2	.97	P	1/2	1 1/4	1,130
C475 5/8	1.11	e	5/8	1 1/2	1,810
C475 3/4	1.42	c	3/4	1 3/4	2,710
C475 7/8	2.00	f	7/8	2	3,770
C475 1	6	y	1	2 1/4	4,960

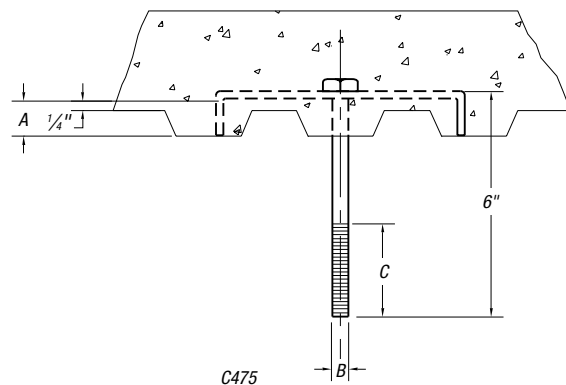

## Beam Clamps

### Superstrut® Beam Clamps

#### Materials

Most products are manufactured from hot-rolled carbon steel bars or hot-rolled strip steel. Pipe rollers are cast iron. Products which are copper plated carry the letter "T" in the prefix.

#### Design Loads

Where design loads are indicated, they provide for a safety factor of 3 in conformance with the "AMERICAN STANDARD CODE FOR PRESSURE PIPING."

GoldGalv® hardware finish is standard for all Superstrut® products. This is a multi-process finish of electro-plated zinc, followed by gold-colored trivalent chromium to give excellent corrosion resistance and a superior paint base. See **pages B-106–B-107** for a complete description of the GoldGalv® hardware finish. GoldGalv® hardware will be furnished if no other finish is specified.



### Beam Clamps for Mounting Channel

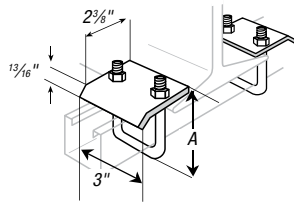

**CAT. NO. U501, U502**  
Furnished complete.  
Design load U501 – 2,150 lbs.  
U502 – 3,000 lbs.

CAT. NO.	FOR CHANNEL	A (IN.)	STD. CTN.
U501	A-1200 A-1400	3 <sup>5</sup> / <sub>16</sub>	20
	B-1200 B-1400		
	C-1200 B-1402		
U502	A-1202 A-1402	4 <sup>13</sup> / <sub>16</sub>	20
	C-1202 H-1200		

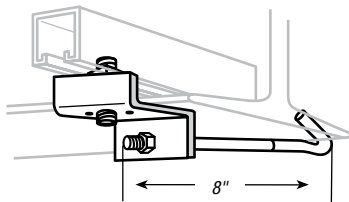

**U504**

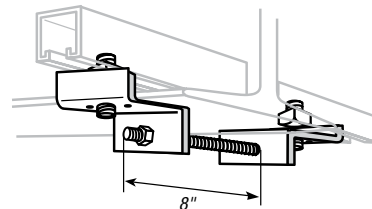

**U505**

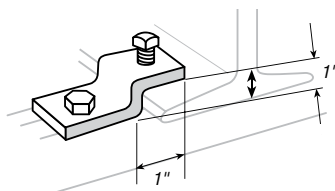

**U510**  
1/2" x 1 1/2" set screw included.  
Order separately one 1/2" x 1 1/2" hex head cap screw and 1/2" channel nut.

Channel	Design Load lbs.
A-1,200	1,000
A-1,400	800

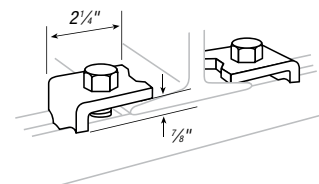

**512-U**  
Order separately one 1/2" x 1 1/2" hex head cap screw and 1/2" channel nut.

Channel	Design Load lbs.
A-1,200	1,000
A-1,400	800



## Beam Clamps

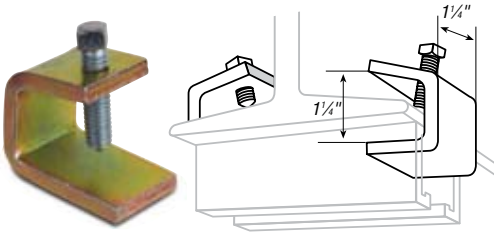

**U514**  
 $\frac{3}{8}$ " x  $1\frac{1}{2}$ " set screw included.  
 Design load 750 lbs./per pair.

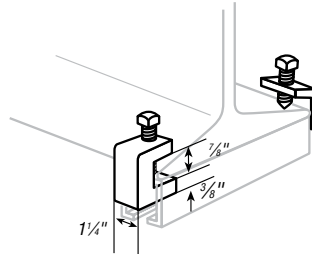

**U514A**  
 $\frac{3}{8}$ " x  $1\frac{1}{2}$ " set screw included.  
 Design load 1,650 lbs./per pair.

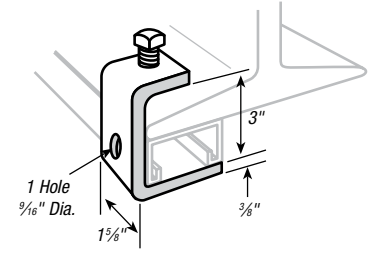

**U515**  
 For all "A" series channel.  
 $\frac{1}{2}$ " x  $1\frac{1}{2}$ " set screw included.  
 Design load 800 lbs.

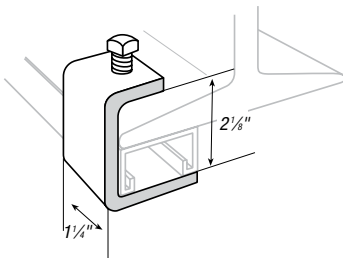

**U515B**  
 For all "B" series channel.  
 $\frac{1}{2}$ " x  $1\frac{1}{2}$ " set screw included.  
 Design load 800 lbs.

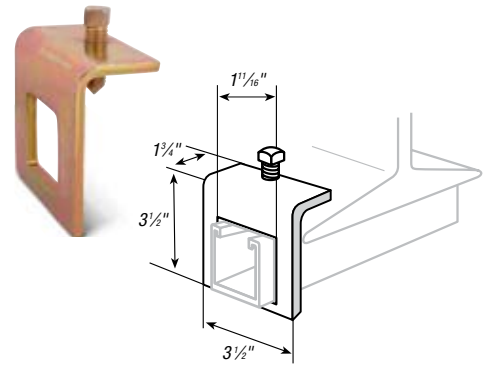
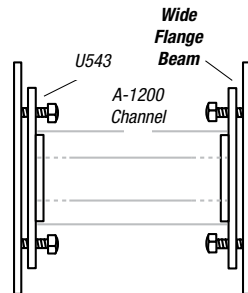

**A-597**  
 Standard Finish — GoldGalv® brand.  
 Channel Series A  
 Design load 800 lbs./ea.

CAT. NO.	FLANGE WIDTH* (IN.)	A (IN.)	DESIGN LOAD LBS.	STD. CTN.
U-520	2 $\frac{3}{8}$ –4 $\frac{1}{2}$	8 $\frac{3}{4}$	2,000	10
U-521	3 $\frac{3}{4}$ –5 $\frac{3}{4}$	10	1,300	10
U-522	5 $\frac{5}{8}$ –7 $\frac{5}{8}$	11 $\frac{5}{8}$	900	10

\*When ordering specify flange width.

Standard Finish — GoldGalv®, unless otherwise stated.

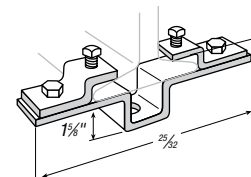

**U520, U-521 & U-522**  
 Standard Finish — GoldGalv® brand.  
 Nuts, cap screws and set screws included.

## Beam Clamps

### Beam Clamps — Malleable Iron, Silver Electroplated Finish

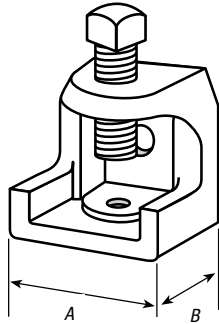

CAT. NO.	BASE SIZE (IN.)		JAW OPENING (IN.)	TAPPING OF BASE AND BACK HOLES	SET SCREW LOAD RATING <sup>†</sup>	TORQUE IN INCH-LBS.	STD. CTN.
	A	B					
500-SC	1	1¼	1½	¼-20	250	60	50
501	1½	1¾	¾	¼-18	500	60	50
502	2	2	1	¾-16	750	120	50
503-SC	2½	2½	1	½-13	1,250	250	20
507	2½	2¾	1¾	½-13	1,250	250	20
508	2½	2¾	2½	½-13	1,250	250	10
509	1	1¼	1½	10-24	150	60	100
510	2½	1¾	¾	¼-20	250	40	100
511-SC	2½	1¾	¾	10-24	150	40	100

<sup>†</sup>Safety Factor of 3.

Load Ratings based on bottom hole of Beam Clamp.

CSA File No. LR-52208.

Also available in 316 stainless steel.

### U-540 — Side Hanger Clip

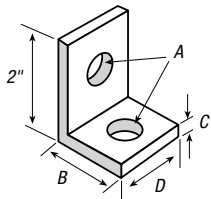

CAT. NO.	A (IN.)	B (IN.)	C (IN.)	D (IN.)	STD. CTN.
540 3/8	7/16	1 1/8	1/4	7/8	25
540 1/2 EC	9/16	1 1/8	1/4	1 1/8	25
540-5/8	1 1/16	2 1/2	3/8	2	25
540-3/4	1 3/16	2 1/2	3/8	2	25

Finishes — GoldGalv® brand or Black (B)

### U-542 — Side Hanger Clip

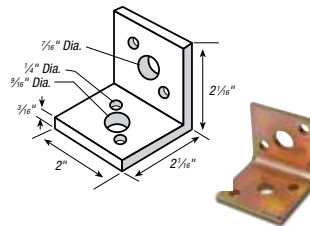

CAT. NO.	ROD SIZE	DESIGN LOAD (LBS.)
544	3/8"	610
	1/2"	1,000

Finishes — GoldGalv® brand or Black (B)  
Standard Finish — GoldGalv®, EG, HD, & SS available.

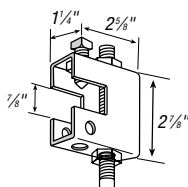

**U562**  
Beam Clamp  
½" set screw included.  
Rod Size: ½"  
Design load 500 lbs.

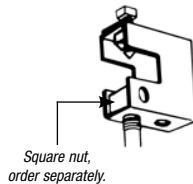

**U562**  
Beam Clamp Optional Use  
½" set screw included.  
Rod size: ½"  
Design load 800 lbs.  
For 20° swivel application, use ES-145-1/2 nut.

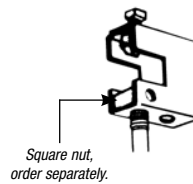

**U563**  
Beam Clamp Optional Use  
¾" set screw included.  
Rod size: ¾"  
Design load 400 lbs.

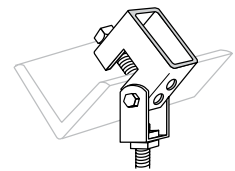

**U563**  
Beam Clamp with Swing Hanger  
¾" set screw included.  
Rod sizes: ¾"  
Design load 540 lbs.

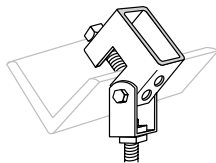

**U562**  
Beam Clamp with Swing Hanger  
½" screw included.  
Rod size: ½"  
Design load 800 lbs.

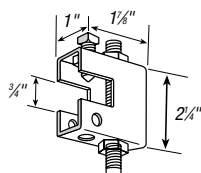

**U563**  
Beam Clamp  
¾" set screw included.  
Rod size: ¾"  
Design load 250 lbs.

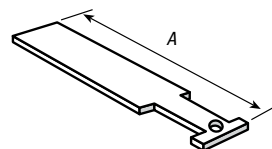

**U-568**  
Beam Clamp Safety Strap  
Standard Finish — GoldGalv® brand  
For U-563 beam clamp.

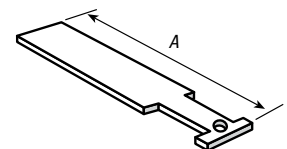

**U-568**  
Beam Clamp Safety Strap  
Standard Finish — GoldGalv® brand  
For U-562 beam clamp.

## Beam Clamps

### S-541 — Swing Connector

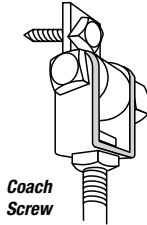

Coach  
Screw

Standard Finish — GoldGalv® brand  
Rod Size: 3/8"  
For use with wood beam.  
3/8" x 1 1/4" bolt, nut and clevis included.

### U-577 — Clevis & Swing Connector

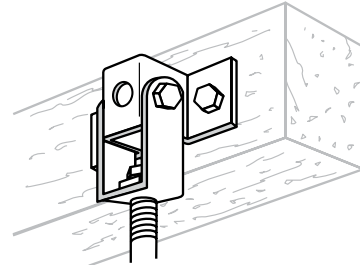

Rod Size: 1/2"  
Standard Finish — GoldGalv® brand  
For use with wood beam.

### U-560 — Heavy-Duty Beam Clamp

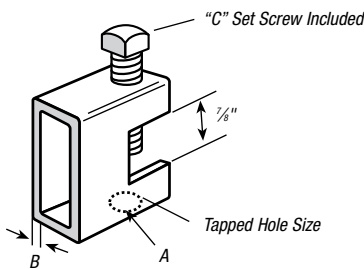

CAT. NO.	DIMENSIONS (IN.)			DESIGN LOAD LBS.	STD. CTN.
	A	B	C		
U560 1/4	1/4	1/8	3/8 x 1 1/2	1,050	25
U-560-3/8	3/8	1/8	3/8 x 1 1/2	1,050	25
U-560-1/2	1/2	1/4	1/2 x 1 1/2	2,650	25
U-560-5/8	5/8	1/4	1/2 x 1 1/2	2,650	25

Channel Angle Connector. Standard Finish — GoldGalv®.  
Available in Electro-Galvanized (EG) finish.  
Integral pilot, prevents twist.

### U-564 — Heavy-Duty Beam Clamp

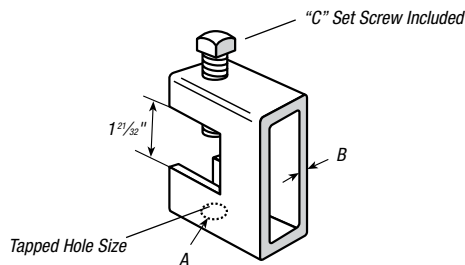

CAT. NO.	DIMENSIONS (IN.)			DESIGN LOAD LBS.	STD. CTN.
	A	B	C		
U-564-3/8	3/8	1/4	3/8 x 2 1/4	1,300	25
U-564-1/2	1/2	1/4	1/2 x 2 3/4	3,150	15
U564 5/8	5/8	1/4	1/2 x 2 3/4	3,150	25

Available in Electro-Galvanized (EG) finish.

## Beam Clamps

### E-231 — Structural Steel Clamp



CAT. NO.	DIMENSIONS (IN.)			WT. LBS./C
	A	B	C	
<b>3/8" or 1/2" Rod</b>				
*E-231-3/8	2 1/2	1	7/8	31
**E-231-1/2	3	1 1/2	1 1/8	53

Assembly requires two H-116-C (3/8") or two H-116-D (1/2") square nuts to attach hanger rod.  
1/2" steel.

\* Load rating of 500 lbs. with a safety factor of 3.

\*\* Load rating of 800 lbs. with a safety factor of 3.

Standard Finish — GoldGalv®, unless otherwise stated.

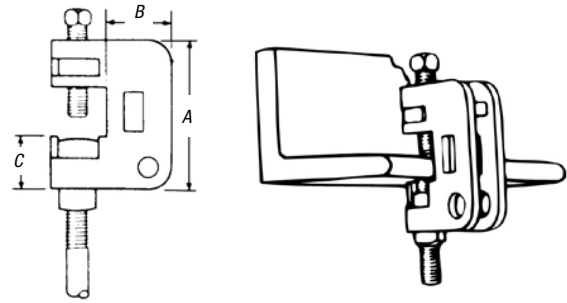

### E-232 — Clamp with Swing Connector

- E-231 clamp with swing connector
- Affords a convenient method of attaching to angled beams



CAT. NO.	DIAMETER FOR ROD (IN.)	DIMENSIONS (IN.)			WT. LBS./C
		A	B	C	
<b>3/8" or 1/2" Rod</b>					
*E-232-3/8	3/8	9/16	7/16	1	48
**E-232-1/2	1/2	7/8	2 3/8	1 1/4	76

\* Load rating of 400 lbs. with a safety factor of 3.

\*\* Load rating of 550 lbs. with a safety factor of 3.

GoldGalv® finish.

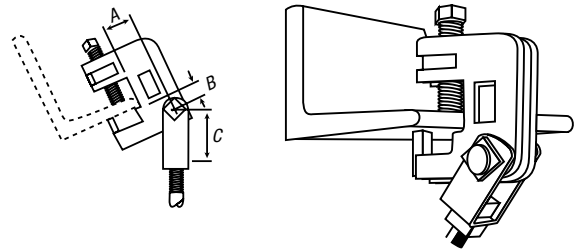

### E-233 — Anchor Clip

- Clamps to I-beams, channels, angles and column
- Two sizes are available, one for 3/8" and the other for 1/2" hanger rod
- Each takes flanges up to .8" thickness



CAT. NO.	ROD SIZE (IN.)	MAX. BEAM WIDTH "A" (IN.)	FOR USE WITH	WT. LBS./C
E-233-3/8-6	3/8	6	E-231-3/8 or E-232-3/8	20
E-233-3/8-10	3/8	10	E-231-3/8 or E-232-3/8	33
E-233-1/2-6	1/2	6	E-231-1/2 or E-232-1/2	26
E-233-1/2-10	1/2	10	E-231-1/2 or E-232-1/2	37

Anchor Clips should be used when clamps are subject to excessive vibration. To obtain the correct size clips, add 1 inch to the flange width. If length required is not standard, order next largest standard length.

GoldGalv® finish.

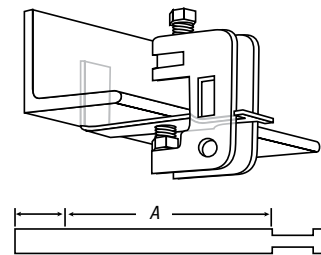

For use with E-231 and E-232 clamps when hanger rod is not in straight through position.

## Beam Clamps

### E-160 — Adjustable Beam Clamp

- Clamps to I-beam where edge of beam flange does not exceed .8" thickness
- Hook rod is furnished in three lengths to fit beam flanges up to 6", 9" or 12" widths



CAT. NO.	BEAM FLANGE WIDTH (IN.)	WT. LBS./C
<b>1/2" HANGER RODS</b>		
<i>1/2" Rod</i>		
E-160-1/2-6	2½ to 6	115
E-160-1/2-9	5½ to 9	125
E-160-1/2-12	8½ to 12	154

Load rating 800 lbs. with a safety factor of 3.

Assembly requires hanger rod of the proper length and size plus two H-114-D nuts 3/16" steel and 1/2" hook rod.

GoldGalv® finish.

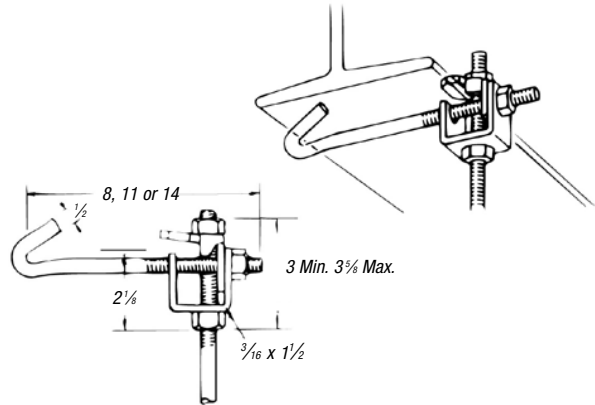

### U-568 Beam Clamps

CAT. NO.	BEAM FLANGE WIDTH (IN.)	A (IN.)	STD. CTN.
U568 1	6	8	50
U-568-2	9	11	50
U-568-3	6	9	25
U-568-4	9	12	50
U-568-5	12	15	50
U-568-6	6	9	25
U-568-7	9	12	25
U-568-8	12	15	25

16 ga. material.

Standard Finish — GoldGalv®, unless otherwise stated.

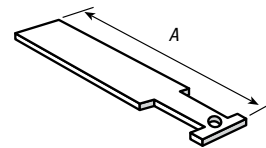

**U-568**  
Beam Clamp Safety Strap  
Standard Finish — GoldGalv® brand.  
For U-560 and U-564 beam clamp.

### U569 — Beam Clamp

- Standard finish — GoldGalv®
- Maximum flange width 5"
- Design load 400 lbs.

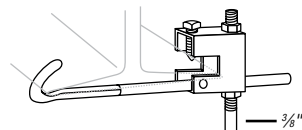

### U570 — Beam Clamp with Safety Rod

- Standard finish — GoldGalv®
- Flange width 4" min. — 8" max.
- Sizes — 1/2" (for use with 3/8" rod, see U569)
- Design load 650° F — 500 lbs.

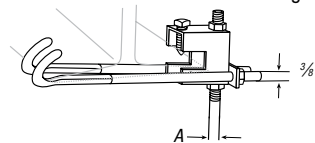

### C-775L — Clamp with Lock Nut

CAT. NO.	ROD SIZE (IN.)	DIMENSIONS (IN.)				DESIGN LOAD LBS.	STD. CTN.
		A	B	C	D		
C775L 3/8	3/8	3/8	3/4	2 3/8	2 3/8	400	100
C-775L-1/2	1/2	3/8	3/4	2 3/8	2 3/8	500	100
C-775L-5/8	5/8	1/2	3/4	2 9/16	2 3/8	550	50
C-775L-3/4	3/4	3/8	3/4	2 1/16	2 3/8	630	50
C-775L-7/8	7/8	3/4	1	3 1/16	3	1,200	25

Standard Finishes - GoldGalv® brand, Black (B), Stainless Steel (SS) and Electro-Galvanized (EG).

Carbon Steel.



C-775L

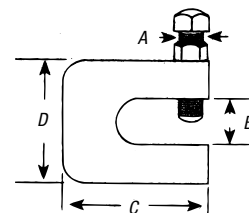

## Beam Clamps

### C-777 — Steel Top Beam Clamp & C-778 — Steel Wide Jaw Top Beam Clamp

CAT. NO.	ROD SIZE A (IN.)	PIPE SIZE	DIMENSIONS (IN.)				DESIGN LOAD LBS.	STD. CTN.	
			B	C	D	E			
C777 3/8	3/8	1/2-4	1 3/16	3/4	1	7/16	1	900	100
C-777-1/2	1/2	5-8	1 1/2	3/4	1	9/16	1 1/4	2,430	50
C-778-3/8	3/8	1/2-4	1 3/16	1 1/4	1	7/16	1	900	100
C-778-1/2	1/2	5-8	1 1/2	1 1/4	1	9/16	1 1/4	2,430	50

Standard Finish — GoldGalv®, Black (B) and Electro-Galvanized (EG).

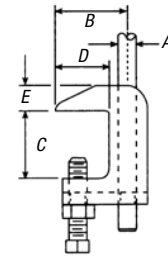
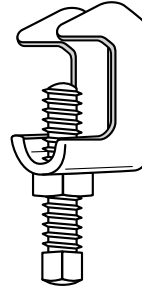

C-777, C-788

### M-777 — Steel Top Beam Clamp

- Junior Top Beam C-Clamp
- Standard finish is Gold-Galv®
- Available in Electro-Galvanized (EG) or Black (B) Malleable Iron
- Provides clamping under roof installations with bar joist construction (max. joist thickness 5/8")
- Order by Cat. No., rod size

ROD SIZE A (IN.)	DESIGN LOAD LBS.
3/8	350
1/2	470
5/8	550
3/4	700
7/8	1,000

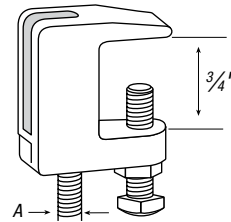

M-777

### M-775L — Clamp with Lock Nut

CAT. NO.	ROD SIZE A (IN.)	B (IN.)	C (IN.)	DESIGN LOAD LBS.	STD. CTN.
M-775L-3/8	3/8	3/4	1 3/4	400	100
M-775L-1/2	1/2	3/4	1 3/4	400	100
M-775L-5/8	5/8	3/4	2	440	50
M-775L-3/4	3/4	3/4	2	500	50

Available in Electro-Galvanized (EG) or Black (B).

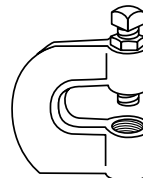

M-775L

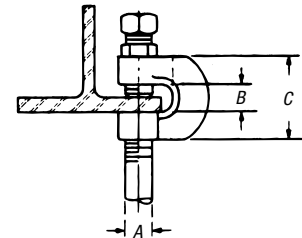

### M-778 — Steel Wide Jaw Top Clamp

- Top Beam C-Clamp
- Rod Size: 3/8", 1/2", 5/8" and 3/4"
- Available in Electro-Galvanized (EG) or Black (B) Malleable Iron
- Provides clamping under roof installations with bar joist type construction
- Order by Cat. No. and rod size

ROD SIZE A (IN.)	DESIGN LOAD LBS.
3/8	400
1/2	500
5/8	850
3/4	900

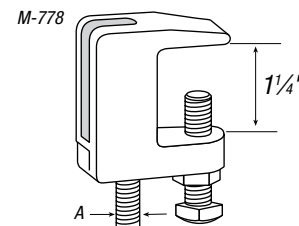

## Beam Clamps

### C-247, C-248 & C-249 — Steel Conduit Clamps

- A versatile clamp for attaching conduit to any type of beam, channel, angle or column
- Designed to hold the conduit snug against the support with conduit either parallel or at right angle to it
- The case-hardened set screw bites into the structural member for maximum security
- 1/8" steel

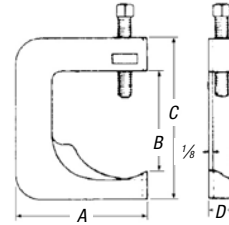

CONDUIT SIZE	MAX. BEAM C-247	FLANGE C-248	THICKNESS C-249
1/2	3/8	1	
3/4	7/16	3/4	1 1/2
1		1/2	1 1/4
1 1/4		1	
1 1/2			5/8
Dim. A	2 1/4	2 9/16	3 1/4
Dim. B	1 3/8	1 1/4	2 1/2
Dim. C	2 3/4	3	4
Dim. D	9/16	9/16	5/8
Per Carton	100	50	50
Wt. in lbs./C	33	36	59

Standard Finish — GoldGalv®, unless otherwise stated.

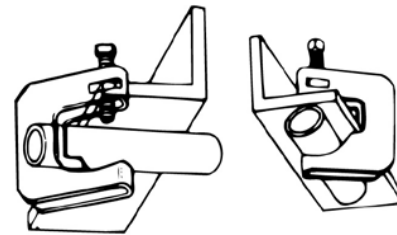

## Pipe Supports

Three types of pipe clamps are available to provide right angle, vertical and parallel attachment to a beam. Types RC, EC and PC are malleable iron clamps with an edge that grips the structural member for maximum holding power when tightened.

Type RCS clamps are all steel, providing two bearing surfaces for strong attachment for mounting pipe or conduit at right angles to the beam.

All parts are electrogalvanized, including the threads. The clamps are designed for clamping to a wide variety of beam thicknesses and tapers. Can be installed using only a wrench.

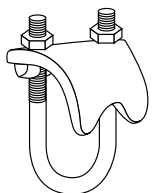

- RC Clamp — Malleable Iron
- RCS Clamp — Steel
- For mounting pipe or conduit at right angles to the beam
- Use SS316 suffix for 316 Stainless Steel
- Use HDG suffix for hot-dip galvanized

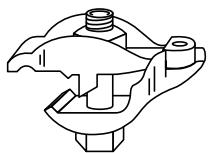

- EC Clamp — Malleable Iron
- For mounting pipe or conduit vertically across the beam
- Use SS316 suffix for 316 Stainless Steel
- Use HDG suffix for hot-dip galvanized

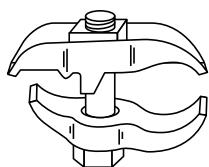

- PC Clamp — Malleable Iron
- For mounting pipe or conduit parallel to the beam
- Use SS316 suffix for 316 Stainless Steel
- Use HDG suffix for hot-dip galvanized

CAT. NO. & SIZE	DIMENSIONS (IN.)			CAT. NO. & SIZE	DIMENSIONS (IN.)		
	O.D. OF CONDUIT OR PIPE	NOM. CONDUIT PIPE SIZE	STD. CTN.		O.D. OF CONDUIT OR PIPE	NOM. CONDUIT PIPE SIZE	STD. CTN.
RCS-1/2	.840	1/2	50	EC-1/2	.840	1/2	50
RCS-3/4	1.050	3/4	50	EC-3/4	1.050	3/4	50
RCS-1	1.315	1	50	EC-1	1.315	1	25
RCS-1-1/4	1.660	1 1/4	50	EC-1-1/4	1.660	1 1/4	25
RCS-1-1/2	1.900	1 1/2	50	EC-1-1/2	1.900	1 1/2	25
RCS-2	2.375	2	50	EC-2	2.375	2	25
RC-3/8	.675	3/8	50	EC-2-1/2	2.875	2 1/2	10
RC-1/2	.840	1/2	50	EC-3	3.500	3	10
RC-3/4	1.050	3/4	50	PC-3/8	.675	3/8	50
RC-1	1.315	1	50	PC 1/2	.840	1/2	50
RC-1-1/4	1.660	1 1/4	50	PC-3/4	1.050	3/4	50
RC-1-1/2	1.900	1 1/2	50	PC-1	1.315	1	50
RC-2-SC	2.375	2	50	PC-1-1/4	1.660	1 1/4	25
RC-2-1/2	2.875	2 1/2	25	PC-1-1/2	1.900	1 1/2	25
RC-3	3.500	3	25	PC-2	2.375	2	25
RC-3-1/2	4.000	3 1/2	25	PC-2-1/2	2.875	2 1/2	25
RC-4-SC	4.500	4	20	PC-3	3.500	3	10
				PC-3-1/2	4.00	3 1/2	10
				PC-4	4.500	4	10

## Pipe Straps, Conduit Clamps and Hangers

### Excellent Corrosion Resistance and a Superior Paint Base

GoldGalv® hardware finish is standard for all Superstrut® products. This is a multi-process finish of electro-plated zinc, followed by gold-colored trivalent chromium to give excellent corrosion resistance and a superior paint base. See **pages B-106–B-107** for a complete description of the GoldGalv® hardware finish. GoldGalv® hardware will be furnished if no other finish is specified.

#### Materials

Most products are manufactured from hot-rolled carbon steel bars or hot-rolled strip steel. Pipe rollers are cast iron. Products which are copper plated carry the letter "T" in the prefix.

#### Design Loads

Where design loads are indicated, they provide for a safety factor of 3 in conformance with the "AMERICAN STANDARD CODE FOR PRESSURE PIPING."

#### Hanger Design

Pipe hangers are of advanced design and afford a new and better way of ordinary use.

#### Standard Dimensions

The following, except where noted, apply to all beam clamp fittings.

Hole Size: 5/16" diameter

Material: 1 5/8" wide

Material: 1/4" thick

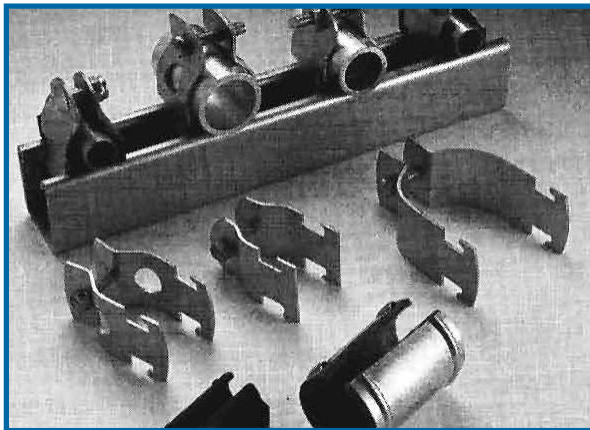
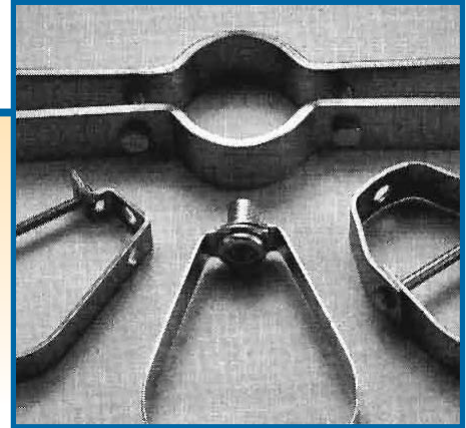

#### GoldGalv® Outperforms Copper Plated

In a test conforming to ASTM G-87-84, also known as the Kesternich Test, Superstrut's GoldGalv® electrogalvanized zinc trivalent chromium finish achieved superior corrosion resistance in comparison to copper plated.

Performed and certified by an independent testing laboratory, the stringent Kesternich test is equivalent to an acid rain environment. The test procedure exposes subject material to condensed moisture containing harsh sulfur dioxide (SO2) which accelerates the aging process. During the series of test time cycles, the material is thoroughly inspected for signs and progression of damaging red rust.

The first test series conducted included various light-duty adjustable clevis hangers assembled to copper tubing. The GoldGalv® finish exhibited five times the red rust resistance as compared to copper plated.

The second test series was performed on various O.D. pipe straps attached to copper tubing and continuous slot channel. GoldGalv® achieved greater red rust resistance by seven times over copper plating.

Once tests were completed, all copper tubes were split open and inspected for signs of electrolysis. The copper tubes showed minimal deterioration as a result of the test and no indication of electrolysis occurrence when attached to material with GoldGalv® finish.

#### ASTM G-87-84 Corrosion Test Results

FINISH	INITIAL RED RUST	50% RED RUST	100% RED RUST
<b>Test Series I: Light-Duty Adjustable Clevis Hanger</b>			
GoldGalv®	120 hours	216 hours	*Never obtained
Copper Plated	24 hours	48 hours	72 hours
<b>Test Series II: O.D. Pipe Straps</b>			
GoldGalv®	168 hours	192 hours	240 hours
Copper plated	24 hours	48 hours	168 hours

\*Test series ended after 360 hours.

Standard Finish – GoldGalv®, unless otherwise stated.



## Pipe Straps, Conduit Clamps and Hangers

The new standard for heavy-duty applications.

### LOC-KING™ Cobra® One-Piece Cable and Pipe Clamp

The LOC-KING™ Cobra® heavy-duty pipe and cable clamp adds two new design innovations to the heavy-duty features of the original King Cobra® clamp.

First, a pre-set torque mechanism takes the guesswork out of installation, ensuring optimum torque and eliminating excess pressure on cables. Since the torque is pre-set, LOC-KING™ Cobra® clamps are ideally suited for use with power tools, making installation faster and more efficient than ever.

Second, the incorporation of an anti-vibration nut means that once installed, LOC-KING™ Cobra® clamps remain securely installed, even in high-vibration environments.

- Designed to be used on tray cable, Teck cable, metal-clad cable and armored cable
- Power-tool compatible for fast and efficient installation
- Pre-set torque mechanism takes the guesswork out of installation, delivering optimum torque even when using power tools
- Pre-set torque prevents over-tightening and excess pressure
- Anti-vibration nut ensures permanent installation, even in high-vibration environments
- Superior design load capabilities for heavy-duty applications: 350 lbs. for ½"–2½" trade sizes; 450 lbs. for 3"–4" trade sizes

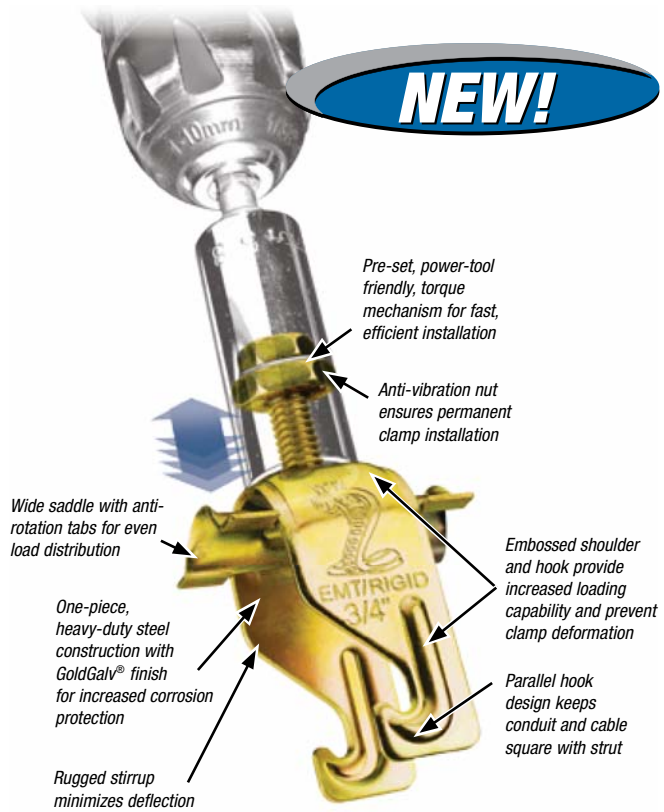

1 Position LOC-KING™ Cobra® clamp.



2 Using a power tool fitted with a ½" (16mm) socket, tighten lock nut...



3 ...until it 'blocks' and will no longer turn. Installation is complete.



See Ratings in the Table Below

**Note:** When pre-set torque engages, lock-nut separates from bolt head and stops firmly against clamp body.

CAT. NO.	FOR EMT AND RIGID CONDUIT TRADE SIZES	CABLE O.D. RANGE (IN.)	ARROW #1 LOAD RATING*	ARROW #2 SLIP RATING**	ARROW #3 PULL RATING**	QUANTITY PER BOX
LKCPC050	½	.650–.890	350 lbs.	50 lbs.	50 lbs.	100
LKCPC075	¾	.860–1.110	350 lbs.	50 lbs.	50 lbs.	100
LKCPC100	1	1.100–1.400	350 lbs.	50 lbs.	50 lbs.	100
LKCPC125	1¼	1.400–1.725	350 lbs.	50 lbs.	50 lbs.	50
LKCPC150	1½	1.690–1.980	350 lbs.	50 lbs.	50 lbs.	50
LKCPC200	2	1.980–2.576	350 lbs.	50 lbs.	50 lbs.	50
LKCPC250	2½	2.576–3.060	350 lbs.	50 lbs.	50 lbs.	25
LKCPC300	3	3.060–3.626	450 lbs.	50 lbs.	50 lbs.	25
LKCPC350	3½	3.626–4.126	450 lbs.	50 lbs.	50 lbs.	25
LKCPC400	4	4.126–4.626	450 lbs.	50 lbs.	50 lbs.	25

\* Safety Factor of 4

\*\* Safety Factor of 1

[www.tnb.com](http://www.tnb.com)

United States  
Tel: 901.252.8000  
800.816.7809  
Fax: 901.252.1354

Technical Services  
Tel: 888.862.3289

**Thomas & Betts**

## Pipe Straps, Conduit Clamps and Hangers

The new specification standard for heavy-duty industrial applications.



### King Cobra® Cable and Pipe Clamp with GoldGalv® Finish

- Superior design load capabilities for industrial applications: 350 lbs. for 1/2" to 2 1/2" trade sizes; 450 lbs. for 3" to 4" trade sizes
- Durable one-piece heavy-duty steel construction — designed specifically for use in industrial applications
- Embossed shoulder and hooks increase loading capability and durability, preventing deformation of clamps
- Rugged stirrup provides increased strength for heavier loads, minimizing deflection
- Wider saddle design with anti-rotation tabs distributes load evenly over a larger surface area, preventing jacket damage
- Increased corrosion protection\* — GoldGalv® (yellow zinc trivalent) finish stands up to harsh industrial applications
- Parallel hook design keeps conduit and cable square with strut
- Heavy-duty 5/16" hex bolt
- One clamp size works on equal trade sizes for both EMT and rigid conduit, simplifying clamp specification



### Cobra® One-Piece Cable and Pipe Clamp

Takes a bite out of your installation time!

- One-piece heavy-duty construction ready to install right out of the box, no need to break apart and reassemble, no screws or bolts to drop
- Installs quickly and securely using one hand
- Universal bolt head accepts a range of tools
- Eliminates the guesswork from clamp selection — one catalog number attaches equal trade sizes of EMT and rigid conduit
- Parallel hook design keeps conduits and cable square with strut
- Reconfigure wiring without complete disassembly. Remove cables easily without disturbing neighboring clamps



\* Compared to conventional electrogalvanization.

CAT. NO.	FOR EMT AND RIGID CONDUIT		STATIC LOAD LIMIT (LB) SAFETY FACTOR = 4	STD. CTN.
	TRADE SIZE (IN.)	CABLE O.D. RANGE (IN.)		
<b>GoldGalv® Finish</b>				
KCPC050	1/2	.650-.890	350	100
KCPC075	3/4	.860-1.110	350	100
KCPC100	1	1.100-1.400	350	100
KCPC125	1 1/4	1.400-1.725	350	50
KCPC150	1 1/2	1.690-1.980	350	50
KCPC200	2	1.980-2.576	350	50
KCPC250	2 1/2	2.576-3.060	350	25
KCPC300	3	3.060-3.626	450	25
KCPC350	3 1/2	3.626-4.126	450	25
KCPC400	4	4.126-4.626	450	25

Standard Finish — GoldGalv®

CAT. NO.	FOR EMT AND RIGID CONDUIT		STATIC LOAD LIMIT (LB) SAFETY FACTOR = 4	STD. CTN.
	TRADE SIZE (IN.)	CABLE O.D. RANGE (IN.)		
<b>EG Silver Finish</b>				
CPC025	1/4	.312-.600	200	100
CPC050	1/2	.650-.890	200	100
CPC075	3/4	.860-1.110	200	100
CPC100	1	1.100-1.400	200	100
CPC125	1 1/4	1.400-1.725	200	50
CPC150	1 1/2	1.690-1.980	200	50
CPC200	2	1.980-2.576	200	50
CPC250	2 1/2	2.576-3.060	350	25
CPC300	3	3.060-3.626	350	25
CPC350	3 1/2	3.626-4.126	350	25
CPC400	4	4.126-4.626	350	25

Stainless Steel: add suffix SS6.

## Pipe Straps, Conduit Clamps and Hangers

Pre-assembled for easy handling and sorting.

### Superstrut® Pipe Straps

Superstrut® Pipe Straps are designed to be twist inserted anywhere along the slot side of the channel. Pipes can be placed as closely as pipe couplings permit.

**Some unique features of the straps include:**

- Bolt head is combination slot and hex head for flexibility of attachment
- Square nut is captivated on the shoulder for easy one-handed tightening
- Straps are interchangeable with 1½" strut for broader application
- Straps are shipped assembled so counting and sorting are easier
- Pipe or conduit sizes are shown on the strap for easy identification
- All Superstrut® Straps are preassembled for easy handling and sorting

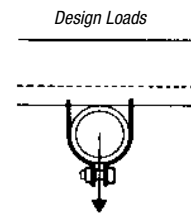

Metal Framing & Cable Tray — Superstrut® Metal Framing System

### 700 — Superstrut® Straps for EMT

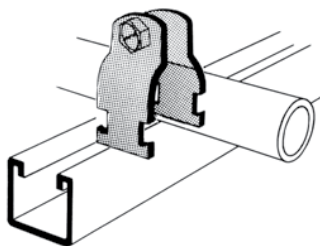

CAT. NO.	EMT SIZE (IN.)	O.D. SIZE (IN.)	STEEL STRAP THICKNESS	DESIGN LOAD (LBS.)	STD. CTN.
700 3/8-STR	3/8	.577	14 ga.	750	100
700-1/2-STR	1/2	.706	14 ga.	750	100
700-3/4-STR	3/4	.922	14 ga.	750	100
700-1-STR	1	1.163	14 ga.	750	100
700-1-1/4-STR	1 1/4	1.510	14 ga.	750	50
700-1-1/2-STR	1 1/2	1.740	12 ga.	800	50
700-2-STR	2	2.197	12 ga.	800	50

Standard Finish — GoldGalv®

### 701 — Superstrut® Straps for O.D. Tubing



CAT. NO.	TUBING O.D. (IN.)	STEEL STRAP THICKNESS	DESIGN LOAD (LBS.)	STD. CTN.
701-1/4	1/4	14 ga.	750	100
701-3/8	3/8	14 ga.	750	100
701-1/2-STR	1/2	14 ga.	750	100
701-5/8	5/8	14 ga.	750	100
701-3/4	3/4	14 ga.	750	100
701-7/8	7/8	14 ga.	750	100
701-1-STR	1	14 ga.	750	50
701-1-1/8	1 1/8	14 ga.	1,000	100
701-1-1/4	1 1/4	14 ga.	1,000	25
701-1-3/8	1 3/8	14 ga.	1,000	100
701-1-1/2	1 1/2	14 ga.	1,000	25
701-1-5/8	1 5/8	14 ga.	1,000	100
701-1-3/4	1 3/4	12 ga.	1,000	25
701-1-7/8	1 7/8	12 ga.	1,000	50
701-2	2	12 ga.	1,000	50
701-2-1/8	2 1/8	12 ga.	1,300	50
701-2-1/4	2 1/4	12 ga.	1,300	25
701-2-3/8	2 3/8	12 ga.	1,300	25
701-2-1/2	2 1/2	12 ga.	1,300	25
701-2-5/8	2 5/8	12 ga.	1,300	50

(continued on following page)

## Pipe Straps, Conduit Clamps and Hangers

### 701 — Superstrut® Straps for O.D. Tubing (continued)

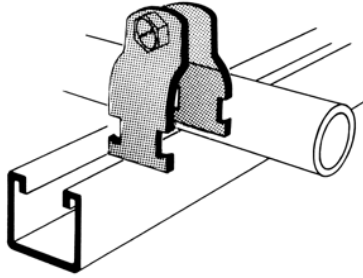

CAT. NO.	TUBING O.D. (IN.)	STEEL STRAP THICKNESS	DESIGN LOAD (LBS.)	STD. CTN.
701-2-3/4	2¾	12 ga.	1,300	25
701-2-7/8	2¾	12 ga.	1,300	25
701-3	3	12 ga.	1,300	25
701-3-1/8	3¼	12 ga.	1,300	25
701-3-1/4	3¼	12 ga.	1,300	25
701-3-3/8	3¾	12 ga.	1,300	25
701-3-1/2	3½	12 ga.	1,300	25
701-3-5/8	3¾	11 ga.	1,650	25
701-3-3/4	3¾	11 ga.	1,650	25
701-3-7/8	3¾	11 ga.	1,650	25
701-4	4	11 ga.	1,650	25
701-4-1/8	4¼	11 ga.	1,650	25
701-4-1/4	4¼	11 ga.	1,650	25
701-4-3/8	4¾	11 ga.	1,650	25
701-4-1/2	4½	11 ga.	1,650	10
701-4-5/8	4¾	11 ga.	1,650	10
701-4-3/4	4¾	11 ga.	1,650	10
701-4-7/8	4¾	11 ga.	1,650	10
701-5	5	11 ga.	1,650	25
701-5-1/8	5¼	11 ga.	1,650	10
701-5-1/4	5¼	11 ga.	1,650	10
701-5-3/8	5¾	11 ga.	1,650	10
701-5-1/2	5½	11 ga.	1,650	10
701-5-5/8	5¾	10 ga.	1,650	10
701-5-3/4	5¾	10 ga.	1,650	10
701-5-7/8	5¾	10 ga.	1,650	10
701-6	6	10 ga.	1,650	10
701-6-1/8	6¼	10 ga.	1,650	10
701-6-1/4	6¼	10 ga.	1,650	10
701-6-3/8	6¾	10 ga.	1,650	10
701-6-1/2	6½	10 ga.	1,650	10
701-6-5/8	6¾	10 ga.	1,650	10
701-6-3/4	6¾	10 ga.	1,650	10
701-6-7/8	6¾	10 ga.	1,650	10
701-8	8	10 ga.	1,650	10

### 702 — Superstrut® Straps for Rigid Conduit, IMC and Pipe

- For Rigid or IMC Conduit, Pipe and Electric Metal Tubing (EMT)

CAT. NO.	RIGID CONDUIT OR PIPE SIZE (IN.)	O.D. SIZE (IN.)	STEEL STRAP THICKNESS	DESIGN LOAD (LBS.)	STD. CTN.
702-3/8	¾	.675	14 ga.	750	100
702-1/2	½	.840	14 ga.	750	100
702-3/4	¾	1.050	14 ga.	750	100
702-1	1	1.315	14 ga.	750	100
702-1-1/4	1¼	1.660	14 ga.	800	50
702-1-1/2	1½	1.900	12 ga.	800	50
702-2-STR	2	2.375	12 ga.	800	50
702-2-1/2	2½	2.875	12 ga.	1,000	50
702-3	3	3.500	12 ga.	1,650	50
702-3-1/2	3½	4.000	11 ga.	1,650	25
702-4	4	4.500	11 ga.	1,650	25
702-4-1/2	4½	5.000	11 ga.	1,650	25
702-5	5	5.563	11 ga.	1,650	25
702-6	6	6.625	11 ga.	1,650	10
702-8	8	8.625	11 ga.	1,650	10
702-10	10	10.750	10 ga.	1,650	25
702-12	12	12.750	10 ga.	1,650	25

Standard Finish — GoldGalv® brand. For Electro-Galvanized (Silver), add EG suffix.

### 703 — Universal Clamp

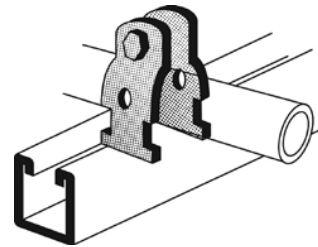

CAT. NO.	PIPE O.D. (IN.)	STEEL STRAP THICKNESS	DESIGN LOAD (LBS.)	STD. CTN.
703-1/2	.706-.840	16 ga.	400	100
703-3/4	.932-1.050	14 ga.	550	100
703 1	1.163-1.315	14 ga.	550	100
703-1-1/4	1.508-1.660	14 ga.	800	50
703-1-1/2	1.738-1.900	14 ga.	800	50
703-2	2.195-2.375	14 ga.	800	50

Standard Finish — GoldGalv®

## Pipe Straps, Conduit Clamps and Hangers

Angled for easy tightening!

### Angler® Pipe and Conduit Clamp



Metal Framing & Cable Tray — Superstrut® Metal Framing System

#### Universal Series — for EMT, IMC, Rigid and Standard Pipe



CAT. NO.	SIZE (IN.)	STRAP THICKNESS	DESIGN LOAD (LBS.)	INSTALL TORQUE (IN. LBS.)	STD. CTN.
<b>GoldGalv® Finish</b>					
C 109 1/2	1/2	14 ga.	400	40	100
C 109 3/4	3/4	14 ga.	500	40	100
C 109 1	1	14 ga.	500	40	100
C 109 1 1/4	1 1/4	14 ga.	500	40	100
C 109 1 1/2	1 1/2	12 ga.	800	60	50
C 109 2	2	12 ga.	800	60	50
C 109 2 1/2	2 1/2	12 ga.	800	60	50
C 109 3	3	12 ga.	800	60	50
C 109 3 1/2	3 1/2	11 ga.	1,200	60	25
C 109 4	4	11 ga.	1,200	60	25
<b>SilverGalv® Finish</b>					
C 109 1/2 EG	1/2	14 ga.	400	40	100
C 109 3/4 EG	3/4	14 ga.	500	40	100
C 109 1 EG	1	14 ga.	500	40	100
C 109 1 1/4 EG	1 1/4	14 ga.	500	40	100
C 109 1 1/2 EG	1 1/2	12 ga.	800	60	50
C 109 2 EG	2	12 ga.	800	60	50
C 109 2 1/2 EG	2 1/2	12 ga.	800	60	50
C 109 3 EG	3	12 ga.	800	60	50
C 109 3 1/2 EG	3 1/2	11 ga.	1,200	60	25
C 109 4 EG	4	11 ga.	1,200	60	25

#### Rigid Series — for Rigid Conduit and Standard Pipe



CAT. NO.	SIZE (IN.)	STRAP THICKNESS	DESIGN LOAD (LBS.)	INSTALL TORQUE (IN. LBS.)	STD. CTN.
<b>GoldGalv® Finish</b>					
C 109R 1/2	1/2	14 ga.	600	40	100
C 109R 3/4	3/4	14 ga.	600	40	100
C 109R 1	1	14 ga.	600	40	100
C 109R 1 1/4	1 1/4	14 ga.	600	40	100
C 109R 1 1/2	1 1/2	12 ga.	800	60	50
C 109R 2	2	12 ga.	800	60	50
C 109R 2 1/2	2 1/2	12 ga.	800	60	50
C 109R 3	3	12 ga.	800	60	50
C 109R 3 1/2	3 1/2	11 ga.	1,200	60	25
C 109R 4	4	11 ga.	1,200	60	25
<b>SilverGalv® Finish</b>					
C 109R 1/2 EG	1/2	14 ga.	600	40	100
C 109R 3/4 EG	3/4	14 ga.	600	40	100
C 109R 1 EG	1	14 ga.	600	40	100
C 109R 1 1/4 EG	1 1/4	14 ga.	600	40	100
C 109R 1 1/2 EG	1 1/2	12 ga.	800	60	50
C 109R 2 EG	2	12 ga.	800	60	50
C 109R 2 1/2 EG	2 1/2	12 ga.	800	60	50
C 109R 3 EG	3	12 ga.	800	60	50
C 109R 3 1/2 EG	3 1/2	11 ga.	1,200	60	25
C 109R 4 EG	4	11 ga.	1,200	60	25

Hex head size 3/8" for 1/2" to 1 1/4" sizes, 1/2" for 1 1/2" to 4" sizes.

Material: Stamped Steel.

Pipe sizes 2 1/2" to 4" utilize the same clamps for the Rigid Series and the Universal Series.

## Pipe Straps, Conduit Clamps and Hangers

### A-716 — Snap•Guard® Cushioned Clamp Tube Series

#### P-716 — Pipe Series

- Assembly consisting of GoldGalv® finish steel clamp with bolt/locknut and cushion
- Secure pipes, tubes and hoses for fluid conductors
- Installation is easy and requires no more time than a simple pipe clamp installation
- Cushion absorbs the shocks and associated vibrations from fluid surges in tubes, pipes and hoses
- Can handle temperatures from -40° F to 300° F
- Cushioned Clamp assemblies are available individually bagged

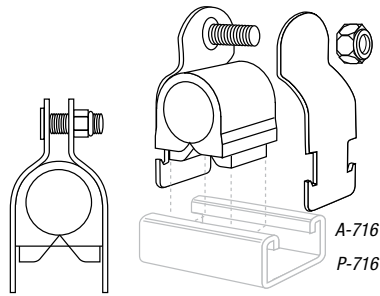

O.D. TUBING SIZES		STANDARD PIPE SIZES		STD. CTN.
ASSEMBLY CAT. NO.	TUBE O.D. (IN.)	ASSEMBLY CAT. NO.	NOMINAL PIPE SIZE (IN.)	
A-716-1/4	¼	P-716-1/4	¼	25
A-716-3/8	⅜	P-716-3/8	⅜	25
A-716-1/2	½	P-716-1/2	½	25
A-716-5/8	⅝	P-716-3/4	¾	25
A-716-3/4	¾	P-716-1	1	25
A-716-7/8	⅞	P-716-1-1/4	1¼	25
A-716-1	1	P-716-1-1/2	1½	10
A-716-1-1/8	1⅛	P-716-2	2	10
A-716-1-1/4	1¼	P716-2-1/2	2½	10
A-716-1-3/8	1⅜	P-716-3	3	10
A-716-1-1/2	1½	P-716-3-1/2	3½	10
A-716-1-5/8	1⅝	P-716-4	4	10
A-716-1-3/4	1¾	—	—	10
A-716-1-7/8	1⅞	—	—	10
A-716-2	2	—	—	10
A-716-2-1/8	2⅛	—	—	10
A-716-2-3/8	2⅜	—	—	10
A-716-2-5/8	2⅝	—	—	10
A-716-3-1/8	3⅜	—	—	10
A716-4-1/8	4⅛	—	—	10

Standard Finishes — GoldGalv® brand. Available in Stainless Steel — use SS suffix. (i.e) A-716-1SS, Electro-Galvanized (Silver) — use EG suffix. (i.e) A-716-1EG

### U-716, U-717 — Two-Hole Cushioned Clamp

- Guides, protects and uniformly spaces line runs. Low-cost, time-saving method of attaching tubing and hose to equipment
- Cushion is built to withstand the effects of most oils, chemical and industrial cleaning compounds, in temperatures from -50° F to 275° F. Interlock edge ensures cushion remains in place
- Clamp available in steel with the GoldGalv® hardware finish
- Attached with two standard fasteners to any flat surface, this clamp eliminates the use of special channels, providing a savings in both space requirements and cost
- Cushioned clamps reduce vibration, shock and noise in fluid systems and eliminate electrolysis

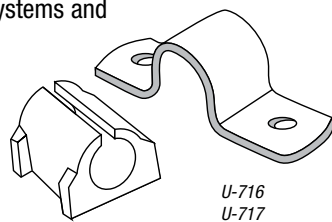

ASSEMBLY CAT. NO.	COPPER AND STEEL TUBING O.D. (IN.)	COPPER WATER PIPE (NOM.) (IN.)	NOMINAL PIPE SIZE (IN.)	STD. CTN.
U716 1/4	¼	—	—	25
U-716-3/8	⅜	¼	—	25
U-716-1/2	½	⅜	¼	25
U-716-5/8	⅝	½	⅜	25
U-716-3/4	¾	⅝	—	25
U-716-7/8	⅞	¾	½	25
U-716-1	1	—	—	25
U-716-1-1/8	1⅛	1	—	25
U-716-1-1/4	1¼	—	—	10
U-716-1-3/8	1⅜	1¼	—	10
U-716-1-1/2	1½	—	—	10
U-716-1-5/8	1⅝	1½	—	10
U-716-1-3/4	1¾	—	—	10
U-716-1-7/8	1⅞	—	1½	10
U-716-2	2	—	—	10
U-716-2-1/8	2⅛	—	—	10
U-716-2-3/8	2⅜	—	—	10
U-717-3/4	—	—	¾	25
U-717-1	—	—	1	10
U-717-1-1/4	—	—	1¼	10

Standard Finish — GoldGalv®

## Pipe Straps, Conduit Clamps and Hangers

### C-716 — Isolator for Copper Tubing

#### Features:

Designed for use with Superstrut® channel and pipe straps and Superstrut® C-711 Hangers, and may also be used with all standard flatbar or malleable iron hangers.

#### Materials:

Manufactured from one-piece steel shell with reinforcing ribs for stiffening and alignment. Padding is of processed non-conducting hairfelt and is cemented to the metal. Design of ribs creates a hinge so isolator may be opened and closed to install.

#### Application:

To provide a means to effectively isolate copper tubing from its supports to prevent the transmission of sound and vibration.

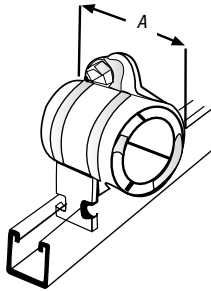

CAT. NO.	SIZE (IN.)	NOMINAL PIPE SIZE (IN.)	HANGER, C-711 OR PIPE STRAP, 702	WIDTH A (IN.)	STD. CTN.
C716 1/2	1/2	1/2	3/4	2 5/8	100
C-716-3/4	3/4	3/4	3/4	2 5/8	100
C-716-1	1	1	1	2 5/8	100
C-716-1-1/4	1 1/4	1 1/4	1 1/4	2 5/8	50
C-716-1-1/2	1 1/2	1 1/2	1 1/2	2 5/8	50
C-716-2	2	2	2 1/2	2 5/8	50
C-716-2-1/2	2 1/2	2 1/2	3	2 15/32	50
C-716-3	3	3	3 1/2	2 5/8	50
C-716-3-1/2	3 1/2	3 1/2	4	4 1/4	30
C-716-4	4	4	5	4 1/4	20

Order by Cat. No. and size.  
Standard Finish — GoldGalv®

### S716 — Cushioned Strip — For Isolation and Vibration Applications

For use with 701 O.D. tubing and pipe clamp. To determine 701 clamp size, add 1/4" to O.D. tube size to allow for the cushioned strip material.

1/4" markings for fast measuring and cutting. Measurement chart is printed on back of carton. 20 feet included in each carton.

Prevent metal-to-metal contact with the cushioned strip material. It aids in sound insulation, shock absorption and protects against corrosion, distortion and abrasion. Cushioned strip material is designed for optimal use between -30° F and 300° F. Cushioned strip material combined with the Superstrut® 701 pipe strap can handle clamping assignments from 1/4" to 6.

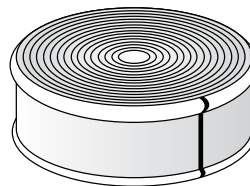

S716

Sold in a carton of 20 feet.

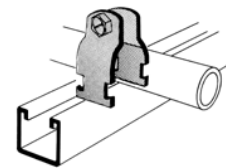

Order 701 clamp separately.



CUSH-A-STRIP



1/8"

### C-708-U — Short Strap for Channel or Wall Mounting

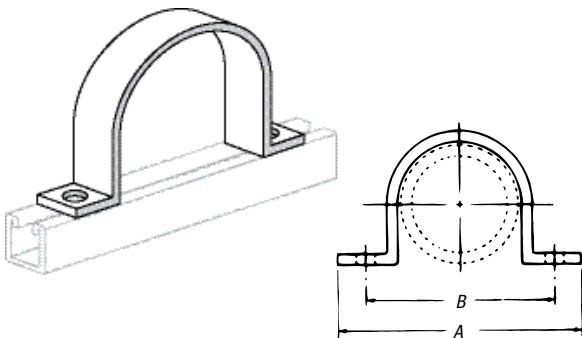

CAT. NO.	DIMENSIONS (IN.)					DESIGN LOAD LBS.	STD. CTN.
	PIPE SIZE	A	B	HOLE SIZE	STOCK SIZE		
C-708-U-1/2	1/2	2 7/8	2	9/32	1/8 x 1 1/8	650	50
C-708-U-3/4	3/4	3 1/16	2 3/16	9/32	1/8 x 1 1/8	650	50
C-708-U-1	1	3 3/8	2 1/2	9/32	1/8 x 1 1/8	650	50
C-708-U-1-1/4	1 1/4	3 15/16	2 3/16	9/32	1/8 x 1 1/8	650	25
C-708-U-1-1/2	1 1/2	3 15/16	3 1/16	9/32	1/8 x 1 1/8	650	25
C-708-U-2	2	5 3/4	4 1/8	7/16	1/4 x 1 5/8	650	25
C-708-U-2-1/2	2 1/2	6 3/16	4 9/16	7/16	1/4 x 1 5/8	1,000	25
C-708-U-3	3	6 3/16	5 3/16	7/16	1/4 x 1 5/8	1,000	25
C-708-U-3-1/2	3 1/2	7 5/16	5 11/16	7/16	1/4 x 1 15/32	1,000	25
C-708-U-4	4	7 13/16	6 3/16	7/16	1/4 x 1 15/32	1,200	25
C-708-U-5	5	8 7/8	7 1/4	7/16	1/4 x 1 15/32	1,200	10
C-708-U-6	6	9 15/16	8 3/16	7/16	1/4 x 1 1/8	1,200	10

Carbon Steel.  
Standard Finish — GoldGalv®

## Pipe Straps, Conduit Clamps and Hangers

### CB118 — Counter Bed

CAT. NO.	STD. CTN.
<i>Counter Bed</i>	
CB118-047PG	100
CB118-055PG	100
CB118-070PG	100
CB118-090PG	100
CB118-110PG	100

CAT. NO.	STD. CTN.
<i>Counter Bed</i>	
CB118-140PG	100
CB118-175PG	100
CB118-200PG	100
CB118-250PG	100
CB118-300PG	100

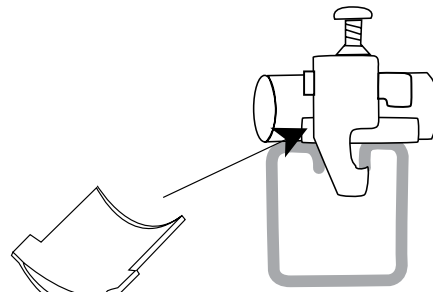

CB118  
Counter Bed

### EB118 — Extended Bed

CAT. NO.	STD. CTN.
<i>Extended Bed</i>	
EB118-047PG	100
EB118-055PG	100
EB118-070PG	100
EB118-090PG	100
EB118-110PG	100

CAT. NO.	STD. CTN.
<i>Extended Bed</i>	
EB118-140PG	100
EB118-175PG	1
EB118-200PG	1
EB118-250PG	1
EB118-300PG	1

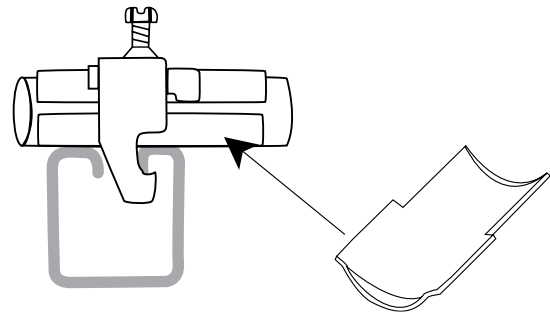

EB118  
Extended Bed

### DB118 — Double Bed

CAT. NO.	STD. CTN.
<i>Double Bed</i>	
DB118-047PG	1
DB118-055PG	1

*Note: Not sold in pairs.*

CAT. NO.	STD. CTN.
<i>Double Bed</i>	
DB118-070PG	1
DB118-090PG	1

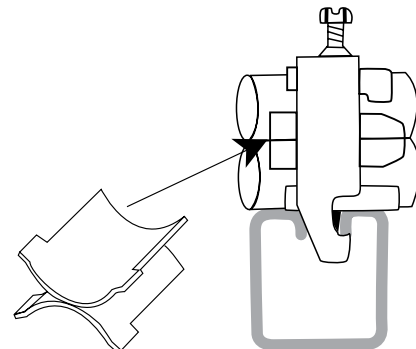

DB118  
Double Bed



## Pipe Straps, Conduit Clamps and Hangers

### C-755 — Porcelain Cable Clamps

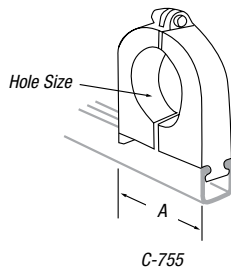

CAT. NO.	HOLE SIZE (IN.)	A (IN.)	STD. CTN.
C-755-1A	3/8	1 1/16	10
C-755-1B	1/2	1 1/16	10
C-755-1C	5/8	1 1/16	10
C-755-2	3/4	2 3/32	10
C-755-2A	7/8	2 3/32	10
C-755-2B	1	2 3/32	10
C-755-2C	1 1/8	2 3/32	10
C-755-3	1 1/4	2 3/8	10
C-755-3A	1 3/8	2 3/8	10
C-755-3B	1 1/2	2 3/8	10
C-755-3C	1 5/8	2 3/8	10
C-755-4	1 3/4	3 3/8	10
C-755-4A	1 7/8	3 3/8	10
C-755-4B	2	3 3/8	10
C-755-4C	2 1/8	3 3/8	10
C-755-5	2 1/4	4 1/4	10
C-755-5A	2 3/8	4 1/4	10
C-755-5B	2 1/2	4 1/4	10
C-755-5C	2 5/8	4 1/4	10
C-755-6	2 5/8	4 3/8	10
C-755-6A	2 7/8	4 3/8	10
C-755-6B	3	4 3/8	10
C-755-6C	3 1/8	4 3/8	10
C-755-7	3 1/4	5 1/16	10
C-755-7A	3 3/8	5 1/16	10
C-755-7B	3 1/2	5 1/16	10
C-755-7C	3 5/8	5 1/16	10
C-755-8	3 3/8	6 3/8	5
C-755-8A	3 5/8	6 3/8	5
C-755-8B	4	6 3/8	5
C-755-8C	4 1/8	6 3/8	5
C-755-8D	4 1/4	6 3/8	5
C-755-8E	4 3/8	6 3/8	5
C-755-8F	4 1/2	6 3/8	5

Finish — GoldGalv® brand with bronze hardware.

Also fits 1 1/2" wide channel.

### C-755 — TPE Cable Clamps

An easy-to-use one-piece insulator made from Sarlink 4339D, a flame-retardant, high hardness grade TPE polymer that is UL Listed. The tapered flange of the insulator ensures complete isolation and protection of the cable. Options include a Stainless Steel Clamp and hardware or an Electro-Galvanized Clamp with Everdur nut and bolt.



- Non-breakable TPE material
- Exceptional chemical resistance
- Dielectric strength of 640 volts per mil
- Stainless Steel Clamps Type 304 or 316
- Electro-Galvanized Steel Clamps with Everdur Nut and Bolt
- Flame-retardant TPE insulator
- Excellent UV resistance

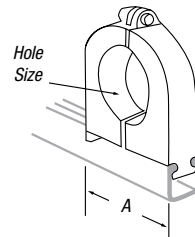

CAT. NO.	HOLE SIZE (IN.)	A (IN.)	CAT. NO.	HOLE SIZE (IN.)	A (IN.)
C755 1ATP	3/8	1.36	C-755-5B-TP	2 1/2	3.36
C-755-1B-TP	1/2	1.36	C-755-5C-TP	2 5/8	3.36
C-755-1C-TP	5/8	1.36	C-755-6-TP	2 3/4	3.86
C-755-2-TP	3/4	1.86	C-755-6A-TP	2 7/8	3.86
C-755-2A-TP	7/8	1.86	C-755-6B-TP	3	3.86
C-755-2B-TP	1	1.86	C-755-6C-TP	3 1/8	3.86
C-755-2C-TP	1 1/8	1.86	C-755-7-TP	3 1/4	4.36
C-755-3-TP	1 1/4	2.36	C-755-7A-TP	3 3/8	4.36
C-755-3A-TP	1 3/8	2.36	C-755-7B-TP	3 1/2	4.36
C-755-3B-TP	1 1/2	2.36	C-755-7C-TP	3 5/8	4.36
C-755-3C-TP	1 5/8	2.36	C-755-8-TP	3 3/4	4.86
C-755-4-TP	1 3/4	2.86	C-755-8A-TP	3 7/8	4.86
C-755-4A-TP	1 7/8	2.86	C-755-8B-TP	4	4.86
C-755-4B-TP	2	2.86	C-755-8C-TP	4 1/8	4.86
C-755-4C-TP	2 1/8	2.86	C-755-8D-TP	4 1/4	5.24
C-755-5-TP	2 1/4	3.36	C-755-8E-TP	4 3/8	5.24
C-755-5A-TP	2 3/8	3.36	C-755-8F-TP	4 1/2	5.24

## Pipe Straps, Conduit Clamps and Hangers

### HS Series Two-Hole Pipe Strap



CAT. NO.	PIPE SIZE (IN.)	STD. CTN.
HS901	1/2	500
HS902	3/4	500
HS903	1	500
HS904	1 1/4	250
HS905	1 1/2	250
HS906	2	125
HS907	2 1/2	125
HS908	3	100
HS909	3 1/2	75
HS910	4	50

Standard Finish — Galvanized.

Carbon steel.

Specify pipe size and catalog number.

For stainless steel, add suffix SS.

### HS Series One-Hole Pipe Straps



CAT. NO.	PIPE SIZE (IN.)	STD. CTN.
HS100	3/8	500
HS101	1/2	500
HS102	3/4	500
HS103	1	500
HS104	1 1/4	250
HS105	1 1/2	250
HS106	2	50
HS107	2 1/2	25
HS108	3	25
HS109	3 1/2	25
HS110	4	25

For stainless steel, add suffix SS.

### C-720, C-720SS — Extension Riser Clamp

Designed for the support or steadying of vertical pipe risers. It is made of carbon steel and is designed to hold tight to the pipe, transmitting the load to the structure through the ears on each end. When possible, the clamp should be placed under a coupling, hub or lugs welded to the pipe.

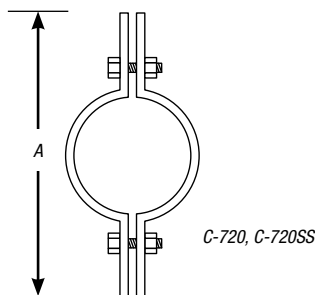

#### Specifications

- Material: Carbon Steel
- Finish: Standard Finish — GoldGalv®, Black (add suffix “-B”), Electro-Galvanized (add suffix “-EG”).
- Compliance: Federal Specification A-A-1192A Type 8, MSS-SP-69 (Type 8) and BSPSS-BS3974.

**Note:** This product is not designed to be supported with rods. Install using the maximum suggested torque values shown in the Technical Section of this catalog.

CAT. NO.	PIPE SIZE (IN.)	MAX. LOAD (LBS.)	A (IN.)	WT. EACH
C-720-1/2	1/2	255	9	1.00
C-720-3/4	3/4	255	8 7/8	1.08
C-720-1	1	255	8 7/8	1.08
C-720-1-1/4	1 1/4	255	10	1.86
C-720-1-1/2	1 1/2	255	10 1/4	1.22
C-720-2	2	255	10 1/4	1.30
C-720-2-1/2	2 1/2	390	11 1/4	1.74
C-720-3	3	530	11 3/8	1.98
C-720-3-1/2	3 1/2	670	12 7/8	2.14
C-720-4	4	810	12 7/8	2.28
C-720-5	5	1,160	13 3/4	3.60
C-720-6	6	1,570	14 3/4	3.68
C-720-8	8	2,500	18 1/2	7.26
C720 10	10	2,500	20 3/4	11.00
C-720-12	12	2,700	22 3/4	15.94
C-720-14	14	2,700	24	17.36
C-720-16	16	2,900	26	29.68
C-720-18	18	2,900	28	31.64
C-720-20	20	2,900	30	34.84
C-720-24	24	2,900	34	50.00

Standard Finish — GoldGalv®, unless otherwise stated.

## Pipe Straps, Conduit Clamps and Hangers

### C-720L — Offset Pipe Clamp

The Offset Pipe Clamp is used on pipe lines running at a fixed distance from a wall or floor. The standard clearance is two inches from the O.D. of pipe to the face of the surface. Non-standard clearances can be fabricated upon request.

#### Specifications

- Material: Carbon Steel
- Load Rating: Up to 650° F (343° C)
- Finish: Standard Finish – GoldGalv®, Black (add suffix “-B”), Electro-Galvanized (add suffix “-EG”)
- Ordering: Specify pipe size, catalog number and finish

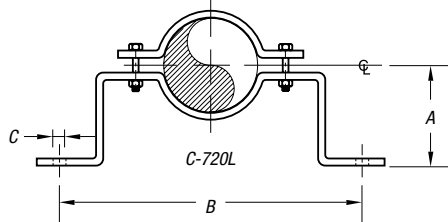

CAT. NO.	PIPE SIZE (IN.)	MAX. LOAD (LBS.)	A (IN.)	B (IN.)	C (IN.)	WT. EACH (LBS.)
C-720L-1/2	1/2	190	2 7/16	8 1/2	7/16	1.1
C-720L-3/4	3/4	190	2 3/4	8 3/4	7/16	1.3
C-720L-1	1	190	2 7/8	9 1/4	7/16	1.4
C-720L-1-1/4	1 1/4	190	3 1/16	9 3/4	7/16	1.5
C-720L-1-1/2	1 1/2	190	3 3/16	10	7/16	1.6
C-720L-2	2	420	3 1/2	11 1/4	9/16	2.8
C-720L-2-1/2	2 1/2	420	3 3/4	11 3/4	9/16	2.9
C-720L-3	3	420	4 1/16	12 7/8	9/16	3.2
C-720L-4	4	610	4 9/16	13 3/8	9/16	4.2
C-720L-5	5	610	5 1/16	15 3/8	1 1/16	6.5
C-720L-6	6	870	5 5/8	16 3/4	1 1/16	7.2
C-720L-8	8	870	6 3/8	18 3/4	1 1/16	8.3
C-720L-10	10	1,050	7 3/8	21 1/2	1 3/16	12.4
C-720L-12	12	1,200	8 3/8	24 7/8	1 3/16	21.0

Standard Finish – GoldGalv®, unless otherwise stated.

### CX-725 — Extended Offset Pipe Clamp

Designed to attach directly to piping where the exact distance between the structure and the pipe cannot be determined until the piping is in place. The extended legs can be modified in the field to suit the location. Legs of longer lengths can be furnished on order.

#### Specifications

- Material: Carbon Steel
- Finish: Standard Finish – Black (add suffix “-B”), Electro-Galvanized (add suffix “-EG”)
- Ordering: Specify pipe size, catalog number and finish

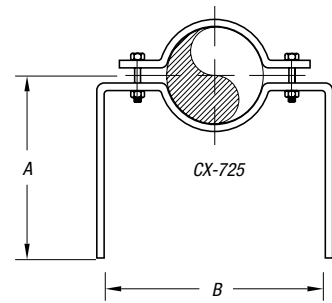

CAT. NO.	PIPE SIZE (IN.)	A (IN.)	B (IN.)	WT. EACH (LBS.)
CX-725-3/8	3/8	12	3 3/4	1.85
CX-725-1/2	1/2	12	3 3/4	1.85
CX-725-3/4	3/4	12	4 1/4	1.85
CX-725-1	1	12	5 1/2	2.34
CX-725-1-1/4	1 1/4	12	5 5/8	2.40
CX-725-1-1/2	1 1/2	12	6 1/8	2.45
CX-725-2	2	12	7	3.13
CX-725-2-1/2	2 1/2	12	7 1/2	4.21
CX-725-3	3	12	7 7/8	4.47
CX-725-4	4	12	10 1/2	4.90
CX-725-5	5	12	12 1/4	4.90
CX-725-6	6	12	13	5.32
CX-725-8	8	12	15 1/4	11.20
CX-725-10	10	12	18 1/4	13.50
CX-725-12	12	12	20 3/4	22.00
CX-725-14	14	12	21	35.00

Standard Finish – GoldGalv®, unless otherwise stated.

### C-720P — PVC-Coated Riser Clamp

The C-720P is normally used for the support of uninsulated vertical piping where no movement will occur. PVC coating the contact surface prevents galvanic corrosion with the pipe. Please use our C-720 for carbon steel piping or CT-720 for copper tubing requirements.

**Note:** This product is not designed to be supported with rods. Install using the maximum suggested torque values shown in the Technical Section of this catalog.

#### Specifications

- Material: Carbon Steel
- Finish: Polyvinyl Chloride
- Compliance: Federal Specification A-A-1192A Type 8, MSS-SP-69 T 1400° F/600° C
- Ordering: Specify pipe size and catalog number

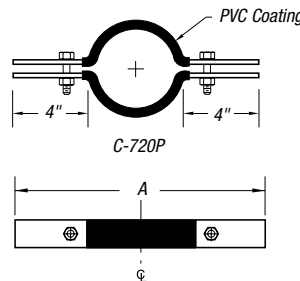

CAT. NO.	PIPE SIZE (IN.)	MAX. LOAD (LBS.)	A (IN.)	WT. EACH (LBS.)
C720P-1/2	1/2	225	9 3/8	1.30
C-720P-3/4	3/4	225	9 3/8	1.36
C-720P-1	1	225	9 3/8	1.38
C-720P-1-1/4	1 1/4	225	10	1.95
C-720P-1-1/2	1 1/2	225	10 3/8	2.01
C-720P-2	2	225	10 3/4	2.17
C-720P-2-1/2	2 1/2	390	11 1/4	2.29
C-720P-3	3	530	12	2.50
C-720P-4	4	810	13 1/2	3.42

Standard Finish – GoldGalv®, unless otherwise stated.

## Pipe Straps, Conduit Clamps and Hangers

### CT-720 — Copper Riser Clamp

Normally used for the support of uninsulated vertical tubing where no movement will occur. Please use C-720 for carbon steel piping or C-720P for plastic coating requirements.

**Note:** This product is not designed to be supported with rods. Install using the maximum suggested torque values shown in the Technical Section of this catalog.

#### Specifications

- Material: Carbon Steel
- Compliance: Federal Specification A-A-1192A Type 8, MSS-SP-69 Type 8
- Finish: Copper
- Ordering: Specify tubing size and catalog number

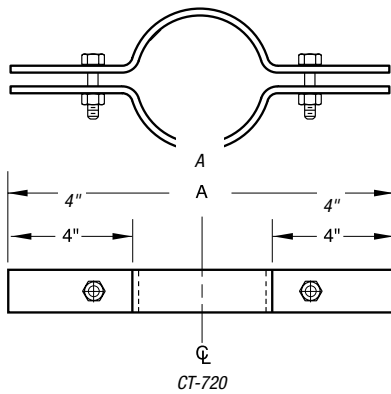

CAT. NO.	TUBE SIZE (IN.)	MAX. LOAD (LBS.)	A (IN.)	WT. EACH (LBS.)
CT-720-1/2	1/2	220	9 <sup>5</sup> / <sub>16</sub>	.70
CT-720-3/4	3/4	220	9 <sup>5</sup> / <sub>16</sub>	.74
CT720 1	1	220	9 <sup>1</sup> / <sub>2</sub>	.75
CT-720-1-1/4	1 <sup>1</sup> / <sub>4</sub>	220	9 <sup>3</sup> / <sub>4</sub>	.77
CT-720-1-1/2	1 <sup>1</sup> / <sub>2</sub>	220	10 <sup>1</sup> / <sub>8</sub>	.80
CT-720-2	2	220	10 <sup>1</sup> / <sub>2</sub>	.84
CT-720-2-1/2	2 <sup>1</sup> / <sub>2</sub>	390	11	1.60
CT-720-3	3	530	11 <sup>5</sup> / <sub>8</sub>	1.80
CT-720-3-1/2	3 <sup>1</sup> / <sub>2</sub>	530	12 <sup>1</sup> / <sub>8</sub>	1.95
CT-720-4	4	530	13 <sup>1</sup> / <sub>8</sub>	2.04
CT-720-5	5	810	14	3.50
CT-720-6	6	1,570	15	5.25

Standard Finish — GoldGalv®, unless otherwise stated.

### C-724 — Ductile Iron Pipe Clamp

Can be used to secure mechanical joint piping or socket fittings together to prevent separation under pressure either under or above ground, vertically or horizontally. If using in this fashion, two (2) W-724 Socket Clamp Washers and Figure 133 Rods are also required, but must be ordered separately. The C-724 may also be used to support and guide vertical ductile iron pipe.

#### Specifications

- Materials: Carbon Steel
- Finish: Standard Finish — GoldGalv®, Black (add suffix "-B"), Electro-Galvanized (add suffix "-EG")
- Ordering: Specify pipe size, catalog number and finish

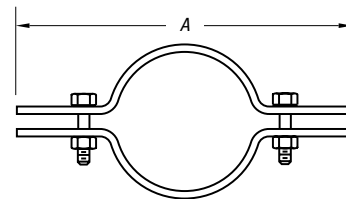

C-724

CAT. NO.	PIPE SIZE (IN.)	ACTUAL PIPE O.D.	A (IN.)	WASHER SIZE (IN.)	WT. EACH (LBS.)
C-724-3	3	3.96	12 <sup>1</sup> / <sub>4</sub>	3/4	9.00
C-724-4	4	4.8	13 <sup>3</sup> / <sub>4</sub>	3/4	9.00
C-724-6	6	6.9	15 <sup>3</sup> / <sub>4</sub>	3/4	10.70
C-724-8	8	9.05	18	3/4	12.20
C-724-10	10	11.1	20 <sup>1</sup> / <sub>8</sub>	3/4	14.60
C-724-12	12	13.2	22 <sup>1</sup> / <sub>8</sub>	3/4	16.60
C-724-14	14	15.3	25 <sup>1</sup> / <sub>2</sub>	1 <sup>1</sup> / <sub>4</sub>	41.90
C-724-16	16	17.4	28	1 <sup>1</sup> / <sub>4</sub>	61.90
C-724-18	18	19.5	33	1 <sup>1</sup> / <sub>4</sub>	65.10
C-724-20	20	21.6	35 <sup>1</sup> / <sub>2</sub>	1 <sup>1</sup> / <sub>2</sub>	92.20
C-724-24	24	25.8	40 <sup>1</sup> / <sub>2</sub>	1 <sup>1</sup> / <sub>2</sub>	122.70
C-724-30	30	32	48	1 <sup>1</sup> / <sub>2</sub>	184.00

Standard Finish — GoldGalv®, unless otherwise stated.

## Pipe Straps, Conduit Clamps and Hangers

### C-725 — Two-Bolt Pipe Clamp

Designed to suspend cold or hot pipe lines where little or no insulation is required. The C-725 is usually used with an E-120-A Weldless Eyunut or E-157 Welded EyeroD. See Figure 298 heavy-duty Two-Bolt Clamp when higher loads are required. We will also design to meet special requirements such as special pipe sizes.

Rated Loads are for up to 750° F (399° C).

#### Specifications

- Material: Carbon Steel
- Compliance: Federal Specification A-A-1192A Type 4, MSS-SP-69 Type 4 and BSPSS-BS3974
- Finish: Standard Finish – GoldGalv®, Black (add suffix “-B”), Electro-Galvanized (add suffix “-EG”)
- Ordering: Specify catalog number, finish and pipe size. Also, include any special requirements for C-725

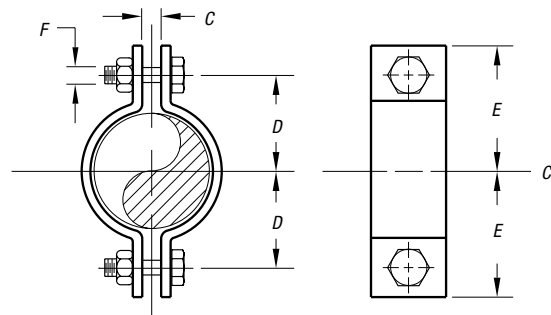

C-726

CAT. NO.	PIPE SIZE (IN.)	MAXIMUM LOAD		C (IN.)	ROD TAKE OUT			WT. EACH (LBS.)
		650° F/343° C	750° F/343° C		D (IN.)	E (IN.)	F (IN.)	
C725 1/2	1/2	500	445	3/8	1 1/8	1 1/8	3/8	.31
C-725-3/4	3/4	500	445	3/8	1 1/4	1 3/4	3/8	.35
C-725-1	1	500	445	3/8	1 3/8	1 7/8	3/8	.39
C-725-1-1/4	1 1/4	500	445	3/8	1 7/8	2 1/8	3/8	.40
C-725-1-1/2	1 1/2	800	715	3/8	1 3/4	2 1/4	3/8	.45
C-725-2	2	1,040	930	1/2	2 1/8	2 5/8	1/2	1.23
C-725-2-1/2	2 1/2	1,040	930	5/8	2 5/8	3 1/8	1/2	1.33
C-725-3	3	1,040	930	5/8	3	3 1/2	1/2	1.53
C-725-4	4	1,040	930	3/4	3 3/8	4 1/8	1/2	2.20
C-725-5	5	1,040	930	3/4	4 1/4	5	1/2	2.39
C-725-6	6	1,615	1,440	7/8	5 1/4	6 1/4	3/4	5.87
C-725-8	8	1,615	1,440	1	6 3/8	7 3/8	3/4	6.95
C-725-10	10	2,490	2,220	1	7 3/8	8 3/4	7/8	14.39
C-725-12	12	2,490	2,220	1 1/8	8 3/4	10 1/4	7/8	16.73
C-725-14	14	2,490	2,220	1 1/8	9 1/4	10 5/8	7/8	21.26
C-725-16	16	2,490	2,220	1 1/8	10 1/4	11 5/8	7/8	23.39
C-725-18	18	3,060	2,730	1 1/4	11 1/8	13	1	32.96
C-725-20	20	3,060	2,730	1 1/2	12 1/4	14 1/8	1 1/8	36.74
C-725-24	24	3,060	2,730	1 1/2	15 1/4	16 5/8	1 1/8	52.96
C-725-30	30	3,500	3,360	2	18 1/2	20 3/4	1 1/2	103.50

Standard Finish – GoldGalv®, unless otherwise stated.

## Pipe Straps, Conduit Clamps and Hangers

### C-726 — Three-Bolt Pipe Clamp

Designed for hot-insulated pipe lines up to 750° F. The spacer on the top inner bolt provides uniform space for the connecting eyerod or weldless eyenut. We will also design to meet special requirements such as special pipe sizes.

Rated Loads are for up to 750° F (399° C).

#### Specifications

- Material: Carbon Steel
- Federal Specification A-A-1192A Type 3, MSS-SP-69 Type 3 and BSPSS-BS3974
- Finish: Standard Finish – GoldGalv®, Black (add suffix “-B”), Electro-Galvanized (add suffix “-EG”)
- Ordering: Specify catalog number, finish and pipe size. Also, include any special requirements

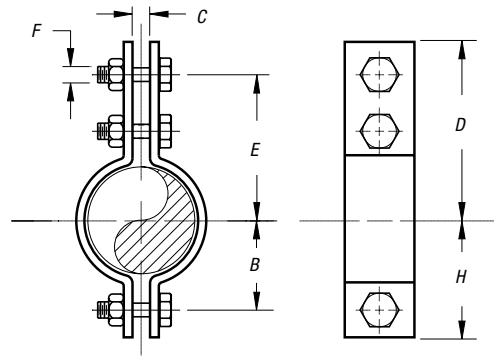

C-726

CAT. NO.	PIPE SIZE (IN.)	MAXIMUM LOAD		B (IN.)	C (IN.)	D (IN.)	TAKE OUT E (IN.)	F (IN.)	H (IN.)	WT. EACH (LBS.)
		650° F/343° C	750° F/399° C							
C-726-1/2	1/2	950	845	1	5/8	2 7/8	2 1/4	3/8	1 7/8	.61
C-726-3/4	3/4	950	845	1 1/8	5/8	3 1/4	2 1/2	3/8	1 3/4	.66
C-726-1	1	950	845	1 1/2	5/8	3 3/4	2 1/2	3/8	2 1/4	.69
C-726-1/4	1 1/4	950	845	1 1/2	3/4	3 3/8	2 7/8	3/8	2 1/4	.75
C-726-1-3/4	1 3/4	1,545	1,380	1 3/4	1	4 7/8	4 1/4	5/8	2 1/2	2.14
C-726-2	2	1,545	1,380	2 1/4	1 1/4	5 7/8	5 1/4	5/8	2 3/4	2.43
C-726-2-3/4	2 3/4	1,545	1,380	2 1/4	1 1/4	6 1/4	5 3/8	5/8	3	2.92
C-726-3	3	1,545	1,380	2 3/4	1 1/4	6 3/8	6	5/8	3 1/2	3.19
C-726-4	4	2,500	2,230	3 3/8	1	7 7/8	6 1/2	3/4	4 1/2	7.12
C-726-5	5	2,500	2,230	4	1 1/4	8 1/4	7	3/4	5 1/4	7.96
C-726-6	6	2,865	2,555	4 3/4	1 1/4	9 5/8	8 1/4	7/8	6 1/4	11.85
C-726-8	8	2,865	2,555	5 3/4	1 1/4	10 5/8	9 1/4	7/8	7 1/4	13.59
C-726-10	10	3,240	2,890	6 7/8	1 1/4	12	10 1/2	1	8 1/4	21.33
C-726-12	12	3,240	2,890	8 3/8	1 1/2	13	11 1/2	1	9 7/8	23.65
C-726-14	14	4,300	3,835	9 1/4	2	14 3/8	12 3/4	1 1/4	10 3/4	38.78
C-726-16	16	4,300	3,835	10	2	15 5/8	14	1 1/4	11 3/4	42.89
C-726-18	18	4,300	3,835	11 1/8	2	16 3/4	15 1/4	1 1/4	13 1/4	46.35
C-726-20	20	4,500	4,015	12 3/8	2	17 1/2	15 7/8	1 3/8	14	58.67
C-726-24	24	5,490	4,900	14 3/4	2	19 7/8	17 7/8	1 1/2	16 3/8	89.32
C-726-30	30	7,500	6,690	18 1/2	1 1/2	26 3/8	23 3/8	1 1/2	21	140.89
C-726-36	36	1,0500	9,360	22 1/2	3	32 1/4	28 3/4	1 3/4	26	246.44

Standard Finish – GoldGalv® unless otherwise stated.

## Pipe Straps, Conduit Clamps and Hangers

### Pipe Clamps — A-726, Alloy Three-Bolt Pipe Clamp

Designed for hot-insulated pipelines. The spacer on the top inner bolt provides uniform space for the connecting eyerod or weldless eyenut.

Temperature range: above 750° F (399° C) to 1050° F (566° C).

- Specifications**
- Material: Chromium Molybdenum Steel, ASTM A-387 Grade 22
  - Compliance: Federal Specification A-A-1192A Type 3, MSS-SP-69 Type 3 and BSPSS-BS3974
  - Finish: Standard Finish – GoldGalv®, Black (add suffix “-B”), Electro-Galvanized (add suffix “-EG”)
  - Ordering: Specify catalog number and pipe size

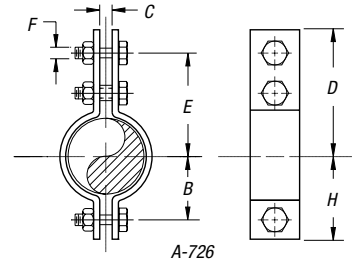

CAT. NO.	PIPE SIZE (IN.)	MAXIMUM LOAD			B (IN.)	C (IN.)	D (IN.)	TAKE OUT E (IN.)	F (IN.)	H (IN.)	(LBS.)
		950° F/510° C	1000° F/538° C	1050° F/566° C							
A-726-3/4	¾	870	600	440	1½	¾	3	2½	¾	1½	1.09
A-726-1	1	870	600	440	1½	¾	3½	2½	¾	1¾	1.14
A-726-1-1/4	1¼	870	600	440	1½	¾	3¾	2½	¾	2¼	1.23
A-726-1-1/2	1½	1,400	1,000	700	1¾	1	4½	4½	¾	2½	2.48
A-726-2	2	1,400	1,000	700	2½	1	5½	5½	¾	2¾	2.70
A-726-2-1/2	2½	1,400	1,000	700	2½	1	6½	5½	¾	3	2.76
A-726-3	3	1,400	1,000	700	2¾	1	6¾	6	¾	3½	3.19
A-726-4	4	2,300	1,600	1,100	3¾	1	7½	6½	¾	4½	7.30
A-726-5	5	2,300	1,600	1,100	4	1½	8½	7	¾	5½	7.96
A-726-6	6	2,600	1,800	1,300	4¾	1½	10	8½	¾	6½	12.26
A-726-8	8	2,600	1,800	1,300	5¾	1½	11	9½	¾	7½	14.04
A-726-10	10	3,000	2,100	1,500	6¾	1½	12	10½	1	8¼	21.33
A-726-12	12	3,000	2,100	1,500	8¾	1½	13¾	11½	1	9½	24.00
A-726-14	14	3,900	2,800	2,000	9¾	2	14¾	12¾	1¼	10¾	38.78
A-726-16	16	3,900	2,800	2,000	10	2	15¾	14	1¼	11¾	43.13
A-726-18	18	39	2,800	2,000	11¾	2	16¾	15½	1¼	13¼	47.78
A-726-20	20	5,000	3,200	2,000	12¾	2	17¾	15½	1½	14	58.67
A-726-24	24	5,500	3,500	2,700	14¾	1½	19¾	17½	1½	16½	90.82

Standard Finish – GoldGalv®, unless otherwise stated.

### Pipe Hangers — C-710, C-710F, C-710P, C-710SS

Designed to support non-insulated, stationary lines from above, allowing for approximately 1" to 1½" of vertical adjustment after the pipe is in place. The lower nut (not furnished) adjusts the pipe line to the proper elevation, the top nut (not furnished) prevents loosening due to vibration and must be tightened securely to assure proper hanger performance.

Rated Loads are for up to 650° F (343° C) for carbon steel. Maximum PVC temperature is 140° F (60° C).

- Specifications**
- Material: Carbon Steel (Also available in Stainless Steel as C-710SS)
  - Compliance: Federal Specification A-A-1192A Type 1, MSS-SP-69 Type 1, BSPSS-BS3974, UL and FM
  - Finish: Standard Finish – GoldGalv®, Black (add suffix “-B”), Electro-Galvanized (add suffix “-EG”)
  - Ordering: Specify catalog number, finish and pipe size

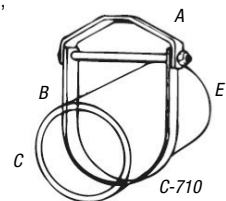

CAT. NO.	PIPE SIZE (IN.)	MAX. LOAD (LBS.)	A (IN.)	B (IN.)	C (IN.)	ROD TAKE OUT E (IN.)	WT. EACH (LBS.)
C-710-1/2	½	610	¾	2¼	3½	1½	.27
C-710-3/4	¾	610	¾	2½	2¾	1½	.29
C-710-1	1	610	¾	3	3¼	2¼	.33
C-710-1-1/4	1¼	610	¾	3½	4	2¼	.36
C-710-1-1/2	1½	610	¾	3¾	4¼	2¾	.42
C-710-2	2	610	¾	3¾	4½	3½	.52
C-710-2-1/2	2½	1,130	½	4½	5½	3½	.61
C-710-3	3	1,130	½	5	6¼	4½	.90
C-710-3-1/2	3½	1,130	½	4½	6½	3½	.99
C-710-4	4	1,430	¾	5½	7¼	4½	1.40
C-710-5	5	1,430	¾	6	8½	5	2.10
C-710-6	6	1,940	¾	7	10½	5½	3.00

Standard Finish – GoldGalv®, unless otherwise stated.

CAT. NO.	PIPE SIZE (IN.)	MAX. LOAD (LBS.)	A (IN.)	B (IN.)	C (IN.)	ROD TAKE OUT E (IN.)	WT. EACH (LBS.)
C-710-7	7	2,000	¾	7½	11¼	6½	5.42
C-710-8	8	2,000	¾	8½	12¼	6¾	5.25
C-710-10	10	3,600	¾	10	15¾	8¼	9.10
C-710-12	12	3,800	¾	11½	17½	9¼	11.75
C-710-14	14	4,200	1	12½	19½	10½	14.25
C-710-16	16	4,800	1	15	23	13½	20.75
C-710-18	18	4,800	1¼	15¾	24¾	13¾	23.00
C-710-20	20	4,800	1¼	17½	27½	15¼	41.50
C-710-24	24	4,800	1¼	19½	31½	17½	50.00
C-710-30	30	6,000	1¼	24¾	40¾	21¼	68.08
C-710-36	36	9,500	1½	32½	50½	30	68.68

Standard Finish – GoldGalv®, unless otherwise stated.

## Pipe Straps, Conduit Clamps and Hangers

### CL-710 — Light-Duty Clevis Hanger

Designed to support non-insulated, stationary lines from above, allowing for approximately 1" to 1½" of vertical adjustment after the pipe is in place. The lower nut (not furnished) adjusts the pipe line to the proper elevation, the top nut (not furnished) prevents loosening due to vibration and must be tightened securely to assure proper hanger performance.

#### Specifications

- Material: Carbon Steel
- Compliance: Federal Specification A-A-1192A Type 1, MSS-SP-69 Type 1
- Finish: Standard Finish – GoldGalv®, Black (add suffix "-B"), Electro-Galvanized (add suffix "-EG")
- Ordering: Specify catalog number, finish and pipe size

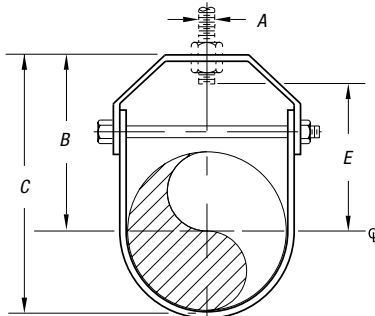

CL-710

CAT. NO.	PIPE SIZE (IN.)	MAX. LOAD (LBS.)	A (IN.)	B (IN.)	C (IN.)	E (IN.)	WT. EACH (LBS.)
CL710 1/2	½	150	¾	1 ⅛	2 ⅞	¾	.27
CL-710-3/4	¾	250	¾	2 ⅜	2 ⅞	1 ½	.29
CL-710-1	1	250	¾	2 ⅞	3 ⅜	1 ⅞	.33
CL-710-1-1/4	1¼	250	¾	2 ⅞	3 ¾	2 ⅞	.36
CL-710-1-1/2	1½	250	¾	3	4	2 ⅞	.42
CL-710-2	2	250	¾	3 ½	4 ¾	2 ¾	.52
CL-710-2-1/2	2½	350	½	4	5 ½	2 ⅞	.81
CL-710-3	3	350	½	4 ¼	6 ⅞	3 ¼	.90
CL-710-3-1/2	3½	350	½	4 ⅞	6 ½	3 ⅞	.99
CL-710-4	4	400	¾	5 ½	7 ⅞	4 ⅞	1.40

Standard Finish – GoldGalv®, unless otherwise stated.

### CTL-710 — Copper Clevis Hanger

Designed to support non-insulated, stationary copper tubing lines from above, allowing for approximately 1" to 1½" of vertical adjustment after the tubing is in place. The lower nut (not furnished) adjusts the pipe line to the proper elevation. The top nut (not furnished) prevents loosening due to vibration and must be tightened securely to assure proper hanger performance.

#### Specifications

- Material: Carbon Steel
- Compliance: Federal Specification A-A-1192A Type 1, MSS-SP-69 Type 1 and BSPSS-BS3974. Rated Loads are for up to 650° F (343° C)
- Finish: Copper
- Ordering: Specify tubing size and catalog number

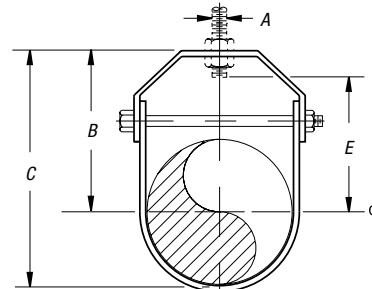

CTL-710

CAT. NO.	PIPE SIZE (IN.)	MAX. LOAD (LBS.)	A (IN.)	B (IN.)	C (IN.)	ROD TAKE OUT E (IN.)	WT. EACH (LBS.)
CTL710 1/2	½	150	¾	2 ⅛	3 ⅜	2 ¼	.16
CTL-710-3/4	¾	250	¾	2 ⅞	3	1 ⅞	.16
CTL-710-1	1	250	¾	2 ⅞	3 ⅜	1 ⅞	.19
CTL-710-1-1/4	1¼	250	¾	3 ⅜	3 ¾	2 ⅞	.22
CTL-710-1-1/2	1½	250	¾	3 ⅞	4 ⅞	2 ⅞	.29
CTL-710-2	2	250	¾	3 ⅞	4 ⅞	2 ⅞	.32
CTL-710-2-1/2	2½	350	½	3 ⅞	4 ⅞	2 ⅞	.72
CTL-710-3	3	350	½	3 ⅞	5 ⅞	2 ⅞	.82
CTL-710-3-1/2	3½	350	½	4 ⅞	5 ⅞	3 ⅞	.91
CTL-710-4	4	350	½	4 ½	6 ¼	3 ½	1.07
CTL-710-5	5	900	¾	5	7 ¼	3 ⅞	1.76
CTL-710-6	6	900	¾	5 ¾	8 ⅞	4 ⅞	1.92

Standard Finish – GoldGalv®, unless otherwise stated.



## Pipe Straps, Conduit Clamps and Hangers

### ETL-710 — Light-Duty Clevis Hanger

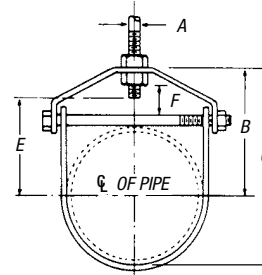
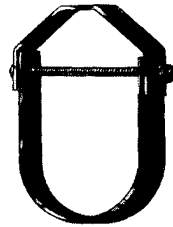

CAT. NO.	TUBING SIZE (IN.)	MATERIAL SIZE	DIMENSIONS (IN.)					STD. CTN.
			A	B	C	E	F	
ETL710 1/2	1/2	16 ga x 7/8	3/8	1 1/16	2 5/16	1 1/4	9/16	100
ETL-710-3/4	3/4	16 ga x 7/8	3/8	1 1/4	2 1/4	1 1/4	9/16	100
ETL-710-1	1	16 ga x 7/8	3/8	1 5/8	2 5/16	1 1/8	1/2	100
ETL-710-1-1/4	1 1/4	16 ga x 7/8	3/8	2	2 3/4	1 1/8	1 1/16	100
ETL-710-1-1/2	1 1/2	16 ga x 7/8	3/8	2 1/2	3 1/8	1 1/4	1	100
ETL-710-2	2	13 ga x 7/8	3/8	2 1/16	4	1 1/2	1 1/16	100
ETL-710-2-1/2	2 1/2	1/8 x 1 1/4	1/2	3 3/4	4 11/16	2	1 1/8	100
ETL-710-3	3	1/8 x 1 1/4	1/2	3 1/2	5 3/16	2 1/4	1 3/16	100
ETL-710-3-1/2	3 1/2	1/8 x 1 1/4	1/2	3 3/4	5 11/16	2 1/2	1 1/8	100
ETL-710-4	4	1/8 x 1 1/4	1/2	4 5/16	6 1/2	3	1 3/16	100
ETL-710-5	5	3/16 x 1 1/4	5/8	5	7 11/16	3 3/8	1 3/16	50
ETL-710-6	6	3/16 x 1 1/4	5/8	5 11/16	8 7/8	4 1/8	1 1/4	50

Standard Finish – GoldGalv®.

Carbon Steel.

Copper tube sized.

For the suspension of stationary copper tubing lines. Order by Cat. No., tubing size.

### CI-710 — Clevis Hanger for Ductile Iron and A.W.W.A. Cast Iron Pipe

Designed to support non-insulated, stationary ductile iron and A.W.W.A. cast iron lines from above, allowing for approximately 1" to 1 1/2" of vertical adjustment after the pipe is in place. The lower nut (not furnished) adjusts the pipe line to the proper elevation. The top nut (not furnished) prevents loosening due to vibration and must be tightened securely to assure proper hanger performance.

#### Specifications

- Material: Carbon Steel
- Compliance: MSS-SP-69 Type 1, A-A-1192A Type 1
- Finish: Standard Finish – GoldGalv®, Black (add suffix "-B"), Electro-Galvanized (add suffix "-EG")
- Ordering: Specify pipe size, catalog number and finish

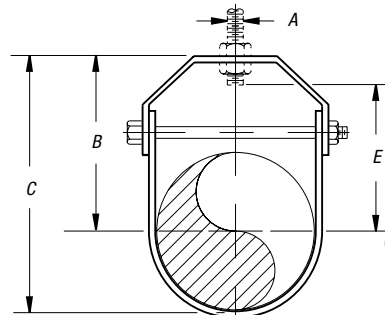

CI-710

CAT. NO.	PIPE SIZE (IN.)	MAX. LOAD (LBS.)	DIMENSIONS (IN.)			ROD TAKE OUT E (IN.)	WT. EACH (LBS.)
			A	B	C		
CI-710-4	4	1,430	3/4	5 3/4	8 3/8	4 3/8	2.08
CI-710-6	6	1,940	7/8	7	10 3/8	5 1/2	2.78
CI-710-8	8	2,000	7/8	9 1/4	13 3/4	7 3/4	4.47
CI-710-10	10	3,600	7/8	10 1/4	15 3/4	8 3/8	8.87
CI-710-12	12	3,800	7/8	12 5/8	19 1/4	11	12.0
CI-710-14	14	4,200	1	14 1/2	21 3/4	12 1/4	15.2
CI-710-16	16	4,800	1	14 7/8	23 3/8	13	23.6
CI-710-18	18	4,800	1 1/4	16 1/2	26 1/4	14 1/2	25.9
CI-710-20	20	4,800	1 1/4	18 3/4	29 1/2	16 1/2	44.3
CI-710-24	24	4,800	1 1/4	21 1/2	34 3/4	19 1/2	53.5

Standard Finish – GoldGalv®, unless otherwise stated.

## Pipe Straps, Conduit Clamps and Hangers

### C-711 — J Pipe Hanger

Standard Finish – GoldGalv® brand

Complies with Specification MSS SP 58, Type 5. Sizes through 5" conform to Ca. Code Title 24, Div. T22 for seismic restraint bracing.

### C-711F — Felt-Lined J Pipe Hanger

Standard Finish – GoldGalv® brand

Available in sizes up to 8".

### C-711P — Plastic-Coated J Pipe Hanger

Standard Finish – GoldGalv® brand

Isolates hanger from glass and other piping for corrosion or cushioning purposes. Available in sizes up to 4". Order by Cat. No. and pipe size. Hole provided for side mounting to wall as bracket.

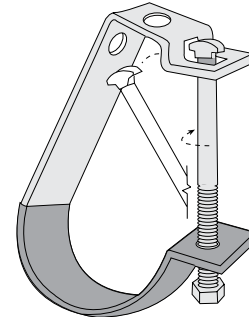

Standard

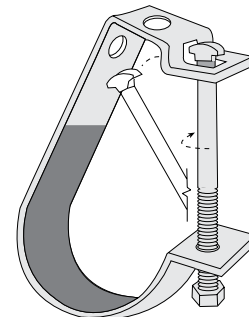

Felt Lined

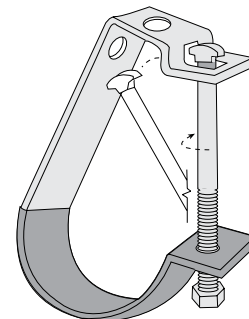

Plastic Coated

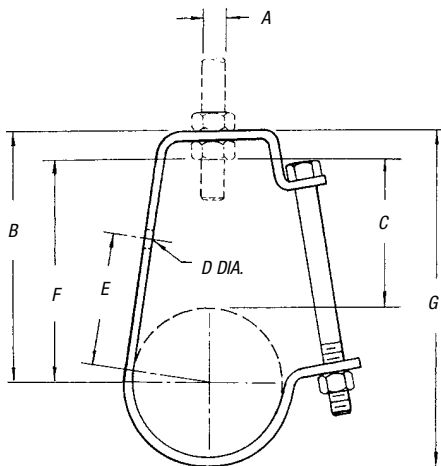

CAT. NO.	PIPE SIZE (IN.)	A ROD SIZE (IN.)	DIMENSIONS (IN.)					BOLT SIZE (IN.)	G (IN.)	STOCK SIZE	MAX REC LOADS (LBS.)	STD. CTN.
			B	C	D	E	F					
C-711-1/2	1/2	3/8	2 5/8	1 3/4	7/16	1 1/2	1 15/16	1/4	3 5/32	12 ga x 3/4	400	50
C-711-3/4	3/4	3/8	2 7/8	1 7/8	7/16	1 11/16	2 1/8	1/4	3 1/2	12 ga x 3/4	400	50
C-711-1	1	3/8	2 15/16	1 15/16	7/16	1 13/16	2 9/16	1/4	3 11/16	12 ga x 3/4	400	50
C-711-1-1/4	1 1/4	3/8	3 1/4	2	7/16	2 1/16	2 5/8	1/4	4 1/8	12 ga x 3/4	400	50
C-711-1-1/2	1 1/2	3/8	3 9/16	2 3/16	7/16	2 7/16	2 7/8	1/4	4 5/8	12 ga x 3/4	400	50
C-711-2	2	3/8	3 11/16	2 1/8	7/16	2 9/16	3 1/16	1/4	5	12 ga x 3/4	400	50
C-711-2-1/2	2 1/2	1/2	4 7/16	2 7/16	9/16	3 3/16	3 5/8	3/8	6	12 ga x 1 1/4	500	25
C-711-3	3	1/2	4 13/16	2 9/16	9/16	3 1/2	4 1/16	3/8	6 21/32	12 ga x 1 1/4	500	25
C-711-3-1/2	3 1/2	1/2	5 1/8	2 5/8	9/16	3 3/4	4 3/8	3/8	7 5/16	3/16 x 1 1/4	500	25
C-711-4	4	5/8	6 1/8	3 3/16	9/16	4 5/8	5 3/16	3/8	8 9/16	3/16 x 1 1/4	550	10
C-711-5	5	5/8	6 3/4	3 1/4	9/16	5 1/16	5 3/8	3/8	9 23/32	3/16 x 1 1/4	550	10
C-711-6	6"	3/4	7 3/4	3 9/16	9/16	5 9/16	6 3/8	3/8	11 1/4	3/16 x 1 3/4	600	10
C-711-8	8"	7/8	9 9/16	3 15/16	9/16	6 15/16	8	3/8	13 11/16	3/16 x 1 3/4	760	8

\*Hangers 6" and over have hole instead of slot.

## Pipe Straps, Conduit Clamps and Hangers

### C-727 — Adjustable Swivel Ring

Designed for the support of non-insulated static pipe lines. The swivel nut is knurled to provide a gripping surface when adjusting the pipe elevation.

#### Specifications

- Compliance: Federal Specification A-A-1192A Type 10, MSS SP-69 Type 10, UL Listed and FM Approved (¾" through 8"). We also offer Swivel Ring hangers that are for Copper Tubing (CT-727), PVC coated (C-727-P) and for NFPA requirements (C-727-NFPA) in this catalog
- Material: Carbon Steel
- Finish: Standard Finish – Pre-Galv, Electro-Galvanized (add suffix "-EG") Black (add suffix "-B")
- Ordering: Specify pipe size, catalog number and finish

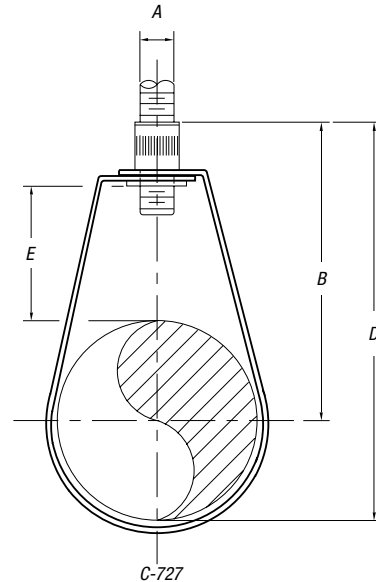

CAT. NO.	PIPE SIZE (IN.)	MAX LOAD (LBS.)	DIMENSIONS (IN.)				WT. EACH (LBS.)
			A	B	D	E	
C-727-1/2	½	300	⅜	2¼	3⅛	1⅛	.09
C-727-¾	¾	300	⅜	2½	3⅛	1⅛	.10
C-727-1	1	300	⅜	2½	3⅞	1	.10
C-727-1-1/4	1¼	300	⅜	2⅜	3⅞	1⅛	.10
C-727-1-1/2	1½	300	⅜	3⅛	3⅞	1⅛	.11
C-727-2	2	300	⅜	3⅝	4⅜	1⅛	.12
C-727-2-1/2	2½	600	½	3⅞	5⅞	1¼	.32
C-727-3	3	600	½	4	5⅞	1⅞	.35
C-727-3-1/2	3½	600	½	4⅞	6⅞	1½	.39
C-727-4	4	1,000	⅝	4⅝	7⅞	1¼	.43
C-727-5	5	1,000	⅝	5⅞	8½	1⅞	.65
C-727-6	6	1,250	¾	6⅞	10⅞	2	1.09
C-727-8	8	1,800	7⁄8	8⅞	12⅞	2⅞	1.24

Standard Finish: Pre-Galv only.

Add "F" suffix for felt lining.

## Pipe Straps, Conduit Clamps and Hangers

### C-727-P — PVC-Coated Adjustable Swivel Ring

Designed for the support of non-insulated static pipe lines and to protect the pipe from coming into direct contact with the hanger by having the contact surface PVC coated. The swivel nut is knurled to provide a gripping surface when adjusting the pipe elevation.

#### Specifications

- Compliance: Federal Specification A-A-1192A Type 10, MSS SP-69 Type 10, UL Listed and FM Approved (¾" through 8")
  - Material: Carbon Steel
  - Finish: Standard Finish – GoldGalv®, Black (add suffix "-B"), Electro-Galvanized (add suffix "-EG")
  - Ordering: Specify pipe size and catalog number
- We also offer Swivel Ring hangers that are for Copper Tubing (C-727) and for NFPA requirements (C-727-NFPA) in this catalog. Operating temperature should not exceed 140° F/60° C

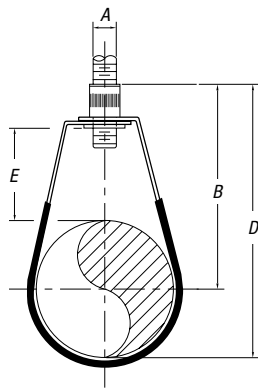

C-727-P

CAT. NO.	PIPE SIZE (IN.)	MAX. LOAD (LBS.)	DIMENSIONS (IN.)				WT. EACH (LBS.)
			A	B	D	E	
C727P-1/2	½	300	¾	2¾	3¼	1¼	.11
C-727-P-3/4	¾	300	¾	2½	3¼	1½	.13
C-727-P-1	1	300	¾	2½	3¼	1	.13
C-727-P-1-1/4	1¼	300	¾	2¾	3¼	1¼	.15
C-727-P-1-1/2	1½	300	¾	3	3½	1¼	.17
C-727-P-2	2	300	¾	3¾	4¾	1½	.18
C-727-P-2-1/2	2½	600	½	3¾	5½	1¼	.34
C-727-P-3	3	600	½	4	5½	1½	.39
C-727-P-3-1/2	3½	600	½	4¾	6½	1½	.42
C-727-P-4	4	1,000	¾	4¾	7	1¼	.48
C-727-P-5	5	1,000	¾	5¾	8½	1¾	.69
C-727-P-6	6	1,250	¾	6¾	10½	2	1.13
C-727-P-8	8	1,800	¾	8¾	12½	2½	1.29

Standard Finish – GoldGalv®, unless otherwise stated.

### C-727-NFPA — NFPA Swivel Ring

Designed for the support of non-insulated static pipe lines. The swivel nut is knurled to provide a gripping surface when adjusting the tubing elevation and is tapped to the reduced rod standards of NFPA.

#### Specifications

- Compliance: Federal Specification A-A-1192A Type 10, MSS SP-69 Type 10, UL Listed and FM Approved (¾" through 8") and NFPA standards
  - Material: Carbon Steel
  - Finish: Standard Finish – GoldGalv®, Black (add suffix "-B"), Electro-Galvanized (add suffix "-EG")
  - Ordering: Specify pipe size, catalog number and finish
- We also offer Swivel Ring hangers that are for standard commercial pipe (C-727), copper tubing (CT-727) and PVC coated (C-727-P) in this catalog

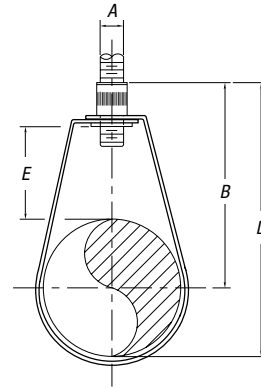

C-727-P

CAT. NO.	PIPE SIZE (IN.)	MAX. LOAD (LBS.)	DIMENSIONS (IN.)				WT. EACH (LBS.)
			A	B	D	E	
C-727-NFPA-1/2	½	300	¾	2¾	3¼	1¼	.09
C-727-NFPA-3/4	¾	300	¾	2½	3¼	1½	.10
C-727-NFPA-1	1	300	¾	2½	3¼	1	.10
C-727-NFPA-1-1/4	1¼	300	¾	2¾	3¼	1¼	.10
C-727-NFPA-1-1/2	1½	300	¾	3	3½	1¼	.11
C-727-NFPA-2	2	300	¾	3¾	4¾	1½	.12
C-727-NFPA-2-1/2	2½	525	¾	3¾	5	1¼	.25
C-727-NFPA-3	3	525	¾	3¾	5¾	1½	.30
C-727-NFPA-3-1/2	3½	525	¾	4¾	6½	1½	.33
C-727-NFPA-4	4	650	¾	4½	7	1¾	.41
C-727-NFPA-5	5	1,000	½	5¾	8¾	2¼	.58
C-727-NFPA-6	6	1,000	½	6¾	9¾	2¾	.92
C-727-NFPA-8	8	1,000	½	7¾	12¼	2¾	1.16

Standard Finish – GoldGalv®, unless otherwise stated.

## Pipe Straps, Conduit Clamps and Hangers

### CT-727 — Copper Tubing Swivel Ring

Designed for the support of non-insulated static copper tubing lines. The swivel nut is knurled to provide a gripping surface when adjusting the tubing elevation.

#### Specifications

- Compliance: Federal Specification A-A-1192A Type 10, MSS SP-69 Type 10. We also offer Swivel Ring hangers that are for carbon steel pipe (C-727), PVC coated (C-727-P) and for NFPA requirements (C-727-NFPA) in this catalog
- Material: Carbon Steel
- Finish: Copper
- Ordering: Specify copper tubing size

CAT. NO.	PIPE SIZE (IN.)	MAX. LOAD (LBS.)	DIMENSIONS (IN.)				WT. EACH (LBS.)
			A	B	D	E	
CT727 1/2	1/2	300	3/8	2 3/8	3/4	1 1/16	.11
CT-727-3/4	3/4	300	3/8	2 3/8	3/8	1 3/8	.11
CT-727-1	1	300	3/8	2 1/2	3/8	1	.11
CT-727-1-1/4	1 1/4	300	3/8	2 3/4	3/4	1 1/16	.13
CT-727-1-1/2	1 1/2	300	3/8	2 5/16	3/8	1 1/8	.13
CT-727-2	2	300	3/8	3 5/16	4/8	1 1/16	.15
CT-727-2-1/2	2 1/2	525	3/8	4	4 3/8	1 1/8	.16
CT-727-3	3	525	1/2	4 9/16	5 9/16	1 1/16	.32
CT-727-3-1/2	3 1/2	525	1/2	4 9/16	5 7/8	1 1/8	.35
CT-727-4	4	650	1/2	5 5/16	6 1/2	1 1/16	.38
CT-727-5	5	1,000	1/2	6 1/4	8 3/8	1 3/8	.58
CT-727-6	6	1,000	1/2	7 3/16	9 3/16	2 1/4	.92

Standard Finish – GoldGalv® unless otherwise stated.

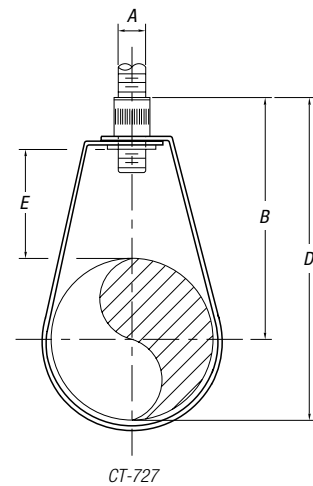

### ET-727 Copper Sized Adjustable Ring

Standard Finish – GoldGalv® barrier for separation of dissimilar metals. Available in sizes 1/2" through 2". Sized for Copper Tubing.

CAT. NO.	TUBING SIZE (IN.)	ROD SIZE (IN.)	DIMENSIONS (IN.)			STOCK SIZE	MAX REC. LOAD (LBS.)	STD. CTN.
			A	B	C			
ET727 1/2	1/2	3/8	3 3/8	2 3/4	1 1/2	16 ga x 3/8	400	100
ET-727-3/4	3/4	3/8	3 3/8	2 5/8	1 1/4	16 ga x 3/8	400	100
ET-727-1	1	3/8	3 3/8	2 1/2	1	16 ga x 3/8	400	100
ET-727-1-1/4	1 1/4	3/8	3 3/4	2 1/2	1	16 ga x 3/8	400	100
ET-727-1-1/2	1 1/2	3/8	3 3/8	3	1 1/4	16 ga x 3/8	400	100
ET-727-2	2	3/8	4 1/2	3 3/8	1 1/2	16 ga x 3/8	400	100
ET-727-2-1/2	2 1/2	3/8*	5 1/2	4 3/8	2	14 ga x 1 3/16	600	100
ET-727-3	3	1/2	6 3/8	4 3/4	2	14 ga x 1 3/16	600	100
ET-727-3-1/2	3 1/2	1/2	6 3/8	4 1/2	1 1/2	14 ga x 1 3/16	600	50
ET-727-4	4	1/2*	7 3/8	5 1/4	2	14 ga x 1 1/4	1,250	100
ET-727-5	5	5/8	8 3/8	5 3/4	2	12 ga x 1 1/4	1,250	25
ET-727-6	6	5/8	9 1/2	6 3/8	1 1/2	12 ga x 1 1/4	1,250	25

2 1/2" CT filled with water weighs less than 2" IP filled with water, 4" CT less than 3 1/2" IP with water.

2 1/2" CT available with 1/2" thread and 4" CT available with 3/8" thread for Government Specs.

Standard Finish – GoldGalv®, unless otherwise stated.

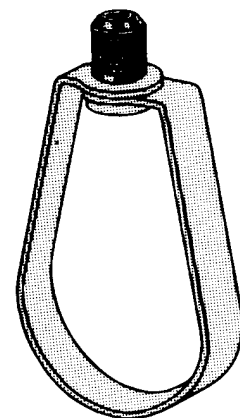

## Pipe Straps, Conduit Clamps and Hangers

### M-718, M-718-B — Extension Ring Hanger

M-718 — (Rod Tapped – Electro-Galvanized)  
 M-718-B — (Rod Tapped – Plain Finish)

This split ring hanger is designed for the support of non-insulated stationary pipe lines. Also available in a two-screw design. The MT-742-R Ceiling Plate is normally used with this product.

#### Specifications

- Material: Malleable Iron.
- Finish: Standard Finish – EG (silver), Black (add suffix “-B”), Electro-Galvanized (add suffix “-EG”)
- Compliance: Federal Specification A-A-1192A Type 12, MSS-SP-69 Type 12
- Ordering: Specify pipe size and catalog number.

CAT. NO.	PIPE SIZE (IN.)	MAX LOAD (LBS.)	PIPE SIZE A (IN.)	ROD SIZE A (IN.)	B (IN.)	WT. EACH (LBS.)
M-718-3/8	3/8	180	1/4	3/8	1 1/16	.16
M-718-1/2	1/2	180	1/4	3/8	7/8	.17
M-718-3/4	3/4	180	1/4	3/8	1	.20
M-718-1	1	180	1/4	3/8	1 1/8	.21
M-718-1-1/4	1 1/4	180	1/4	3/8	1 1/16	.29
M-718-1-1/2	1 1/2	180	1/4	3/8	1 1/16	.31
M-718-2	2	180	1/4	3/8	1 1/16	.35
M-718-2-1/2	2 1/2	480	1/2	1/2	2 1/8	.57
M-718-3	3	480	1/2	1/2	2 1/16	.72
M-718-4	4	480	1/2	1/2	3 1/8	1.16

Standard Finish – EG (silver).

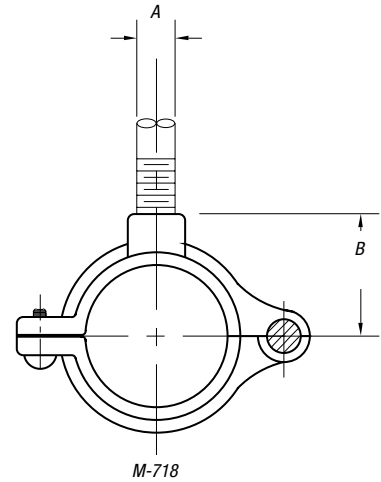

### MT-718 — Copper Extension Ring Hanger

This split ring hanger is designed for the support of non-insulated copper tubing lines. The MT-718 is furnished tapped for bolt thread and is used with the MT-742-R Ceiling Plate. Also available in a two-bolt design.

#### Specifications

- Material: Malleable Iron
- Finish: Copper
- For Electro-Galvanizing please see M-718.
- Compliance: Federal Specification A-A-1192A Type 12, MSS-SP-69 Type 12
- Ordering: Specify tube size and catalog number.

CAT. NO.	TUBE SIZE (IN.)	MAX LOAD (LBS.)	ROD SIZE A (IN.)	B (IN.)	WT. EACH (LBS.)
MT718-1/4	1/4	180	3/8	1/2	.10
MT-718-3/8	3/8	180	3/8	1/2	.12
MT-718-1/2	1/2	180	3/8	3/4	.13
MT-718-5/8	5/8	180	3/8	3/4	.14
MT-718-3/4	3/4	180	3/8	7/8	.15
MT-718-1	1	180	3/8	1	.16
MT-718-1-1/4	1 1/4	180	3/8	1 1/4	.19
MT-718-1-1/2	1 1/2	180	3/8	1 1/4	.22
MT-718-2	2	180	3/8	1 1/2	.27
MT-718-2-1/2	2 1/2	480	1/2	2	.72
MT-718-3	3	480	1/2	2 1/4	1.07

Standard Finish – GoldGalv®, unless otherwise stated.

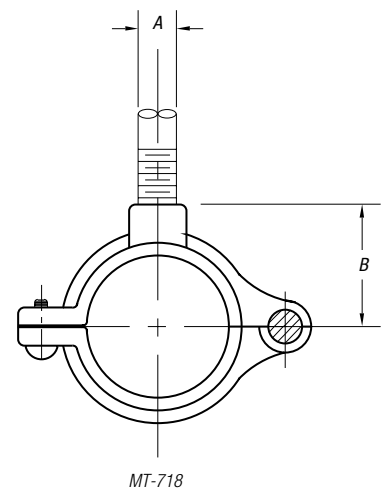

## Pipe Straps, Conduit Clamps and Hangers

### Seismic Bracing

(Consult Superstrut® Seismic Hanger bulletin for additional information.)

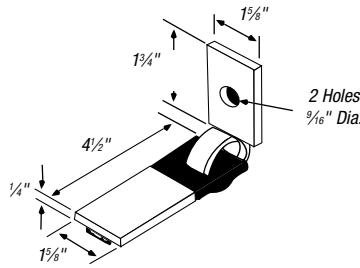

**CAT. NO. C749N**  
Seismic Brace  
1,500 lb. load safety factor of 3

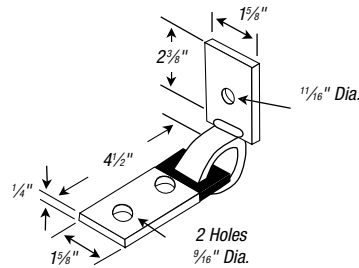

**CAT. NO. C749N 5/8**  
Seismic Brace  
1,650 lb. load safety factor of 3

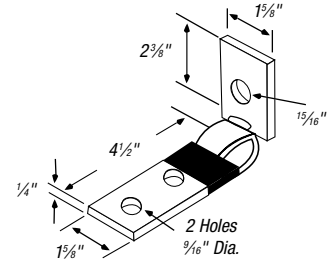

**CAT. NO. C749N 7/8**  
Seismic Brace  
1,650 lb. load safety factor of 3

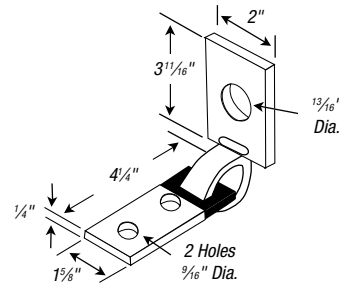

**CAT. NO. C-749-N-1-1/8**  
Seismic Brace  
1,650 lb. load safety factor of 3

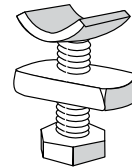

**CAT. NO. ES-142**  
Size: 1/2" x 1 1/4" Bolt Size: 1/2"  
Seismic bracing rod stiffener connector

All braces have plastisol coating on the flat member. Plastisol insulates against vibration noise transmission and eliminates rattle at the connection points.  
Standard Finish – GoldGalv® brand. Approved for seismic applications.

## S-720 — Adjustable Pipe Hanger

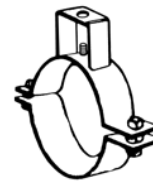

CAT. NO.	PIPE SIZE (IN.)	ROD SIZE (IN.)	ADJUSTMENT (IN.)	BOLT CENTERS (IN.)	STOCK SIZE (IN.)	BOLT SIZE (IN.)	DESIGN LOAD (LBS.)	STD. CTN.
S720 3/4	3/4	3/8	1 5/8	4 1/2	3/16 x 1 1/4	1/2-1 1/4	550	10
S-720-1	1	3/8	1 1/2	4 1/2	3/16 x 1 1/4	1/2-1 1/4	550	10
S-720-1-1/4	1 1/4	3/8	1 3/8	5	3/16 x 1 1/4	1/2-1 1/4	550	10
S-720-1-1/2	1 1/2	3/8	1 1/2	4 1/2	3/16 x 1 1/4	1/2-1 1/4	550	10
S-720-2	2	3/8	1 1/2	5	1/4 x 1 1/4	1/2-1 1/4	700	10
S-720-2-1/2	2 1/2	1/2	2 1/8	5 3/8	1/4 x 1 1/4	1/2-1 1/4	700	10
S-720-3	3	1/2	2 1/4	6 1/4	1/4 x 1 1/4	1/2-1 1/4	1,100	10
S-720-3-1/2	3 1/2	1/2	2 1/4	6 3/4	1/4 x 1 1/4	1/2-1 1/4	1,100	10
S-720-4	4	1/2	2 1/4	7 1/4	1/4 x 1 1/4	1/2-1 1/4	1,300	10
S-720-5	5	5/8	2 1/4	8 1/2	1/4 x 1 1/2	5/8-1 1/2	1,600	10
S-720-6	6	5/8	2 1/4	9 1/2	1/4 x 1 1/2	5/8-1 1/2	1,600	5
S-720-8	8	3/4	2 1/8	11 1/2	1/4 x 2	3/4-2	2,000	5

Standard Finish – GoldGalv®, unless otherwise stated.

## Pipe Straps, Conduit Clamps and Hangers

### PG-794 — Pipe Alignment Guide

Designed to maintain the axial alignment of piping as it expands and contracts during operation. It is most typically installed adjacent to expansion joints and at reasonable distances between the expansion joint and the anchor point. Our Figures 1007 and 1010 also offer alternative means for your piping alignment needs.

**Note:** Guides are not designed to carry dead weight loads. Maximum temperature is 750° F.

#### Specifications

- Material: Carbon Steel
  - Finish: EG (Silver), Black (add suffix "-B"), Electro-Galvanized (add suffix "-EG")
  - Ordering: Specify pipe size, insulation thickness, catalog number and finish.
- Example Catalog Number:** PG794 T3-2-1/2 would be 2½" pipe with 2" thick insulation.

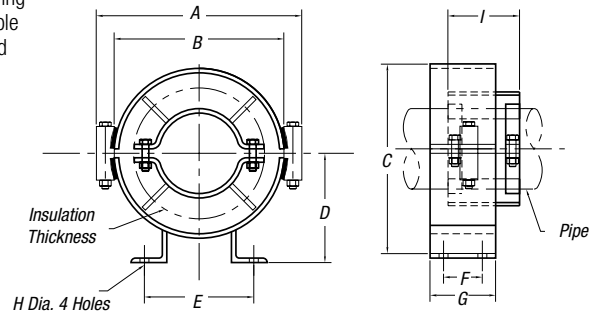

M-718

SIZE	DIMENSIONS (IN.)								WT. EACH (LBS.)
	A	B	C	D	E	F	G	H	
1	6¾	4½	5½	3½	5	1½	3	¾	5.8
2	7¼	5½	6¾	3½	6¾	1½	3	¾	7.2
3	8¾	6¾	7¾	4	6¾	1½	3	¾	8.2
4	10¾	8¾	9¾	5	7¾	1½	3	¾	10.6
5	12½	10¾	11¾	6¼	7¾	2	4	¾	15.6
6	14¾	12¾	13¾	7¼	8	2	4	¾	19.5
7	16¾	14¾	15¾	8½	9¾	2	4	¾	26.8
8	18¾	16¾	17¾	9½	10¾	4	6	¾	35.6
9	22¾	19	20	10½	11¾	4	6	¾	44.2
10	23¾	21	22	11½	14¾	4	6	¾	52.6
11	25¾	23	24	12½	14¾	4	6	¾	66.3
12	28¾	25¾	26¾	13¾	15¾	4	6	1	79.7
13	32¾	29½	30½	15¾	16¾	5½	8	1	106.3
14	36¾	33½	34½	17¾	17¾	5½	8	1	116.8

SIZE NUMBER	THICKNESS OF INSULATION (IN.)					
	1	1½	2	2½	3	4
1	1					
2	1¼-2	1				
3	2½	1¼-2	1			
4	3-4	2½-3½	1¼-2½	1-2	1	
5	5-6	4-5	3-4	2½-3½	1¼-2½	1
6		6	5-6	4-5	3-4	1¼-2½
7		8	8	6	5-6	3-4
8		10	10	8	8	5-6
9		12	12	10	10	8
10			14	12-14	12	10
11			16	16	14	12
12					16-18	14-16
13					20	18-20
14					24	24

Standard Finish — EG (silver).

PIPE SIZE (IN.)	DIM. I	MAX. MVT
1-6	4	4
8-16	6	6
18-24	8	8

#### Insulation Thickness Table

PRODUCT DESIGNATION	INSULATION THICKNESS (IN.)	FOR PIPE SIZES
T1	1	½-24
T2	1½	½-24
T3	2	½-24
T4	2½	½-24
T5	3	½-24
T6	3½	½-24
T7	4	½-24

Standard Finish — GoldGalv®, unless otherwise stated.



## Pipe Straps, Conduit Clamps and Hangers

### Structure Attachments

#### M-742-R Ceiling Flange

M-742-R, M-742-RB, MT-742-R – Single Plate

M-742-R — (Rod Tapped – Electro-Galvanized)

M-742-RB — (Rod Tapped – Plain Finish)

MT-742-R — (Rod Tapped – Copper Finish)

Designed for attaching a rod to a wooden member.

This part is normally used in conjunction with our M-718 Split Ring.

#### Specifications

- Material: Malleable Iron. M-742-R is Carbon Steel.
- Ordering: Specify rod size and catalog number.

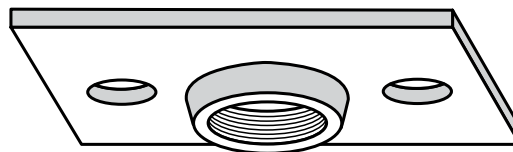
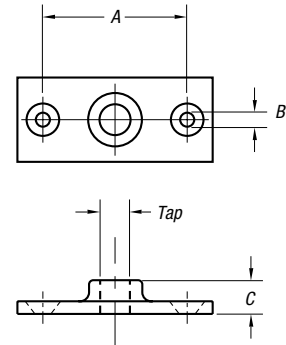

M-742-R  
Rod Sizes: 3/8" & 1/2"

CAT. NO.	ROD TAP (IN.)	MAX. LOAD (LBS.)	DIMENSIONS (IN.)			WT. EACH (LBS.)
			A	B	C	
M-742-R-3/8	3/8	180	2	1/4	1/2	.19
M-742-R-1/2	1/2	180	2	1/4	1/2	.18

Standard Finish – Black (B), EG (Silver) or Copper-Colored Epoxy Paint.

#### C-736-Side Clip — Steel Bracket Clip

Clip can be used to support piping 3/2" or smaller from the horizontal member of a C-736 Steel Bracket. The clip is composed of two steel plates and one bolt and nut.

#### Specifications

- Material: Carbon Steel
- Finish: Standard Finish – GoldGalv®, Black (add suffix "-B"), Electro-Galvanized (add suffix "-EG")
- Ordering: Specify size number, catalog number and finish.

CAT. NO.	ROD SIZE (IN.)	SIZE (IN.)	MAX. LOAD (LBS.)	WT. EACH (LBS.)
C-736-SIDE CLIP-1	1	3/4	750	6.99
C-736-SIDE CLIP-2	2	1/2	750	10.10

Standard Finish – GoldGalv®, unless otherwise stated.

## Pipe Straps, Conduit Clamps and Hangers

### C-736 — Light Welded Steel Bracket

Designed to support up to 6" pipe. This bracket is for installation to walls as shown or inverted, and may require a backing plate. Holes for up to 3/4" rods are located at each end of the bracket to allow for use in either orientation. The C-736 Side Clip Steel Bracket Clip can be attached to the C-736 to support piping 3 1/2" or smaller. Please see Figure 79 for more information.

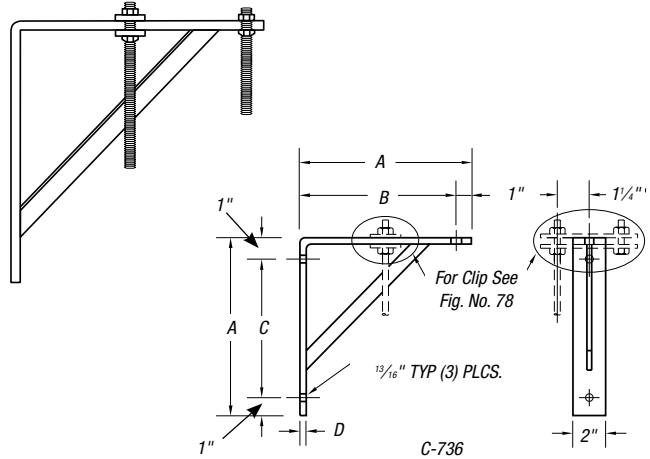

#### Specifications

- Compliance: A-A-1192A Type 31, MSS-SP 69 Type 31
- Ordering: Specify size number, catalog number and finish.
- Finish: Standard Finish – GoldGalv®, Black (add suffix “-B”), Electro-Galvanized (add suffix “-EG”)

CAT. NO.	ROD TAP	MAX. LOAD (LBS.)	DIMENSIONS (IN.)			WT. EACH (LBS.)
			A	B	C	
C-736-1	1	750	9	8	6 1/2	6.99
C-736-2	2	750	13	12	10 1/2	10.10
C-736-3	3	750	19	18	16 1/2	10.50

Standard Finish – GoldGalv®, unless otherwise stated.

### C-739-H — Heavy Welded Steel Bracket

Designed to support pipe from either above or below. Slotted construction allows for drop rod use along the length of the bracket. This bracket is for bolted installation to walls and may require a backing plate. Special steel brackets can be fabricated to customers loads and/or dimensions.

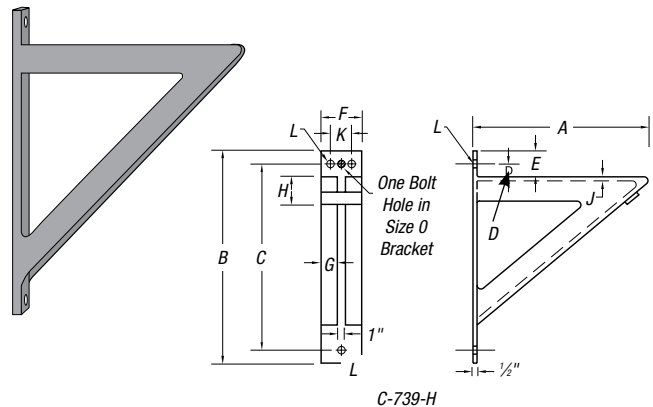

#### Specifications

- Compliance: A-A-1192A Type 33, MSS-SP 69 Type 33
- Ordering: Specify size number, catalog number and finish.
- Finish: Standard Finish – GoldGalv®, Black (add suffix “-B”), Electro-Galvanized (add suffix “-EG”)

CAT. NO.	SIZE	MAX. LOAD (LBS.)	DIMENSIONS (IN.)											WT. EACH (LBS.)
			A	B	C	D	E	F	G	H	J	K	L	
C-739-H-0	0	3,000	12	18	15 1/4	1 1/2	2 3/4	4 1/2	1 1/2	2	1/4	NA	1 3/16	25.1
C-739-H-1	1	3,000	18	24	21 1/4	1 1/2	2 3/4	5	1 1/2	2	3/8	2 3/4	1 3/16	44.8
C-739-H-2	2	3,000	24	30	27 1/2	1 1/2	2 3/4	5	1 1/2	2 1/2	3/8	2 1/2	1 1/16	60.7
C-739-H-3	3	3,000	30	36	33 1/4	1 1/2	3	6	2	2 1/2	3/8	2 1/2	1 1/16	98.1
C-739-H-4	4	3,000	36	42	39	1 1/2	3	6	2	3 1/2	3/8	3 1/2	1 1/16	129.4
C-739-H-5	5	3,000	42	50	46	1 1/2	3 1/2	7	2 1/2	3 1/2	3/8	3 1/2	1 1/16	177.2

## Pipe Straps, Conduit Clamps and Hangers

### PG-795 — Pipe Block

Standard Finish — Black (B).

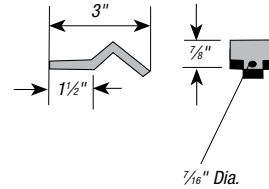
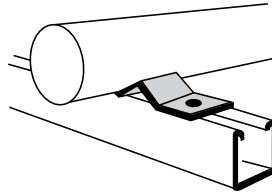

## Pipe Attachments

### H-115, H-115SS — Standard U-Bolt

Our standard U-Bolts are recommended for use as supports or guides for piping. They are supplied with four hex nuts. The H-115SS is recommended for support of stainless steel piping. Please specify the grade of stainless steel you require when ordering. Load Ratings shown are for Carbon Steel. PVC coating should not exceed 140° F/60° C.



H-115-1/2

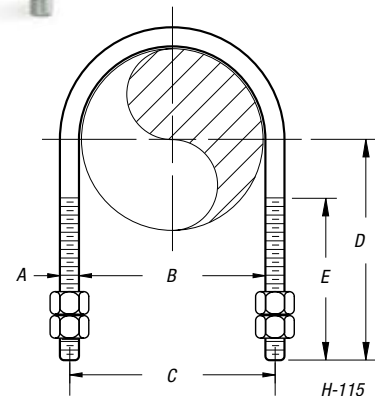

#### Specifications

- Materials: Carbon Steel, Stainless Steel
  - Compliance: Federal Specification A-A-1192A Type 24, MSS-SP 69 Type 24, and BSPSS-BS3974
  - Finish: Standard Finish — GoldGalv®, Black (add suffix "-B"), Electro-Galvanized (add suffix "-EG"), SS (add suffix SS), SS6 = 316
- Side loads are given for the H-115 for a maximum temperature of 650° F/343° C.

When the loading condition requires the simultaneous application of a normal load and side load, the following interaction equation must be used to determine if the H-115 can be used.

(Actual Load / Maximum Design Load) + (Actual Side Load/Maximum Side Load). The result of this equation cannot exceed the value of 1.0 if the H-115 is to be used.

- Ordering: Specify pipe size, catalog number and finish.

CAT. NO.	PIPE SIZE (IN.)	MAX. LOAD (LBS.)		MAX. SIDE LOAD (LBS.) 650° F/343° C	DIMENSIONS (IN.)					WT. EACH (LBS.)
		650° F/ 343° C	750° F/ 399° C		A	B	C	D	E	
H-115-1/2	1/2	485	435	63	1/4	1 1/8	1 1/8	2 3/4	2 1/8	.11
H-115-3/4	3/4	485	435	63	1/4	1 1/8	1 1/8	2 3/4	2 1/8	.12
H-115-1	1	485	435	63	1/4	1 1/8	1 1/8	2 3/4	2 1/8	.12
H-115-1/2	1/2	1,200	1,070	316	3/8	1 1/8	1 1/4	2 3/4	2 1/8	.16
H-115-3/4	3/4	1,200	1,070	240	3/8	1 1/8	1 1/2	2 3/4	2 1/8	.16
H-115-1	1	1,200	1,070	186	3/8	1 1/8	1 3/4	2 3/4	2 1/8	.19
H-115-1-1/4	1 1/4	1,220	1,090	194	3/8	1 3/4	2 1/8	2 7/8	2 1/8	.28
H-115-1-1/2	1 1/2	1,220	1,090	194	3/8	2	2 3/8	3	2 1/2	.30
H-115-2	2	1,220	1,090	194	3/8	2 1/2	2 1/8	3 1/4	2 1/2	.33
H-115-2-1/2	2 1/2	2,260	2,020	184	1/2	3	3 1/2	3 3/4	3	.70
H-115-3	3	2,260	2,020	184	1/2	3 3/8	4 1/8	4	3	.78
H-115-3-1/2	3 1/2	2,260	2,020	184	1/2	4 1/8	4 3/8	4 1/2	3	.84
H-115-4	4	2,260	2,020	184	1/2	4 3/8	5 1/8	4 1/2	3	.90

## Pipe Straps, Conduit Clamps and Hangers

### Beam Attachments

#### M-750 — Side Beam Bracket

Designed for bolt connections.

##### Specifications.....

- Compliance: A-A-1192A Type 34 and MSS-SP 69 Type 34
- Material: Malleable Iron (Maximum Temperature 450° F/232° C)
- Standard Finish — GoldGalv®, Black (add suffix “-B”), Electro-Galvanized (add suffix “-EG”)
- Ordering: Specify rod size and catalog number.

CAT. NO.	MAX LOAD (LBS.)		WITH BOLT TO STEEL	DIMENSIONS (IN.)				WT. EACH (LBS.)
	ROD SIZE (IN.)	WITH LAG SCREW		C	D	F	G	
M-750-3/8	3/8	390	610	5/8	1 1/16	7/16	7/8	.26
M-750-1/2	1/2	640	1,130	3/4	1 7/8	9/16	1 3/16	.54
M-750-5/8	5/8	760	1,810	7/8	2 1/8	3/4	1 1/16	.94

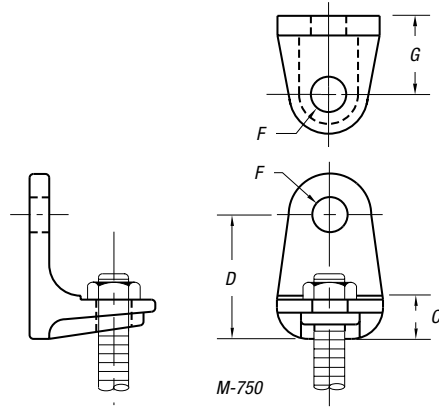

#### M-762 — Side Beam Connector

Designed for use on buildings of wood construction. They can be secured to the side of beams or joists by means of our Figure 166 Drive Screws (ordered separately).

##### Specifications.....

- Material: Malleable Iron
- Standard Finish — GoldGalv®, Black (add suffix “-B”), Electro-Galvanized (add suffix “-EG”)
- Ordering: Specify size, catalog number and finish.

CAT. NO.	SIZE (IN.)	MAX LOAD (LBS.)	DIMENSIONS (IN.)			WT. EACH (LBS.)
			A	B	C	
M-762-3/8	3/8 rod	250	2 3/4	3/4	3/4	.13
M-762-1/2	1/2 rod	480	2 3/4	3/4	3/4	.25
M-762-1/4	1/4 pipe	250	2 3/4	3/4	3/4	.25

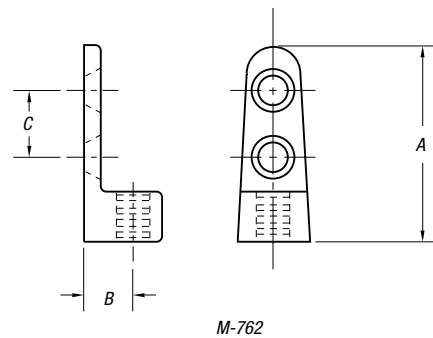

#### C-747 — Adjustable Beam Attachment

For attachment to timber with coach screws or to the bottom of beams with bolts.

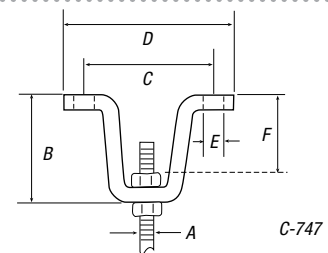

CAT. NO.	ROD SIZE A (IN.)	HOLE SIZE (IN.)	DIMENSIONS (IN.)					STOCK SIZE (IN.)	DESIGN LOAD (LBS.)	STD. CTN.
			B	C	D	E	F			
C-747-3/8B	3/8B	7/16	2 3/4	3 3/8	4 7/8	7/16	2 1/8	1/4 x 1 1/4	610	50
C-747-1/2B	1/2B	9/16	3 3/8	4 3/4	6	9/16	2 5/16	3/8 x 1 1/2	1,130	50
C-747-5/8B	5/8B	1 1/16	3 3/8	4 3/4	6	9/16	2 3/16	3/8 x 1 1/2	1,810	50
C-747-3/4B	3/4B	1 3/16	3 11/16	6 1/4	7 3/4	1 1/16	2 9/16	1/2 x 2	2,710	50
C-747-7/8B	7/8B	1 5/16	3 3/4	6 3/8	8 1/4	1 3/16	2 1/2	1/2 x 2	3,770	50

Standard Finish — Black (B).

Order by Cat. No., rod size.

## Pipe Straps, Conduit Clamps and Hangers

### Rods and Rod Attachments

#### F-112 — Turnbuckle

Used to connect right- and left-hand threaded rods together and provide for adjustment.

##### Specifications

- Material: Forged Steel
- Finish: Standard Finish – GoldGalv®, Black (add suffix “-B”), Electro-Galvanized (add suffix “-EG”)
- Specify catalog number, finish and rod size.
- Compliance: Federal Specification A-A-1192A Type 13, MSS-SP 69 Type 13 and BSPSS-BS3974

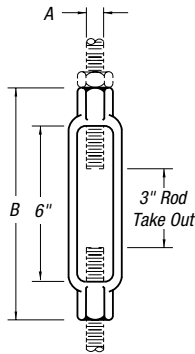

F-112

CAT. NO.	ROD SIZE (IN.)	MAX LOAD (LBS.)	B (IN.)	WT. EACH (LBS.)
		650° F/343° C		
F-112-3/8	3/8	610	7 1/8	.30
F-112-1/2	1/2	1,130	7 1/2	.60
F-112-5/8	5/8	1,810	7 7/8	1.00
F-112-3/4	3/4	2,710	8 1/4	1.20
F-112-7/8	7/8	3,370	8 5/8	1.90
F-112-1	1	4,960	9	2.50
F-112-1-1/4	1 1/4	8,000	9 1/2	3.80
F-112-1-1/2	1 1/2	11,630	9 3/4	5.70
F-112-1-3/4	1 3/4	15,700	10 5/8	8.20
F-112-2	2	20,700	11	14.20
F-112-2-1/4	2 1/4	27,200	12 7/8	27.00
F-112-2-1/2	2 1/2	33,500	13 1/2	33.00

Standard Finish – GoldGalv®, unless otherwise stated.

#### M-129 — Extension Piece

Designed for attaching rods to the M-732-EXT Clamp and similar types of attachments.

##### Specifications

- Material: Malleable Iron
- Finish: Standard Finish – GoldGalv®, Black (add suffix “-B”), Electro-Galvanized (add suffix “-EG”)
- Specify rod size, catalog number and finish
- Compliance: Federal Specification A-A-1192A Type 30, MSS-SP-69 Type 30 when used with a Figure 82

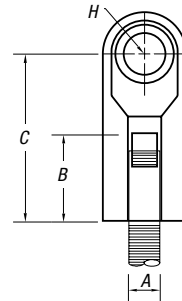

M-129

CAT. NO.	ROD SIZE (IN.)	MAX LOAD (LBS.)	DIMENSIONS (IN.)				WT. EACH (LBS.)
			B	C	G	H	
M-129-3/8	3/8	610	1 1/4	2 1/8	1/2	1/2	.20
M-129-1/2	1/2	1,130	1 3/8	2 3/8	5/8	1/2	.40
M-129-5/8	5/8	1,810	1 1/2	2 1/2	5/8	1/2	.44
M-129-3/4	3/4	2,710	1 3/4	2 7/8	5/8	1/2	.65
M-129-7/8	7/8	2,950	1 7/8	3	3/4	9/16	.78

Standard Finish – GoldGalv®, unless otherwise stated.

## Pipe Straps, Conduit Clamps and Hangers

### Structure Attachments

## C-780 W/OB, C-780 W/HWB — Welded Beam Attachment

Recommended for attachment to the bottom of beams when little or no pipe movement is expected. C-780 W/HWB is recommended for attachment to the bottom of beams, when pipe movement is expected. A bolt and nut or pin is supplied. A pin with cotters is normally supplied for rod sizes over 1".

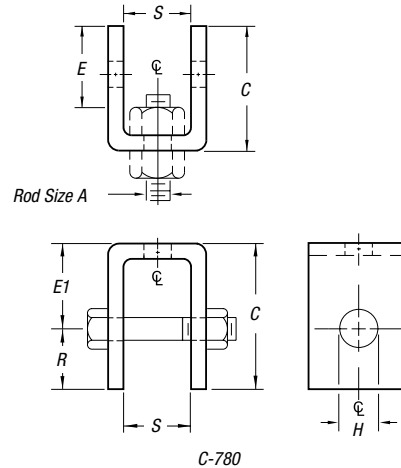

- Specifications**
- Compliance: Federal Specification A-A-1192A Type 22, MSS SP-69 Type 22 and BSPSS-BS3974
  - Material: Carbon Steel
  - Finish: Standard Finish – GoldGalv®, Black (add suffix "-B"), Electro-Galvanized (add suffix "-EG")
  - Ordering: Specify catalog number, rod size and finish.

CAT. NO.	ROD SIZE (IN.)	MAX. LOAD (LBS.) 650° F/ 343° C	BOLT OR PIN SIZE (IN.)	C (IN.)	ROD TAKEOUT C-780 W/OB E (IN.)	ROD TAKEOUT C-780 W/HWB E1 (IN.)	H (IN.)	R (IN.)	S (IN.)	WT. EACH (LBS.)	
										C-780 W/OB W/O B&N	C-780 W/HWB W B&N
C-780-3/8	3/8	610	1/2	2 7/8	1 1/2	2	3/16	7/8	1 1/4	.96	1.20
C-780-1/2	1/2	1,130	5/8	2 7/8	1 3/4	2	1 1/16	7/8	1 1/4	.96	1.20
C-780-5/8	5/8	1,810	3/4	2 7/8	1 3/4	2	1 3/16	7/8	1 1/4	.96	1.60
C-780-3/4	3/4	2,710	7/8	3 3/8	1 1/2	2	1 15/16	1 1/8	2 1/2	1.90	2.80
C-780-7/8	7/8	3,770	1	4 1/4	2 3/8	3	1 1/2	1 1/4	2 1/2	2.50	3.90
C-780-1	1	4,960	1 1/8	4 1/2	3	3 1/2	1 1/4	1 1/2	2 3/8	4.30	6.30
C-780-1-1/4	1 1/4	8,000	1 3/8	5	2	3	1 1/2	2	3	8.10	10.20
C-780-1-1/2	1 1/2	11,600	1 5/8	5 1/2	2 1/2	4	1 3/4	2 1/2	3	15.60	19.00
C-780-1-3/4	1 3/4	15,700	1 7/8	7 3/4	2 3/4	5	2	2 3/4	3 3/4	18.70	24.20
C-780-2	2	20,700	2 1/4	8 3/4	N/A	5	2 3/8	3 1/4	3 3/4	—	30.60
C-780-2-1/4	2 1/4	27,200	2 1/2	9 3/4	N/A	6 1/4	2 3/8	3 1/2	3 3/4	—	36.80
C-780-2-1/2	2 1/2	33,500	2 1/2	9 3/4	N/A	6 1/4	2 7/8	3 3/4	3 3/4	—	39.70
C-780-2-3/4	2 3/4	41,580	3	9 3/4	N/A	5 3/4	3 3/8	4	3 3/4	—	39.70
C-780-3	3	50,580	3 3/4	10 1/4	N/A	6 1/4	3 3/8	4	3 3/4	—	49.00
C-780-3-1/4	3 1/4	71,280	3 1/2	11 1/2	N/A	7	3 3/8	4 1/2	4 1/4	—	67.60
C-780-3-1/2	3 1/2	71,280	3 3/4	12	N/A	7 1/2	3 3/8	4 1/2	4 1/4	—	79.30

## Pipe Straps, Conduit Clamps and Hangers

### C-755 — Beam Clamp

Designed to attach to the bottom of flanged beams. Normally used with the E-157 Eye Rod or E-120-A Eye Nut.

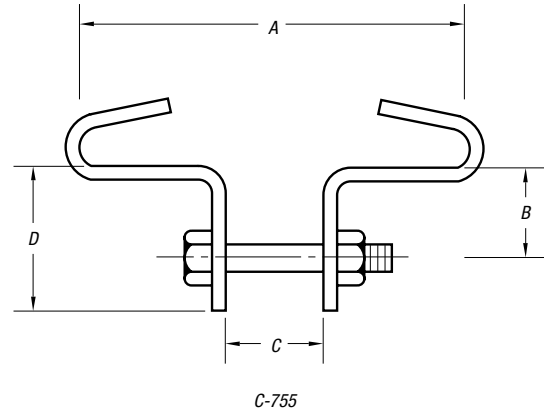

#### Specifications

- Material: Carbon Steel
- Compliance: Federal Specification A-A-1192A Type 21, MSS-SP-69 Type 21
- Finish: Standard Finish – GoldGalv®, Black (add suffix “-B”), Electro-Galvanized (add suffix “-EG”), Thermoplastic (add suffix “-TP”)
- Ordering: Specify clamp size, flange width, flange thickness, catalog number and finish.

CAT. NO.	CLAMP SIZE	MAX. LOAD (LBS.)	DIMENSIONS (IN.)			BOLT SIZE (IN.)
			B	C	D	
C-755-1	1	500	7/8	1/2	1 1/2	3/8
C-755-2	2	700	1 1/8	5/8	1 3/4	1/2
C-755-3	3	800	1 1/4	5/8	2	1/2
C-755-4	4	1,000	1 5/8	3/4	2 1/8	5/8
C-755-5	5	3,000	1 7/8	7/8	2 3/8	3/4
C-755-6	6	3,000	2	1	3	7/8
C-755-7	7	5,000	2 1/8	1 1/8	4 1/8	1

CAT. NO.	CLAMP SIZE	WEIGHT EACH (LBS.) BEAM WIDTH — DIMENSION “A”							
		2	3	4	5	6	7	8	10
C-755-1	1	.52	.62	.78	.88	.95	—	—	—
C-755-2	2	.74	.82	1.09	1.21	1.31	1.39	—	—
C-755-3	3	1.26	1.49	1.89	2.12	2.29	2.45	2.69	—
C-755-4	4	—	2.32	2.85	3.18	3.39	3.60	3.92	—
C-755-5	5	—	3.40	4.08	4.52	4.80	5.10	5.51	6.23
C-755-6	6	—	—	6.00	6.45	7.00	7.40	7.90	8.80
C-755-7	7	—	—	—	11.95	12.75	13.55	14.35	15.95

## Pipe Straps, Conduit Clamps and Hangers

### M-732-H — Steel Beam Clamp with Weldless Eyunut

The M-732-H beam clamp with eyenut is used for support where some movement is expected and welding to the structure is prohibited. The clamping effect is produced by the "ice-tong" action of the arms and is locked in place by the through bolt located just under the beam flange.

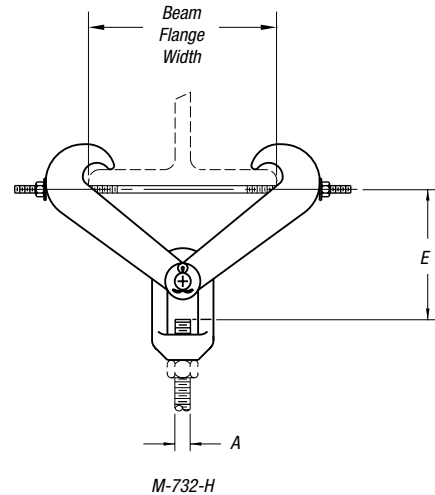

#### Specifications

- Material: Carbon Steel with Forged Steel Eyunut
- Compliance: Federal Specification A-A-1192A Type 28, MSS-SP-69 Type 28 and BSPSS-BS3974
- Finish: Standard Finish – GoldGalv®, Black (add suffix “-B”), Electro-Galvanized (add suffix “-EG”)
- Ordering: Specify catalog number, rod size, clamp number and finish.

CAT. NO.	CLAMP SIZE	MAX. LOAD (LBS.)	MAX. ROD SIZE A (IN.)	BEAM WIDTH	BODY SIZE (IN.)	MAX. FLANGE THICKNESS (IN.)	WT. EACH (LBS.)
M-732-H-1	1	2,710	3/4	3-8	25/32	.6	5.5
M-732-H-2	2	4,960	1	3-8	25/32	.6	5.5
M-732-H-3	3	4,960	1	4-11	27/32	.6	9.0
M-732-H-4	4	4,960	1	4-12	29/32	1.03	29.0
M-732-H-5	5	4,960	1	11-15	1/64	1.03	33.3
M-732-H-6	6	11,500	1 1/2	4-12	29/32	1.03	29.0
M-732-H-7	7	11,500	1 1/2	11-15	1/64	1.03	33.3
M-732-H-8	8	11,500	2	4-12	29/32	1.03	29.0

CAT. NO.	CLAMP SIZE	BODY SIZE (IN.)	DIMENSIONS (IN.)												
			3	4	5	6	7	8	9	10	11	12	13	14	15
M-732-H-1	1	25/32	5 3/16	5 1/8	5	4 13/16	4 3/8	3 15/16	—	—	—	—	—	—	—
M-732-H-2	2	25/32	5 3/16	5 1/8	5	4 13/16	4 3/8	3 15/16	—	—	—	—	—	—	—
M-732-H-3	3	27/32	—	8 1/4	8 1/8	8 1/8	7 7/8	7 7/8	7 3/8	7	6 1/2	—	—	—	—
M-732-H-4	4	27/32	—	8 5/8	8 5/8	8 1/2	8 3/8	8 3/8	7 7/8	7 7/8	7	6 3/8	—	—	—
M-732-H-5	5	1/64	—	—	—	—	—	—	—	—	9 1/2	9 1/4	8 7/8	8 3/8	7 7/8
M-732-H-6	6	3/8	—	8 5/8	8 5/8	8 1/2	8 3/8	8 3/8	7 7/8	7 7/8	7	6 3/8	—	—	—
M-732-H-7	7	1/64	—	—	—	—	—	—	—	—	9 7/8	9 1/2	9 1/8	8 7/8	8 3/8
M-732-H-8	8	3/8	—	11 1/8	11 1/2	11 1/2	11 3/8	11 3/8	10 7/8	10 7/8	10 1/2	10	—	—	—



## Pipe Straps, Conduit Clamps and Hangers

### M-732-EXT — Adjustable Beam Clamp

Designed to attach to the bottom of flanged beams without requiring welding. Normally used with the M-129 Extension Piece (not furnished) up to a maximum 7/8" (M20) rod diameter. Loading is achieved through the clamp jaws while locking is accomplished by tightening the through-bolt located directly below the flange. Maximum flange thickness is .60 inches.

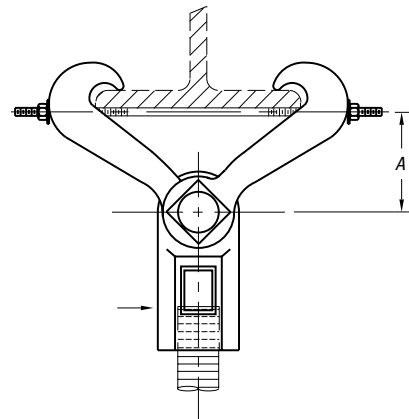

M-732-EXT

#### Specifications

- Material: Malleable Iron
- Compliance: Federal Specification A-A-1192A Type 30, MSS-SP-69 Type 30 when used with a Figure 157
- Finish: Standard Finish – GoldGalv®, Black (add suffix “-B”), Electro-Galvanized (add suffix “-EG”)
- Ordering: Specify catalog number and finish. Order M-129 separately if required.

CAT. NO.	MAX. ROD SIZE (IN.)	MAX. LOAD (LBS.)	ROD TAKE OUT BEAM FLANGE WIDTH — B (IN.)						WT. EACH (LBS.)
			2C 60	3 76	4 101	5 127	6 152	7 177	
M-732-EXT-3/8	3/8	610	3 1/2	3 7/16	3 5/16	2 15/16	2 9/16	1 7/8	1.91
M-732-EXT-1/2	1/2	1,130	3 1/2	3 7/16	3 5/16	2 15/16	2 9/16	1 7/8	2.11
M-732-EXT-5/8	5/8	1,365	3 1/2	3 7/16	3 5/16	2 15/16	2 9/16	1 7/8	2.15
M-732-EXT-3/4	3/4	1,365	3 1/2	3 7/16	3 5/16	2 15/16	2 9/16	1 7/8	2.36
M-732-EXT-7/8	7/8	1,365	3 1/2	3 7/16	3 5/16	2 15/16	2 9/16	1 7/8	2.49

## Pipe Straps, Conduit Clamps and Hangers

### C-728 — Pipe Roller (Pair)

- Cast aluminum rollers, steel brackets
- Designed for standard saddles
- Order separately for each pair of rollers: Two ½" x ⅝" hex head cap screws, two ½" channel nuts
- Space to fit O.D. of pipe and wrapping
- Adjustable for radius up to 8"

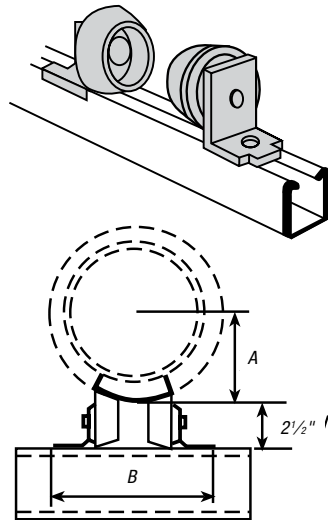

CAT. NO.	A MAX OS RADIUS (IN.)	B (IN.)	DESIGN LOAD (LBS.)	STD. CTN.
C728	3 ¾	6 ¼	2,350	5 pair (10 pieces)
	4 ½	7 ½	2,350	5 pair (10 pieces)
	6 ¾	8 ½	2,350	5 pair (10 pieces)
	8 ½	9 ⅞	2,350	5 pair (10 pieces)

### C728H — Pipe Roller Assembly (Pair)

Cast aluminum roller, steel brackets. Order separately for each pair of rollers:

- Two ½" x ⅝" hex head cap screws
- Two ½" channel nuts

Adjustable to fit O.D. pipe 6" through 18".

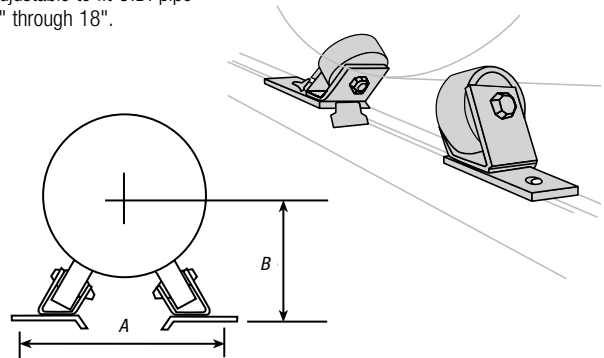

CAT. NO.	PIPE SIZE (IN.)	A (IN.)	B (IN.)	DESIGN LOAD (LBS.)	STD. CTN.
C728H	6	10 ⅜	6 ⅞	3,920	5 pair (10 pieces)
	8	11 ⅜	7 ⅞	3,920	5 pair (10 pieces)
	10	12 ⅞	8 ⅞	3,920	5 pair (10 pieces)
	12	13 ⅞	9 ⅞	3,920	5 pair (10 pieces)
	14	14 ½	9 ¾	3,920	5 pair (10 pieces)
	16	15 ½	10 ⅞	3,920	5 pair (10 pieces)
	18	16 ½	11 ⅞	3,920	5 pair (10 pieces)

### CR-729 — Roller Support

Used on steam or hot water systems where pipe is to be supported in tunnels, trenches, structural brackets and frames. Adjustment is made by raising and lowering the top nut on the legs and locked into position by tightening the lower nut.

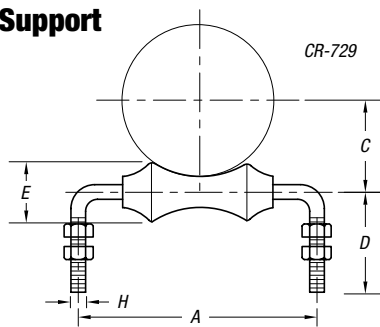

CR-729 PIPE SIZE OF ROLL	C-789 1" COV. 25	C-789A 1 ½" COV. 38	C-789B 2" COV. 51	C-789C 2 ½" COV. 64	C-789D 3" COV. 76	C-789E 4" COV. 100
4	2 ½-3	2-2 ½	—	—	—	—
5	3 ½	—	—	—	—	—
6	4-5	3-3 ½	2-2 ½	—	—	—
7	6	4-5	3-4	2-2 ½	2-2 ½	—
8	8	6	5	3-3 ½	3-3 ½	—
10	—	8	6	4-5	4-5	—
12	10	10	8	6	6-8	4-6
14	12	12	10	8	—	—
16	14	14	12-14	10	8	8

### Specifications

- Material: Steel Axle, Cast Iron Roll
- Finish: Standard Finish – GoldGalv®, Black (add suffix "-B"), Electro-Galvanized (add suffix "-EG")

CAT. NO.	PIPE SIZE (IN.)	MAX. LOAD (LBS.)	DIMENSIONS (IN.)					WT. EACH (LBS.)
			A	C	D	E	H	
CR-729-2	2	300	4 ½	1 ⅞	3 ¼	1 ⅞	¾	.79
CR-729-2-1/2	2 ½	600	5	1 ⅞	4 ½	1 ⅞	½	1.44
CR-729-3	3	600	5 ⅞	2 ¼	4 ½	1 ⅞	½	1.62
CR-729-3-1/2	3 ½	600	7	2 ⅞	4 ½	1 ⅞	½	1.64
CR-729-4	4	700	7	2 ⅞	4 ½	1 ⅞	½	1.82
CR-729-5	5	700	8 ½	3 ⅞	4 ½	2	¾	2.90
CR-729-6	6	1,000	10	4 ⅞	4 ½	2 ⅞	¾	4.66
CR-729-8	8	1,300	12	5 ⅞	5 ¼	2 ¾	¾	7.29
CR-729-10	10	1,700	14	6 ⅞	5 ½	3 ⅞	¾	10.23
CR-729-12	12	2,300	16	7 ⅞	6	3 ⅞	¾	12.27
CR-729-14	14	3,075	17	8 ¾	7	4 ¾	1	21.39
CR-729-16	16	3,075	19	9 ⅞	8	5 ⅞	1	27.76

## Pipe Straps, Conduit Clamps and Hangers

### C-729 — Harvard Roll Hanger

Designed to support piping lines from above, allowing for vertical adjustment and axial movement in the piping. The lower nut (not furnished) adjusts the pipe line to the proper elevation. The top nut (not furnished) prevents loosening due to vibration and must be tightened securely to assure proper hanger performance.

#### Specifications

- Material: Carbon Steel frame with a Cast Iron Roll. Do not exceed 450° F/232° C at the contact point to the roll.
  - Compliance: A-A-1192A Type 43 and MSS-SP-69 Type 43
  - Finish: Black (add suffix "-B"), Electro-Galvanized (add suffix "-HDG")
- For pipe with insulation and a pipe covering protection saddle the C-729 will have to be oversized to suit. Please see the table below showing the correct sizing for insulated pipe.
- Ordering: Specify pipe size, catalog number and finish.

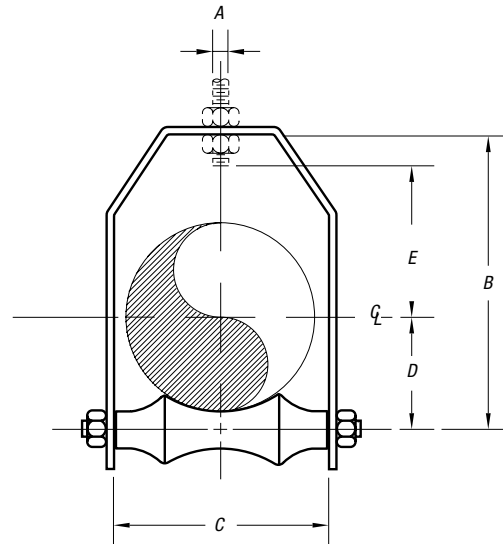

C-729

CAT. NO.	PIPE SIZE (IN.)	MAX. LOAD (LBS.)	DIMENSIONS (IN.)					WT. EACH (LBS.)
			ROD SIZE	A	B	C	D	
C-729-2	2	150	1/2	4 1/4	2 3/4	1 5/8	2 5/8	1.60
C-729-2-1/2	2 1/2	225	1/2	4 7/8	3 1/4	2	2 7/8	2.00
C-729-3	3	310	1/2	6 1/4	3 3/8	2 1/4	3 1/8	2.30
C-729-3-1/2	3 1/2	390	1/2	6 7/8	4 1/2	2 5/8	3 1/2	2.50
C-729-4	4	475	5/8	7 1/2	4 7/8	2 7/8	3 5/8	4.00
C-729-5	5	685	5/8	8 3/8	6 3/8	3 1/2	4 1/2	5.30
C-729-6	6	780	3/4	9 7/8	7 7/8	4	5	7.00
C-729-7	7	780	3/4	11 1/8	8 7/8	4 3/4	5 1/4	9.40
C-729-8	8	780	7/8	12 3/8	9 7/8	5 1/2	6 1/8	12.30
C-729-10	10	965	7/8	15	11 1/4	6 1/4	7 1/4	19.30
C-729-12	12	965	7/8	17 1/8	13 1/2	7 1/2	8 3/8	23.10
C-729-14	14	1,200	1	18 3/8	14 3/8	8 3/8	8 3/4	35.50
C-729-16	16	1,400	1	20 1/2	17 1/4	9 1/2	9 3/4	46.50
C-729-18	18	1,400	1	23 1/8	19	10 1/2	11 1/2	57.00
C-729-20	20	1,600	1 1/4	24 1/2	21	11 3/8	12 1/4	75.90
C-729-24	24	1,800	1 1/2	29 3/8	24 3/4	14	15 3/4	119.30

Standard Finish — GoldGalv®, unless otherwise stated.

C-729 PIPE SIZE OF ROLL	C-789 1" COV. 25	C-789A 1 1/2" COV. 38	C-789B 2" COV. 51	C-789C 2 1/2" COV. 64	C-789D 3" COV. 76	C-789E 4" COV. 100
2 1/2	3/4	—	—	—	—	—
3	1-1 1/2	—	—	—	—	—
4	2-2 1/2	1-1 1/2	—	—	—	—
5	3-3 1/2	2-2 1/2	3/4-1 1/2	—	—	—
6	4	3-3 1/2	2-2 1/2	3/4-1	—	—
7	5	4	3-3 1/2	1 1/4-1 1/2	2	—
8	6	5	4	2-3	2 1/2	—
10	8	6	5-6	3 1/2-5	3-4	—
12	10	8	8	6	5-6	—
14	12	10	—	8	5-6	—
16	14	12	10	10	8	8
18	—	14	14	12	12	10
20	—	16	16	14	14	12
24	—	20	20	18	18	16

Standard Finish — GoldGalv®, unless otherwise stated.

## Pipe Straps, Conduit Clamps and Hangers

### CR-729A — Roller Chair

Designed for longitudinal movement of pipe where vertical adjustment is not required. Although two bolts are supplied for installation, the chair can be alternatively welded in position.

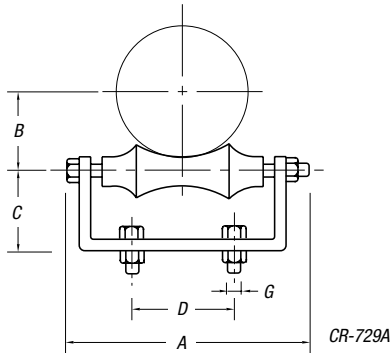

#### Specifications

- Material: Carbon Steel Chair and Axle with Cast Iron Pipe Roll. Use a Figure 17 when a Cast Iron Chair is required. Do not exceed 450° F/232° C at the contact point to the roll.
- Finish: Standard Finish – GoldGalv®, Black (add suffix “-B”), Electro-Galvanized (add suffix “-EG”).
- For pipe with insulation and a pipe covering protection saddle, the CR-729A will have to be oversized to suit.
- Please see the Table for the RC-729A which shows the correct sizing for insulated pipe.
- Ordering: Specify pipe size, catalog number and finish.

CAT. NO.	PIPE SIZE (IN.)	MAX. LOAD (LBS.)	DIMENSIONS (IN.)				BOLT SIZE G (IN.)	WT. EACH (LBS.)
			A	B	C	D		
CR-729-2A	2	300	4 <sup>7</sup> / <sub>8</sub>	1 <sup>1</sup> / <sub>2</sub>	1 <sup>1</sup> / <sub>2</sub>	2	<sup>3</sup> / <sub>8</sub> x 1 <sup>1</sup> / <sub>2</sub>	1.10
CR-729-2-1/2A	2 <sup>1</sup> / <sub>2</sub>	600	4 <sup>7</sup> / <sub>8</sub>	2	1 <sup>1</sup> / <sub>2</sub>	2	<sup>3</sup> / <sub>8</sub> x 1 <sup>1</sup> / <sub>2</sub>	1.40
CR-729-3A	3	600	6	2 <sup>1</sup> / <sub>4</sub>	1 <sup>3</sup> / <sub>4</sub>	2	<sup>3</sup> / <sub>8</sub> x 1 <sup>1</sup> / <sub>2</sub>	1.60
CR-729-3-1/2A	3 <sup>1</sup> / <sub>2</sub>	600	6 <sup>1</sup> / <sub>2</sub>	2 <sup>3</sup> / <sub>8</sub>	2 <sup>1</sup> / <sub>2</sub>	2	<sup>3</sup> / <sub>8</sub> x 1 <sup>1</sup> / <sub>2</sub>	2.60
CR-729-4A	4	700	7	2 <sup>7</sup> / <sub>8</sub>	2 <sup>3</sup> / <sub>8</sub>	2 <sup>1</sup> / <sub>2</sub>	<sup>3</sup> / <sub>8</sub> x 1 <sup>1</sup> / <sub>2</sub>	2.90
CR-729-5A	5	700	7 <sup>3</sup> / <sub>8</sub>	3 <sup>1</sup> / <sub>2</sub>	2 <sup>1</sup> / <sub>2</sub>	3	<sup>1</sup> / <sub>2</sub> x 2	3.90
CR-729-6A	6	1,000	9 <sup>3</sup> / <sub>4</sub>	4	2 <sup>3</sup> / <sub>4</sub>	3 <sup>3</sup> / <sub>4</sub>	<sup>1</sup> / <sub>2</sub> x 2	6.00
CR-729-8A	8	1,300	11 <sup>7</sup> / <sub>8</sub>	5 <sup>1</sup> / <sub>8</sub>	3	4 <sup>1</sup> / <sub>2</sub>	<sup>3</sup> / <sub>8</sub> x 2	9.00
CR-729-10A	10	1,700	14 <sup>1</sup> / <sub>2</sub>	6 <sup>3</sup> / <sub>8</sub>	3 <sup>3</sup> / <sub>8</sub>	5	<sup>3</sup> / <sub>4</sub> x 2 <sup>1</sup> / <sub>2</sub>	13.80
CR-729-12A	12	2,300	16 <sup>1</sup> / <sub>4</sub>	7 <sup>1</sup> / <sub>2</sub>	4 <sup>1</sup> / <sub>2</sub>	6	<sup>3</sup> / <sub>4</sub> x 2 <sup>1</sup> / <sub>2</sub>	18.90
CR-729-14A	14	3,100	18 <sup>1</sup> / <sub>2</sub>	8 <sup>3</sup> / <sub>8</sub>	4 <sup>3</sup> / <sub>4</sub>	6 <sup>1</sup> / <sub>2</sub>	<sup>3</sup> / <sub>4</sub> x 2 <sup>1</sup> / <sub>2</sub>	28.10
CR-729-16A	16	3,900	20	9 <sup>3</sup> / <sub>8</sub>	5 <sup>3</sup> / <sub>8</sub>	10	<sup>7</sup> / <sub>8</sub> x 3	34.90
CR-729-18A	18	4,200	22 <sup>3</sup> / <sub>4</sub>	10 <sup>1</sup> / <sub>2</sub>	6	9 <sup>1</sup> / <sub>4</sub>	<sup>3</sup> / <sub>4</sub> x 2 <sup>1</sup> / <sub>2</sub>	44.40
CR-729-20A	20	4,500	25 <sup>3</sup> / <sub>8</sub>	11 <sup>3</sup> / <sub>8</sub>	6 <sup>1</sup> / <sub>2</sub>	10 <sup>1</sup> / <sub>4</sub>	<sup>3</sup> / <sub>4</sub> x 2 <sup>1</sup> / <sub>2</sub>	56.30
CR-729-24	24	6,000	30	14	7 <sup>7</sup> / <sub>8</sub>	12 <sup>1</sup> / <sub>4</sub>	<sup>7</sup> / <sub>8</sub> x 3 <sup>1</sup> / <sub>2</sub>	87.50

Standard Finish – GoldGalv®, unless otherwise stated.

### RC-729 — Adjustable Roll Support

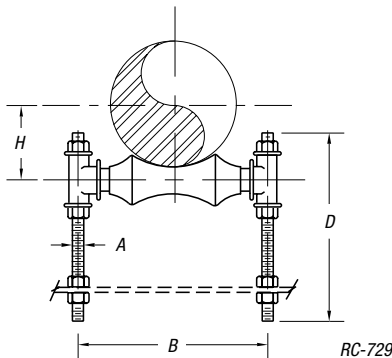

#### Specifications

- Material: Cast Iron Pipe Roll and Sockets, Carbon Steel Axle, Continuous Thread Rods and Hex Nuts. Do not exceed 450° F/232° C at the contact point to the roll.
- Finish: Standard Finish – GoldGalv®, Black (add suffix “-B”), Electro-Galvanized (add suffix “-EG”).
- For pipe with insulation and a pipe covering protection saddle, the RC-729 will have to be oversized to suit.
- Please see the table for the RC-729A which shows the correct sizing for insulated pipe.
- Ordering: Specify pipe size, catalog number and finish.

CAT. NO.	PIPE SIZE (IN.)	MAX. LOAD (LBS.)	DIMENSIONS (IN.)				WT. EACH (LBS.)
			A	B	D	H	
RC-729-1-1/4	1 <sup>1</sup> / <sub>4</sub>	300	<sup>3</sup> / <sub>8</sub>	3 <sup>3</sup> / <sub>8</sub>	7 <sup>1</sup> / <sub>4</sub>	1 <sup>1</sup> / <sub>4</sub>	1.08
RC-729-1-1/2	1 <sup>1</sup> / <sub>2</sub>	300	<sup>3</sup> / <sub>8</sub>	3 <sup>3</sup> / <sub>8</sub>	7 <sup>1</sup> / <sub>4</sub>	1 <sup>1</sup> / <sub>2</sub>	1.11
RC-729-2	2	300	<sup>3</sup> / <sub>8</sub>	4 <sup>1</sup> / <sub>8</sub>	7 <sup>1</sup> / <sub>4</sub>	1 <sup>1</sup> / <sub>2</sub>	1.65
RC-729-2-1/2	2 <sup>1</sup> / <sub>2</sub>	600	<sup>1</sup> / <sub>2</sub>	5 <sup>1</sup> / <sub>2</sub>	8	2	2.72
RC-729-3	3	600	<sup>1</sup> / <sub>2</sub>	6 <sup>1</sup> / <sub>8</sub>	8	2 <sup>1</sup> / <sub>4</sub>	2.72
RC-729-3-1/2	3 <sup>1</sup> / <sub>2</sub>	700	<sup>1</sup> / <sub>2</sub>	7 <sup>1</sup> / <sub>8</sub>	8	2 <sup>3</sup> / <sub>8</sub>	2.72
RC-729-4	4	700	<sup>5</sup> / <sub>8</sub>	7 <sup>1</sup> / <sub>8</sub>	8 <sup>1</sup> / <sub>2</sub>	2 <sup>1</sup> / <sub>2</sub>	3.91
RC-729-5	5	700	<sup>5</sup> / <sub>8</sub>	8 <sup>3</sup> / <sub>8</sub>	9	3 <sup>1</sup> / <sub>2</sub>	4.63
RC-729-6	6	1,000	<sup>3</sup> / <sub>4</sub>	9 <sup>3</sup> / <sub>8</sub>	9	4	7.07
RC-729-8	8	1,300	<sup>7</sup> / <sub>8</sub>	12	10	5 <sup>1</sup> / <sub>8</sub>	11.40
RC-729-10	10	1,700	<sup>7</sup> / <sub>8</sub>	14 <sup>1</sup> / <sub>8</sub>	11	6 <sup>3</sup> / <sub>8</sub>	13.70
RC-729-12	12	2,300	<sup>7</sup> / <sub>8</sub>	16 <sup>1</sup> / <sub>8</sub>	12	7 <sup>1</sup> / <sub>2</sub>	15.90
RC-729-14	14	3,075	1	17 <sup>3</sup> / <sub>4</sub>	12	8 <sup>3</sup> / <sub>8</sub>	28.70
RC-729-16	16	3,970	1	19 <sup>3</sup> / <sub>4</sub>	18	9 <sup>1</sup> / <sub>2</sub>	42.50
RC-729-18	18	4,200	1	21 <sup>1</sup> / <sub>8</sub>	18	10 <sup>1</sup> / <sub>2</sub>	46.60
RC-729-20	20	4,550	1 <sup>1</sup> / <sub>4</sub>	24 <sup>1</sup> / <sub>4</sub>	18	11 <sup>3</sup> / <sub>8</sub>	66.20
RC-729-24	24	6,160	1 <sup>1</sup> / <sub>2</sub>	28 <sup>3</sup> / <sub>8</sub>	24	14	102.50
RC-729-30	30	7,290	1 <sup>1</sup> / <sub>2</sub>	35 <sup>1</sup> / <sub>2</sub>	24	17 <sup>1</sup> / <sub>2</sub>	186.80

Standard Finish – GoldGalv®, unless otherwise stated.

## Pipe Straps, Conduit Clamps and Hangers

### RC-729A — Adjustable Roll Support

Designed for longitudinal movement of pipe where vertical adjustment is required. Although primarily used for support of the pipe, this component may also be placed over the pipe to act as a guide.

#### Specifications

- Material: Cast Iron Pipe Roll and Sockets with a Carbon Steel Axle. Do not exceed 450° F/232° C at the contact point to the roll.
- Compliance: A-A-1192A Type 42, MSS SP-69 Type 41.
- Finish: Black (add suffix "-B"). Electro-Galvanized (add suffix "-HDG").
- For pipe with insulation and a pipe covering protection saddle, the RC-729A will have to be oversized to suit.
- Please see the table below which shows the correct sizing for insulated pipe.
- Ordering: Specify pipe size, catalog number and finish.

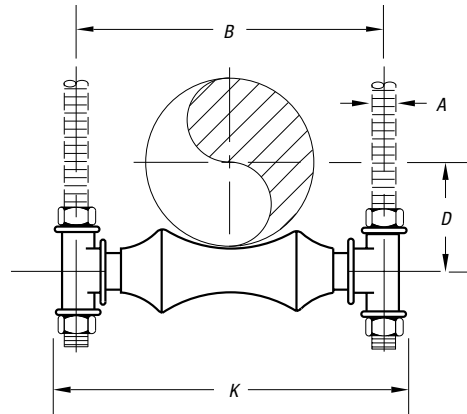

RC-729A

CAT. NO.	PIPE SIZE (IN.)	MAX. LOAD (LBS.)	DIMENSIONS (IN.)				WT. EACH (LBS.)
			ROD SIZE A	B	D	K	
RC-729A-1	1	600	3/8	3	1	4 1/2	.45
RC-729A-1-1/4	1 1/4	600	3/8	3 3/8	1 1/4	4 1/2	.48
RC-729A-1-1/2	1 1/2	600	3/8	3 3/8	1 1/2	4 3/4	.51
RC-729A-2	2	600	3/8	4 1/8	1 1/2	5 1/4	.57
RC-729A-2-1/2	2 1/2	600	1/2	5 1/2	2	7	1.48
RC-729A-3	3	700	1/2	6 1/8	2 1/4	7 3/8	1.48
RC-729A-4	4	700	5/8	7 1/8	2 1/2	8 3/8	1.78
RC-729A-5	5	700	5/8	8 3/8	3 1/2	9 3/8	2.42
RC-729A-6	6	1,000	3/4	9 3/8	4	11 1/8	3.96
RC-729A-7	7	1,200	3/4	10 3/4	4 3/4	12 1/2	5.99
RC-729A-8	8	1,300	7/8	12	5 1/8	14	6.43
RC-729A-10	10	1,700	7/8	14 1/8	6 1/4	16	8.45
RC-729A-12	12	2,400	7/8	16 1/8	7 1/2	18	10.20
RC-729A-14	14	3,100	1	17 3/4	8 3/8	20	20.90
RC-729A-16	16	3,900	1	19 3/8	9 1/2	22 1/8	26.07
RC-729A-18	18	4,200	1	22 1/8	10 1/2	24 3/8	36.59
RC-729A-20	20	4,500	1 1/4	24 1/8	11 3/8	26 3/8	39.00
RC-729A-24	24	6,100	1 1/2	28 3/8	14	32 1/8	66.90
RC-729A-30	30	7,200	1 1/2	35 1/2	17 1/2	39 3/8	134.00

RC-729A PIPE SIZE OF ROLL	PIPE SIZE OF COVERING PROTECTION SADDLE TO BE USED WITH RC-729A					
	C-789 1" COV. 25	C-789A 1 1/2" COV. 38	C-789B 2" COV. 51	C-789C 2 1/2" COV. 64	C-789D 3" COV. 76	C-789E 4" COV. 100
2 1/2	3/4-1	—	—	—	—	—
3	1 1/4-1 1/2	3/4-1	—	—	—	—
4	2 1/2-3	1 1/2	3/4-1	—	—	—
5	3 1/2	2-2 1/2	1 1/4-1 1/2	3/4-1	—	—
6	4-5	3-3 1/2	2-2 1/2	1 1/4-1 1/2	—	—
7	6	4-5	3-4	2-2 1/2	2-2 1/2	—
8	—	6	5	3-3 1/2	3-3 1/2	—
10	8	8	6	4-5	4-5	—
12	10	10	8	6	6-8	4-6
14	12	12	10	8	—	—
16	14	14	12-14	10	10	8
18	16	16	16	12-14	12-14	10
20	18	18	—	16	—	12
24	20	20	18-20	18-20	16-20	14-18
30	24	24	24	24	24	20-24

Standard Finish — GoldGalv®, unless otherwise stated.

## Pipe Straps, Conduit Clamps and Hangers

### S-730-C — Chair and Roll

Designed for longitudinal movement of pipe where vertical adjustment is not required. Because the chair is made of steel, it can be either welded or bolted in position.

#### Specifications

- Material: Carbon Steel Chair and Axle with Cast Iron Pipe Roll.  
Use a Figure 17 when a Cast Iron Chair is required.  
Do not exceed 450° F/232° C at the contact point to the roll.
- Compliance: Federal Specification A-A-1192A Type 44, MSS-SP-69 Type 44.
- Finish: Black (add suffix "-B"). Electro-Galvanized (add suffix "-HDG").  
For pipe with insulation and a pipe covering protection saddle, the S-730-C will have to be oversized to suit.  
Please see the Table below showing the correct sizing for insulated pipe.
- Ordering: Specify chair number, catalog number and finish.

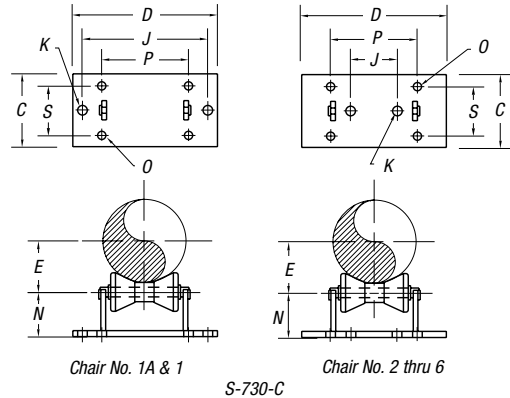

CHAIR NO.	BARE PIPE SIZE	C-789 1" COV. 25	C-789A 1½" COV. 38	C-789B 2" COV. 51	C-789C 2½" COV. 64	C-789D 3" COV. 76	C-789E 4" COV. 102
—	1½	—	—	—	—	—	—
—	2	—	—	—	—	—	—
—	2½	¾-3	¾-2½	¾-1¾	—	—	—
—	3	20-80	20-65	20-40	—	—	—
—	3½	—	—	—	—	—	—
1	4	4-6	3-5	2-4	¾-1½	—	—
—	5	100-150	80-125	50-100	20-40	—	—
—	6	—	—	—	—	—	—
2	8	8	6-8	5-8	2-5	2-6	4-5
—	10	200	150-200	125-200	50-125	50-150	100-125
3	12	10-12	10-12	10-12	6-8	8	6-8
—	14	250-300	250-300	250-300	150-200	200	150-200
4	16	14-18	14-18	14-18	10-16	10-14	10-12
—	18	350-450	350-450	350-450	250-400	250-350	250-300
—	20	—	—	—	—	—	—
5	24	20	20	18-20	18-20	16-18	14-18
5	600	500	500	450-500	450-500	400-450	350-450
6	30	24	24	24	24	20-24	20-24
6	750	600	600	600	600	500-600	500-600
7	36	30	30	30	30	30	28
—	900	750	750	750	750	750	700
7	42	40	36	36	36	36	32
—	1,050	1,000	900	900	900	900	800

CAT. NO.	CHAIR NO.	MAX. LOAD (LBS.)	BARE PIPE SIZE (IN.)	DIMENSIONS (IN.)										WT. EACH (LBS.)
				C	D	E	J	K	M	N	O	P	S	
S-730-C-1A	1½	390	2	6	8½	1½	6½	1	¼	2	¼	¾	4½	7.0
			2½		1¾									
			3		2½									
			3½		2¾									
S-730-C-1	1	950	4	6	10½	2¼	8	1	¼	2¾	¼	4¾	4¼	10.5
			5		3¾									
			6		3¾									
S-730-C-2	2	2,100	8	7	9	5½	4	1	¾	¾	1½	7	5	16.5
			10		6¼									
S-730-C-3	3	3,075	12	8	11	7¾	5¼	1	¾	¾	1½	9	6	26.8
			14		8									
S-730-C-4	4	4,980	16	9	12½	8¾	6¾	1	½	¾	1½	10	6½	40.5
			18		10									
			20		11									
S-730-C-5	5	6,100	24	8¾	13¾	13	7½	1	¾	¾	1½	11½	6¾	51.0
S-730-C-6	6	7,500	30	11	17¼	16¼	10	1	¾	¾	1½	14¼	8	89.8
S-730-C-7	7	12,000	36	12	20	20	12	1	1	5½	1½	17	9	145
			42		23¾									

## Pipe Straps, Conduit Clamps and Hangers

### C-786 — Adjustable Pipe Support

Used for support of piping from below without welding to the pipe, and consists of a steel saddle, nipple and pipe reducer. It connects to a threaded pipe standard and base.

Rated loads are for up to 650° F (343° C).

#### Specifications

- Materials: Reducer is Cast Iron, Pipe saddle and nipple are carbon steel.
- Compliance: Federal Specification A-A-1192A Type 39, MSS-SP-69 Type 39.
- Finish: Standard Finish – GoldGalv®, Black (add suffix “-B”), Electro-Galvanized (add suffix “-EG”).
- Ordering: Specify pipe size, catalog number and finish.

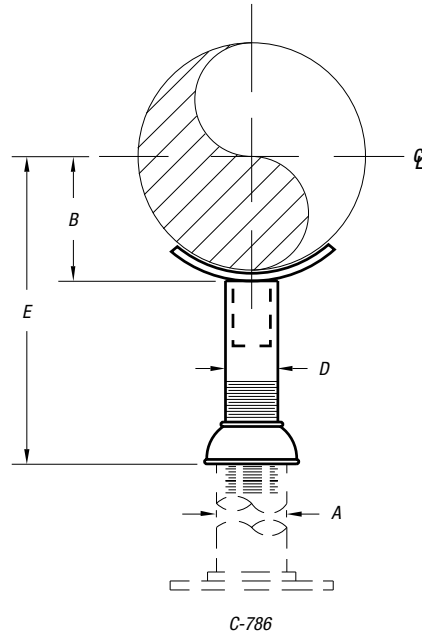

CAT. NO.	PIPE SIZE (IN.)	MAX. LOAD (LBS.)	DIMENSIONS (IN.)					
			A	B	D	MIN. E	MAX. E	WT. EACH (LBS.)
C-786-1-1/2	1½	5,000	2½	1¼	1½	8	13	4.75
C-786-2	2	5,000	2½	1½	1½	8	13	4.80
C-786-2-1/2	2½	5,000	2½	1¾	1½	8	13	4.90
C-786-3	3	5,000	2½	2¼	1½	8¼	13¼	5.00
C-786-4	4	7,000	3	2¾	2½	9¾	14¾	9.30
C-786-5	5	7,000	3	3¼	2½	9¾	14¾	9.65
C-786-6	6	7,000	3	3¾	2½	10¼	15¼	11.70
C-786-8	8	7,000	3	4¾	2½	11¼	16¼	12.90
C-786-10	10	7,000	3	5¾	2½	12¾	17¾	14.10
C-786-12	12	7,000	3	6¾	2½	13¾	18¾	15.30
C-786-14	14	7,000	4	7½	3	15½	20½	21.70
C-786-16	16	7,000	4	8¾	3	16¾	21¾	25.40
C-786-18	18	7,000	6	9¾	4	19¾	24¾	39.30
C-786-20	20	7,000	6	10¾	4	20¾	25¾	44.90
C-786-24	24	10,000	6	12¾	4	22¼	27¼	54.30
C-786-30	30	10,000	6	15¾	4	25¼	30¼	62.40
C-786-36	36	10,000	6	18¾	4	28¼	33¼	70.20

Standard Finish – GoldGalv®, unless otherwise stated.

## Pipe Straps, Conduit Clamps and Hangers

### C-789, C-789A, C789B, C-789C, C-789D, C-789E — Pipe Covering Protection Saddle

The C-789 saddles are used to protect the insulation against damage and keep heat loss to a minimum. They are designed for 1" to 5" of covering. All Saddles are 12" long with three tabs on each side for welding to pipe. Sizes 12" and larger have a welded-in center rib.

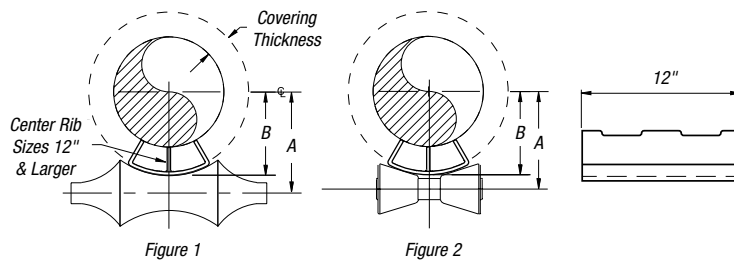

C-789

#### Specifications

- Material: Carbon Steel (except C-789 and C-789-8 which are Chromium Molybdenum Steel).
- Finish: Standard Finish – GoldGalv®, Black (add suffix “-B”), Electro-Galvanized (add suffix “-EG”).
- Compliance: Federal Specification A-A-1192A Type 39A or 39B, MSS-SP-69 Type 39A or 39B and BSPSS-BS3974.
- Ordering: Specify catalog number and pipe size.

#### Pipe Saddles and Pipe Shields

CAT. NO.	PIPE SIZE (IN.)	MAX. COVERING THICKNESS (IN.)	ACTUAL COVERING THICKNESS (IN.)	MAX. LOAD (LBS.)	FIGURE 1 (IN.)			FIGURE 2 (IN.)			WT. EACH (LBS.)
					ROLL SIZE	A	B	ROLL SIZE	A	B	
C-789-3/4	¾	1	1 <sup>5</sup> / <sub>16</sub>	1,200	2½	2 <sup>1</sup> / <sub>8</sub>	1 <sup>5</sup> / <sub>8</sub>	2-3½	2 <sup>5</sup> / <sub>16</sub>	1 <sup>5</sup> / <sub>8</sub>	1.15
C-789A-3/4	¾	1½	1½	1,200	3	2 <sup>3</sup> / <sub>8</sub>	2 <sup>1</sup> / <sub>8</sub>	2-3½	2 <sup>11</sup> / <sub>16</sub>	2 <sup>1</sup> / <sub>4</sub>	2.10
C-789B-3/4	¾	2	2	1,200	4	3¼	2 <sup>3</sup> / <sub>8</sub>	2-3½	3 <sup>3</sup> / <sub>8</sub>	2 <sup>3</sup> / <sub>4</sub>	2.63
C-789-1	1	1	1 <sup>1</sup> / <sub>16</sub>	1,200	2¼	2¼	1¼	2-3½	2 <sup>1</sup> / <sub>16</sub>	1¼	1.15
C-789A-1	1	1½	1 <sup>9</sup> / <sub>16</sub>	1,200	3	2 <sup>3</sup> / <sub>8</sub>	2 <sup>3</sup> / <sub>8</sub>	2-3½	2 <sup>15</sup> / <sub>16</sub>	2 <sup>3</sup> / <sub>8</sub>	2.10
C-789B-1	1	2	2 <sup>1</sup> / <sub>8</sub>	1,200	4	3 <sup>3</sup> / <sub>8</sub>	2 <sup>3</sup> / <sub>4</sub>	2-3½	3½	2 <sup>3</sup> / <sub>4</sub>	2.63
C-789-1-1/4	1¼	1	¾	1,200	3	2½	2	2-3½	2 <sup>9</sup> / <sub>16</sub>	2	1.25
C-789A-1-1/4	1¼	1½	1 <sup>5</sup> / <sub>8</sub>	1,200	3½	3	2½	2-3½	3 <sup>3</sup> / <sub>16</sub>	2½	2.10
C-789B-1-1/4	1¼	2	1 <sup>15</sup> / <sub>16</sub>	1,200	5	3 <sup>3</sup> / <sub>8</sub>	3 <sup>1</sup> / <sub>16</sub>	2-3½	3 <sup>11</sup> / <sub>16</sub>	3 <sup>1</sup> / <sub>16</sub>	2.63
C-789C-1-1/4	1¼	2½	2½	1,200	6	4¼	3½	4-6	4 <sup>1</sup> / <sub>16</sub>	3½	3.25
C-789-1-1/2	1½	1	1 <sup>1</sup> / <sub>16</sub>	1,200	3	2½	2	2-3½	2 <sup>11</sup> / <sub>16</sub>	2	1.50
C-789A-1-1/2	1½	1½	1 <sup>9</sup> / <sub>16</sub>	1,200	4	3 <sup>3</sup> / <sub>8</sub>	2 <sup>3</sup> / <sub>8</sub>	2-3½	3 <sup>3</sup> / <sub>16</sub>	2 <sup>3</sup> / <sub>4</sub>	2.10
C-789B-1-1/2	1½	2	2 <sup>3</sup> / <sub>8</sub>	1,800	5	4 <sup>9</sup> / <sub>16</sub>	3 <sup>3</sup> / <sub>8</sub>	2-3½	3¾	3 <sup>3</sup> / <sub>8</sub>	3.10
C-789C-1-1/2	1½	2½	2 <sup>3</sup> / <sub>8</sub>	1,800	6	4 <sup>5</sup> / <sub>8</sub>	3 <sup>3</sup> / <sub>8</sub>	4-6	4 <sup>3</sup> / <sub>16</sub>	3 <sup>3</sup> / <sub>8</sub>	3.75
C-789-2	2	1	1 <sup>1</sup> / <sub>16</sub>	1,200	3½	2 <sup>3</sup> / <sub>8</sub>	2 <sup>3</sup> / <sub>8</sub>	2-3½	2 <sup>15</sup> / <sub>16</sub>	2 <sup>3</sup> / <sub>8</sub>	1.63
C-789A-2	2	1½	1 <sup>9</sup> / <sub>16</sub>	1,200	4	3 <sup>9</sup> / <sub>16</sub>	2 <sup>3</sup> / <sub>8</sub>	2-3½	3 <sup>3</sup> / <sub>16</sub>	2 <sup>3</sup> / <sub>4</sub>	2.10
C-789B-2	2	2	2 <sup>1</sup> / <sub>8</sub>	1,800	6	4¼	3½	4-6	3 <sup>3</sup> / <sub>8</sub>	3½	3.12
C-789C-2	2	2½	2 <sup>3</sup> / <sub>8</sub>	1,800	7	4¼	4	4-6	4 <sup>13</sup> / <sub>16</sub>	4	3.63
C-789D-2	2	3	3 <sup>1</sup> / <sub>16</sub>	1,800	7	5¼	4½	7-10	5 <sup>5</sup> / <sub>16</sub>	4½	4.40
C-789-2-1/2	2½	1	1 <sup>1</sup> / <sub>16</sub>	1,200	4	3½	2 <sup>3</sup> / <sub>8</sub>	2-3½	3 <sup>3</sup> / <sub>16</sub>	2 <sup>3</sup> / <sub>4</sub>	1.75
C-789A-2-1/2	2½	1½	1 <sup>5</sup> / <sub>8</sub>	1,200	6	4½	3 <sup>3</sup> / <sub>8</sub>	2-3½	3¾	3 <sup>3</sup> / <sub>8</sub>	2.40
C-789B-2-1/2	2½	2	2 <sup>3</sup> / <sub>8</sub>	1,800	6	4 <sup>5</sup> / <sub>8</sub>	3 <sup>3</sup> / <sub>8</sub>	4-6	4 <sup>3</sup> / <sub>16</sub>	3 <sup>3</sup> / <sub>8</sub>	3.12
C-789C-2-1/2	2½	2½	2 <sup>3</sup> / <sub>8</sub>	1,800	7	5 <sup>9</sup> / <sub>16</sub>	4 <sup>3</sup> / <sub>8</sub>	7-10	5 <sup>1</sup> / <sub>16</sub>	4 <sup>3</sup> / <sub>8</sub>	3.63
C-789D-2-1/2	2½	3	3 <sup>3</sup> / <sub>8</sub>	1,800	7	5 <sup>5</sup> / <sub>8</sub>	4 <sup>3</sup> / <sub>8</sub>	7-10	5 <sup>5</sup> / <sub>16</sub>	4 <sup>3</sup> / <sub>8</sub>	4.40

Standard Finish – GoldGalv®, unless otherwise stated.



## Pipe Straps, Conduit Clamps and Hangers

### Pipe Saddles and Pipe Shields (Continued)

CAT. NO.	PIPE SIZE (IN.)	MAX. COVERING THICKNESS (IN.)	ACTUAL COVERING THICKNESS (IN.)	MAX. LOAD (LBS.)	FIGURE 1 (IN.)			FIGURE 2 (IN.)			WT. EACH (LBS.)
					ROLL SIZE	A	B	ROLL SIZE	A	B	
C-789-3	3	1	1/16	1,200	4	3 1/2	2 1/8	2-3 1/2	3 1/16	2 1/8	1.75
C-789A-3	3	1 1/2	1 1/16	1,800	6	4 1/2	3 3/4	4-6	4 1/16	3 3/4	2.75
C-789B-3	3	2	2 1/16	1,800	7	4 3/4	4	4-6	4 3/16	4	3.50
C-789C-3	3	2 1/2	2 3/16	1,800	8	5 3/8	4 5/8	7-10	5 3/8	4 5/8	3.93
C-789D-3	3	3	3 1/16	1,800	8	5 5/8	5	7-10	6	5	4.40
C-789-4	4	1	1 1/16	5,000	6	4 1/4	3 1/2	4-6	4	3 1/2	2.13
C-789A-4	4	1 1/2	1 1/16	5,000	7	4 3/4	4	4-6	4 1/16	4	3.00
C-789B-4	4	2	2 1/16	5,000	7	5 3/8	4 5/8	4-6	5 1/8	4 5/8	3.50
C-789C-4	4	2 1/2	2 3/16	5,000	10	6	5 1/8	7-10	5 1/8	5 1/8	3.93
C-789D-4	4	3	3 1/8	5,000	10	6 5/8	5 3/4	7-10	6 3/8	5 3/4	5.00
C-789E-4	4	4	4 1/8	5,000	12	7 3/4	6 1/2	7-10	7 3/16	6 1/2	6.30
C-789-4	4	4	4 1/16	5,000	12	7 3/4	6 1/2	7-10	7 7/8	6 1/2	14.45
C-789-4	4	5 1/2	5 1/16	5,000	16	9 5/8	8 1/4	16	9 1/2	8 1/4	26.40
C-789-5	5	1	1 1/16	1,800	6	4 3/8	4 1/8	4-6	4	4 1/8	2.38
C-789A-5	5	1 1/2	1 1/16	1,800	7	5 1/2	4 3/4	4-6	5 3/16	4 3/4	3.00
C-789B-5	5	2	2 1/16	1,800	8	6	5 1/4	7-10	6	5 1/4	3.62
C-789C-5	5	2 1/2	2 3/16	1,800	10	6 5/8	5 3/4	7-10	6 1/16	5 3/4	4.06
C-789D-5	5	3	3 1/16	1,800	10	7 1/8	6 1/4	7-10	7 3/32	6 1/4	5.00
C-789E-5	5	4	4 1/4	1,800	12	8 1/4	7	7-10	8 3/32	7	6.30
C-789-5	5	4	4 1/16	5,000	12	8 3/8	7 1/8	7-10	8 1/4	7 1/8	14.95
C-789-5	5	5 1/2	5 1/16	5,000	18	10 3/16	8 3/4	18	10 3/4	8 3/4	27.40
C-789-6	6	1	1	1,800	7	5 3/8	4 3/8	4-6	5 1/8	4 3/8	3.85
C-789A-6	6	1 1/2	1 1/2	1,800	8	5 3/8	5	7-10	6 3/16	5	4.75
C-789B-6	6	2	2 1/16	1,800	10	6 3/8	5 1/2	7-10	6 1/2	5 1/2	6.28
C-789C-6	6	2 1/2	2 3/16	1,800	12	7	6	12-15	7 1/8	6	7.09
C-789D-6	6	3	3 1/16	1,800	12	7 3/4	6 1/2	7-10	7 1/2	6 1/2	8.10
C-789E-6	6	4	4 1/16	1,800	12	8 3/8	7 1/8	12-15	8 3/16	7 1/8	10.15
C-789-6	6	4	4 1/8	7,200	12	8 3/8	7 1/8	12-15	8 3/8	7 1/8	16.00
C-789-6	6	5 1/2	5 3/8	7,200	18	11 3/16	10	18	11 1/2	10	27.50
C-789-8	8	1	1 1/16	1,800	10	7	6	7-10	6 3/16	6	5.05
C-789A-8	8	1 1/2	1 1/16	1,800	10	7	6	7-10	7 3/16	6	5.25
C-789B-8	8	2	2 1/16	1,800	12	7 1/2	6 1/2	7-10	7 1/16	6 1/2	7.00
C-789C-8	8	2 1/2	2 1/16	1,800	14	8 1/4	7	12-15	8 1/16	7	7.55
C-789D-8	8	3	3 3/16	1,800	12	8 3/8	7 1/8	12-15	8 7/32	7 1/8	9.90
C-789E-8	8	4	4 3/16	1,800	16	10	8 3/4	12-15	9 3/16	8 3/4	10.13
C-789-8	8	4	4 1/16	7,200	16	10	8 3/4	12-15	9 3/8	8 3/4	16.90
C-789-8	8	5 1/2	5 3/16	7,200	20	11 3/16	10 1/4	20	11 3/4	10 1/4	34.10
C-789-10	10	1	1	1,800	10	8 1/4	7 1/4	7-10	6 3/16	7 1/4	5.05
C-789A-10	10	1 1/2	1 1/8	1,800	10	8 1/4	7 1/4	7-10	7 3/16	7 1/4	5.25
C-789B-10	10	2	2 1/16	1,800	12	9 1/8	7 3/8	7-10	7 1/16	7 3/8	7.0
C-789C-10	10	2 1/2	2 1/8	1,800	16	9 5/8	8 1/8	16-20	9 1/16	8 1/8	8.75
C-789D-10	10	3	3 1/8	5,000	16	10 1/8	8 3/8	16-20	10 3/8	8 3/8	10.70
C-789E-10	10	4	4 1/8	5,000	18	11 1/8	9 1/4	16-20	11 1/16	9 1/4	13.88
C-789-10	10	4	4 1/16	7,200	18	11 1/8	9 1/4	16-20	11 1/8	9 1/4	17.50
C-789-10	10	5 1/2	5 3/16	7,200	20	13 3/8	11 1/4	20	12 5/8	11 1/4	36.60
C-789-12	12	1	1 1/8	2,500	14	9 3/8	8 1/8	12-15	9 1/4	8 1/8	7.30
C-789A-12	12	1 1/2	1 1/8	5,000	14	9 3/8	8 1/8	12-15	9 3/8	8 1/8	7.35
C-789B-12	12	2	2 1/8	5,000	16	10	8 3/8	16-20	9 3/16	8 3/8	9.20
C-789C-12	12	2 1/2	2 1/8	5,000	18	10 1/2	9 1/8	16-20	10 3/16	9 1/8	10.04
C-789D-12	12	3	3 1/8	5,000	18	11 1/4	9 1/8	16-20	11 1/16	9 1/8	11.00
C-789E-12	12	4	4 1/8	5,000	20	12 1/4	10 1/4	16-20	12 1/16	10 1/4	14.45
C-789-12	12	4	4 1/8	11,000	20	12 1/4	10 1/4	16-20	12 1/8	10 1/4	28.00
C-789-12	12	5 1/2	5 3/16	11,000	24	14 1/4	12 3/8	24	13 3/4	12 3/8	36.60

## Pipe Straps, Conduit Clamps and Hangers

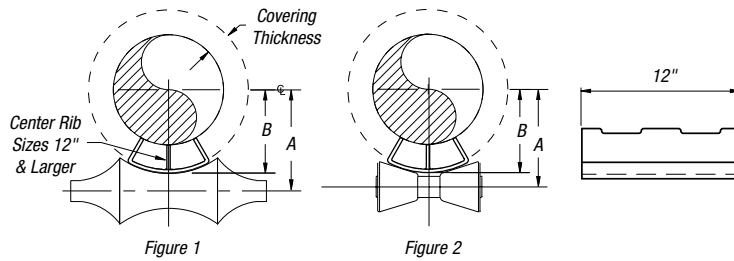

C-789

### Pipe Saddles and Pipe Shields (Continued)

CAT. NO.	PIPE SIZE (IN.)	MAX. COVERING THICKNESS (IN.)	ACTUAL COVERING THICKNESS (IN.)	MAX. LOAD (LBS.)	FIGURE 1 (IN.)			FIGURE 2 (IN.)			WT. EACH (LBS.)
					ROLL SIZE	A	B	ROLL SIZE	A	B	
C-789A-14	14	1½	1½	5,000	16	10¼	9	16-20	10¾	9	8.25
C-789B-14	14	2	2	5,000	18	10¾	9¾	16-20	10¾	9¾	9.20
C-789C-14	14	2½	2½	5,000	18	11¾	9¾	16-20	11¼	9¾	10.04
C-789D-14	14	3	3	5,000	18	12	10½	16-20	11¼	10½	11.00
C-789E-14	14	4	4	5,000	24	13¾	11¾	22-24	12¾	11¾	15.50
C-789-14	14	4	4	11,000	24	12¾	11¼	22-24	11¾	11¼	27.60
C-789-14	14	5½	5½	11,000	24	15	13¾	24	14½	13¾	36.60
C-789A-16	16	1½	1½	5,000	18	11¾	9¾	16-20	11¼	9¾	8.25
C-789B-16	16	2	2	5,000	20	11¼	10¼	16-20	11¾	10¼	9.20
C-789C-16	16	2½	2½	7,200	20	12¼	10¾	16-20	12¼	10¾	13.69
C-789D-16	16	3	3	7,200	24	12¾	11¾	22-24	12¾	11¾	14.65
C-789E-16	16	4	4	7,200	24	14	12¼	22-24	13¾	12¼	15.50
C-789-16	16	4	4	11,000	24	14	12¼	22-24	13¾	12¼	30.10
C-789-16	16	5½	5½	11,000	30	16¾	13¾	30	15¾	13¾	39.00
C-789A-18	18	1½	1½	5,000	20	12¼	10¾	16-20	12¼	10¾	9.35
C-789B-18	18	2	2	7,200	24	13¾	11¾	22-24	12¾	11¾	12.00
C-789C-18	18	2½	2½	7,200	24	13½	11¾	22-24	13	11¾	14.19
C-789D-18	18	3	3	7,200	24	14	12¼	22-24	13½	12¼	15.25
C-789E-18	18	4	4	7,200	24	15¾	13¾	22-24	14¾	13¾	21.00
C-789-18	18	4	4	13,200	24	15¾	13¾	22-24	14¾	13¾	40.30
C-789-18	18	5½	5½	13,200	30	17¾	15	30	16¾	15	52.10
C-789A-20	20	1½	1½	7,200	24	13½	11¾	22-24	13	11¾	11.05
C-789B-20	20	2	2	7,200	24	14	12¼	22-24	13½	12¼	12.40
C-789C-20	20	2½	2½	7,200	24	14¾	12¾	22-24	14¾	12¾	14.19
C-789D-20	20	3	3	7,200	24	15¼	13¾	26-30	14¾	13¾	15.25
C-789E-20	20	4	4	7,200	30	16½	14¼	26-30	15¾	14¼	22.80
C-789-20	20	4	4	13,200	7	16¾	14¾	26-30	15¾	14¾	44.80
C-789-20	20	5½	5½	13,200	30	18¾	16	30	17¾	16	52.10
C-789A-24	24	1½	1½	7,200	30	16¾	14¾	26-30	15¾	14¾	12.90
C-789B-24	24	2	2	7,200	30	16¾	14¾	26-30	15¾	14¾	13.90
C-789C-24	24	2½	2½	7,200	30	17	14¾	26-30	16¾	14¾	18.07
C-789D-24	24	3	3	7,200	30	17½	15¼	26-30	17¾	15¼	19.35
C-789E-24	24	4	4	7,200	30	18¾	16½	26-30	18	16½	23.10
C-789-24	24	4	4	13,200	30	18¾	16¾	26-30	18¾	16¾	45.40

Standard Finish – GoldGalv®, unless otherwise stated.

## Pipe Straps, Conduit Clamps and Hangers

### C-790 — Insulation Shield

Designed to protect the insulation and distribute the load at the hanger point. This item is usually used with our C-710 Clevis Hanger.

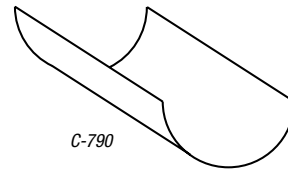

C-790

#### Specifications

- Approvals: Federal Specification A-A-1192A Type 40, MSS-SP-69 Type 40
- Material: Carbon Steel
- Finish: Standard Finish – GoldGalv®, Black (add suffix “-B”), Electro-Galvanized (add suffix “-EG”)
- Ordering: Specify hanger size and catalog number

#### Shield Size Selection Table

PIPE SIZES	½	¾	1	1½	2
<b>Insulation Thickness (Inches)</b>					
½	1A*	1A	—	—	—
¾	1A	1A	2A	4A	6A
1	1A	2A	3A	5A	7A
1¼	2A	3A	4A	6A	7A
1½	2A	3A	4A	6A	7A
2	3A	4A	5A	7A	8A
2½	4A	5A	6A	7A	8A
3	5A	6A	7A	8A	9A
3½	—	—	8A	9A	10A
4	—	—	8A	9A	10A
5	—	—	9B	10B	11B
6	—	—	10B	11B	12B
8	—	—	—	13C	14C
10	—	—	14C	15C	16C
12	—	—	16C	17C	19C
14	—	—	17C	19C	—

CAT. NO.	INSIDE DIAMETER (IN.)	CLEVIS HANGER SIZE (IN.)	LENGTH (IN.)	WT. EACH (LBS.)
C-790-1A	2¾	2	12	.62
C-790-2A	2⅞	2½	12	.76
C-790-3A	3½	3	12	.92
C-790-4A	4	3½	12	1.04
C-790-5A	4½	4	12	1.16
C-790-6A	5	5	12	1.32
C-790-7A	5⅝	5	12	1.46
C-790-8A	6⅝	6	12	1.58
C-790-9A	7⅝	7	12	1.74
C-790-10A	8⅝	8	12	2.02
C-790-11B	9⅝	10	12	2.28
C-790-12B	10¾	10	12	2.54
C-790-13C	11¾	12	12	2.84
C-790-14C	12¾	12	12	4.18
C-790-15C	14	14	12	4.58
C-790-16C	15	16	12	4.90
C-790-17C	16	16	12	5.20
C-790-18C	17	18	12	5.53

Standard Finish – GoldGalv®, unless otherwise stated.

### M-117 — Eye Socket

Designed for attaching a rod to split ring type clamps. M-117 is only available in ¼", ⅜" and ½" rod sizes.

#### Specifications

- Material: Malleable Iron
- Compliance: Federal Specification WW-H-171E Type 16, MSS-SP-69 (Type 16)
- Finish: Plain, Copper
- Ordering: Specify rod size and catalog number

CAT. NO.	ROD SIZE A (IN.)	MAX LOAD (LBS.)	MAX B (IN.)	E (IN.)	WT. EACH (LBS.)
M-117-1/4	¼	240	¼	1⅞	.08
M-117-3/8	⅜	610	¼	1⅞	.08
M-117-1/2	½	1,000	¼	1⅞	.11
M-117-5/8	⅝	1,400	⅜	1¼	.22
M-117-3/4	¾	2,200	½	2¼	.30
M-117-7/8	⅞	2,300	½	2¼	.32

Standard Finish – GoldGalv®, unless otherwise stated.

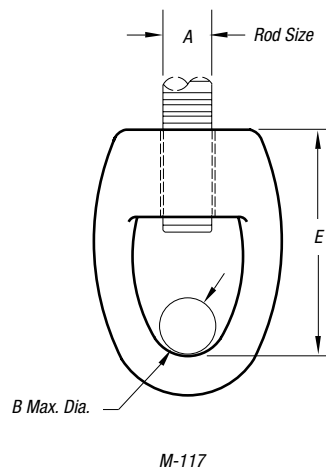

M-117

## Pipe Straps, Conduit Clamps and Hangers

### Rods and Rod Attachments

**Shield Size Selection Table**

CAT. NO.	PIPE SIZES	D	F	1	1D	2
<i>Insulation Thickness (Inches)</i>						
C-790-1/2	1/2	1A*	1A	—	—	—
C-790-3/4	3/4	1A	1A	2A	4A	6A
C-790-1	1	1A	2A	3A	5A	7A
C-790-1-1/4	1 1/4	2A	3A	4A	6A	7A
C-790-1-1/2	1 1/2	2A	3A	4A	6A	7A
C-790-2	2	3A	4A	5A	7A	8A
C-790-2-1/2	2 1/2	4A	5A	6A	7A	8A
C-790-3	3	5A	6A	7A	8A	9A
C-790-3-1/2	3 1/2	—	—	8A	9A	10A
C-790-4	4	—	—	8A	9A	10A
C-790-5	5	—	—	9B	10B	11B
C-790-6	6	—	—	10B	11B	12B
C-790-8	8	—	—	—	13C	14C
C-790-10	10	—	—	14C	15C	16C
C-790-12	12	—	—	16C	17C	18C
C-790-14	14	—	—	17C	18C	—

\*For Unarco foam, specify X1A

**Sizes of CL-710 or C-710 Clevis**

PIPE SIZES	1/2	3/4	1	1 1/2	2
<i>For Use with Shields Outside of Insulation. Insulation Thickness (Inches)</i>					
1/2	2	2	—	—	—
3/4	2	2	2 1/2	3 1/2	5
1	2	2 1/2	3	4	5
1 1/4	2 1/2	3	3	5	5
1 1/2	2 1/2	3	3 1/2	5	5
2	3	3 1/2	4	5	6
2 1/2	3 1/2	4	5	5	6
3	4	5	5	6	8
3 1/2	—	—	6	8	8
4	—	—	6	8	8
5	—	—	8	8	10
6	—	—	8	10	10
8	—	—	—	12	12
10	—	—	12	—	—

### E-151 — Lag Rod

Designed for a vertical rod connection to wood.

**Specifications**

- Material: Carbon Steel
- Finish: Standard Finish – GoldGalv®, Black (add suffix “-B”), Electro-Galvanized (add suffix “-EG”)
- Ordering: Specify rod diameter, rod length, catalog number and finish

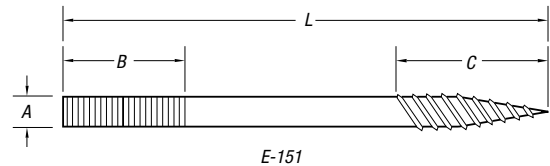

CAT. NO.	ROD SIZE (IN.)	MAX LOAD (LBS.)	MIN. LENGTH (IN.)		WT. EACH (LBS.) LENGTH — DIMENSION L				
			MACHINE B	COACH C	4	6	8	10	12
E-151-3/8	3/8	390	2 1/2	2	.12	.19	.25	.31	.37
E-151-1/2	1/2	640	2 1/2	2	.22	.34	.44	.56	.67
E-151-5/8	5/8	750	2 1/2	2 1/2	.35	.53	.70	.87	.59

Standard Finish – GoldGalv®, unless otherwise stated

## Pipe Straps, Conduit Clamps and Hangers

### E-157 — Machine Thread Eye Rod

Welded Eyeroads are designed to permit swing in the attachment component due to pipe movement.

#### Specifications

- Material: Carbon Steel. Larger rod diameters over 2 1/2", special materials and special eye dimensions can be furnished upon request
- Finish: Standard Finish – GoldGalv®, Black (add suffix "-B"), Electro-Galvanized (add suffix "-EG")
- Ordering: Specify catalog number, finish, rod size, rod length and thread length if other than standard

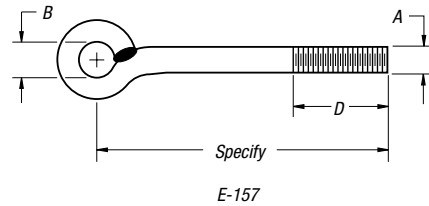

<b>A (IN.)</b>	3/8	1/2	5/8	3/4	7/8	1	1 1/4	1 1/2	1 3/4	2	2 1/4	2 1/2
<b>B (IN.)</b>	3/4	7/8	1	1 1/8	1 1/4	1 3/8	1 5/8	1 7/8	2 1/2	2 3/4	3	3 1/4
<b>Thread Length D (IN.)</b>	3	3	3	3	4	4	4	6	6	6	6	6
<b>Load at (LBS.) 650° F/343° C</b>	610	1,130	1,810	2,710	3,770	4,960	8,000	11,630	15,700	20,700	27,200	33,500
<b>Load at (LBS.) 750° F/399° C</b>	540	1,010	1,610	2,420	3,360	4,420	7,140	10,370	14,000	18,460	24,260	29,880

Standard Finish – GoldGalv®, unless otherwise stated

## Pipe Straps, Conduit Clamps and Hangers

### F-111 — Forged Steel Clevis

Used to connect rod ends with structural steel welding lug plates or lugs welded to pipe. It provides a pivot point and adjustment. It can be supplied with a pin as F-111.

#### Specifications

- Material: Forged Steel
- Finish: Standard Finish – GoldGalv®, Black (add suffix “-B”), Electro-Galvanized (add suffix “-EG”)
- Compliance: Federal Specification A-A-1192A Type 14, MSS-SP 69 Type 14 and BSPSS-BS3974
- Ordering: Specify catalog number, rod size, pin size, grip “G” and finish

CAT. NO.	ROD SIZE	MAX. LOAD 650° F/343° C	PIN/BOLT DIA.	SIZE NO.	P	WT. EACH (LBS.)
F-111-3/8	3/8	610	1/2	2	3/16	.77
F-111-1/2	1/2	1,130	5/8	2	11/16	.77
F-111-5/8	5/8	1,810	3/4	2	13/16	.77
F-111-3/4	3/4	2,710	7/8	2 1/2	1	2.50
F-111-7/8	7/8	3,770	1	2 1/2	1 1/8	2.50
F-111-1	1	4,960	1 1/8	3	1 1/4	4.00
F-111-1-1/4	1 1/4	8,000	1 3/8	3	1 1/2	4.00
F-111-1-1/2	1 1/2	11,630	1 5/8	3 1/2	1 3/4	6.00
F-111-1-3/4	1 3/4	15,700	1 7/8	4	2	8.00
F-111-2	2	20,700	2 1/4	5	2 3/8	16.00
F-111-2-1/4	2 1/4	27,200	2 1/2	6	2 3/8	26.00
F-111-2-1/2	2 1/2	33,500	2 3/4	6	2 3/8	36.00

Standard Finish – GoldGalv®, unless otherwise stated

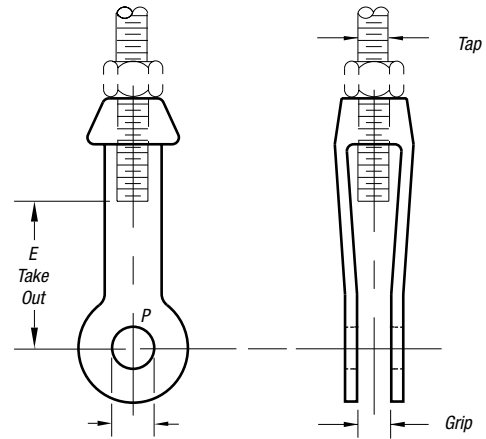

Note: Pins and Cotter Pins supplied when requested as Fig. F-111.

### E-120-A — Forged Weldless Eynut

Used to connect rod ends with structural steel welded beam attachments or pipe clamps as a substitute for a welded eyerod. It provides a pivot point and adjustment. It can also be supplied tapped left hand as E-120-A.

#### Specifications

- Material: Forged Steel
- Finish: Standard Finish – GoldGalv®, Black (add suffix “-B”), Electro-Galvanized (add suffix “-EG”)
- Compliance: Federal Specification A-A-1192A Type 14, MSS-SP 69 Type 14 and BSPSS-BS3974
- Ordering: Specify catalog number, rod size and finish

CAT. NO.	ROD TAP A	MAX. LOAD 650° F/343° C	F	WT. EACH (LBS.)
E-120-A-3/8	3/8	610	1	.20
E-120-A-1/2	1/2	1,130	1	.31
E-120-A-5/8	5/8	1,810	1	.55
E-120-A-3/4	3/4	2,710	1	1.00
E-120-A-7/8	7/8	3,770	1 1/8	1.55
E-120-A-1	1	4,960	1 1/4	2.45
E-120-A-1-1/4	1 1/4	8,000	1 3/4	3.75
E-120-A-1-1/2	1 1/2	11,630	1 3/4	6.75
E-120-A-1-3/4	1 3/4	15,700	3 1/4	16.40
E-120-A-2	2	20,700	3 1/4	16.75
E-120-A-2-1/4	2 1/4	27,200	3 1/4	16.75
E-120-A-2-1/2	2 1/2	33,500	3 1/4	16.75

Standard Finish – GoldGalv®, unless otherwise stated

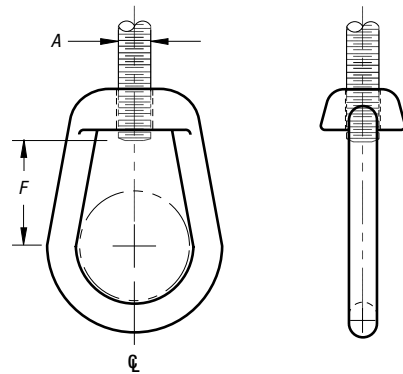

E-120-A

## Surface Raceway and Lighting Systems

### Electrical Raceway

#### Series 800 Surface Raceway and Lighting Systems

Superstrut® channel together with snap-in closure strip is listed by Underwriters Laboratories as a surface metal raceway. Other accessories listed by Underwriters Laboratories are identified on the drawings.

#### Electrical Applications

##### Column A

Suitable for number of wires indicated when used as a raceway. Also suitable for number of wires indicated when installed to support and supply electric discharge type fixtures when raceway wiring is suitable for not less than 75° C.

##### Column B

Suitable for number of wires indicated when used as a raceway. Also suitable for number of wires indicated when installed to support electric discharge type fixtures when clearance of not less than 1/8" is provided between raceway and fixture and when wiring is suitable for 75° C.

GoldGalv® hardware finish is standard for all Superstrut® products. This is a multi-process finish of electro-plated zinc, followed by gold-colored trivalent chromium coating to give excellent corrosion resistance and a superior paint base. See **pages B-106-B-107** for a complete description of the GoldGalv® hardware finish. GoldGalv® hardware finish will be furnished if no other finish is specified.

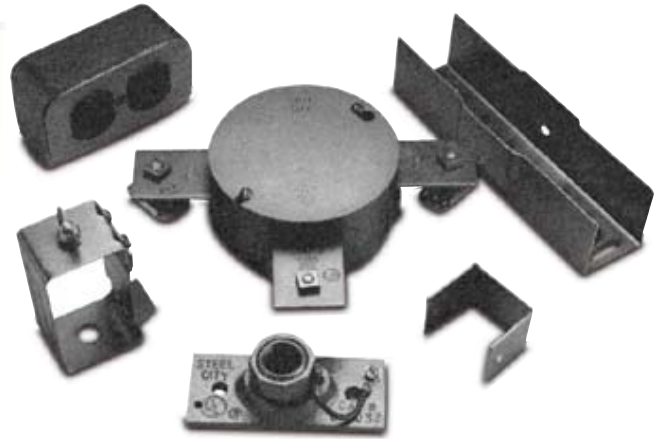

##### Materials:

Superstrut® electrical raceway, fixture hanging channel, closure strip and accessories are cold formed from hot-rolled strip steel.

##### Design Data:

Deflections at various hanger rod spacings for raceway channels, based on 40 to 45 lbs. per fixture.

##### UL LISTED CHANNELS

A-1200	B-1200
A-1200-KO	B1200AL
A-1200 AL	B-1400
A-1200 PG	C-1200
A-1400	E-1200
A-1400-KO	H-1200
A-1400 SS	

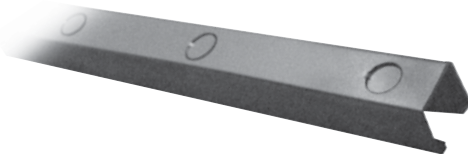

CHANNEL	DEFLECTION AT		
	AT 10 FT.	12 FT.	AT 14 FT.
A-1200	1/4"	1/2"	3/4"
C-1200	3/8"	3/4"	*
A-1400	3/8"	3/4"	*

CHANNEL	DEFLECTION CHANNEL AT		
	6 FT.	7 FT.	9 FT.
B-1200	3/8"	9/16"	3/8"
B-1400	1"	1/2"	*

\*Not recommended for this spacing

##### Maximum Number of Wires

AVG	RACEWAY WITH OR WITHOUT KO							
	A-1200 A-1400		B-1200 B-1400		C-1200		E-1200 H-1200	
	A	B	A	B	A	B	A	B
14	6	10	4	6	5	10	6	10
12	6	10	3	6	4	10	6	10
10	5	8	—	—	4	6	5	8
8	4	6	—	—	3	4	4	6
6	2	3	—	—	2	2	2	3

## Surface Raceway and Lighting Systems

### Electrical Applications (continued)

Metal Framing & Cable Tray — Superstrut® Metal Framing System

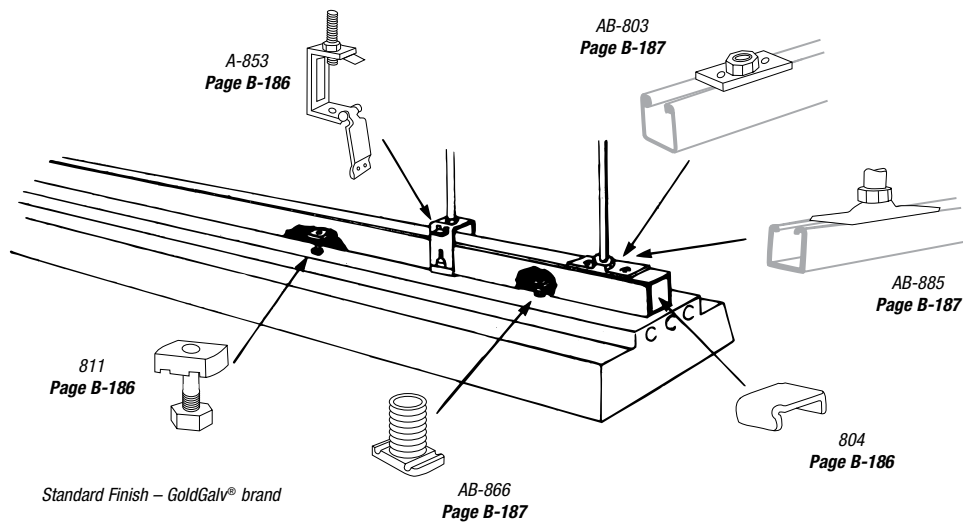
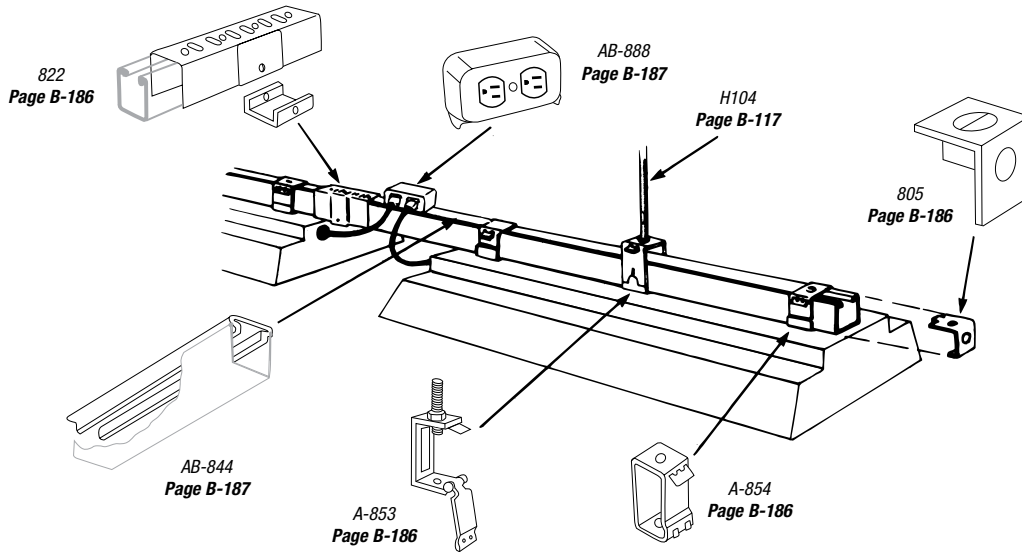



## Surface Raceway and Lighting Systems

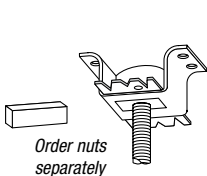
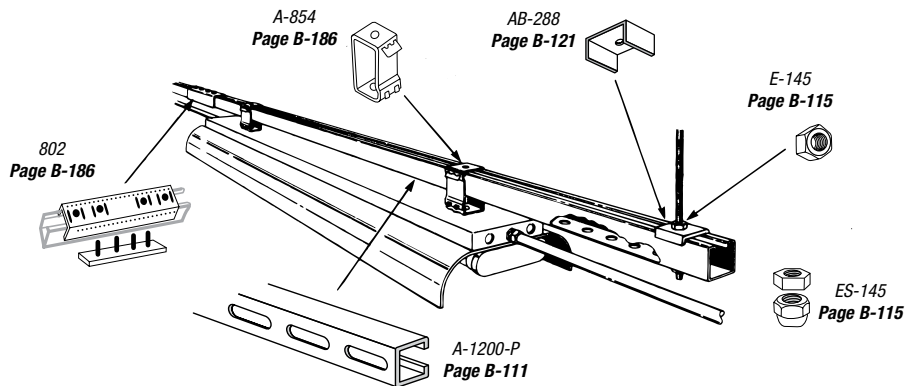
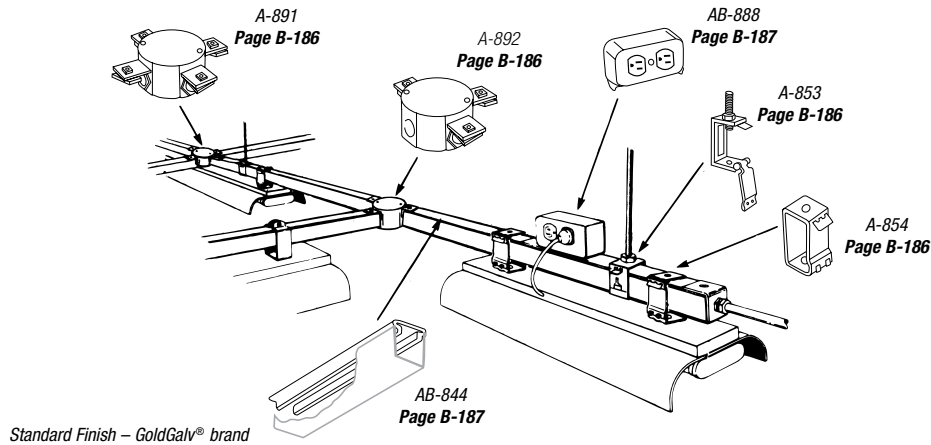

452TB  
Concrete Spot Insert  
Page B-127

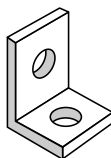

540  
Side Beam  
Hanger Clip  
Page B-130

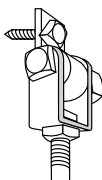

S-541  
Swing Connector  
Page B-131

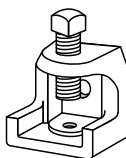

500  
Beam Clamp  
Page B-130

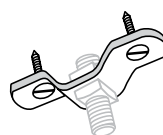

U-579  
Ceiling Flange  
Page B-50

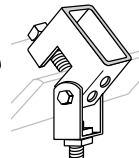

US-563  
Beam Clamp  
Page B-130

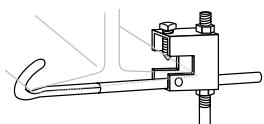

U-569  
Beam Clamp  
with Safety Rod  
Page B-133

## Surface Raceway and Lighting Systems

### Fixture Fittings

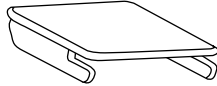

**A-243-1**  
End Cap for A-1200 Channel

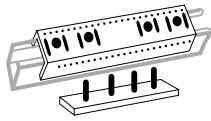
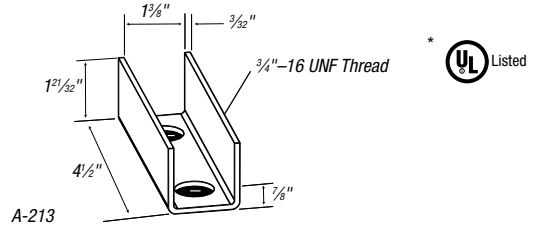

**802**  
Raceway Joiner with Reinforcing Plate  
furnished complete with nuts.

CAT. NO.	FOR CHANNEL	STD. CTN.
A802	A Series	25
B-802	B Series	25
E-802	E Series	10
H-802	H Series	10

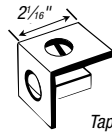

**809**  
Tapped End Cap

12 ga for 3/4" or 1" Conduit.  
Furnished complete with 1/4" x 5/8"  
Flat Head Machine Screw and  
AB-100-1/4 nut.

CAT. NO.	FOR CHANNEL	STD. CTN.
A-809	A Series	25
H-809	H Series	25

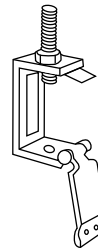

**A853**  
Channel Hanger  
Use hanger rod 3/4" or 1/2".  
Use with "A", "B" or "C" series  
single channel.

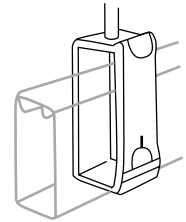

**A853L**  
Channel Hanger  
Long type for all  
series channel.



**804**  
End Cap

CAT. NO.	FOR CHANNEL	STD. CTN.
A804	A-1200	25
	A-1400	25
B804	B-1400	25
C-804	C-1200	25
E-804	E-1200	25
H-804	H-1200	25

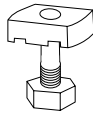

**811**  
Stud Nut

For attaching fixture to Slot Down  
Channel or to Slot up Knockouts.  
Specific length. Hex Nut included.

CAT. NO.	FOR CHANNEL	STD. CTN.
811 1-STR	1/4 x 1	50
811 2-STR	1/4 x 1 1/4	50

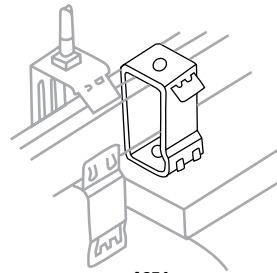

**A854**  
Channel Hanger  
Illustration showing A-854 with nut and bolt  
furnished to attach to fluorescent fixture.  
Use with "A", "B" or "C" series channel.

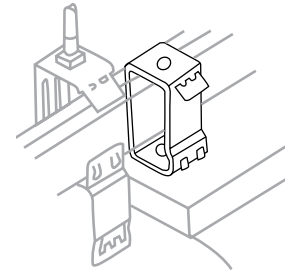

**A854L**  
Channel Hanger  
Long Illustration showing A-854-L  
with nut and bolt furnished to attach  
to fluorescent fixture. Long  
type for all series channel.

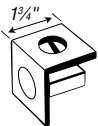

**805**  
End Cap with Knockout

KO for 1/2" conduit. Furnished  
complete with 1/4" x 5/8" flat Head  
Machine Screw and AB-100-1/4 nut.

CAT. NO.	FOR CHANNEL	STD. CTN.
A-805	A Series	25
H-805	H Series	25

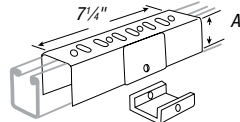

**822**  
Raceway Joiner & Seal

CAT. NO.	A (IN.)	FOR CHANNEL	STD. CTN.
A822*	1 1/16	A Series	25
B-822*	7/8	B Series	25
C-822*	1 1/16	C Series	25

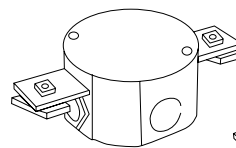

**A889\***

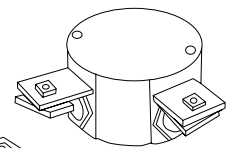

**A890\***

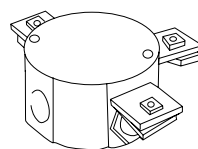

**A892\***

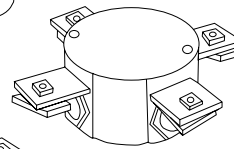

**A891\***

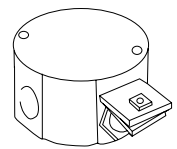

**A893**

## Surface Raceway and Lighting Systems

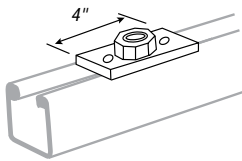

**AB803\***  
Cast Conduit Connector  
To connect 1/2" or 3/4" conduit to raceway channel — Furnished complete with stud nuts & hex nuts. Part has removable bushing to increase size from 1/2" to 3/4".

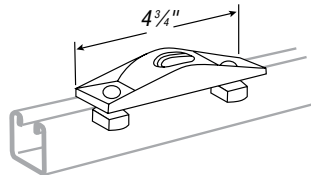

**AB815**  
Swing Connector  
Nuts & bolts to clamp to channel included. For 1/2" or 3/4" conduit.

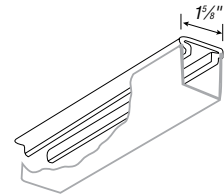

**AB-844\*** Steel Closure Strip  
**AB-844-PC\*** Plastic Closure Strip  
When used as a raceway channel, it is normally installed with the slot up and after wiring is complete, the closure strip is installed. For all channels. Standard lengths 10 ft.

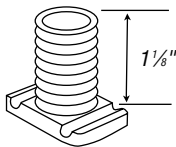

**AB-866**  
1/2" Pipe thread

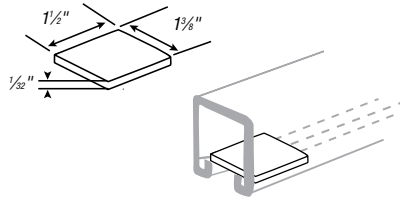

**AB868**  
Fiber Retainer for cables until closure strip is installed.

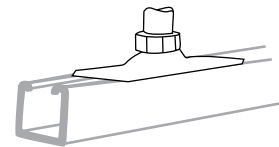

**AB885**  
15° Swivel  
Nuts and bolts to clamp to channel included. For 1/2" or 3/4" conduit.

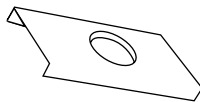

**AB867\***  
Spacer Clevis  
For use with AB-866 wiring stud nuts.

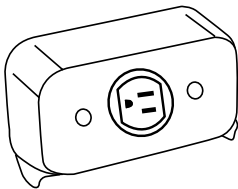

**AB887\***  
Single Outlet  
Complete unit including housing, standard SINGLE 3-wire, 15 Amp, 125 Volt, NEMA ground receptacle and cover plate.

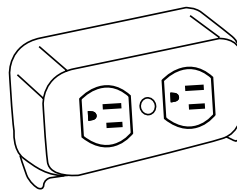
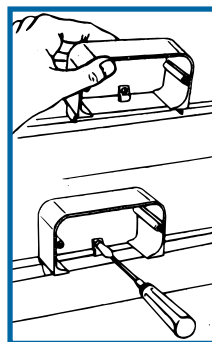

**AB888\***  
Duplex Outlet  
Complete unit including housing, standard DUPLEX 3-wire, 15 Amp, 125 Volt, NEMA ground receptacle and cover plate.

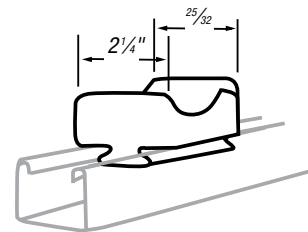

**AB-880 AB-881**  
3" and 4" Porcelain Saddles

CAT. NO.	MAX. CABLE DIAM. (IN.)	STD. CTN.
AB-880	3	3
AB-881	4	4 1/2

## Slotted Angle Metal Framing

With Superangle, You Get Flexibility  
— Simplicity — Economy!

### Superangle Slotted Angle Metal Framing

#### Create the support framing you need.

Superangle is manufactured from structural-quality steel in three different sizes. The small sizes are 14 ga. steel, the larger size is 12 ga. steel. With this offering, an endless variety of metal framing requirements can be met, from lightweight supporting needs to larger shelving needs such as inventory storage.

One of the legs on all sizes is 1 5/8" wide, while the other is either 1 1/8", 2 3/8" or 3 1/8" long. Depending on the frame requirements, a single size can be utilized throughout, or the sizes can be interchanged to get the most efficient usage from the material.

#### Installation time is reduced — inventory space is minimal.

Scribe marks are placed every 3/4", which saves planning, layout and cutting time and provides accuracy. The exclusive slot and hole pattern, repeated every 3", is scientifically designed for ease of assembly. The proper nuts and bolts are included with the material to ensure fast and easy erection.

Superangle Metal Framing is packaged in 10' and 12' lengths to minimize cutoffs and ensure maximum use of material.

10', 12' lengths of Superangle take up the same amount of space as one 2 x 4. A standard package includes five pieces to a bundle, therefore handling and storage space are significantly reduced.

The importance of cutting Superangle easily, quickly and accurately is the key to time-saving assembly. The Portable Cutter provides these advantages and makes layout and erection of any structure a light-work job.

#### Finish is designed for long lasting durability.

The standard GoldGalv® hardware finish is applied to all Superangle products after rolling and punching of the holes. This provides you with a number of benefits. First, raw ends resulting from cuts will be protected by the sacrificial quality of zinc. Second, the edges of all holes are protected against formation of rust, to provide a call-back free installation. Third, the electro-galvanizing process provides an excellent bonding surface for paint if desired for aesthetic reasons.

**Note:** Product is also available with Pre-Galvanized (PG) sections

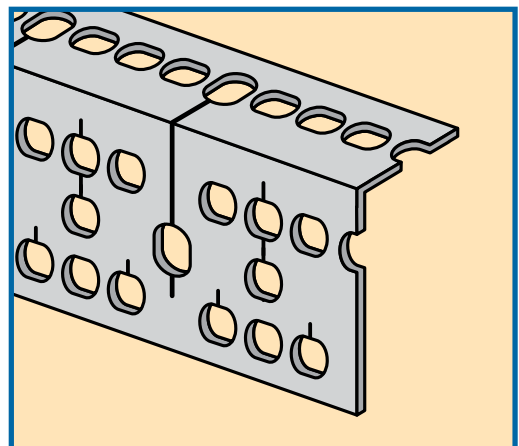
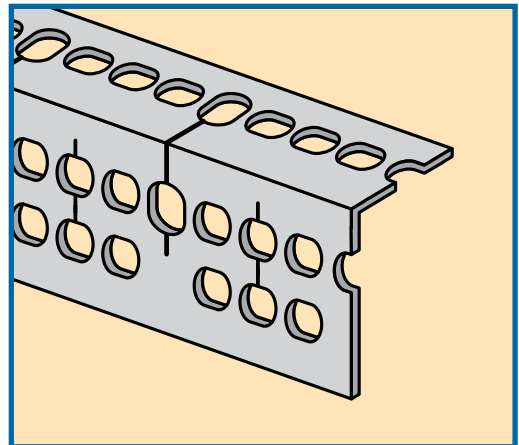
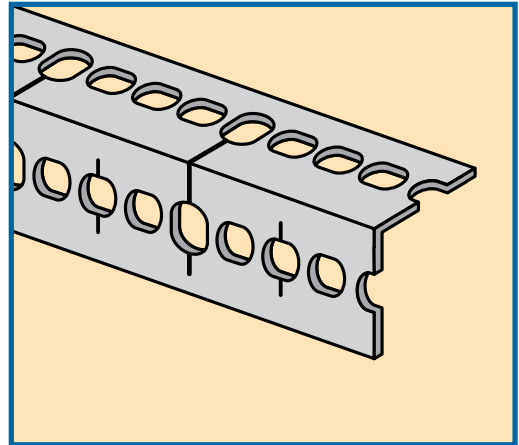

## Slotted Angle Metal Framing

### Superangle Slotted Angle Metal Framing (continued)

CAT. NO.	LENGTH (FT.)	FT. PER PKG.	STD. CTN.
RA-160-10	10	50	1,000
RA-160-12	12	60	1,200
RA-225-10	10	50	1,000
RA-225-12	12	60	1,200
RA 300 10	10	50	1,000
RA-300-12	12	60	1,200

5 Lengths, 36 Nuts and Bolts

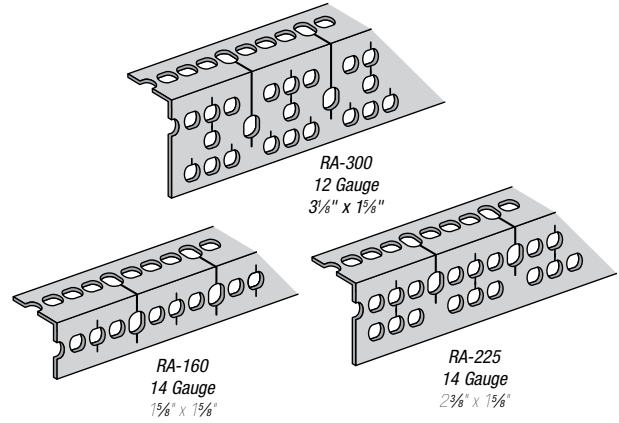

### Superangle Accessories

#### Casters

CAT. NO.	STD. PKG.	STD. CTN.
RA RC	2	2
RA SC	2	2



RA-RC  
Rigid Center



RA-SC  
Swivel Caster

Rigid & Swivel Casters  
Hard rubber composition 3/2" dia.  
with load rating of 225 lbs. per wheel.

#### Portable Cutter

CAT. NO.	STD. PKG.	STD. CTN.
RA C	1	1

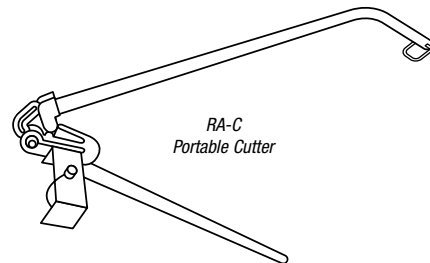

RA-C  
Portable Cutter

#### Gusset Plate

CAT. NO.	STD. PKG.	STD. CTN.
RA GP	25	100

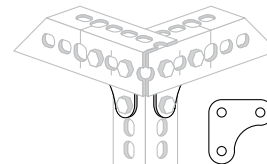

RA-GP  
Gusset Plate  
for extra-rigid  
assembly.

#### Extra Nuts and Bolts

CAT. NO.	PACKAGE 100 SETS	STD. CTN.
RA BN 5/8	5/8"-16 x 3/8" lg.	100
RA BN 3/4	3/4"-16 x 3/4" lg.	100

Use with RA-160 & RA-225  
Use with RA-300

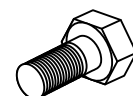
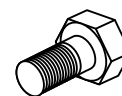

Extra Nuts and Bolts

## Special Metals and Finishes

### Properties for Design — Stainless Steel (Suffix SS/Type 304 and 6SS/Type 316)

Superstrut® stainless steel products are made from high-quality austenitic Type 304 and Type 316 material. Stainless steel contains large amounts of chromium and nickel, is non magnetic and offers superior corrosion resistance. Tolerant to high-temperature environments, Superstrut's stainless steel framing provides dependable support, resulting in reduced maintenance cost. The channel is roll-formed to shape when cold, enhancing its structural strength for the most rigid of applications.

#### Stainless Steel Channel

Elements of sections are the same as shown on **pages B-200–B-210** for standard steel channel. Load ratings meet or exceed ratings for standard steel channel shown elsewhere in this catalog.

*Additional stainless steel and aluminum items are available. Contact your local Superstrut® representative.*



### Properties for Design Aluminum Channel (Suffix AL)

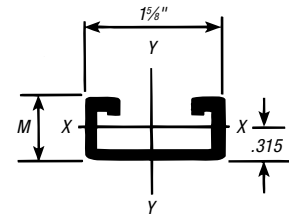
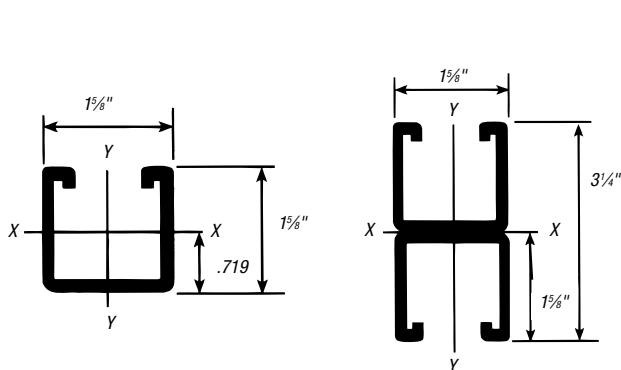

**Span (IN.): 12, 18, 24, 30, 36, 42, 48, 54, 60, 72, 84, 96, 108 & 120.**

12 ga. = .105"

**I** — Moment of Inertia

**S** — Section of Modulus

**r** — Radius of Gyration

**A** — Area

Calculations based on maximum fiber stress of 10,000 psi, maximum 1/360th span deflection. For concentrated loads, multiply load by 0.50.

#### Specifications

- Alloy and Temper: 6063-T6
- Tensile Strength: Yield — 25,000 PSI
- Ultimate — 30,000 PSI
- Shear — Ultimate: 19,000 PSI
- Elongation: (Percent in 2 inches) -12
- Density: .098 Lbs./Cu. Inch
- Modules of Elasticity: 10 x 10<sup>6</sup> PSI

SECTION MEMBER	X - X AXIS				Y - Y AXIS		
	A IN. <sup>2</sup>	I IN. <sup>4</sup>	S IN. <sup>3</sup>	R IN.	I IN. <sup>4</sup>	S IN. <sup>3</sup>	R IN.
A-1200	.563	.198	.224	.594	.274	.338	.698
B-1200	.400	.041	.082	.320	.150	.185	.612
A-1202	1.126	1.001	.620	.942	.548	.676	.698

#### Safe Uniform Total Load Table (X-X AXIS)

SPAN (IN.)	B-1200-AL (LBS.)	A-1200-AL (LBS.)	A-1202-AL (LBS.)
12	540	1,490	4,130
18	270	990	2,760
24	150	730	2,070
30	90	470	1,650
36	60	320	1,370
42	50	240	1,180
48	—	180	930
54	—	140	730
60	—	110	590
72	—	80	410
84	—	60	300
96	—	40	230
108	—	30	180
120	—	20	140

## Special Metals and Finishes

### Aluminum Products (AL Suffix)

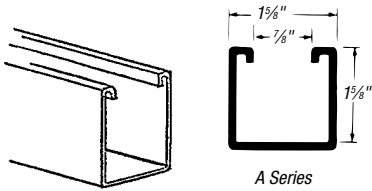

A Series

**A-1200\_AL**  
1 5/8" deep channel and combination

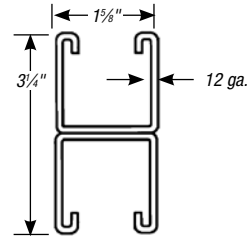

A-1202\_AL

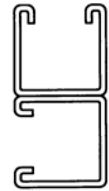

A-1202-C\_AL

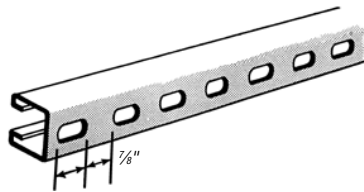

**A-1200-HS\_AL**  
Slots 2" on center.  
Slot size 3/16" x 1 1/8"

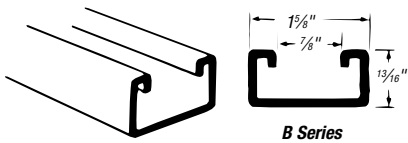

B Series

**B-1200\_AL**

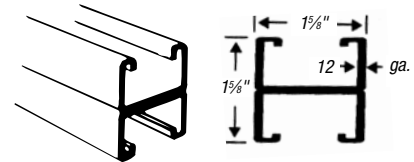

**B-1202\_AL**

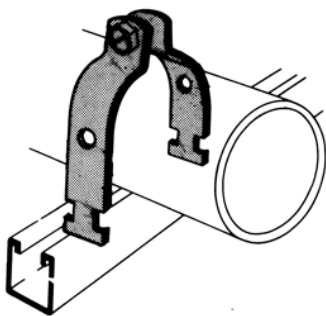

**702\_AL**  
Rigid Conduit Pipe Strap

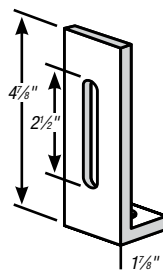

**X201\_AL**

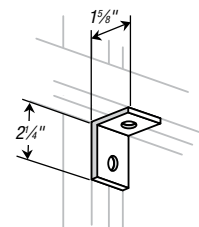

**AB201\_AL**

## Special Metals and Finishes

### Stainless Steel Products

**Available in:**

- Type 304 Stainless Steel — SS Suffix
- Type 316 Stainless Steel — SS6 Suffix

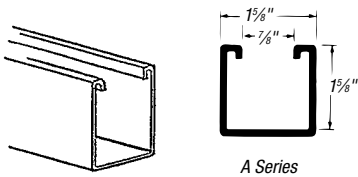

**A-1200\_SS**  
**A-1200\_T316SS**

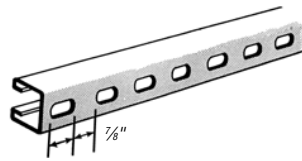

**A-1200-HS\_SS**  
**A-1200\_HS\_T316SS**



**A-1202\_SS**  
**A-1202-T316SS**

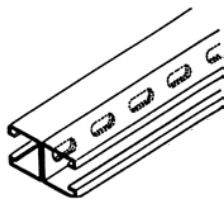

**A-1202-HS\_SS**  
**A-1202-HS\_T316SS**

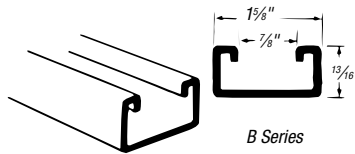

**12 gauge**  
**B-1200\_SS**  
**B-1200\_T316SS**  
**14 gauge**  
**B-1400\_SS**  
**B-1400\_T316SS**

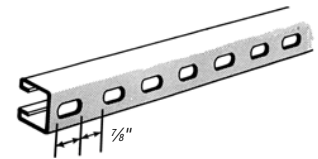

**B-1400-HS\_SS**  
**B-1400-HS\_T316SS**

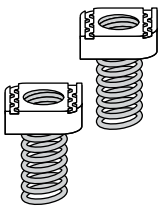

**A-100**  
*Regular Spring Nut*

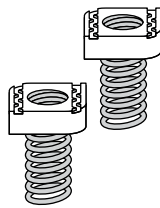

**B-100**  
*Short Spring Nut*

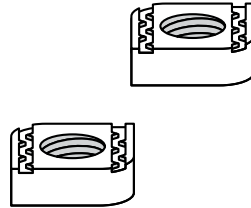

**AB-100**  
*Springless Nut*

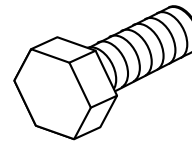

**E-142**  
*Hex Head Cap Screw*

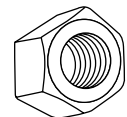

**E-145**  
*Standard Hex Nut*

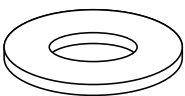

**EF-147**  
*Fender Washer*

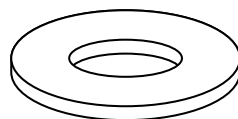

**E-147**  
*Flat Steel Washer*

**AB-241 Square Washer**

CAT. NO.	ROD SIZE (IN.)	STD. CTN.
AB-241-1/4	1/4	100
AB-241-3/8	3/8	100
AB-241-1/2	1/2	100

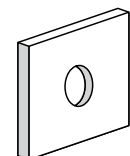



## Special Metals and Finishes

### Stainless Steel Products (continued)

Available in:

- Type 304 Stainless Steel — SS Suffix
- Type 316 Stainless Steel — SS6 Suffix

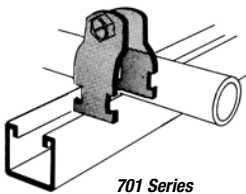
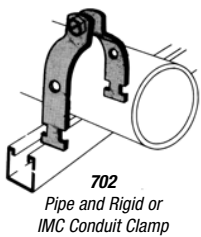
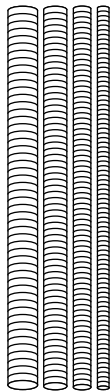
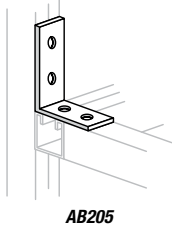
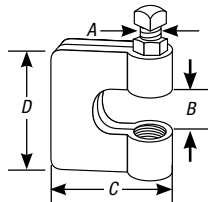
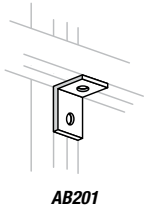
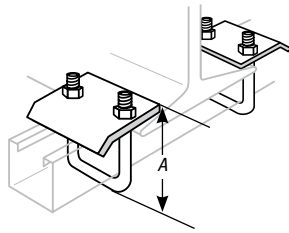
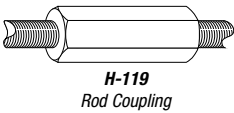

#### U501, U502

CAT. NO.	FOR CHANNEL	A (IN.)	STD. CTN.
U501	A-1200 A-1400	3 <sup>3</sup> / <sub>16</sub>	20
	B-1200 B-1400		
	C-1200 B-1402		
U502	A-1202 A-1402	4 <sup>1</sup> / <sub>16</sub>	20
	C-1202 H-1200		

Furnished complete

Design Load U501 — 2150 lbs.

U502 — 3000 lbs.

#### C-775L — Clamp with Lock Nut

CAT. NO.	ROD SIZE (IN.)	DIMENSIONS (IN.)				DESIGN LOAD (LBS.)	STD. CTN.
		A	B	C	D		
C-775L	3/8	3/8	3/4	2 <sup>3</sup> / <sub>16</sub>	2 <sup>3</sup> / <sub>16</sub>	400	100
	1/2	2 <sup>3</sup> / <sub>16</sub>	2 <sup>1</sup> / <sub>16</sub>	2 <sup>3</sup> / <sub>16</sub>	2 <sup>3</sup> / <sub>16</sub>	500	100

#### H-104

- Hanger rod
- Continuous threaded

##### NATIONAL COARSE THREAD

CAT. NO.	SIZE (IN.)	THREADS PER INCH	DESIGN LOAD (LBS.)	STD. CTN.
H-104-1-1/4	1 <sup>1</sup> / <sub>4</sub>	20	150	500
H-104-3/8	3/8	16	610	500
H-104-1/2	1/2	13	1,130	500
H-104-5/8	5/8	11	1,810	500
H-104-3/4	3/4	10	2,710	500
H-104-7/8	7/8	9	3,770	500
H-104-1	1	8	4,960	500

Standard lengths 12' only

#### Cobra® Clamp

CAT. NO.	FOR EMT AND RIGID CONDUIT TRADE SIZE (IN.)	CABLE O.D. RANGE (IN.)	STATIC LOAD LIMIT (LB) SAFETY FACTOR = 4	STD. CTN.
<b>316 Stainless Steel</b>				
CPC050SS6	1/2	.650-.890	200	100
CPC075SS6	3/4	.860-1.110	200	100
CPC100SS6	1	1.100-1.400	200	100
CPC125SS6	1 1/4	1.400-1.725	200	50
CPC150SS6	1 1/2	1.690-1.980	200	50
CPC200SS6	2	1.980-2.576	200	50
CPC250SS6	2 1/2	2.576-3.060	350	25
CPC300SS6	3	3.060-3.626	350	25
CPC350SS6	3 1/2	3.626-4.126	350	25
CPC400SS6	4	4.126-4.626	350	25

## Special Metals and Finishes

### Type 304 Stainless Steel Products (SS Suffix)

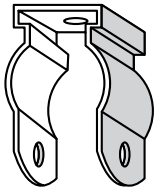

**6H Series**

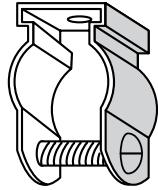

**6H-B Series**  
Conduit and Pipe Hanger

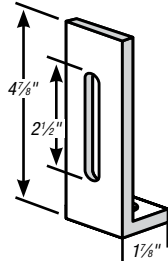

**X201**

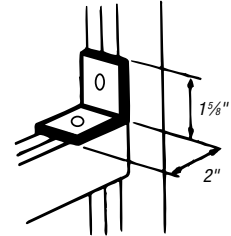

**AB202**

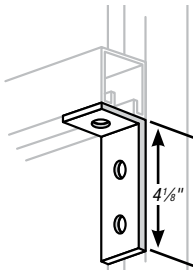

**AB203**

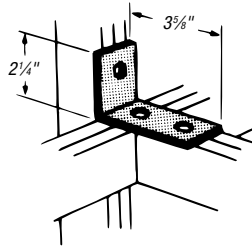

**AB204**

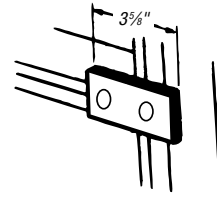

**AB206**

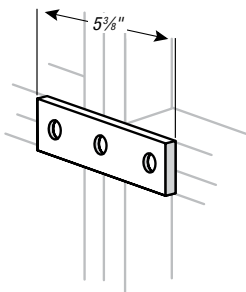

**AB207**

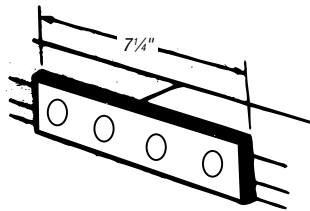

**X207**

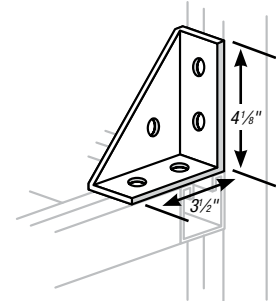

**AB213**

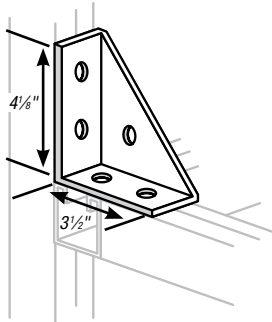

**AB214**

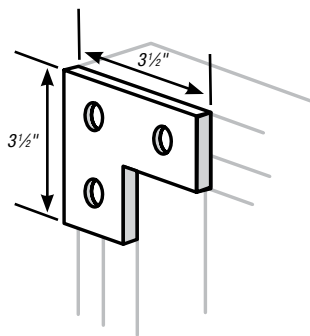

**AB219**

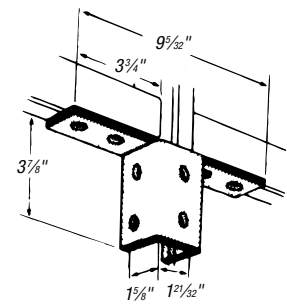

**AW219**

## Special Metals and Finishes

### Type 304 Stainless Steel Products (SS Suffix) (continued)

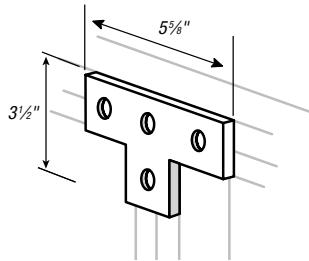

AB220

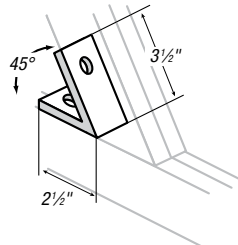

AB225

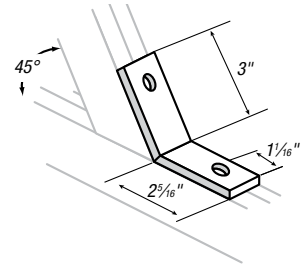

SPAB-227

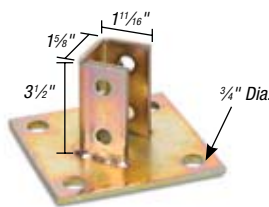

AP-232

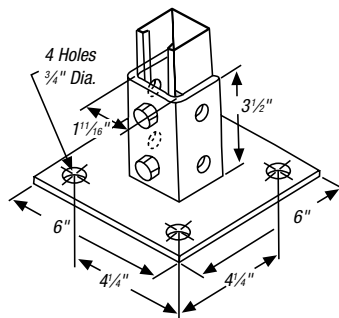

AP-232SQ

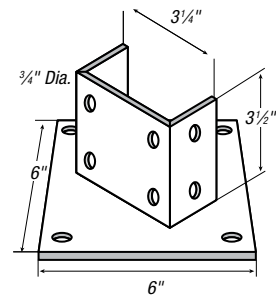

AP-235

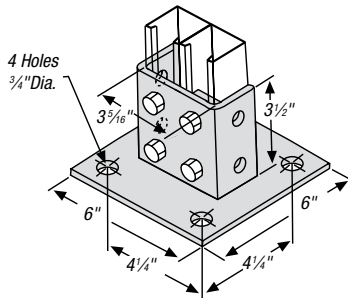

AP-235SQ

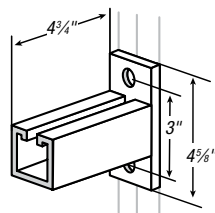

S-250

A is in lengths: 6, 12, 18 & 24.  
May be installed inverted with no change  
in load ratings. Strut section made from  
half slot channel.

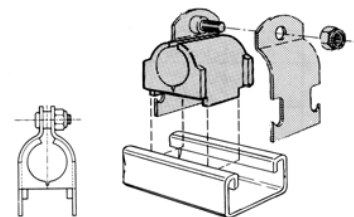

A-716

Cushioned Clamp Tube Series

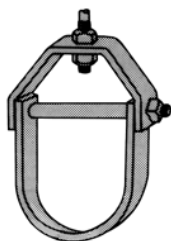

C-710 Series  
Standard Clevis

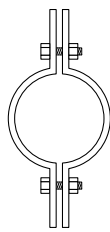

C-720

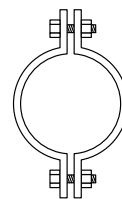

C-725



C-727  
Standard Ring Hanger

## Special Metals and Finishes

### White Painted Products (WH Suffix)

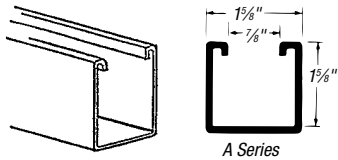

A-1200

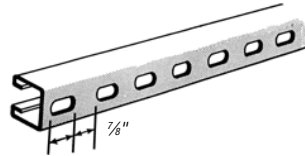

A-1200-HS

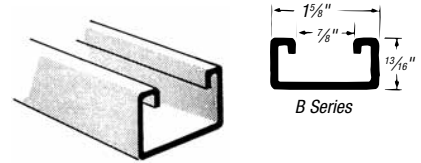

B-1400

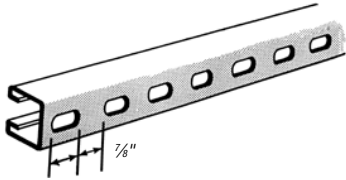

B-1400-HS

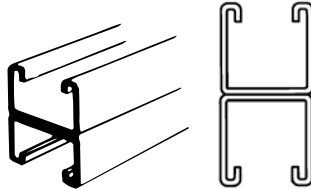

A-1202

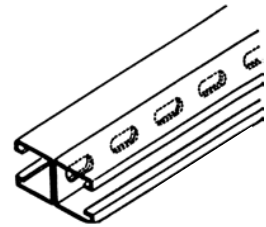

A-1202-HS

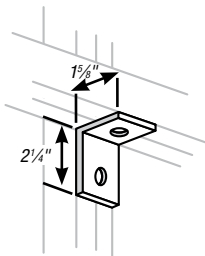

AB201

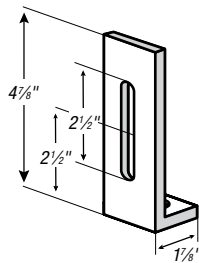

X201

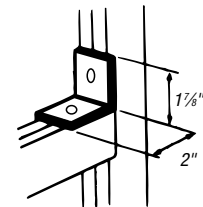

AB219

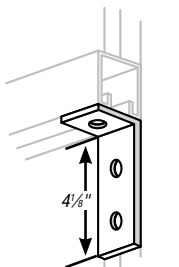

AB203

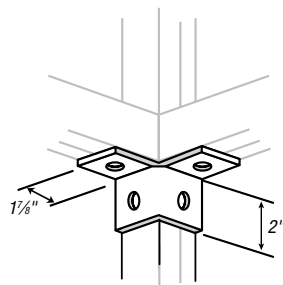

AW204

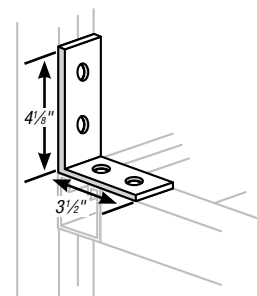

AB205

## Special Metals and Finishes

### White Painted Products (WH Suffix) (continued)

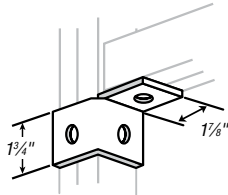

**AW205 L**

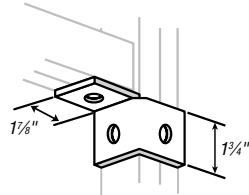

**AW-205-R**

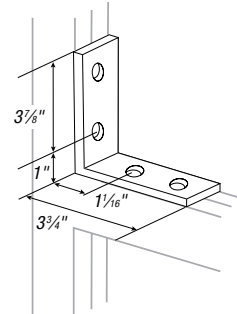

**N-205**

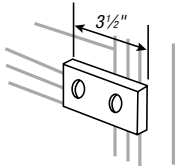

**AB-206**

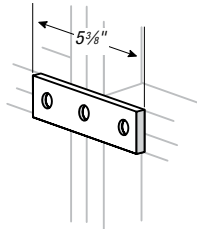

**AB-207**

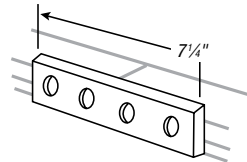

**X-207**

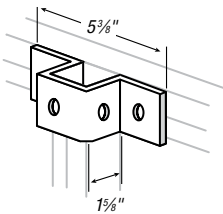

**A210**  
For attaching A Series channel

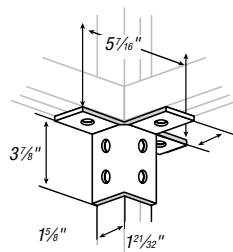

**A218**

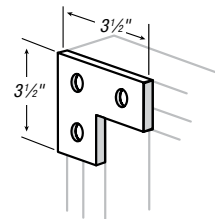

**AB-219**

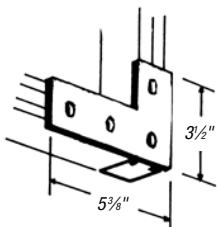

**N-219**

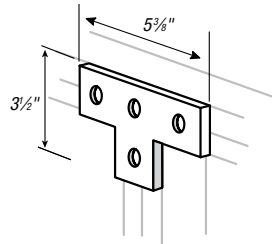

**AB-220**

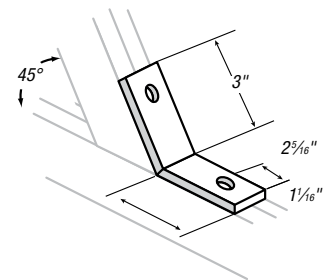

**AB-227-WH**

## Special Metals and Finishes

### White Painted Products (WH Suffix) (continued)



#### AB-241

CAT. NO.	ROD SIZE (IN.)	STD. CTN.
AB-241-1/4	1/4	100
AB-241-3/8	3/8	100
AB-241-1/2	1/2	100

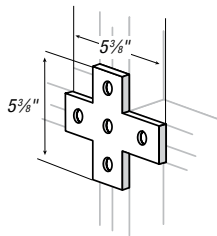

AB253

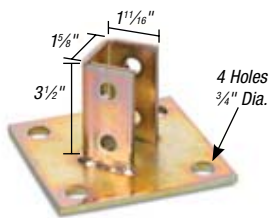

AP-232

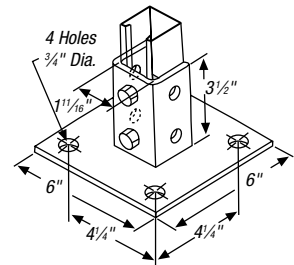

AP-232SQ

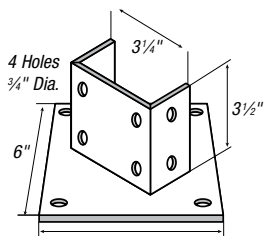

AP-235

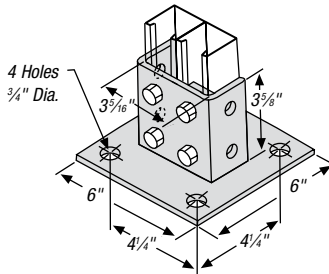

AP-235SQ

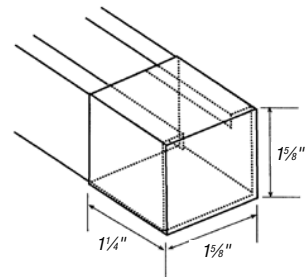

A804 NEOP WH  
1 5/8" x 1 5/8"  
White Plastisol End-Cap

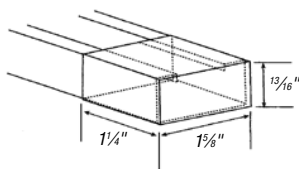

B 804 NEOP WH  
1 5/8" x 1 5/8"  
White End-Cap

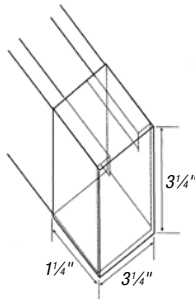

H804 NEOP WH  
1 5/8" x 3/4"  
White Plastisol End-Cap

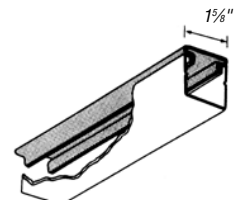

SPAB-844-PC — WHITE  
White Closure Strip  
For all channels

## Technical Information

### Design Data — Metal Framing Channel

Elements of Sections

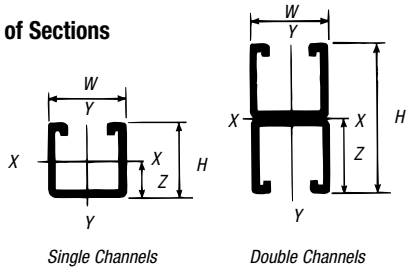

Nominal Thickness (IN.)

12 ga. = .105  
 14 ga. = .075  
 16 ga. = .060

I — Moment of Inertia  
 S — Section of Modulus  
 r — Radius of Gyration  
 Z — Nominal Axis  
 A — Area

Table 1 — Properties for Design: Single Channel

CAT. NO.	H IN.	W IN.	A IN.2	I IN.4	S IN.3	R IN.	X-X AXIS			Y-Y AXIS
							Z IN.	I IN.4	S IN.3	R IN.
A-1200	1.625	1.625	.557	.192	.212	.587	.719	.237	.292	.652
B-1200	.813	1.625	.381	.031	.063	.283	.331	.137	.168	.600
C-1200	1.375	1.625	.500	.121	.155	.492	.595	.205	.252	.640
E-1200	2.438	1.625	.726	.529	.399	.853	1.112	.335	.413	.679
H-1200	3.250	1.625	.897	1.100	.635	1.107	1.507	.436	.536	.697
A-1400	1.625	1.625	.401	.134	.146	.577	.707	.184	.226	.677
B-1400	.813	1.625	.280	.024	.051	.295	.338	.103	.127	.607

Table 1 — Properties for Design: Double Channel

CAT. NO.	H IN.	W IN.	A IN.2	I IN.4	S IN.3	R IN.	X-X AXIS			Y-Y AXIS
							Z IN.	I IN.4	S IN.3	R IN.
A-1202	3.250	1.625	1.114	.948	.583	.992	1.625	.474	.584	.652
B-1202	1.626	1.625	.762	.147	.181	.439	.813	.274	.337	.600
C-1202	2.750	1.625	1.000	.595	.433	.772	1.375	.409	.504	.640
E-1202	4.876	1.625	1.450	2.854	1.171	1.402	2.438	.672	.827	.680
H-1202	6.500	1.625	1.794	6.273	1.930	1.870	3.250	.871	1.072	.697
A-1402	3.250	1.625	.801	.668	.411	.913	1.625	.367	.452	.677
B-1402	1.626	1.625	.560	.112	.138	.447	.813	.206	.254	.607

Table 2 — Load Ratings for ½" Strut Nuts used in Superstrut® Channel

CHANNEL NO.	SLIP RESISTANCE (LBS.)	PULL-OUT STRENGTH (LBS.)
A-1200	1,500	2,000
C-1200	1,500	2,000
B-1200	1,400	1,400
A-1400	1,000	1,400
B-1400	1,000	1,400

Safety Factor of 3

If connections will be subjected to dynamic or seismic loading conditions, contact Thomas & Betts Technical Services for design assistance.

## Technical Information

### Design Data — Metal Framing Channel (continued)

## Design Loads for Channel Used as Beam or Column.

### Table 3

#### Beam Loads

Table 3 contains simple beam, uniformly-distributed loads calculated at 25,000 psi fiber stress. Beam loads are based on channel being loaded across the x-x axis. Loads are also listed at reduced deflections for long spans.

#### Maximum Loads @ 25,000 psi Stress

Maximum allowable deflections and maximum uniform loads for all spans @ 25,000 psi fiber stress.

#### Reduced Load for all 1/180 Span Deflection

For moderate deflections on the longer spans, reduced loads are listed which will produce a deflection equal to 1/180 of the span. When maximum loads do not induce deflections exceeding 1/180 x the span length, reduced loads are not required.

#### Reduced Load for 1/360 Span Deflection

For very slight deflections on the longer spans, reduced loads are listed which will produce a deflection equal to 1/360 of the span. When maximum loads do not induce deflections exceeding 1/360 x the span length, reduced loads are not required.

#### Concentrated Loads

To obtain values for concentrated loads from Table 3, multiply uniform load by .5 and deflection by 1.25.

#### Slotted, Punched or KO Channel

Reduce load rating 5%.

#### Long Span Deep Beams

Support in a manner to prevent rotation at supports and tie between supports to prevent twist.

#### Column Loads

Allowable column loads given are for uniform axial loading with pinned ends. For eccentric loading or other end conditions, reduce allowable loads according to standard engineering practice.

#### Dynamic Loads

Allowable dynamic loads may be calculated by dividing the static loads shown in Table 3, by 2.08.





## Technical Information

**Table 3 — Single Channel**

CAT. NO.	DEPTH (IN.)	GA.	MAXIMUM UNIFORM		1/180 SPAN		1/360 SPAN		COL. LOAD
			LOAD	DEFL.	LOAD	DEFL.	LOAD	DEFL.	
<b>12" Beam or Column</b>									
A-1200	1½	12	3,534	.014	—	.067	—	.033	10,533
B-1200	1¾	12	1,050	.026	—	.067	—	.033	6,683
C-1200	1¾	12	2,584	.016	—	.067	—	.033	9,345
E-1200	2¼	12	6,650	.010	—	.067	—	.033	13,830
H-1200	¾	12	10,583	.008	—	.067	—	.033	17,106
A-1400	1¾	14	2,434	.015	—	.067	—	.033	7,575
B-1400	1¾	14	850	.028	—	.067	—	.033	4,950
<b>18" Beam or Column</b>									
A-1200	1¾	12	2,355	.033	—	.100	—	.050	10,210
B-1200	1¾	12	700	.059	—	.100	—	.050	6,058
C-1200	1¾	12	1,723	.038	—	.100	—	.050	8,970
E-1200	2¼	12	4,434	.023	—	.100	—	.050	13,482
H-1200	¾	12	7,055	.016	—	.100	—	.050	16,693
A-1400	1¾	14	1,623	.031	—	.100	—	.050	7,334
B-1400	1¾	14	566	.063	—	.100	453	.050	4,150
<b>24" Beam or Column</b>									
A-1200	1¾	12	1,766	.058	—	.133	—	.067	9,842
B-1200	1¾	12	525	.105	—	.133	333	.067	5,315
C-1200	1¾	12	1,291	.066	—	.133	—	.067	8,545
E-1200	2¼	12	3,325	.039	—	.133	—	.067	13,082
H-1200	¾	12	5,291	.030	—	.133	—	.067	16,277
A-1400	1¾	14	1,216	.056	—	.133	—	.067	7,058
B-1400	1¾	14	425	.110	—	.133	258	.067	4,000
<b>30" Beam or Column</b>									
A-1200	1¾	12	1,414	.089	—	.167	—	.083	9,419
B-1200	1¾	12	420	.164	—	.167	266	.083	4,465
C-1200	1¾	12	1,034	.104	—	.167	1,040	.083	8,060
E-1200	2¼	12	2,660	.063	—	.167	—	.083	12,640
H-1200	¾	12	4,234	.046	—	.167	—	.083	15,698
A-1400	1¾	14	974	.088	—	.167	—	.083	6,753
B-1400	1¾	14	340	.172	—	.167	165	.083	3,420

When no numbers are shown, use the maximum uniform load.

Deflections are given in inches; loads in lbs.

## Technical Information

### Design Data — Metal Framing Channel (continued)

**Table 3 — Double Channel (Single Channels Welded Back-to-Back)**

CAT. NO.	DEPTH (IN.)	GA.	MAXIMUM UNIFORM		1/180 SPAN		1/360 SPAN		COL. LOAD
			LOAD	DEFL.	LOAD	DEFL.	LOAD	DEFL.	
<b>12" Beam or Column</b>									
A-1202	3/4	12	—	.008	—	.067	—	.033	21,177
B-1202	1½	12	3,016	.016	—	.067	—	.033	14,110
C-1202	2¾	12	—	.010	—	.067	—	.033	18,990
E-1202	4¾	12	—	.005	—	.067	—	.033	27,623
H-1202	6½	12	—	.004	—	.067	—	.033	34,210
A-1402	3/4	14	—	.008	—	.067	—	.033	15,250
B-1402	1½	14	2,300	.016	—	.067	—	.033	10,390
<b>18" Beam or Column</b>									
A-1202	3/4	12	—	.018	—	.100	—	.050	20,609
B-1202	1½	12	2,011	.036	—	.100	—	.050	13,440
C-1202	2¾	12	4,811	.021	—	.100	—	.050	18,470
E-1202	4¾	12	—	.013	—	.100	—	.050	16,926
H-1202	6½	12	—	.009	—	.100	—	.050	33,390
A-1402	3/4	14	—	.018	—	.100	—	.050	14,867
B-1402	1½	14	1,534	.036	—	.100	—	.050	9,910
<b>24" Beam or Column</b>									
A-1202	3/4	12	4,858	.031	—	.133	—	.067	19,974
B-1202	1½	12	1,509	.064	—	.133	—	.067	12,670
C-1202	2¾	12	3,609	.038	—	.133	—	.067	17,890
E-1202	4¾	12	—	.021	—	.133	—	.067	26,143
H-1202	6½	12	—	.016	—	.133	—	.067	32,435
A-1402	3/4	14	3,425	.033	—	.133	—	.067	14,426
B-1402	1½	14	1,150	.064	—	.133	—	.067	9,350
<b>30" Beam or Column</b>									
A-1202	3/4	12	3,886	.049	—	.167	—	.083	19,261
B-1202	1½	12	1,206	.100	—	.167	—	.083	11,803
C-1202	2¾	12	2,886	.059	—	.167	—	.083	17,230
E-1202	4¾	12	7,806	.034	—	.167	—	.083	25,259
H-1202	6½	12	—	.025	—	.167	—	.083	31,395
A-1402	3/4	14	2,740	.050	—	.167	—	.083	13,937
B-1402	1½	14	920	.100	—	.167	—	.083	8,730

When no numbers are shown, use the maximum uniform load.

Deflections are given in inches; loads in lbs.

## Technical Information

**Table 3 — Single Channel**

CAT. NO.	DEPTH (IN.)	GA.	MAXIMUM UNIFORM		1/180 SPAN		1/360 SPAN		COL. LOAD
			LOAD	DEFL.	LOAD	DEFL.	LOAD	DEFL.	
A-1200	1½	12	1,178	.129	—	.200	917	.100	8,962
B-1200	1¾	12	350	.236	—	.200	148	.100	3,498
C-1200	1¾	12	861	.149	—	.200	578	.100	7,525
E-1200	2¼	12	2,216	.088	—	.200	—	.100	12,160
H-1200	3¼	12	3,528	.068	—	.200	—	.100	15,132
A-1400	1¾	14	811	.126	—	.200	640	.100	6,416
B-1400	1¾	14	284	.248	—	.200	115	.100	2,755
<b>42" Beam or Column</b>									
A-1200	1½	12	1,010	.175	—	.233	674	.117	8,466
B-1200	1¾	12	300	.323	217	.233	109	.117	2,579
C-1200	1¾	12	738	.203	—	.233	425	.117	6,945
E-1200	2¼	12	1,900	.120	—	.233	—	.117	11,698
H-1200	3¼	12	3,024	.091	—	.233	—	.117	14,514
A-1400	1¾	14	695	.160	—	.233	470	.117	6,051
B-1400	1¾	14	243	.336	168	.233	84	.117	2,060
<b>48" Beam or Column</b>									
A-1200	1½	12	884	.228	—	.267	516	.133	7,943
B-1200	1¾	12	263	.420	167	.267	83	.133	1,981
C-1200	1¾	12	646	.265	—	.267	325	.133	6,325
E-1200	2¼	12	1,663	.156	—	.267	—	.133	11,092
H-1200	3¼	12	2,646	.120	—	.267	—	.133	13,850
A-1400	1¾	14	609	.120	—	.267	360	.133	5,658
B-1400	1¾	14	213	.440	129	.267	64	.133	1,580
<b>54" Beam or Column</b>									
A-1200	1½	12	785	.289	—	.300	408	.150	7,369
B-1200	1¾	12	234	.533	132	.300	66	.150	1,555
C-1200	1¾	12	574	.335	—	.300	257	.150	5,650
E-1200	2¼	12	1,478	.198	—	.300	1,123	.150	10,505
H-1200	3¼	12	2,351	.151	—	.300	—	.150	13,150
A-1400	1¾	14	541	.286	—	.300	284	.150	5,241
B-1400	1¾	14	189	.556	102	.300	51	.150	1,250

When no numbers are shown, use the maximum uniform load.

Deflections are given in inches; loads in lbs.

## Technical Information

### Design Data — Metal Framing Channel (continued)

Table 3 — Double Channel (Single Channels Welded Back-to-Back)

CAT. NO.	DEPTH (IN.)	GA.	MAXIMUM UNIFORM		1/180 SPAN		1/360 SPAN		COL. LOAD
			LOAD	DEFL.	LOAD	DEFL.	LOAD	DEFL.	
<b>36" Beam or Column</b>									
A-1202	3/4	12	3,239	.071	—	.200	—	.100	18,470
B-1202	1½	12	1,005	.144	—	.200	702	.100	10,840
C-1202	2¼	12	2,400	.085	—	.200	—	.100	16,500
E-1202	4½	12	6,505	.048	—	.200	—	.100	24,316
H-1202	6½	12	—	.036	—	.200	—	.100	30,265
A-1402	3/4	14	2,284	.071	—	.200	—	.100	13,416
B-1402	1½	14	766	.144	—	.200	535	.100	8,050
<b>42" Beam or Column</b>									
A-1202	3/4	12	2,776	.098	—	.233	—	.117	17,635
B-1202	1½	12	863	.195	—	.233	516	.117	9,790
C-1202	2¼	12	2,063	.115	—	.233	—	.117	15,730
E-1202	4½	12	5,576	.065	—	.233	—	.117	23,272
H-1202	6½	12	9,190	.049	—	.233	—	.117	29,025
A-1402	3/4	14	1,958	.225	—	.233	—	.117	12,832
B-1402	1½	14	658	.195	—	.233	393	.117	7,300
<b>48" Beam or Column</b>									
A-1202	3/4	12	2,429	.128	—	.267	—	.133	16,730
B-1202	1½	12	754	.255	—	.267	395	.133	8,640
C-1202	2¼	12	1,804	.151	—	.267	—	.133	14,890
E-1202	4½	12	4,879	.085	—	.267	—	.133	22,170
H-1202	6½	12	8,041	.064	—	.267	—	.133	27,700
A-1402	3/4	14	1,713	.128	—	.267	—	.133	12,223
B-1402	1½	14	575	.255	—	.267	301	.133	6,480
<b>54" Beam or Column</b>									
A-1202	3/4	12	2,159	.161	—	.300	—	.150	15,763
B-1202	1½	12	670	.323	—	.300	312	.150	7,405
C-1202	2¼	12	1,604	.190	—	.300	1,263	.150	13,990
E-1202	4½	12	4,338	.108	—	.300	—	.150	20,980
H-1202	6½	12	7,149	.081	—	.300	—	.150	16,280
A-1402	3/4	14	1,523	.161	—	.300	—	.150	11,566
B-1402	1½	14	511	.323	—	.300	238	.150	5,580

When no numbers are shown, use the maximum uniform load.

Deflections are given in inches; loads in lbs.

## Technical Information

**Table 3 — Single Channel**

CAT. NO.	DEPTH (IN.)	GA.	MAXIMUM UNIFORM		1/180 SPAN		1/360 SPAN		COL. LOAD
			LOAD	DEFL.	LOAD	DEFL.	LOAD	DEFL.	
<b>60" Beam or Column</b>									
A-1200	1½	12	706	.358	—	.333	330	.167	6,762
B-1200	1¾	12	210	.658	107	.333	53	.167	—
C-1200	1¾	12	516	.414	—	.333	208	.167	4,920
E-1200	2¼	12	1,330	.244	—	.333	909	.167	9,874
H-1200	3¼	12	2,116	.186	—	.333	—	.167	12,406
A-1400	1¾	14	486	.353	—	.333	231	.167	4,792
B-1400	1¾	14	170	.687	82	.333	41	.167	—
<b>66" Beam or Column</b>									
A-1200	1¾	12	643	.432	—	.367	273	.183	6,127
B-1200	1¾	12	191	.795	88	.367	44	.183	—
C-1200	1¾	12	470	.501	344	.367	172	.183	4,145
E-1200	2¼	12	1,210	.295	—	.367	753	.183	9,211
H-1200	3¼	12	1,924	.226	—	.367	—	.183	11,616
A-1400	1¾	14	443	.426	—	.367	190	.183	4,311
B-1400	1¾	14	155	.831	68	.367	35	.183	—
<b>72" Beam or Column</b>									
A-1200	1¾	12	589	.514	459	.400	299	.200	5,436
B-1200	1¾	12	175	.946	74	.400	37	.200	—
C-1200	1¾	12	430	.595	289	.400	144	.200	3,485
E-1200	2¼	12	1,108	.351	—	.400	632	.200	8,509
H-1200	3¼	12	1,839	.269	—	.400	1,313	.200	10,782
A-1400	1¾	14	405	.506	320	.400	160	.200	3,809
B-1400	1¾	14	141	.989	57	.400	29	.200	—
<b>84" Beam or Column</b>									
A-1200	1¾	12	505	.700	337	.467	168	.233	4,061
B-1200	1¾	12	—	—	54	.467	27	.233	—
C-1200	1¾	12	369	.811	212	.467	106	.233	2,565
E-1200	2¼	12	950	.479	—	.467	464	.233	6,991
H-1200	3¼	12	1,513	.366	—	.467	965	.233	8,988
A-1400	1¾	14	348	.691	235	.467	118	.233	2,827
B-1400	1¾	14	—	—	42	.467	21	.233	—

When no numbers are shown, use the maximum uniform load.

Deflections are given in inches; loads in lbs.

## Technical Information

### Design Data — Metal Framing Channel (continued)

**Table 3 — Double Channel (Single Channels Welded Back-to-Back)**

CAT. NO.	DEPTH (IN.)	GA.	MAXIMUM UNIFORM		1/180 SPAN		1/360 SPAN		COL. LOAD
			LOAD	DEFL.	LOAD	DEFL.	LOAD	DEFL.	
<b>60" Beam or Column</b>									
A-1202	3/4	12	1,944	.199	—	.333	—	.167	14,738
B-1202	1½	12	604	.398	—	.333	253	.167	6,100
C-1202	2¾	12	1,444	.235	—	.333	1,023	.167	13,050
E-1202	4¾	12	3,904	.133	—	.333	—	.167	19,734
H-1202	6½	12	6,434	.100	—	.333	—	.167	24,810
A-1402	3/4	14	1,370	.199	—	.333	—	.167	10,878
B-1402	1½	14	460	.399	—	.333	193	.167	4,640
<b>66" Beam or Column</b>									
A-1202	3/4	12	1,766	.240	—	.367	1,347	.183	13,646
B-1202	1½	12	549	.481	418	.367	209	.183	5,055
C-1202	2¾	12	1,313	.285	—	.367	846	.183	12,030
E-1202	4¾	12	3,549	.180	—	.367	—	.183	18,415
H-1202	6½	12	5,849	.120	—	.367	—	.183	23,230
A-1402	3/4	14	1,245	.241	—	.367	949	.183	10,133
B-1402	1½	14	419	.483	318	.367	159	.183	3,840
<b>72" Beam or Column</b>									
A-1202	3/4	12	1,620	.286	—	.400	1,132	.200	12,500
B-1202	1½	12	503	.574	351	.400	176	.200	4,230
C-1202	2¾	12	1,203	.339	—	.400	710	.200	10,980
E-1202	4¾	12	3,253	.191	—	.400	—	.200	17,023
H-1202	6½	12	5,361	.143	—	.400	—	.200	21,560
A-1402	3/4	14	1,141	.286	—	.400	798	.200	9,340
B-1402	1½	14	384	.574	267	.400	134	.200	3,220
<b>84" Beam or Column</b>									
A-1202	3/4	12	1,388	.390	—	.467	832	.233	9,992
B-1202	1½	12	431	.780	258	.467	129	.233	3,100
C-1202	2¾	12	1,031	.461	—	.467	522	.233	8,670
E-1202	4¾	12	2,788	.260	—	.467	—	.233	13,993
H-1202	6½	12	4,595	.195	—	.467	—	.233	17,975
A-1402	3/4	14	979	.390	—	.467	586	.233	7,682
B-1402	1½	14	329	.781	197	.467	98	.233	2,370

When no numbers are shown, use the maximum uniform load.

Deflections are given in inches; loads in lbs.

## Technical Information

**Table 3 — Single Channel**

CAT. NO.	DEPTH (IN.)	GA.	MAXIMUM UNIFORM		1/180 SPAN		1/360 SPAN		COL. LOAD
			LOAD	DEFL.	LOAD	DEFL.	LOAD	DEFL.	
<b>96" Beam or Column</b>									
A-1200	1½	12	441	.914	258	.533	129	.267	3,108
B-1200	1¾	12	—	—	42	.533	21	.267	—
C-1200	1¾	12	323	1.059	163	.533	81	.267	1,960
E-1200	2¼	12	831	.730	—	.533	355	.267	5,423
H-1200	3¼	12	1,323	.478	—	.533	739	.267	7,059
A-1400	1¾	14	304	.903	180	.533	90	.267	2,615
B-1400	1¾	14	—	—	32	.533	16	.267	—
<b>108" Beam or Column</b>									
A-1200	1¾	12	393	1.156	204	.600	102	.300	2,456
B-1200	1¾	12	—	—	33	.600	16	.300	—
C-1200	1¾	12	288	1.350	128	.600	64	.300	—
E-1200	2¼	12	739	.790	561	.600	281	.300	4,291
H-1200	3¼	12	1,176	.605	—	.600	584	.300	5,579
A-1400	1¾	14	270	1.141	142	.600	71	.300	1,708
B-1400	1¾	14	—	—	25	.600	13	.300	—
<b>120" Beam or Column</b>									
A-1200	1¾	12	354	1.425	165	.667	83	.333	—
B-1200	1¾	12	—	—	27	.667	13	.333	—
C-1200	1¾	12	259	1.663	104	.667	52	.333	—
E-1200	2¼	12	665	.976	455	.667	227	.333	3,478
H-1200	3¼	12	1,059	.746	—	.667	473	.333	4,521
A-1400	1¾	14	244	1.413	114	.667	57	.333	—
B-1400	1¾	14	—	—	21	.667	10	.333	—
<b>144" Beam or Column</b>									
A-1200	1¾	12	—	—	115	.800	57	.400	—
C-1200	1¾	12	—	—	72	.800	36	.400	—
E-1200	2¼	12	554	1.400	315	.800	158	.400	—
H-1200	3¼	12	883	1.075	657	.800	328	.400	—
A-1400	1¾	14	—	—	80	.800	40	.400	—

When no numbers are shown, use the maximum uniform load.

Deflections are given in inches; loads in lbs.

## Technical Information

### Design Data — Metal Framing Channel (continued)

Table 3 — Double Channel (Single Channels Welded Back-to-Back)

CAT. NO.	DEPTH (IN.)	GA.	MAXIMUM UNIFORM		1/180 SPAN		1/360 SPAN		COL. LOAD
			LOAD	DEFL.	LOAD	DEFL.	LOAD	DEFL.	
<b>96" Beam or Column</b>									
A-1202	3/4	12	1,215	.509	—	.533	637	.267	7,675
B-1202	1%	12	378	1.019	197	.533	99	.267	—
C-1202	2%	12	903	.603	—	.533	400	.267	6,640
E-1202	4%	12	2,440	.340	—	.533	1,917	.267	10,875
H-1202	6 1/2	12	4,021	.255	—	.533	—	.267	14,120
A-1402	3/4	14	856	.509	—	.533	449	.267	5,951
B-1402	1%	14	288	1.020	150	.533	75	.267	—
<b>108" Beam or Column</b>									
A-1202	3/4	12	1,080	.644	—	.600	503	.300	6,071
B-1202	1%	12	355	1.290	156	.600	78	.300	—
C-1202	2%	12	801	.763	632	.600	316	.300	5,250
E-1202	4%	12	2,169	.430	—	.600	1,515	.300	8,599
H-1202	6 1/2	12	3,574	.323	—	.600	—	.300	11,160
A-1402	3/4	14	761	.644	—	.600	355	.300	4,702
B-1402	1%	14	255	1.290	119	.600	59	.300	—
<b>120" Beam or Column</b>									
A-1202	3/4	12	971	.795	—	.667	408	.333	—
B-1202	1%	12	301	1.588	126	.667	63	.333	—
C-1202	2%	12	721	.941	512	.667	256	.333	4,250
E-1202	4%	12	1,951	.531	—	.667	1,227	.333	6,946
H-1202	6 1/2	12	3,216	.398	—	.667	—	.333	9,040
A-1402	3/4	14	685	.796	—	.667	287	.333	3,805
B-1402	1%	14	230	1.600	96	.667	48	.333	—
<b>144" Beam or Column</b>									
A-1202	3/4	12	810	1.145	566	.800	283	.400	—
B-1202	1%	12	—	—	88	.800	44	.400	—
C-1202	2%	12	601	1.350	355	.800	178	.400	—
E-1202	4%	12	1,626	.764	—	.800	852	.400	—
H-1202	6 1/2	12	2,680	.573	—	.800	1,873	.400	—
A-1402	3/4	14	571	1.146	399	.800	199	.400	—
B-1402	1%	14	—	—	67	.800	33	.400	—

When no numbers are shown, use the maximum uniform load.

Deflections are given in inches; loads in lbs.



## Technical Information

**Table 3 — Single Channel**

CAT. NO.	DEPTH (IN.)	GA.	MAXIMUM UNIFORM		1/180 SPAN		1/360 SPAN		COL. LOAD
			LOAD	DEFL.	LOAD	DEFL.	LOAD	DEFL.	
<b>168" Beam or Column</b>									
A-1200	1 $\frac{5}{8}$	12	—	—	84	.933	42	.467	—
C-1200	1 $\frac{5}{8}$	12	—	—	53	.933	27	.467	—
E-1200	2 $\frac{1}{4}$	12	475	1.912	233	.933	116	.467	—
H-1200	3 $\frac{1}{4}$	12	756	1.463	482	.933	241	.467	—
A-1400	1 $\frac{5}{8}$	14	—	—	60	.933	30	.467	—
<b>192" Beam or Column</b>									
E-1200	2 $\frac{1}{4}$	12	—	—	178	1.07	89	.533	—
H-1200	3 $\frac{1}{4}$	12	661	1.910	369	1.07	185	.533	—
<b>216" Beam or Column</b>									
E-1200	2 $\frac{1}{4}$	12	—	—	140	1.20	70	.600	—
H-1200	3 $\frac{1}{4}$	12	—	—	292	1.20	146	.600	—
<b>240" Beam or Column</b>									
E-1200	2 $\frac{1}{4}$	12	—	—	114	.334	57	.667	—
H-1200	3 $\frac{1}{4}$	12	—	—	236	.334	118	.667	—

When no numbers are shown, use the maximum uniform load.

Deflections are given in inches; loads in lbs.

## Technical Information

### Design Data — Metal Framing Channel (continued)

Table 3 — Double Channel (Single Channels Welded Back-to-Back)

CAT. NO.	DEPTH (IN.)	GA.	MAXIMUM UNIFORM		1/180 SPAN		1/360 SPAN		COL. LOAD
			LOAD	DEFL.	LOAD	DEFL.	LOAD	DEFL.	
<b>168" Beam or Column</b>									
A-1202	3/4	12	694	1.563	916	.933	208	.467	—
B-1202	1½	12	—	—	64	.933	32	.467	—
C-1202	2¼	12	515	1.850	261	.933	130	.467	—
E-1202	4½	12	1,394	1.040	1,255	.933	626	.467	—
H-1202	6½	12	2,298	.780	—	.933	1,326	.467	—
A-1402	3/4	14	489	1.563	293	.933	147	.467	—
B-1402	1½	14	—	—	49	.933	25	.467	—
<b>192" Beam or Column</b>									
A-1202	3/4	12	—	—	318	1.07	159	.533	—
—	—	—	—	—	—	—	—	—	—
C-1202	2¼	12	—	—	200	1.07	100	.533	—
E-1202	4½	12	1,220	1.363	958	1.07	479	.533	—
H-1202	6½	12	2,010	1.019	—	1.07	1,053	.533	—
A-1402	3/4	14	—	—	224	1.07	112	.533	—
—	—	—	—	—	—	—	—	—	—
<b>216" Beam or Column</b>									
A-1202	3/4	12	—	—	252	1.20	126	.600	—
—	—	—	—	—	—	—	—	—	—
C-1202	2¼	12	—	—	158	1.20	79	.600	—
E-1202	4½	12	1,084	1.725	757	1.20	379	.600	—
H-1202	6½	12	1,788	1.288	—	1.20	832	.600	—
A-1402	3/4	14	—	—	177	1.20	89	.600	—
—	—	—	—	—	—	—	—	—	—
<b>240" Beam or Column</b>									
A-1202	3/4	12	—	—	204	1.33	102	.667	—
—	—	—	—	—	—	—	—	—	—
C-1202	2¼	12	—	—	128	1.33	64	.667	—
E-1202	4½	12	—	—	613	1.33	307	.667	—
H-1202	6½	12	1,609	1.588	—	1.33	674	.667	—
A-1402	3/4	14	—	—	144	1.33	72	.667	—
—	—	—	—	—	—	—	—	—	—

When no numbers are shown, use the maximum uniform load.

Deflections are given in inches; loads in lbs.

## Technical Information

**Table 4 — Safe Bearing Loads for 1½" Channel and Combinations**

SECTION	RECOMMENDED LOAD IN LBS.	SECTION	RECOMMENDED LOAD IN LBS.	SECTION	RECOMMENDED LOAD IN LBS.
A-1200	5,000	A-1200	3,500	A-1200	8,000
A-1400	3,500	A-1400	2,500	A-1400	5,500
B-1200	6,000	B-1200	4,000	B-1200	9,000
B-1400	3,400	B-1400	2,600	B-1400	4,800
C-1200	5,000	C-1200	3,500	C-1200	8,000
E-1200	5,000	E-1200	3,500	E-1200	8,000
H-1200	4,000	H-1200	2,000	H-1200	5,500

Safety factor of 2½

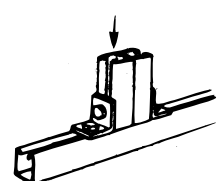
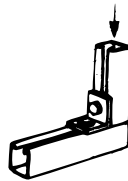
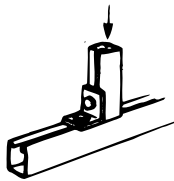

**Table 5 — Design Load Table for Typical Channel Connections**

Safety factor of 2½ based on ultimate strength of the connection. Load diagrams indicate up to three design loads, for 12 gauge, 14 gauge and 16 gauge channel applications.

**90° Fittings (when used in position shown).**

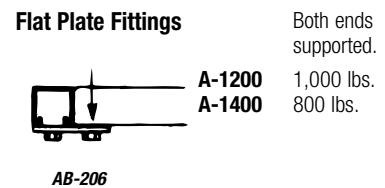
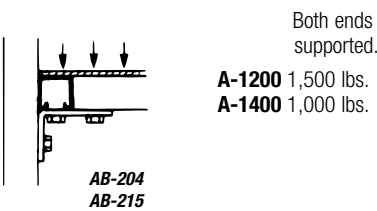
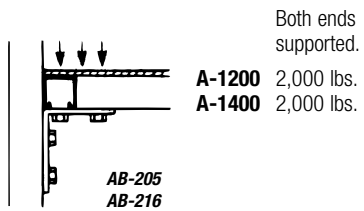
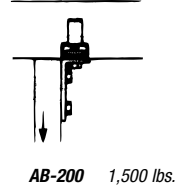
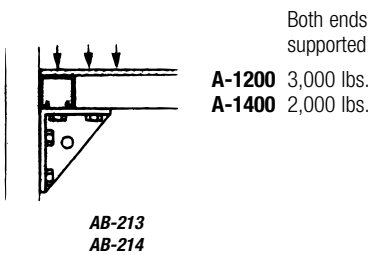
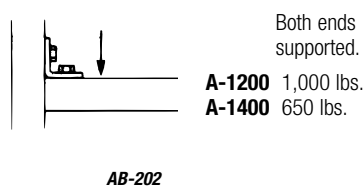
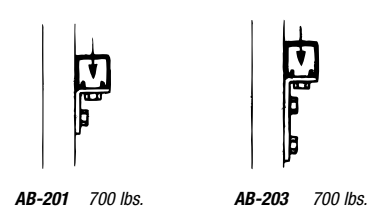
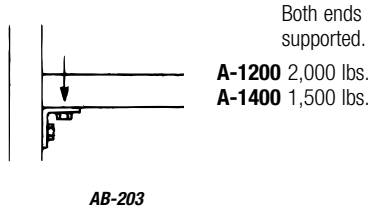
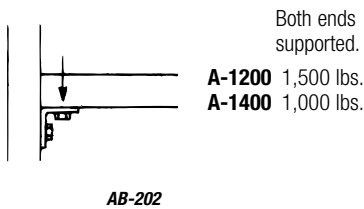

## Technical Information

### Design Applications

#### Cantilever Beams

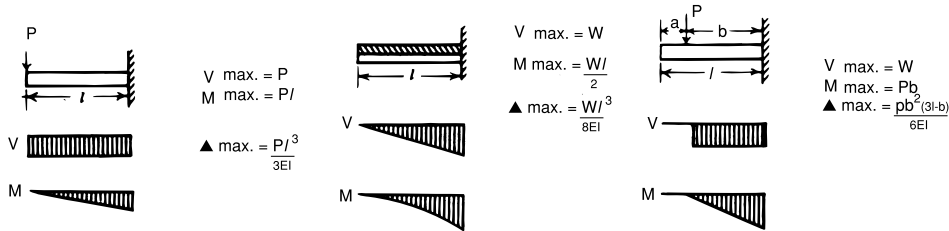

#### Simple Beams

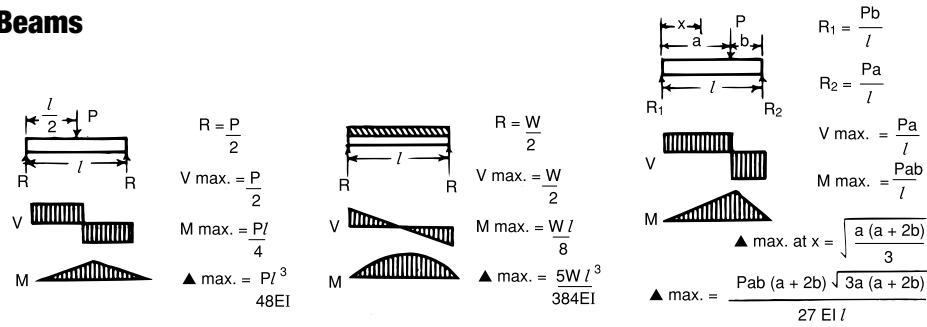

#### Beams Fixed on One End, Supported at Other

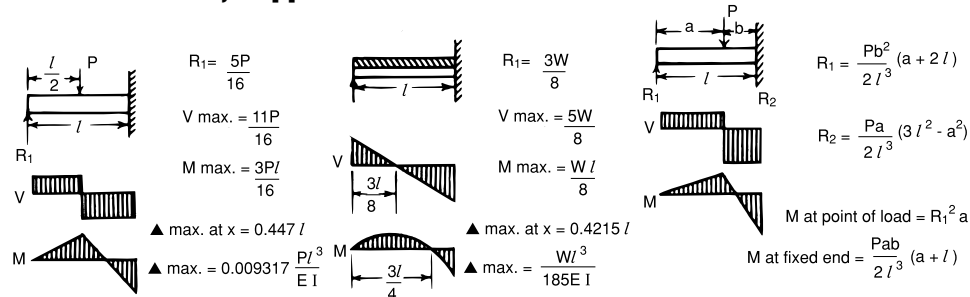



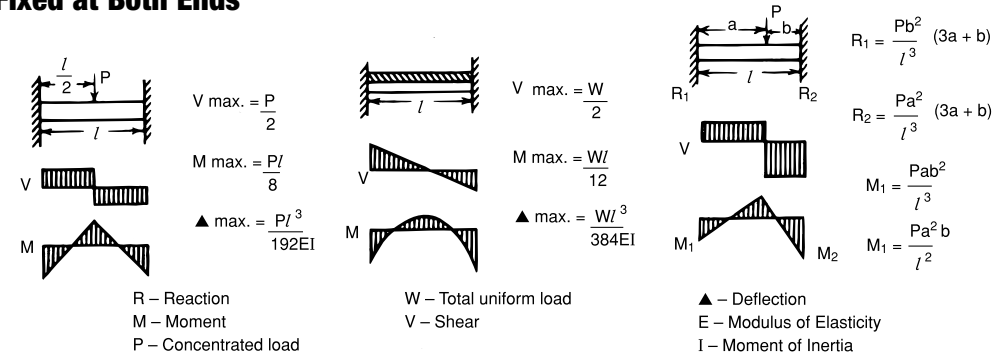



#### Beams Fixed at Both Ends

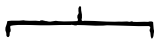

## Technical Information

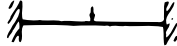
Load tables on **pages B-200–B-210** for A, B, C, E and H series channel are for single span beams supported at the ends. These can be used in the majority of cases. There are times when it is necessary to know what happens with other loading and support conditions. Some common arrangements are shown in Table 6. Simply multiply the loads from the Design Load Tables times the factors given in Table 6. Examples shown on **page B-214**.

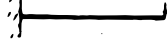
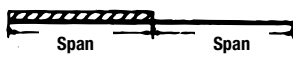
**Table 6 — Conversion Factors for Beams with Various Static Loading Conditions**

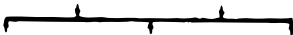
LOAD AND SUPPORT CONDITION			LOAD FACTOR	DEFLECTION FACTOR
1.	Simple Beam — Uniform Load		1.00	1.00
2.	Simple Beam — Concentrated Load at Center		.50	1.25
3.	Simple Beam — Two Equal Concentrated Loads at ¼ Points		1.00	1.10
4.	Beam Fixed at Both Ends — Uniform Load		1.50	.30
5.	Beam Fixed at Both Ends — Concentrated Load at Center		1.00	.40
6.	Cantilever Beam — Uniform Load		.25	2.40
7.	Cantilever Beam — Concentrated Load at End		.12	3.20
8.	Continuous Beam — Two Equal Spans — Uniform Load on One Span		1.30	.92
9.	Continuous Beam — Two Equal Spans		1.00	.42
10.	Continuous Beam — Two Equal Spans — Concentrated Load at Center of One Span		.62	.71
11.	Continuous Beam — Two Equal Spans — Concentrated Load at Center of Both Spans		.67	.48

## Technical Information

### Design Applications (continued)



#### Example I

**Problem:**

Determine the load and deflection of an A-1200 beam continuous over one support and loaded uniformly on one span.

**Solution:**

- A. From load table 3 for A-1200 the load for a 5'0" span is 706 lbs. and deflection is .358".
- B. Multiply by factors from Table 6.  
 $Load = 706 \text{ lbs.} \times 1.30 = 917.8 \text{ lbs.}$   
 $Deflection = .358 \times .92 = .329"$

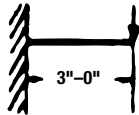

#### Example II

**Problem:**

Determine load and deflection of an E-1200 cantilever beam with a concentrated load on the end.

**Solution:**

- A. From load table 3 for E-1200 the load for a 3'0" span is 2216 lbs. and deflection is .088".
- B. Multiply by factors from Table 6.  
 $Load = 2216 \text{ lbs.} \times .12 = 265.9 \text{ lbs.}$   
 $Deflection = .088 \times 3.20 = .282"$

Illustration 1

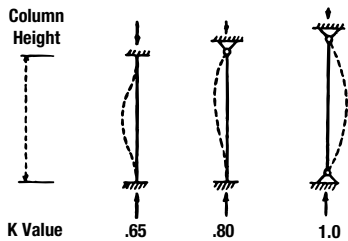

### Column Loading

The load bearing capacity of column or compression members is a function of the inherent configurational strength, the unbraced length and design of the end connections.

Values of axial column loading given in Table 3 were calculated using a rotationally free and translation fixed correction at each end (see illustration I). This gives an end condition constant (K) of 1.

If other end conditions are used, axial loading should be calculated using procedures in the AISI specification for the design of cold formed steel structural members (SG671) and the engineering values for Superstrut channel given in Table 1.

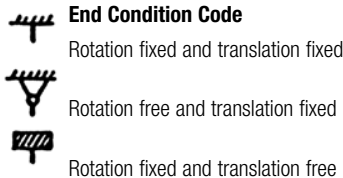

## Technical Information

**Table 7 — Load Carrying Capacities of Hot-Rolled Steel Rod**

DIMENSIONS (IN.) — LOADS	
NOMINAL ROD DIA.	ROOT AREA THREAD
1/8	.068
1/4	.126
5/8	.202
3/4	.302
7/8	.419

Safety factor of 5.

**Table 8 — Rod Size Determined by Pipe Size for Fire Protection**

DIMENSIONS (IN.) — LOADS	
NOMINAL ROD DIA.	ROOT AREA THREAD
3/4 to 2	1/8
2 1/2 to 3 1/2	1/2
4 to 5	5/8
6	3/4
8 to 12	7/8

Safety factor of 5.

**Table 9 — Maximum Spacing between Pipe Supports**

<b>Steel Pipe</b>																			
Nom. Pipe Size (IN.)	1/2	3/4	1	1 1/2	2	2 1/2	3	3 1/2	4	5	6	8	10	12	14	16	18	20	24
Max. Spacing (FT.)	5	6	7	9	10	11	12	13	14	16	17	19	22	23	25	27	28	30	32
<b>Copper Size</b>																			
Nom. Pipe Size (IN.)	1/2	3/4	1	1 1/4	1 1/2	2	2 1/2	3	3 1/2	4									
Max. Spacing (FT.)	5	6	6	7	8	9	10	10	11	12									

**Table 10 — Minimum Spacing (IN.) between Centers of Standard Pipe When Using Superstrut #702 Pipe Straps**

NOM. PIPE SIZE	1/2	3/4	1	1 1/4	1 1/2	2	2 1/2	3	3 1/2	4	5	6	8
1/2	1 1/16	—	—	—	—	—	—	—	—	—	—	—	—
3/4	1 1/16	1 1/16	—	—	—	—	—	—	—	—	—	—	—
1	1 1/2	1 5/8	1 3/4	—	—	—	—	—	—	—	—	—	—
1 1/4	1 3/4	1 7/8	2	2 1/4	—	—	—	—	—	—	—	—	—
1 1/2	1 15/16	2 1/16	2 3/16	2 7/16	2 9/16	—	—	—	—	—	—	—	—
2	2 2/16	2 3/16	2 1/2	2 3/4	2 7/8	3 1/8	—	—	—	—	—	—	—
2 1/2	2 7/16	2 5/8	2 3/4	3	3 1/8	3 1/8	3 5/8	—	—	—	—	—	—
3	2 13/16	2 15/16	3 1/16	3 3/16	3 7/16	3 3/4	4	4 5/16	—	—	—	—	—
3 1/2	3 1/8	3 3/4	3 3/8	3 5/8	3 3/4	4 1/16	4 5/16	4 5/8	4 15/16	—	—	—	—
4	3 7/16	3 3/8	3 13/16	4 1/16	4 1/8	4 3/8	4 7/16	5 1/4	5 5/16	—	—	—	—
6	4 3/4	4 7/8	5	5 1/4	5 1/2	5 5/8	5 7/8	6 3/16	6 1/2	6 3/16	7 7/16	8 1/8	—
8	5 7/16	6	6 1/8	6 1/8	6 1/2	6 3/4	7	7 7/16	7 7/8	8	8 9/16	9 1/4	10 1/8

## Technical Information

### Design Applications (continued)

**Table 11 — Standard Dimensions and Weights of Piping Materials and Conduit**

MECHANICAL (SCHEDULE 40)		
NOMINAL STD. PIPE SIZE (IN.)	PIPE O.D. (IN.)	COUPLING O.D. (IN.)
½	.84	1.06
¾	1.05	1.31
1	1.32	1.58
1¼	1.66	1.90
1½	1.90	2.20
2	2.38	2.75
2½	2.88	3.25
3	3.50	4.00
3½	4.00	4.63
4	4.50	5.00
5	5.56	6.30
6	6.63	7.39
8	8.63	9.23
10	10.75	—
12	12.75	—
14	14.00	—
16	16.00	—
18	18.00	—
20	20.00	—
22	22.00	—
24	24.00	—
26	26.00	—
28	28.00	—
30	30.00	—

NOMINAL CONDUIT SIZE (IN.)	ELECTRICAL CONDUIT	
	RIGID STEEL CONDUIT O.D. (IN.)	THIN WALL (EMT) CONDUIT O.D. (IN.)
½	.84	.71
¾	1.05	.92
1	1.32	1.16
1¼	1.66	1.51
2	2.38	2.20
2½	2.88	2.88
3	3.50	3.50
4	4.50	4.50

\* Includes weight of heaviest conductor combination



## Technical Information

**Table 12 — Extra Strong Pipe (Schedule 80)**

A.S.A. B36.10 SCHEDULE NOS. AND NOMINAL WALL THICKNESS DESIGNATIONS	NOMINAL PIPE SIZE (IN.)	OUTSIDE DIAMETER (IN.)	WALL THICKNESS (IN.)	INSIDE DIAMETER (IN.)
EXTRA STRONG PIPE AND SCHEDULE 80 PIPE (THROUGH 8")	¾	.675	.126	.423
	½	.840	.147	.546
	¾	1.050	.154	.742
	1	1.315	.179	.957
	1¼	1.660	.191	1.278
	1½	1.900	.200	1.500
	2	2.375	.218	1.939
	2½	2.875	.276	2.323
	3	3.500	.300	2.900
	3½	4.000	.318	3.364
	4	4.500	.337	3.826
	5	5.563	.375	4.813
	6	6.625	.432	5.761
8	8.625	.500	7.625	
10	10.750	.500	9.750	
EXTRA STRONG PIPE (10" THROUGH 24" OD)	12	12.750	.500	11.750
	14 OD	14.000	.500	13.000
	16 OD	16.000	.500	15.000
	18 OD	18.000	.500	17.000
	20 OD	20.000	.500	19.000
	24 OD	24.000	.500	23.000
	10	10.750	.593	9.564
SCHEDULE 80 PIPE (10" THROUGH 24" OD)	12	12.750	.687	11.376
	14 OD	14.000	.750	12.500
	16 OD	16.000	.842	14.314
	18 OD	18.000	.937	16.126
	20 OD	20.000	1.031	17.938
24 OD	24.000	1.218	21.564	

**Table 13 — Pipe Covering Weights Thickness (Intended as Guide Only) and Weight of Calcium Silicate Covering**

NOMINAL PIPE SIZE	260° THICK. (IN.)	360° THICK. (IN.)	440° THICK. (IN.)	525° THICK. (IN.)	600° THICK. (IN.)	700° THICK. (IN.)	800° THICK. (IN.)
1	1	1	1	1	1½	1½	1½
1¼	1	1	1	1	1½	1½	2
1½	1	1	1	1	1½	1½	2
2	1	1	1	1½	1½	2	2
2½	1	1	1	1½	1½	2	2½
3	1	1	1	1½	1½	2	2½
3½	1	1	1½	1½	2	2	2½
4	1	1	1½	1½	2	2	2½
5	1	1	1½	1½	2	2	2½
6	1½	1½	1½	1½	2	2	2½
8	1½	1½	1½	1½	2	2	2½

## Technical Information

### Design Applications (continued)

Column height,  
equal shelf spacing

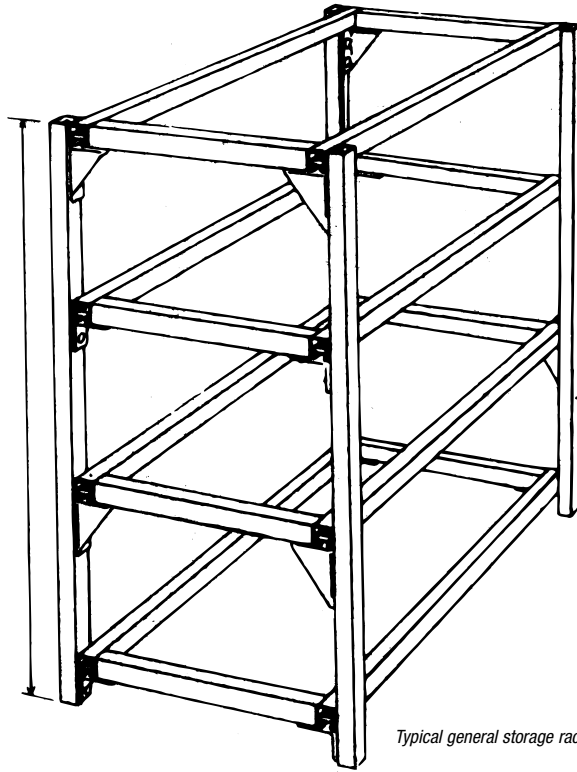

Typical general storage rack for use with plywood or other decking

- General Storage Racks
- Pallet Racks
- Barrel Racks
- Bulk Furniture Racks
- Cable Racks
- Bar Stock Racks
- Display Racks
- Special Purpose Racks
- For Uniform Loads on Horizontal Members, See Table 3 (pages B-200–B-210)

Table 14 — Column Loading for Rack Construction

COLUMN HEIGHT	CAT. NO.	ALLOWABLE LOAD IN LBS. PER UPRIGHT								
		NUMBER OF SHELVES PER UPRIGHT								
		2	3	4	5	6	7	8	9	10
6'	A-1200	2,237	1,925	1,650	1,437	1,290	—	—	—	—
	A-1202	4,170	3,580	3,100	2,730	2,450	—	—	—	—
	B-1400	800	820	790	700	630	—	—	—	—
	B-1402	1,930	1,700	1,500	1,300	1,190	—	—	—	—
7'	A-1200	2,150	1,850	1,630	1,425	1,280	1,150	—	—	—
	A-1202	4,000	3,525	3,000	2,700	2,430	2,200	—	—	—
	B-1400	650	790	760	685	615	550	—	—	—
	B-1402	1,800	1,650	1,450	1,300	1,180	750	—	—	—
8'	A-1200	2,000	1,820	1,600	1,400	1,250	1,150	1,050	—	—
	A-1202	3,900	3,475	3,000	2,700	2,400	2,185	2,000	—	—
	B-1400	580	750	730	660	610	540	510	—	—
	B-1402	1,650	1,610	1,450	1,300	1,160	940	970	—	—
9'	A-1200	1,950	1,780	1,575	1,400	1,250	1,130	1,030	950	—
	A-1202	3,800	3,400	3,020	2,675	2,400	2,180	1,975	1,800	—
	B-1400	—	600	665	600	580	540	500	475	—
	B-1402	1,500	1,500	1,430	1,275	1,160	1,000	900	800	—
10'	A-1200	1,870	1,700	1,500	1,300	1,200	1,100	1,000	900	800
	A-1202	3,600	3,300	3,000	2,650	2,350	2,000	1,975	1,800	1,650
	B-1400	—	550	650	625	580	535	490	450	425
	B-1402	1,450	1,480	1,400	1,250	1,140	1,040	960	885	825

## Technical Information

### Federal Specifications (WW-H-171)/ Manufacturers Society Specifications (MSS SP69)



**C-710**  
Adj. Steel Clevis  
Sizes 3/4" through 20" IPS  
**Federal Type 1**  
**SP69 Type 1**



**C-726**  
Steel Double Bolt Pipe Clamp  
Sizes 1 1/2" through 24" IPS  
**Federal Type 3**  
**SP69 Type 3**



**C-725**  
Steel Pipe Clamp  
Sizes 1 1/2" through 24" IPS  
**Federal Type 4**  
**SP69 Type 4**



**CF-710**  
Adj. Steel Band Hanger  
Sizes 1/2" through 8"  
IPS 3/4" through 4" tube  
**Federal Type 7**

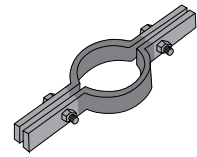

**C-720/CT-720**  
Extension Pipe or Riser Clamp  
Sizes 3/4" through 20"  
IPS 1/2" through 6" tube  
**Federal Type 8**  
**SP69 Type 8**



**C-727/CT-727**  
Adj. Swivel Ring Hanger  
Sizes 1/2" through 8" IPS  
1/2" through 4" tube  
**Federal Type 10**  
**SP69 Type 10**

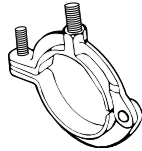

**M-718/MT-718**  
MI Split Pipe Ring  
w/wo turnbuckle adj.  
Sizes 1/2" through 8" IPS  
1/2" through 4" tube  
**Federal Type 11**  
**SP69 Type 12**



**CL-710**  
Light-Duty Clevis Hanger  
Sizes 1/2" through 4"  
**Federal Type 12**



**F-112**  
Forged Steel Turnbuckle  
Sizes 3/8" through 1 1/2" rod  
**Federal Type 13**  
**SP69 Type 13**



**F-111**  
Forged Steel Clevis  
Sizes 3/8" through 1 1/2" rod  
**Federal Type 14**  
**SP69 Type 13**

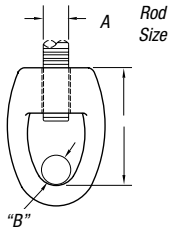

**M-117**  
MI Socket only for  
S Split Ring Hanger  
Sizes 3/8" through 7/8" Rod  
**Federal Type 16**  
**SP69 Type 16**



**E-120-A**  
Forged Steel Weldless Eye Nut  
Sizes 3/8" through 1 1/2" rod  
**Federal Type 17**  
**SP69 Type 17**

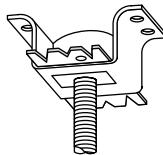

**452**  
Steel Concrete Insert  
**Federal Type 19**  
**SP69 Type 18**

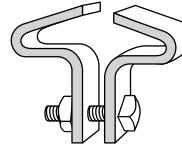

**C-755 T/C-757 T**  
Center I-Beam Clamp  
**Federal Type 21**  
**SP69 Type 21**

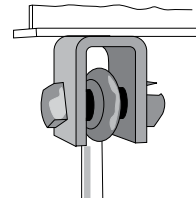

**C-780**  
Welded attachment as  
shown or inverted less bolt  
**Federal Type 22**  
**SP69 Type 22**



**M-775-L/C-775-L**  
MI or Steel C-Clamp  
Sizes 3/8" through 1 1/2"  
**Federal Type 23**  
**SP69 Type 23**



**H-115**  
U-Bolt  
Sizes 1/2" through 24" IPS  
**Federal Type 24**  
**SP69 Type 24**

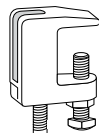

**M-778**  
Top Beam C-Clamp  
Sizes 3/8" through 3/4" rod  
**SP69 Type 19**

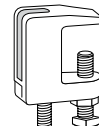

**M-777**  
Junior Top Beam C-Clamp  
Sizes 3/8" through 1/2" rod  
**SP69 Type 18**

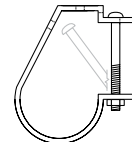

**C-711**  
"J" Pipe Hanger  
Sizes 1/2" through 8" pipe  
**SP69 Type 5**

## Technical Information

### Federal Specifications (WW-H-171)/ Manufacturers Society Specifications (MSS SP69) (continued)



**C-704-A**  
Offset J-Hook  
Sizes ½" through 3" IPS  
Federal Type 27



**M-732-H**  
I-Beam w/Eye Nut  
Federal w/o links Type 28  
Federal w/links Type 29  
SP69 Type 28



**M-732/M-732 Ext**  
I-Beam Clamp  
w/Swing Nut  
Sizes ¾" through 7/8" Rod  
Federal Type 30  
SP69 Type 30

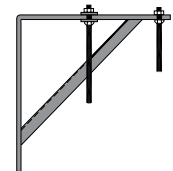

**C-736**  
Light Welded Steel Bracket  
Federal Type 32  
SP69 Type 31

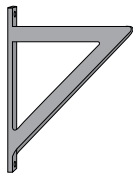

**C-739-H**  
Heavy Welded Steel Bracket  
Max. Load 3,000 lbs.  
Federal Type 34  
SP69 Type 33

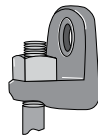

**M-750**  
Side Beam Bracket  
Sizes ¾" through 7/8" Rod  
Federal Type 35  
SP69 Type 34



**C-785-A**  
Pipe Stanchion Saddle  
Sizes 4" through 36" IPS  
Federal Type 38  
SP69 Type 37



**C-786**  
Adj. Pipe Saddle Support  
Sizes 2½" through 36" IPS  
Federal Type 39  
SP69 Type 38

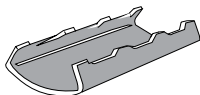

**C-789**  
Steel Pipe Covering  
Protection Saddle  
Sizes up to and including  
10" IPS  
Federal Type 40A  
SP69 Type 39

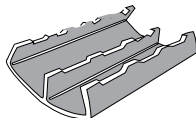

**C-789-AL**  
Steel Pipe Covering  
Protection Saddle  
Sizes 12" IPS and larger  
Federal Type 40B  
SP69 Type 39

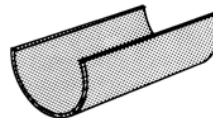

**C-790**  
Insulation Protection Shield  
for Vapor sealed pipe lines and  
insulated copper tubing  
Sizes ¾" through 12" IPS  
Federal Type 41  
SP69 Type 40



**RC-729A**  
Single Pipe Roll  
Sizes 1" through 24" IPS  
Federal Type 42  
SP69 Type 41



**C-729**  
Adj. Roller Hanger  
Sizes 1" through 20" IPS  
Federal Type 44  
SP69 Type 43



**S-730-C**  
Pipe Roll Complete  
Federal Type 45  
SP69 Type 44



**S-730-D**  
Adj. Pipe Roll & Base  
Federal Type 47  
SP69 Type 46