

Quality, Since 1857

Utility Catalog

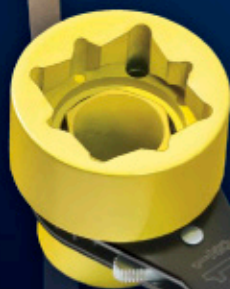

KLEIN TOOLS®

www.kleintools.com

Company History

Klein Tools was founded in 1857 by an industrious German immigrant, Mathias Klein, who began in the hand tool business when a broken side-cutting pliers was brought to his forge shop by a telegraph lineman. Mathias repaired the pliers by forging and finishing a new half for the tool and riveting it to the old half. Soon the lineman returned because the other original half of the pliers had broken and needed replacement. Mathias forged and finished the second half of the pliers and riveted it to the other replacement half – creating the first complete Klein pliers.

To this day, Klein Tools is proudly owned and managed by the Klein family. Over 150 years of hard work and dedication has earned Klein the reputation of supplying only the finest quality products for users of professional hand tools and occupational protective equipment.



Klein's reputation as a leading producer of professional-quality products is global. Klein Tools products are available worldwide through a well-established network of agents and distributors who stock what is needed for their particular markets.





Lineman's Climbing Equipment

Klein Tools lineman's climbing equipment meets or exceeds applicable OSHA, ASTM, and CSA standards and provides the comfort and choices professionals depend on.

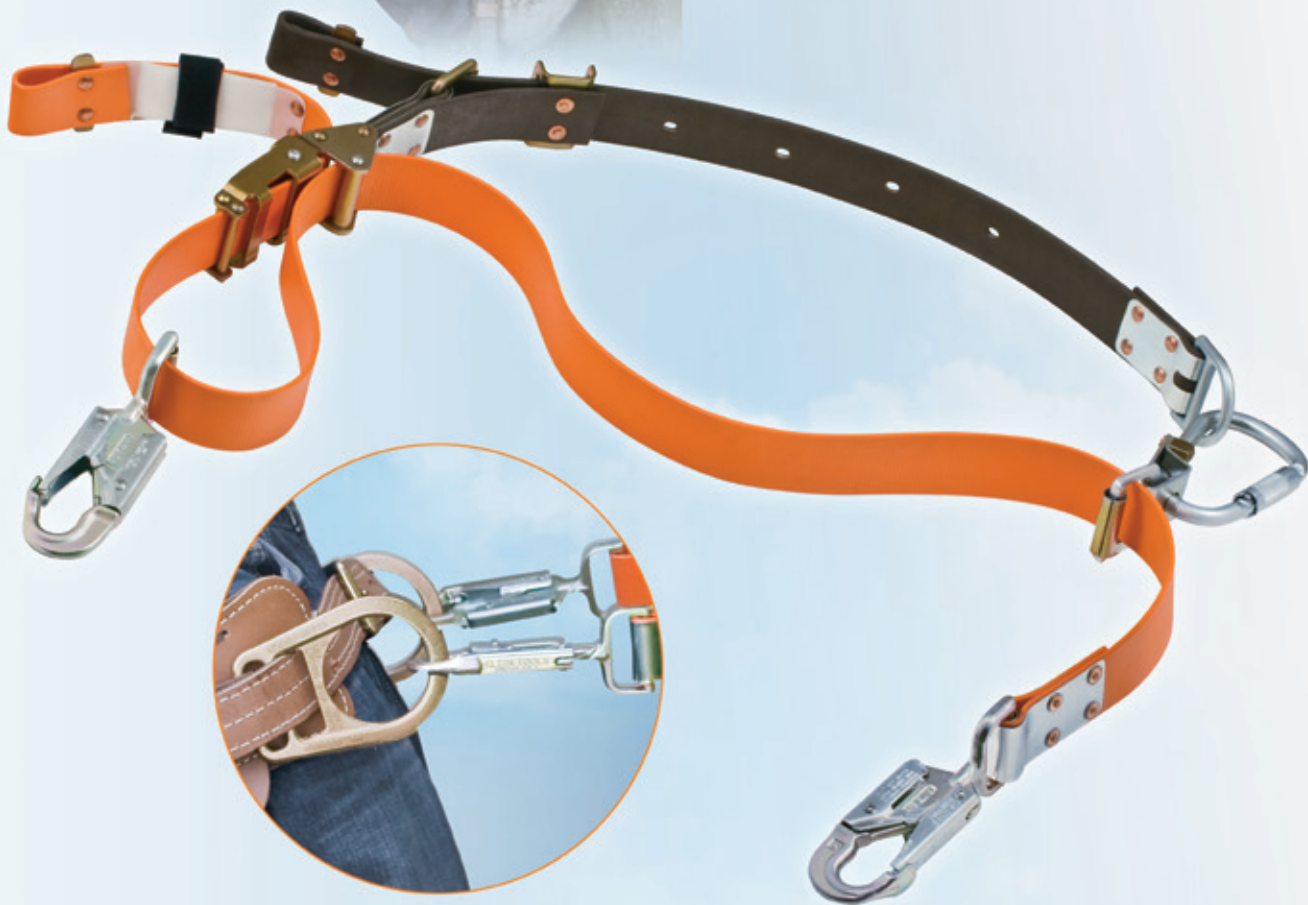

Introduction – Lineman’s Climbing Equipment

Klein manufactures a full line of lineman’s body belts and positioning devices (for positioning and limited fall restrict applications), designed to comply with OSHA criteria and applicable ASTM and CSA requirements.

The symbol shown in Figure 1 appears on warning and instruction tags attached to each body belt and positioning device identifying the Occupational Protective Equipment (OPE) function.

All individuals who use Klein lineman’s climbing equipment, must be instructed in how to use this equipment correctly. Also, they must read, understand, and follow all instructions and warnings packed with the product before each use.

Klein lineman’s body belts

- Available in full-floating, semi-floating, or fixed styles.
- They meet or exceed all OSHA regulations, which apply to positioning device systems, for power utilities (OSHA 1926.959) and telecommunications (OSHA 1910.268).
- They also meet or exceed standards ASTM F887 and CSA Z259.1.
- Each belt has a permanent tag, which identifies model number, serial number, size, and date of manufacture.

Klein positioning devices

- Positioning straps available with KG (elongated) and KL (standard) length snap-hooks.
- An Adjustable Positioning Lanyard (APL) with Length Adjusting Device – LAD (rope adjuster) 8’ (2.4m).
- Type A Wood Pole Fall Restrict Device (WPFRD) adjusts to pole diameters from 8” to 16” (203mm to 406mm).
- They are designed to meet or exceed standards:
 - CSA Z259.14 and ASTM F887 – WPFRD
 - CSA Z259.11 and ASTM F887 – APL and positioning straps.



Figure 1.

Wood Pole Fall Restrict Device (WPFRD)

NEW!

Features:

Adjusts from 8” to 16” diameter poles.

Outer strap constructed of Klein-Kord® material.

Carabiner sub-assembly with roller.

Cam Bracket and Adjusting Paddle.

Inner strap constructed of abrasion resistant webbing.

Klein-Gard™ elongated snap-hooks.

Patent Pending.



FPD-5295

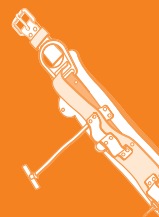

Wood Pole Fall Restrict Device (WPFRD)

PoleMaster™

NEW!

- Connecting hardware conforms to ASTM F887, ANSI Z359.12 and CSA Z259.12, Class I requirements.
- Abrasion resistant inner strap material for durability – includes a red wear indicator.
- Outer strap constructed of Klein-Kord® material – a proven material for years with linemen.
- Wood Pole diameter range from 8" to 16" (203 mm to 406 mm).
- Cam bracket system for easy adjustments.
- Self-closing and self-locking carabiner for easy disconnect from around the pole.
- Vinyl Storage Bag includes a zippered pocket for instructions and DVD7.
- The Wood Pole Fall Restrict Device (WPFRD) has been designed to meet CSA Z259.14-01 standard as a Type A Fall Restrict Device. Do NOT use on icy poles.
- Also meets or exceeds ASTM F887; OSHA 1910, 1926.



Positioning and Limited Fall Restrict

FPD-5295

Cat. No.	UPC No. 0-92644+	Pole Diameter Range	Weight (lbs.)
FPD-5295	52006-8	8" to 16" (203 mm to 406 mm)	6.4

Klein recommends using this system only with Klein® Lineman's Body Belts.

Lineman's Body Belts

Types of Klein Lineman's Body Belts

Full-Floating Belt: 5278N (5299N and 5282N) *Not pictured*

- Allows 4" (102 mm) lateral movement of the D-rings during use.
- D-rings easily adjust to lineman's positioning changes on the pole. As a result, the positioning strap slides against the pole less frequently, and strap wear is reduced.



Cat. No. 5278N pictured

- Any load or pull on the D-rings will not bind tools in the tool loops.
- Does not allow lateral movement of the belt strap with the tool loops.

Semi-Floating Belt: 5266N

- Allows lateral movement of the belt strap with the tool loops prior to wearing the body belt.
- Any load or pull on the D-rings will not bind tools in the tool loops.
- Does not allow lateral movement of the D-rings.



Cat. No. 5266N pictured

Fixed Belt: 5268N

- Does not allow lateral movement of the D-rings or belt strap with the tool loops.



Cat. No. 5268N pictured



Introduction – Lineman’s Climbing Equipment

Materials Used in Lineman’s Climbing Equipment

Klein-Kord®

- Klein lineman’s belt straps, billets, and pocket tabs are made of Klein-Kord®.
- Klein-Kord® is an exceptionally strong, multi-ply filament nylon fabric that is neoprene-impregnated, folded, and vulcanized.
- Klein-Kord® is abrasion-resistant, non-conductive, virtually free from stretch, and flexible for ease of use and durability. It has excellent chemical resistance and is virtually unaffected by creosote and other pole-treatment chemicals.
- In addition, its properties and wear characteristics remain essentially unchanged at temperatures up to 250°F (121°C).
- The center plies of Klein-Kord® are red at the core. When the red plies appear, remove the product from use and replace it. This “early warning” feature is yet another safety measure provided by Klein Tools.

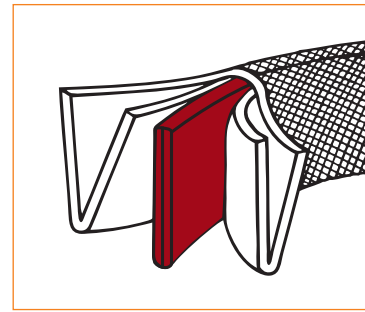

Six-ply Klein-Kord® with red center plies

Note: The red center plies may become discolored in use. Therefore, visual inspection for wear before use is mandatory.

Drop-Forged Steel Hardware

- Klein D-rings, snap-hooks, and tongue buckles are made of drop-forged steel with a corrosion-resistant finish.
- All of this Klein hardware is tested to meet or exceed applicable standards and OSHA requirements.

Nylon Webbing

- Klein uses a high-quality, commercial-grade nylon.
- The nylon webbing is impregnated with resin for extra durability and abrasion resistance.

Leather

- Rolled-edge, chrome-tanned topgrain leather is used for cushioning in all Klein lineman’s belts. These cushions have sponge-rubber cores for added comfort.
- Other components, such as tool loops, are made of latigo leather, hand-laced and stitched to the belt cushion.
- Tape thong straps are constructed from topgrain leather with fiber cross-piece.
- On top-of-the-line belts, straps are covered with harness leather.

Nickel Plating

Klein knife snaps, glove-bag rings, and suspender rings are nickel plated for durability and corrosion resistance.

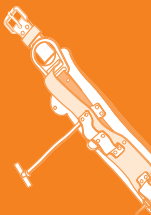

Lineman's Body Belts

Features:

Klein Tools body belts meet or exceed applicable ASTM and CSA standards and OSHA requirements.

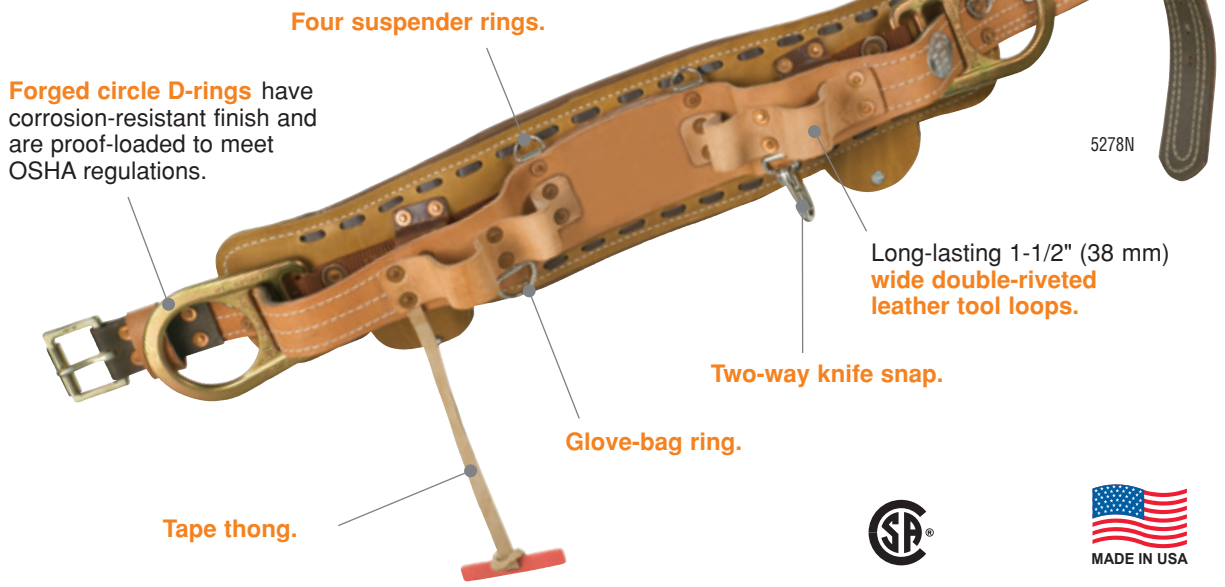

Forged circle D-rings have corrosion-resistant finish and are proof-loaded to meet OSHA regulations.

Four suspender rings.

Long-lasting 1-1/2" (38 mm) wide double-riveted leather tool loops.

Two-way knife snap.

Glove-bag ring.

Tape thong.



Full-Floating Body Belts

Lineman's Backsaver Belt

NEW!



5299N



Positioning and Limited Fall Restrict

- Leather construction is used throughout, including tool loops, tape thong, pocket tabs and cushioning material.
- Body Belt strap - covered in leather - is made of Klein-Kord®, an exceptionally strong nylon fabric that is abrasion-resistant, non-conductive, and flexible.
- 4" (102 mm) lateral movement of D-ring independent of belt and pad.
- Meets or exceeds applicable OSHA requirements and ASTM and CSA standards.

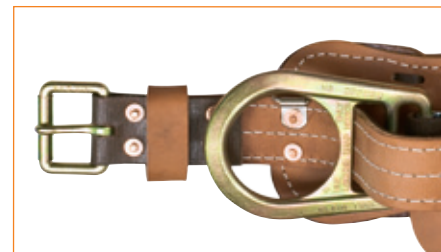

D-ring for 5299N

*See page 10 for body belt ordering procedure.



Full-Floating Body Belts

Full-Floating Body Belt – Style No. 5278N* (Deluxe) and Style No. 5282N* (Standard)

- *Latigo-leather belt pad is laced and stitched with two pocket tabs. (5278N only)*
- *Rolled-edge leather belt cushion for comfort when leaning back. 5" (127 mm) overall width.*
- *Padded for maximum comfort and body fit.*
- *1-3/4" (44 mm) wide Klein-Kord® belt strap covered with top-grain harness leather for long-lasting use.*
- *Full-floating D-ring web strap with straight double-bar D-rings.*
- *Klein-Kord® belt pad with two pocket tabs. (5282N)*



Positioning and Limited Fall Restrict

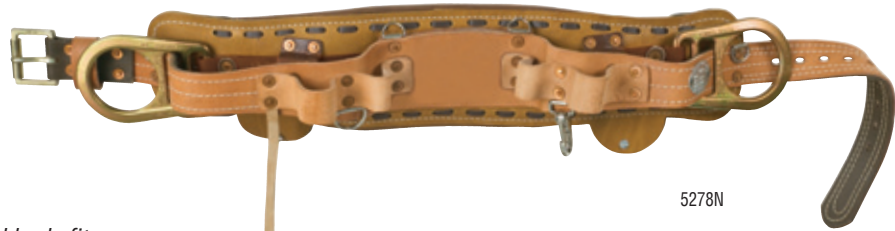

5278N



5282N

Semi-Floating Body Belt

Semi-Floating Body Belt – Style No. 5266N*

- *Klein-Kord® belt pad with two pocket tabs.*
- *Rolled-edge leather belt cushion for comfort when leaning back. 4-3/4" (120.6 mm) overall width.*
- *Padded for maximum comfort and body fit.*
- *1-3/4" (44 mm) wide belt strap made of 6-ply Klein-Kord®.*
- *Equipped with straight double-bar D-rings.*
- *Hand-line clip.*



Positioning and Limited Fall Restrict



5266N

Fixed Body Belt

Fixed Body Belt – Style No. 5268N*

- *Klein-Kord® belt pad with two pocket tabs.*
- *4-3/4" (120.6 mm) rolled-edge leather belt cushion with no padding.*
- *1-3/4" (44 mm) wide belt strap made of 6-ply Klein-Kord®.*
- *Equipped with straight double-bar D-rings.*



Positioning and Limited Fall Restrict



5249N

*See page 10 for body belt ordering procedure.

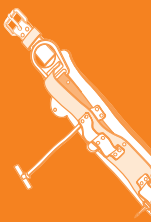

Positioning Straps

Adjustable Positioning Lanyard – APL

- Designed to meet CSA Z259.11 as a Class “F” lanyard.
- Also meets or exceeds CSA Z259.12; OSHA 1910, 1926.
- Stitched 1/2" rope with red center indicator threads.
- (2) Self-closing and self-locking snap hooks.
- Anti wear tubing for increased durability and ease in hitchhiking.
- 8' length (2.4m).
- Rope adjuster (LAD) that easily adjusts.
- Storage Hook (SEC-52595HK).
- Made in U.S.A.



NEW!

SEC-5295

Cat. No.	Maximum Length	Weight(lbs.)
SEC-5295	8' (2.4 m)	2.9
SEC-5295HK	4-3/4" (121 mm)	0.9

▲WARNING: The Adjustable Positioning Lanyard – APL (Secondary Device) is for positioning and travel restraint only.



SEC-5295HK



Positioning Only

Klein-Gard™ (KG) and Klein-Lok™ (KL) Series Positioning Straps

- Made of 6-ply, 1-3/4" (45 mm) wide Klein-Kord® an exceptionally strong, flexible fabric.
- Elongated 6-1/2" (165 mm) snap hook is easy to use with even the thickest gloves. (KG Series)
- Internal lock mechanism.
- Snap hook has 5,000 lb. proof-loaded rating.
- Red wear indicator in center of strap alerts user when strap needs to be replaced.
- Meets or exceeds applicable OSHA requirements and ASTM and CSA standards.



KG5295L



Positioning Only

Cat. No. KG Series	Cat. No. KL Series	Maximum Length	Minimum Length	Adjustable Range
KG5295L	KL5295L	5' 8" (1.72 m)	4' 1" (1.24 m)	1' 7" (0.48 m)
KG5295-6L	KL5295-6L	6' (1.83 m)	4' 3" (1.30 m)	1' 9" (0.53 m)
KG5295-6-6L	KL5295-6-6L	6' 6" (1.98 m)	4' 6" (1.37 m)	2' (0.61 m)
KG5295-7L	KL5295-7L	7' (2.13 m)	4' 9" (1.45 m)	2' 3" (0.69 m)
KG5295-8L	KL5295-8L	8' (2.44 m)	5' 9" (1.75 m)	2' 3" (0.69 m)



KG Series 6-1/2" (165 mm) snap hook



KL Series 5" (127 mm) snap hook

*Depending on the application, choose a positioning strap that allows you to work at arm's length from the pole or other positioning anchorage.



Klein has been a well-recognized manufacturer of occupational protective equipment since 1890.

The Klein-Gard™ positioning straps provide ease of use with gloved hands. The positioning straps are constructed with 6-ply Klein-Kord® material, which offers abrasive resistance and contrasting center color to alert lineman when to replace. The KG series features drop-forged hardware with a corrosion resistant finish.

▲WARNING: It is important that users of this product read, understand, and follow all instructions, cautions, and warnings that are attached to and/or packed with the product.



Lineman's Accessories

Tape Thong



- Long-lasting leather thong with fiber bar at end.
- Conveniently fits all standard electrical tape rolls.
- Slotted at the top for easy attachment to the belt.

Cat. No.	Length
5130	12" (30 cm)

Two-Way Knife Snap



- Easily attaches to belts with screw type rivets.
- Long-lasting leather strap construction.

Cat. No.	Length
5131	4-1/2" (11 cm)

Handline Clip



- Long-lasting leather thong slotted at the top for easy attachment to the belt.
- 8 to 12 lbs. of tension will release handline should it snag.

Cat. No.	Length
5133	10-1/2" (27 cm)



▲WARNING: It is important that users of this product read, understand, and follow all instructions, cautions, and warnings that are attached to and/or packed with the product.

Body Belt Ordering Procedure

The catalog number used to order a Lineman's Body Belt is made up of specific parts. Each part of the number refers to a component or component size. The following is a typical example of a catalog number: 5278N-24D

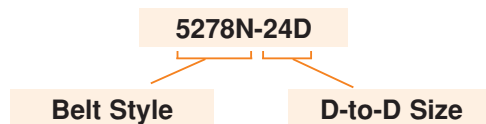

Use the following ordering procedure to properly identify and select each component in order to create a catalog number for your Lineman's Body Belt.

- 1. Know the job and regulations** governing performance requirements for the equipment needed.
- 2. Select the belt style.**
 - Klein lineman's body belts are available in a choice of full-floating, semi-floating, and fixed styles, and feature the choice of belt pad size.
 - All Klein lineman's body belts have chrome-tanned leather cushions for greater comfort.
 - Full-floating belts allow lateral movement of the D-rings during use.
 - Semi-floating and fixed-style belts allow no lateral movement of the D-rings.
- 3. Select the proper belt size.**
 - The comfort of a lineman's belt depends on the construction of the belt and the location of the D-rings.
 - The D-rings should be located about 1" (25 mm) in front of the hip bones.

Never order Klein lineman's body belts by waist size. Always order Klein lineman's body belts by the desired distance between D-rings.

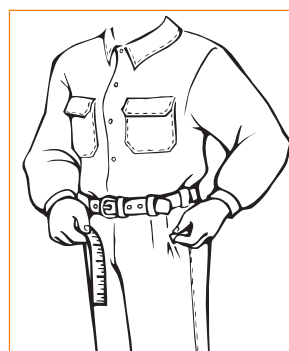

Size your body belt using a tape measure (Figure 1).

To obtain the correct D-to-D (D-ring to D-ring) size, measure around the back from hipbone to hipbone and then add 2" (51 mm).

Figure 1

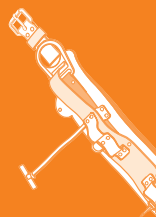

Body Belt & Back Saver Belt Ordering Procedure

The Lineman's Belt Sizing Table (shown below) contains more information on selecting the proper belt size. For non-standard sizes, please call the Klein Tools Sales Department at 1-800-553-4676.

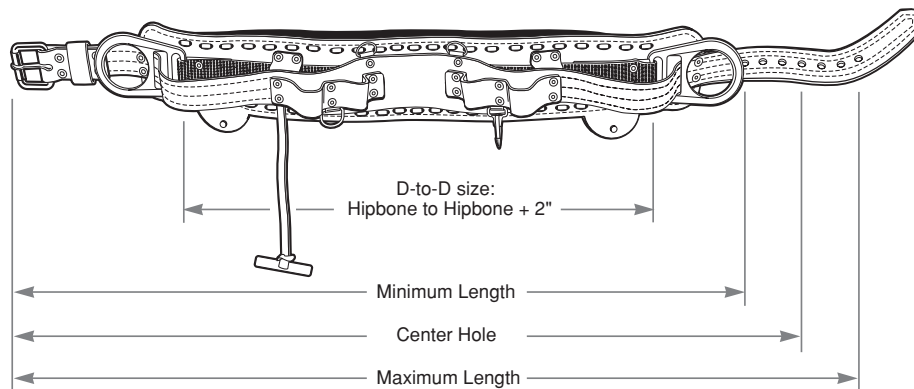

Lineman's Belt Sizing Table*

D-to-D Distance	Minimum Length	Center Hole Distance	Maximum Length
18D (46 cm)	32" (81 cm)	36" (91 cm)	40" (102 cm)
19D (48 cm)	33" (84 cm)	37" (94 cm)	41" (104 cm)
20D (51 cm)	34" (86 cm)	38" (97 cm)	42" (107 cm)
21D (53 cm)	36" (91 cm)	40" (102 cm)	44" (112 cm)
22D (56 cm)	37" (94 cm)	41" (104 cm)	45" (114 cm)
23D (58 cm)	38" (97 cm)	42" (107 cm)	46" (117 cm)
24D (61 cm)	40" (102 cm)	44" (112 cm)	48" (122 cm)
25D (64 cm)	41" (104 cm)	45" (114 cm)	49" (124 cm)
26D (66 cm)	42" (107 cm)	46" (117 cm)	50" (127 cm)
27D (69 cm)	44" (112 cm)	48" (122 cm)	52" (132 cm)
28D (71 cm)	45" (114 cm)	49" (124 cm)	53" (135 cm)
29D (74 cm)	46" (117 cm)	50" (127 cm)	54" (137 cm)
30D (76 cm)	47" (119 cm)	51" (130 cm)	55" (140 cm)

* All measurements are listed in inches and (cm). This table shows the maximum and minimum lengths and center-hole distances for the full range of standard D-to-D measurements. A belt sized for the proper D-to-D size will fit correctly with buckle tongue engaged in the center hole.

** Non-standard D-to-D sizes can be special ordered; please call the Klein Tools Sales Department at 1-800-553-4676.

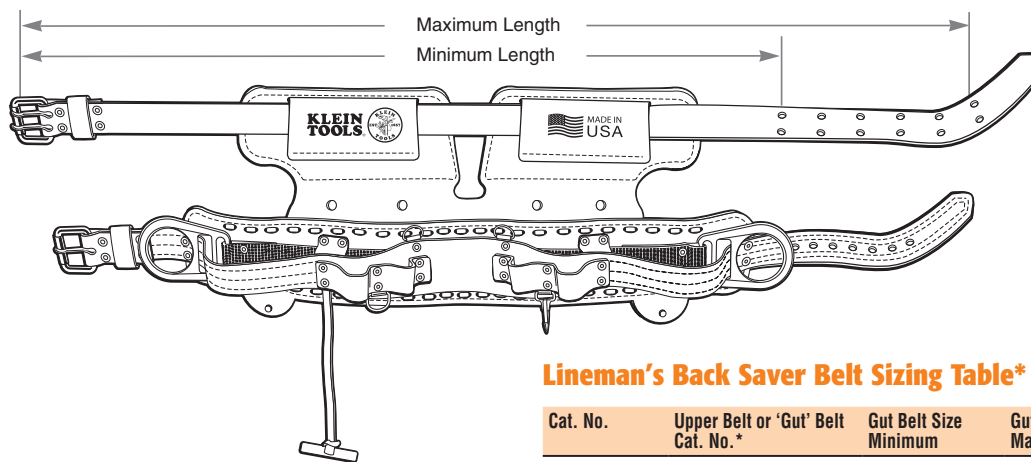

Lineman's Back Saver Belt Sizing Table*

Cat. No.	Upper Belt or 'Gut' Belt Cat. No.*	Gut Belt Size Minimum	Gut Belt Size Maximum
5299N18D	5299S (small)	30" (76 cm)	40" (102 cm)
5299N19D	5299 (medium)	34" (86 cm)	44" (112 cm)
5299N20D	5299 (medium)	34" (86 cm)	44" (112 cm)
5299N21D	5299 (medium)	34" (86 cm)	44" (112 cm)
5299N22D	5299 (medium)	34" (86 cm)	44" (112 cm)
5299N23D	5299L (large)	38" (97 cm)	48" (122 cm)
5299N24D	5299L (large)	38" (97 cm)	48" (122 cm)
5299N25D	5299L (large)	38" (97 cm)	48" (122 cm)
5299N26D	5299L (large)	38" (97 cm)	48" (122 cm)
5299N27D	5299XL (x-large)	42" (107 cm)	52" (132 cm)
5299N28D	5299XL (x-large)	42" (107 cm)	52" (132 cm)
5299N29D	5299XL (x-large)	42" (107 cm)	52" (132 cm)
5299N30D	5299XL (x-large)	42" (107 cm)	52" (132 cm)

CAUTION: Remember, a backsaver belt is not a substitute for an orthopedic brace and is only designed to provide the wearer additional comfort and support. The actual lineman's belt portion should still be worn around the hips. Do not position the belt lower and attempt to sit in it as you could flip or tip out in the event of a fall.

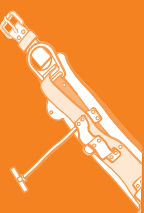

Positioning Straps Ordering Procedure

Depending on your application, choose a positioning strap that allows you to work at arms' length from the pole or other positioning anchorage. Lineman's Positioning Straps are adjustable and available in five sizes. For more information, see the following chart:

Cat. No. KG Series	Cat. No. KL Series	Maximum Length	Minimum Length	Adjustable Range
KG5295L	KL5295L	5' 8" (1.72 m)	4' 1" (1.24 m)	1' 7" (0.48 m)
KG5295-6L	KL5295-6L	6' (1.83 m)	4' 3" (1.30 m)	1' 9" (0.53 m)
KG5295-6-6L	KL5295-6-6L	6' 6" (1.98 m)	4' 6" (1.37 m)	2' (0.61 m)
KG5295-7L	KL5295-7L	7' (2.13 m)	4' 9" (1.45 m)	2' 3" (0.69 m)
KG5295-8L	KL5295-8L	8' (2.44 m)	5' 9" (1.75 m)	2' 3" (0.69 m)

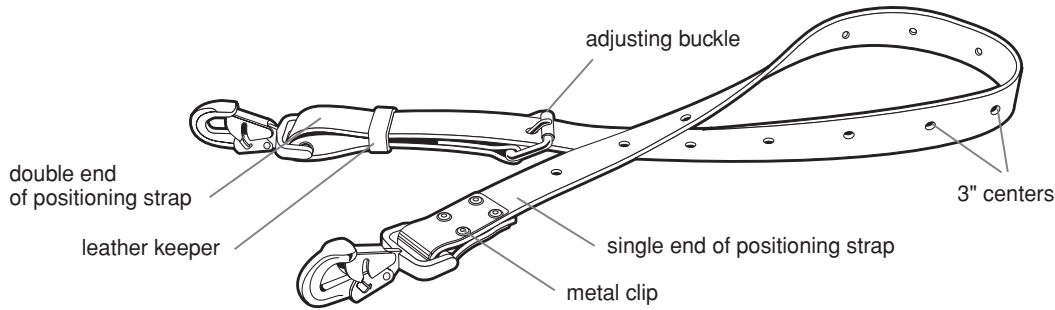
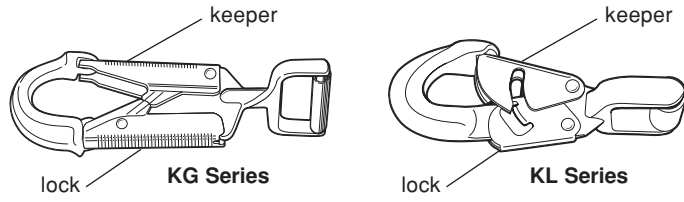

Warning Tags & Labels – Lineman's Climbing Equipment

Klein attaches highly-durable warning and instruction tags/labels to its OPE products. In the event any of these tags or labels become unattached, lost, or damaged, contact the Klein Tools Sales Department at 1-800-553-4676 for information on how to have the tags replaced free of charge.

Types of OPE Warning Tags/Labels

This section contains black and white reproductions of Klein OPE warning tags/labels. They are organized by product category. Some warning and instructional information may be printed on a durable label wrapped around the product.

A set of plastic or Tyvek warning tags are attached to the majority of OPE products.

Each set contains four types of warning/information tags:

- 1. A General Hazard Tag** will be attached to each OPE product.
- 2. General Warning Tags** will be included on all OPE products in a particular category. For example, all OPE harnesses will have general harness warning tags.
- 3. Specific Warning Tags** will be included for each class of products within a particular category. For example, Cat. No. 87012 and 87020 harnesses have their own specific warning tags.
- 4. A Product ID Tag** will be attached to each OPE product.

General Hazard Tag for All OPE Products

This tag is the first in a set of warning tags which will be attached to each Klein OPE product.



Product ID Tag for OPE Connecting Devices

For connecting devices with warning tag packets, this tag (front and back sides shown) is the last in a set of warning tags which will be attached to each Klein OPE product.

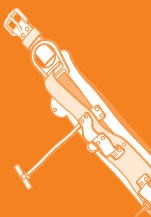
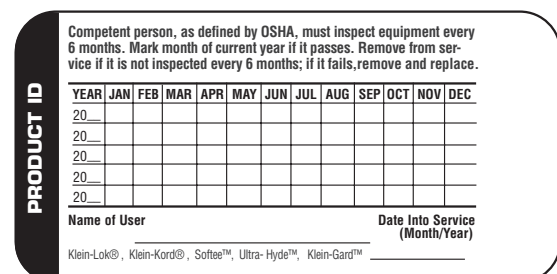
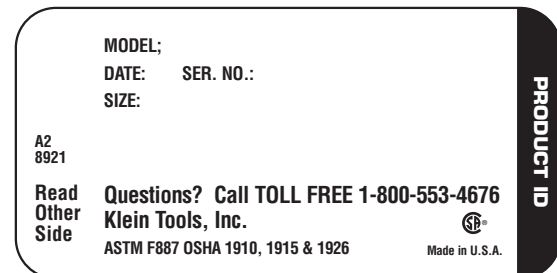

Warning Tags & Labels – Lineman's Climbing Equipment

Klein permanently attaches highly durable warning and instruction tags to its lineman's body belts and positioning straps.

If any of these tags become unattached, lost, or damaged, call Klein Tools, toll-free at 1-800-553-4676, for information on how to have the tags replaced free of charge.

Tags for Lineman's Body Belts



C1b1.997
Read Other Side

For Positioning Use Only

- Use this product for positioning only, **NOT** for fall arrest.
- If possible, the use of fall arrest equipment is **highly recommended** in addition to this belt.
- Assume the responsibility for determining that your belt is in good condition at all times.

- Do **NOT** use connecting devices made of leather or manila rope.
- Never** use side D-rings for fall arrest.
- Positioning anchorages** must support your weight plus any additional job related load.
- Never** allow belt to come in contact with edged or pointed tools; or come near a radiator, steam pipe, stove, heater, engine exhaust pipe or other heat source.

Read Next Tag

INSTRUCTIONS

- For use by **properly trained professionals only**.
- Only** use locking snap hooks.
- OPE equipment must only** be used for the specific purpose for which it is designed and intended.
- OPE equipment **must be destroyed** if subjected to impact loading.
- Always visually check** that all buckles are properly closed before each use.
- Never** allow a positioning strap to become twisted before engaging D-ring.

B1-2.1.007
Read Other Side

INSTRUCTIONS

- Always visually check that:** 1) each snap hook freely engages D-ring or anchor point, 2) keeper is completely closed with each use. **Never** rely solely on the feel or sound of a snap hook engaging.
- Before each use check that:** 1) fabric or belt strap is free of burns, cuts, broken stitches or excessive wear, 2) rivets are not bent, loose or missing, 3) buckles and D-rings are not distorted or cracked, 4) if tongue buckle, tongue does not bind on buckle and buckle holes are not damaged, 5) **Remove from service, destroy and discard belt or harness if it fails inspection and replace immediately.**

Read Next Tag

- For personal use only. NOT** for towing or hoisting.
- Snap hooks attached to D-rings **must** have less than 3/4" (19mm) throat opening. **Never** attach ladder or rebar hooks onto D-rings.
- Never** attach multiple snap hooks onto a D-ring.
- Never** punch additional holes in or alter any belt or harness in any way.
- Never** work without independent fall arrest protection if there is danger of a fall.

B1-2.2.007
Read Other Side

- NOT** for recreational or sporting use.
- Employer**— instruct employee as to proper use and warnings before use of equipment.
- Read, understand and follow** all instructions and cautions attached to and/or packed with this and all occupational protective equipment before each use.
- Klein strongly recommends that Klein components **NOT** be interchanged with other components made by other manufacturers, because Klein cannot guarantee that other manufacturers' components are free of defects in materials or workmanship.

Read Next Tag

WARNING

Klein strongly recommends using fall-arrest protection when working at any elevated position. Therefore, independent fall-arrest equipment should be used in addition to Klein's body belts and positioning straps unless a competent person, as defined by OSHA, has determined that such fall-arrest equipment is not necessary or appropriate.

Tags for Lineman's Positioning Strap



C6b1.997
Read Other Side

For Positioning Use Only

- Always** attach snap hooks to positioning D-rings on both sides of the belt or harness with keepers facing outward.
- Never** attach multiple snap hooks onto a D-ring.
- Never** allow a positioning strap to become twisted before engaging D-ring.

- Never** attach multiple positioning straps together.
- Never** attach a positioning strap back onto itself.
- Assume the responsibility for determining that your positioning strap is in good condition at all times.
- Never** allow positioning strap to come in contact with edged or pointed tools, welding; or near a radiator, steam pipe, stove, heater, engine exhaust pipe, or other heat source.
- Never** use a positioning strap which has worn to the point of showing the red-colored interior plies.

Read Next Tag

WARNINGS

- For human support only, NOT** for towing or hoisting material.
- Never** disable locking keeper on hook, punch holes in or alter a positioning strap in any way.
- Use **only** with positioning belt or harness with positioning D-rings meeting government standards for intended use.
- Klein strongly recommends that Klein components **NOT** be interchanged with other components made by other manufacturers, because Klein cannot guarantee that other manufacturers' components are free of defects in materials or workmanship.

C6b2.007
Read Other Side

WARNINGS

- Before each use check that:** 1) unit is free of burns, cuts, abrasions, kinks, knots, broken strands and excessive wear, 2) hooks, buckle (and D-rings, if any) are not distorted or cracked, 3) hook keepers are free of burrs, functioning properly, clean, and not bent, 4) positioning strap has not worn to the point of showing the red-colored interior plies, 5) **Remove from service, destroy and discard unit if it does not pass this inspection and replace immediately.**

Read Next Tag

WARNINGS

- For use by **properly trained professionals only**.
- OPE equipment must only** be used for the specific purpose for which it is designed and intended.
- Connecting devices **must be destroyed** if subjected to impact loading.
- Always visually check that:** 1) each snap hook freely engages D-ring or anchorage, 2) keeper is completely closed with each use. **Never** rely solely on the feel or sound of a snap hook engaging.
- Make sure each hook is positioned so that its keeper is **never** load bearing.

C6b3.997
Read Other Side

WARNINGS

- Never** join two snap hooks together. They are **NOT** intended to be used that way, and could twist apart.
- Never** work without independent fall arrest protection if there is danger of a fall.
- Employer**— instruct employee as to proper use and warnings before use of equipment.
- Read, understand and follow** all instructions and cautions attached to and/or packed with this and all occupational protective equipment before each use.

Read Next Tag



Warning Tags & Labels – PoleMaster™



⚠ WARNINGS

For Positioning and Limited Fall Restrict on wood poles ONLY as defined by ASTM F887 & CSA Z259.14-01 C2-F

- Always attach snap hooks to positioning D-rings on both sides of the belt or harness with keepers facing outward.
- Never work without independent fall arrest protection if there is danger of a fall. Use of a Secondary Adjustable Positioning Lanyard (APL) is highly recommended when climbing past obstacles.
- When using a Secondary APL with the (WPFRD), refer to separate instructions and warnings for proper use.
- Never attach multiple snap hooks onto a single D-ring while actively climbing.
- Never allow WPFRD outer strap or inner strap to become twisted before engaging D-ring.

READ OTHER SIDE

⚠ WARNINGS

- Never attach multiple WPFRD's together.
- Assume the responsibility for determining that your WPFRD is in good condition at all times.
- Never allow WPFRD straps to come in contact with edged or pointed tools, sharp edges, abrasive surfaces, welding; or near a radiator, steam pipe, stove, heater, engine exhaust pipe, or other heat source.
- Never use a Fall Restrict Equipment (FRE) straps which have worn to the point of showing the red-colored interior plies.

C2-B

⚠ WARNINGS

- For human support only, NOT for towing or hoisting material.
- Never disable locking keeper on hook, punch holes in or alter WPFRD in any way.
- Use only with belt or harness with positioning D-rings meeting ASTM F887 standards for intended use.
- Klein strongly recommends that Klein components NOT be interchanged with other components made by other manufacturers, because Klein cannot guarantee that other manufacturers' components are free of defects in materials or workmanship.

C3-F

READ OTHER SIDE

Warning Tags & Labels – Klein Adjustable Positioning Lanyard - APL



⚠ WARNINGS

A fall could result in serious injury or death. Do not use unless properly trained. Read and follow all instructions and warnings.

C1-F

READ OTHER SIDE

DO NOT REMOVE TAGS

⚠ WARNINGS

- **Employer** — instruct employee as to proper use and warnings before use of equipment.
- **Read, understand and follow** all instructions and cautions attached to and/or packed with this and all occupational protective equipment before each use.

C1-B

⚠ WARNINGS

- For use by properly trained professionals only.
- OPE equipment must only be used for the specific purpose for which it is designed and intended.
- Assume the responsibility when using the Fall Restrict Equipment (FRE) around moving machinery and electrical hazards.
- Misuse of the Fall Restrict Equipment (FRE) could result in injury or death.
- Connecting devices must be destroyed if subjected to impact loading.
- Always visually check that: 1) each snap hook freely engages D-ring or anchorage, 2) keeper is completely closed with each use. Never rely solely on the feel or sound of a snap hook engaging.
- Make sure each hook is positioned so that its keeper is never load bearing.

C4-F

READ OTHER SIDE

⚠ WARNINGS

- Never join two snap hooks together. They are NOT intended to be used that way, and could twist apart.
- Employer — instruct employee as to proper use and warnings before use of equipment.
- Read, understand and follow all instructions and cautions attached to and/or packed with this and all occupational protective equipment before each use.

C4-B

⚠ WARNINGS

- Before each use check that: 1) unit is free of burns, cuts, abrasions, kinks, knots, broken strands and excessive wear, 2) hooks, carabiner, buckle, D-rings are not distorted or cracked, 3) hook keepers are free of burrs, functioning properly, clean, and not bent, 4) WPFRD outer and inner straps have not worn to the point of showing the red-colored interior plies, 5) Remove from service, destroy and discard unit if it does not pass this inspection and replace immediately. 6) ANY UNIT WHICH HAS SEEN FALL ARREST SERVICE SHOULD NOT BE USED AFTER SUCH SERVICE.
- Never attempt to repair or modify any part or component of WPFRD.

C3-B



⚠ WARNINGS

WARNING: Hardware must be in direct contact with the pole at the 9 and 3 o'clock positions as shown. Failure to do so could prevent the Wood Pole Fall Restrict Device (WPFRD) from stopping your fall causing injury or death.

C1-B

⚠ WARNINGS

- **Before each use check that:** 1) unit is free of burns, cuts, abrasions, kinks, knots, broken strands and excessive wear, 2) hooks, link and Length Adjusting Device - LAD (Rope Adjuster) are not distorted or cracked, 3) hook keepers are free of burrs, functioning properly, clean, and not bent, 4) Adjustable Positioning Lanyard - APL (Secondary Device) rope has not worn to the point of showing the red-colored interior. 5) **Remove from service, destroy and discard unit if it does not pass this inspection and replace immediately.** 6) **ANY UNIT WHICH HAS SEEN FALL ARREST SERVICE SHOULD NOT BE USED AFTER SUCH SERVICE.**
- **Never attempt to repair or modify any part or component of APL.**

C3-B

⚠ WARNINGS

- For use by **properly trained professionals only.**
- **OPE equipment must only** be used for the specific purpose for which it is designed and intended.
- Assume the responsibility when using the Adjustable Positioning Lanyard - APL (Secondary Device) around moving machinery and electrical hazards.
- Misuse of the APL could result in injury or death.
- Connecting devices **must be destroyed** if subjected to impact loading.
- **Always visually check that:** 1) each snap hook freely engages D-ring or anchorage, 2) keeper is completely closed with each use. Never rely solely on the feel or sound of a snap hook engaging.
- Make sure each hook is positioned so that its keeper is **never** load bearing.

C4-F

READ OTHER SIDE

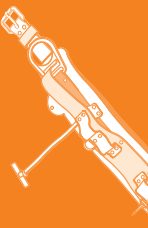

Warning Tags & Labels – Klein Adjustable Positioning Lanyard - APL



⚠ WARNINGS

For Positioning and Travel Restraint ONLY. Positioning connecting devices must be rigged so that a worker cannot free fall more than 2 feet.

C2-F

- **Never** work without independent fall arrest protection if there is danger of a fall.
- **Always** attach snap hooks of the Adjustable Positioning Lanyard - APL (Secondary Device) to positioning D-rings on both sides of the belt or harness with keepers facing outward.
- The arrow on the Length Adjusting Device - LAD (Rope Adjuster) should **always** point away from the user.
- **Never** attach multiple snap hooks onto a single D-ring while actively climbing.

READ OTHER SIDE

⚠ WARNINGS

- For **human support** only, **NOT** for towing or hoisting material.
- **Never** disable locking keeper on hook, disable Length Adjusting Device - LAD (Rope Adjuster) or alter the Adjustable Positioning Lanyard - APL (Secondary Device) in any way.
- Use **only** with belt or harness with positioning D-rings meeting ASTM, ANSI or CSA standards for intended use.
- **Never** alter or remove the stop on the free end of the APL.
- Klein strongly recommends that Klein components **NOT** be interchanged with other components made by other manufacturers, because Klein cannot guarantee that other manufacturers' components are free of defects in materials or workmanship.

C3-F

READ OTHER SIDE

⚠ WARNINGS

- **Never** attach multiple Adjustable Positioning Lanyard - APL (Secondary Device) devices together.
- Assume the responsibility for determining that your APL is in good condition at all times.
- **Never** allow APL rope to come in contact with edged or pointed tools, sharp edges, abrasive surfaces, welding; or near a radiator, steam pipe, stove, heater, engine exhaust pipe, or other heat source.
- **Never** use an APL rope which has worn to the point of showing the red-colored interior.
- **Failure** to properly store the APL when not in use could hook a gaff increasing the danger of a fall.

C2-B

⚠ WARNINGS

- **Never** join two snap hooks together. They are **NOT** intended to be used that way, and could twist apart.
- **Never** attach an Adjustable Positioning Lanyard - APL (Secondary Device) back onto itself.
- **Never** tie knots in the APL. Knots can reduce the strength of the APL rope up to 50%.

C4-B

Inspection Procedures

General

- 1. Check for wear and deterioration.** Before each use, carefully inspect your harness for signs of wear, deterioration, or evidence of impact loading. Visually inspect for loose threads, pulled rivets, burns, cuts, distortions, abrasions, or any other evidence of chemical or physical deterioration that may have weakened the material or assembly.
- 2. Inspect hardware for malfunctions and cracks.** Check all snap-hooks, buckles, and D-rings.
- 3. Remove from service and replace all worn or damaged equipment.** If any part does not pass inspection, immediately remove the harness from service and destroy it.

Specific

- 1. Inspect stitching and webbing.** Check stitching for broken, burned, cut, or pulled stitches. Broken strands appear as tufts on the surface. To inspect, hold the webbing with your hands six to eight inches apart. Bend the webbing in an inverted "U" to cause surface tension, exposing problem areas. Inspect all web areas. Damage from cuts, abrasions, corrosives, heat, or chemicals should be apparent. (See Fig. 1)
- 2. Inspect buckle and belt ends.** Inspect the ends of all straps, which can wear from repeated opening and closing. Enlarged or distorted holes may indicate excessive wear or damage through impact loading. Harnesses with unusually enlarged or distorted holes should fail inspection. (See Fig. 2)
- 3. Inspect D-rings.** Check all D-rings for distortion. Check D-ring attachment points for unusual wear or damaged fibers. Badly pitted D-rings indicate chemical corrosion, and they should fail inspection. (See Fig. 3 and 4)
- 4. Inspect stitching or rivets at hardware attachment points.** For stitched attachment points, check that stitching is not broken, burned, cut, or pulled. Check all riveted attachment points for tightness. Badly pitted rivets indicate chemical corrosion, and they should fail inspection. (See Fig. 4)
- 5. Inspect tongue buckles.** Check all tongue buckles for distortion, sharp edges, and cracks. The tongue should move freely and overlap the frame. Rollers should not be distorted and should roll freely. (See Fig. 5)

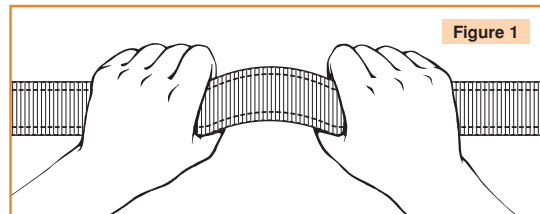

Figure 1

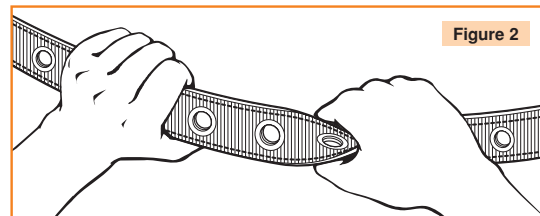

Figure 2

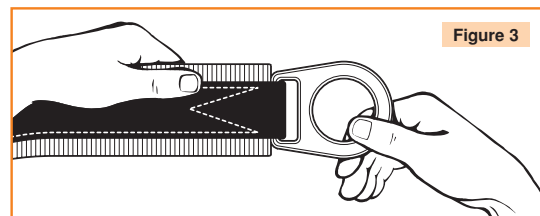

Figure 3

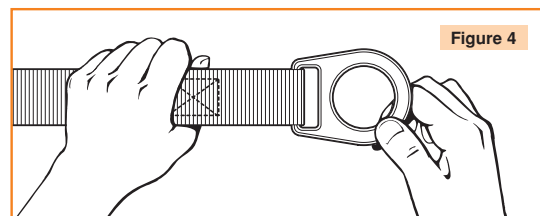

Figure 4

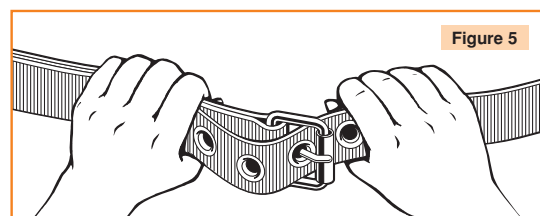

Figure 5



Lineman's Climbing Equipment Inspection Procedures

1. Stitching or rivets at hardware attachment points.

For stitching-attachment points, check that stitching is not broken, burned, cut, or pulled. For riveted attachment points, check all rivets for tightness, especially those at D-ring wear pads. Badly pitted rivets indicate chemical corrosion, and equipment should be replaced immediately. (See Fig. 1)

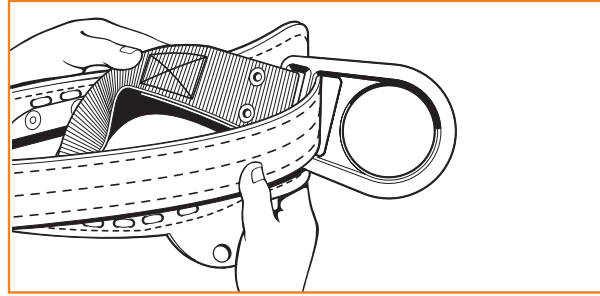

2. Destroy and replace all worn or damaged OPE equipment.

If any evidence of excessive wear, deterioration, or mechanical malfunction is observed, replace equipment immediately. **Never work with worn or damaged OPE equipment. Using damaged or worn equipment can cause serious injury or death.**

3. The inspector is the most important part of any inspection procedure. Check all equipment thoroughly and follow all safety procedures and guidelines. Do not take any shortcuts.

⚠WARNING: If you note any unusual conditions during the inspection that are not specified here, do NOT use the suspect equipment until a qualified individual has made a decision on its usability.

Important Note: OSHA specifies that all employers covered by the Occupational Safety and Health Act are responsible for inspection and maintenance of all tools and equipment used by employees – whether owned by the employees or by the company.

Personal-protective equipment should be inspected before each use, and immediately removed from service if any sign of wear or damage is found.

PoleMaster™ Inspection Procedures



⚠WARNING: Should any unusual conditions be noted during the inspection which are not specified here, do not use the suspect equipment until a qualified individual has made a decision on its usability.

1. Check for wear and deterioration. Before each use, carefully inspect your Wood Pole Fall Restrict Device (WPRD) for signs of wear or deterioration or evidence of impact loading. **IF ANY SIGNS OF IMPACT LOADING ARE EVIDENT, THE DEVICE MUST BE REMOVED FROM SERVICE.** Visually inspect for loose threads, pulled rivets, burns, cuts, abrasions, or evidence of chemical or physical deterioration that may have weakened the material or assembly.

2. Inspect hardware for malfunctions and cracks; including (2A) belt buckles, (2B) snap hooks, (2C) carabiner, (2D) cam bracket sub-assembly, (2E) guide bracket and stops. Check that snap hooks, carabiner and cam bracket sub-assembly are not distorted or cracked and that the keepers are free of burrs, functioning properly, clean, and not bent.

3. Destroy and replace all worn or damaged equipment. Immediately destroy and replace any OPE system component which does not pass inspection.

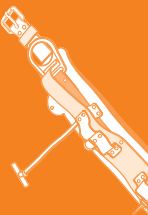

Pole & Tree Climbers

Features:



Adjustable climber length. Steel sleeve moves in 1/4" (6 mm) increments for the most comfortable fit.

Contoured leg irons help position gaffs securely and comfortably.

Replaceable gaff firmly attaches to the leg iron with a center pin and two TORX® screws.



8" x 8" (203 x 203 mm) cushioned, high-grade leather climber pads for maximum comfort.

Neoprene-impregnated nylon climber straps for long-lasting life.

Secure sleeve and leg iron connection. Two slotted hex-head bolts with lock washers and barrel-type nuts join the steel sleeve and leg iron together.

Steel split ring secures ankle strap in place and allows for quick replacement.

4-7/16" (113 mm) wide stirrup provides greater foot support.

Pole Climbers with 1-1/2" Gaffs - Complete Set

1972AR Series

- Includes 8" x 8" (203 x 203 mm) cushioned leather pad, steel sleeve, leg iron, gaff, split ring, and nylon calf and ankle straps.
- C.C.A. pole gaff. Designed to penetrate the hardest salt-treated poles.
- To determine size needed, measure from instep to 1" (25 mm) below knee.
- Sold in pairs only.



CN1972ARL

Cat. No.	Adjustable Length	Shipping Weight (lbs.)	Replacement Gaff Cat. No.	Replacement Pad Cat. No.	Replacement Calf Strap Cat. No.	Replacement Ankle Strap Cat. No.
CN1972AR	15" - 19" (381 mm - 483 mm)	6.00	72	8210	5301-18	5301-20
CN1972ARL	17" - 21" (432 mm - 533 mm)	6.25	72	8210	5301-18	5301-20

WARNING: For your protection, Klein recommends that climbers be replaced when original gaff and two replacement gaffs have been used on the climbers.

TORX® is a registered trademark of Acument Intellectual Properties, LLC.
All Klein climber straps are sold in pairs only.
All Klein ankle straps and pads are sold in pairs only.



Pole & Tree Climbers

Pole Climbers with 1-9/16" Gaffs – Complete Set

1986AR Series

- Gaffs are longer in length and wider in angle than 1-1/2" gaffs for exceptional resistance to cutouts.
- Includes 8" x 8" (203 x 203 mm) cushioned leather pad, steel sleeve, leg iron, gaff, split ring, and nylon calf and ankle straps.
- To determine size needed, measure from instep to 1" (25 mm) below knee.
- Sold in pairs only.

Cat. No.	Adjustable Length	Shipping Weight (lbs.)	Replacement Gaff Cat. No.	Replacement Pad Cat. No.	Replacement Calf Strap Cat. No.	Replacement Ankle Strap Cat. No.
CN1986AR	15" - 19" (381 mm - 483 mm)	6.20	86	8210	5301-18	5301-20
CN1986ARL	17" - 21" (432 mm - 533 mm)	6.35	86	8210	5301-18	5301-20



CN1986AR

Tree Climbers with 2-3/4" Gaffs – Complete Set

1907AR Series

- Extra-long gaffs for maximum penetration when climbing trees.
- Includes 8" x 8" (203 mm x 203 mm) cushioned leather pad, steel sleeves, leg iron, gaff, split ring, and nylon calf and ankle straps.
- To determine size needed, measure from instep to 1" (25 mm) below knee.
- Sold in pairs only.

Cat. No.	Adjustable Length	Shipping Weight (lbs.)	Replacement Gaff Cat. No.	Replacement Pad Cat. No.	Replacement Gaff Cat. No.	Replacement Ankle Strap Cat. No.
CN1907AR	15" - 19" (381 mm - 483 mm)	6.20	07	8210	5301-18	5301-20
CN1907ARL	17" - 21" (432 mm - 533 mm)	6.75	07	8210	5301-18	5301-20



CN1907AR

Pole Climbers Without Pads and Straps

- POLE CLIMBERS ONLY. Includes steel sleeve, leg iron, split ring, and gaff.
- To determine size needed, measure from instep to 1" (25 mm) below knee.
- Sold in pairs only.

Cat. No.	Adjustable Length	Shipping Weight (lbs.)	Replacement Gaff Cat. No.	Gaff Length
1972AR	15" - 19" (381 - 483 mm)	4.50	72	1-1/2" (38 mm)
1972ARL	17" - 21" (423 - 533 mm)	4.85	72	1-1/2" (38 mm)
1986AR	15" - 19" (381 mm - 483 mm)	4.50	86	1-9/16" (40 mm)
1907AR	15" - 19" (381 - 483 mm)	4.85	07	2-3/4" (70 mm)
1907ARL	17" - 21" (423 - 533 mm)	4.95	07	2-3/4" (70 mm)



1972AR



1986AR



1907AR

WARNING: For your protection, Klein recommends that climbers be replaced when original gaff and two replacement gaffs have been used on the climbers.

TORX® is a registered trademark of Acument Intellectual Properties, LLC.
All Klein climber straps are sold in pairs only.
All Klein ankle straps and pads are sold in pairs only.



Climber Accessories

Klein Velcro® – Climber Pads

NEW!

- 4" of Velcro provides the maximum amount of adjustability.
- Continuous wrap with metal cinch loop for quick attachment and ease of use.
- Extra wide cuff fastens around the calf to provide more support.
- Padded for additional comfort.

Cat. No.	Description	Weight (lbs.)
8220	8220L (left) 8220R (right) only sold in pairs	1.75

Velcro® is a registered trademark of Velcro Industries B.V.



8220

▲WARNING: It is important that users of this product read, understand, and follow all instructions, cautions and warnings that are attached to and/or packed with this product.

Climber Replacement Parts & Accessories

Replacement Gaffs and Accessories

- Replacement gaffs include, TORX® screws, and wrench.



86

Cat. No.	Description	Qty.	Shipping Weight (lbs.)
Replacement Pole Climbing Gaffs			
72*	1-1/2" (38 mm) Pole Climbing Gaffs (supplied with the 1972AR series)	2	.50
86*	1-9/16" (40 mm) Pole Climbing Gaffs (supplied with the 1986AR series)	2	.60
Replacement Tree Climbing Gaffs			
07*	2-3/4" (70 mm) Tree Climbing Gaffs (supplied with the 1907AR series)	2	.75
Gaff Accessories			
244	Long Gaff Screw (should be ordered with Cat. No. 247)	1	.01
247	Short Gaff Screw (should be ordered with Cat. No. 244)	1	.01
34910	Screw w/Lock Washer Set (for steel sleeve) (4) screws with lock washers and (4) T-nuts		.01

*Gaffs sold in pairs only.

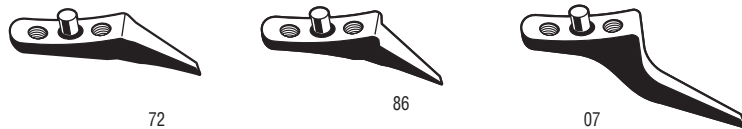

72

86

07

Gaff Gauge for Pole and Tree Climbers

- Convenient climber gaff guide assists with sharpening gaffs and checking proper gaff width, thickness, and point profiles.

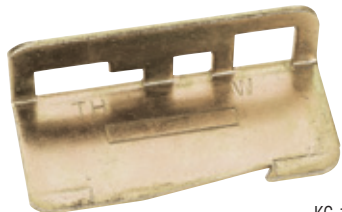

KG-1

Cat. No.	Description	Shipping Weight (lbs.)
KG-1	Gaff-sharpening kit for pole and tree climbers	.10

Gaff Sharpening Kit

- Handy kit contains: 8" fine-tooth file, 3" honing stone, Klein KG-1 gaff gauge, fully-illustrated gaff sharpening instructions, and canvas roll-up case.

Cat. No.	Shipping Weight (lbs.)
KG-2	.50



KG-2

▲WARNING: For your protection, Klein recommends that climbers be replaced when original gaff and two replacement gaffs have been used on the climbers.

TORX® is a registered trademark of Acument Intellectual Properties, LLC. All Klein climber straps are sold in pairs only. All Klein ankle straps and pads are sold in pairs only.



Climber Replacement Parts & Accessories

Snap-On Gaff Guard

- Coil-spring, plastic coated guard quickly snaps onto pole climbers.
- Sold in pairs only.



1972G

Cat. No.	Description	Shipping Weight (lbs.)
1972G	Snap-on gaff guards for pole climbers	.10

Removable Gaff Guard

- Long-lasting leather construction with easy-to-remove Velcro® strap.
- Sold in pairs only.



1945G

Cat. No.	Description	Shipping Weight (lbs.)
1945G	Gaff guards for pole and tree climber	.10

Climber Pads for Pole and Tree Climbers

- 3/4" (19 mm) thick cushioned right and left "L"-shaped leather pads.
- Sold in pairs only.

Cat. No.	Overall Size	Shipping Weight (lbs.)
8210	8" x 8" (20 x 20 cm)	.10



8210

Climber Straps for Pole and Tree Climbers



5301-18

- Durable neoprene-impregnated nylon strap is chemical/abrasion resistant and non-conductive.
- Tongue buckle has roller for easy adjustment.
- Sold in pairs only.

Cat. No.	Overall Size	Shipping Weight (lbs.)
5301-18	1" x 22" (25 mm x 56 cm)	.35
5301-20	1" x 26" (25 mm x 66 cm)	.40
5301-21	1-1/4" x 22" (32 mm x 56 cm)	.50
5301-22	1-1/4" x 26" (32 mm x 66 cm)	.46

Ankle Straps for Pole and Tree Climbers



5301-20

- Durable neoprene-impregnated nylon strap is chemical/abrasion resistant and non-conductive.
- Tongue buckle has roller for easy adjustment and a comfortable leather buckle pad.
- Sold in pairs only.

Cat. No.	Overall Size	Shipping Weight (lbs.)
5301-20	1" x 24" (25 mm x 61 cm)	.50
5301-23	1-1/4" x 24" (32 mm x 61 cm)	.70

▲WARNING: For your protection, Klein recommends that climbers be replaced when original gaff and two replacement gaffs have been used on the climbers.

All Klein climber straps are sold in pairs only.
All Klein ankle straps and pads are sold in pairs only.



Warning Tags & Labels – Pole and Tree Climbers

Pole and Tree Climber Catalog Numbers

KG-1, KG-2, 07, 72, 86, 1907AR, CN1907AR, 1907ARL, CN1907ARL, 1945G, 1972G, 1972AR, CN1972AR, 1972ARL, CN1972ARL, 1972G, 1986AR, CN1986AR, 1986ARL, CN1986ARL, 5301-18, 5301-19, 5301-20, 5301-21, 5301-22, 5301-23, 8210

- Climbing equipment is for use **by properly trained professionals only.**
- **Use climbing equipment only** for the specific purpose for which it is designed and intended.
- **Klein Tools recommends a combined body, clothing and tool weight of 300 pounds or less for use with our pole and/or tree climbers.**
- **Always visually check that** all buckles are properly closed before use.
- **Before each use check that:** 1) gaffs are free of dents, gouges or scratches 2) gaffs have proper width, thickness, point profile and sharpness. **Only evaluate gaffs with Klein KG-1 gaff gauge.** 3) **Resharpener, or discard and replace gaffs if they fail inspection.**
- **Before each use check that:** 1) climber straps and pads are free of burns, cuts, broken stitches or excessive wear, 2) rivets are not bent, loose or missing, 3) buckles are not distorted or cracked, tongue does not bind on buckle and buckle holes are not damaged.
4) **Remove from service, destroy and discard item if it fails inspection and replace immediately.**
- **Never** allow this equipment to come in contact with fire, high-temperature surfaces, welding sparks, or other heat sources.
- **Never** punch holes in or alter a strap or climber.
- **For leather components:** Leather is subject to deterioration by cracking, wearing thin, tearing, weakening and chemical attack. Carefully maintain with Neat's-foot oil or equivalent. Inspect straps for these conditions before each use. **Remove from service, destroy and discard strap if it shows any signs of deterioration and replace immediately.**
- **While climbing,** avoid gaff contact with metal, such as pole hardware, tags, nails, poster staples, etc.
- Poles are **NOT** all alike. Different wood species, climate, pole age, and preservative treatments (Creosote, Penta, CCA) affect climbability, resulting in significant differences in gaff penetration. **Visually check gaff penetration with your full weight on the climber before any climb. If penetration is shallow, use extreme caution.** The gaff could "cut-out," or the increased stress could lead to tip breakage. **For proper penetration,** the minimum underside length of a pole climber gaff is 1-7/16" (37 mm).
- Trees are **NOT** all alike. Different species and bark thickness affect climbability. **Visually check gaff penetration** as described for pole climbers before any climb. **For proper penetration:** 1) Use a tree-climber gaff with a minimum underside length of 2-1/4" (57 mm). 2) When bark thickness measures more than 2-1/2" (64 mm), make sure gaff has adequate length for proper penetration of wood under the bark.
- After climbs, remove climbers to avoid gaff damage from hard surfaces or each other while walking.
- Use gaff guards to protect gaffs between uses.
- Limiting gaff replacement on climbers to two times is **highly recommended.**
- **Employer-** instruct employee as to proper use and warnings before use of equipment.
- **Read, understand and follow** all information provided with climber before use.



Pole & Tree Climbers Inspection Procedures

General

- 1. Check for wear and deterioration.** Before each use, carefully inspect the complete system for signs of wear, deterioration, or evidence of impact loading. Visually inspect for loose threads, pulled rivets, cuts, abrasions, or other evidence of chemical or physical deterioration that may have weakened the material or assembly.
- 2. Inspect hardware for malfunctions or cracks.** Check all hardware, including rivets and buckles.
- 3. Destroy and replace all worn or damaged equipment.** Immediately destroy and replace any component that does not pass inspection.

Specific

1. Check straps and pads. Make sure straps and pads are free of tears, burns, broken stitches, or excessive wear. Since leather is subject to deterioration, carefully check for cracking, wearing thin, tearing, weakening, chemical attack, or other signs of deterioration. (See Fig. 1)

2. Check rivets, buckles, and other metal parts. Check that rivets are not bent, loose, or missing. Check that all buckles are not distorted or cracked, tongue does not bind on buckle, and buckle holes are not damaged. Also check split ring, leg iron, and steel sleeve for signs of excessive wear or damage. (See Fig. 2)

3. Check gaffs. Check that gaffs are free of dents, gouges, or scratches.

4. Check gaff thickness with Klein gaff gauge. For **pole gaffs** only, insert the gaff as far as possible through the large opening in the gauge marked "TH" (See Fig. 3). Make sure the top ridge is flush against the gauge base. The point of the gaff should fall within the limits formed by the last line and the edge of the gauge as illustrated. If it does, the gaff is the proper thickness, approximately 1" (25.4 mm) from the point. For **pole and tree gaffs**, insert gaff as far as possible through the small opening in the gauge marked "TH" (See Fig. 3). Make sure the top ridge is flush against the gauge base. The point should fall within the center two lines as illustrated. If it does, the gaff is the proper thickness, as measured approximately a 1/2" (12.7 mm) from the point.

5. Check gaff width with Klein gaff gauge. For **pole gaffs** only, insert gaff as far as possible through the large square opening in the gauge marked "W" (See Fig. 4). Make sure the top ridge is flush against the gauge base. The point should fall within the limits formed by the last line and the edge of the gauge as illustrated. If it does, the gaff is the proper width, approximately 1" (25.4 mm) from the point. For **pole and tree gaffs**, insert gaff as far as possible through the small opening in the gauge marked "W" (See Fig. 4). Make sure the top ridge is flush against the gauge base. The point should fall within the limits formed by the center two lines as illustrated. If it does, the gaff is the proper width, approximately a 1/2" (12.7 mm) from the point.

NOTE: See page 22 for remaining procedure steps.

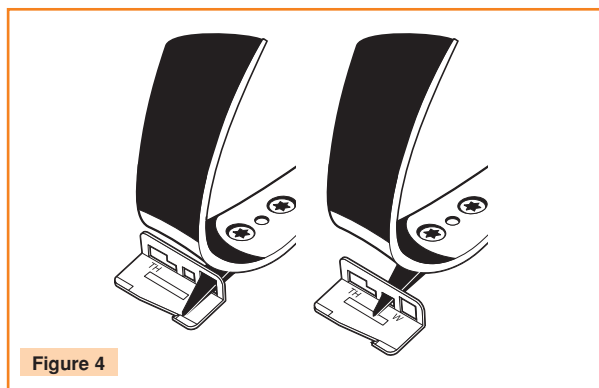
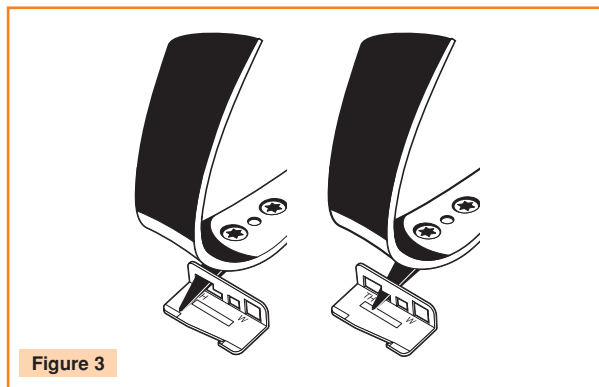
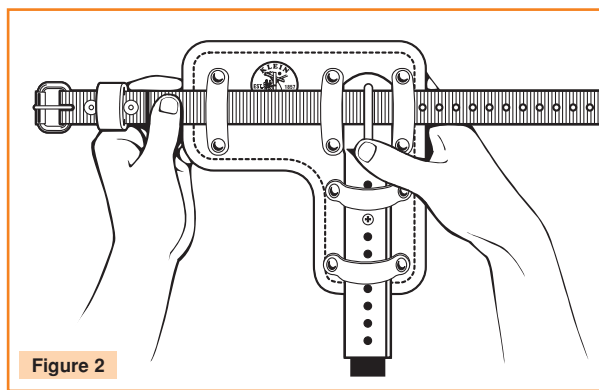
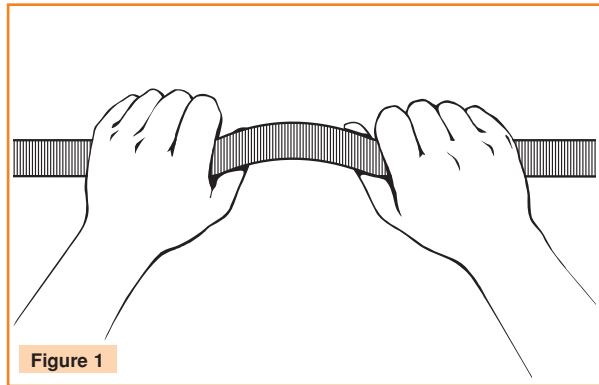

Pole & Tree Climbers Inspection Procedures

6. Check gaff profile/contour with Klein gaff gauge. For pole and tree gaffs, place the side of the gaff along the front edge of the gauge with the gaff point resting in the notch. The point should follow the configuration of the gauge to assure the proper “rounding off” of the tip within 1/4” (6.4 mm) of the point. (See Fig. 5)

Minimum safe length for a **pole-climbing gaff** is 1-7/16” (37.5 mm), measured on the underside of the gaff. Minimum safe length for a **tree-climbing gaff** is the greater of the following: A) 2-1/4” (57 mm), measured on the underside of the gaff, or B) long enough to penetrate the bark on the tree and properly penetrate the core of the tree. Always test the penetration of tree gaffs at the base of the tree before climbing to be sure gaffs extend through the bark and properly penetrate the core of the tree.

7. Check gaff sharpness with the “plane test.”

Step 1: Place climber with gaff pointing downward and upper strap loop resting against a horizontal board or pole. Hold the leg iron parallel to the wood surface with the stirrup vertical. Push the climber horizontally in the direction of the gaff without any downward pressure except the weight of the climber. (See Fig. 6)

Step 2: The gaff is properly sharpened if the gaff buries itself in the wood within a few inches of its starting position and can no longer be moved forward (See Fig. 7). The gaff is NOT properly sharpened if the gaff merely slips, slides, or plows a shallow groove in the wood (See Fig. 8). In this case, either replace the gaff following the “Replacement-Gaff Assembly Instructions” or resharpen the gaff following the “Gaff Sharpening Instructions.”

For free copies of instructions, call Klein Tools at **1-800-553-4676**. A resharpened gaff must be tested for proper width, thickness, and point profile, and it must also pass the “plane test” before use.

The “plane test” reveals possible penetration problems not noticeable to the naked eye. Figure 9 shows how a properly sharpened gaff cuts its way into the pole for proper support. Figure 10 shows how an improperly sharpened gaff can “cut-out.”

8. Destroy and replace all worn or damaged OPE equipment. If evidence of excessive wear, deterioration, or mechanical malfunction is observed, replace the equipment immediately. Never work with worn or damaged OPE equipment. Using damaged or worn equipment can cause serious injury or death.

9. The inspector is the most important part of the inspection. Check all equipment thoroughly, and follow all safety procedures and guidelines. Do not take any shortcuts.

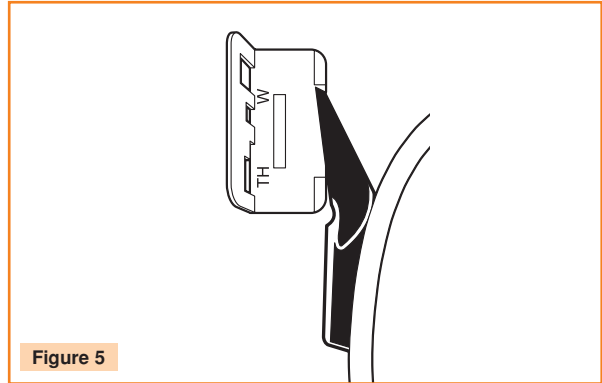

Figure 5

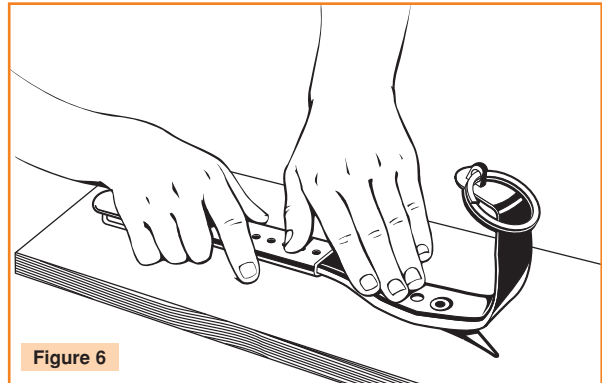
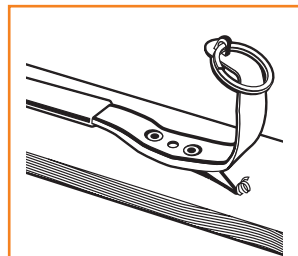
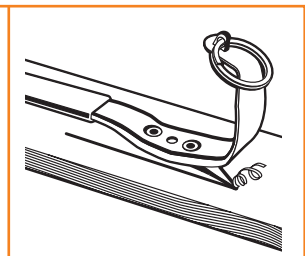

Figure 6



Correct

Figure 7



Incorrect

Figure 8

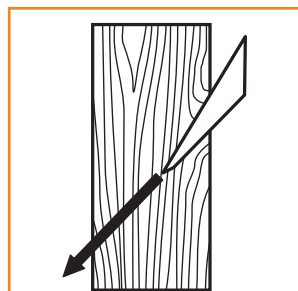

Correct

Figure 9

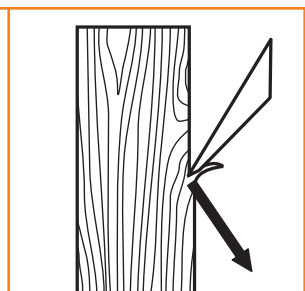

Incorrect

Figure 10



Block & Tackle

- These are NOT occupational protective devices. NOT for human support.
- Light, galvanized-steel shell blocks are fitted with snubbing hooks to hold the load.
- Sheaves are strong, yet are lightweight aluminum alloy with all-bronze bushings.
- Available with standard snap hooks or guarded snap hooks (with snap hook nose lengthened to extend over the latch or keeper).
- Choice of forged hook Cat. No. 258 or swivel hook Cat. No. 259.
- Hooks fit under insulator and engage pin on cross arm.
- All Klein Block & Tackle use high-quality, 3/8" diameter rope.
- Catalog numbers followed by S/R have rope spliced to block.
- Maximum safe load is 750 lbs. (338 kg).

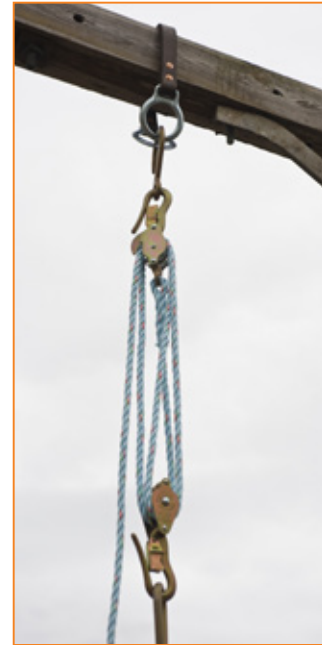

Block & Tackle with Standard Hooks

Cat. No.	Component Part Number			Rope spliced to component number	Weight (lbs.)
	267 Block	268 Block	258 Anchor Hook		
1802-30	•	•	•		2.80
1802-30 S/R	•	•	•	268 Block	2.80
1802-30S	•	•		•	2.85
1802-30S S/R	•	•		• 268 Block	2.85



258



268



267



259



268



267



1802-30

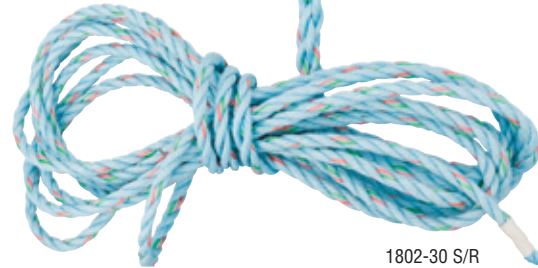

1802-30 S/R



259



268



267



259



268



267



1802-30S

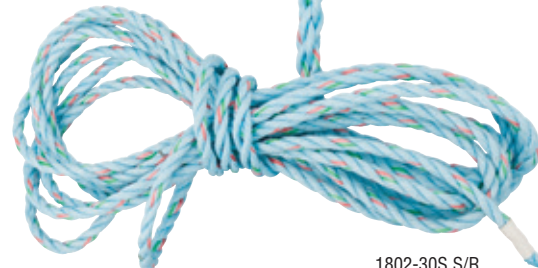

1802-30S S/R

All dimensions are in inches and (millimeters).

WARNING: These are NOT occupational protective devices. Do NOT use for human support.



Block & Tackle

Block & Tackle with Guarded Hooks



Cat. No.	Component Part Number				Rope spliced to component number	Weight (lbs.)
	H267 Block	H268 Block	258 Anchor Hook	259 Swivel Anchor Hook		
H1802-30	•	•	•			2.90
H1802-30 S/R	•	•	•		H268 Block	2.90
H1802-30 S	•	•		•		3.00
H1802-30S S/R	•	•		•	H268 Block	3.00



258 H268 H267



H1802-30



258 H268 H267



H1802-30 S/R



259 H268 H267



H1802-30S



259 H268 H267



H1802-30S S/R

All dimensions are in inches and (millimeters).

WARNING: These are NOT occupational protective devices. Do NOT use for human support.



Block & Tackle

Anchor Hook



258

- Forged hook is designed to slip under insulator and engage pin of cross arm.
- Maximum safe load 750 lbs. (340 kg).
- Standard on Klein block & tackle Cat. Nos. 1802-30 and H1802-30.

Cat. No.	Eye I.D.	Throat Opening	Overall Length	Weight (lbs.)
258	5/8" (16 mm)	1-7/8" (48 mm)	5-1/2" (140 mm)	.42

Swivel Anchor Hook



259

- Swivel clevis on this forged hook will engage with snap on Klein block & tackle Cat. Nos. 1802-30 and H1802-30.
- Swivel prevents twisting and kinking of rope.
- Maximum safe load 750 lbs. (340 kg).

Cat. No.	Swivel Opening	Throat Opening	Overall Length	Weight (lbs.)
259	1-3/16" x 1" (30 mm x 25 mm)	1-7/8" (48 mm)	6-1/2" (165 mm)	.40

Heavy-Duty Snap Hook

- Snaps on with one hand.
- Forged hook may be used on many conventional steel blocks, 4" (102 mm) or smaller.
- Maximum safe load 8000 lbs. (3629 kg).

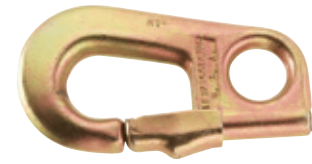

455

Cat. No.	Eye I.D.	Throat Opening	Overall Length	Weight (lbs.)
455	15/16" (24 mm)	1" (25 mm)	5" (127 mm)	.84

Blocks



267



268



H267



H268

- Blocks without ropes and hooks.
- Made of light galvanized steel and aluminum alloy.
- Sheaves have bronze bushings.

Cat. No.	Description	Weight (lbs.)
267	plain block	.76
H267	Cat. No. 267, but nose extends over keeper	.80
268	block with eye to splice line to block and rope tie-off	.91
H268	Cat. No. 268, but nose extends over keeper	1.00



H1802-30S



All dimensions are in inches and (millimeters).

WARNING: These are NOT occupational protective devices. Do NOT use for human support.



Block & Tackle

Polypropylene Hand-Lines with Snap Hook



1804-60

- Made of 5/16" (8 mm) three-strand polypropylene rope spliced to eye of snap hook.
- Both lines 75' (23 m) long.
- Forged steel with swivel clevis and quick-acting plunger-style latch.

Cat. No.	Description	Weight (lbs.)
1803-60	75' (23 m) of 5/16" (8 mm) rope with Cat. No. 443A snap. Maximum safe load 250 lbs. (113 kg)	2.45
1804-60	75' (23 m) of 5/16" (8 mm) rope with Cat. No. 470 swivel snap. Maximum safe load 250 lbs. (113 kg)	2.20

Snap Hook

- General-purpose forged snap hook with eye at 90° to opening.
- Maximum safe load 1500 lbs. (675 kg).



443A

Cat. No.	Eye I.D.	Throat Opening	Overall Length	Weight (lbs.)
443A	1" (25 mm)	1/2" (13 mm)	5-1/2" (140 mm)	.52

Swivel Hook with Plunger Latch

- Forged steel with swivel clevis and quick-acting plunger-style latch.
- Designed to take 1/2" (13 mm) or lighter hand lines.
- Swivel action prevents accidental fouling into secondary wires.
- Maximum safe load 750 lbs. (338 kg).



470

Cat. No.	Swivel Opening	Throat Opening	Overall Length	Weight (lbs.)
470	1-3/16" x 1" (30 mm x 25 mm)	5/8" (16 mm)	5" (127 mm)	.30

Howe Wire Tool



1702-20N

- Strap is made of Klein Kord®.
- Swivel hook is forged steel with large opening.
- Shank of hook is lengthened to reach under insulator.
- Other end has device to hold the load at any distance.
- All metal parts are galvanized.
- Max. safe load 500 lbs. (225 kg).

Cat. No.	Description	Weight (lbs.)
1702-20N	Klein Kord® Strap 1" (25 mm) wide, 7' (2.1 m) long	1.95



Howe Wire Tool



Howe Wire Tool

All dimensions are in inches and (millimeters).

⚠WARNING: These are NOT occupational protective devices. Do NOT use for human support.



Lineman Buckets, Bags & Holders

Klein lineman buckets, bags and accessories have been trusted and recognized for decades for their durability and dependability. They are built for strength and to handle professional wear and tear.



Lineman Buckets,
Bags & Holders



Canvas Buckets

Features:

Rope handle reinforced with leather for water resistance and strength.

Durable, straight-wall and tapered-wall buckets are made of heavy-duty canvas.

The No. canvas refers to the canvas weight. No. 1 being the thickest and No. 8 being the thinnest.

High-density polyethylene top ring for strength and chemical resistance.



Leather-Bottom Buckets

Additional Features:

- No. 1 canvas.
- Leather reinforced bottom.
- Leather cuff extends 3" (76 mm) up the side.
- Inside pocket measures 8" x 8" (203 mm x 203 mm).
- Rope handle.



5104

Straight-Wall Buckets

Additional Features:

- No. 6 canvas.
- Black molded polypropylene bottom.
- Rope handle.



5106

Cat. No.	Top Diameter	Bottom Diameter	Height	Extra Features	Weight (lbs.)
5104	12" (305 mm)	12" (305 mm)	17" (432 mm)		2.71
5104S	12" (305 mm)	12" (305 mm)	17" (432 mm)	swivel snap (Cat. No. 2012)	2.93

Cat. No.	Diameter	Height	Extra Features	Weight (lbs.)
5106	9" (229 mm)	14" (356 mm)		1.51
5106P	9" (229 mm)	14" (356 mm)	two 7" x 7" (178 mm x 178 mm) inside pockets	1.62
5106S	9" (229 mm)	14" (356 mm)	swivel snap (Cat. No. 2012)	1.80

Wide-Opening Straight-Wall Buckets

Additional Features:

- No. 6 canvas.
- Black molded polypropylene bottom.
- Rope handle.

Cat. No.	Diameter	Height	Extra Features	Weight (lbs.)
5109	12" (305 mm)	15" (381 mm)		2.06
5109P	12" (305 mm)	15" (381 mm)	one 8" x 8" (203 mm x 203 mm) inside pocket	2.12
5109S	12" (305 mm)	15" (381 mm)	swivel snap (Cat. No. 2012)	2.35
5109PS	12" (305 mm)	15" (381 mm)	one 8" x 8" (203 mm x 203 mm) inside pocket and swivel snap (Cat. No. 2012)	2.40



5109

All dimensions are in inches and (millimeters).



Canvas Buckets

Tapered-Wall Buckets

Additional Features:

- No. 6 canvas.
- Black molded polypropylene bottom.
- Rope handle.



5113

Cat. No.	Top Diameter	Bottom Diameter	Height	Extra Features	Weight (lbs.)
5113	12" (305 mm)	9" (229 mm)	13" (330 mm)		1.55
5113S	12" (305 mm)	9" (229 mm)	13" (330 mm)	swivel snap (Cat. No. 2012)	1.84

Heavy-Duty Tapered-Wall Bucket

Additional Features:

- Tough No. 4 canvas.
- Black molded polypropylene bottom.
- Rope handle.
- Riveted leather glove strap.
- Equipped with Cat. No. 2012 swivel snap hook.



5103S

Cat. No.	Top Diameter	Bottom Diameter	Height	Extra Features	Weight (lbs.)
5103S	12" (305 mm)	9" (229 mm)	12" (305 mm)	swivel snap (Cat. No. 2012)	1.95

Heavy-Duty Tapered-Wall Buckets with Pockets

Additional Features:

- Tough No. 4 canvas.
- Black molded polypropylene bottom.
- Rope handle.
- Riveted leather glove strap.
- Equipped with Cat. No. 2012 swivel snap hook.

Cat. No.	Top Diameter	Bottom Diameter	Height	Outside Pockets	Extra Features	Weight (lbs.)
5171PS	12" (305 mm)	9" (229 mm)	12" (305 mm)	4 outside pockets	swivel snap (Cat. No. 2012)	2.20
5172PS	12" (305 mm)	9" (229 mm)	12" (305 mm)	15 inside pockets	swivel snap (Cat. No. 2012)	2.35



5171PS

5172PS

Oval Bucket with 41 Pockets

Additional Features:

- No. 6 canvas.
- Black molded polypropylene bottom.
- Sisal-Rope handle.
- Equipped with Cat. No. 2012 swivel snap hook.
- Tripod suspension rope for greater stability.
- 26 pockets inside and 15 pockets outside.

Cat. No.	Length	Width	Height	Pockets	Extra Features	Weight (lbs.)
5152S	14" (356 mm)	7" (177 mm)	10" (254 mm)	26 inside pockets 15 outside pockets	swivel snap (Cat. No. 2012)	2.46



5152S

Oval Bucket with 15 Interior Pockets

Additional Features:

- No. 6 canvas.
- Black molded polypropylene bottom.
- Sisal-Rope handle.
- Equipped with Cat. No. 2012 swivel snap hook.
- Tripod suspension for greater stability.

Cat. No.	Length	Width	Height	Pockets	Extra Features	Weight (lbs.)
5144S	14" (356 mm)	7" (177 mm)	10" (254 mm)	15 inside pockets	swivel snap (Cat. No. 2012)	2.17



5144S

All dimensions are in inches and (millimeters).



Canvas Buckets

Aerial-Basket Oval Bucket with 15 Interior Pockets

Additional Features:

- No. 6 canvas.
- Black molded polypropylene bottom.
- Two nylon 66 polymer hooks (Cat. No. 5144H) supplied with Cat. No. 5144.



5144



Cat. No.	Length	Width	Height	Pockets	Extra Features	Weight (lbs.)
5144	14" (356 mm)	7" (177 mm)	10" (254 mm)	15 inside pockets	two hooks (Cat. No. 5144H)	2.01
5144B	14" (356 mm)	7" (177 mm)	10" (254 mm)	15 inside pockets		1.5

Aerial-Basket Tool Carrier

- Heavy-duty vinyl.
- Equipped with tool loops, tool holster, knife sheath, and small parts bag to keep tools organized.
- Hangs inside aerial basket to make tools readily available.
- Stiffening rod across the top holds carrier straight.
- Replacement hooks available Cat. No. 5144H.

Cat. No.	Height	Width	Weight (lbs.)
5169	21" (533 mm)	19" (483 mm)	2.85



5169



Line-Hose Bag

- No. 6 canvas with Cyclac top ring and molded bottom.
- Large enough to accommodate several pieces of hose.
- Can also be used to raise protective rubber blankets that are rolled.
- Leather cuff extends 3" (76 mm) up the side.
- Polypropylene rope handle is reinforced with leather.

Cat. No.	Diameter	Depth	Weight (lbs.)
5110-48	7" (178 mm)	48" (1219 mm)	1.91



5110-48

All dimensions are in inches and (millimeters).



Canvas Buckets

Canvas Tapered-Bottom Bag

- No. 10 canvas.
- Two pockets are provided for small parts.
- Bottom is tapered so parts will stay in center.
- Equipped with a snap for hanging.

Cat. No.	Diameter	Depth	Weight (lbs.)
5143	6-1/2" (165 mm)	8" (203 mm)	.30



5143

Canvas Electrode Bag

- Made of tough No. 4 canvas.
- Heat-resistant, hard leather bottom.
- Web loop for sliding over belt.

Cat. No.	Diameter	Front Depth	Back Depth	Weight (lbs.)
5471	2-1/2" (64 mm)	12" (305 mm)	15-1/2" (394 mm)	.25



5471

Hooks

Swivel Snap Hook

Additional Features:

- This is NOT an occupational protective hook. NOT for human support.
- Bronze swivel snap hook made for use on canvas buckets.
- Maximum safe load is 150 lbs. (68 kg).

Cat. No.	Length	Width	Weight (lbs.)
2012	4-3/8" (111 mm)	1-5/8" (41 mm)	.28



2012

Hook for Aerial-Baskets

- All weather, durable, nylon 66 polymer.
- Most manufacturers' aerial basket trucks accommodate bucket hook.
- Replacement hook for both Cat. No. 5144 and Cat. No. 5169.

Cat. No.	Weight (lbs.)
5144H	.30



5144H

Slings

Pole Sling



5606

- For use where a running loop wrap around pole is desired.
- Nylon web stitched with nylon thread.
- Copper rivets with burrs at the point of wear.
- NOT an occupational protective device. NOT for human support.
- Resistant to oil, creosote, and moisture.

Cat. No.	Rated Capacity (Maximum Working Load)		Overall Length	Width	Weight (lbs.)
	Choke Hitch	Basket Hitch			
5606	3000 lbs (1350 kg)	4700 lbs (2115 kg)	39" (991 mm)	2" (51 mm)	1.33



Crossarm Sling



5607

- Made of 12 plies of nylon laminated together with neoprene and pre-formed prior to vulcanization for ease in placing around the crossarm.
- D-rings are 1/4" (6 mm) welded wire securely riveted with copper rivets and burrs.
- NOT an occupational protective device. NOT for human support.
- Resistant to oil, creosote, and moisture.

Cat. No.	Rated Capacity (Maximum Working Load)		Overall Length	Width	Weight (lbs.)
	Basket Hitch	Basket Hitch			
5607	1000 lbs (450 kg)	1000 lbs (450 kg)	23-1/4" (590 mm)	1" (25 mm)	.83



All dimensions are in inches and (millimeters).

⚠WARNING: This is NOT an occupational protective device. NOT for human support.



Tool Bags

Canvas Tool Bags

- Heavy-duty No. 8 natural canvas.
- Rivet-reinforced for durability.
- Steel-frame mouth with hinge for rugged use.
- Stitched and riveted leather handles for comfort and strength.
- Two retaining straps with buckles provide secure closure.
- Bottom and lower sides are covered with moisture-resistant vinyl.
- Non-scratch studs on base protect against wear.
- Shoulder strap kit available (Cat. No. 5102S).



5102-12

Cat. No.	Length	Width	Height/Depth	Weight (lbs.)
5102-12	12" (305 mm)	6" (152 mm)	10" (254 mm)	2.14
5102-14	14" (356 mm)	6" (152 mm)	14" (356 mm)	2.55
5102-16	16" (406 mm)	6" (152 mm)	14" (356 mm)	3.05
5102-18	18" (457 mm)	6" (152 mm)	14" (356 mm)	2.84
5102-20	20" (508 mm)	6" (152 mm)	15" (381 mm)	3.16
5102-22	22" (559 mm)	6" (152 mm)	15" (381 mm)	3.48
5102-24	24" (610 mm)	6" (152 mm)	15" (381 mm)	4.10

High-Bottom Canvas Tool Bags

- Heavy-duty No. 8 natural canvas.
- Bottom and 8" (203 mm) of lower sides are covered with moisture-resistant vinyl.
- Non-scratch studs on base protect against wear.
- Steel-frame mouth with hinge for rugged use.
- Harness-leather handles with two retaining straps and buckles.
- Retro-fit bags with shoulder strap kit (Cat. No. 5102S). Kit includes leather strap with pad and snap hooks, rings and fasteners for attaching rings to bags.



5105-20

Cat. No.	Length	Width	Height/Depth	Weight (lbs.)
5105-20	20" (508 mm)	6" (152 mm)	15" (381 mm)	3.55
5105-24	24" (610 mm)	6" (152 mm)	15" (381 mm)	4.00

Canvas Tool Bags – Multiple Pockets, Leather Bottom

- Steel-frame mouth with hinge for rugged use.
- Internal pockets in a variety of sizes.
- External pocket for additional carrying needs.
- Constructed of strong No. 8 natural canvas.
- Reinforced bottom supports heavy tools, blocks moisture, and provides durability at wear points.
- Wide opening provides easy access to large tools.
- Bottom is protected from the elements by 6 studs.
- Includes: Shoulder strap mounts, (optional shoulder strap available, Cat. No. 58889) external pocket, leather bottom and 3" (76 mm) of sides covered with black leather, 2" (51 mm) wide web handles, leather handle wrap, and external tool loop handle in the webbing.



5003-16

Cat. No.	Length	Width	Height/Depth	Interior Pockets	Exterior Pockets	Retaining traps	Weight (lbs.)
5003-18	18" (457 mm)	6" (152 mm)	14" (356 mm)	10	1	1	4.14
5003-20	20" (508 mm)	6" (152 mm)	15" (381 mm)	14	1	2	4.38

All dimensions are in inches and (millimeters).



Tool Bags

Cordura® Ballistic Nylon Tool Bag

- Cordura® ballistic nylon, a high-performance fabric resistant to abrasions, tears and scuffs.
- Molded bottom made with a durable impact modified polypropylene.
- Eight interior and two exterior pockets hold a wide assortment of hand tools and supplies.
- Large opening with reinforced steel frame maintains the bag's shape while loading and unloading.
- Heavy-duty nylon zipper closure and a large leather zipper-pull assure easy operation.
- Box-stitched 2" (51 mm) wide polypropylene padded carrying handles with comfortable leather wrap.
- Optional padded, slip-resistant adjustable shoulder strap (Catalog No. 58889) for hands-free mobility is available.



5200-15

Cat. No.	Length	Width	Height/Depth	Weight (lbs.)
5200-15	15" (381 mm)	8" (203 mm)	14-1/2" (368 mm)	3.59

Cordura® is a registered trademark of INVISTA for durable fabrics.

Extra-Large Nylon Equipment Bag

- Orange vinyl-coated nylon fabric bag.
- Bottom extends 3" (76 mm) up the sides.
- Bottom of bag is protected by metal studs.
- Bottom reinforced with 1/4" (6 mm) plywood.
- Nylon-web handles extend around bag for extra support.
- Wide opening steel frame is securely riveted in top of bag.
- Extra flap for storm protection.



5180

Cat. No.	Length	Width	Height/Depth	Weight (lbs.)
5180	24" (610 mm)	10" (254 mm)	18" (457 mm)	6.00

Tool Totes™

- Constructed of rugged, 600 x 300 denier polyester to resist wear and tear on the jobsite.
- 2" wide (51 mm), polypropylene padded carrying handles with comfortable leather wrap.
- Water-resistant to avoid the build-up of mold and mildew.
- Exterior pockets hold a variety of tools and a mobile phone.
- Multiple interior pockets and a large interior compartment for a wide assortment of tools and supplies (only with 58888 and 58890).
- Durable molded bottom with drain holes to prevent water retention.
- Contoured, padded, slip-resistant shoulder strap for hands-free mobility (included with 58888 and 58890).
- Heavy-duty chain tape thong (58890 only).



58890

Cat. No.	Interior Pockets	Exterior Pockets	Chain Tape Thong	Shoulder Strap (58889)	Length	Width	Height/Depth	Weight (lbs.)
58886	-	7	No	No*	15-1/2" (394 mm)	7-1/2" (191 mm)	10" (254 mm)	2.42
58888	5	7	No	Yes	15-1/2" (394 mm)	7-1/2" (191 mm)	10" (254 mm)	3.01
58890	7	10	Yes	Yes	15-1/2" (394 mm)	7-1/2" (191 mm)	10" (254 mm)	3.41

*Optional shoulder strap (Cat. No. 58889) available.

All dimensions are in inches and (millimeters).



Tool Bags

Ten-Compartment Drawstring Bag

- 12-oz. olive canvas.
- Ten compartments to hold small parts.
- Drawstring for easy closing.

Cat. No.	Diameter	Height/Depth	Weight (lbs.)
5151	11" (279 mm)	6" (152 mm)	.41



5151

Glove Bags – Canvas

- Made of durable canvas.
- Has an expansion gusset, 5-1/2" (140 mm) across the top and 2-3/4" (70 mm) at bottom.
- Brass grommets in bottom for ventilation.
- Supplied with two-way snap.
- Includes safety notice to remind workers of the importance of using gloves.

Cat. No.	Canvas	Length	Width	Top Depth	Bottom Depth	Weight (lbs.)
5121-15	No. 4	15" (381 mm)	8" (203 mm)	5-1/2" (140 mm)	2-3/4" (70 mm)	.74
5121-19	No. 4	19" (483 mm)	8" (203 mm)	5-1/2" (140 mm)	2-3/4" (70 mm)	.88
5124-15	No. 8	15" (381 mm)	8" (203 mm)	5-1/2" (140 mm)	2-3/4" (70 mm)	.64
5124-17	No. 8	17" (432 mm)	8" (203 mm)	5-1/2" (140 mm)	2-3/4" (70 mm)	.70
5124-19	No. 8	19" (483 mm)	8" (203 mm)	5-1/2" (140 mm)	2-3/4" (70 mm)	.77



5121-15

Combination Glove and Sleeve Bags

- Panels are tough No. 4 canvas.
- Provides separate storage for gloves and sleeves.
- Brass grommets in bottom for ventilation.
- Bags are 8" (203 mm) wide.
- Supplied with two-way snap.
- Includes safety notice to remind workers of the importance of using gloves.

Cat. No.	Length	Width	Bottom Depth	Weight (lbs.)
5122-16	16" (406 mm)	8" (203 mm)	4-13/16" (122 mm)	.98
5122-18	18" (457 mm)	8" (203 mm)	4-13/16" (122 mm)	1.05



5122-16

Zipper Bags



5139



5139B



5139C

- Constructed of No. 10 canvas with heavy-duty brass zipper.
- Convenient storage for pliers, wrenches, screwdrivers, nut drivers, other tools, and spare parts.
- Constructed of Cordura® ballistic nylon, a high-performance fabric resistant to abrasions, tears, and scuffs (Cat. Nos. 5139B, 5139, 5139C).
- Heavy-duty nylon zipper. (Cat. Nos. 5139B, 5139).
- Features the jungle stalker digitized camouflage pattern for maximum concealment (Cat. Nos. 5139C).
- Heavy-duty nylon stitching and zipper ensure durability and long life (Cat. Nos. 5139C).

Cat. No.	Material	Length	Height	Weight (lbs.)
5139	canvas	12-1/2" (318 mm)	7" (178 mm)	.19
5336	canvas	17" (432mm)	12" (305 mm)	.40
5139B	Cordura® Ballistic Nylon	12-1/2" (318 mm)	7" (178 mm)	.24
5236	Cordura® Ballistic Nylon	17" (432 mm)	12" (305 mm)	.51
5139C	Cordura® Camouflage	12-1/2" (318 mm)	7" (178 mm)	.14

Cordura® is a registered trademark of INVISTA for durable fabrics.

All dimensions are in inches and (millimeters).



Tool Bags

Zipper Bags – Canvas, 4-Pack

- Includes four assorted colors (olive, orange, royal-blue, and yellow) to organize and categorize important tools.
- Constructed of No. 10 canvas with heavy-duty brass zipper.
- Convenient storage for pliers, wrenches, screwdrivers, nut drivers, other tools and spare parts.
- Overall size: 12-1/2" (318 mm) long x 7" (178 mm) high.



5140

Cat No.	Description	Weight (lbs.)
5140	4 zipper bags - canvas	.80

Tool Pouches

Extra-Large Canvas Utility Bag

- Heavy No. 8 natural canvas.
- Includes interior pocket.
- Inside bottom is reinforced with cushion leather & ventilating eyelet.
- Metal snaps provided on loops for easy attachment to belts up to 3" (76 mm) wide.
- Top edge reinforced with 1/4" (6 mm) rope.



5141P

Cat. No.	Belt Connection	Belt Capacity	Length	Width	Depth	Weight (lbs.)
5141P	loops	up to 3" (76 mm) wide	10" (254 mm)	12" (305 mm)	5" (127 mm)	.88

Canvas Utility Bags

- Heavy No. 8 natural canvas.
- Top edge reinforced with 1/4" (6 mm) rope.
- Metal snaps provided on loops for easy attachment to belts up to 3" (76 mm) wide.
- Inside bottom is reinforced with cushion leather & ventilating eyelet.
- Cat. No. 5142P version includes interior pocket.



5142

Cat. No.	Belt Connection	Belt Capacity	Length	Width	Top Diameter	Weight (lbs.)
5142	loops	up to 3" (76 mm) wide	9" (229 mm)	10" (254 mm)	8" x 3" (203 mm x 76 mm)	.60
5142P	loops	up to 3" (76 mm) wide	9" (229 mm)	10" (254 mm)	8" x 3" (203 mm x 76 mm)	.65

Bull-Pin and Bolt Bags

- No. 4 canvas or split-leather with double bottom.
- Bolt bag with bull-pin loop on each side.

Cat. No.	Belt Connection	Belt Capacity	Length	Width	Depth	Weight (lbs.)
Canvas						
5416	loops	up to 3" (76 mm) wide	5" (127 mm)	9" (229 mm)	10" (254 mm)	.85
5416T	tunnel	up to 3" (76 mm) wide	5" (127 mm)	9" (229 mm)	10" (254 mm)	.90
Leather						
5416L	tunnel	up to 3" (76 mm) wide	5" (127 mm)	9" (229 mm)	10" (254 mm)	1.10



5416



5416L

All dimensions are in inches and (millimeters).



Tool Holders

Scissors Holder – Tunnel

- Leather construction.
- Designed for Klein electrician's scissors, Cat. Nos. 2100-5 and 2100-7.
- Riveted and stitched for extra durability.



5100M

Cat. No.	Belt Connection	Belt Width	Overall Size	Weight (lbs.)
5100M	tunnel	up to 2" (50.8)	Medium	3.2

Scissors Holder – Slotted

- Leather construction.
- Riveted with clip on back for attaching to belt.
- Designed to hold Klein electrician's scissors, Cat. Nos. 2100-5 and 2100-7.
- Riveted to assure long life.



5101

Cat. No.	Belt Connection	Belt Width	Overall Size	Weight (lbs.)
5101	metal clip	up to 1-1/2" (38 mm)	2" x 7" (51 mm x 178 mm)	.11

Scissors and Cable-Splicer's Knife Holders

- Leather construction.
- Specially designed to hold a pair of Klein electrician's scissors (Cat. Nos. 2100-5 or 2100-7), and Cat. No. 44200 cable-splicer's knife.
- Riveted and stitched for extra durability.

Cat. No.	Belt Connection	Belt Width	Overall Size	Weight (lbs.)
5187	slotted	up to 2-1/4" (57 mm)	2" x 7-1/4" (51 mm x 184 mm)	.11
5187T	tunnel	up to 2-1/4" (57 mm)	2" x 7-1/4" (51 mm x 184 mm)	.13



5187



5187T

Knife Holder

- Leather construction.
- Designed for utility knives and Klein Cat. Nos. 44100 and 44105.
- Corners riveted and stitched for extra durability.



5185

Cat. No.	Belt Connection	Belt Width	Overall Size	Weight (lbs.)
5185	slotted	up to 2-1/2" (64 mm)	2-5/8" x 8-1/4" (67 mm x 210 mm)	.11

Lineman's Knife Holder

- Leather construction.
- Designed for Klein skinning knives Cat. Nos. 1570-3, 1570-3LR, and 1560-3.
- Riveted to assure long life.



5163

Cat. No.	Belt Connection	Belt Width	Overall Size	Weight (lbs.)
5163	slotted	up to 2" (51 mm)	3-1/2" x 9-3/8" (89 mm x 238 mm)	.21

Cable-Splicer's Knife Holders

- Leather construction.
- Designed to hold Cat. No. 44200 cable-splicer's knife.
- Riveted and stitched for extra durability.

Cat. No.	Belt Connection	Belt Width	Overall Size	Weight (lbs.)
5188	slotted	up to 2-1/4" (57 mm)	2-1/8" x 7-3/4" (54 mm x 197 mm)	.08
5188T	tunnel	up to 2-1/4" (57 mm)	2-1/8" x 7-1/4" (54 mm x 184 mm)	.11



5188



5188T

All dimensions are in inches and (millimeters).



Tool Holders

Two-Way Knife Snap

- Leather construction.
- Screw-type rivets for easy attachment to belts.



5131

Cat. No.	Belt Connection	Length	Weight (lbs.)
5131	screw rivets	4-1/2" (114 mm)	.10

Snap Loop

- Leather construction.
- Designed for tools with hang holes.
- Loop with snap hook for carrying an adjustable wrench, welder's igniter or other tool with hang hole.
- Riveted to assure long life.



5458

Cat. No.	Belt Connection	Belt Width	Overall Size	Weight (lbs.)
5458	slides on	up to 4" (102 mm)	1-1/2" x 8-1/2" (38 mm x 216 mm)	.15

Splitting-Knife Guards

- Leather construction.

Cat. No.	Description	Weight (lbs.)
5574L	leather splitting or chipping-knife guard. Fits Klein knife, Cat. No. 1515-1	.13
5574S	leather splitting or chipping-knife guard. Fits Klein knife, Cat. No. 1515-S	.05



5574L



5574S

Mobile Phone Holders

PowerLine Series

Additional Features:

- Fits most mobile phones.
- Metal belt clip for simple mounting and removal from belts up to 2" wide.
- Closable flap features genuine Velcro® brand touch fastener.
- Closed bottom for convenient storage.

Cat. No.	Size	Overall Dimensions		Pocket Dimensions			Weight (lbs.)
		H	W	H†	W	D	
5715XS	extra small	4-1/2" (114 mm)	2-5/8" (67 mm)	3" (76 mm)	2-1/8" (54 mm)	3/4" (19 mm)	.01
5715S	small	4-1/2" (114 mm)	2-5/8" (67 mm)	3-1/2" (89 mm)	2-1/8" (54 mm)	1" (25 mm)	.01
5715	large	6-1/2" (165 mm)	3-5/8" (92 mm)	5" (127 mm)	3-5/8" (79 mm)	1-1/4" (32 mm)	.014

Velcro® is a registered trademark of Velcro Industries B.V.

†Velcro latching cover accommodates phones slightly taller than pocket.



5715

Pliers Holders – Open Bottom

- Leather construction.
- Long-nose pliers may protrude through opening at bottom.
- Riveted to assure long life.
- Cat. No. 5107-6 holds 6" (152 mm) or 7" (178 mm) long-nose or diagonal-cutting pliers.
- Cat. No. 5107-9 holds 8" (203 mm) or 9" (229 mm) long-nose or diagonal-cutting pliers.



5107-6

Cat. No.	Belt Connection	Belt Width	Overall Size	Weight (lbs.)
5107-6	slotted	up to 2" (51 mm)	3-1/2" x 8-1/2" (89 mm x 216 mm)	.17
5107-9	slotted	up to 2" (51 mm)	3-3/4" x 11" (95 mm x 279 mm)	.26

Pliers Holder – Closed Bottom

- Leather construction.
- Nose of pliers does not protrude from closed bottom.
- Bottom is vented to prevent collection of dirt or water.
- Riveted to assure long life.
- Holds 7", 8", or 9" side-cutting pliers.



5112

Cat. No.	Belt Connection	Belt Width	Overall Size	Weight (lbs.)
5112	slotted	up to 2" (51 mm) wide	3-1/4" x 11" (83 mm x 279 mm)	.21

All dimensions are in inches and (millimeters).



Tool Holders

Pliers and Folding Rule Holders

- Leather construction.
- Riveted to assure long life.
- Pockets for 7", 8", or 9" side-cutting pliers and 6-ft. folding rule.

Cat. No.	Pockets (Total Number)	Belt Connection	Belt Width	Overall Size	Weight (lbs.)
5118R	2	slotted	up to 2" (51 mm)	4-3/4" x 8" (121 mm x 203 mm)	.43
5118RT	2	tunnel	up to 3-3/4" (95 mm)	4-1/2" x 12-1/2" (114 mm x 318 mm)	.50



5118R

5118RT

Tape Thong

- Leather strap with fiber bar.
- Fits all standard electrical tape rolls.

Cat. No.	Belt Connection	Length	Weight (lbs.)
5130	slotted	12" (305 mm)	.03



5130

Tool Pouches

4 and 5 Pocket Pouches

- Leather construction with double leather back for durability.
- Rivet hole for belt connection.
- Riveted to assure long life.
- Includes knife snap, pockets for pliers, most screwdrivers, 6' folding rule and open ended wrenches.

Cat. No.	Pockets (Total No.)	Belt Connection	Approx. Overall Size	Weight (lbs.)
5118P5	5	rivet hole	10" x 11" (254 mm x 279 mm)	1.13
5118P4	4	rivet hole	8" x 11" (203 mm x 279 mm)	.91



5118P5

5118P4

Pliers, Folding Rule, Screwdriver, and Wrench Holder

- Leather construction.
- No exposed rivets in back.
- Riveted to assure long life.
- Pockets for 7", 8", and 9" side-cutting pliers, most screwdrivers, 6' folding rules, and open-end wrenches from 9/16" to 13/16".
- Nickel plated alloy snap.



5118C

Cat. No.	Pockets (Total Number)	Belt Connection	Belt Width	Overall Size	Weight (lbs.)
5118C	4	slotted	up to 2" (51 mm)	6-1/2" x 11" (165 mm x 279 mm)	.78

Pliers, Rule, and Screwdriver Holders

- Leather construction.
- 3 pockets for pliers, folding rule, and screwdriver.
- S5118PRS has a two-way knife snap.
- Riveted to assure long life.
- Pockets for 7", 8", and 9" side-cutting pliers, most screwdrivers, 6' folding rules, and open end wrenches from 9/16" to 13/16".



5118PRS

Cat. No.	Belt Connection	Belt Width	Overall Size	Weight (lbs.)
5118PRS	slotted	up to 2" (51 mm)	6-3/4" x 10" (171 mm x 254 mm)	.49
S5118PRS	slotted	up to 2" (51 mm)	6-3/4" x 10" (171 mm x 254 mm)	.56

All dimensions are in inches and (millimeters).



Lineman's Tools

Klein Tools has established a reputation for manufacturing high quality tools to help linemen do their jobs. The company remains dedicated to making the best hand tools in the industry, and supporting linemen around the world with quality and reliability they can count on every day.



Lineman's Tools



Cable Cutters

Utility Cable Cutter

- Forged steel with black-oxide finish for long life.
- Shear-type hook jaws grab and hold cable while shear-cutting action makes clean cuts.
- Beveled tips for positive mating.
- Hinge bolt with pin-set nut for proper blade tension.
- Non-slip vinyl grips.
- Not designed for cutting steel or ACSR.



63035

Cat. No.	Overall Length	MCM Cable-Cutting Maximum Capacity	Handle Color	Weight (lbs.)
63035	16-3/4" (425 mm)	350 copper, 350 aluminum	red	1.70

Standard Cable Cutters

- Lightweight, yet efficient shear-type cable cutters.
- Replaceable hook-jaw blades grab and hold cable while shear-cutting action makes clean cuts.
- Exceptionally strong fiberglass handles with heavy vinyl grips for comfort and slip resistance.
- Heavy-duty pins in head serve as blade-stops.
- Jaws are forged tool steel with black-oxide finish for long life.
- Makes a clean, even cut for ease in fitting lugs and terminals.
- Beveled tips assure positive mating, and hinge on a rugged bolt with a pin-set nut to maintain proper blade tension.
- Communications Cable Cutter (Cat. No. 63047) cuts lead or rubber-covered communications cable.
- Not designed for cutting steel or ACSR.



63041

Cat. No.	Overall Length	Soft Cable-Cutting Maximum Capacity	MCM Cable-Cutting Maximum Capacity	Weight (lbs.)
63041	25-1/2" (648 mm)	1-3/8" (35 mm) diameter	500 copper, 750 aluminum	5.25
63045	32" (813 mm)	1-3/4" (44 mm) diameter	1000 copper, 1200 aluminum	8.00
63047	37" (940 mm)	900-pair soft copper and aluminum	up to 2-1/4" (57 mm) diameter	8.55
Replacement Cable Cutter Heads		Fits Klein Cat. No.		
63081		63041		2.05
63090		63045		3.30
63110		63047		3.50



Ratcheting Cutter – Heavy-Duty For Steel & ACSR

- Ratchet-action design provides maximum leverage with minimum effort for heavy-duty use.
- Cuts steel and ACSR.
- Forged, heat-treated, shear-type blades, plus 24" (609 mm) long steel handles with heavy vinyl grips for comfort and slip-resistance.
- Blade-advance knob for fast rotation of the blade to engage the cable or other material being cut, plus a quick-release mechanism allows for removal of the cable or rod before completion of the cut, if desired.
- Not designed for cutting EHS Guy Strand or reinforcement rod.



63700

Cat. No.	Overall Length	Soft Cable-Cutting Maximum Capacity	Communications Cable-Cutting Maximum Capacity	Weight (lbs.)
63700	36" (914 mm)	2-1/4" (57 mm) diameter	1-1/4" (32 mm) dia. ACSR, ACAR 7/16" (11 mm) dia. common guy strand 5/8" (16 mm) dia. steel wire rope 1/2" (13 mm) dia. steel rod (C.R.S. SOFT) 750 MCM (1-3/8" dia.) (35 mm) copper or aluminum	14.00

All dimensions are in inches and (millimeters).

⚠ WARNING: Do NOT use to cut steel or ACSR.

⚠ WARNING: Always wear approved eye protection.

⚠ WARNING: NOT insulated. Plastic-dipped or slip-on plastic handles are NOT intended for protection against electrical shock.



Cable Cutters

Ratcheting Cable Cutters

- High leverage ratchet mechanism for single-handed cutting of copper and aluminum cables, leaving no burrs or sharp edges.
- Patented two-step ratchet mechanism requires fewer strokes per cut (63060 and 63750).
- Quick release opens blades easily in every cutting position. (Allows removal of the cable before completion of cut).
- Precision ratcheting mechanism holds cable tight and allows rapid, straight cuts with minimum effort.
- Hardened steel cutting blades for lasting strength and sharpness.
- Plastic covered handles with hand guards for comfort and firm grip.
- Locking lever keeps handles closed for easy transport; fits in a toolbox or bag.
- One-year warranty.



63060

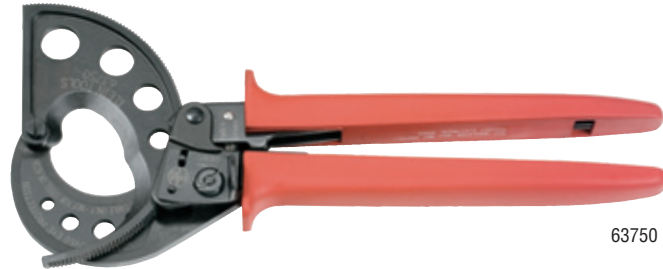

63750

⚠WARNING: Do NOT use to cut steel or ACSR.

Cat No	MCM Maximum Cable Capacity				Length	Weight (lbs.)
	Copper	Aluminum	Communication Cable			
63060	Maximum: 400 kcmil (MCM) (185 mm ²)	Maximum: 600 kcmil (MCM) (300 mm ²)	Maximum: 1-1/8" (28 mm)		10-1/4" (260 mm)	1.32 lbs. (600 g)
63750	Maximum: 1000 kcmil (MCM) (500 mm ²) Frequent Use: 750 kcmil (MCM) (400 mm ²)	Maximum: 1000 kcmil (MCM) (500 mm ²) Frequent Use: 750 kcmil (MCM) (400 mm ²)	Maximum: 2-1/16" (52 mm)		12-1/8" (308 mm)	1.76 lbs. (800 g)

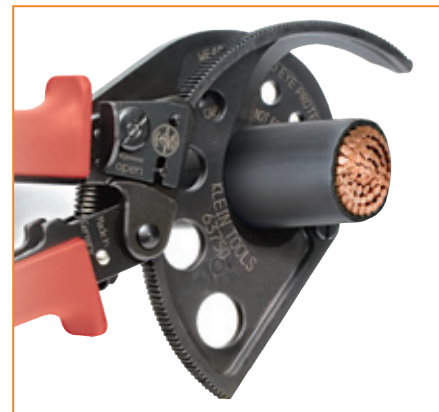

ACSR Ratcheting Cable Cutter

- Cutting inserts are easily replaced by simply removing 3 screws per blade.
- Capacity:
477 MCM ACSR
1-1/4" (32 mm) Ø CU-AL Stranded
1" (25 mm) Ø CU Solid
1/2" (13 mm) Ø Guy Strand (NOT FOR EHS)
- Tool can be locked when not in use.
- High leverage ratcheting mechanism for easier cutting.
- Plastic covered handles with hand guards for comfort and firm grip.
- At a length of just under 14" tool can be carried in a tool pouch.

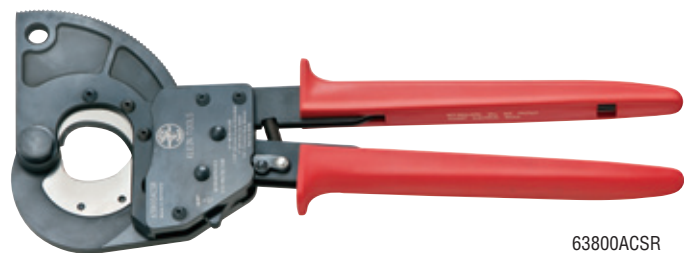

63800ACSR

Cat. No.	Cutting Capacity ACSR - Max.	Cutting Capacity Stranded Aluminum and Copper - Max.	Cutting Capacity Solid Copper - Max.	Cutting Capacity Guy Strand - Max.	Length	Weight (lbs.)
63800ACSR	477 MCM (273 mm ²)	1-1/4" (32 mm)	1" (25 mm)	1/2" (13 mm)	13-3/4" (349 mm)	3.2
Replacement Cutting Inserts (with set of 6 screws)		Fits Klein Cat. No.				
63858	63800ACSR					

All dimensions are in inches and (millimeters).

⚠WARNING: Always wear approved eye protection.

⚠WARNING: NOT insulated. Plastic-dipped or slip-on plastic handles are NOT intended for protection against electrical shock.



Bolt Cutters

Bolt Cutters

- Handles have heavy vinyl grips with flat grip ends for 90° cuts.
- All-purpose, center-cut jaws for soft, medium, and hard metals.
- Forged, alloy tool steel jaws are precision ground for sure, efficient cutting, and long life.
- Lockplate reinforcement prevents jaw bolts from loosening or turning, keeps jaws in correct alignment.
- One adjustment realigns cutting edges.
- 3-point toggle joint multiplies 50 lbs. of hand pressure on handles to 4,000 pounds at cutting jaws.



63124

Fiberglass Handles

Cat. No.	Handle Type	Overall Length	Soft & Medium Cutting Maximum Capacities*	Hard Material Cutting Maximum Capacities**	Handle Color	Weight (lbs.)
63118	fiberglass	18-1/4" (464 mm)	3/8" (10 mm)	1/4" (6 mm)	red	3.65
63124	fiberglass	24-1/2" (622 mm)	7/16" (11 mm)	5/16" (8 mm)	red	6.13
63130	fiberglass	30-1/2" (775 mm)	1/2" (13 mm)	3/8" (10 mm)	red	9.50
63136	fiberglass	36-1/2" (927 mm)	9/16" (14 mm)	7/16" (11 mm)	red	12.95

* Up to Brinell 300, Rockwell C31.

** Up to Brinell 400, Rockwell C42.

Replacement Fiberglass Handle Sets

Cat. No.	Fits Cat. No.	Weight (lbs.)
63119	63118	2.15
63131	63130	5.56
63137	63136	7.55



Bolt Cutters – Heavy-Duty

- Designed for constant use in the most demanding applications.
- Heavy-duty side plates keep jaws aligned for clean, quick cuts through reinforcing rod, wire mesh, guy strand, and many other materials too tough for standard bolt cutters.
- Steel handles and precision ground, forged alloy tool steel jaws.
- Lever design creates 4,000 lbs. jaw pressure with 50 lbs. hand pressure.
- Handles have heavy vinyl grips with flat grip ends for 90° cuts.

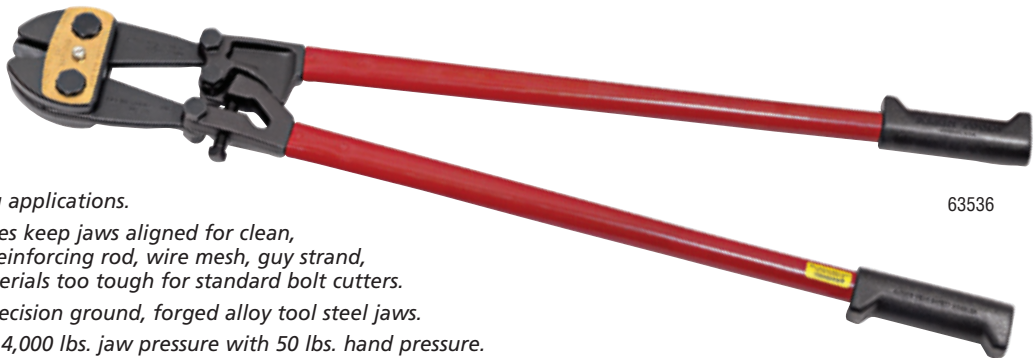

63536

Steel Handles

Cat. No.	Overall Length	Soft & Medium Cutting Maximum Capacities*	Hard Material Cutting Maximum Capacities**	Handle Color	Weight (lbs.)
63524	24" (610 mm)	7/16" (11 mm)	5/16" (8 mm)	red	7.10
63530	30" (762 mm)	1/2" (13 mm)	3/8" (10 mm)	red	11.65
63536	36" (914 mm)	9/16" (14 mm)	7/16" (11 mm)	red	16.35
63542	42" (1067 mm)	11/16" (18 mm)	1/2" (13 mm)	red	21.00

* Up to Brinell 300, Rockwell C31. ** Up to Brinell 400, Rockwell C42.

Replacement Bolt Cutter Heads (complete)

Cat. No.	Fits Cat. No.	Weight (lbs.)
63624	63524	2.75
63630	63530	4.80
63636	63536	6.50
63642	63542	8.70

All dimensions are in inches and (millimeters).

WARNING: Always wear approved eye protection.

WARNING: NOT insulated. Plastic-dipped or slip-on plastic handles are NOT intended for protection against electrical shock.



Cable Cutters

Features:

Custom, US-made tool steel.

Hot-riveted joint ensures smooth action and no handle wobble.

Through-hardened (not case-hardened) for longer-lasting cutting surfaces.

Beveled jaw tips provide proper mating and shearing action, which protects leading jaw edges.



High-Leverage Cable Cutter

JOURNEYMAN

Additional Features:

- Cuts up to 4/0 aluminum AWG (no ACSR), 2/0 AWG soft copper and 100-pair 24 AWG communications cable.
- High-leverage for greater cutting power.
- Precision, one-hand shearing action.



J63050

Cat. No.	Overall Length	Handle Finish	Handle Color	Weight (lbs.)
J63050	9-9/16" (243 mm)	Journeyman	red/black	.98

⚠WARNING: Do NOT use to cut steel or ACSR.

Side-Cutting Pliers

Features:

Custom, US-made tool steel.

"Handform" handles for full gripping and cutting power.

Plastic-dipped handles[†] for comfort and ease of identification.

Unique handle tempering helps absorb the "snap" when cutting wire.

Hot-riveted joint ensures smooth action and no handle wobble.

Induction hardened cutting knives for long life.

Precision-hardened plier head for on-the-job toughness.

2000 SERIES[®] pliers available. Cuts ACSR, screws, nails, and most hardened wire.

[†]Journeyman pliers available. State-of-the-art, dual-material handles, which provide a better grip without sacrificing tool strength or durability.

Sure-gripping cross-hatched knurled jaws.



All dimensions are in inches and (millimeters).

⚠WARNING: Always wear approved eye protection.

⚠WARNING: NOT insulated. Plastic-dipped or slip-on plastic handles are NOT intended for protection against electrical shock.



Side-Cutting Pliers

High-Leverage Side-Cutting Pliers – Heavy-Duty Cutting 2000 SERIES®

Additional Features:

- Cuts ACSR, screws, nails and most hardened wire.
- High-leverage design. Rivet is closer to the cutting edge for 46% greater cutting and gripping power than other plier designs.
- Streamlined design with sure-gripping, cross-hatched knurled jaws.
- Features combination polished and black-oxide finish.



D2000-9NE

Cat. No.	Nose Type	Overall Length	Jaw Length	Jaw Width	Jaw Thickness	Knife Length	Handle Finish	Handle Color	Weight (lbs.)
D2000-7	New England	7-7/8" (200 mm)	1-9/32" (33 mm)	1-1/32" (26 mm)	1/2" (13 mm)	3/4" (19 mm)	plastic-dipped	royal blue	.66
D2000-8	New England	8-11/16" (221 mm)	1-7/16" (37 mm)	1-7/64" (28 mm)	5/8" (16 mm)	3/4" (19 mm)	plastic-dipped	royal blue	.85
D2000-9NE	New England	9-3/8" (238 mm)	1-19/32" (41 mm)	1-1/4" (32 mm)	5/8" (16 mm)	25/32" (20 mm)	plastic-dipped	royal blue	1.09
HD2000-9NE	New England	9-1/2" (241 mm)	1-19/32" (41 mm)	1-1/4" (32 mm)	5/8" (16 mm)	25/32" (20 mm)	heavy-duty, oversized, plastic-dipped	light red	1.15

Journeyman 2000 Series – Dual-material handles

J2000-9NE	New England	9-1/2" (241 mm)	1-19/32" (41 mm)	1-1/4" (32 mm)	5/8" (16 mm)	25/32" (20 mm)	Journeyman	light blue/black	1.13
-----------	-------------	-----------------	------------------	----------------	--------------	----------------	------------	------------------	------

Refer to the insulated section for insulated pliers.

High-Leverage Side-Cutting Pliers

Additional Features:

- High-leverage design. Rivet is closer to the cutting edge for 46% greater cutting and gripping power than other plier designs.
- Sure-gripping, cross-hatched knurled jaws.

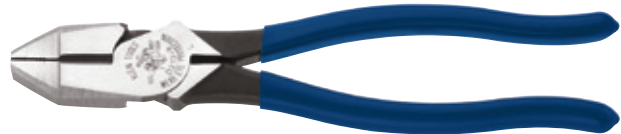

D213-9

Cat. No.	Nose Type	Overall Length	Jaw Length	Jaw Width	Jaw Thickness	Knife Length	Handle Finish	Handle Color	Weight (lbs.)
D213-9	Square	9-3/8" (238 mm)	1-19/32" (41 mm)	1-1/4" (32 mm)	5/8" (16 mm)	25/32" (20 mm)	plastic-dipped	dark blue	1.07

High-Leverage Side-Cutting Pliers – Lineman's Bolt-Thread Holding

Additional Features:

- Hinge opening holds and cleans 5/8" pole line and hardware bolts or threaded rods.
- High-leverage design. Rivet is closer to the cutting edge for 46% greater cutting and gripping power than other plier designs.
- Streamlined design with rounded nose and sure-gripping, cross-hatched knurled jaw.



D213-9NETH



Cat. No.	Nose Type	Overall Length	Jaw Length	Jaw Width	Jaw Thickness	Knife Length	Handle Finish	Handle Color	Weight (lbs.)
D213-9NETH	New England	9-3/8" (238 mm)	1-19/32" (41 mm)	1-1/4" (32 mm)	5/8" (16 mm)	25/32" (20 mm)	plastic-dipped	dark blue	1.18
HD213-9NETH	New England	9-1/2" (241 mm)	1-19/32" (41 mm)	1-1/4" (32 mm)	5/8" (16 mm)	25/32" (20 mm)	heavy-duty, oversized, plastic-dipped	light red	1.12

2000 Series* – Heavy-duty cutting knives

D2000-9NETH	New England	9-3/8" (238 mm)	1-19/32" (41 mm)	1-1/4" (32 mm)	5/8" (16 mm)	25/32" (20 mm)	plastic-dipped	royal blue	1.18
-------------	-------------	-----------------	------------------	----------------	--------------	----------------	----------------	------------	------

*Cuts ACSR, screws, nails, and most hardened wire. Features combination polished and black-oxide finish.

All dimensions are in inches and (millimeters).

▲WARNING: Always wear approved eye protection.

▲WARNING: NOT insulated. Plastic-dipped or slip-on plastic handles are NOT intended for protection against electrical shock.



Pump Pliers

Pump Pliers

- Secure tongue and groove design for non-slip grip – even with heavy pressure.
- Wide range of versatile jaw positions.



D502-6

Cat. No.	Overall Length	Max. Jaw Capacity	Handle Finish	Handle Color	Weight (lbs.)
D502-6	6-1/2" (165 mm)	7/8" (22 mm)	plastic-dipped	yellow	.41
HD502-6	6-5/8" (168 mm)	7/8" (22 mm)	heavy-duty plastic-dipped	light red	.44
D502-10	10" (254 mm)	1-3/4" (45 mm)	plastic-dipped	yellow	.97
HD502-10	10-1/8" (257 mm)	1-3/4" (45 mm)	heavy-duty plastic-dipped	light red	1.01
D502-12	12-1/4" (311 mm)	2-3/8" (60 mm)	plastic-dipped	yellow	1.37
HD502-12	12-3/8" (314 mm)	2-3/8" (60 mm)	heavy-duty plastic-dipped	light red	1.48
D502-16	16-3/4" (425 mm)	4-1/4" (108 mm)	plastic-dipped	yellow	3.22

Journeyman Series – Dual-material handles

J502-10	10-1/4" (260 mm)	1-3/4" (45 mm)	Journeyman	yellow/black	1.02
---------	------------------	----------------	------------	--------------	------

Refer to the insulated section for insulated pliers.

Pump Pliers

JOURNEYMAN

Additional Features:

- Secure tongue and groove design for non-slip grip – even with heavy pressure.
- Wide range of versatile jaw positions.
- Tension-loaded joint to reduce handle wobble for sure gripping.
- Induction-hardened jaws for long life.



J502-10

Cat. No.	Overall Length	Max. Jaw Capacity	Handle Finish	Handle Color	Weight (lbs.)
J502-10	10-1/4" (260 mm)	1-3/4" (45 mm)	Journeyman	yellow/black	1.02

Telecom Tools

Diagonal Telephone Work Pliers – Type D-6

- Tapered nose for easy working in confined areas and close tip cutting.
- Convenient .030" and .045" stripping holes.
- "V" stripping notch in jaw for quick insulation slitting.
- Serrated behind the hinge to crush insulation.



72192

Cat. No.	Overall Length	Jaw Length	Jaw Width	Jaw Thickness	Cutting Knives	Handle Finish	Handle Color	Weight (lbs.)
72192	6-1/8" (156 mm)	13/16" (21 mm)	3/4" (19 mm)	7/16" (11 mm)	standard	plastic-dipped	red	.33

All dimensions are in inches and (millimeters).

▲WARNING: Always wear approved eye protection.

▲WARNING: NOT insulated. Plastic-dipped or slip-on plastic handles are NOT intended for protection against electrical shock.



Adjustable Wrenches

Features:

Precision-machined jaws are individually chosen and assembled by hand for smooth operation.

Available in high-capacity.

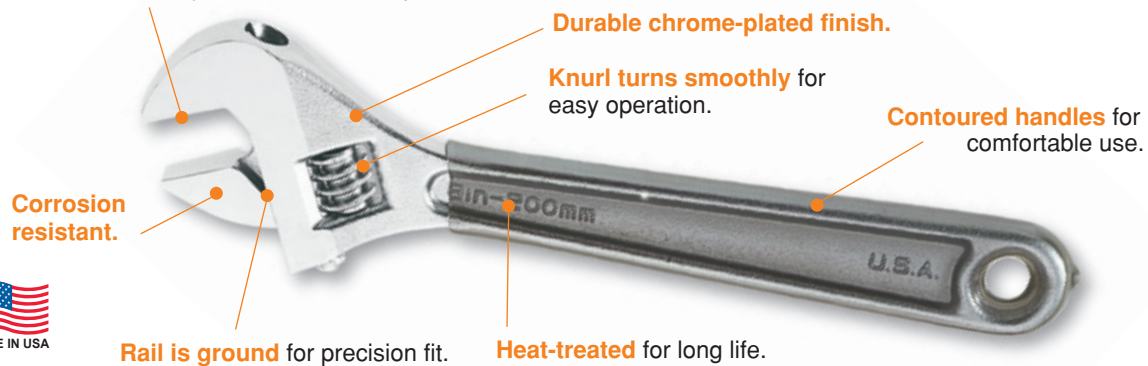

Adjustable Wrenches – Standard Capacity

Additional Features:

- Forged heat-treated alloy steel for maximum strength and light weight.
- High polish chrome finish.



506-8

Cat. No.	Handle Type	Handle Finish	Length	Capacity	Weight (lbs.)
506-10	dovetail	plain	10-1/4" (260 mm)	1-1/8" (28 mm)	.86
506-12	dovetail	plain	12-1/4" (311 mm)	1-5/16" (33 mm)	1.32
500-18	tapered	plain	18-1/4" (463 mm)	2-1/16" (52 mm)	4.67
500-24	tapered	plain	24" (610 mm)	2-1/2" (63 mm)	7.76

Adjustable Wrenches – Standard Capacity, Plastic-Dipped Handles

Additional Features:

- Plastic-dipped handles for added comfort.
- Forged heat-treated alloy steel for maximum strength and light weight.
- High polish chrome finish.



D506-8

Cat. No.	Handle Type	Handle Finish	Length	Capacity	Weight (lbs.)
D506-10	dovetail	plastic-dipped	10-3/8" (264 mm)	1-1/8" (28 mm)	1.00
D506-12	dovetail	plastic-dipped	12-3/8" (315 mm)	1-5/16" (33 mm)	1.44

Socket Wrenches

3/8-Inch Drivers and Extensions

Cat. No.	Description	Weight (lbs.)
65720	7-1/2" ratchet	.73
65721	1-3/4" extension	.09
65722	3" extension	.15
65723	6" extension	.30
65724	5/8" spark plug socket	.21



65720

65721

65722

65723

65724

All dimensions are in inches and (millimeters).

▲WARNING: Always wear approved eye protection.

▲WARNING: Do NOT push or hammer wrench.

▲WARNING: NOT insulated. Plastic-dipped or slip-on plastic handles are NOT intended for protection against electrical shock.

▲WARNING: Do NOT extend handle length.



Ratcheting Box Wrenches

Features:

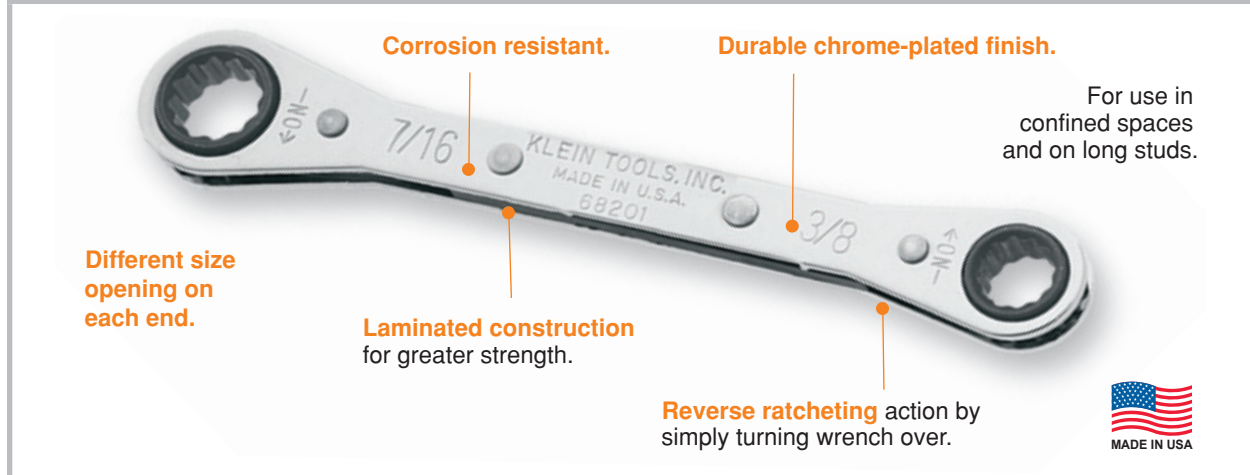

5-Piece Ratcheting Box Wrench Set

Additional Features:

- Five ratcheting box wrenches packed in a vinyl 8-1/2"W x 10"H (216 mm x 254 mm) roll-up pouch with individual pockets.
- Wrenches flip over to reverse ratchet.

Cat. No.	Set Contains	Weight (lbs.)	
68221		1.45	
Cat. No.	Point	Size	Length
68200	12	1/4" x 5/16"	4-3/8" (112 mm)
68201	12	3/8" x 7/16"	5-1/2" (140 mm)
68202	12	1/2" x 9/16"	6-7/8" (175 mm)
68203	12	5/8" x 11/16"	8-1/4" (216 mm)
68204	12	5/8" x 3/4"	8-1/4" (216 mm)



68221

7-Piece Ratcheting Box Wrench Set

Additional Feature:

- Set of the ratcheting box wrenches in vinyl roll-up pouch.

Cat. No.	Set Contains	Weight (lbs.)	
68222		2.65	
Cat. No.	Point	Size	Length
68200	12	1/4" x 5/16"	4-3/8" (112 mm)
68201	12	3/8" x 7/16"	5-1/2" (140 mm)
68202	12	1/2" x 9/16"	6-7/8" (175 mm)
68203	12	5/8" x 11/16"	8-1/4" (216 mm)
68204	12	5/8" x 3/4"	8-1/4" (216 mm)
68205	12	11/16" x 3/4"	9-1/4" (235 mm)
68206	12	13/16" x 7/8"	9-1/4" (235 mm)



68222

All dimensions are in inches and (millimeters).

▲WARNING: Always wear approved eye protection.

▲WARNING: Do NOT push or hammer wrench.

▲WARNING: Never use on or near live electrical circuits.

▲WARNING: Do NOT extend handle length.



Ratcheting Box Wrenches

Ratcheting Box Wrenches

Cat. No.	Point	Size	Length	Weight (lbs.)
68200	12	1/4" x 5/16"	4-3/8" (112 mm)	.13
68201	12	3/8" x 7/16"	5-1/2" (140 mm)	.18
68202	12	1/2" x 9/16"	6-7/8" (175 mm)	.29
68203	12	5/8" x 11/16"	8-1/4" (216 mm)	.43
68204	12	5/8" x 3/4"	8-1/4" (216 mm)	.42
68205	12	11/16" x 3/4"	9-1/4" (235 mm)	.52
68206	12	13/16" x 7/8"	9-1/4" (235 mm)	.69



Ratcheting Lineman's Wrenches

- Bolt-through design allows bolts to pass through the socket.
- 3/4" and 1" x 1-1/8" combination square socket for most common utility hardware.
- Bright yellow socket for easy visibility.
- Works on most common utility pole hardware, such as lag bolts, "C" clamps and suspension bolts.
- KT155T also offers two popular wrench sizes: 9/16" and 3/4".

Cat. No.	Description	Length	Weight (lbs.)
KT151T	Ratcheting Lineman's Wrench	13"	2.12
KT155T	5-in-1 Lineman's Wrench	9-3/8"	1.42



Lineman's Box Wrenches

- "See-through handle" (Klein Klear-Vu™ technology) shows metal ends are not connected.
- 12-point 9/16" and 3/4" sockets.
- Reverse ratcheting action by simply turning wrench over.
- Textured grooves in handle prevent slipping (Cat. No. KT223-INS).
- Solid, one piece design (Cat. No. KT203).
- Chrome plated finish resists corrosion.

Cat. No.	Description	Socket Size	Length	Weight (lbs.)
KT223-INS	Insulating Lineman's Box Wrench	9/16" x 3/4"	8-1/4" (216 mm)	.62
KT203	Lineman's Box Wrench	9/16" x 3/4"	8-1/8" (206 mm)	.55

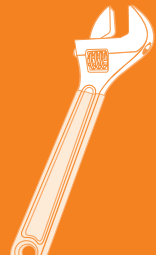

All dimensions are in inches and (millimeters).

▲WARNING: Always wear approved eye protection.

▲WARNING: Do NOT push or hammer wrench.

▲WARNING: NOT insulated. Plastic-dipped or slip-on plastic handles are NOT intended for protection against electrical shock.

▲WARNING: Do NOT extend handle length.

Ratcheting Offset Box Wrenches

3-Piece Fully Reversible Ratcheting Offset Box Wrench Set

- Set of three offset and fully reversible ratcheting box wrenches.
- Different size single-hex openings on each end.
- Includes heavy-duty vinyl pouch.

Cat. No.	Set Contains	Weight (lbs.)	
68244		.61	
Cat. No.	Point	Size	Length
68234	6	1/4" x 5/16"	4-3/8" (112 mm)
68236	6	3/8" x 7/16"	5-1/2" (140 mm)
68238	6	1/2" x 9/16"	6-3/4" (171 mm)



68244

5-Piece Fully Reversible Ratcheting Offset Box Wrench Set

- Set of the offset reversible ratchet box wrenches in vinyl roll-up pouch.
- Two grommet holes for hanging.

Cat. No.	Set Contains	Weight (lbs.)	
68245		1.57	
Cat. No.	Point	Size	Length
68234	6	1/4" x 5/16"	4-3/8" (112 mm)
68236	6	3/8" x 7/16"	5-1/2" (140 mm)
68238	6	1/2" x 9/16"	6-3/4" (171 mm)
68240	12	5/8" x 11/16"	8-1/8" (206 mm)
68242	12	3/4" x 7/8"	9-1/8" (232 mm)



68245

Fully Reversible Ratcheting Offset Box Wrenches

- Both ends are offset 25° for more convenient use in confined spaces.
- Quick-flip reversing lever for instant ratchet reversal.
- Laminated construction for greater strength.
- Chrome-plated for rust resistance.
- Different size openings at each end.



68236

Cat. No.	Point	Size	Length	Weight (lbs.)
68234	6	1/4" x 5/16"	4-3/8" (112 mm)	.13
68236	6	3/8" x 7/16"	5-1/2" (140 mm)	.18
68238	6	1/2" x 9/16"	6-3/4" (171 mm)	.30
68240	12	5/8" x 11/16"	8-1/8" (206 mm)	.46
68242	12	3/4" x 7/8"	9-1/8" (232 mm)	.50



All dimensions are in inches and (millimeters).

▲WARNING: Always wear approved eye protection.

▲WARNING: Do NOT push or hammer wrench.

▲WARNING: NOT insulated. Plastic-dipped or slip-on plastic handles are NOT intended for protection against electrical shock.

▲WARNING: Do NOT extend handle length.



Socket Wrench Sets

9-Piece 3/8-Inch Drive "D" Socket Wrench Set

Special tool selection for telephone work on cable enclosures and pole hardware.

Set consists of the following pieces:

- Four 6-point deep sockets: 3/8", 7/16", 1/2", and 9/16".
- One 3/8"-drive reversible ratchet: 7-7/8" long.
- Two extensions: 3" and 5" long.
- One 9/16" combination wrench: 6-5/8" long.
- One 3/16" hex nut driver.
- Hinged metal box.



65503

Cat. No.	Description	Weight (lbs.)
65503	complete 9-piece "D" wrench kit plus metal box	3.60

Specialty Wrenches

Can Wrench



68005

- Two tools in one; saves space in your pouch.
- One end opens telephone box fasteners, the other end tightens nuts on binding-post terminals.
- The 7/16" socket has a black finish and the 3/8" socket has a silver finish.
- Sockets are 1-1/4" (32 mm) deep to fit over long binding posts and are thin-walled for easy access into tight areas.
- Socket ends are color-coded for quick identification of socket sizes.
- Hex-socket design enables using a wrench to obtain extra torque.
- High-impact, break-resistant handle for long and dependable service.
- Sockets are heat-treated, alloy steel.

Cat. No.	Description	Length	Handle Diameter	Weight (lbs.)
68005	3/8" and 7/16" hex nut	7" (178 mm)	1" (25 mm)	.35

Bell System Type



3146B

- Similar to standard lineman's wrench, but with end openings sized to NEMA hardware specifications.
- Silver painted finish.

Cat. No.	Description	Length	Weight (lbs.)
3146B	Large end has 1-1/16" and 1-3/16" openings. Small end has 11/16" and 7/8" openings.	13" (330 mm)	1.76

Lineman's Wrenches



3146

- Forged from special bar steel and heat-treated for long life.
- Each end has two different size openings.
- Hole is provided at larger end for turning-in standard pole steps.
- Wrench is suited for use on heavy three-bolt guy clamps on which clearance is limited.
- Dark blue painted finish (small end is painted silver on Cat. No. 3146A).

Cat. No.	Description	Length	Weight (lbs.)
3146	For 5/8" hardware. Large end has 29/32" and 1-3/32" openings. Small end has 5/8" and 13/16" openings.	13" (330 mm)	1.85
3146A	For 3/4" hardware. Large end has 1-1/16" and 1-5/16" openings. Small end has 5/8" and 7/8" openings.	13" (330 mm)	1.70



All dimensions are in inches and (millimeters).

▲WARNING: Always wear approved eye protection.

▲WARNING: Do NOT push or hammer wrench.

▲WARNING: NOT insulated. Plastic-dipped or slip-on plastic handles are NOT intended for protection against electrical shock.

▲WARNING: Do NOT extend handle length.



Cushion-Grip Screwdrivers

Keystone-Tip Screwdrivers – Heavy-Duty Round-Shanks

Additional Features:

- Built to handle the tough jobs with ease.
- Hex bolster reinforces shank for hard use and allows wrench assisted turning.

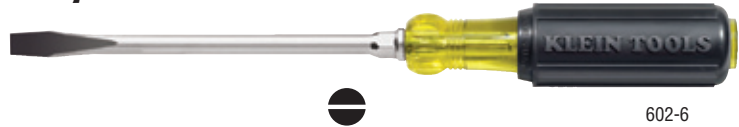

602-6

Cat. No.	Shank Tip Width	Shank Length	Overall Length	Weight (lbs.)
600-1*	1/4" (6 mm)	1-1/2" (38 mm)	3-7/16" (87 mm)	.10
602-3	7/32" (6 mm)	3" (76 mm)	6-3/4" (171 mm)	.15
602-4	1/4" (6 mm)	4" (102 mm)	8-11/32" (212 mm)	.25
602-6	5/16" (8 mm)	6" (152 mm)	10-15/16" (278 mm)	.35
602-8	3/8" (10 mm)	8" (203 mm)	13-7/16" (341 mm)	.55
602-10	3/8" (10 mm)	10" (254 mm)	15-7/16" (392 mm)	.60
602-12	3/8" (10 mm)	12" (305 mm)	17-7/16" (443 mm)	.65

* Bolster not available on 600-1.
Refer to the insulated section for insulated screwdrivers.

Journeyman™ Screwdriver Sets

5-Piece Journeyman™ Screwdriver Set

JOURNEYMAN

Additional Features:

- General purpose selection of the most frequently used screwdrivers.

Cat. No.	Set Contains	Weight (lbs.)
JSDS01		1.15

Cat. No.	Description	Shaft Length	Overall Length
JSD6C06	3/16" Cabinet Tip Screwdriver	6" (152 mm)	10-1/4" (260 mm)
JSD4K08	1/4" Keystone Tip Screwdriver	4" (102 mm)	9" (228 mm)
JSD6K09	5/16" Keystone Tip Screwdriver	6" (152 mm)	11" (279 mm)
JSD4PH1	#1 Phillips Tip Screwdriver	4" (102 mm)	8-1/4" (210 mm)
JSD4PH2	#2 Phillips Tip Screwdriver	4" (102 mm)	9" (228 mm)



JSDS01

7-Piece Journeyman™ Screwdriver Set

JOURNEYMAN

Additional Features:

- Accommodates a broad range of standard fastener sizes.

Cat. No.	Set Contains	Weight (lbs.)
JSDS02		1.65

Cat. No.	Description	Shaft Length	Overall Length
JSD4C06	3/16" Cabinet Tip Screwdriver	4" (102 mm)	8-1/4" (210 mm)
JSD6C06	3/16" Cabinet Tip Screwdriver	6" (152 mm)	10-1/4" (260 mm)
JSD4K08	1/4" Keystone Tip Screwdriver	4" (102 mm)	9" (228 mm)
JSD6K09	5/16" Keystone Tip Screwdriver	6" (152 mm)	11" (279 mm)
JSD4PH1	#1 Phillips Tip Screwdriver	4" (102 mm)	8-1/4" (210 mm)
JSD4PH2	#2 Phillips Tip Screwdriver	4" (102 mm)	9" (228 mm)
JSD6PH3	#3 Phillips Tip Screwdriver	6" (152 mm)	11" (279 mm)



JSDS02

All dimensions are in inches and (millimeters).

⚠WARNING: Always wear approved eye protection.

⚠WARNING: NOT insulated. Will NOT protect against electrical shock.

⚠WARNING: Do NOT use to pry or chisel.



Hammers

Lineman's Straight-Claw Hammer



832-32

- Heavy-duty, double-duty hammer drives lags and pulls big nails.
- Special high-carbon steel head with solid, octagon-shaped driving end and thick, strong claw.
- Straight-grain hickory handle, lacquered.

Cat. No.	Head Weight	Overall Length	Weight (lbs.)
832-32	32 oz. (907 g)	15" (381 mm)	2.50



Hammers



Lineman's Double-Face Hammer



809-36

- Designed for pole-line work.
- Rugged and well-balanced, with the weight to drive lag bolts.
- Forged, tempered-steel head is only 3-3/4" (95 mm) long for use in tight areas.
- Identical faces with 1-3/4" (44 mm) round-crown driving surface and beveled edges.

Cat. No.	Head Weight	Overall Length	Weight (lbs.)
809-36	36 oz. (1021 g)	14" (356 mm)	2.50

All dimensions are in inches and (millimeters) unless otherwise specified.

▲WARNING: Always wear approved eye protection.



Pocket Knives – One Blade

Lightweight Lockback Knives

- Blades are AUS 8 stainless steel hardened to 58-59 Rc.
- Premium quality blade offers superior edge holding.
- Impact-resistant nylon resin handle with rubber insert (Cat. Nos. 44002-44005).
- Slim and comfortable silver anodized-aluminum handle for corrosion-resistance (Cat. Nos. 44000, 44001, 44006, 44007, 44008).
- Black chrome blade and black anodized-aluminum handle for corrosion-resistance (Cat. Nos. 44000-BLK and 44001-BLK).
- Cat. No. 44008 features drop point and screwdriver blades.
- Reversible thumb stud provides easy one-handed opening.

Cat. No.	Blade Steel	Blade Length	Closed Length	Weight (oz.)
----------	-------------	--------------	---------------	--------------

Drop Point Blade

44000	AUS 8 stainless steel	2-1/4" (57 mm)	3-1/8" (76 mm)	1.5
44000-BLK	AUS 8 stainless steel	2-1/4" (57 mm)	3-1/8" (76 mm)	.08
44001*	AUS 8 stainless steel	2-1/2" (64 mm)	3-1/2" (89 mm)	2.5
44001-BLK*	AUS 8 stainless steel	2-1/2" (64 mm)	3-1/2" (89 mm)	1.3
44002	AUS 8 stainless steel	2-3/8" (60 mm)	3-1/2" (89 mm)	1.5
44003	AUS 8 stainless steel	2-3/4" (70 mm)	4-1/8" (105 mm)	2.5

Sheepfoot Blade

44004	AUS 8 stainless steel	2-3/8" (60 mm)	3-1/2" (89 mm)	1.5
44005	AUS 8 stainless steel	2-5/8" (67 mm)	4-1/8" (105 mm)	2.5
44006*	AUS 8 stainless steel	2-5/8" (67 mm)	3-1/2" (89 mm)	.13

* Includes a pocket/belt clip.



44001-BLK



44001



44002



44005

Cat. No.	Blade Steel	Blade Length	Closed Length	Weight (oz.)
----------	-------------	--------------	---------------	--------------

Coping Blade

44007*	AUS 8 stainless steel	2-1/2" (63 mm)	3-1/2" (89 mm)	.15
--------	-----------------------	----------------	----------------	-----

* Includes a pocket/belt clip.

Compact Pocket Knives – Drop Point Blade

- Compact and lightweight knives.
- Stainless steel handles and blades for long life.



44033

- Rosewood handle inserts on both sides.
- Modified spearpoint blades lock open.

Cat. No.	Blade Steel	Blade Length	Length Closed	Weight (oz.)
----------	-------------	--------------	---------------	--------------

44032	stainless steel	1-5/8" (41 mm)	2-1/2" (64 mm)	1.0
44033	stainless steel	2" (51 mm)	3" (76 mm)	1.8
44034	stainless steel	2-5/8" (67 mm)	4" (102 mm)	4.0



Money-Clip Pocket Knife – Spearpoint Blade and Nail File

- Handsome, brushed stainless steel case with rosewood insert.
- Includes money clip, 1-1/2" (38 mm) spearpoint blade and 1-1/2" (38 mm) nail file.

Cat. No.	Blade Type	Blade Length	Length Closed	Weight (oz.)
----------	------------	--------------	---------------	--------------

44031	stainless steel	1-1/2" (38 mm)	2-1/8" x 7/8" x 1/4" (54 mm x 22 mm x 6 mm)	.8
-------	-----------------	----------------	--	----



44031

All dimensions are in inches and (millimeters).

▲WARNING: Always wear approved eye protection.

▲WARNING: Never use on or near live electrical circuits.



Pocket Knives – One Blade

Sportsman Knives – Sharp Point Blade

- Curved handle with big bolster.
- Brass bolsters and ebony wood handles.
- Stainless steel blades for long life.
- Brass linings.



- Blades lock open.
- Cat. No. 44037 furnished with leather snap case with belt loop.

Cat. No.	Blade Steel	Blade Length	Length Closed	Weight (oz.)
44035	stainless steel	2" (51 mm)	3" (76 mm)	1.5
44036	stainless steel	2-3/8" (60 mm)	3-1/2" (89 mm)	2.5
44037	stainless steel	3-3/8" (86 mm)	4-7/8" (124 mm)	6.5

Pocket Knives – Coping Blade

- Coping-type blade.
- Compact and lightweight.
- Ideal for skinning small wire and cable.
- Blade locks open (Cat. No 1550-11 and 1550-14 only)

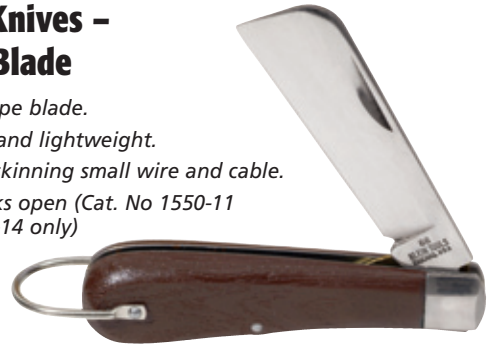

- Woodgrain plastic handle (Cat. No. 1550-14 only)

Cat. No.	Blade Steel	Blade Length	Length Closed	Weight (oz.)
1550-5	carbon steel	2-1/4" (57mm)	3-1/4" (83mm)	1.5
1550-11*	carbon steel	2-1/4" (57mm)	3-1/4" (83mm)	1.5
1550-14*	carbon steel	3" (76mm)	4-1/4" (108mm)	4.0
1550-45	stainless steel	2-1/4" (57mm)	3-1/4" (83mm)	1.5

*Blade locks open

Pocket Knives – Sheepfoot Slitting Blade

- Extra-large curved sheepfoot slitting-blade – 2-5/8" (67 mm) long.
- Ideal for heavy-duty line work.
- Woodgrain plastic handle.
- Blade locks open.



Cat. No.	Blade Steel	Blade Length	Length Closed	Weight (oz.)
1550-4	carbon steel	2-5/8" (67 mm)	4" (102 mm)	4.0
1550-44	stainless steel	2-5/8" (67 mm)	4" (102 mm)	4.0

Pocket Knife – Slitting Blade

- Large, stainless steel, curved-sheepfoot slitting blade – 2-1/2" (64 mm) long.
- Ideal for heavy-duty line work.
- Plastic handle.
- Blade locks open.



Cat. No.	Blade Steel	Blade Length	Length Closed	Weight (oz.)
1550-24	stainless steel	2-1/2" (64 mm)	4-3/8" (111 mm)	2.5

Pocket Knives – Two Blades

2-Blade Pocket Knives – Spearpoint and Screwdriver-Tip Blades

- Standard spearpoint blade – 2-1/2" (64 mm) long.
- Screwdriver-tip blade – 2-1/2" (64 mm) long.
- Screwdriver-tip blade locks open.



Cat. No.	Blade Steel	Blade Lengths	Length Closed	Weight (oz.)
1550-2	carbon steel	2-1/2" (64 mm)	3-3/4" (95 mm)	4.0
1550-42	stainless steel	2-1/2" (64 mm)	3-3/4" (95 mm)	4.0

2-Blade Pocket Knife – Sheepfoot and Screwdriver-Tip Blades

- Curved sheepfoot slitting blade – 2-3/8" (60 mm) long.
- Screwdriver-tip blade – 2-1/2" (64 mm) long.
- Screwdriver blade locks open.



Cat. No.	Blade Steel	Blade Lengths	Length Closed	Weight (oz.)
1550-7	carbon steel	2-3/8" (60 mm) and 2-1/2" (64 mm)	3-3/4" (95 mm)	4.0

All dimensions are in inches and (millimeters).

▲WARNING: Always wear approved eye protection.

▲WARNING: Never use on or near live electrical circuits.



Pocket Knives – One Blade

Cable/Lineman's Skinning Knives



- Three-inch steel blade withstands frequent scoring and slitting of cable jacket.
- Blade and ring are securely molded in handle.
- Notch on blade back for scraping or removing wire insulation.
- Comfortable textured handle with finger grooves and guard.
- Heavy-duty serrated steel blade for saw-action cutting (Cat. No. 1560-3).
- No contact between stainless steel ring and hardened steel blade (available on Cat. No. 1570-3).
- Rectangle-shaped handle design for attachment to some utility hot stick equipment.
- Leather sheath available, Cat. No. 5163.



Cat. No.	Description	Handle Color	Length Less Ring	Weight (lbs.)
1560-3	serrated blade, notch, and ring	black	8" (203 mm)	.30
1570-3	hook blade, notch, and ring	red	8" (203 mm)	.30
1570-3LR	hook blade and notch	red	8" (203 mm)	.29

Sharpening Tools

Pocket-Sized Knife Sharpener

- A rugged, versatile sharpener featuring fine craftsmanship and unique design.
- Blade unscrews and stores in handle for convenient carrying tool box, pouch, or pocket.
- Blade is precision-cut, hard-chromed steel for accurate, consistent sharpening and long life.
- Magnetized to trap metal particles when sharpening.
- Handle is high-visibility orange color, with handy pocket clip.



Cat. No.	Blade Length	Length Closed	Weight (lbs.)
44151	3-3/4" (95 mm)	5-1/2" (140 mm)	.05

Special-Purpose Knives

Cable-Sheath Splitting Knife



- Compact, lightweight knife for opening lead cables.
- Rugged, forged tempered cutlery steel blade.
- Sharp, chisel-shaped edge.
- Hammer head on back.
- Plastic-dipped handle for comfort.
- Leather guard available, Cat. No. 5574S.

Cat. No.	Overall Length	Blade Length	Weight (lbs.)
1515-S	7-3/8" (187 mm)	2-19/32" (66 mm)	.35

Bell System Cable-Sheath Splitting Knife – Heavy-Duty



- Heavy-duty knife for splitting cable sheaths.
- Rugged, forged tempered cutlery steel blade.
- Sharp chisel-shaped edge.
- Plastic-dipped handle for comfort.
- Leather guard available, Cat. No. 5574L.

Cat. No.	Overall Length	Blade Length	Weight (lbs.)
1515-1	8-3/4" (222 mm)	4-1/2" (114 mm)	1.20

All dimensions are in inches and (millimeters).

▲WARNING: Always wear approved eye protection.

▲WARNING: Never use on or near live electrical circuits.



Special-Purpose Knives

Cable-Splicer's Kits

- Cuts cable, telephone wire, and strips insulation.
- Dimensions: 2-1/8" x 7-1/2" (54 mm x 191 mm).

Cat. No.	Kit Contains	Weight (lbs.)
46037	cable splicer's kit	.50
Cat. No.	Description	
44200	cable-splicer's knife	
2100-7	electrician's scissors with stripping notches	
5187	slotted leather holder for belts up to 2" (51 mm) wide	



46037

Cable-Splicer's Knife

- Special-purpose short blade with comfortable, full-sized, heavy-duty handle.
- Coping-type blade made of the finest cutlery steel, tough and carefully tempered to hold its edge.
- Handle is textured for comfort and firm grip.
- Hang hole for easy storage and portability.

Cat. No.	Overall Length	Blade Length	Weight (lbs.)
44200	6-1/4" (159 mm)	1-3/4" (44 mm)	.15



44200

Electrician's Scissors

Electrician's Scissors

- Designed for telecom and electrical applications and heavy-duty use.
- Strong, tough tempered steel.
- Nickel-plated finish resists corrosion.
- Scraper and file on outside of both blades.



2100-5

Cat. No.	Overall Length	Cutting Length	Weight (lbs.)
2100-5	5-1/4" (133 mm)	1-7/8" (48 mm)	.20

Electrician's Scissors – Stripping Notches

- Upper blade has notches for stripping 19 AWG and 23 AWG wire.
- Designed for telecom and electrical applications and heavy-duty use.
- Strong, tough tempered steel.
- Nickel-plated finish resists corrosion.
- Scraper and file on outside of both blades.
- Serrated lower blade reduces slippage.



2100-7

Cat. No.	Overall Length	Cutting Length	Weight (lbs.)
2100-7	5-1/4" (133 mm)	1-7/8" (48 mm)	.20

Stainless Steel Electrician's Scissors – Stripping Notches

- Stainless steel blades to maintain blade durability and sharpness.
- Blade is fully serrated for non-slip cutting action.
- Free-fall snip feature for ease of use (2100-8).
- Cuts electrical communication 19 AWG and 23 AWG wire.
- Extended handle provides comfort and cutting leverage for wire cutting application (2100-8).
- 56 HRC.



2100-9



2100-8

Cat. No.	Overall Length	Cutting Length	Weight (lbs.)
2100-8	6-5/16" (160 mm)	1-7/8" (48 mm)	.21
2100-9	5-1/4" (133 mm)	1-7/8" (48 mm)	.21
2101-0*	1-7/8" (48 mm)	6-5/16" (160 mm)	.21

*Free-fall snip with carbon steel blade.

All dimensions are in inches and (millimeters).

▲WARNING: Always wear approved eye protection.

▲WARNING: Never use on or near live electrical circuits.

▲WARNING: NOT insulated. Will NOT protect against electrical shock.



Folding Rules

Fiberglass Folding Rules

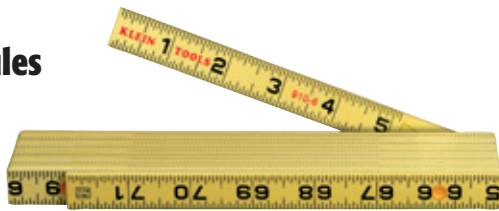

910-6

- Constructed of tough nylon, reinforced with glass fibers for added durability, and resistance to weather, abrasion, and most chemicals.
- Positive locking joints and stainless steel spring hinges for added strength.
- Measurements are marked on both sides and both edges, graduated to 1/16th inch.
- Black markings on yellow, with red stud center markings every 16 inches.
- Engraved graduations on both sides.

Cat. No.	Reading	Length	Weight (lbs.)
910-6	inside	6' (183 cm)	.33
911-6	outside	6' (183 cm)	.33



Fiberglass Tapes

Woven Fiberglass Tape – Case

- Woven fiberglass tape with moisture-proof coating of polyvinyl chloride assures durability and protects against oil or chemicals.
- Can be immersed in water without adverse effects.
- All metal parts are nickel-plated for protection against rust.
- End-hooks are permanently attached to reinforced strip.
- Black case and reel are ruggedly built, yet lightweight and comfortable to use.
- Tape line graduated in feet and inches to 8ths.
- Black graduating numbers and red foot markings on yellow background.
- Protective carrying case encloses tape completely.
- Tape ring tucks neatly into case opening for storage.

Cat. No.	Length	Width	Weight (lbs.)
946-50	50' (15 m)	1/2" (13 mm)	.80
946-100	100' (30 m)	1/2" (13 mm)	1.20



946-100

Woven Fiberglass Tape – Open-Reel

- Woven fiberglass tape with moisture-proof coating of polyvinyl chloride assures durability and protects against oil or chemicals.
- Can be immersed in water without adverse effects.
- Black figures on a yellow background are easy to read.
- All metal parts are nickel-plated for protection against rust.
- End hooks are permanently attached to a reinforced strip.
- Case and reel are ruggedly built, yet lightweight and comfortable to use.
- Tape line is graduated in feet and inches to 8ths.
- Graduations and numbers are black; foot markings are red.
- Contained in a high-visibility orange open reel and is easy to handle and rewind.
- Line will not collect dirt or bring debris into the case.

Cat. No.	Length	Width	Weight (lbs.)
946-150	150' (46 m)	1/2" (13 mm)	1.70



946-150

All dimensions are in inches and (millimeters) unless otherwise specified.

▲WARNING: Always wear approved eye protection.



Protective Eyewear

Features:

Impact resistant polycarbonate lenses block greater than 99.9% of harmful UVA and UVB radiation up to 400 nanometer.

Permanently bonded **Uvextreme® anti-fog coating** with anti-scratch, anti-static and UV protection properties.

Adjustable spatulite temples provide a comfortable customized fit.

Temple-end holes for easy lanyard attachment.

Meets the traffic signal color recognition requirements of **ANSI Z80.3-1996**.



Lens Color



Uvextreme® and Spectrum Control Technology® (SCT™) are registered trademarks of Sperian Eye & Face Protection, Inc.

*SCT® = Spectrum Control Technology

Protective Eyewear – Standard

Additional Features:

- Meets Mil V₀ ballistic test for impact.
- Soft elastomer brow-guard absorbs, diffuses and deflects impact energy.
- Soft flexible fingers adjust and conform to most nasal profiles reducing slippage.
- Three position ratchet lens inclination adjusts for a custom fit and unsurpassed comfort.
- Lens designed to follow the contour of the cheekbone and create a "zone of protection."
- Dual 9-base wrap-around lens provides uncompromised peripheral vision.
- Unique ventilation channel delivers an outstanding level of moisture and fog control.



60053

Cat. No.	Frame Color	Lens Color	Environment	Light Intensity	True Color Recognition	Visual Light Transmitted	IR Absorption	Blue Light transmittance	Accidental Arc Protection	Weight (lbs.)
60046	black	dark gray	outdoor	normal to bright	Yes	10%	60%	-	No	.15
60047	black	SCT* gray	outdoor	normal to bright	Yes	15%	>85%	<7%	Yes	.15
60049	black	amber	indoor/ outdoor	normal to low	No	90%	-	-	No	.15
60053	black	clear	indoor	normal to low	Yes	92%	-	-	No	.15
60054	royal blue	clear	indoor	normal to low	Yes	92%	-	-	No	.15
60055	black	espresso	outdoor	normal to bright	Yes	15%	60%	<3%	No	.15

Protective Eyewear – Frameless

Additional Features:

- Dual nine-base wrap-around lens with integrated side shields provides a clear, unobstructed field of vision and superior coverage.
- Sleek, frameless design is featherlight (22 grams) for all-day comfort.
- Lens inclination adjustment system for a customized fit.
- Molded-in nose bridge provides uncompromised comfort and fit.



60056

Cat. No.	Frame Color	Lens Color	Environment	Light Intensity	True Color Recognition	Visual Light Transmitted	IR Absorption	Blue Light transmittance	Accidental Arc Protection	Weight (lbs.)
60056	black	clear	indoor	normal to low	Yes	92%	-	-	No	.15
60057	black	espresso	outdoor	normal to bright	Yes	15%	60%	<3%	No	.15

WARNING: It is important that users of these products read, understand, and follow all instructions, cautions, and warnings that are attached to and/or packed with the product.



Hard Hats & Caps

V-Gard® Cap and Hat

- Polyethylene shell with 4-point Fas-Trac® ratcheting suspension.
- Standard size fits head sizes 6 - 8.
- Cap and Full-Brim Hat style available.
- Three branding choices: plain front, Klein Tools Lineman Logo, Klein Tools Standard Logo.
- Three color choices: White, Yellow, and Blue.
- Type I helmet meets or exceeds ANSI Z89.1-2003 and CSA Z94.1-2005 specifications for Class E.
- Third Party Certified by Safety Equipment Institute.
- Full line of accessories designed specifically for the V-Gard® Cap and Hat are available.

V-Gard® and Fas-Trac® are registered trademarks of MSA, the safety company.







Available in three colors



60031



60023

Front Logo	none								
Style	Cat. No	Color	Weight (lbs.)	Cat. No.	Color	Weight (lbs.)	Cat. No.	Color	Weight (lbs.)
	60016	white	.86	60019	white	.86	60022	white	.86
	60018	blue	.86	60021	blue	.86	60023	yellow	.86
	60028	white	.95	60031	white	.95	60034	white	.95
	60030	blue	.95	60033	blue	.95	60036	blue	.95

Back Logo All V-Gard helmet backs contain the Klein logo with American flag (pictured blue hard hat in square). Logo color varies depending on shell color.

Advance® Cap

- Vented style provides cooling vents for improved air circulation and comfort.
- Glaregard™ under the brim reduces reflective glare.
- Lateral contours above the ear for easy integration of hearing protection.
- Polyethylene shell with 4-point Fas-Trac® ratcheting suspension.
- Lightweight design for added comfort.
- Standard size fits head sizes 6 - 8.
- Branding: Plain front with Klein Tools Logo and American Flag on the back of the cap.
- Type I helmet meets or exceeds ANSI Z89.1-2003 and specifications for Class C.
- Third Party Certified by Safety Equipment Institute.
- Full line of accessories designed specifically for the Advance® Cap.



Available in three colors



60027

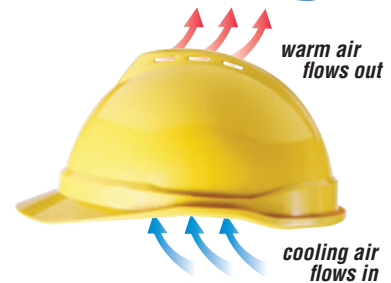

Cat. No.	Color	Weight (lbs.)
60025	white	.84
60027	blue	.84

All Advance® cap backs contain the Klein logo with American flag (pictured blue hard hat in square). Logo color varies depending on shell color.

Glaregard™ is a trademark of, and Advance®, Fas-Trac® are registered trademarks of MSA, the safety company.

Scope of Z89.1 - 2003 American National Standard for Head Protection

The most recent standard was approved in July 2003 and continues to cover requirements for two types of impact-resistant helmets:

TYPE I (Top Impact) Helmets intended to reduce the force of an impact to the top of a wearer's head.

TYPE II (Top and Lateral Impact) Helmets intended to reduce the force of an impact resulting from a blow received off-center or to the top of a wearer's head. The new standard's performance requirements for Type I and Type II Helmets are equivalent to those specified in the 1998 revision.

Electrical Performance

CLASS E (Electrical) Helmets intended to reduce the danger of exposure to high-voltage electrical conductors, proof-tested at 20,000 volts.

CLASS G (General) Helmets intended to reduce the danger of exposure to low-voltage electrical conductors, proof-tested at 2,200 volts.

CLASS C (Conductive) Helmets not intended to provide protection from electrical conductors. The electrical performance requirements in the 2003 standard are identical to those in the 1997 standard.

▲WARNING: It is important that users of these products read, understand, and follow all instructions, cautions, and warnings that are attached to and/or packed with the product.



Hard Hats & Caps

Skullgard® – Cap and Hat



60038

- Heavy-duty construction for use in steel mills and other heavy industries where elevated temperatures are common.
- Resin shell with 4-point Fas-Trac® ratcheting suspension.
- Standard size fits head sizes 6 - 8.
- Cap and hat styles available.
- Branding is not available.
- Traditional tan color.
- Type I helmet meets or exceeds ANSI Z89.1-2003 and specifications for Class G.
- Third Party Certified by Safety Equipment Institute.
- Full line of accessories available that are designed specifically for the Skullgard® cap and hat.

Cat. No.	Type	Color	Weight (lbs.)
60038	hat	tan	1.03

Western Outlaw Hat



60039

- Wide brim provides protection from the sun, rain, heat, and glare.
- Comfortable Western style design.
- 4-point ratcheting suspension.
- Standard size comfortably fits head sizes up to 7-1/4.
- Type I helmet meets or exceeds ANSI Z89.1-2003 and specifications for Class E.
- Branding: Klein Tools logo on the front of the hat.
- Classic tan color.
- Accessories not available.

Cat. No.	Type	Color	Weight (lbs.)
60039	Western Hat	tan	1.24

Accessories

V-Gard®, Advance® and Skullgard® Accessories

Cat. No.	Description	Weight (oz.)
Replacement Suspension - Standard Size		
59979	Skullgard® Cap Fas-Trac® – 4-point ratcheting	3.9
Defender® + Faceshield Frames (All frames meet Z87.1-2003)		
59985	Plus Universal Foldback Frame-dielectric for caps	2.9
59986	Plus Universal Foldback Frame-dielectric for hats	3.2

Skullgard® is a registered trademark of MSA, the safety company.



59985

V-Gard®, Advance®, Fas-Trac®, and Defender® are registered trademarks of MSA, the safety company. Thinsulate™ is a trademark of 3M. Accessories sold separately.

Gloves

Lineman Work Gloves

- 4" Neoprene cuff with side vents.
- Soft grain leather construction and reinforced leather patches for added flexibility.
- Double-row padded knuckle for durability and long life.

	Medium	Large	Extra-Large	Weight (lbs.)
Cat. No.	40080	40082	40084	.25

⚠WARNING: These gloves are not intended for energized electrical use.

NEW!



40080

⚠WARNING: It is important that users of these products read, understand, and follow all instructions, cautions, and warnings that are attached to and/or packed with the product.



Gloves

Utility Gloves

JOURNEYMAN

- Supple, breathable, durable synthetic leather palm added for firm grip.
- Two-way stretch spandex padded top features form-fitting elasticity.
- Reinforced thumb, index finger and fingertips add protection.
- Concealed interior seam stitching prevents snagging.
- Wide opening elastic cuff features an easy entry design.
- Contact points on index finger and thumb feature smooth surface for improved handling of objects.

	Medium	Large	Extra-Large	Weight (lbs.)
Cat. No.	40052	40053	40054	.25



40052

Heavy-Duty Protection Gloves

JOURNEYMAN

- Streamlined high-density accordion knuckle panel reduces impact.
- High profile, impact absorbing molded Thermal Plastic Rubber (TPR) finger protection.
- Non-slip rubberized Zeus™ Clarino® finger and thumb grippers and panel on heel of hand provide grip control and longer wear.
- Synthetic leather with breathable mesh side-insert finger panels for comfort and flexibility.
- Two-ply synthetic leather palm with anatomically die cut Ethylene Vinyl Acetate (EVA) foam padded impact zones.
- Thermal Plastic Rubber (TPR) cuff strap with hook and loop closure.
- Neoprene cuff allows easier access with additional wrist protection and comfort.

	Medium	Large	Extra-Large	Weight (lbs.)
Cat. No.	40062	40063	40064	.46

Zeus™ Clarino® is a trademark of Kuraray Co., Ltd.



40062

Leather Work Gloves

JOURNEYMAN

- Genuine Goatskin professional-grade leather offers the finest in comfort and protection.
- Two-way form-fitting spandex top increases ventilation, comfort and fit.
- Molded Thermal Plastic Rubber (TPR) ribs offer flexible protection for back of hand and fingers.
- Lightly padded palm for increased grip and comfort.
- Easy-entry elastic cuff ventilates and increases comfort.
- Stretch knuckle with Ethylene Vinyl Acetate (EVA) foam padding.
- Thermal Plastic Rubber (TPR) cuff strap with hook and loop closure.

	Medium	Large	Extra-Large	Weight (lbs.)
Cat. No.	40067	40068	40069	.30



40067

Long-Cuff Gloves

- Soft, flexible, top-grain cowhide leather.
- Leather fingers, palm, pull, and knuckle strap.
- Gunn cut with seams away from wear surfaces.
- Wing thumb, seamless index finger, elastic wrist-back strap.
- Lined palm and fingers.
- Rubberized, waterproof, bell gauntlet cuff 5" (127 mm) long.
- Light-gray leather, striped-blue cuff.

Cat. No.	Size	Weight (lbs.)
40010	large	.59
40012	extra large	.68



40010

⚠ WARNING: Not flameproof or fire retardant. DO NOT expose to open flame or sparks.



Wasp and Hornet Spray

Wasp and Hornet Spray

- Quick knock-down occurs with instant freeze action for use on wasp and hornet nests either indoors or outdoors.
- As liquid propellant instantly evaporates, a drop in the temperature paralyzes the insect causing immediate knock-down.
- A 20-foot, high pressure, non-flammable fogging system provides effective use on entire nests and ends re-infestation.
- High dielectric breakdown voltage of 25,000 volts.
- Spray distance and pressure remains throughout the life of the can.

Cat. No.	Net Weight	Cap Color
50990	14 oz. (396 g)	red



50990

RTV Sealants

General Purpose Clear RTV Silicone Adhesive

- Adhesive/Sealant is a gel-like, single component material that cures to a rubbery solid when exposed to moisture in the air.
- Silicone will not sag, slump or run off.
- Adheres to clean metal, glass, most types of oily wood, vulcanized silicone rubber, silicone resins, natural and synthetic fibers, ceramic, paper as well as many painted and plastic surfaces.
- Resists ultraviolet light.
- Automatic dispensing can, with provided plastic nozzle, allows for an even and uniform application to eliminate waste, mess and lumps.

Cat. No.	Net Weight	Cap Color
50995	8 oz. (227 g)	clear



50995

Lubricants

Multi-Purpose Penetrant Lubricant

- All purpose, non-flammable, non-conductive, non-chlorinated spray with a 39,000 volt dielectric strength.
- Lubricant penetrates through rust and corrosion to quickly and easily loosen frozen nuts and bolts to ensure free and easy movement.
- Use on screws, tools, motors, hinges, bearings, gears, relays, starters, and generators.
- Moisture is displaced in wet electrical systems to create a waterproof film to inhibit corrosion and electrical discharge.
- Residual anti-corrosive film leaves treated surfaces protected.
- Non-flammable spray is safe around most plastic and paint. (Test small area of plastic first).

Cat. No.	Net Weight	Cap Color
50999	12 oz. (340 g)	blue



50999

Dielectric Silicone Grease

- Translucent white, grease-like silicone paste.
- Maintains flexibility of natural and synthetic rubbers, vinyls, plastics, rubber and plastic O-rings.
- Moisture-proof seal for aircraft, automotive and marine ignition systems and spark plug connections.
- Use on waterproof electrical connections, electrical assemblies and terminals.
- Acts as a sealant and lubricant for cable connectors, battery terminals, rubber door seals, rubber and plastic O-rings.
- Use as an assembly lubricant for various metals on plastic (test small area of plastic first) and metal on rubber combinations.
- Automatic dispensing can, with provided plastic nozzle, allows for an even and uniform application to eliminate waste, mess and lumps.

Cat. No.	Net Weight	Cap Color
50997	8 oz. (227 g)	black



50997

▲ WARNING: It is important that users of this product read, understand, and follow all instructions, cautions, and warnings attached to and/or packed with the product.

Cleaners

Electrical Cable and Equipment Cleaner

- Non-flammable, non-conductive, non-carcinogenic and fast evaporating without leaving residue.
- Effectively cleans circuit boards, controls, switches and relays.
- Cleans oxidation, dust and light oils from electrical equipment.
- Metals will not corrode and sensitive plastics will not degrade. (Test small area of plastic first).
- Aerosol can, with plastic straw and adjustable flow (low, medium, high) nozzle.



50986

Cat. No.	Net Weight	Cap Color
50986	16 oz. (459 g)	black

Multi-Purpose Cleaner-Degreaser

- Specially formulated solvent for industrial and maintenance cleaning on grime, grease, lubrication fluids, silicone, tars, adhesives and fluxes.
- Effectively cleans jaws on Klein's Chicago® grips.
- Evaporates without leaving a residue, and is essentially non-conductive, non-corrosive and non-staining.
- Suitable for use in electrical maintenance as a replacement for 1,1,1-trichloroethane, but is slower drying.
- Harmless to most plastics. (Test small area of plastic first).
- Aerosol can, with plastic straw and adjustable flow (low, medium, high) nozzle.



50985

Cat. No.	Net Weight	Cap Color
50985	10.5 oz. (298 g)	white

Hand Cleaners

Klein Hand Cleaners

- Contain premium grade cleansing ingredients.
- Natural formulations are free of petroleum solvents and contain an antimicrobial agent.
- Efficiently and effectively remove inks, oil, paint, silicone sealants and many other hard to remove soils.
- Use with or without water.
- Comply with USA VOC regulations.



51431



51432



51433



51434

Cat. No.	Description	Scent	Skin Conditioners	Container Size	Weight (lbs.)
51431	Heavy-Duty Pumice Hand Cleaner	citrus	6	15 fl. oz. squeeze bottle (433.5 ml)	1.25
51432	Orange Pumice Hand Cleaner	orange	5	15 fl. oz. squeeze bottle (433.5 ml)	1.25
51433	Orange Smooth Hand Cleaner	orange	5	15 fl. oz. squeeze bottle (433.5 ml)	1.25
51434	Orange Pumice Hand Cleaner	orange	5	1 gallon bottle with dispenser pump (3.8 liters.)	9.25

Klein Kleeners® Hand Cleaning Towels

- Simple and convenient.
- Pre-moistened towels.
- No rinsing – no drying – no residue.
- Powerful, yet gentle, pumice-like cleaning action.
- Quickly loosens, dissolves, and absorbs dirt and grease.
- Features a natural citrus solvent that's gentler than petroleum-based hand cleaners.



51426



51425

Cat. No.	Container Size	Towel Size	Weight (lbs.)
51425	72-count bucket	10-1/2" x 12-1/4" (267 mm x 311 mm)	2.45
51426	10-pack	9" x 11" (229 mm x 279 mm)	.23

▲ WARNING: It is important that users of this product read, understand, and follow all instructions, cautions, and warnings attached to and/or packed with the product.



Important information for everyone who uses hand tools...fully illustrated pages of basic facts and practical "how-to" tips.



Prepared by KLEIN TOOLS in conjunction with the Hand Tools Institute. Available from your Klein distributor (Cat. No. 98016).

Warranty

Klein products in this catalog, manufactured and sold for commercial or industrial uses, are warranted to be free from defects in materials and workmanship for the normal life of the product, with the exception of: I. Cordomatic® products; and II. Ratcheting Cable Cutters, Models 63060, 63600, 63700, 63750, and 63800ACSR which are warranted for one year from the date of purchase. The following consumable products are warranted to be free from defects in materials and workmanship when delivered to the customer: Triple-Taps, Drill Bits, Klein Unibits®, Hole Saws and Arbors; Saw Blades and Jab Saws; disposable Razor and Knife Blades; Stripper Cartridges, Replaceable Cutting Inserts, Bits and Blades; Klein Chemicals, Hand Cleaners and Wire Pulling Lubricant. **THERE ARE NO IMPLIED WARRANTIES OF MERCHANTABILITY OR FITNESS.** At its option Klein will repair or replace, or refund the purchase price of, any product which fails to conform to this warranty under normal use and service. **In no event shall Klein be liable for incidental or consequential damage.**

If your Klein product requires repair or for information on how to exercise your rights under the terms of this warranty, please contact Klein Tools at 1-800-553-4676.

Warranty Returns

All warranty returns must include a Warranty Return Authorization (WRA) number. The WRA for the U.S. can be obtained by calling Customer Service at 1-800-553-4676. (International call 1-847-821-5500) or email serviceonline@kleintools.com.

Specifications of all products in this catalog are subject to Change without notice.

Dimensions shown for all forged products in this catalog are as precisely accurate as possible, but subject to very slight variations that are unavoidable in forging and grinding operations. Dimensions of Klein forged tools and all other tools and equipment are always within commercial tolerances recognized for such products.



Pros know the difference™



Utility Catalog

**AMERICA
DEPENDS
on LINEMEN**

**LINEMEN
DEPEND
on Klein Tools**

**KLEIN
TOOLS®**

www.kleintools.com

Klein Tools, Inc.
450 Bond Street
Lincolnshire, IL 60069
Phone: 800.553.4676 / 847.821.5500
Fax: 800.553.4876 / 847.478.0625