



ALLIED
MOULDED
PRODUCTS, Inc.



THE CONTRACTOR'S CHOICE

Nonmetallic Wall, Floor, & Ceiling Boxes
FOR RESIDENTIAL CONSTRUCTION

RESIDENTIAL CATALOG 2018



fiberglassBOX™

flexBOX.

What's New?

SLIDERBOX® Floor Box

We've expanded our line of floor boxes to include the new SLIDERBOX® floor box options with flip lid covers. The new floor boxes are designed with Allied Moulded's patented SLIDERBOX feature, and can be adjusted to fit a variety of flooring installation applications.

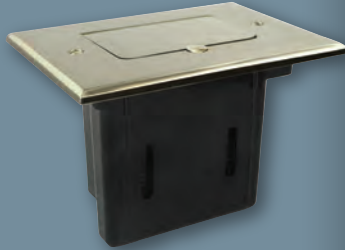

Learn more on page 44

Vapor Seal Fixture Support

New vapor seal boxes have been added to our growing line of air-sealed electrical outlet boxes and include factory installed ground straps! Vapor seal boxes aid in sealing up exterior walls and provide an efficient solution to air leakage.



Learn more on page 29

Steel Fan Boxes

We've added steel fan boxes along side our popular fiberglass box products. The new boxes are available in a bottom-mount or adjustable bar hanger option, and feature a rigid fan and fixture rating!

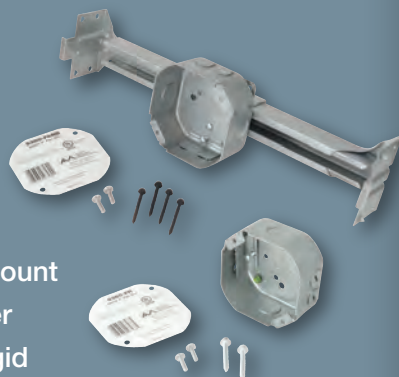

Learn more on page 27

FIBERGLASS:

THE DIFFERENCE IS ELEMENTAL

FIBERGLASS BOXES FOR RESIDENTIAL CONSTRUCTION

Like so many of the products Allied Moulded creates, our robust fiberglassBOX™ series of impact-resistant, high strength fiberglass reinforced polyester (FRP) wall boxes were specifically designed with the electrical contractor in mind. Fire-resistant, soundproof and air-sealed, these hard-working yet lightweight fiberglass boxes don't have the same installation limitations as PVC boxes. This eliminates the need for costly additional materials and labor, and provides you with the long-term savings you're looking for in your wall applications.

To learn more, visit alliedmoulded.com.

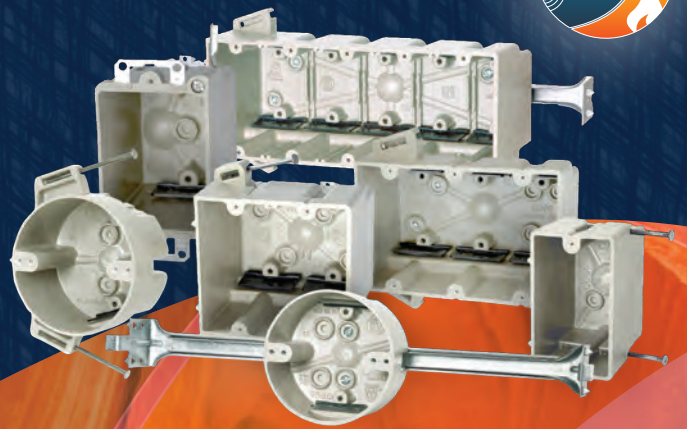

Fire Rated
FOR MORE APPLICATIONS

Industry Exclusive Fire Rating Turns Up the Heat on the Competition



Sound Resistant
WITHOUT ADDITIONAL MATERIALS

Sound Transmission Class Rating Quietly Saves You Even More



Air-Sealed
FOR ENERGY EFFICIENCY

Increased Energy Savings, Reduced Installation Costs

Wiring Size Cubic Inch Requirements 2

fiberglassBOX™ Features 3

Reduction In Horizontal Box Separation
In Fire Resistive Wall/Ceiling Assemblies 4

Frequently Asked Questions (FAQ's) 5

Speed "K" Klamp™ 6

Attachment Codings 7

fiberglassBOX™ Residential Switch & Outlet Boxes

Single Gang 8-10

Handy Box & Covers 10

Two Gang 11-12

Three Gang 13-14

Four Gang 15-16

Five Gang 17

Square Junction Boxes 18

Range/Dryer Receptacle Box 18

Plaster Rings and Covers 18

3-½" Round Ceiling Boxes 19-22

4" Round Ceiling Boxes 23-25

Fan and Fixture Support Boxes 26-27

Vapor Seal Air-Sealed Electrical Boxes .. 28-29

SLIDERBOX® Adjustable Boxes

Features & Installation Instructions 30

Wall/Ceiling Boxes for New & Old Work 31



View our catalog online:

- Quickly drill down to your product of interest
- Print product specification sheets
- Quickly find a rep or distributor

flexBOX® Residential Switch & Outlet Boxes

flexBOX® Features 32

Single Gang 33

Two Gang 34

Three Gang 34

Four Gang 34

Square Junction Boxes 35

Plaster Rings and Cover 35

3-½" Round Ceiling Boxes 36

4" Round Ceiling Boxes 36

Accessories

Bulk Clamps, Ground Straps, Panel Stops,
Low Voltage Partitions, Templates 37

Installation Instructions

For Flush Device & Round Outlet Boxes .. 38-39

Structured Cable/Low Voltage 40

PARA-form® Siding Boxes 41

Lampholders

(Incandescent & GU-24 2-PIN Base) 42

CFLs (Compact Fluorescent Luminaires) 43

Floor Box Assemblies

SLIDERBOX® Floor Box 44

Single Gang 46-47

Two Gang 48-49

Round Profile 50-51

Concrete Adapter Kit 52

Competitive Cross Reference

Fiberglass Boxes 53-57

Paddle Fan Support Boxes 57

Vapor Seal Boxes 58

Adjustable Boxes 58

Thermoplastic Boxes 59-60

Index 60-61

References 62

UL® Certified Test Lab 63

Notes 64



Cubic Inch Requirements

Allied Moulded's boxes are designed for use with 14-2 through 10-3 nonmetallic sheathed cable with ground.

To calculate cubic inch requirements, make allowance of 2 conductors for each device and 1 for clamps, 1 for ground wire.

For example, the cubic inch requirement for no. 10-3 wire being used for a single device with a ground wire and one clamp would be 4 conductors for a requirement of 10.00 cubic inches.

Number of Conductors	Cu. In. Req'd for No. 14 Wire	Cu. In. Req'd for No. 12 Wire	Cu. In. Req'd for No. 10 Wire
1	2.00	2.25	2.50
2	4.00	4.50	5.00
3	6.00	6.75	7.50
4	8.00	9.00	10.00
5	10.00	11.25	12.50
6	12.00	13.50	15.00
7	14.00	15.75	17.50
8	16.00	18.00	20.00
9	18.00	20.25	22.50
10	20.00	22.50	25.00
11	22.00	24.75	27.50
12	24.00	27.00	30.00
13	26.00	29.25	32.50
14	28.00	31.50	35.00
15	30.00	33.75	37.50
16	32.00	36.00	40.00
17	34.00	38.25	42.50
18	36.00	40.50	45.00
19	38.00	42.75	47.50
20	40.00	45.00	50.00

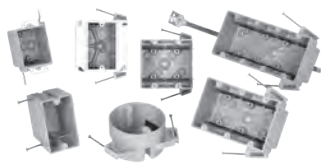

Allied Moulded switch and outlet boxes are molded of impact-resistant, high-strength fiberglass reinforced thermoset polyester material. Our fiberglassBOX™ “Premier Series” line of

products was created for the electrical contractor looking for nonmetallic outlet boxes with “hard box” characteristics. Allied Moulded’s fiberglassBOX line offers the following advantages:

- Non-corrosive
- Non-conductive, no ground required
- Non-distorting in high heat
- Will not melt
- Shatter resistant in cold temperatures
- Lightweight
- Heat insulator

2-Hour Wall and Ceiling Fire Classification

All Allied Moulded fiberglass boxes, including our 5305 five gang box, are classified by Underwriters Laboratories (UL®) for use in 2-hour rated walls or ceilings.

Labor Saving Features

With innovative products designed for the electrical contractor, Allied Moulded offers the largest, most complete line of box sizes and attachment brackets in the industry for a wide variety of applications. A few of the most popular attachments are:

- The “S” snap bracket or a “W” wing bracket for secure, old work box installation
- “BH” and 16” adjustable bar hangers for maximum support of ceiling boxes used for fixture support
- “Z” brackets with metal spurs to fasten wall boxes to wood or steel studs
- The “B” adjustable stabilizing bar, available on 3, 4 or 5 gang boxes, for more secure mounting used in conjunction with nails or “Z” brackets

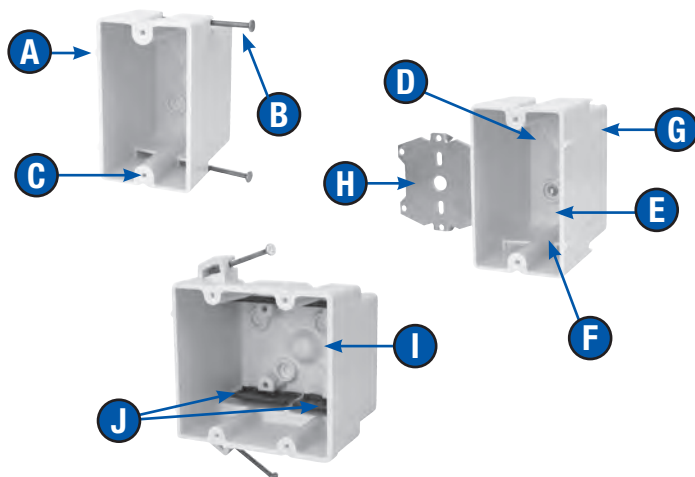

During an actual fire test set up in a UL laboratory, Allied Moulded boxes passed all of the test criteria outlined in UL Standard 263 for both walls and ceilings.



Backed by even more UL® testing, the horizontal box separation requirement outlined in the Uniform Building Code™ can be reduced to as little as three inches without using any additional fire resistive protection. Allied Moulded fiberglass boxes, up to and including two three-gangs, can be mounted in the same stud cavity of fire rated walls **with absolutely no additional fire resistant protection needed.** In fact, only Allied Moulded has documentation covering all 52 U300 Series wall configurations, eliminating the need for additional putty pads, mineral wool insulation or alternate construction saving the contractor both time and money. See pages 4 and 5 for more information.

Look for our classification CEYY “Outlet Boxes and Fittings Classified for Fire Resistance” on our website at www.alliedmoulded.com or in the UL® online certification directory at www.ul.com. Additional documentation from these testing processes is available for examination upon request.



Learn more about our fiberglassBOX™ series online

- A. Offset gauge marks on box give positive stop for the proper wall thickness
- B. Bright common nails or pierce-point screws fit securely in specially designed supports and are angled for easy installation
- C. Strip-resistant, tapered and machine tapped device holes allow device screw to be started by hand and speed installation time with adjustable torque screwdrivers
- D. Cubic inch capacity clearly marked and easy for contractor and inspector to locate and identify
- E. Proudly UL® listed
- F. Knockouts on fiberglass boxes are complete, reducing drafts and are easily removed with wire for no-tool installation
- G. Leveling ribs position face of box parallel to wall surface
- H. “Z” brackets are designed to securely hold box to wood or steel studs; brackets also provide proper ¼” or ½” offset
- I. 2-Hour Fire Rated clearly marked for easy inspector identification
- J. Nonmetallic Speed “K” Klamps™ dependably secure wire in box (if a knockout is inadvertently opened and not used, the Speed “K” Klamp is considered sufficient closure of the opening per UL®)

We Can Stand the Heat

Reduction in Horizontal Box Separation in Fire Resistive Wall & Ceiling Assemblies



ALLIED MOULDED PRODUCTS, Inc.

You can mount Allied Moulded outlet boxes* in the same stud cavity without any additional fire resistive protection!



We've been telling you for years that Allied Moulded fiberglass outlet boxes can truly take the heat. Now there's solid proof, backed by Underwriters Laboratories (UL®) test results. When penetrating all U300 Series fire resistive wall assemblies (including staggered stud) with Allied Moulded outlet boxes, up to and including our three gang boxes, you can now mount two boxes in the same stud cavity on opposite sides of the wall without using any additional protection. That's right – no mineral wool batt or putty pads needed to insulate the box. **Absolutely no additional fire resistant protection required!** Prime application examples include a wall between multi-family dwellings.



Watch our latest video on horizontal wall box placement

In this or any other application, Allied Moulded outlet boxes are proven so reliable you can feel confident using them for all your outlet box needs. Look for our classification CEYY "Outlet Boxes and Fittings Classified for Fire Resistance" on our web site at www.alliedmoulded.com or in the UL® online certification directory at www.ul.com. Additional documentation from these testing processes is available for examination upon request.

**Up to and including three gang boxes*

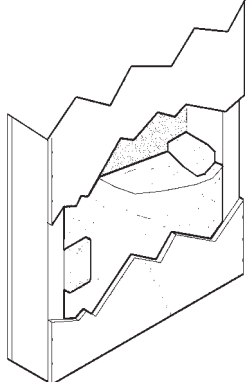
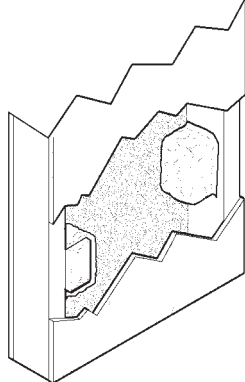
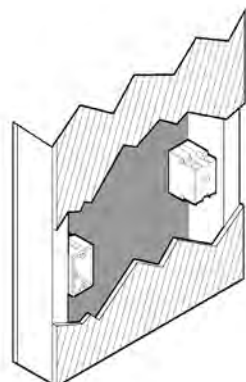
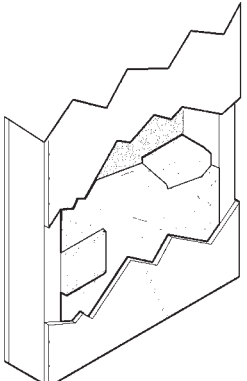
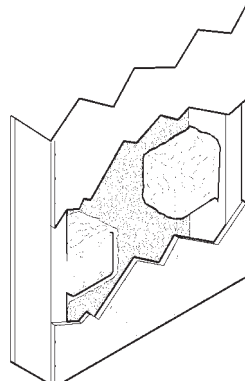
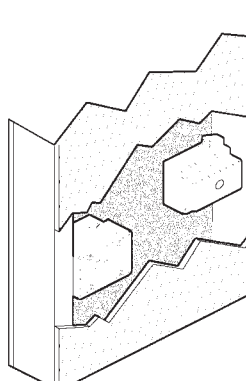
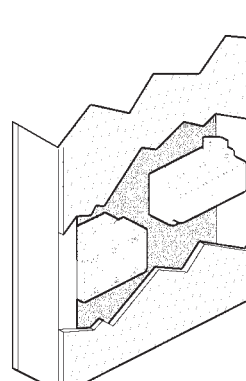
	Thermoplastic Boxes		Allied Moulded Fiberglass Boxes	
Single Gang	 <p>COMPETITION 2 BOXES SAME STUD CAVITY MINERAL WOOL BATT REQUIRED</p>	 <p>COMPETITION 2 BOXES SAME STUD CAVITY PUTTY PADS REQUIRED</p>	 <p>ALLIED MOULDED 2 BOXES SAME STUD CAVITY NO ADDITIONAL FIRE RESISTIVE MATERIAL REQUIRED</p>	
Two Gang	 <p>COMPETITION 2 BOXES SAME STUD CAVITY MINERAL WOOL BATT REQUIRED</p>	 <p>COMPETITION 2 BOXES SAME STUD CAVITY PUTTY PADS REQUIRED</p>	 <p>ALLIED MOULDED 2 BOXES SAME STUD CAVITY NO ADDITIONAL FIRE RESISTIVE MATERIAL REQUIRED</p>	
Three Gang	<p>NOT RATED for use in same stud cavity</p>		 <p>ALLIED MOULDED 2 BOXES SAME STUD CAVITY NO ADDITIONAL FIRE RESISTIVE MATERIAL REQUIRED</p>	

Frequently Asked Questions

Reduction in Horizontal Box Separation in Fire Resistive Wall & Ceiling Assemblies



ALLIED
MOULDED
PRODUCTS, Inc.

1 In what type of construction would this rating apply?

This rating applies where nonmetallic sheathed cable is used and walls are constructed of wood and non-load-bearing steel studs and gypsum.

2 Can all boxes marked with a 2-hour wall rating be installed in the same manner?

No. A box that is marked with 2-hour wall rating means that you can install the box in a 2-hour fire resistive wall or walls with less than 2-hour rating. To find out details of the installation, you must read the instructions found in the UL® Fire Resistive Directory or from the UL® card provided by the manufacturer.

The Directory/UL® card describes the following:

- Those boxes suitable for use in the wall by basic model number
- The maximum size opening in square inches
- The maximum openings in total square inches per 100 square feet
- The maximum clearance around the box
- The type construction of the wall assembly – “wood studs and gypsum”
- The wall designs such as “U-300 Series” meaning all wall designs found in the UL Fire Resistive Directory from U-301 through U-370, including those staggered stud designs and separated wall designs
- Horizontal separation when mounted on opposite sides of the wall
- Cover plate material (when limited)

3 What is the maximum size box that can go into the same stud cavity?

Paragraph #2 of the card states for those fire resistive wall designs with or without insulation, the maximum size box is a 3 gang 3300, 3303, 9313 (22.0 sq. in.). These boxes can be mounted in all U-300 Series walls with a horizontal separation of three inches when boxes are mounted on opposite sides of the wall. Note: This does include staggered stud construction.

4 Does this rating apply to staggered stud configuration?

Yes. U-300 Series walls have both staggered stud designs in addition to separated type walls.

5 Will I still need to use mineral wool or fiberglass insulation?

The wall assembly design dictates the need for insulation. The wall design does not change when penetrated by Allied Moulded outlet boxes.

6 What if I am actually putting double drywall in the middle to help with sound?

If the wall is constructed of wood studs and gypsum board and is a 2-hour or less fire resistive rated, the penetration with an Allied Moulded outlet box will not cause the wall to be derated as long as it is installed according to instructions.

7 Can I put the boxes back to back?

The Fire Resistive card says the boxes must be separated by three inches horizontal separation but not back to back.

8 Do you still have to caulk the knockouts that are penetrated by the wire?

Boxes were tested with nonmetallic sheathed cable installed. No caulk is necessary where knockouts are penetrated by the nonmetallic sheathed cable.

9 If I accidentally open a knockout I do not need, do I need to caulk it?

The National Electrical Code requires all unused open knockouts to be closed. Allied Moulded’s Speed “K” Klamp™ is an accepted means of closing the knockout (documentation available upon request). Open, unused knockouts in boxes without Speed “K” Klamps would need to be closed.

10 Is there a rating that relates to vertical separation?

No, not as of this printing.

11 Does this apply to ceiling configurations also?

The instructions for ceiling penetrations are found on the same documentation as the wall boxes; however, the instructions are different.

12 Does this apply to low voltage devices?

The fire resistive rating is for Allied Moulded boxes penetrating fire resistive walls classified at 2 hours or less. What is placed inside the box is covered by the National Electrical Code and does not affect the fire resistive rating of the box.

13 Which inspector will be enforcing this code? Electrical or Building or Fire?

Minimum horizontal box separation is a requirement of the applicable building code. Generally, the electrical inspector will view the installation first, but final compliance falls on the building inspector.

Please contact our Technical Support Department for clarification on this listing or to address any further questions.



Virtually eliminate clamp breakage during knockout • Easy no-tool installation • Secures wires quickly and dependably

Punching through the knockouts on ordinary electrical boxes often requires a screwdriver and leads to damaged clamps that compromise a box's safety and code compliance.¹ But Allied Moulded's Speed “K” Klamps™ eliminate the risk and problem of broken clamps. Fast, easy entry knockouts can be pushed through with the wire. No tools required. No broken clamps. It's a one-two punch that leaves the competition down for the count.

Allied Moulded offers a unique nonmetallic wire clamping system featuring UL® listing, faster installation, and a no cost way of meeting National Electrical Code requirements. Should a knockout be inadvertently opened and not used, the Speed “K” Klamp is considered sufficient closure of the opening per UL®. Documentation is available upon request.

¹ Reference 2008 NEC 314.17(C)

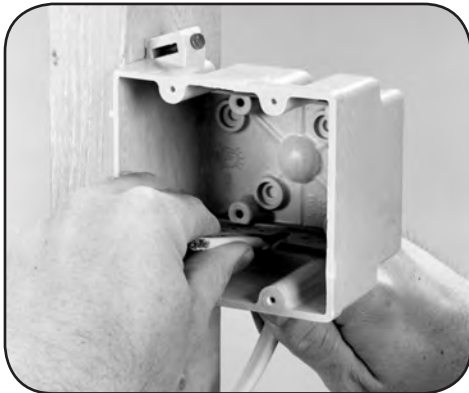

1. Remove the knockout and prepare the conductors to enter the box per NEC.

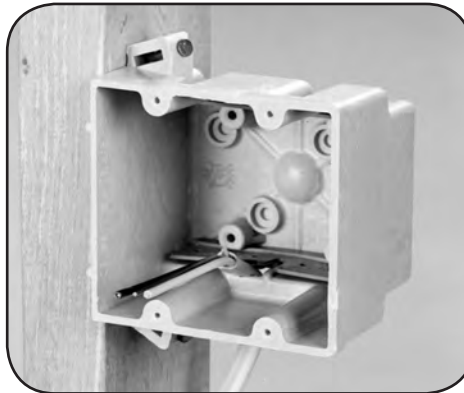

2. Insert the conductors from the outside of the box into the appropriate knockout and **OVER THE TOP** of the Speed “K” Klamp until the outer jacket extends at least ½" past the top of the clamp.



3. Bend wire 90° over Speed “K” Klamp.
4. Pull wire from outside of box to ensure Speed “K” Klamp engagement.



Component Descriptions and Ordering Information

At Allied Moulded, we want it to be as easy as possible for you to locate the right outlet boxes to meet your needs. Most Allied Moulded boxes can be manufactured with these letter coded components. For example, steel stud screws may be ordered when applicable by adding the suffix "SS" to the basic catalog number, i.e., 1098-SS.

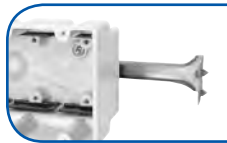

B The **adjustable stabilizing bar** is available on the 3, 4 and 5 gang boxes and used in conjunction with nails or "Z" hangers.



G The **grounding strap** on outlet boxes permits the lighting fixture to be grounded when necessary. Available on round boxes.



S The **snap bracket** pushes through an opening in wallboard, then snaps out on the back side.

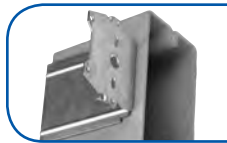

Z The "**Z**" **hanger**, which mounts on stud face, has spurs to secure the hanger to wood and steel studs.

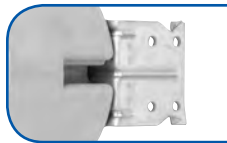

HL The "**HL**" **hanger**, which mounts on the side of the stud or joist, has spurs which hold the hanger to the joist for easier nailing.



SS Pierce-point sheet metal **screws** are installed for easy penetration of non-load-bearing steel studs 22 gauge or lighter.



2Z "**Z**" **hangers** are installed on both sides of the box.



V **Vapor Seal**, polyurethane seal for use in **single sheet** drywall applications.

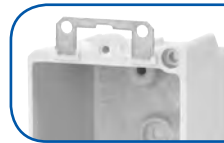

E Metal **ears** are securely molded into the box.



N **Nails** are installed as fastening devices. Fetter ring nails, when offered, allow for extra strength when nailed into stud or joist.



W When **wing bracket** screws are tightened, the box is drawn firmly against the wall.



HF "**HF**" **hanger**, which mounts flush on the side of the stud, has spurs to hold the hanger to the stud for easier nailing.



HN With the "**HN**" **hanger**, application is quick and easy because nails are installed.



BH The **bar hanger** is an adjustable bar assembly for either **16"** or **24"** joist spacing.



16 This **bar hanger** is specifically designed for box location in maximum **16"** joist spacing.



V2 **Vapor Seal**, polyurethane seal for use in **double 5/8"** drywall applications.

Factory Installed Clamps



Speed "K" Klamp™

Catalog numbers with the suffix "K" indicates factory installed nonmetallic Speed "K" Klamps™.



"C" Clamp

Catalog numbers with the suffix "C" indicate factory installed wire clamps. The number following the "C" indicates the number of wire clamps (i.e., "C4" = 4 wire clamps).



9324-N



1096-N



1096-NR (top view)



1098-N



9327-N



1099-N



1099-NRED

Nail-On

Cu. In. Volume	Catalog Number	Component Description	Exterior Dimensions			UPC# 85339	Std. Pkg. Qty.	Std. Wt. (lb.)
			D	W	H			
12.0	9324-N	 Nails	1-3/4	2-3/8	4-1/8	10165	100	27
18.0	1096-N	Internal mid-nails	3	2-1/4	3-13/16	24414	100	32
18.0	1096-NR	 Reverse nails	3	2-1/4	3-13/16	24413	100	32
20.5	1098-N	Angled mid-nails	3-1/4	2-1/4	3-13/16	25001	100	34
20.5	1098-NR	 Reverse nails	3-1/4	2-1/4	3-13/16	25007	100	34
20.5	9327-N	Back nails	3-1/4	2-3/8	3-5/8	10195	50	17
22.5	1099-N	Angled mid-nails	3-9/16	2-1/4	3-27/32	26000	100	39
22.5	1099-NR	 Reverse nails	3-9/16	2-1/4	3-27/32	26009	50	20
22.5	1099-NRED	Angled mid-nails, *molded in red for fire circuits	3-9/16	2-1/4	3-27/32	96500	24	10



1096-SS



1098-SS



1099-SS



1096-Z2



1098-Z4



1098-Z4H

Steel Stud Screws

Cu. In. Volume	Catalog Number	Component Description	Exterior Dimensions			UPC# 85339	Std. Pkg. Qty.	Std. Wt. (lb.)
			D	W	H			
18.0	1096-SS	Steel stud screws for use with non-load-bearing studs 22 gauge or lighter	3	2-1/4	3-13/16	24421	100	32
20.5	1098-SS	Steel stud screws for use with non-load-bearing studs 22 gauge or lighter	3-1/4	2-1/4	3-13/16	25009	100	34
22.5	1099-SS	Steel stud screws for use with non-load-bearing studs 22 gauge or lighter	3-9/16	2-1/4	3-27/32	26001	100	39

"Z" Hanger

Cu. In. Volume	Catalog Number	Component Description	Exterior Dimensions			UPC# 85339	Std. Pkg. Qty.	Std. Wt. (lb.)
			D	W	H			
18.0	1096-Z2	1/4" offset, "Z" hanger	3	2-1/4	3-13/16	24402	50	25
18.0	1096-Z4	1/2" offset, "Z" hanger	3	2-1/4	3-13/16	24406	50	25
20.5	1098-Z2	1/4" offset, "Z" hanger	3-1/4	2-1/4	3-13/16	25030	50	27
20.5	1098-Z4	1/2" offset, "Z" hanger	3-1/4	2-1/4	3-13/16	25040	50	27
20.5	1098-Z4H	1/2" offset, horizontal mount "Z" hanger	3-1/4	2-1/4	3-13/16	25025	50	20
22.5	1099-Z4	1/2" offset, "Z" hanger	3-9/16	2-1/4	3-27/32	26003	50	29

All dimensions are in inches unless otherwise noted.
See page 7 for Attachment Coding suffix descriptions.

 Old Work/Manufactured Housing Boxes

 Flush-Device Box
UL File No. E30594



9301-E



9331-EC2



9331-EK



9361-EK



9363-EK



9366-EK



9368-EK

Ears

Cu. In. Volume	Catalog Number	Component Description	Exterior Dimensions			UPC# 85339	Std. Pkg. Qty.	Std. Wt. (lb.)
			D	W	H			
9.0	9301-E	Ears, 2 wire clampss - bulk packed	1-3/4	2-3/8	3-1/4	10010	100	23
9.0	9301-EC2	Ears, 2 wire clamps - factory installed	1-3/4	2-3/8	3-1/4	10011	100	26
14.0	9331-E	Ears, Speed Klamps™- bulk packed	2-1/2	2-3/8	3-1/4	10235	100	28
14.0	9331-EC2	Ears, 2 wire clamps - factory installed	2-1/2	2-3/8	3-1/4	10236	100	31
14.0	9331-EK	Ears, Speed Klamps™ - factory installed	2-1/2	2-3/8	3-1/4	10239	100	28
16.0	9361-E	Ears, Speed Klamps™ - bulk packed	2-7/8	2-3/8	3-1/4	10555	100	29
16.0	9361-EC2	Ears, 2 wire clamps - factory installed	2-7/8	2-3/8	3-1/4	10560	100	33
16.0	9361-EK	Ears, Speed Klamps™ - factory installed	2-7/8	2-3/8	3-1/4	10561	100	29
16.0	9363-E	Ears, Speed Klamps™- bulk packed	2-27/32	2-3/8	3-1/4	10570	100	30
16.0	9363-EC2	Ears, 2 wire clamps - factory installed	2-27/32	2-3/8	3-1/4	10571	100	32
16.0	9363-EK	Ears, Speed Klamps™- factory installed	2-27/32	2-3/8	3-1/4	10576	100	30
18.0	9366-EK	Wide body box, ears, Speed Klamps™ - factory installed *Requires oversized device/receptacle plate	2-27/32	2-3/4	3-1/4	77003	100	32
18.0	9368-E	Ears, Speed Klamps™- bulk packed	3-3/16	2-3/8	3-1/4	76000	100	31
18.0	9368-EK	Ears, Speed Klamps™- factory installed	3-3/16	2-3/8	3-1/4	76003	100	32



9331-ES



9331-ESC2



9331-ESK



9361-ES



9361-ESC2



9361-ESK

Ears & Snap Brackets

Cu. In. Volume	Catalog Number	Component Description	Exterior Dimensions			UPC# 85339	Std. Pkg. Qty.	Std. Wt. (lb.)
			D	W	H			
14.0	9331-ES	Ears, snap bracket, Speed Klamps™ - bulk packed	2-1/2	2-3/8	3-1/4	10242	50	21
14.0	9331-ESC2	Ears, snap bracket, 2 wire clamps - factory installed	2-1/2	2-3/8	3-1/4	10244	50	23
14.0	9331-ESK	Ears, snap bracket, Speed Klamps™ - factory installed	2-1/2	2-3/8	3-1/4	10243	50	21
16.0	9361-ES	Ears, snap bracket, Speed Klamps™ - bulk packed	2-7/8	2-3/8	3-1/4	10562	50	22
16.0	9361-ESC2	Ears, snap bracket, 2 wire clamps - factory installed	2-7/8	2-3/8	3-1/4	10564	50	23
16.0	9361-ESK	Ears, snap bracket, Speed Klamps™ - factory installed	2-7/8	2-3/8	3-1/4	10566	50	23







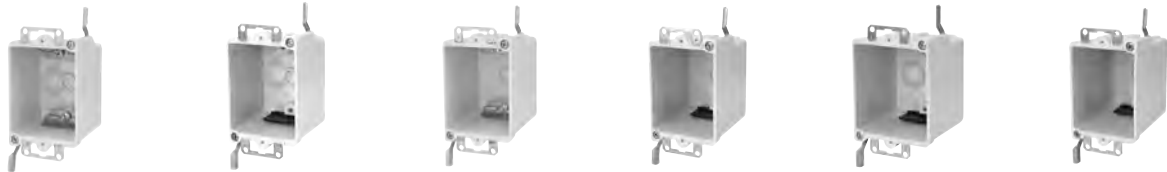



All dimensions are in inches unless otherwise noted.
See page 7 for Attachment Coding suffix descriptions.

Old Work/Manufactured Housing Boxes

Flush-Device Box
UL File No. E30594



9331-EWC2 9331-EWK 9363-EWC2 9363-EWK 9366-EWK 9368-EWK

	Cu. In. Volume	Catalog Number	Component Description	Exterior Dimensions			UPC# 85339	Std. Pkg. Qty.	Std. Wt. (lb.)
				D	W	H			
Ears & Wing Brackets	14.0	9331-EW	 Ears, wing brackets, Speed Klamps™ - bulk packed	2-½	2-3/8	3-¼	38500	100	30
	14.0	9331-EWC2	 Ears, wing brackets, 2 wire clamps - factory installed	2-½	2-3/8	3-¼	38510	100	33
	14.0	9331-EWK	 Ears, wing brackets, Speed Klamps™ - factory installed	2-½	2-3/8	3-¼	38511	100	31
	16.0	9363-EW	 Ears, wing brackets, Speed Klamps™ - bulk packed	2-27/32	2-3/8	3-¼	10572	100	32
	16.0	9363-EWC2	 Ears, wing brackets, 2 wire clamps - factory installed	2-27/32	2-3/8	3-¼	10573	100	36
	16.0	9363-EWK	 Ears, wing brackets, Speed Klamps™ - factory installed	2-27/32	2-3/8	3-¼	10578	100	33
	18.0	9366-EW	 Wide body box, ears, wing brackets, Speed Klamps™ - bulk packed *Requires oversized device/receptacle plate	2-27/32	2-¾	3-¼	77001	100	34
	18.0	9366-EWK	 Wide body box, ears, wing brackets, Speed Klamps™ - factory installed *Requires oversized device/receptacle plate	2-27/32	2-¾	3-¼	77002	100	35
	18.0	9368-EW	 Ears, wing brackets, Speed Klamps™ - bulk packed	3-3/16	2-3/8	3-¼	76002	100	32
	18.0	9368-EWK	 Ears, wing brackets, Speed Klamps™ - factory installed	3-3/16	2-3/8	3-¼	76001	100	34

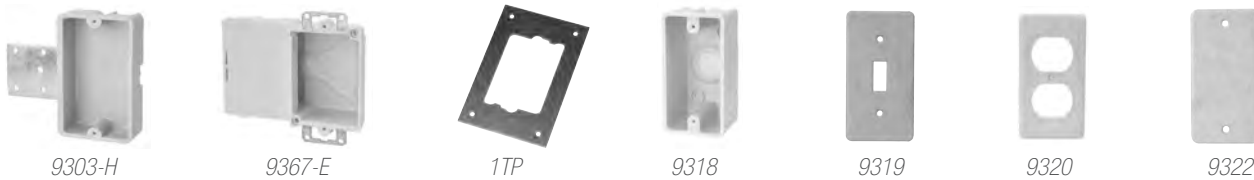

9303-H

9367-E



1TP

9318

9319

9320

9322

	Cu. In. Volume	Catalog Number	Component Description	Exterior Dimensions			UPC# 85339	Std. Pkg. Qty.	Std. Wt. (lb.)
				D	W	H			
Miscellaneous	6.0	9303-H	Side mount hanger, ¼" offset, not UL® listed	1-1/16	2-¼	3-5/8	10021	100	20
	16.0	9367-E	 Side cube box, ears	1-11/16	2-3/8 open 4-15/16 overall	3-¼	75600	50	17
	16.0	9367-EW	 Side cub box, ears, wing brackets	1-11/16	2-3/8 open 4-15/16 overall	3-¼	75601	50	18
	—	1TP	 Metal template for single gang old work box: Series 9331-E, 9363-E, & 9368-E	0.062	4	6	88015	1	1

	Cu. In. Volume	Catalog Number	Component Description	Exterior Dimensions			UPC# 85339	Std. Pkg. Qty.	Std. Wt. (lb.)
				D	W	H			
Handy Box & Covers	12.5	9318	Handy Box surface mounted box with side and bottom cable openings	2	2-¼	4-3/16	10140	100	28
	—	9319	Handy Box switch cover, not UL® listed	—	2-¼	4-¼	10145	100	8
	—	9320	Handy Box duplex outlet cover, not UL® listed	—	2-3/16	4-¼	10146	100	7
	—	9322	Handy Box blank cover, not UL® listed	—	2-3/16	4-3/16	10148	100	7

All dimensions are in inches unless otherwise noted.
See page 7 for Attachment Coding suffix descriptions.

 Old Work/Manufactured Housing Boxes

 Flush-Device Box
UL File No. E30594

fiberglass BOX™ Two Gang

Residential Switch or Receptacle Box



	Cu. In. Volume	Catalog Number	Component Description	Exterior Dimensions			UPC# 85339	Std. Pkg. Qty.	Std. Wt. (lb.)
				D	W	H			
Nail-On	30.0	9372-NMHK	 Angled mid-nails, 3/16" panel stops, Speed Klamps™ - factory installed	2-3/4	4	3-3/4	10683	48	26
	32.5	2300-N	Angled mid-nails, Speed Klamps™ - bulk packed	3	4	3-3/4	12125	48	28
	32.5	2300-NC2	Angled mid-nails, 2 wire clamps - factory installed	3	4	3-3/4	12135	48	29
	32.5	2300-NC4	Angled mid-nails, 4 wire clamps - factory installed	3	4	3-3/4	12145	48	31
	32.5	2300-NK	Angled mid-nails, Speed Klamps™ - factory installed	3	4	3-3/4	12127	48	28
	37.0	2302-N	Angled mid-nails, Speed Klamps™ - bulk packed	3-7/16	4	3-3/4	13060	48	30
	37.0	2302-NC2	Angled mid-nails, 2 wire clamps - factory installed	3-7/16	4	3-3/4	13065	48	31
	37.0	2302-NC4	Angled mid-nails, 4 wire clamps - factory installed	3-7/16	4	3-3/4	13070	48	33
	37.0	2302-NK	Angled mid-nails, Speed Klamps™ - factory installed	3-7/16	4	3-3/4	13075	48	30
	37.0	2302-NKRED	Angled mid-nails, Speed Klamps™ - factory installed, molded in red for fire circuits	3-7/16	4	3-3/4	96501	12	8

	Cu. In. Volume	Catalog Number	Component Description	Exterior Dimensions			UPC# 85339	Std. Pkg. Qty.	Std. Wt. (lb.)
				D	W	H			
Steel Stud Screws	32.5	2300-SS	Steel stud screws for use with non-load-bearing studs 22 gauge or lighter, Speed Klamps™ - bulk packed	3	4	3-3/4	12202	50	29
	32.5	2300-SSK	Steel stud screws for use with non-load-bearing studs 22 gauge or lighter, Speed Klamps™ - factory installed	3	4	3-3/4	12203	50	29
	37.0	2302-SS	Steel stud screws for use with non-load-bearing studs 22 gauge or lighter, Speed Klamps™ - bulk packed	3-7/16	4	3-3/4	13080	50	29
	37.0	2302-SSK	Steel stud screws for use with non-load-bearing studs 22 gauge or lighter, Speed Klamps™ - factory installed	3-7/16	4	3-3/4	13081	50	30

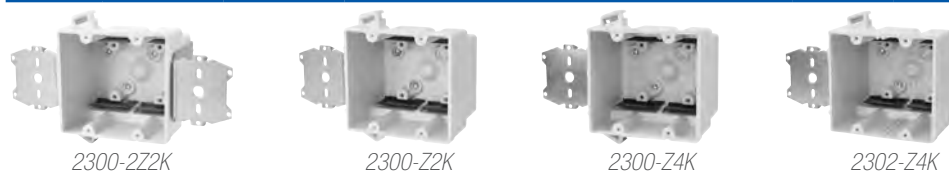

	Cu. In. Volume	Catalog Number	Component Description	Exterior Dimensions			UPC# 85339	Std. Pkg. Qty.	Std. Wt. (lb.)
				D	W	H			
"Z" Hanger	32.5	2300-Z22	1/4" offset, "Z" hanger each side of box, Speed Klamps™ - bulk packed	3	4	3-3/4	12500	12	13
	32.5	2300-Z22K	1/4" offset, "Z" hanger each side of box, Speed Klamps™ - factory installed	3	4	3-3/4	12501	12	13
	32.5	2300-Z2	1/4" offset, "Z" hanger, Speed Klamps™ - bulk packed	3	4	3-3/4	12400	50	39
	32.5	2300-Z2K	1/4" offset, "Z" hanger, Speed Klamps™ - factory installed	3	4	3-3/4	12401	50	39
	32.5	2300-Z4	1/2" offset, "Z" hanger, Speed Klamps™ - bulk packed	3	4	3-3/4	12700	50	38
	32.5	2300-Z4K	1/2" offset, "Z" hanger, Speed Klamps™ - factory installed	3	4	3-3/4	12701	50	39
	37.0	2302-Z4	1/2" offset, "Z" hanger, Speed Klamps™ - bulk packed	3-7/16	4	3-3/4	13082	50	40
	37.0	2302-Z4K	1/2" offset, "Z" hanger, Speed Klamps™ - factory installed	3-7/16	4	3-3/4	13083	50	42

All dimensions are in inches unless otherwise noted.
See page 7 for Attachment Coding suffix descriptions.

 Old Work/Manufactured Housing Boxes

 Flush-Device Box
UL File No. E30594



LVP-1



LVP-1 Installed

Low Voltage Partition	Catalog Number	Component Description	UPC# 85339	Std. Pkg. Qty.	Std. Wt. (lb.)
	LVP-1	Low voltage divider plate for use with 2302, 3303, 4304, 5305 Series and 9314 only. See 2008 NEC 800.133(A)(1)(c).		80000	50*

* Consists of ten (10) packages of five (5) pieces each.



9312-EK



9312-EWC2



9312-EWC4





9312-EWK



9329-EWK



2TP

Ears	Cu. In. Volume	Catalog Number	Component Description	Exterior Dimensions			UPC# 85339	Std. Pkg. Qty.	Std. Wt. (lb.)
				D	W	H			
	28.0	9312-E	 Ears, Speed Klamps™- bulk packed	2-¾	4-1/8	3-¼	10064	50	23
	28.0	9312-EK	 Ears, Speed Klamps™- factory installed	2-¾	4-1/8	3-¼	29112	50	24

Ears & Wing Brackets	Cu. In. Volume	Catalog Number	Component Description	Exterior Dimensions			UPC# 85339	Std. Pkg. Qty.	Std. Wt. (lb.)
				D	W	H			
	28.0	9312-EW	 Ears, wing brackets, Speed Klamps™- bulk packed	2-¾	4-1/8	3-¼	29100	50	25
	28.0	9312-EWC2	 Ears, wing brackets, 2 wire clamps - factory installed	2-¾	4-1/8	3-¼	29110	50	26
	28.0	9312-EWC4	 Ears, wing brackets, 4 wire clamps - factory installed	2-¾	4-1/8	3-¼	29120	50	28
	28.0	9312-EWK	 Ears, wing brackets, Speed Klamps™- factory installed	2-¾	4-1/8	3-¼	29111	50	25
	32.5	9329-EW	 Ears, wing brackets, Speed Klamps™- bulk packed	3-¼	4-1/8	3-¼	10801	50	27
	32.5	9329-EWK	 Ears, wing brackets, Speed Klamps™- factory installed	3-¼	4-1/8	3-¼	10802	50	27

Template	Catalog Number	Component Description	UPC# 85339	Std. Pkg. Qty.	Std. Wt. (lb.)
	2TP	 Metal template for two gang old work box: 9312-E series, 9329-E series	88016	1	2

All dimensions are in inches unless otherwise noted.
See page 7 for Attachment Coding suffix descriptions.

 Old Work/Manufactured Housing Boxes

 Flush-Device Box
UL File No. E30594

fiberglass BOX™ Three Gang

Residential Switch or Receptacle Box



3300-NC3



3300-NK



3303-NK



3300-NBC3



3300-NBK



3303-NBK

Nail-On	Cu. In. Volume	Catalog Number	Component Description	Exterior Dimensions			UPC# 85339	Std. Pkg. Qty.	Std. Wt. (lb.)
				D	W	H			
	46.0	3300-N	Angled mid-nails, Speed Klamps™ - bulk packed	3	5-11/16	3-3/4	14175	20	15
	46.0	3300-NC3	Angled mid-nails, 3 wire clamps - factory installed	3	5-11/16	3-3/4	14190	20	16
	46.0	3300-NC6	Angled mid-nails, 6 wire clamps - factory installed	3	5-11/16	3-3/4	14205	20	18
	46.0	3300-NK	Angled mid-nails, Speed Klamps™ - factory installed	3	5-11/16	3-3/4	14177	20	16
	56.5	3303-N	Angled mid-nails, Speed Klamps™ - bulk packed	3-9/16	5-11/16	3-3/4	15200	20	18
	56.5	3303-NC6	Angled mid-nails, 6 wire clamps - factory installed	3-9/16	5-11/16	3-3/4	15211	20	19
	56.5	3303-NK	Angled mid-nails, Speed Klamps™ - factory installed	3-9/16	5-11/16	3-3/4	15201	20	18

Nail-On with Bar	Cu. In. Volume	Catalog Number	Component Description	Exterior Dimensions			UPC# 85339	Std. Pkg. Qty.	Std. Wt. (lb.)
				D	W	H			
	46.0	3300-NB	Angled mid-nails, adjustable stabilizing bar, Speed Klamps™ - bulk packed	3	5-11/16	3-3/4	14210	20	21
	46.0	3300-NBC3	Angled mid-nails, adjustable stabilizing bar, 3 wire clamps - factory installed	3	5-11/16	3-3/4	14225	20	22
	46.0	3300-NBK	Angled mid-nails, adjustable stabilizing bar, Speed Klamps™ - factory installed	3	5-11/16	3-3/4	14212	20	21
	56.5	3303-NB	Angled mid-nails, adjustable stabilizing bar, Speed Klamps™ - bulk packed	3-9/16	5-11/16	3-3/4	15207	20	23
	56.5	3303-NBK	Angled mid-nails, adjustable stabilizing bar, Speed Klamps™ - factory installed	3-9/16	5-11/16	3-3/4	15208	20	23



3300-SSK



3303-SSK



3300-SSBK

Steel Stud Screws	Cu. In. Volume	Catalog Number	Component Description	Exterior Dimensions			UPC# 85339	Std. Pkg. Qty.	Std. Wt. (lb.)
				D	W	H			
	46.0	3300-SS	Steel stud screws for use with non-load-bearing studs 22 gauge or lighter, Speed Klamps™ - bulk packed	3	5-11/16	3-3/4	14522	20	16
	46.0	3300-SSK	Steel stud screws for use with non-load-bearing studs 22 gauge or lighter, Speed Klamps™ - factory installed	3	5-11/16	3-3/4	14524	20	16
	56.5	3303-SS	Steel stud screws for use with non-load-bearing studs 22 gauge or lighter, Speed Klamps™ - bulk packed	3-9/16	5-11/16	3-3/4	15203	20	17
	56.5	3303-SSK	Steel stud screws for use with non-load-bearing studs 22 gauge or lighter, Speed Klamps™ - factory installed	3-9/16	5-11/16	3-3/4	15204	20	17

Steel Stud Screws with Bar	Cu. In. Volume	Catalog Number	Component Description	Exterior Dimensions			UPC# 85339	Std. Pkg. Qty.	Std. Wt. (lb.)
				D	W	H			
	46.0	3300-SSB	Steel stud screws for use with non-load-bearing studs 22 gauge or lighter, adjustable stabilizing bar, Speed Klamps™ - bulk packed	3	5-11/16	3-3/4	14521	20	21
	46.0	3300-SSBK	Steel stud screws for use with non-load-bearing studs 22 gauge or lighter, adjustable stabilizing bar, Speed Klamps™ - factory installed	3	5-11/16	3-3/4	14523	20	22

All dimensions are in inches unless otherwise noted.
See page 7 for Attachment Coding suffix descriptions.



Flush-Device
Box
UL File No. E30594

fiberglass BOX™ Three Gang

Residential Switch or Receptacle Box



3300-2Z2K



3300-Z2K



3303-2Z4K



3303-Z4K



3300-Z2BK

	Cu. In. Volume	Catalog Number	Component Description	Exterior Dimensions			UPC# 85339	Std. Pkg. Qty.	Std. Wt. (lb.)
				D	W	H			
"Z" Hanger	46.0	3300-2Z2	¼" offset, "Z" hanger each side of box, Speed Klamps™ - bulk packed	3	5-11/16	3-¾	14700	25	29
	46.0	3300-2Z2K	¼" offset, "Z" hanger each side of box, Speed Klamps™ - factory installed	3	5-11/16	3-¾	14702	25	29
	46.0	3300-2Z4	½" offset, "Z" hanger each side of box, Speed Klamps™ - bulk packed	3	5-11/16	3-¾	15120	25	29
	46.0	3300-2Z4K	½" offset, "Z" hanger each side of box, Speed Klamps™ - factory installed	3	5-11/16	3-¾	15121	25	29
	46.0	3300-Z2	¼" offset, "Z" hanger, Speed Klamps™ - bulk packed	3	5-11/16	3-¾	14560	25	24
	46.0	3300-Z2K	¼" offset, "Z" hanger, Speed Klamps™ - factory installed	3	5-11/16	3-¾	14562	25	24
	46.0	3300-Z4	½" offset, "Z" hanger, Speed Klamps™ - bulk packed	3	5-11/16	3-¾	14980	24	24
	46.0	3300-Z4K	½" offset, "Z" hanger, Speed Klamps™ - factory installed	3	5-11/16	3-¾	15017	24	24
	56.5	3303-2Z4	½" offset, "Z" hanger each side of box, Speed Klamps™ - bulk packed	3-9/16	5-11/16	3-¾	15222	25	33
	56.5	3303-2Z4K	½" offset, "Z" hanger each side of box, Speed Klamps™ - factory installed	3-9/16	5-11/16	3-¾	15223	25	33
	56.5	3303-Z4	½" offset, "Z" hanger, Speed Klamps™ - bulk packed	3-9/16	5-11/16	3-¾	15205	20	21
	56.5	3303-Z4K	½" offset, "Z" hanger, Speed Klamps™ - factory installed	3-9/16	5-11/16	3-¾	15206	20	22

	Cu. In. Volume	Catalog Number	Component Description	Exterior Dimensions			UPC# 85339	Std. Pkg. Qty.	Std. Wt. (lb.)
				D	W	H			
"Z" Hanger with Bar	46.0	3300-Z2B	¼" offset, "Z" hanger, adjustable stabilizing bar, Speed Klamps™ - bulk packed	3	5-11/16	3-¾	14595	20	25
	46.0	3300-Z2BK	¼" offset, "Z" hanger, adjustable stabilizing bar, Speed Klamps™ - factory installed	3	5-11/16	3-¾	14597	20	25



LVP-1



LVP-1 Installed



9313-EWC3



9313-EWK

Low Voltage Partition	Catalog Number	Component Description	UPC# 85339	Std. Pkg. Qty.	Std. Wt. (lb.)
	LVP-1	Low voltage divider plate for use with 2302, 3303, 4304, 5305 Series and 9314 only. See 2008 NEC 800.133(A)(1)(c).	80000	50*	3

* Consists of ten (10) packages of five (5) pieces each.

Ears with Wing Brackets	Cu. In. Volume	Catalog Number	Component Description	Exterior Dimensions			UPC# 85339	Std. Pkg. Qty.	Std. Wt. (lb.)
				D	W	H			
	42.5	9313-EW	Ears, wing brackets, Speed Klamps™- bulk packed	2-7/8	5-15/16	3-¼	10093	25	17
	42.5	9313-EWC3	Ears, wing brackets, 3 wire clamps - factory installed	2-7/8	5-15/16	3-¼	10095	25	18
	42.5	9313-EWK	Ears, wing brackets, Speed Klamps™- factory installed	2-7/8	5-15/16	3-¼	10094	25	17

All dimensions are in inches unless otherwise noted.
See page 7 for Attachment Coding suffix descriptions.

Old Work/Manufactured Housing Boxes

Flush-Device Box
UL File No. E30594

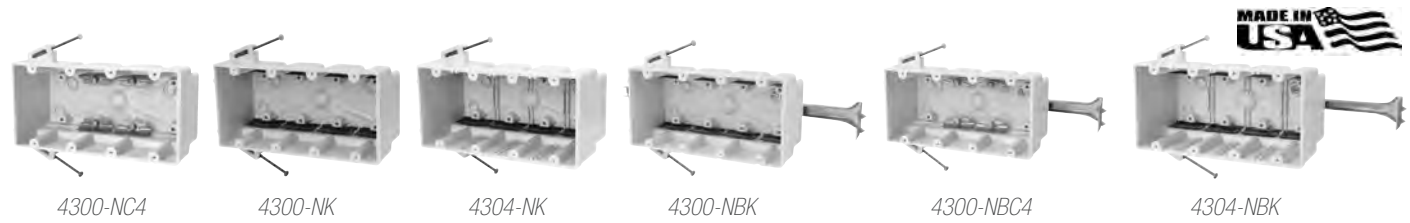

	Cu. In. Volume	Catalog Number	Component Description	Exterior Dimensions			UPC# 85339	Std. Pkg. Qty.	Std. Wt. (lb.)
				D	W	H			
Nail-On	60.0	4300-N	Angled mid-nails, Speed Klamps™ - bulk packed	3	7-½	3-¾	16225	18	17
	60.0	4300-NC4	Angled mid-nails, 4 wire clamps - factory installed	3	7-½	3-¾	16245	18	18
	60.0	4300-NK	Angled mid-nails, Speed Klamps™ - factory installed	3	7-½	3-¾	16226	18	17
	75.0	4304-N	Angled mid-nails, Speed Klamps™ - bulk packed	3-9/16	7-½	3-¾	17550	18	20
	75.0	4304-NK	Angled mid-nails, Speed Klamps™ - factory installed	3-9/16	7-½	3-¾	17551	18	20

	Cu. In. Volume	Catalog Number	Component Description	Exterior Dimensions			UPC# 85339	Std. Pkg. Qty.	Std. Wt. (lb.)
				D	W	H			
Nail-On with Bar	60.0	4300-NB	Angled mid-nails, adjustable stabilizing bar, Speed Klamps™ - bulk packed	3	7-½	3-¾	16270	18	22
	60.0	4300-NBC4	Angled mid-nails, adjustable stabilizing bar, 4 wire clamps - factory installed	3	7-½	3-¾	16290	18	23
	60.0	4300-NBK	Angled mid-nails, adjustable stabilizing bar, Speed Klamps™ - factory installed	3	7-½	3-¾	16271	18	22
	75.0	4304-NB	Angled mid-nails, adjustable stabilizing bar, Speed Klamps™ - bulk packed	3-9/16	7-½	3-¾	17552	18	24
	75.0	4304-NBK	Angled mid-nails, adjustable stabilizing bar, Speed Klamps™ - factory installed	3-9/16	7-½	3-¾	17553	18	25

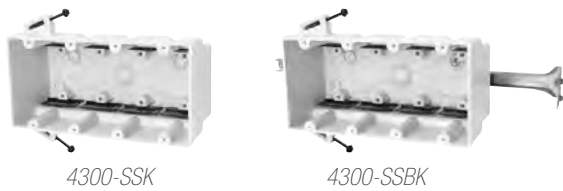

	Cu. In. Volume	Catalog Number	Component Description	Exterior Dimensions			UPC# 85339	Std. Pkg. Qty.	Std. Wt. (lb.)
				D	W	H			
Steel Stud Screws	60.0	4300-SS	Steel stud screws for use with non-load-bearing studs 22 gauge or lighter, Speed Klamps™ - bulk packed	3	7-½	3-¾	16233	18	17
	60.0	4300-SSK	Steel stud screws for use with non-load-bearing studs 22 gauge or lighter, Speed Klamps™ - factory installed	3	7-½	3-¾	16232	18	17

	Cu. In. Volume	Catalog Number	Component Description	Exterior Dimensions			UPC# 85339	Std. Pkg. Qty.	Std. Wt. (lb.)
				D	W	H			
Steel Stud Screws with Bar	60.0	4300-SSB	Steel stud screws for use with non-load-bearing studs 22 gauge or lighter, adjustable stabilizing bar, Speed Klamps™ - bulk packed	3	7-½	3-¾	16229	18	25
	60.0	4300-SSBK	Steel stud screws for use with non-load-bearing studs 22 gauge or lighter, adjustable stabilizing bar, Speed Klamps™ - factory installed	3	7-½	3-¾	16234	18	25

All dimensions are in inches unless otherwise noted.
See page 7 for Attachment Coding suffix descriptions.

Flush-Device Box
UL File No. E30594

fiberglassBOX™ Four Gang Residential Switch or Receptacle Box



4300-2Z2K



4300-Z2K



4300-Z2BK



4304-Z4BK

	Cu. In. Volume	Catalog Number	Component Description	Exterior Dimensions			UPC# 85339	Std. Pkg. Qty.	Std. Wt. (lb.)
				D	W	H			
"Z" Hanger	60.0	4300-2Z2	¼" offset, "Z" hanger each side of box, Speed Klamps™ - bulk packed	3	7-½	3-¾	16905	12	15
	60.0	4300-2Z2K	¼" offset, "Z" hanger each side of box, Speed Klamps™ - factory installed	3	7-½	3-¾	16907	12	15
	60.0	4300-Z2	¼" offset, "Z" hanger, Speed Klamps™ - bulk packed	3	7-½	3-¾	16725	12	14
	60.0	4300-Z2K	¼" offset, "Z" hanger, Speed Klamps™ - factory installed	3	7-½	3-¾	16906	12	14
	60.0	4300-Z4	½" offset, "Z" hanger, Speed Klamps™ - bulk packed	3	7-½	3-¾	18265	12	15
	60.0	4300-Z4K	½" offset, "Z" hanger, Speed Klamps™ - factory installed	3	7-½	3-¾	17312	12	22
	75.0	4304-2Z4	½" offset, "Z" hanger each side of box, Speed Klamps™ - bulk packed	3-9/16	7-½	3-¾	17560	12	17
	75.0	4304-2Z4K	½" offset, "Z" hanger each side of box, Speed Klamps™ - factory installed	3-9/16	7-½	3-¾	17561	12	17

	Cu. In. Volume	Catalog Number	Component Description	Exterior Dimensions			UPC# 85339	Std. Pkg. Qty.	Std. Wt. (lb.)
				D	W	H			
"Z" Hanger with Bar	60.0	4300-Z2B	¼" offset, "Z" hanger, adjustable stabilizing bar, Speed Klamps™ - bulk packed	3	7-½	3-¾	16770	6	9
	60.0	4300-Z2BK	¼" offset, "Z" hanger, adjustable stabilizing bar, Speed Klamps™ - factory installed	3	7-½	3-¾	16771	6	9
	75.0	4304-Z4B	½" offset, "Z" hanger, adjustable stabilizing bar, Speed Klamps™ - bulk packed	3-9/16	7-½	3-¾	17554	6	10
	75.0	4304-Z4BK	½" offset, "Z" hanger, adjustable stabilizing bar, Speed Klamps™ - factory installed	3-9/16	7-½	3-¾	17555	6	10



LVP-1



9314-EWK

Low Voltage Partition	Catalog Number	Component Description	UPC# 85339	Std. Pkg. Qty.	Std. Wt. (lb.)
	LVP-1	Low voltage divider plate for use with 2302, 3303, 4304, 5305 Series and 9314 only. See 2008 NEC 800.133(A)(1)(c).	80000	50*	3

* Consists of ten (10) packages of five (5) pieces each.

Ears w/ Wing Brackets	Cu. In. Volume	Catalog Number	Component Description	Exterior Dimensions			UPC# 85339	Std. Pkg. Qty.	Std. Wt. (lb.)
				D	W	H			
	70.0	9314-EWK	Ears, wing brackets, ½" knockouts, Speed Klamps™ - factory installed	3-9/16	7-11/16	3-¾	31800	6	8

All dimensions are in inches unless otherwise noted.
See page 7 for Attachment Coding suffix descriptions.

Old Work/Manufactured Housing Boxes

Flush-Device Box
UL File No. E30594

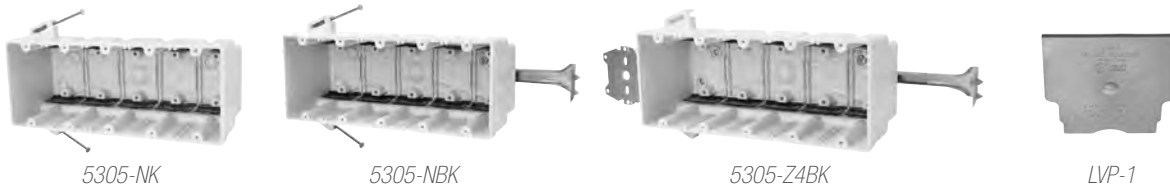

	Cu. In. Volume	Catalog Number	Component Description	Exterior Dimensions			UPC# 85339	Std. Pkg. Qty.	Std. Wt. (lb.)
				D	W	H			
Nail-On	94.0	5305-NK	Angled mid-nails, Speed Klamps™ - factory installed	3-9/16	9-5/16	3-3/4	18001	6	9
Nail-On with Bar	94.0	5305-NBK	Angled mid-nails, adjustable stabilizing bar, Speed Klamps™ - factory installed	3-9/16	9-5/16	3-3/4	18002	6	10
"Z" Hanger with Bar	94.0	5305-Z4BK	1/2" offset, "Z" hanger, adjustable stabilizing bar, Speed Klamps™ - factory installed	3-9/16	9-5/16	3-3/4	18003	6	12
Low Voltage Partition		Catalog Number	Component Description				UPC# 85339	Std. Pkg. Qty.	Std. Wt. (lb.)
		LVP-1	Low voltage divider plate for use with 2302, 3303, 4304, 5305 Series and 9314 only. See 2008 NEC 800.133(A)(1)(c).				80000	50*	3

* Consists of ten (10) packages of five (5) pieces each.

All dimensions are in inches unless otherwise noted.
See page 7 for Attachment Coding suffix descriptions.

 Flush-Device
Box
UL File No. E30594

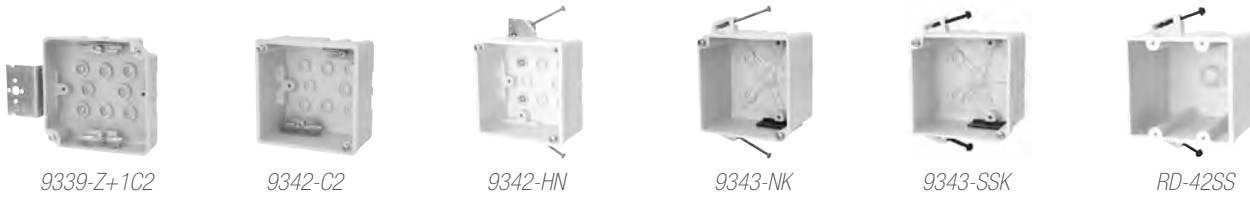

Square Junction Boxes	Cu. In. Volume	Catalog Number	Component Description	Exterior Dimensions			UPC# 85339	Std. Pkg. Qty.	Std. Wt. (lb.)
				D	W	H			
	16.0	9339-Z+1	"Z" hanger, flush with face of plaster ring, wire clamps - bulk packed	1-1/4	4-1/4	4-1/4	10314	50	22
	16.0	9339-Z+1C2	"Z" hanger, flush with face of plaster ring, 2 wire clamps - factory installed	1-1/4	4-1/4	4-1/4	10318	50	23
	27.3	9342-C2	Bottom mount, 2 wire clamps - factory installed	2-1/4	4	4	10346	50	25
	27.3	9342-HF	Nail-on "HF" hanger, wire clamps - bulk packed	2-1/4	4	4	10348	50	30
	27.3	9342-HN	Nail-on "HN" hanger, wire clamps - bulk packed	2-1/4	4	4	10342	50	32
	32.3	9343-N	Nails, Speed Klamps™ - bulk packed	2-1/2	4-1/16	4-1/16	10370	50	26
	32.3	9343-NC2	Nails, 2 wire clamps - factory installed	2-1/2	4-1/16	4-1/16	57150	50	27
	32.3	9343-NK	Nails, Speed Klamps™ - factory installed	2-1/2	4-1/16	4-1/16	10374	50	27
	32.3	9343-SS	Steel stud screws for use with non-load-bearing studs 22 gauge or lighter, Speed Klamps™ - bulk packed	2-1/2	4-1/16	4-1/16	10375	50	27
	32.3	9343-SSK	Steel stud screws for use with non-load-bearing studs 22 gauge or lighter, Speed Klamps™ - factory installed	2-1/2	4-1/16	4-1/16	10376	50	27

Range/Dryer Receptacle	Cu. In. Volume	Catalog Number	Component Description	Exterior Dimensions			UPC# 85339	Std. Pkg. Qty.	Std. Wt. (lb.)
				D	W	H			
	42.0	RD-42	Fetter ring nails, internal wire clamp - factory installed, knockout	3-13/16	4	3-3/4	12907	24	22
	42.0	RD-42SS	Steel stud screws for use with non-load-bearing studs 22 gauge or lighter, internal wire clamp - factory installed, knockout	3-13/16	4	3-3/4	12905	24	22

For use with 2-position devices; knockout accomodates #8 and #6 gauge wire.



Plaster Rings & Covers	Cu. In. Volume	Catalog Number	Component Description	Exterior Dimensions			UPC# 85339	Std. Pkg. Qty.	Std. Wt. (lb.)
				D	W	H			
	—	9315	Round blank cover	—	4-3/4 dia.	—	10130	100	16
	—	9315-WH	Round blank cover, white	—	4-3/4 dia.	—	10132	100	16
	—	9344	Square blank cover; *Use with series 9339, 9342, and 9343 only	—	4	4	10360	100	15
	4.2	9345	Single gang plaster ring, thermoplastic material, 1/2" offset	5/8	4	4	10361	100	8
	5.1	9345-58	Single gang plaster ring, thermoplastic material, 5/8" offset; *Use with series 9339, 9342, and 9343 only	3/4	4	4	10372	50	5
	6.7	9346	Two-gang plaster ring, thermoplastic material, 1/2" offset	5/8	4	4	10362	50	4
	8.1	9346-58	Two-gang plaster ring, thermoplastic material, 5/8" offset; *Use with series 9339, 9342, and 9343 only	3/4	4	4	10390	50	4
	4.8	9347	Square plaster ring, reduces to 3/0 outlet, 1/2" offset; *Use with series 9339, 9342, and 9343 only	11/16	4-1/16	4-1/16	10386	50	8
	4.3	9348	Round plaster ring, reduces 4" dia. outlet box to 3" dia. opening, 1/2" offset; *Use with series 9350, 9351, 9364 and 9365 only	5/8	4 dia.	—	10366	100	11

All dimensions are in inches unless otherwise noted.
See page 7 for Attachment Coding suffix descriptions.



UL File No. E30594

fiberglass BOX™ 3-1/2" Dia. Round Outlet

Wall or Ceiling Fixture Support Boxes



NOTE: All 3-1/2" round outlet boxes have a fixture mounting pattern (at a width of 2.75") with machine tapped holes to accept #8-32 mounting hardware.

	Cu. In. Volume	Catalog Number	Component Description	Exterior Dimensions		Fixture Rating	UPC# 85339	Std. Pkg. Qty.	Std. Wt. (lb.)
				D	W				
Nail-On	16.0	9336-N	Fetter ring nails, Speed Klamps™ - bulk packed	2-3/8	3-1/2	50 lb.	10270	50	21
	16.0	9336-NC2	Fetter ring nails, 2 wire clamps - factory installed	2-3/8	3-1/2	50 lb.	10276	50	23
	16.0	9336-NK	Fetter ring nails, Speed Klamps™ - factory installed	2-3/8	3-1/2	50 lb.	10271	50	22
	16.0	9336-NG	Fetter ring nails, ground strap, Speed Klamps™ - bulk packed	2-3/8	3-1/2	50 lb.	10280	50	22
	16.0	9336-NGK	Fetter ring nails, ground strap, Speed Klamps™ - factory installed	2-3/8	3-1/2	50 lb.	10281	50	22
	20.5	9335-N	Fetter ring nails, Speed Klamps™ - bulk packed	2-7/8	3-1/2	50 lb.	41160	50	24
	20.5	9335-NC2	Fetter ring nails, 2 wire clamps - factory installed	2-7/8	3-1/2	50 lb.	41170	50	25
	20.5	9335-NK	Fetter ring nails, Speed Klamps™ - factory installed	2-7/8	3-1/2	50 lb.	41162	50	24
	20.5	9335-NKRED	Fetter ring nails, Speed Klamps™ - factory installed *Molded in red for fire circuits	2-7/8	3-1/2	50 lb.	96503	12	6
	20.5	9335-NG	Fetter ring nails, ground strap, Speed Klamps™ - bulk packed	2-7/8	3-1/2	50 lb.	41180	50	25
	20.5	9335-NGC2	Fetter ring nails, ground strap, 2 wire clamps - factory installed	2-7/8	3-1/2	50 lb.	41190	50	26
	20.5	9335-NGK	Fetter ring nails, ground strap, Speed Klamps™ - factory installed	2-7/8	3-1/2	50 lb.	41182	50	25

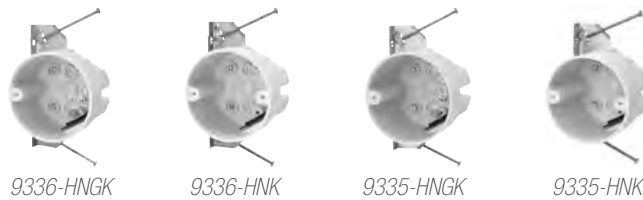

	Cu. In. Volume	Catalog Number	Component Description	Exterior Dimensions		Fixture Rating	UPC# 85339	Std. Pkg. Qty.	Std. Wt. (lb.)
				D	W				
"HN" Hanger	16.0	9336-HNGK	Nail-on "HN" hanger, ground strap, Speed Klamps™ - factory installed	2-3/8	3-1/2	50 lb.	10341	50	26
	16.0	9336-HNK	Nail-on "HN" hanger, Speed Klamps™ - factory installed	2-3/8	3-1/2	50 lb.	10307	50	25
	20.5	9335-HNGK	Nail-on "HN" hanger, ground strap, Speed Klamps™ - factory installed	2-15/16	3-1/2	50 lb.	41823	50	29
	20.5	9335-HNK	Nail-on "HN" hanger, Speed Klamps™ - factory installed	2-15/16	3-1/2	50 lb.	41824	50	28

All dimensions are in inches unless otherwise noted.
See page 7 for Attachment Coding suffix descriptions.



fiberglass BOX™ 3-1/2" Dia. Round Outlet

Wall or Ceiling Fixture Support Boxes

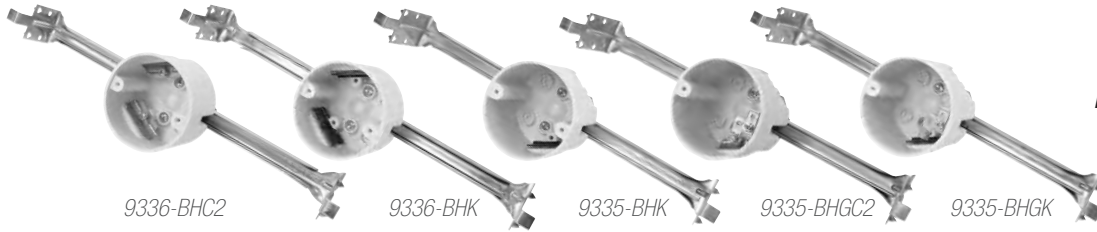

NOTE: All 3-1/2" round outlet boxes have a fixture mounting pattern (at a width of 2.75") with machine tapped holes to accept #8-32 mounting hardware.

Adjustable Bar Hanger for 16" to 24" O.C. Joist Applications	Cu. In. Volume	Catalog Number	Component Description	Exterior Dimensions		Fixture Rating	UPC# 85339	Std. Pkg. Qty.	Std. Wt. (lb.)
				D	W				
	16.0	9336-BH	16" - 24" adjustable bar hanger, Speed Klamps™ - bulk packed	2-3/8	3-1/2	50 lb.	88104	24	31
	16.0	9336-BHC2	16" - 24" adjustable bar hanger, 2 wire clamps - factory installed	2-3/8	3-1/2	50 lb.	88118	24	31
	16.0	9336-BHK	16" - 24" adj. bar hanger, Speed Klamps™ - factory installed	2-3/8	3-1/2	50 lb.	88105	24	30
	16.0	9336-BHG	16" - 24" adj. bar hanger, ground strap, Speed Klamps™ - bulk packed	2-3/8	3-1/2	50 lb.	88106	24	30
	16.0	9336-BHGC2	16" - 24" adjustable bar hanger, ground strap, 2 wire clamps - factory installed	2-3/8	3-1/2	50 lb.	88119	24	31
	16.0	9336-BHGK	16" - 24" adjustable bar hanger, ground strap, Speed Klamps™ - factory installed	2-3/8	3-1/2	50 lb.	88107	24	31
	20.5	9335-BH	16" - 24" adjustable bar hanger, Speed Klamps™ - bulk packed	2-15/16	3-1/2	50 lb.	88100	24	32
	20.5	9335-BHC2	16" - 24" adjustable bar hanger, 2 wire clamps - factory installed	2-15/16	3-1/2	50 lb.	88116	24	32
	20.5	9335-BHK	16" - 24" adj. bar hanger, Speed Klamps™ - factory installed	2-15/16	3-1/2	50 lb.	88101	24	32
	20.5	9335-BHG	16" - 24" adjustable bar hanger, ground strap, Speed Klamps™ - bulk packed	2-15/16	3-1/2	50 lb.	88102	24	32
	20.5	9335-BHGC2	16" - 24" adjustable bar hanger, ground strap, 2 wire clamps - factory installed	2-15/16	3-1/2	50 lb.	88117	24	32
	20.5	9335-BHGK	16" - 24" adjustable bar hanger, ground strap, Speed Klamps™ - factory installed	2-15/16	3-1/2	50 lb.	88103	24	32



Bar Hanger for 16" O.C. Joist Applications Only	Cu. In. Volume	Catalog Number	Component Description	Exterior Dimensions		Fixture Rating	UPC# 85339	Std. Pkg. Qty.	Std. Wt. (lb.)
				D	W				
	16.0	9336-16	16" bar hanger, Speed Klamps™ - bulk packed	2-3/8	3-1/2	50 lb.	10273	24	20
	16.0	9336-16C2	16" bar hanger, 2 wire clamps - factory installed	2-3/8	3-1/2	50 lb.	98300	24	21
	16.0	9336-16K	16" bar hanger, Speed Klamps™ - factory installed	2-3/8	3-1/2	50 lb.	10284	24	21
	16.0	9336-16G	16" bar hanger, ground strap, Speed Klamps™ - bulk packed	2-3/8	3-1/2	50 lb.	10279	24	20
	16.0	9336-16GC2	16" bar hanger, ground strap, 2 wire clamps - factory installed	2-3/8	3-1/2	50 lb.	10274	24	21
	16.0	9336-16GK	16" bar hanger, ground strap, Speed Klamps™ - factory installed	2-3/8	3-1/2	50 lb.	10286	24	21
	20.5	9335-16	16" bar hanger, Speed Klamps™ - bulk packed	2-15/16	3-1/2	50 lb.	41280	24	21
	20.5	9335-16C2	16" bar hanger, 2 wire clamps - factory installed	2-15/16	3-1/2	50 lb.	41290	24	25
	20.5	9335-16K	16" bar hanger, Speed Klamps™ - factory installed	2-15/16	3-1/2	50 lb.	41281	24	21
	20.5	9335-16G	16" bar hanger, ground strap, Speed Klamps™ - bulk packed	2-15/16	3-1/2	50 lb.	41300	24	21
	20.5	9335-16GC2	16" bar hanger, ground strap, 2 wire clamps - factory installed	2-15/16	3-1/2	50 lb.	41310	24	25
	20.5	9335-16GK	16" bar hanger, ground strap, Speed Klamps™ - factory installed	2-15/16	3-1/2	50 lb.	41301	24	22

All dimensions are in inches unless otherwise noted.
See page 7 for Attachment Coding suffix descriptions.



fiberglass BOX™ 3-1/2" Dia. Round Outlet Wall Fixture Support Boxes

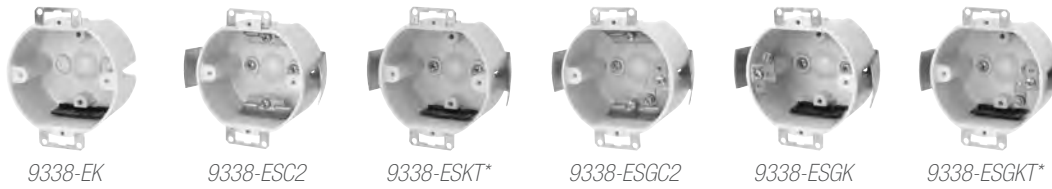

NOTE: All 3-1/2" round outlet boxes have a fixture mounting pattern (at a width of 2.75") with machine tapped holes to accept #8-32 mounting hardware.

Ears	Cu. In. Volume	Catalog Number	Component Description	Exterior Dimensions		Fixture Rating	UPC# 85339	Std. Pkg. Qty.	Std. Wt. (lb.)
				D	W				
	14.0	9338-E	Ears, Speed Klamps™ - bulk packed	2	3-1/2	15 lb.	46000	50	14
	14.0	9338-EK	Ears, Speed Klamps™ - factory installed	2	3-1/2	15 lb.	46001	50	15
	14.0	9338-EKT*	Ears, Speed Klamps™ - factory installed, tapped device holes	2	3-1/2	15 lb.	46038	50	15

Ears & Snap Brackets	Cu. In. Volume	Catalog Number	Component Description	Exterior Dimensions		Fixture Rating	UPC# 85339	Std. Pkg. Qty.	Std. Wt. (lb.)
				D	W				
	14.0	9338-ES	Ears, snap bracket, Speed Klamps™ - bulk packed	2	3-1/2	15 lb.	46005	50	20
	14.0	9338-ESC2	Ears, snap bracket, 2 wire clamps - factory installed	2	3-1/2	15 lb.	46015	50	22
	14.0	9338-ESC2T*	Ears, snap bracket, 2 wire clamps - factory installed, tapped device holes	2	3-1/2	15 lb.	46041	50	22
	14.0	9338-ESK	Ears, snap bracket, Speed Klamps™ - factory installed	2	3-1/2	15 lb.	46006	50	21
	14.0	9338-ESKT*	Ears, snap bracket, Speed Klamps™ - factory installed, tapped device holes	2	3-1/2	15 lb.	46040	50	21
	14.0	9338-EST*	Ears, snap bracket, Speed Klamps™ - bulk packed, tapped device holes	2	3-1/2	15 lb.	46039	50	20
	14.0	9338-ESG	Ears, snap bracket, ground strap, Speed Klamps™ - bulk packed	2	3-1/2	15 lb.	46020	50	21
	14.0	9338-ESGC2	Ears, snap bracket, ground strap, 2 wire clamps - factory installed	2	3-1/2	15 lb.	46030	50	23
	14.0	9338-ESGK	Ears, snap bracket, ground strap, Speed Klamps™ - factory installed	2	3-1/2	15 lb.	46021	50	21
	14.0	9338-ESGKT*	Ears, snap bracket, ground strap, Speed Klamps™ - factory installed, tapped device holes	2	3-1/2	15 lb.	46043	50	21

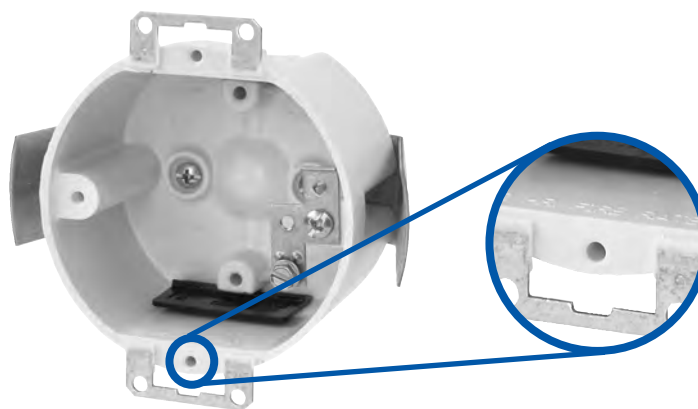

*Strip-resistant, tapered and machine tapped device holes allow device screw to be started by hand and speed installation time with adjustable torque screwdrivers.

All dimensions are in inches unless otherwise noted.
See page 7 for Attachment Coding suffix descriptions.

Old Work/Manufactured Housing Boxes

Outlet Box
UL File No. E30594



9305-SC2



9305-SK



9305-SG



9305-SGK



9355-SK

NOTE: All 3-1/2" round outlet boxes have a fixture mounting pattern (at a width of 2.75") with machine tapped holes to accept #8-32 mounting hardware.

Snap Brackets – Wall Applications

Cu. In. Volume	Catalog Number	Component Description	Exterior Dimensions		Fixture Rating	UPC# 85339	Std. Pkg. Qty.	Std. Wt. (lb.)
			D	W				
14.0	9305-S	3/0 box with flange, snap bracket, Speed Klamps™ - bulk packed	1-3/4	3-1/2	15 lb.	27350	50	21
14.0	9305-SC2	3/0 box with flange, snap bracket, 2 wire clamps - factory installed	1-3/4	3-1/2	15 lb.	27360	50	23
14.0	9305-SK	3/0 box with flange, snap bracket, Speed Klamps™ - factory installed	1-3/4	3-1/2	15 lb.	27351	50	22
14.0	9305-SG	3/0 box with flange, snap bracket, ground strap, Speed Klamps™ - bulk packed	1-3/4	3-1/2	15 lb.	27370	50	23
14.0	9305-SGK	3/0 box with flange, snap bracket, ground strap, Speed Klamps™ - factory installed	1-3/4	3-1/2	15 lb.	27371	50	23
22.0	9355-S	3/0 box with flange, snap bracket, Speed Klamps™ - bulk packed	2-3/4	3-1/2	15 lb.	10480	48	27
22.0	9355-SK	3/0 box with flange, snap bracket, 2 wire clamps - factory installed	2-3/4	3-1/2	15 lb.	68292	48	27
22.0	9355-SGK	3/0 box with flange, snap bracket, ground strap, 2 wire clamps - factory installed	2-3/4	3-1/2	15 lb.	68151	48	26



9304*



9304-G*



9305-C2



9305-K



9305-GK



9355-K



9355-GK

Bottom Mount – Ceiling Fixture Applications

Cu. In. Volume	Catalog Number	Component Description	Exterior Dimensions		Fixture Rating	UPC# 85339	Std. Pkg. Qty.	Std. Wt. (lb.)
			D	W				
3.5	9304	Fixture mounting holes on 2-3/4" centers, not UL® listed. See NEC 2008 410.10. *For wall applications only.	5/8	3-3/8	—	10025	100	12
3.5	9304-G	Fixture mounting holes on 2-3/4" centers, ground strap, not UL® listed. See NEC 2008 410.10. *For wall applications only.	5/8	3-3/8	—	10026	100	14
14.0	9305	3/0 box with flange, Speed Klamps™ - bulk packed	1-3/4	3-1/2	50 lb. ◀	10030	50	15
14.0	9305-C2	3/0 box with flange, 2 wire clamps - factory installed	1-3/4	3-1/2	50 lb. ◀	10032	50	17
14.0	9305-K	3/0 box with flange, Speed Klamps™ - factory installed	1-3/4	3-1/2	50 lb. ◀	10034	50	16
14.0	9305-G	3/0 box with flange, ground strap, Speed Klamps™ - bulk packed	1-3/4	3-1/2	50 lb. ◀	10031	50	16
14.0	9305-GK	3/0 box with flange, ground strap, Speed Klamps™ - factory installed	1-3/4	3-1/2	50 lb. ◀	10036	50	17
22.0	9355	3/0 box with flange, Speed Klamps™ - bulk packed	2-3/4	3-1/2	50 lb. ◀	10490	48	19
22.0	9355-K	3/0 box with flange, ground strap, Speed Klamps™ - factory installed	2-3/4	3-1/2	50 lb. ◀	68291	48	19
22.0	9355-G	3/0 box with flange, ground strap, Speed Klamps™ - bulk packed	2-3/4	3-1/2	50 lb. ◀	10491	48	19
22.0	9355-GK	3/0 box with flange, ground strap, Speed Klamps™ - factory installed	2-3/4	3-1/2	50 lb. ◀	68091	48	20

All dimensions are in inches unless otherwise noted.
See page 7 for Attachment Coding suffix descriptions.

◀ 50 lb. ceiling fixture rating when bottom mounted per installation instructions.



Old Work/Manufactured Housing Boxes



Outlet Box





UL File No. E30594

fiberglass BOX™ 4" Dia. Round Outlet

Wall or Ceiling Fixture Support Boxes



NOTE: All 4" round outlet boxes have combination fixture mounting patterns (at widths of 2.75" and 3.5") with machine tapped holes to accept #8-32 mounting hardware.

Bottom Mount	Cu. In. Volume	Catalog Number	Component Description	Exterior Dimensions		Fixture Rating	UPC# 85339	Std. Pkg. Qty.	Std. Wt. (lb.)
				D	W				
	15.0	9364	 Bottom mount, Speed Klamps™ - bulk packed	1-11/16	4	50 lb.	15080	50	25
	15.0	9364-K	 Bottom mount, Speed Klamps™ - factory installed	1-11/16	4	50 lb.	10622	50	25
	22.5	9350	 Bottom mount, Speed Klamps™ - bulk packed	2-7/16	4	50 lb.	10420	50	21
	22.5	9350-K	 Bottom mount, Speed Klamps™ - factory installed	2-7/16	4	50 lb.	10418	50	21

Nail-On	Cu. In. Volume	Catalog Number	Component Description	Exterior Dimensions		Fixture Rating	UPC# 85339	Std. Pkg. Qty.	Std. Wt. (lb.)
				D	W				
	15.0	9365-N	Fetter ring nails, Speed Klamps™ - bulk packed	1-11/16	4	50 lb.	10630	50	21
	15.0	9365-NK	Fetter ring nails, Speed Klamps™ - factory installed	1-11/16	4	50 lb.	75391	50	22
	22.5	9351-N	Fetter ring nails, Speed Klamps™ - bulk packed	2-7/16	4	50 lb.	10475	48	25
	22.5	9351-NC2	Fetter ring nails, 2 wire clamps - factory installed	2-7/16	4	50 lb.	65190	48	26
	22.5	9351-NK	Fetter ring nails, Speed Klamps™ - factory installed	2-7/16	4	50 lb.	10476	48	25
	22.5	9351-NKRED	Fetter ring nails, Speed Klamps™ - factory installed *Molded in red for fire circuits	2-7/16	4	50 lb.	96502	25	13
	22.5	9351-NG	Fetter ring nails, ground strap, Speed Klamps™ - bulk packed	2-7/16	4	50 lb.	65210	48	24
	22.5	9351-NGC2	Fetter ring nails, ground strap, 2 wire clamps - factory installed	2-7/16	4	50 lb.	65220	48	26
	22.5	9351-NGK	Fetter ring nails, ground strap, Speed Klamps™ - factory installed	2-7/16	4	50 lb.	65212	48	26



Steel Stud Screws	Cu. In. Volume	Catalog Number	Component Description	Exterior Dimensions		Fixture Rating	UPC# 85339	Std. Pkg. Qty.	Std. Wt. (lb.)
				D	W				
	22.5	9351-SS	Steel stud screws for use with non-load-bearing studs 22 gauge or lighter, Speed Klamps™ - bulk packed	2-7/16	4	50 lb.	65991	48	24
	22.5	9351-SSK	Steel stud screws for use with non-load-bearing studs 22 gauge or lighter, Speed Klamps™ - factory installed	2-7/16	4	50 lb.	65992	48	24

All dimensions are in inches unless otherwise noted.
See page 7 for Attachment Coding suffix descriptions.

fiberglass BOX™ 4" Dia. Round Outlet

Wall or Ceiling Fixture Support Boxes



NOTE: All 4" round outlet boxes have combination fixture mounting patterns (at widths of 2.75" and 3.5") with machine tapped holes to accept #8-32 mounting hardware.

HF, HL, & HN Hangers	Cu. In. Volume	Catalog Number	Component Description	Exterior Dimensions		Fixture Rating	UPC# 85339	Std. Pkg. Qty.	Std. Wt. (lb.)
				D	W				
	22.5	9350-HFK	"HF" hanger, Speed Klamps™ - factory installed	2-7/16	4	50 lb.	10419	50	28
	22.5	9350-HL	"HL" hanger, Speed Klamps™ - bulk packed	2-7/16	4	50 lb.	10424	50	27
	22.5	9350-HLC2	"HL" hanger, 2 wire clamps - factory installed	2-7/16	4	50 lb.	10425	50	29
	22.5	9350-HLK	"HL" hanger, Speed Klamps™ - factory installed	2-7/16	4	50 lb.	62094	50	27
	22.5	9350-HLGK	"HL" hanger, ground strap, Speed Klamps™ - factory installed	2-7/16	4	50 lb.	10443	50	27
	22.5	9350-HN	"HN" hanger, Speed Klamps™ - bulk packed	2-7/16	4	50 lb.	10460	50	30
	22.5	9350-HNK	"HN" hanger, Speed Klamps™ - factory installed	2-7/16	4	50 lb.	10462	50	31



Adjustable Bar Hanger for 16" to 24" O.C. Joist Applications	Cu. In. Volume	Catalog Number	Component Description	Exterior Dimensions		Fixture Rating	UPC# 85339	Std. Pkg. Qty.	Std. Wt. (lb.)
				D	W				
	15.0	9364-BH	16" - 24" adjustable bar hanger, Speed Klamps™ - bulk packed	1-11/16	4	50 lb.	88112	24	30
	15.0	9364-BHC2	16" - 24" adjustable bar hanger, 2 wire clamps - factory installed	1-11/16	4	50 lb.	88122	24	30
	15.0	9364-BHK	16" - 24" adj. bar hanger, Speed Klamps™ - factory installed	1-11/16	4	50 lb.	88113	24	30
	15.0	9364-BHG	16" - 24" adj. bar hanger, ground strap, Speed Klamps™ - bulk packed	1-11/16	4	50 lb.	88114	24	30
	15.0	9364-BHGC2	16" - 24" adjustable bar hanger, ground strap, 2 wire clamps - factory installed	1-11/16	4	50 lb.	88123	24	31
	15.0	9364-BHGK	16" - 24" adjustable bar hanger, ground strap, Speed Klamps™ - factory installed	1-11/16	4	50 lb.	88115	24	30
	22.5	9350-BH	16" - 24" adjustable bar hanger, Speed Klamps™ - bulk packed	2-7/16	4	50 lb.	88108	24	32
	22.5	9350-BHC2	16" - 24" adjustable bar hanger, 2 wire clamps - factory installed	2-7/16	4	50 lb.	88120	24	33
	22.5	9350-BHK	16" - 24" adj. bar hanger, Speed Klamps™ - factory installed	2-7/16	4	50 lb.	88109	24	32
	22.5	9350-BHG	16" - 24" adjustable bar hanger, ground strap, Speed Klamps™ - bulk packed	2-7/16	4	50 lb.	88110	24	32
	22.5	9350-BHGC2	16" - 24" adjustable bar hanger, ground strap, 2 wire clamps - factory installed	2-7/16	4	50 lb.	88121	24	33
	22.5	9350-BHGK	16" - 24" adjustable bar hanger, ground strap, Speed Klamps™ - factory installed	2-7/16	4	50 lb.	88111	24	32

All dimensions are in inches unless otherwise noted.
See page 7 for Attachment Coding suffix descriptions.



fiberglass BOX™ 4" Dia. Round Outlet

Wall or Ceiling Fixture Support Boxes



NOTE: All 4" round outlet boxes have combination fixture mounting patterns (at widths of 2.75" and 3.5") with machine tapped holes to accept #8-32 mounting hardware.

	Cu. In. Volume	Catalog Number	Component Description	Exterior Dimensions		Fixture Rating	UPC# 85339	Std. Pkg. Qty.	Std. Wt. (lb.)
				D	W				
Bar Hanger for 16" O.C. Joist Applications Only	15.0	9364-16	16" bar hanger, Speed Klamps™ - bulk packed	1-11/16	4	50 lb.	10590	24	19
	15.0	9364-16C2	16" bar hanger, 2 wire clamps - factory installed	1-11/16	4	50 lb.	10591	24	20
	15.0	9364-16K	16" bar hanger, Speed Klamps™ - factory installed	1-11/16	4	50 lb.	98302	24	19
	15.0	9364-16G	16" bar hanger, ground strap, Speed Klamps™ - bulk packed	1-11/16	4	50 lb.	10610	24	20
	15.0	9364-16GC2	16" bar hanger, ground strap, 2 wire clamps - factory installed	1-11/16	4	50 lb.	10611	24	20
	15.0	9364-16GK	16" bar hanger, ground strap, Speed Klamps™ - factory installed	1-11/16	4	50 lb.	98303	24	21
	22.5	9350-16	16" bar hanger, Speed Klamps™ - bulk packed	2-7/16	4	50 lb.	10426	24	23
	22.5	9350-16C2	16" bar hanger, 2 wire clamps - factory installed	2-7/16	4	50 lb.	10427	24	24
	22.5	9350-16K	16" bar hanger, Speed Klamps™ - factory installed	2-7/16	4	50 lb.	62224	24	22
	22.5	9350-16G	16" bar hanger, ground strap, Speed Klamps™ - bulk packed	2-7/16	4	50 lb.	10448	24	23
	22.5	9350-16GC2	16" bar hanger, ground strap, 2 wire clamps - factory installed	2-7/16	4	50 lb.	10456	24	24
	22.5	9350-16GK	16" bar hanger, ground strap, Speed Klamps™ - factory installed	2-7/16	4	50 lb.	10449	24	24

All dimensions are in inches unless otherwise noted.
See page 7 for Attachment Coding suffix descriptions.

fiberglass BOX™ Fan & Fixture Support

3-½" & 4" Fan/Fixture Support Box



3-½" Dia.	Cu. In. Volume	Catalog Number	Component Description	Exterior Dimensions		Fan Rating	Fixture Rating	UPC# 85339	Std. Pkg. Qty.	Std. Wt. (lb.)
				D	W					
	16.0	9336-NKFR	3-½" diameter fan & fixture support, side fetter ring nail mount, Speed Klamps™ - factory installed	2-3/8	3-½	35 lb.	50 lb.	10305	50	23
	20.5	9335-NFR	3-½" diameter fan & fixture support, side fetter ring nail mount, Speed Klamps™ - bulk packed	2-7/8	3-½	35 lb.	50 lb.	41201	50	25
	20.5	9335-NKFR	3-½" diameter fan & fixture support, side fetter ring nail mount, Speed Klamps™ - factory installed	2-7/8	3-½	35 lb.	50 lb.	41202	50	25

4" Diameter Fan & Fixture Support	Cu. In. Volume	Catalog Number	Component Description	Exterior Dimensions		Fan Rating	Fixture Rating	UPC# 85339	Std. Pkg. Qty.	Std. Wt. (lb.)
				D	W					
	8.0	9370-FR	4" diameter pan fan box, ½" deep base, "pop-in" cable clamp, mounting hardware included	1-½ overall	4	70 lb.	110 lb.	76600	24	6
	14.0	9375-FR	4" diameter thermoplastic fan box, ½" deep base, Speed Klamps™ - molded in, two ½" knockouts, mounting hardware included	3-13/16 overall	4	70 lb.	110 lb.	79291	24	7
	15.0	9364-FANB	4" diameter fan box, adjustable bar hanger, Speed Klamps™ - factory installed	1-11/16	4	35 lb.	50 lb.	99025	20	39
	15.0	9364-KFR	4" diameter bottom mount, Speed Klamps™ - factory installed, mounting hardware included	1-11/16	4	35 lb.	50 lb.	10620	50	21
	15.0	9365-NKFR	4" diameter fan & fixture support, side fetter ring nail mount, "HL" hanger, Speed Klamps™ - factory installed	1-11/16	4	35 lb.	50 lb.	75392	50	29
	16.0	9369-FB	4" diameter fan & fixture support, surface mount, Speed Klamps™ - factory installed, mounting hardware included	1-¾	4	35 lb.	50 lb.	76500	25	12
	16.0	9369-FBH	4" diameter fan box, side mount hanger, Speed Klamps™ - factory installed, mounting hardware included	1-¾	4	35 lb.	50 lb.	76501	25	18
	16.0	9369-FRBKB	4" diameter fan box, adjustable bar hanger, Speed Klamps™ - factory installed	1-¾	4	70 lb.	125 lb.	99739	20	28
	16.5	9373-FR	4" diameter thermoplastic fan box, ½" deep base, Speed Klamps™ - molded in, mounting hardware included	6 overall	4	70 lb.	110 lb.	78254	40	16
	22.5	9350-FANB	4" diameter fan box, adjustable bar hanger, Speed Klamps™ - factory installed, bulk packed	2-7/16	4	35 lb.	50 lb.	99021	20	32
	22.5	9350-KFR	4" diameter bottom mount, Speed Klamps™ - factory installed, mounting hardware included	2-7/16	4	35 lb.	50 lb.	10459	50	24
	22.5	9351-NFR	4" diameter fan & fixture support, side fetter ring nail mount, Speed Klamps™ - factory installed	2-7/16	4	35 lb.	50 lb.	65001	50	27
	22.5	9351-NKFR	4" diameter fan & fixture support, side fetter ring nail mount, Speed Klamps™ - factory installed	2-7/16	4	35 lb.	50 lb.	65002	50	28



All dimensions are in inches unless otherwise noted.
See page 7 for Attachment Coding suffix descriptions.

Old Work/Manufactured Housing Boxes

Outlet Box
UL File No. E30594



9364-FAN





9364-FRBKOW



9350-FAN



9350-FRBKOW

Point-of-Purchase (POP) Fan & Fixture Support	Cu. In. Volume	Catalog Number	Component Description	Exterior Dimensions		Fan Rating	Fixture Rating	UPC# 85339	Std. Pkg. Qty.	Std. Wt. (lb.)
				D	W					
	15.0	9364-FAN	4" diameter fan & fixture support, adjustable bar hanger, Speed Klamps™ - factory installed, individual point-of-purchase carton	1-11/16	4	35 lb.	50 lb.	99024	20	39
	15.0	9364-FRBKOW	 4" diameter fan & fixture support, adjustable bar hanger for old work applications, Speed Klamps™ - factory installed, individual point-of-purchase carton	1-11/16	4	35 lb.	50 lb.	70424	20	48
	22.5	9350-FAN	4" diameter fan & fixture support, adjustable bar hanger, Speed Klamps™ - factory installed, individual point-of-purchase carton	2-7/16	4	35 lb.	50 lb.	99020	20	39
	22.5	9350-FRBKOW	 4" diameter fan & fixture support, adjustable bar hanger for old work applications, Speed Klamps™ - factory installed, individual point-of-purchase carton	2-7/16	4	35 lb.	50 lb.	10472	20	50



9380-FR



9380-FANB

Steel Fan & Fixture Support	Cu. In. Volume	Catalog Number	Component Description	Exterior Dimensions		Fan Rating	Fixture Rating	UPC# 85339	Std. Pkg. Qty.	Std. Wt. (lb.)
				D	W					
	17.0	9380-FR	4" octagonal bottom mount fan & fixture support, two 1/2" knockouts, four pry-outs, metal clamps - factory installed, mounting hardware included	1-3/4	4	*70 lb.	*200 lb.	97588	24	13
	17.0	9380-FANB	4" octagonal fan & fixture support, adjustable bar hanger, two 1/2" knockouts, four pry-outs, metal clamps - factory installed, mounting hardware included	1-3/4	4	*70 lb.	*200 lb.	97589	12	26

NOTES: * No reduction in fan/fixture rating when used on 16" or 24" on center joist applications

All dimensions are in inches unless otherwise noted.
See page 7 for Attachment Coding suffix descriptions.

 Old Work/Manufactured Housing Boxes

 Outlet Box

UL File No. E30594



Vapor Seal: Material & Labor Saving Features

With innovative products designed for the electrical contractor, Allied Moulded offers a complete line of wall and ceiling boxes for use in energy efficient homes to aid in sealing up the exterior walls per construction methods outlined in 402.4 of the 2009 International Energy Conservation Code. **U.S. Patent #6, 908,003 B2**

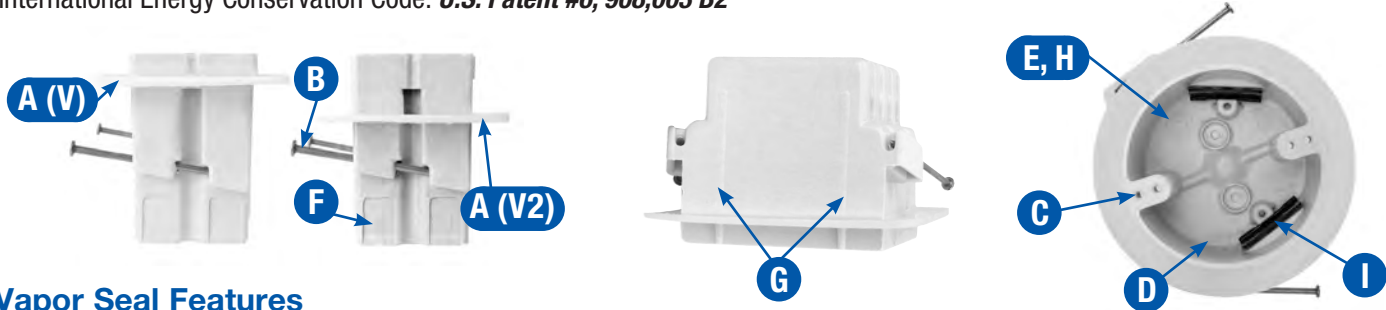

Vapor Seal Features

- A. Patented (U.S. Patent #6,908,003 B2) flexible polyurethane flange available for sealing box to air/vapor barrier. Flange products "V" are for single drywall and "V2" are for double drywall applications.
- B. Bright common nails fit securely in specially designed supports and are angled for easy installation.
- C. Tapered and machine tapped device holes allow device screw to be started by hand and speed installation time with high torque screwdrivers.
- D. Cubic inch capacity clearly marked and easy for contractor and inspector to locate and identify.
- E. Proudly UL® listed.
- F. Knockouts on fiberglass boxes are complete, reducing drafts and easily removed with wire for no-tool installation.
- G. Leveling ribs position face of box parallel to wall surface.
- H. 2-Hour Fire Rated clearly marked for easy inspector identification.
- I. Nonmetallic Speed "K" Klamps™ dependably secure wire in box.



Learn more about Vapor Seal products now!

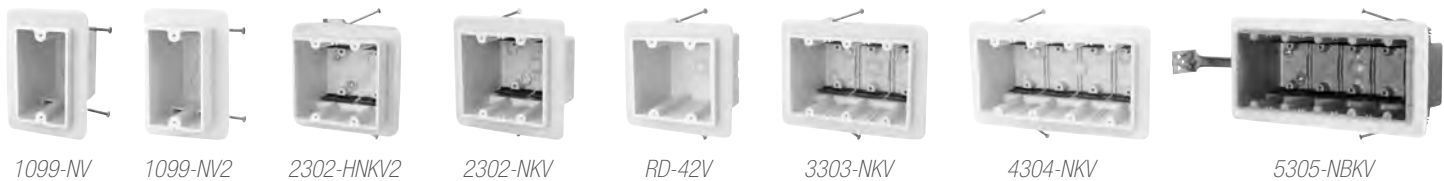

	Cu. In. Volume	Catalog Number	Component Description	Exterior Dim. (min. flange dim.)			Wall Substrate Offset	UPC# 85339	Std. Pkg. Qty.	Std. Wt. (lb.)
				D	W	H				
Vapor Seal Switch or Receptacle Boxes	22.5	1099-NV	Single gang box with Vapor Seal flange, angled mid-nails, knockouts	3-9/16	2-1/4 (3-1/2)	3-27/32 (5)	1/2 - 5/8	26007	48	21
	22.5	1099-NV2	Single gang box with Vapor Seal flange, angled mid-nails, knockouts, for use in double 5/8" drywall applications	3-9/16	2-1/4 (3-1/2)	3-27/32 (5)	1 - 1-1/4	26015	48	21
	37.0	2302-HNKV2	Two gang box with Vapor Seal flange, "HN" hanger, Speed Klamps™ - factory installed, knockouts, for use in double 5/8" drywall applications	3-7/16	4 (5-1/4)	3-3/4 (5)	1 - 1-1/8	92711	6	6
	37.0	2302-NKV	Two gang box with Vapor Seal flange, angled mid-nails, Speed Klamps™ - factory installed	3-7/16	4 (5-1/4)	3-3/4 (5)	1/2 - 5/8	13077	48	33
	42.0	RD-42V	Range/dryer receptacle box, fetter ring nails, clamp for #6/#8 AWG - factory installed	3-13/16	4 (5-1/4)	3-3/4 (5)	1/2 - 5/8	12906	24	23
	56.5	3303-NKV	Three gang box with Vapor Seal flange, angled mid-nails, Speed Klamps™ - factory installed	3-9/16	5-11/16 (7)	3-3/4 (5)	1/2 - 5/8	15209	18	17
	75.0	4304-NKV	Four gang box with Vapor Seal flange, angled mid-nails, Speed Klamps™ - factory installed	3-9/16	7-1/2 (8-3/4)	3-3/4 (5)	1/2 - 5/8	17558	18	22
	94.0	5305-NKV	Five gang box with Vapor Seal flange, angled mid-nails, Speed Klamps™ - factory installed	3-9/16	9-5/16 (10-1/2)	3-3/4 (5)	1/2 - 5/8	18011	6	9
	94.0	5305-NBKV	Five gang box with Vapor Seal flange, angled mid-nails, stabilizer bar, Speed Klamps™-factory installed	3-9/16	9-5/16 (10-1/2)	3-3/4 (5)	1/2 - 5/8	18012	6	11

All dimensions are in inches unless otherwise noted.
See page 7 for Attachment Coding suffix descriptions.

UL LISTED Flush-Device Box
UL File No. E30594

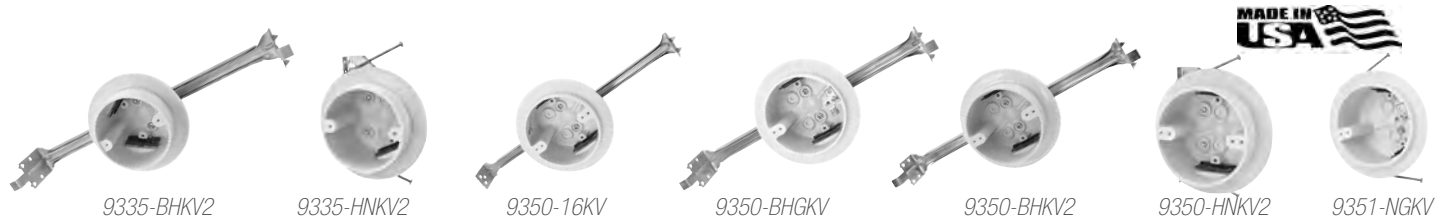

Vapor Seal Round Fixture Support

Cu. In. Volume	Catalog Number	Component Description	Exterior Dimensions (flange dim.)		Ceiling Substrate Offset	Fixture Rating	UPC# 85339	Std. Pkg. Qty.	Std. Wt. (lb.)
			D	W					
20.5	9335-BHKV2	3-½" dia. fixture box with Vapor Seal flange, 16" to 24" adjustable bar hanger, Speed Klamps™ - factory installed, for use in double 5/8" drywall applications	2-15/16	3-½ (4-¾)	1 - 1-¼	50 lb.	88125	18	25
20.5	9335-HNKV2	3-½" dia. fixture box with Vapor Seal flange, "HN" hanger, Speed Klamps™ - factory installed, for use in double 5/8" drywall applications	2-15/16	3-½ (4-¾)	1 - 1-¼	50 lb.	88126	50	33
22.5	9350-16KV	4" dia. fixture box with Vapor Seal flange, 16" bar hanger, Speed Klamps™ - factory installed	2-7/16	4 (5-¼)	½ - 5/8	50 lb.	98301	24	24
22.5	9350-BHKV	4" dia. fixture box with Vapor Seal flange, 16" to 24" adjustable bar hanger, Speed Klamps™ - factory installed	2-7/16	4 (5-¼)	½ - 5/8	50 lb.	88124	18	26
22.5	9350-BHGKV	4" dia. fixture box with Vapor Seal flange, with Ground Strap, 16" to 24" adjustable bar hanger, Speed Klamps™ - factory installed	2-7/16	4 (5-¼)	½ - 5/8	50 lb.	99092	18	26
22.5	9350-BHKV2	4" dia. fixture box with Vapor Seal flange, 16" to 24" adjustable bar hanger, Speed Klamps™ - factory installed, for use in double 5/8" drywall applications	2-7/16	4 (5-¼)	1 - 1-¼	50 lb.	10484	18	26
22.5	9350-HNKV2	4" diameter fan box with Vapor Seal flange, "HN" hanger, Speed Klamps™ - factory installed, for use in double 5/8" drywall applications	2-7/16	4 (5-¼)	1 - 1-¼	50 lb.	10485	50	33
22.5	9351-NKV	4" diameter fan box with Vapor Seal flange, fetter ring nails, Speed Klamps™ - factory installed	2-7/16	4 (5-¼)	½ - 5/8	50 lb.	65811	48	27
22.5	9351-NGKV	4" diameter fan box with Vapor Seal flange, fetter ring nails, with Ground Strap, Speed Klamps™ - factory installed	2-7/16	4 (5-¼)	½ - 5/8	50 lb.	99093	48	27



Vapor Seal Fan & Fixture Support

Cu. In. Volume	Catalog Number	Component Description	Exterior Dimensions (flange dim.)		Ceiling Substrate Offset	Fan Rating	Fixture Rating	UPC# 85339	Std. Pkg. Qty.	Std. Wt. (lb.)
			D	W						
12.0	9371-FRV	4" diameter pan fan box with Vapor Seal flange, ½" deep pan, Speed Klamps™ - factory installed	2-7/8 overall	4 (5-¼)	½ - 5/8	70 lb.	110 lb.	92705	24	10
22.5	9350-FANVB	4" diameter fan box with Vapor Seal flange, bar hanger, Speed Klamps™ - factory installed	2-7/16	4 (5-¼)	½ - 5/8	35 lb.	50 lb.	99022	18	31
22.5	9350-FANV2B	4" diameter fan box with Vapor Seal flange, bar hanger, Speed Klamps™ - factory installed, for use in double 5/8" drywall applications	2-7/16	4 (5-¼)	1 - 1-¼	35 lb.	50 lb.	99023	18	31
22.5	9351-NKFRV	4" diameter fan box with Vapor Seal flange, fetter ring nails, Speed Klamps™ - factory installed	2-7/16	4 (5-¼)	½ - 5/8	35 lb.	50 lb.	65810	48	28

All dimensions are in inches unless otherwise noted.
See page 7 for Attachment Coding suffix descriptions.

UL LISTED Outlet Box
UL File No. E30594

Nonmetallic Adjustable Wall Box for Both New & Old Work Construction

Unlike other adjustable boxes, with SLIDERBOX® there's no need to remove or relocate mounting screws to reposition the box.



SLIDERBOX® installed with 1/2" drywall.



SLIDERBOX® adjusted for additional ceramic tile.

SLIDERBOX® Features



- Slots retain slider plate and guide it in a straight motion.
- Internal rails guide slider plate for smooth mounting adjustability in wall substrates from 1/2" to 1 3/8" thick, and ceiling substrates from 1/2" to 1 5/32".

- Square corner design allows easy wall cut-in (old work applications).
- Molded spline device holes for quick device screw installation in wall boxes and machine tapped threads for ceiling fixture support in round ceiling boxes.
- Allied Moulded exclusive patented (U.S. Pat. #6365831 B1) molded in Speed Klamps™ in multi-gang and ceiling boxes.
- Molded of engineering grades of nonmetallic thermoplastic.
- SB-2, SB-3 are UL listed for 2HR fire resistive walls.
- SB-1, SB-1H, SB-CB and SB-CBFR are UL listed for 2HR fire resistive walls and ceilings.



- Slider plate holds screws in ready position to enable contractor to mount boxes faster.
- Patent #7,855,338 design allows for adjustments in new or old work installations.



- Fan support product has steel bracket and mounting bolts for secure paddle fan mounting.



- Heavy-duty non-slip pad to ensure box and slider assembly solidly hold mounted position.
- Tested to hold 50 lbs. hung on box to simulate power cord pull-out strength.



- Multi-gang boxes consist of internal holding slots for LVP-2 low voltage partitions and dual voltage applications.

SLIDERBOX® Installation Instructions

1. Position slider plate forward so box will mount in its normal position for nominal drywall thickness.
2. Attach SLIDERBOX® to wood stud by driving screws in tight.
3. Wires should be installed and drywall hung and trimmed according to building code.
4. SLIDERBOX® will be mounted flush with drywall at this point.



Learn more about SLIDERBOX® products now!

Instructions to Adjust Box for Additional Wall Substrate

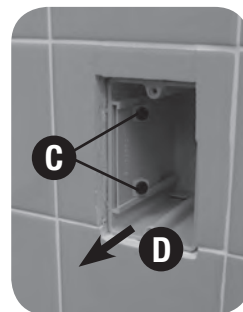

- A. Once additional wall substrate is applied, the SLIDERBOX® will need to be adjusted flush to the new surface.
- B. Make sure there is clearance around the box prior to adjustment.
- C. Loosen the two mounting screws until box moves freely in the slider mechanism and will slide forward.
- D. Grab box interior or the installed wire and pull forward until top edge is flush with the new surface.
- E. Re-tighten the slider plate mounting screws.
- F. Install wire device and cover plate.



SB-1



SB-1H



SB-2



SB-3



SB-4



LVP-2



SB-2 with LVP installed

SLIDERBOX® Adjustable Boxes	Cu. In. Volume	Catalog Number	Component Description	Exterior Dimensions			UPC# 85339	Std. Pkg. Qty.	Std. Wt. (lb.)
				D	W	H			
	23.0	SB-1	Single gang adjustable outlet box, internal stud screws for use in wood or steel non-load-bearing studs 25 gauge or lighter, ½" knockout	3-9/16	2-5/16	3-¾	94500	48	14
	23.0	SB-1H	Single gang adjustable outlet box, horizontal mount , internal stud screws for use in wood or steel non-load-bearing studs 25 gauge or lighter, ½" knockout	3-9/16	3-¾	2-5/16	94503	12	4
	42.0	SB-2	Two-gang adjustable outlet box, internal stud screws for use in wood or steel non-load-bearing studs 25 gauge or lighter, molded-in Speed Klamps™, two ½" knockouts	3-9/16	4	3-¾	94501	24	9
	61.0	SB-3	Three-gang adjustable outlet box, internal stud screws for use in wood or steel non-load-bearing studs 25 gauge or lighter, molded-in Speed Klamps™, two ½" knockouts	3-9/16	5-13/16	3-¾	94502	6	3
	74.8	SB-4	Four-gang adjustable outlet box, internal stud screws for use in wood or steel non-load-bearing studs 25 gauge or lighter, molded-in Speed Klamps™, two ½" knockouts *NOTE: Not UL® classified for fire resistive walls	3-9/16	7-5/8	3-¾	94504	6	4

Low Voltage Partition	Catalog Number	Component Description	UPC# 85339	Std. Pkg. Qty.	Std. Wt. (lb.)

* Consists of ten (10) packages of five (5) pieces each.



SB-CB



SB-CBG



SB-CBFR



Outlet Box
UL File No. E30594

SLIDERBOX® 4" Dia.	Cu. In. Volume	Catalog Number	Component Description	Exterior Dim.		Fan Rating	Fixture Rating	UPC# 85339	Std. Pkg. Qty.	Std. Wt. (lb.)
				D	W					
	25.0	SB-CB	4" diameter adjustable ceiling box, internal stud screws for use in wood or steel non-load-bearing studs 25 gauge or lighter, molded-in Speed Klamps™, two ½" knockouts	2-¾	4	—	50 lb.	94505	12	3
	25.0	SB-CBG	4" diameter adjustable ceiling box, internal stud screws for use in wood or steel non-load-bearing studs 25 gauge or lighter, ground strap, molded-in Speed Klamps™, two ½" knockouts	2-¾	4	—	50 lb.	94507	12	4
	25.0	SB-CBFR	4" diameter adjustable fan & fixture support, internal stud screws for use in wood or steel non-load-bearing studs 25 gauge or lighter, molded-in Speed Klamps™, two ½" knockouts, paddle fan mounting bracket and screws	2-¾	4	70 lb.	90 lb.	94506	12	10

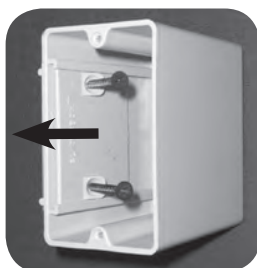

Slider plate in full forward position sets box for 1/2" drywall.

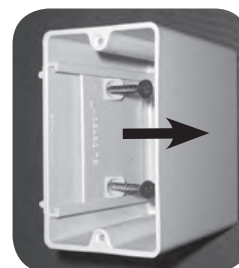

Slider plate retracted sets box in fully adjusted forward position for maximum wall substrate thickness of 1-3/8".



SLIDERBOX® can be used in New Work or Old Work/Manufactured Housing Applications

All dimensions are in inches unless otherwise noted.



Flush-Device Box
UL File No. E30594

flexBOX® Material & Labor Saving Features

Allied Moulded flexBOX switch and outlet boxes are molded of engineering grades of nonmetallic thermoplastic materials. Our flexBOX line of products was created for the electrical contractor looking for nonmetallic outlet boxes with "soft box" characteristics. Allied Moulded's flexBOX line offers the following material advantages:

- Non-corrosive
- Non-conductive
- Lightweight
- No accessory clamps
- Splined thread holes (wall boxes)
- Machine tapped holes (ceiling boxes)

Learn more about
flexBOX® products now!

Labor saving features include:

- Patented #6,365,831 B1 integral Speed Klamps™
- Molded thread device holes for wall boxes
 - Optional Quick Thread™ device holes
- Machine tapped thread holes for secure fixture installation
- Proudly UL® listed
- 2-Hour Fire Rated clearly marked for easy inspector identification
- Large cubic inch capacity clearly marked and easy for contractor and inspector to locate and identify
- Stabilizing bracket for maximum support and flush face alignment of wall boxes
- Molded wallboard tabs for securing multi-gang boxes on the opposite end of the framing stud
- Wall box face brackets for steel or wood stud construction
- Offset gauge marks on box give positive stop for the proper wall thickness
- Square corner design for easy wall cut-in
- Steel wing brackets for secure box mounting
- ½" knockouts in multi-gang old work boxes for use with wire/conduit connectors
- Molded flange and steel snap bracket for secure old work box installation
- Round exterior for easy wall cut-in
- Optional ground strap
- Internal holding slots for low voltage partitions (available on specific multi-gang boxes for dual voltage applications)

flexBOX®

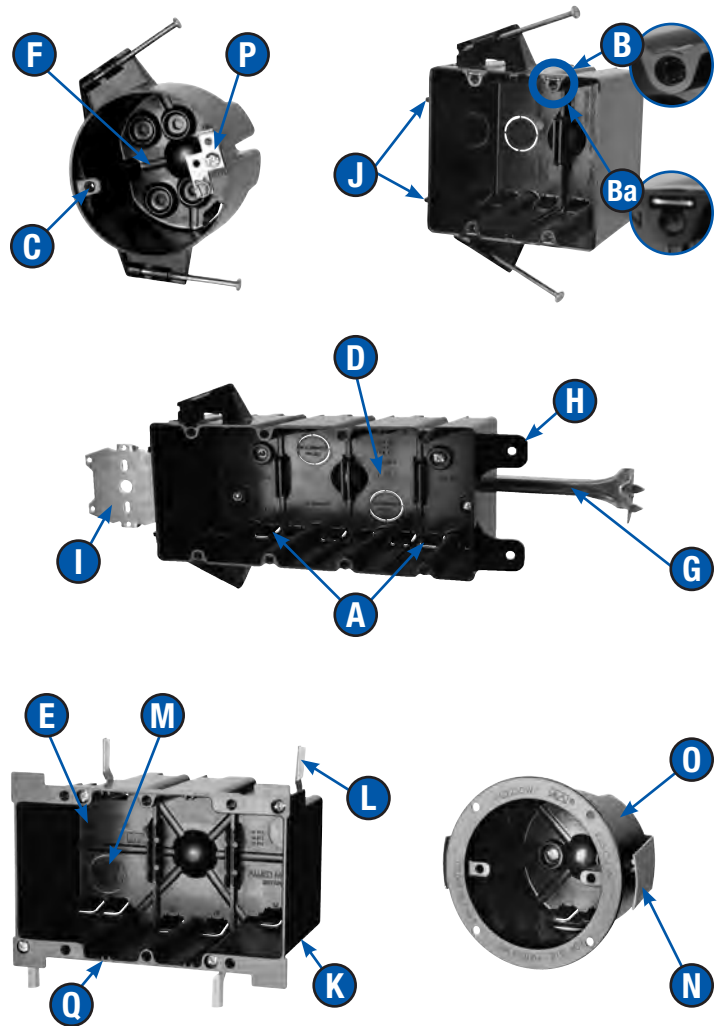
**flexBOX® Attachment Codings**

- | | | | |
|-----------|--|-----------|---|
| B | Stabilizer bracket | N | Nail on mounting |
| G | Ground strap | H | Face bracket for steel and wood stud mounting |
| R | Reverse nail mounting option | QT | Quick Thread™ device hole option |
| BH | Adjustable bar hanger for 16" to 24" joist spacing | 16 | Bar hanger max 16" joist spacing |

All dimensions are in inches unless otherwise noted.

Old Work/Manufactured Housing Boxes

Flush-Device
Box
UL File No. E30594



*Quick Thread™ device hole



Nail-On

Cu. In. Volume	Catalog Number	Component Description	Exterior Dimensions			UPC# 85339	Std. Pkg. Qty.	Std. Wt. (lb.)
			D	W	H			
18.0	P-181	Single gang, angled mid-nails	2-5/8	2-5/16	3-3/4	24391	100	21
18.0	P-181QT	Single gang, angled mid-nails, Quick Thread™ device holes	2-5/8	2-5/16	3-3/4	24399	100	21
18.0	P-181RK	Single gang, reverse nails, molded-in Speed Klamps™	2-11/16	2-5/16	3-3/4	24398	100	21
20.5	P-201	Single gang, angled nails	3-1/16	2-5/16	3-3/4	24900	100	23
20.5	P-201QT	Single gang, angled nails, Quick Thread™ device holes	3-1/8	2-5/16	3-3/4	24909	100	25
20.5	P-201R	Single gang, reverse nails	3-1/16	2-5/16	3-3/4	24901	100	24
23.5	P-122SC	Patented single gang with side cube, angled mid-nails, four wire knockouts, 2 recessed buttons	1-3/4	2-9/32 (5-1/2 overall)	3-3/4	24914	24	9
24.0	P-241	Single gang, angled nails	3-9/16	2-5/16	3-3/4	24903	100	26
24.0	P-241QT	Single gang, angled nails, Quick Thread™ device holes	3-9/16	2-5/16	3-3/4	24904	100	27



Face Bracket Mount

Cu. In. Volume	Catalog Number	Component Description	Exterior Dimensions			UPC# 85339	Std. Pkg. Qty.	Std. Wt. (lb.)
			D	W	H			
18.0	P-181H	Single gang, face bracket mount, 1/2" NM knockouts	2-3/4	2-5/16	3-3/4	24916	48	10
18.0	P-181HZ	Single gang, face bracket mount, 1/2" NM knockouts, "Z" hanger	2-3/4	2-5/16	3-3/4	24919	36	11
24.0	P-241H	Single gang, face bracket mount	3-9/16	2-5/16	3-3/4	24907	50	12
24.0	P-241HQT	Single gang, face bracket mount, Quick Thread™ device holes	3-9/16	2-5/16	3-3/4	24908	50	12

Miscellaneous

Cu. In. Volume	Catalog Number	Component Description	Exterior Dimensions			UPC# 85339	Std. Pkg. Qty.	Std. Wt. (lb.)
			D	W	H			
8.0	P-108E	Single gang, ears	1-1/4	2-5/16	3-3/4	24917	24	3
8.0	P-108H	Single gang, side bracket mount	1-1/4	2-5/16	3-3/4	24918	24	3
16.0	P-1160W	Single gang, ears, wing brackets, 1/2" NM knockouts	2-5/8	2-5/16	3-11/16	24915	48	10
18.0	P-1180W	Single gang, ears, wing brackets, molded-in Speed Klamps™, 1/2" NM knockout	3	2-1/4	3-11/16	92714	48	11
22.5	P-1220W	Single gang, ears, wing brackets, molded-in Speed Klamps™, 1/2" NM knockout	3-3/4	2-5/16	3-3/4	24913	48	14

All dimensions are in inches unless otherwise noted.
See page 32 for flexbox® Attachment Coding suffix descriptions.

Old Work/Manufactured Housing Boxes

Flush-Device Box
UL File No. E30594

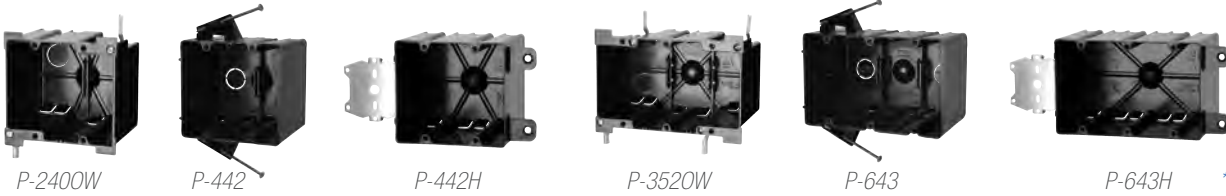

*Quick Thread™ device hole

	Cu. In. Volume	Catalog Number	Component Description	Exterior Dimensions			UPC# 85339	Std. Pkg. Qty.	Std. Wt. (lb.)
				D	W	H			
Two Gang	40.0	P-2400W	Two gang, ears, wing brackets, molded-in Speed Klamps™, two ½" knockouts; *Can use LVP-2 partition for dual voltage applications	3-3/8	4-1/8	3-11/16	24912	24	8
	43.0	P-442	Two gang, angled mid-nails, molded-in Speed Klamps™, two ½" knockouts	3-9/16	4	3-¾	44000	48	17
	43.0	P-442QT	Two gang, angled mid-nails, molded-in Speed Klamps™, two ½" knockouts, Quick Thread™ device holes	3-9/16	4	3-¾	44001	48	16
	43.5	P-442H	Two gang, face bracket side mount hanger, molded-in Speed Klamps™	3-9/16	4	3-¾	44002	48	18
	43.5	P-442HQT	Two gang, ace bracket side mount hanger, molded-in Speed Klamps™, Quick Thread™ device holes	3-9/16	4	3-¾	44003	48	20

	Cu. In. Volume	Catalog Number	Component Description	Exterior Dimensions			UPC# 85339	Std. Pkg. Qty.	Std. Wt. (lb.)
				D	W	H			
Three Gang	55.0	P-3520W	Three gang, ears, wing brackets, molded-in Speed Klamps™, two ½" knockouts; *Can use LVP-2 partition for dual voltage applications	3-3/8	5-15/16	3-11/16	33201	12	6
	63.0	P-643	Three gang, angled nails, molded-in Speed Klamps™, two ½" knockouts	3-9/16	5-13/16	3-¾	46302	20	9
	63.0	P-643QT	Three gang, angled nails, molded-in Speed Klamps™, Quick Thread™ device holes, two ½" knockouts	3-9/16	5-13/16	3-¾	46301	20	10
	64.0	P-643H	Three gang, face bracket side mount hanger, molded-in Speed Klamps™	3-9/16	5-13/16	3-¾	46303	20	11
	64.0	P-643HQT	Three gang, face bracket side mount hanger, molded-in Speed Klamps™, Quick Thread™ device holes	3-9/16	5-13/16	3-¾	46304	20	11

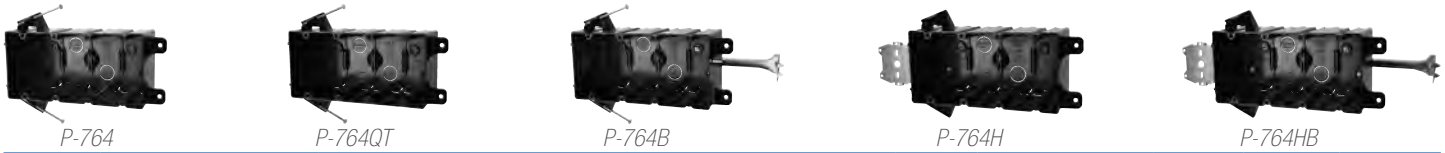

	Cu. In. Volume	Catalog Number	Component Description	Exterior Dimensions			UPC# 85339	Std. Pkg. Qty.	Std. Wt. (lb.)
				D	W	H			
Four Gang	74.8	P-764	Four gang, angled nails, molded-in Speed Klamps™, two ½" knockouts	3-¼	7-5/8	3-¾	94060	18	10
	74.8	P-764QT*	Four gang, angled nails, molded-in Speed Klamps™, Quick Thread™ device holes, two ½" knockouts	3-¼	7-5/8	3-¾	94063	18	9
	74.8	P-764B*	Four gang, angled nails, molded-in Speed Klamps™, stabilizer bracket, two ½" knockouts	3-¼	7-5/8	3-¾	94061	18	13
	74.8	P-764BQT*	Four gang, angled nails, molded-in Speed Klamps™, stabilizer bracket, Quick Thread™ device holes, two ½" knockouts	3-¼	7-5/8	3-¾	94062	18	13
	74.8	P-764H*	Four gang, face bracket side mount hanger, molded-in Speed Klamps™, two ½" knockouts	3-¼	7-5/8	3-¾	94064	12	9
	74.8	P-764HQT*	Four gang, face bracket side mount hanger, molded-in Speed Klamps™, Quick Thread™ device holes, two ½" knockouts	3-¼	7-5/8	3-¾	94065	12	9
	74.8	P-764HB*	Four gang, face bracket side mount hanger, molded-in Speed Klamps™, stabilizer bracket, two ½" knockouts	3-¼	7-5/8	3-¾	94066	6	5
	74.8	P-764HBQT*	Four gang, face bracket side mount hanger, molded-in Speed Klamps™, stabilizer bracket, Quick Thread™ device holes, two ½" knockouts	3-¼	7-5/8	3-¾	94067	6	6

*NOTE: flexbox four gang switch/receptacle boxes are **not** UL classified for fire resistive walls.

All dimensions are in inches unless otherwise noted.

See page 32 for flexbox® Attachment Coding suffix descriptions.



Old Work/Manufactured Housing Boxes



Flush-Device Box

UL File No. E30594



LVP-2



P2400W with LVP-2 installed



P3520W with LVP-2 installed

Low Voltage Partition	Catalog Number	Component Description	UPC# 85339	Std. Pkg. Qty.	Std. Wt. (lb.)
	LVP-2	Low voltage divider plate for use with the following part numbers: P-442, P-442QT, P-643, P-643QT, P-764, P-764QT, P-764B, P-764H, P-764HBQT, P-2400W, and P-3520W		80005	50*

* Consists of ten (10) packages of five (5) pieces each.



PJ-20N



PJ-20H



PJ-32N



PJ-32H



PJ-4S1



PJ-4T1



PJ-4B

4" Square Junction Boxes	Cu. In. Volume	Catalog Number	Component Description	Exterior Dimensions			UPC# 85339	Std. Pkg. Qty.	Std. Wt. (lb.)
				D	W	H			
20.5	PJ-20N	4" square junction box, angled nails, molded-in Speed Klamps™	1-5/8	4	4	99001	48	11	
20.5	PJ-20H	4" square junction box, face bracket side mount hanger, molded-in Speed Klamps™	1-5/8	4	4	99000	48	15	
32.5	PJ-32N	4" square junction box, angled nails, molded-in Speed Klamps™	2-1/2	4	4	99003	48	13	
32.5	PJ-32H	4" square junction box, face bracket side mount hanger, molded-in Speed Klamps™	2-1/2	4	4	99002	48	17	

Plaster Rings/Cover	Cu. In. Volume	Catalog Number	Component Description	Exterior Dimensions			UPC# 85339	Std. Pkg. Qty.	Std. Wt. (lb.)
				D	W	H			
4.2	PJ-4S1	Single gang plaster ring for use w/ 4" square junction box, 1/2" offset	5/8	4	4	99004	100	8	
5.1	PJ-4S2	Single gang plaster ring for use w/ 4" square junction box, 5/8" offset	3/4	4	4	99005	50	5	
6.7	PJ-4T1	Two gang plaster ring for use w/ 4" square junction box, 1/2" offset	5/8	4	4	99006	50	4	
8.1	PJ-4T2	Two gang plaster ring for use w/ 4" square junction box, 5/8" offset	3/4	4	4	99007	50	4	
—	PJ-4B	Square blank cover for use with 4" square junction box	—	4	4	99008	100	8	

All dimensions are in inches unless otherwise noted.
 See page 32 for flexbox® Attachment Coding suffix descriptions.



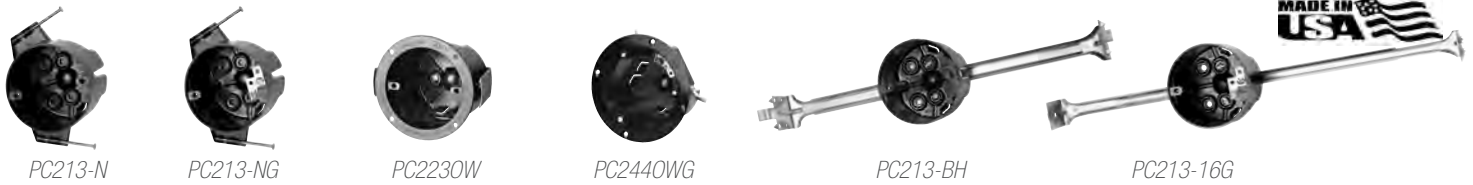

3-1/2" Dia. Round Outlet	Cu. In. Volume	Catalog Number	Component Description	Exterior Dimensions		Fixture Rating	UPC# 85339	Std. Pkg. Qty.	Std. Wt. (lb.)
				D	W				
	21.0	PC213-N	Angled fetter ring nails, molded-in Speed Klamps™	2-13/16	3-1/2	50 lb.	98011	50	12
	21.0	PC213-NG	Angled fetter ring nails, molded-in Speed Klamps™, ground strap	2-13/16	3-1/2	50 lb.	98012	50	13
	21.5	PC2230WG	Flange, snap bracket, ground strap, molded-in Speed Klamps™	2-13/16	3-1/2	■	98029	24	10
	21.5	PC2230W	Flange, snap bracket, molded-in Speed Klamps™	2-13/16	3-1/2	■	98028	24	9
	21.5	PC2440WG	Flange, snap bracket, ground strap, molded-in Speed Klamps™	3	4	■	98311	24	7
21.5	PC2440W	Flange, snap bracket, molded-in Speed Klamps™	3	4	■	97418	24	7	

*3-1/2" Dia. Round Outlet w/ Bar	Cu. In. Volume	Catalog Number	Component Description	Exterior Dimensions		Fixture Rating	UPC# 85339	Std. Pkg. Qty.	Std. Wt. (lb.)
				D	W				
	21.0	PC213-BH**	16" - 24" adjustable bar hanger, molded-in Speed Klamps™	2-13/16	3-1/2	50 lb.	98030	24	27
	21.0	PC213-BHG**	16" - 24" adjustable bar hanger, ground strap, molded-in Speed Klamps™	2-13/16	3-1/2	50 lb.	98031	24	27
	21.0	PC213-16*	16" bar hanger, molded-in Speed Klamps™	2-13/16	3-1/2	50 lb.	98304	24	17
21.0	PC213-16G*	16" bar hanger, ground strap, molded-in Speed Klamps™	2-13/16	3-1/2	50 lb.	98305	24	17	

NOTES: * For maximum 16" on-center joist applications only ** For 16" - 24" on-center joist applications ■ Meets NEC for wall applications



4" Dia. Round Outlet	Cu. In. Volume	Catalog Number	Component Description	Exterior Dimensions		Fixture Rating	UPC# 85339	Std. Pkg. Qty.	Std. Wt. (lb.)
				D	W				
23.0	PC234-N	Angled fetter ring nails, molded-in Speed Klamps™	2-5/16	4	50 lb.	98025	50	12	
23.0	PC234-NG	Angled fetter ring nails, ground strap, molded-in Speed Klamps™	2-5/16	4	50 lb.	98026	50	13	

**4" Dia. Round Outlet w/ Bar	Cu. In. Volume	Catalog Number	Component Description	Exterior Dimensions		Fixture Rating	UPC# 85339	Std. Pkg. Qty.	Std. Wt. (lb.)
				D	W				
	23.0	PC234-BH**	16" - 24" adjustable bar hanger, molded-in Speed Klamps™	2-5/16	4	50 lb.	98032	24	27
	23.0	PC234-BHG**	16" - 24" adjustable bar hanger, ground strap, molded-in Speed Klamps™	2-5/16	4	50 lb.	98033	24	27
	23.0	PC234-16*	16" bar hanger, molded-in Speed Klamps™	2-5/16	4	50 lb.	98306	24	16
23.0	PC234-16G*	16" bar hanger, ground strap, molded-in Speed Klamps™	2-5/16	4	50 lb.	98307	24	16	

NOTES: * For maximum 16" on-center joist applications only; ** For 16" - 24" on-center joist applications

All dimensions are in inches unless otherwise noted.

See page 32 for flexbox® Attachment Coding suffix descriptions.



Old Work/Manufactured Housing Boxes



Outlet Boxes

UL File No. E30594

Accessories

Bulk Clamps, Ground Straps, Panel Stops, Low Voltage Partitions, Templates



ALLIED
MOULDED
PRODUCTS, Inc.



1K-100



WINGS



WIRE CLAMP



GRD STRAP



50PANST

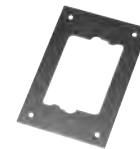

1TP



2TP

Clamp	Catalog Number	Component Description	UPC# 85339	Std. Pkg. Qty.	Std. Wt. (lb.)
	1K-100	Single Speed Klamp™	88011	100	1

Wings	Catalog Number	Component Description	UPC# 85339	Std. Pkg. Qty.	Std. Wt. (lb.)
	WINGS	Metal wing bracket and screw	89056	100	2

Wire Clamp	Catalog Number	Component Description	UPC# 85339	Std. Pkg. Qty.	Std. Wt. (lb.)
	WIRE CLAMP	Wire clamp with screw	88010	100	2

Ground Strap	Catalog Number	Component Description	UPC# 85339	Std. Pkg. Qty.	Std. Wt. (lb.)
	GRD STRAP	Ground strap with screw	88020	100	2

Panel Stop	Catalog Number	Component Description	UPC# 85339	Std. Pkg. Qty.	Std. Wt. (lb.)
	50PANST	Panel stop to square up box in misaligned walls	17546	50	1

Templates	Catalog Number	Component Description	Exterior Dimensions			UPC# 85339	Std. Pkg. Qty.	Std. Wt. (lb.)
			D	W	H			
	1TP	Metal template for single gang old work box: Series 9331-E, 9363-E, & 9368-E	0.062	4	6	88015	1	1
2TP	Metal template for two gang old work box: 9312-E series, 9329-E series	0.062	6	6	88016	1	2	

Installation Instructions: Single Gang Boxes

Old Work Single Gang Boxes with Ears

Part Numbers: [9331-EK](#), [9363-EK](#), [9368-EK](#)

The Allied Moulded 9331-EK, 9363-EK and 9368-EK can be mounted two ways, either through the holes in the metal plaster ears or through the hole provided in the bottom of the box.

Ear Mount Instructions

1. Cut an opening in the wall to comply with NEC 314-20. Allied Moulded Products' template #1TP is designed to provide the guide for such a hole and allows 1/16" clearance around the outside of the box.
2. Using two (2) #8 sheet metal screws at least 3/4" in length, attach the box to the substrate. One screw should be located at each end of the box. UL® has tested these boxes in 3/8" thick plywood, which is the substrate used for its standard test. The strength of the substrate must be equal to 3/8" thick plywood.
3. If the wall assembly is not accessible from the back side to complete the wiring, then the wires must be secured to the box with Speed Klamps™ before installing the box in the wall assembly.



Bottom Mount Instructions

1. Cut an opening in the wall to comply with NEC 314-20. Allied Moulded Products' template #1TP is designed to provide the guide for such a hole and allows 1/16" clearance around the outside of the box.
2. Secure mounting block scab in wall.
3. Using one (1) #8 sheet metal screw at least 3/4" in length, mount box to the scab through the hole in the bottom of the box. UL has tested these boxes in 3/8" thick plywood, which is the substrate used for its standard test. The strength of the scab must be equal to 3/8" thick plywood.
4. If the wall assembly is not accessible from the back side to complete the wiring, then the wires must be secured to the box with Speed Klamps before installing the box in the wall assembly.

Old Work Single Gang Boxes with Wing Brackets

Part Numbers: [9331-EWK](#), [9363-EWK](#), [9368-EWK](#), [P-1220W](#)

The Allied Moulded 9331-EWK, 9363-EWK* and 9368-EWK are mounted identically (via 1a.); P-1220W (via 1b.).

- 1a. Cut an opening in the wall to comply with NEC 314-20. Allied Moulded Products' template #1TP is designed to provide the guide for such a hole and allows 1/16" clearance around the outside of the box.
- 1b. Cut an opening in the wall to comply with NEC 314-20. Using the box as a template, place the box open face against the wall surface where the box is to be installed. Draw a line along each long side and each short side stopping at the molded ears. Remove the box and with a straight edge, complete the rectangle. Cut along the line of the rectangle using the appropriate tools.
2. Insert box into opening. Tighten wing screws to secure box to wall substrate. UL has tested these boxes in 3/8" thick plywood which



is the substrate used for its standard test. The strength of the substrate must be equal to 3/8" thick plywood.

3. If the wall assembly is not accessible from the back side to complete the wiring, then the wires must be secured to the box with Speed Klamps before installing the box in the wall assembly.

**Allied Moulded Products has had the 9363-EW style box tested in wall assemblies that use 5/16" thick gypsum board covering. This test was conducted by a testing laboratory that has been evaluated by BOCA as an independent testing and inspection agency for manufactured buildings. This report is available upon request.*

Old Work Single Gang Boxes with Snap Brackets (for wall applications)

Part Numbers: [9361-ES](#), [9361-ESK](#)

1. Cut an opening in the wall to comply with NEC 314-20. Using the box as a template, place the box open face against the wall surface where the box is to be installed. Draw a line along each long side and each short side stopping at the molded ears. Remove the box and with a straight edge, complete the rectangle. Cut along the line of the rectangle using the appropriate tools.
2. Insert box into opening. Bracket will automatically compress and snap back into position. Tighten snap bracket screws until bracket is drawn snug to the back of the wallboard. Note: Wall substance must be capable of supporting the box with the rated load.
3. If the wall assembly is not accessible from the back side to complete the wiring, the wires must be secured to the box with Speed Klamps before installing the box in the wall assembly.



Installation Instructions: Two Gang Boxes

Old Work Two Gang with Wing Brackets

Part Numbers: [9312-EWK](#),
[9329-EWK \(1a.\)](#), [P-2400W \(1b.\)](#)

- 1a. Cut an opening in the wall to comply with NEC 314-20. Allied Moulded Products' template #2TP is designed to provide the guide for such a hole and allows 1/16" clearance around the outside of the box.
- 1b. Cut an opening in the wall to comply with NEC 314-20. Using the box as a template, place the box open face against the wall surface where the box is to be installed. Draw a line along each long side and each short side stopping at the molded ears. Remove the box and with a straight edge, complete the rectangle. Cut long the line of the rectangle using the appropriate tools.
2. Insert box into opening. Tighten wing screws to secure box to wall substrate. UL has tested these boxes in 3/8" thick plywood which is the substrate used for its standard test. The strength of the substrate must be equal to 3/8" thick plywood.
3. If the wall assembly is not accessible from the back side to complete the wiring, then the wires must be secured to the box with Speed Klamps before installing the box in the wall assembly.



Installation Instructions

For Flush Device & Round Outlet Boxes



ALLIED
MOULDED
PRODUCTS, Inc.

Installation Instructions: Two Gang Boxes

Old Work Two Gang with Wing Brackets

Part Numbers: 9312-EWK, 9329-EWK (1a.), P-2400W (1b.)

- 1a. Cut an opening in the wall to comply with NEC 314-20. Allied Moulded Products' template #2TP is designed to provide the guide for such a hole and allows 1/16" clearance around the outside of the box.
- 1b. Cut an opening in the wall to comply with NEC 314-20. Using the box as a template, place the box open face against the wall surface where the box is to be installed. Draw a line along each long side and each short side stopping at the molded ears. Remove the box and with a straight edge, complete the rectangle. Cut long the line of the rectangle using the appropriate tools.
2. Insert box into opening. Tighten wing screws to secure box to wall substrate. UL has tested these boxes in 3/8" thick plywood which is the substrate used for its standard test. The strength of the substrate must be equal to 3/8" thick plywood.
3. If the wall assembly is not accessible from the back side to complete the wiring, then the wires must be secured to the box with Speed Klamps before installing the box in the wall assembly.



Part Number: 9372-NMHK

1. Locate and position leveling rib on surface of box to the framing member. This will position box at a depth of 7/16" to 1/2".
2. Hold box at desired position and drive nails into stud with hammer.
3. Install nonmetallic sheathed cable through knockout.



Installation Instructions: Three & Four Gang Boxes

Old Work Three & Four Gang Box with Wing Brackets

Part Numbers: 9313-EWK & 9314-EWK(1a.), P-3520W (1b.)

- 1a. Cut an opening in the wall to comply with NEC 314-20.
- 1b. Cut an opening in the wall to comply with NEC 314-20. Using the box as a template, place the box open face against the wall surface where the box is to be installed. Draw a line along each long side and each short side stopping at the molded ears. Remove the box and with a straight edge, complete the rectangle. Cut along the line of the rectangle using the appropriate tools.
2. Insert box into opening. Tighten wing screws to secure box to wall substrate. UL has tested these boxes in 3/8" thick plywood which is the substrate used for its standard test. The strength of the substrate must be equal to 3/8" thick plywood.
3. If the wall assembly is not accessible from the back side to



complete the wiring, the wires must be secured to the box with Speed Klamps before installing the box in the wall assembly.

Installation Instructions: 3-1/2" Round Boxes

Part Numbers: 9305-K, 9355-K, PC2230W

The Allied Moulded 9305-K and 9355-K can be mounted two ways, either through the holes in the flange or through the holes provided in the bottom of the box.



Flange Mount Instructions

1. Cut a 3-5/8" diameter circular hole in the wall or ceiling board. The box diameter is nominally 3-1/2" and the 3-5/8" diameter hole allows 1/16" clearance around the outside of the box.
2. Using two (2) #8 sheet metal screws at least 3/4" in length, attach the box to the substrate through two (2) of the holes provided diagonally across from each another. Note: Wall substance must be capable of supporting the box with the rated load.
3. If the wall assembly is not open to the back side to complete the wiring, the wires must be secured to the box with Speed Klamps before installing the box in the wall assembly.

Bottom Mount Instructions

1. Cut a 3-5/8" diameter circular hole in the wall or ceiling board. The box diameter is nominally 3-1/2" and the 3-5/8" diameter hole allows 1/16" clearance around the outside of the box.
2. Secure mounting block scab in wall. For a 9305-K, the scab is to be installed 1-13/16" from the substrate surface into the wall section. A 9355-K would require the scab to be mounted in the wall section 2-13/16" from the substrate surface. A PC2230W would require the scab to be mounted 2-13/16" from the substrate surface into the wall section.
3. Using two (2) #8 sheet metal screw at least 3/4" in length, mount box to the scab through the two (2) holes in the bottom of the box. Note: Wall substance must be capable of supporting the box with the rated load.
4. If the wall assembly is not accessible from the back side to complete the wiring, the wires must be secured to the box with Speed Klamps before installing the box in the wall assembly.

Old Work Round Boxes with Snap Brackets (for wall applications)

Part Numbers: 9305-SK, 9338-ESK, 9355-SK, 9361-ES/-ESK, PC2230W

1. Cut a 3-5/8" diameter circular hole in the wall board. The box diameter is nominally 3-1/2" and the 3-5/8" diameter hole allows 1/16" clearance around the outside of the box.
2. Insert box into opening. Bracket will automatically compress and snap back into position. Tighten snap bracket screws until bracket is drawn snug to the back of the wallboard. Note: Wall substance must be capable of supporting the box with the rated load.
3. If the wall assembly is not accessible from the back side to complete the wiring, the wires must be secured to the box with Speed Klamps before installing the box in the wall assembly.



Structured Cable/Low Voltage

Single Gang Boxes, Low Voltage Partitions, Plaster Rings



ALLIED
MOULDED
PRODUCTS, Inc.



LVBOW-1



LVB-1



LVPR-1



LVP-1



LVP-2

Structured Cable/Low Voltage

Catalog Number	Component Description	Exterior Dimensions			UPC# 85339	Std. Pkg. Qty.	Std. Wt. (lb.)
		D	W	H			
LVBOW-1	Single gang, old work, structured cable box with ears and wings	3-1/16	2-5/16	3-11/16	80003	24	5
LVB-1	Single gang, angled mid-nails, structured cable box	2-3/4	2-1/4	3-3/4	80002	48	9
LVPR-1	Single gang plaster ring, 1/2" offset, structured cable bracket for steel or wood stud face mounting	5/8	4	4	80001	50	4
LVP-1	Low voltage divider plate for use with fiberglassBOX™ series 2302, 3303, 4304, 5305, and 9314 only	3/32	3-5/16	3-3/4	80000	50*	3
LVP-2	Low voltage divider plate for use with SLIDERBOX® series SB-2, SB-3, and SB-4; and flexBOX® part numbers P-442, P-442QT, P-643, P-643QT, P-764, P-764QT, P-764B, P-764H, P-764HBQT, P-2400W, and P-3520W	3-32	3-1/16	3-1/2	80005	50*	3

* Consists of ten (10) packages of five (5) pieces each.

LVBOW-1 Features and Benefits

- Old work structured cable box
- Sturdy construction with “box-like” strength and rigidity
- Molded thread device holes provide for secure mounting of structured cable devices and cover plates
- Eliminates the need to modify single gang outlet boxes
- Open back design for generous cable bend radius
- Holes in back section provide a means to secure the cable allowing cable accessibility later (Fig. A)
- U.S. Patents D531,128 and 7,179,994



LVB-1 Features and Benefits

- New work structured cable box
- Sturdy construction with “box-like” strength and rigidity
- Eliminates need to modify single gang box
- Open back for generous cable bend radius
- Easy nail-on mounting design
- Holes on back provide a means to wire tie the cable allowing cable accessibility later (Fig. A)
- Open back channel to store and protect cable during drywall phase (Fig. B)
- US Patents D531,128 and 7,179,994

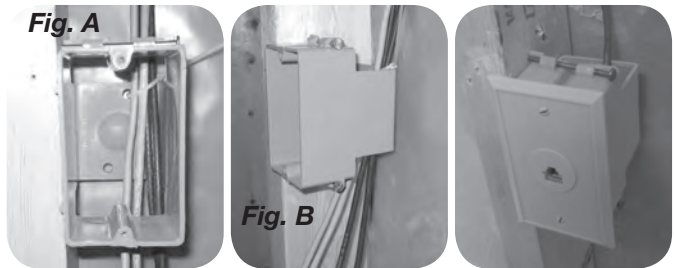

LVP-1/LVP-2 Features and Benefits

- Separates line and low voltage within the same electrical box
- Use LVP-1 with Allied Moulded’s deep series 2302, 3303, 4304, 5305, and 9314 fiberglass boxes
- Use LVP-2 with Allied Moulded’s flexBOX® products and SLIDERBOX® products (see chart above for specific part numbers)
- Allows for a reduced number of wall box installations
- Fast, easy and convenient to install

- Complies with article 800.133(A)(1)(c) from 2008 NEC
- For low voltage applications in fire rated walls, utilize the LVP-1 partition with the Allied Moulded deep series fiberglass wall boxes which carry the industry exclusive rating for reduced horizontal separation in the same stud cavity

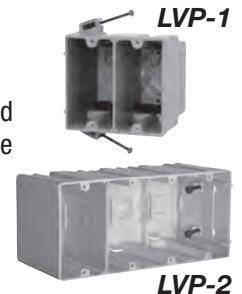

All dimensions are in inches unless otherwise noted.

Old Work/Manufactured Housing Boxes



UL File No. E245435 - Boxes
UL File No. E30594 - Partitions



AC9500



AC9501



AC9502

PARA-form® Siding Boxes	Cu. In. Volume	Catalog Number	Component Description	Fixture Rating	UPC# 85339	Std. Pkg. Qty.	Std. Wt. (lb.)
	12.0	AC9500	One-piece 4" diameter x 1-¼" high round outlet box with 7" square mounting flange, construction prevents water from running behind box, "pop-in" nonmetallic sheathed cable clamp included	15 lb.	09500	20	12
	12.0	AC9500BULK	One-piece 4" diameter x 1-¼" high round outlet box with 7" square mounting flange, construction prevents water from running behind box, "pop-in" nonmetallic sheathed cable clamp included - bulk packed	15 lb.	09503	50	29
	12.0	AC9501	One (1) AC9500 outlet box and one (1) siding installation block, outside dimensions are 6-½" x 6-½" with a 4" diameter opening, "pop-in" nonmetallic sheathed cable clamp included	15 lb.	09501	20	15
	12.0	AC9502	One (1) AC9500 outlet box and one (1) siding installation block, accommodates larger fixture bases, outside dimensions are 6-7/8" x 10-3/4" with a 4" diameter opening, "pop-in" nonmetallic sheathed cable clamp included	15 lb.	09502	12	11

NOTE: PARA-form® blocks come in a standard white color. They may be painted to match any siding color.

Mounting Instructions for PARA-form® Siding Boxes

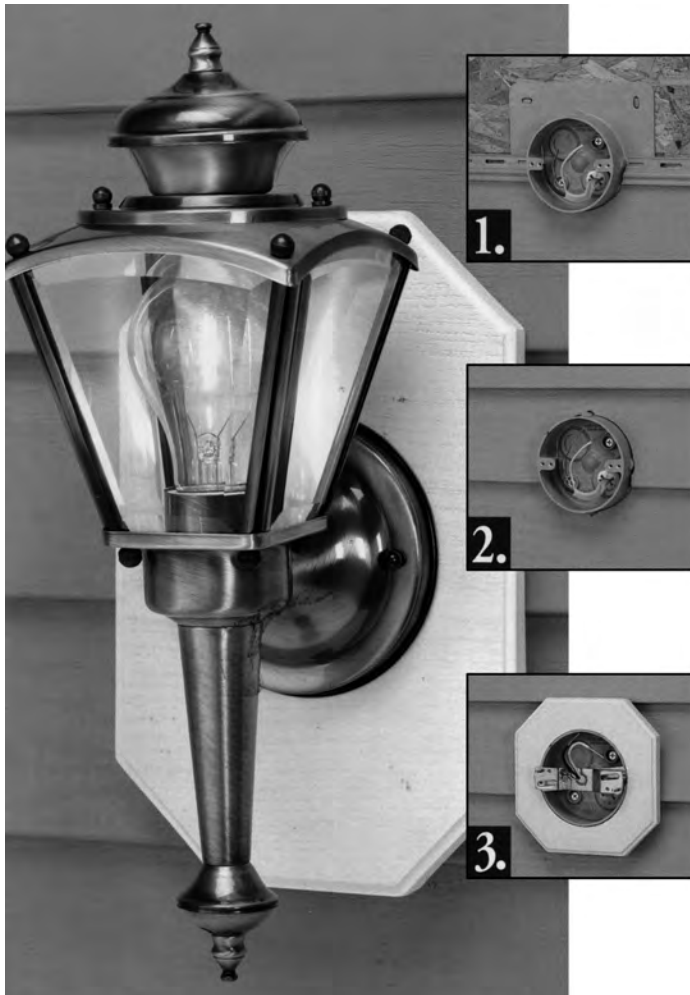

1. Mount electrical box to exterior wall and feed wiring through knockout prior to siding.

2. Affix mounting brackets, and caulk around box after siding is installed.

3. Fit **PARA-form** block to siding box and install light fixture.

All dimensions are in inches unless otherwise noted.



UL File No. E30594

Lampholders

Incandescent and GU24



Lampholders	Catalog Number	Component Description	Outside Diameter	UPC# 85339	Std. Pkg. Qty.	Std. Wt. (lb.)
	LH-11P	Keyless lampholder, 660W/250V, 4 terminal screws	4-9/16	87000	48	13
	LH-11WP	Keyless lampholder with wire leads, 660W/250V	4-9/16	87001	48	14
	LH-12P	Lampholder 660W/250V, 3' pull cord, 2 terminal screws	4-9/16	87002	48	15
	LH-12WP	Lampholder with wire leads, 660W/250V, 3' pull cord	4-9/16	87003	48	16
	LH-13P	Lampholder, 660W/250V, 3' pull cord, grounded outlet (125VAC/15A)	4-9/16	87004	48	18

Lampholder Features

- Mounting slots accept 3-1/2" or 4" outlet boxes
- Lamp rated 660 watts (max.)
- Made of UV and heat-resistant thermoset material
- Nickel-plated brass screw shell and includes plated steel hardware



- All models accept most manufacturers' bulb protective cages
- For use in non-corrosive, residential lighting applications as permitted by local code
- All models are individually polybagged



*GU24 Lampholders	Catalog Number	Component Description	Outside Diameter	UPC# 85339	Std. Pkg. Qty.	Std. Wt. (lb.)
	LH-21WP	GU24 keyless lampholder with wire leads, 75W/250V	4-7/8	99583	48	11
	LH-22WP	GU24 pull chain lampholder with wire leads, 75W/250V, 3' pull cord	4-7/8	99584	48	15

***NOTE:** Not intended for use with GU24/incandescent adapter designs

GU24 Lampholder Features

- Listed per UL ® 496
- Mounting slots accept 3-1/2" or 4" outlet boxes
- Lampholder rated 75 Watts, 250 Volts
- Made of UV and heat-resistant polycarbonate material
- Will accept industry standard lamps with GU24 pin design (*see note above)
- For use in non-corrosive, residential lighting applications as permitted by local code
- All models are individually polybagged
- Title 24 compliant for installation of lampholders in California

All dimensions are in inches unless otherwise noted.

Designed in USA • Made in China



UL File No. E68415 - Incandescent
UL File No. E359883 - GU24

Compact Fluorescent Luminaires

CFL's



ALLIED
MOULDED
PRODUCTS, Inc.



LH-CFL1



LH-CFL2



33213SSP

Compact Fluorescent Luminaires	Bulb Wattage	Catalog Number	Component Description	Base Dia.	Assembled Height	UPC#	Std. Pkg. Qty.	Std. Wt. (lb.)
	13W	LH-CFL1	Compact fluorescent luminaire with wire leads (mounting screws included)	5.06	3.04	8533987005	12	9
	13W	LH-CFL2	Compact fluorescent luminaire with wire leads and pull chain (mounting screws included)	5.06	3.82	8533987006	12	12
	13W	33213SSP*	Squat or low-profile compact fluorescent lamp, GU24 base. *See additional replacement lamp part numbers below.	—	2.3 (M.O.L.)	76214809173	6	2

***Replacement Lamp Part Numbers:**

MaxLite; MLS13FUSWW, 13 Watt, GU24 fixture base, M.O.L. = 2.52"

TCP; 33213SSP, 13 Watt, GU24 fixture base, M.O.L. = 2.3"

Golo; GU241327, 13 Watt, GU24 fixture base, M.O.L. = 2.36"

Luminaire Design Features

- For use in attics, basements, closets and garages
- ENERGY STAR certified
- Energy savings of up to 75% compared to incandescent bulbs
- 10,000 hour lamp life
- Fully assembled with GU24 – 13W lamp and polycarbonate lens
- 13W CFL lamp produces same light as 60W standard incandescent light bulb
- Lens securely locks to base with spring-loaded tabs
- Lamp base mounts to most 3-½" and 4" ceiling boxes



Supplied with compact fluorescent lamp, mounting screws, and wire nuts.



Prepackaged in a blister pack with bi-lingual installation instructions.

All dimensions are in inches unless otherwise noted.

Designed in USA • Made in China



UL File No. E337796

Floor Box Assemblies

For New and Old Work Wood Floor Cut-In Applications



SLIDERBOX® Floor Box Options Added

Allied Moulded is expanding its line of floor box assemblies to include the new SLIDERBOX® floor box with flip lid cover. The new box is designed with Allied Moulded's patented SLIDERBOX® feature, and can be adjusted and installed in the "up" position to aid in easier installation of flooring material.



The new floor box is available in 3 cover finishes; brass, dark bronze, and nickel. The box is sold as a complete assembly kit and is ready for installation.



Learn more about floor box products now!

Features & Benefits

- Designed for use in raised wood floor construction and multiple floor substrate materials. This allows for quick and easy floor installation.
- No need to remove or relocate mounting screws to reposition the box. Simply loosen the screws and slide the box up or down.
- Three cover options; brass, dark bronze, or nickel
- Flip lid cover seals water tight and allows assembly to meet UL 514C scrub-water exclusion test
- Decorator type Tamper Resistant (TR) receptacle; 15 amp 125 volt with ground (NEMA config. 5-15R)
- Provisions for cable entry through molded-in Speed Klamps™ or 1/2" bottom knockouts
- Substrate thickness of 1-9/16" when utilizing positioning tabs. *Max floor substrate of 2"



SBFB-1



SBFB-1N



SBFB-1DB

SLIDERBOX® Floor Box Assembly Installation Instructions

With the new SLIDERBOX® floor box, installation of subfloor materials has become less of a daunting task. There's no need to remove or relocate the mounting screws during installation, making this one-person assembly quick and simple! Simply install the floor box in the highest position, and install subfloor around the box.

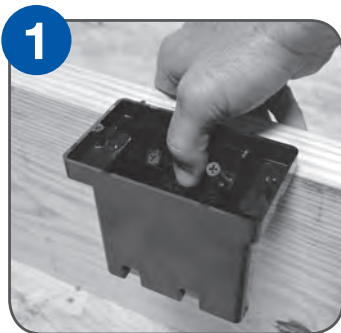

1 Find and install floor box on solid floor joist; mount with slider plate in the "up" position



2 Move floor box in highest position by loosening slider plate screws, install sub floor around raised box



3 Install desired floor material around the raised floor box. The raised box allows for easier installation by contractors



4 Adjust box height to achieve a flush position; wire the included device and install the gasket and cover

All dimensions are in inches unless otherwise noted.

Designed in USA • Made in China

Floor Box 714L
UL File No. E30594

Floor Box Assemblies

For Wood Floor Cut-In Applications

Cut in Floor Box Assembly Installation Instructions



1 Find a location in between floor joists and measure the box dimensions according to the template supplied in the installation instruction sheet.



2 Once measured, place the installation template on the floor and cut a hole accordingly. A small drill, jigsaw, or hole saw can be used to precisely cut the hole required.

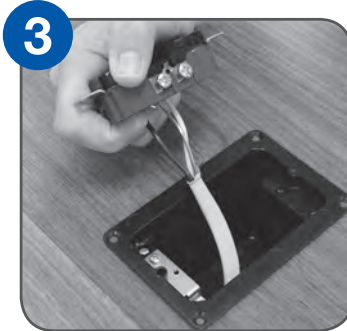

3 Bring the electrical cable through the preferred box clamp, and place the box down in the hole and secure it with the preferred mounting method. Wire the device according to local electrical code.



4 Once the device has been wired, secure the device and dust plate down into the box using the screws supplied in the packaging.



5 Place the cover gasket on the box flange and position the cover assembly over the gasket to ensure an adequate seal between box and lid is met.



6 Secure the cover to the box with the screws supplied in the packaging. Attach all screw plugs and keystone plugs as required.

Line/Low Voltage Product Options Added

Allied Moulded now offers five floor box assemblies that have line/low voltage options. The round FB-4 is similar in design to Allied Moulded's popular FB-3 assembly, but includes a provision for adding two industry standard low voltage keystone plugins. The square FB-5 is a two-gang assembly featuring a new decorative style device along with flip lid covers and a provision for four industry standard low voltage keystone plugins or a second device.

The single gang FB-6 series is similar to the FB-2 series, but has a decorative device and a flip lid cover. The FB-7 series design is similar to the FB-3 series and the FB-8 series is similar to the FB-4 series; both series have 5.75" diameter covers with flip lids.

All assemblies are available in three cover finish options including brass, dark bronze, and nickel. See images below for standard features of the line/low voltage options.

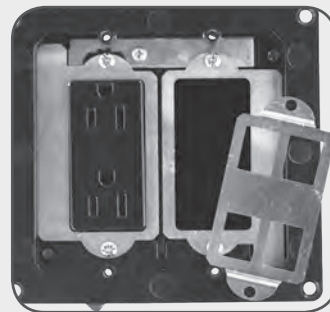

The FB-5 comes standard with one decorative device and two plates for installing an additional device or up to 4 LV keystone plugins, plus the required low voltage box divider plate

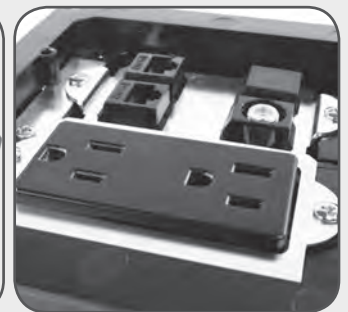

Industry standard LV keystone plugins installed. Low voltage divider plate is factory installed per code requirements. Note: LV plugins are not supplied with the FB-5 assembly



The FB-4/FB-8 comes standard with a duplex device and provision for adding 2 standard LV keystone plugins



Industry standard LV keystone plugins installed. Note: LV plugins are not supplied with the FB-4/FB-8 assembly

All dimensions are in inches unless otherwise noted.

Designed in USA • Made in China

Floor Box Assemblies

Single Gang, Rectangular Profile



ALLIED
MOULDED
PRODUCTS, Inc.



FB-1



FB-2N



FB-6



FB-6DB



SBFB-1

Floor Box Assemblies: Single Gang	Cu. In. Volume	Catalog Number	Cover Finish	Cover Type	Device	LV Provision	UPC# 85339	Std. Pkg. Qty.	Std. Wt. (lb.)
	24.5	FB-1	Brass	Screw Plug	Simplex	No	94123	6	9
	24.5	FB-1N	Nickel	Screw Plug	Simplex	No	94128	6	9
	24.5	FB-2	Brass	Screw Plug	Duplex	No	94124	6	9
	24.5	FB-2DB	Dark Bronze	Screw Plug	Duplex	No	99601	6	9
	24.5	FB-2N	Nickel	Screw Plug	Duplex	No	94129	6	9
	24.5	FB-6	Brass	Flip Lid	Decorative	No	97233	6	10
	24.5	FB-6DB	Dark Bronze	Flip Lid	Decorative	No	97235	6	10
	24.5	FB-6N	Nickel	Flip Lid	Decorative	No	97234	6	10
	24.0	SBFB-1	Brass	Flip Lid	Decorative	No	97528	6	10
	24.0	SBFB-1DB	Dark Bronze	Flip Lid	Decorative	No	97529	6	10
	24.0	SBFB-1N	Nickel	Flip Lid	Decorative	No	97530	6	10

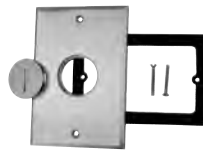

FB-1CVR



FB-2NCVR

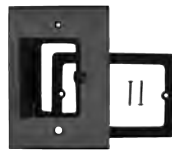

FB-6DBCVR

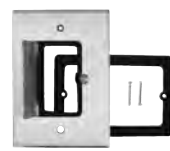

SBFB-1CVR



FB-DBPLG



FB-NPLG

Floor Box Replacement Parts: Single Gang	Catalog Number	Used With Assembly #	Cover Finish	Cover Type	Device	LV Provision	UPC# 85339	Std. Pkg. Qty.	Std. Wt. (lb.)
	FB-1CVR	FB-1	Brass	Screw Plug	Simplex	No	94131	1	1
	FB-1NCVR	FB-1N	Nickel	Screw Plug	Simplex	No	94132	1	1
	FB-2CVR	FB-2	Brass	Screw Plug	Duplex	No	94133	1	1
	FB-2DBCVR	FB-2DB	Dark Bronze	Screw Plug	Duplex	No	99602	1	1
	FB-2NCVR	FB-2N	Nickel	Screw Plug	Duplex	No	94134	1	1
	FB-6CVR	FB-6	Brass	Flip Lid	Decorative	No	97242	1	1
	FB-6DBCVR	FB-6DB	Dark Bronze	Flip Lid	Decorative	No	97244	1	1
	FB-6NCVR	FB-6N	Nickel	Flip Lid	Decorative	No	97243	1	1
	FB-BRPLG	FB-1, FB-2	Brass	Screw Plug	Simplex, Duplex	No	94137	1	1
	FB-DBPLG	FB-2DB	Dark Bronze	Screw Plug	Duplex	No	99605	1	1
	FB-NPLG	FB-1N, FB-2N	Nickel	Screw Plug	Simplex, Duplex	No	94138	1	1
	SBFB-1CVR	SBFB-1	Brass	Flip Lid	Decorative	No	97617	1	1
	SBFB-1DBCVR	SBFB-1DB	Dark Bronze	Flip Lid	Decorative	No	97619	1	1
	SBFB-1NCVR	SBFB-1N	Nickel	Flip Lid	Decorative	No	97618	1	1

All dimensions are in inches unless otherwise noted.

Designed in USA • Made in China

Floor Box 714L
UL File No. E30594

Floor Box Assemblies

Single Gang, Rectangular Profile



ALLIED
MOULDED
PRODUCTS, Inc.

Single Gang Floor Box Specifications

FB-1, FB-2, FB-6, & SBFB-1



FB-1



FB-2



FB-6



SBFB-1

- Cut-in hole size: 2.625" x 4.437"
- Box size (no flange): 3.5" (D) x 2.498" (W) x 4.312" (H) (SBFB H=4.4")
- Flange outside dimension: 3.250" x 4.883" (SBFB—no flange)
- Cover dimension (FB-1/FB-2): 0.217" (D) x 3.5" (W) x 5.125" (H)
- Cover dimension (SBFB-1/FB-6): 0.222" (D) x 4" (W) x 5.625" (H)
- Box wire capacity: 24.5 cu. in. (SBFB 24.0 cu. in.)
- (2) ½" knockouts on bottom and (2) ½" knockouts on the side wall
- (2) molded-in Speed Klamps™ for securing NM cable
- Part material types:
 - Cover: brushed brass, nickel, or dark bronze
 - Screw plug/Flip Lid: matches cover with nitrile O-ring or gasket
 - Gasket: closed-cell rubber
 - Box screws and wings: galvanized steel
 - Dust plate: galvanized steel
 - Device: UL® listed residential grade w/ copper terminals & brass ground
- Receptacle rating: 15 amp, 125V tamper resistant with ground (Article 406 of the NEC; requirements for Tamper Resistant receptacles in dwellings)
- Assembly meets UL 514C scrub-water exclusion test requirement



The FB-6 comes standard with one decorative device and a flip lid

WARNING: This product can expose you to chemicals including lead, which is known to the State of California to cause cancer and birth defects or other reproductive harm. For more information go to www.P65Warnings.ca.gov.

All dimensions are in inches unless otherwise noted.

Designed in USA • Made in China

 Floor Box
714L
UL File No. E30594

Floor Box Assemblies

Two Gang, Rectangular Profile



ALLIED
MOULDED
PRODUCTS, Inc.



FB-5



FB-5DB



FB-5N

Floor Box Assemblies: Two Gang	Cu. In. Volume	Catalog Number	Cover Finish	Cover Type	Device	LV Provision	UPC# 85339	Std. Pkg. Qty.	Std. Wt. (lb.)
	44.5	FB-5	Brass	Flip Lid	(1) Decorative; (1) Open for 4 LV keystone plate or a second device	Yes	99075	6	14
	44.5	FB-5DB	Dark Bronze	Flip Lid	(1) Decorative; (1) Open for 4 LV keystone plate or a second device	Yes	99076	6	14
	44.5	FB-5N	Nickel	Flip Lid	(1) Decorative; (1) Open for 4 LV keystone plate or a second device	Yes	99077	6	14



FB-5CVR



FB-5DBCVR



FB-5NCVR

Floor Box Replacement Parts: Two Gang	Catalog Number	Used With Assembly #	Cover Finish	Cover Type	Device	LV Provision	UPC# 85339	Std. Pkg. Qty.	Std. Wt. (lb.)
	FB-5CVR	FB-5	Brass	Flip Lid	Decorative	Yes	99081	1	1
	FB-5DBCVR	FB-5DB	Dark Bronze	Flip Lid	Decorative	Yes	99082	1	1
	FB-5NCVR	FB-5N	Nickel	Flip Lid	Decorative	Yes	99083	1	1

All dimensions are in inches unless otherwise noted.

Designed in USA • Made in China



Floor Box
714L

UL File No. E30594

Floor Box Assemblies

Two Gang, Rectangular Profile

Two Gang Floor Box Specifications

FB-5



FB-5

- Cut-in hole size: 4.625" x 4.437"
- Box size (no flange): 4.056" (D) x 4.498" (W) x 4.335" (H)
- Flange outside dimension: 5.508" x 5.133"
- Cover dimension: 0.222" (D) x 6.000" (W) x 5.625" (H)
- (4) Dust plate keystone openings (FB-5): 0.575" x 0.765"
- Box wire capacity: 44.5 cu. in.
- (2) ½" knockouts on bottom
- (4) molded-in Speed Klamps™ for securing NM cable
- Part material types:
 - Cover: brushed brass, nickel-plated brass or dark bronze
 - Flip Lids: matches cover
 - Gaskets: closed-cell rubber
 - Box screws and wings: galvanized steel
 - Dust plates: galvanized steel
 - Device: UL listed residential grade w/ copper terminals & brass ground
- Receptacle rating: 15 amp, 125V tamper resistant with ground
(Article 406 of the NEC; requirements for Tamper Resistant receptacles in dwellings)
- Assembly meets UL 514C scrub-water exclusion test requirement



The FB-5 comes standard with one decorative device and two plates for installing an additional device or up to 4 LV keystone plugins (shown installed, but not included in package), plus the required low voltage box divider plate.

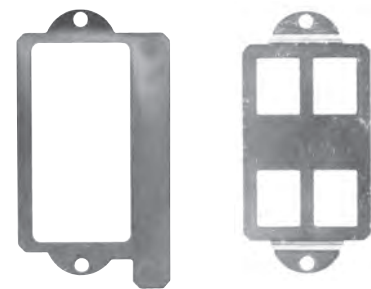

WARNING: This product can expose you to chemicals including lead, which is known to the State of California to cause cancer and birth defects or other reproductive harm. For more information go to www.P65Warnings.ca.gov.

All dimensions are in inches unless otherwise noted.

Designed in USA • Made in China

 Floor Box
714L
UL File No. E30594

Floor Box Assemblies

Round Profile



ALLIED MOULDED PRODUCTS, Inc.



FB-3



FB-3DB



FB-4



FB-4DB



FB-7



FB-8N

Floor Box Assemblies: Round

Cu. In. Volume	Catalog Number	Cover Finish	Cover Type	Device	LV Provision	UPC# 85339	Std. Pkg. Qty.	Std. Wt. (lb.)
24.5	FB-3	Brass	Screw Plug	Duplex	No	94125	6	10
24.5	FB-3DB	Dark Bronze	Screw Plug	Duplex	No	99603	6	10
24.5	FB-3N	Nickel	Screw Plug	Duplex	No	94130	6	10
19.5	FB-4	Brass	Screw Plug	Duplex & 2 keystone openings	Yes	99072	6	12
19.5	FB-4DB	Dark Bronze	Screw Plug	Duplex & 2 keystone openings	Yes	99073	6	12
19.5	FB-4N	Nickel	Screw Plug	Duplex & 2 keystone openings	Yes	99074	6	12
24.5	FB-7	Brass	Flip Lid	Duplex	No	97236	6	11
24.5	FB-7DB	Dark Bronze	Flip Lid	Duplex	No	97238	6	11
24.5	FB-7N	Nickel	Flip Lid	Duplex	No	97237	6	11
19.5	FB-8	Brass	Flip Lid	Duplex & 2 keystone openings	Yes	97239	6	11
19.5	FB-8DB	Dark Bronze	Flip Lid	Duplex & 2 keystone openings	Yes	97241	6	11
19.5	FB-8N	Nickel	Flip Lid	Duplex & 2 keystone openings	Yes	97240	6	11



FB-3CVR



FB-4CVR



FB-7NCVR



FB-8NCVR



FB-BRPLGLV



FB-NPLG

Floor Box Replacement Parts: Round

Catalog Number	Used With Assembly #	Cover Finish	Cover Type	Device	LV Provision	UPC# 85339	Std. Pkg. Qty.	Std. Wt. (lb.)
FB-3CVR	FB-3, FB-7	Brass	Screw Plug	Duplex	No	94135	1	1
FB-3DBCVR	FB-3DB, FB-7DB	Dark Bronze	Screw Plug	Duplex	No	99604	1	1
FB-3NCVR	FB-3N, FB-7N	Nickel	Screw Plug	Duplex	No	94136	1	1
FB-4CVR	FB-4, FB-8	Brass	Screw Plug	Duplex/2 keystone openings	Yes	99078	1	1
FB-4DBCVR	FB-4DB, FB-8DB	Dark Bronze	Screw Plug	Duplex/2 keystone openings	Yes	99079	1	1
FB-4NCVR	FB-4N, FB-8N	Nickel	Screw Plug	Duplex/2 keystone openings	Yes	99080	1	1
FB-7CVR	FB-7, FB-3	Brass	Flip Lid	Duplex	No	97245	1	1
FB-7DBCVR	FB-7DB, FB-3DB	Dark Bronze	Flip Lid	Duplex	No	97247	1	1
FB-7NCVR	FB-7N, FB-3N	Nickel	Flip Lid	Duplex	No	97246	1	1
FB-8CVR	FB-8, FB-4	Brass	Flip Lid	Duplex/2 keystone openings	Yes	97248	1	1
FB-8DBCVR	FB-8DB, FB-4DB	Dark Bronze	Flip Lid	Duplex/2 keystone openings	Yes	97250	1	1
FB-8NCVR	FB-8N, FB-4N	Nickel	Flip Lid	Duplex/2 keystone openings	Yes	97249	1	1
FB-BRPLG	FB-3, FB-4	Brass	Screw Plug	Duplex/2 keystone openings	FB-4	94137	1	1
FB-DBPLG	FB-3DB, FB-4DB	Dark Bronze	Screw Plug	Duplex/2 keystone openings	FB-4DB	99605	1	1
FB-NPLG	FB-3N, FB-4N	Nickel	Screw Plug	Duplex/2 keystone openings	FB-4N	94138	1	1
FB-BRPLGLV	FB-4, FB-8	Brass	Flip Lids	Duplex/2 keystone openings	Yes	99084	1	1
FB-DBPLGLV	FB-4DB, FB-8DB	Dark Bronze	Flip Lids	Duplex/2 keystone openings	Yes	99085	1	1
FB-NPLGLV	FB-4N, FB-8N	Nickel	Flip Lids	Duplex/2 keystone openings	Yes	99086	1	1

All dimensions are in inches unless otherwise noted.

Designed in USA • Made in China



Floor Box 714L

UL File No. E30594

Round Floor Box Specifications

FB-3, FB-4, FB-7, & FB-8



FB-3



FB-4



FB-7



FB-8

- Cut-in hole size: 4.0" Dia. (standard hole saw size)
- FB-3/FB-7 box size (no flange): 3.0" (Deep) x 3.936" dia.
- FB-4/FB-8 box size (no flange): 3.433" (Deep) x 3.936" dia.
- Flange outside dimension: FB-3/FB-7 (5.0" dia.), FB-4/FB-8 (5.25" dia.)
- Cover dimension (FB-3/): 5.25" dia. x 0.217" thickness
- Cover dimension (FB-4/FB-7/FB-8): 5.75" dia. x 0.237" thickness
- (2) Dust plate keystone openings (FB-4/FB-8): 0.575" x 0.765"
- Box wire capacity: FB-3/FB-7 (24.5 cu. in.), FB-4/FB-8 (19.5 cu. in.)
- FB-3/FB-7: (2) ½" knockouts on bottom
- FB-4/FB-8: (1) ½" knockout on bottom
- (4) molded-in Speed Klamps™ for securing NM cable
- Part material types:
 - Cover: brushed brass, nickel-plated brass or dark bronze
 - Screw plugs: matches cover with nitrile O-ring
 - Low Voltage Plates: (FB-4/FB-8) with closed-cell gaskets
 - Gasket: closed-cell rubber
 - Box screws and wings: galvanized steel
 - Dust plate: galvanized steel
 - Device: nonmetallic with copper terminals and brass ground
- Receptacle rating: 15 amp, 125V tamper resistant with ground
(Article 406 of the NEC; requirements for Tamper Resistant receptacles in dwellings)
- Assembly meets UL 514C scrub-water exclusion test requirement

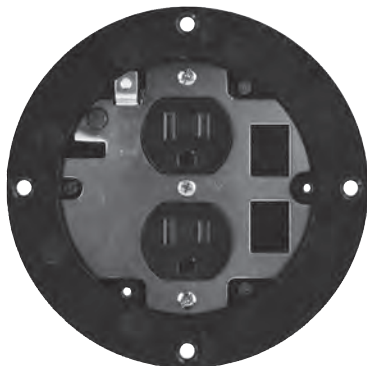

The FB-8 comes standard with a duplex device and provision for adding 2 standard LV keystone plugs and a flip lid

WARNING: This product can expose you to chemicals including lead, which is known to the State of California to cause cancer and birth defects or other reproductive harm. For more information go to www.P65Warnings.ca.gov.

All dimensions are in inches unless otherwise noted.

Designed in USA • Made in China

 Floor Box
714L
UL File No. E30594



FB-CAK

Accessory

Catalog Number	Component Description	UPC#	Std. Pkg. Qty.	Std. Wt. (lb.)
FB-CAK	Concrete adapter kit; contains adapter sealing gasket, adapter ring, and detailed installation instructions	85339	6	3

NOTE: For use in adapting round profile residential floor box assemblies (Series FB-3, FB-4, FB-7, & FB-8) to standard industry concrete junction boxes.

Concrete Adapter Kit

- Installed floor box assembly meets UL 514C scrub water exclusion test
- Quick and easy installation with fewer floor box and device components
- Floor box comes with a standard TR tamper resistant receptacle; 15amp, 125 volt with ground (NEMA config. 5-15R)
- Allied Moulded floor box assemblies can be adapted to many standard PVC concrete junction boxes

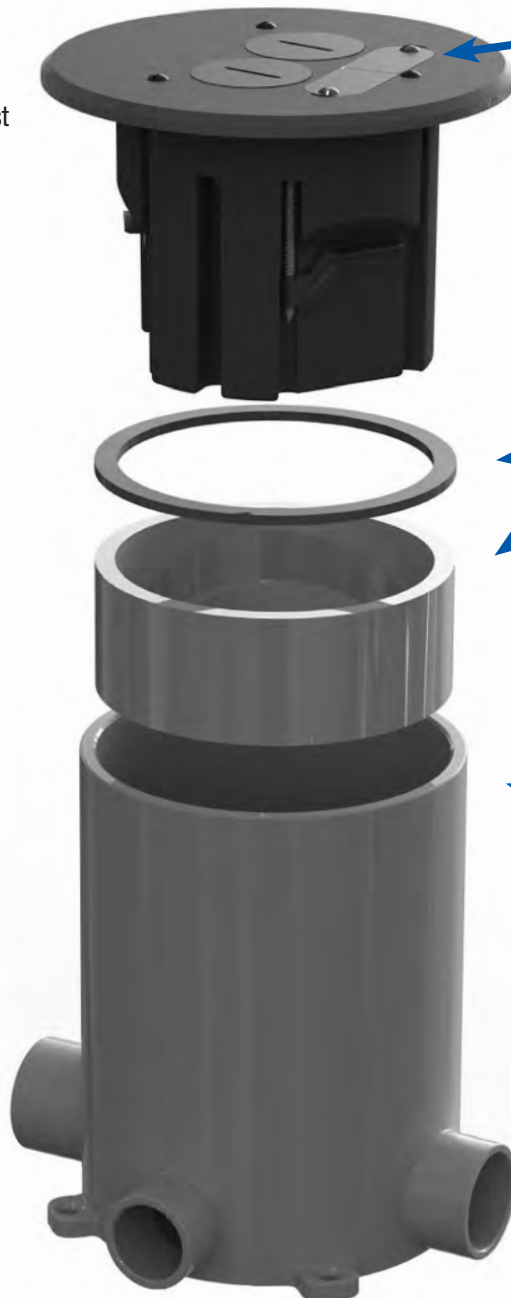

Fits Round Profile Floor Box Assemblies:

- FB-3, FB-4, FB-7, & FB-8 (Brass)
- FB-3DB, FB-4DB, FB-7DB, & FB-8DB (Dark Bronze)
- FB-3N, FB-4N, FB-7N, & FB-8N (Nickel)

FB-CAK Concrete Adapter Kit

Includes:

- Adapter sealing gasket
- Adapter ring
- Detailed installation instructions



UL® recognized for use with round PVC concrete junction boxes with an inside diameter of 4-½" to 4-9/16".

These include, but are not limited to the following:

- Arlington FLBC4500
- Cantex, 5133758/5133760
- Carlon, E971FB
- Ipex/Sceptor, FB 076954
- Kraloy, FB 078876
- Lew, FB/FBLEW

All dimensions are in inci.

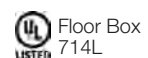

UL File No. E30594

Competitive Cross Reference

Fiberglass Outlet Boxes



ALLIED
MOULDED
PRODUCTS, Inc.

fiberglassBOX™: Premium Series “Hard Box” Fiberglass Boxes

Allied Moulded	Carlton® PH (Union Phenolic)	Carlton® PC Black Polycarbonate	Carlton® PVC (Zip Blue)	Carlton® PVC (SuperBlue®)	Cantex® (EZ BOX®)	Pass & Seymour (Slater®)
1096-N	1040/2000/1240	118-N	B118A	N/A	EZ18SN	P118R
1096-NR	N/A	N/A	N1-710-M	N/A	N/A	P118RN
1096-SS	N/A	N/A	N/A	N/A	EZ18SNZ	S118RS
1096-Z2	N/A	118-LB	N/A	N/A	N/A	S118S25
1096-Z4	2000-738	118-LB	B118B	N/A	N/A	S118S50
1098-N	1250/1050	120-N	B120A	N/A	EZ20SN/EZ20SB	N/A
1098-NR	N/A	N/A	N/A	N/A	N/A	N/A
1098-SS	1250-S	N/A	N/A	N/A	EZ20SNZ	N/A
1098-Z2	N/A	N/A	N/A	N/A	N/A	N/A
1098-Z4	1250-112	N/A	N/A	N/A	N/A	N/A
1098-Z4H	N/A	N/A	N/A	N/A	N/A	PH1-22-B
1099-N	1260	122-N	RN-23	BH122A	EZ23SN	P122R
1099-NR	N/A	N/A	N/A	N/A	N/A	P122RN
1099-NRED	N/A	N/A	N/A	N/A	EZ20SNAR	N/A
1099-SS	1260-S	N/A	RS-23	BH122S	EZ23SNZ	S122RS
1099-Z4	N/A	N/A	N/A	N/A	EZ20SB	S122S50/P122C
2300-Z22	N/A	234-LB	SB2-236-FS	N/A	N/A	S235S50AC
2300-Z22K	N/A	234-LB	SB2-236-FS	N/A	N/A	S235S50AC
2300-N	1052	234-N	B232A/SN234/SN236	BH235A	EZ32DN	S235RAC
2300-NK	1052	234-N	B232A/SN234	BH235A	EZ32DN	S235RAC
2300-SS	1052CS	N/A	N/A	BH235S	EZ32DNZ	N/A
2300-SSK	1052CS	N/A	N/A	BH235S	EZ32DNZ	N/A
2300-Z2	2002-738	N/A	B232B	N/A	N/A	N/A
2300-Z2K	2002-738	N/A	B232B	N/A	N/A	N/A
2300-Z4	N/A	N/A	N/A	N/A	N/A	N/A
2300-Z4K	N/A	N/A	N/A	N/A	N/A	N/A
2302-N	1072-C	N/A	SN236/SN241	BH235A	EZ48DN	N/A
2302-NK	1072-C	N/A	SN236/SN241	BH235A	EZ48DN	N/A
2302-NKRED	N/A	N/A	N/A	N/A	N/A	N/A
2302-SS	N/A	N/A	SS241	BH235S	EZ48DNZ	5235RACS
2302-SSK	N/A	N/A	SS241	BH235S	EZ48DNZ	5235RACS
2302-Z4	N/A	N/A	N/A	N/A	N/A	N/A
2302-Z4K	N/A	N/A	N/A	N/A	N/A	N/A
3300-Z22	N/A	345-LB	SB2-357-FS	N/A	N/A	S354S50AC
3300-Z22K	N/A	345-LB	SB2-357-FS	N/A	N/A	S354S50AC
3300-Z24	N/A	N/A	N/A	N/A	N/A	N/A
3300-Z24K	N/A	N/A	N/A	N/A	N/A	N/A
3300-N	1043-C	345-N	B344A/SN357	BH353A	EZ44TN	N/A
3300-NB	N/A	N/A	N/A	N/A	N/A	N/A
3300-NBK	N/A	N/A	N/A	N/A	N/A	N/A
3300-NK	1043-C	345-N	B344A/SN357	BH353A	EZ44TN	N/A
3300-SS	N/A	N/A	SS357	BH353S	EZ44TNZ	N/A
3300-SSB	N/A	N/A	N/A	N/A	N/A	N/A
3300-SSBK	N/A	N/A	N/A	N/A	N/A	N/A
3300-SSK	N/A	N/A	SS357	BH353S	EZ44TNZ	N/A
3300-Z2	N/A	N/A	SB357	N/A	N/A	N/A
3300-Z2B	N/A	N/A	N/A	N/A	N/A	N/A
3300-Z2BK	N/A	N/A	N/A	N/A	N/A	N/A
3300-Z2K	N/A	N/A	SB357	N/A	N/A	N/A
3300-Z4	N/A	N/A	N/A	N/A	N/A	N/A

Competitive Cross Reference

Fiberglass Outlet Boxes



ALLIED
MOULDED
PRODUCTS, Inc.

fiberglassBOX™: Premium Series “Hard Box” Fiberglass Boxes continued

Allied Moulded	Carlton® PH (Union Phenolic)	Carlton® PC Black Polycarbonate	Carlton® PVC (Zip Blue)	Carlton® PVC (SuperBlue®)	Cantex® (EZ BOX®)	Pass & Seymour (Slater®)
3300-Z4K	N/A	N/A	N/A	N/A	N/A	N/A
3303-2Z4	N/A	N/A	N/A	N/A	N/A	N/A
3303-2Z4K	N/A	N/A	N/A	N/A	N/A	N/A
3303-N	1063/C	N/A	N/A	BH353A	N/A	S354RAC
3303-NB	N/A	N/A	N/A	N/A	N/A	N/A
3303-NBK	N/A	N/A	N/A	N/A	N/A	N/A
3303-NK	1063/C	N/A	N/A	BH353A	EZ74TN	S354RAC
3303-SS	1063-CS	N/A	N/A	BH353S	N/A	S354RACS
3303-SSK	1063-CS	N/A	N/A	BH353S	EZ74TNZ	S354RACS
3303-Z4	N/A	N/A	SB357	N/A	N/A	S354S50AC
3303-Z4K	N/A	N/A	SB357	N/A	N/A	S354S50AC
4300-2Z2	2004-238/2004-238-02	460-LB	N/A	N/A	N/A	S468S50AC
4300-2Z2K	2004-238/2004-238-02	460-LB	N/A	N/A	N/A	N/A
4300-N	2004	N/A	B455A	BH464A	EZ55QNB	S468RAC
4300-NB	7074BH/2004BH	460-SB	B455AH	N/A	EZ55QNB	N/A
4300-NBK	7074BH/2004BH	460-SB	B455AH	N/A	EZ55QNB	N/A
4300-NK	2004	N/A	B455A	BH464A	EZ55QNB	S468RAC
4300-SS	N/A	N/A	N/A	BH464S	EZ55QNBZ	S468RACS
4300-SSB	N/A	N/A	N/A	N/A	EZ55QNBZ	N/A
4300-SSBK	N/A	N/A	N/A	N/A	EZ55QNBZ	N/A
4300-SSK	N/A	N/A	N/A	BH464S	EZ55QNBZ	S468RACS
4300-Z2	N/A	N/A	N/A	N/A	N/A	N/A
4300-Z2B	N/A	N/A	N/A	N/A	N/A	N/A
4300-Z2BK	N/A	N/A	N/A	N/A	N/A	N/A
4300-Z2K	N/A	N/A	N/A	N/A	N/A	N/A
4300-Z4	N/A	N/A	N/A	N/A	N/A	N/A
4300-Z4K	N/A	N/A	N/A	N/A	N/A	N/A
4304-2Z4	N/A	N/A	N/A	N/A	N/A	N/A
4304-2Z4K	N/A	N/A	N/A	N/A	N/A	N/A
4304-N	N/A	N/A	N/A	BH464A	N/A	N/A
4304-NB	N/A	N/A	N/A	N/A	N/A	N/A
4304-NBK	N/A	N/A	N/A	N/A	N/A	N/A
4304-NK	N/A	N/A	N/A	BH464A	N/A	N/A
4304-Z4B	N/A	N/A	N/A	N/A	N/A	N/A
4304-Z4BK	N/A	N/A	N/A	N/A	N/A	N/A
5305-NBK	N/A	N/A	N/A	N/A	N/A	N/A
5305-NK	N/A	N/A	N/A	N/A	N/A	N/A
5305-Z4BK	N/A	N/A	N/A	N/A	N/A	N/A
9301-E	7060	108E	B108R	N/A	EZ08SF	N/A
9303-H	9050-702	N/A	B108B	N/A	EZ08SB	N/A
9304	3060	N/A	N/A	N/A	N/A	N/A
9304-G	N/A	N/A	N/A	N/A	N/A	N/A
9305	3030	N/A	N/A	N/A	N/A	N/A
9305-G	N/A	N/A	N/A	N/A	N/A	N/A
9305-GK	3030-02-40	N/A	N/A	N/A	N/A	N/A
9305-K	3030PC	N/A	N/A	N/A	N/A	N/A
9305-S	3030-902/3080-9	N/A	N/A	BH614R	N/A	N/A
9305-SG	3020-9-40/3020-902-40	N/A	N/A	BH614P	N/A	N/A
9305-SGK	3020-9-40/3020-902-40	N/A	N/A	BH614P	N/A	N/A
9305-SK	3030-902/3080-9	N/A	N/A	BH614R	N/A	N/A

Competitive Cross Reference

Fiberglass Outlet Boxes



ALLIED
MOULDED
PRODUCTS, Inc.

fiberglassBOX™: Premium Series “Hard Box” Fiberglass Boxes continued

Allied Moulded	Carlton® PH (Union Phenolic)	Carlton® PC Black Polycarbonate	Carlton® PVC (Zip Blue)	Carlton® PVC (SuperBlue®)	Cantex® (EZ BOX®)	Pass & Seymour (Slater®)
9312-E	N/A	N/A	N/A	N/A	N/A	N/A
9312-EK	N/A	N/A	N/A	N/A	N/A	N/A
9312-EW	6062-402	4R-B	B225R	N/A	EZ25D0	N/A
9312-EWK	6062-402	4R-B	B225R	N/A	EZ25D0	N/A
9313-EW	6063-402	N/A	B355R	N/A	N/A	S3-52-W
9313-EWK	6063-402	N/A	B355R	N/A	N/A	S3-52-W
9314-EWK	N/A	N/A	B468R	N/A	N/A	N/A
9315	4062/WHITE	4R-B	E460R	N/A	EZYKL	N/A
9315-WH	4062/WHITE	4R-B	E460R	N/A	EZYKL	N/A
9318	N/A	N/A	B112HB	N/A	N/A	N/A
9319	N/A	N/A	HB15W	N/A	N/A	N/A
9320	N/A	N/A	HB1DP	N/A	N/A	N/A
9322	N/A	N/A	HB1BL	N/A	N/A	N/A
9324-N	2070/N1614	N/A	N1614	N/A	N/A	N/A
9327-N	6090/7010/E1614	N/A	N/A	N/A	N/A	N/A
9329-EW	7010-8	232-OW	B225R	BH234R	N/A	S2-32-W
9329-EWK	7010-8	232-OW	B225R	BH234R	N/A	S2-32-W
9331-E	6090/7010	N/A	E1614	N/A	N/A	N/A
9331-EK	6090/7010	N/A	E1614	N/A	N/A	N/A
9331-ES	7010-8	N/A	N/A	N/A	N/A	N/A
9331-ESK	7010-8	N/A	N/A	N/A	N/A	N/A
9331-EW	6090-402	114-OW	B114R	N/A	EZ14S0	N/A
9331-EWK	6090-402	114-OW	B114R	N/A	EZ14S0	N/A
9335-16/16K	3190-C-94	N-321-C-94	N/A	N/A	N/A	N/A
9335-16G/16GK	N/A	N-321-GC-94	N/A	N/A	N/A	N/A
9335-BH/BHK	3190-C-94	N-321-C-95	N/A	N/A	N/A	S118HAC
9335-BHG/BHGK	N/A	N-321-GC-95	N/A	N/A	N/A	S118HGAC
9335-HNGK	N/A	N/A	N/A	N/A	N/A	N/A
9335-HNK	N/A	N/A	N/A	N/A	N/A	N/A
9335-N	3190/3190C	N/A	B518A/N-321-C	N/A	EZ18CN	C118RAC
9335-NG	3190-40-PC	N/A	B518P	N/A	EZ18CNG	C118RGAC
9335-NGK	3190-40-PC	N/A	B518P	N/A	EZ18CNG	C118RGAC
9335-NK	3190/3190C	N/A	B518A/N-321-C	N/A	EZ18CN	C118RAC
9335-NKRED	N/A	3R-16-N-RED	N/A	N/A	EZ18CNAR	N/A
9336-16/16K	3090-94/3090-94-SQ	N/A	N/A	N/A	N/A	N/A
9336-16G/16GK	3090-94-40	N/A	N/A	N/A	N/A	N/A
9336-BH/BHK	3090-95/3090-95-SQ	3R-16-BH	N/A	N/A	N/A	N/A
9336-BHG/BHGK	3090-95-40	3R-16-BHGP	N/A	N/A	N/A	N/A
9336-HNGK	3090-N-40	N/A	N/A	N/A	N/A	N/A
9336-HNK	3090-N	N/A	N/A	N/A	N/A	N/A
9336-N	3190	3R16N	N/A	N/A	N/A	N/A
9336-NG	3190-PC	3R16NGP	N/A	N/A	N/A	N/A
9336-NGK	3190-PC	3R16NGP	N/A	N/A	N/A	N/A
9336-NK	3190	3R16N	N/A	N/A	N/A	N/A
9338-E	3080	N/A	N/A	N/A	N/A	N/A
9338-EK	3080	N/A	N/A	N/A	N/A	N/A
9338-EKT	3080	N/A	N/A	N/A	N/A	N/A
9338-ES	3080-9/3080-9-PC	3R160W	N/A	BH614R	N/A	N/A
9338-ESG	3080-9-40	3R160WGP	B432A	BH614RP	N/A	N/A
9338-ESGK	3080-9-40	3R160WGP	B432A	BH614RP	N/A	C118WGAC

Competitive Cross Reference

Fiberglass Outlet Boxes



ALLIED
MOULDED
PRODUCTS, Inc.

fiberglassBOX™: Premium Series “Hard Box” Fiberglass Boxes continued

Allied Moulded	Carlton® PH (Union Phenolic)	Carlton® PC Black Polycarbonate	Carlton® PVC (Zip Blue)	Carlton® PVC (SuperBlue®)	Cantex® (EZ BOX®)	Pass & Seymour (Slater®)
9338-ESGKT	3080-9-40	N/A	N/A	N/A	N/A	C118WGAC
9338-ESK	3080-9/3080-9-PC	3R160W	N/A	BH614R	N/A	N/A
9338-ESKT	3080-9-PC	N/A	N/A	N/A	N/A	N/A
9338-EST	3080-9-PC	N/A	N/A	N/A	N/A	N/A
9339-Z+1	4020-1-02	N/A	4S-812C	N/A	EZ18XN	N/A
9342-HF	N/A	N/A	N/A	N/A	N/A	N/A
9342-HN	N/A	N/A	N/A	N/A	N/A	N/A
9343-N	4000-02	4S32N	B432A	N/A	EZ32XN	S4435RAC
9343-NK	4000-02	4S32N	B432A	N/A	EZ32XN	S4435RAC
9343-SS	4000-02	N/A	N/A	N/A	N/A	N/A
9343-SSK	4000-02	N/A	N/A	N/A	N/A	N/A
9344	4041	4SB	A400/4SPB	N/A	EZXXL	N/A
9345	4042-12	4S1G	A410	N/A	EZ03SXA	RC1
9345-58	N/A	N/A	A411	N/A	EZ04ES	N/A
9346	4022-12	4S2G	A420	N/A	EZ06DXA	RC2
9346-58	N/A	N/A	A421	N/A	EZ08ED	N/A
9347	4043-12	N/A	N/A	N/A	N/A	N/A
9348	4061	N/A	A471	N/A	EZ03YC	N/A
9350-16/16K	4070-94/4070-9402	N-423-C-94-V	N/A	BH525H	N/A	N/A
9350-16G/16GK	N/A	N-423-GC-94-V	N/A	BH525HP	N/A	N/A
9350-BH/BHK	4070-95/4070-9502/4070-95-PC	N-423-C-95-V	N/A	N/A	EZ20CH	S120HAC
9350-BHG/BHGK	4070-95-40	N-423-GC-95-V	N/A	N/A	EZ20CHG	S120HGAC
9350-HFK	N/A	N/A	N/A	N/A	N/A	S120JAC
9350-HL	4070-302	N/A	B620L	N/A	N/A	S120JAC
9350-HLGK	N/A	N/A	N/A	N/A	N/A	S120JGAC
9350-HLK	4070-302	N/A	B620L	N/A	N/A	S120JAC
9350-HN	4070-NO2	N/A	N/A	N/A	N/A	S120JAC
9350-HNK	4070-NO2	N/A	N/A	N/A	N/A	S120JAC
9350-K	N/A	N/A	N/A	N/A	N/A	N/A
9350	N/A	N/A	N/A	N/A	N/A	N/A
9351-N	4170/4170PC	4R20N	B520A/N-423-C	BH525A	EZ20CN	S120RAC
9351-NG	4070-N-40	4R20NGP	B520P/N-423-GC	BH525P	EZ20CNG	S120RGAC
9351-NGK	4070-N-40	4R20NGP	B520P/N-423-GC	BH525P	EZ20CNG	S120RGAC
9351-NK	4170/4170PC	4R20N	B520A/N-423-C	BH525A	EZ20CN	S120RAC
9351-NKRED	N/A	N/A	N/A	N/A	EZ20CNAR	N/A
9351-SS	4070-N-S	N/A	N/A	N/A	N/A	N/A
9351-SSK	4070-N-S	N/A	B618R	BH525S	N/A	N/A
9355-G	3000-02-40	N/A	N/A	N/A	N/A	C118WGAC
9355-GK	3000-02-40	N/A	N/A	N/A	N/A	C118WGAC
9355-K	3000	N/A	N/A	N/A	N/A	C118WAC
9355-S	3000-902-40	N/A	B618R	N/A	EZ18C0	C118WAC
9355-SGK	3000-902-40	N/A	B618R	N/A	EZ19C0G	C118WAC
9355-SK	3000-902-40	N/A	B618R	N/A	EZ18C0	C118WAC
9355	3000	N/A	N/A	N/A	N/A	C118WAC
9361-E	N/A	N/A	N/A	N/A	N/A	N/A
9361-EK	N/A	N/A	N/A	N/A	N/A	N/A
9361-ES	N/A	N/A	N/A	N/A	N/A	N/A

Competitive Cross Reference

Fiberglass Outlet Boxes



ALLIED
MOULDED
PRODUCTS, Inc.

fiberglassBOX™: Premium Series “Hard Box” Fiberglass Boxes continued

Allied Moulded	Carlton® PH (Union Phenolic)	Carlton® PC Black Polycarbonate	Carlton® PVC (Zip Blue)	Carlton® PVC (SuperBlue®)	Cantex® (EZ BOX®)	Pass & Seymour (Slater®)
9361-ESK	E168/7010-8/7020-8	N/A	N/A	N/A	N/A	N/A
9363-E	6060-02	N/A	N/A	N/A	N/A	N/A
9363-EK	6060-02	N/A	N/A	N/A	N/A	N/A
9363-EW	6010-402/6060-402	114-OW	N/A	N/A	N/A	N/A
9363-EWK	6010-402/6060-402	114-OW	N/A	N/A	N/A	N/A
9364	4060-02	N/A	N/A	N/A	N/A	N/A
9364-16/16K	4060-9402	N/A	N/A	N/A	N/A	N/A
9364-16G/16GK	N/A	N/A	N/A	N/A	N/A	N/A
9364-BH/BHK	4060-9502	N/A	N/A	N/A	N/A	N/A
9364-BHG/BHGK	N/A	N/A	N/A	N/A	N/A	N/A
9364-K	4060-02	N/A	N/A	N/A	N/A	N/A
9365-N	4160-C	N/A	N/A	N/A	N/A	N/A
9365-NK	4160-C/N40712RC	N/A	N/A	N/A	N/A	N/A
9366-EK	N/A	N/A	N/A	N/A	N/A	N/A
9366-EW	N/A	N/A	N/A	BH118R	N/A	N/A
9366-EWK	N/A	N/A	N/A	BH118R	N/A	N/A
9367-E	6000-402/E01-712	N/A	B117RSW	B117RSW	N/A	N/A
9367-EW	6000-402	N/A	B117RSW	B117RSW	N/A	N/A
9368-E	N/A	N/A	N/A	N/A	N/A	N/A
9368-EK	N/A	N/A	N/A	N/A	N/A	N/A
9368-EW	6070-4/E214	N/A	B120R	BH118R	EZ21S0	S118W
9368-EWK	6070-4/E214	N/A	B120R	BH118R	EZ21S0	S118W
9372-NMHK	N/A	N/A	N/A	N/A	N/A	N/A
RD-42	RD-30	N/A	B234ADJC/RDS-30	N/A	N/A	P242RRD
RD-42SS	N/A	N/A	N/A	N/A	N/A	P242SRD

fiberglassBOX™: Paddle Fan Support Boxes

Allied Moulded	Westinghouse	Arlington	Raco	Carlton PC	Steel City (T&B)	Carlton PH	Reiker (P&S)	Slater (P&S)
9335-NFR/NKFR	N/A	FB417S/FBS420S	N/A	N/A	N/A	N/A	N/A	N/A
9336-NKFR	01040-11	FBS415S	N/A	N/A	N/A	N/A	N/A	N/A
9350-FAN/FANB	N/A	N/A	927/928	N/A	N/A	4070-CFB-BHL	65521/85502	N/A
9350-FRBKOW	N/A	FBRS420R	934	N/A	N/A	N/A	22200	N/A
9350-KFR	N/A	FB423/FBS420	7120/299	B720-SHK	54171-CFB	CFB-16	44400/55528	S1-6-FAN
9351-NFR/NKFR	01240-11	FB417S	294-1	BH525L/BH525LP	54171-F-CFB	4170-CFB	55020/55025	S1-20-RFAN
9364-FAN/FANB	01525/ 01100/ 01010	N/A	925/926	MB715H	N/A	N/A	N/A	N/A
9364-FRBKOW	N/A	N/A	935	MB715RH	54151CFB-BHL-OW	N/A	33310/83300	N/A
9364-KFR	01050-11	FBS426	N/A	N/A	N/A	N/A	33303/55505	N/A
9365-NKFR	01250-11	N/A	N/A	BH525L	N/A	N/A	55015/33303	N/A
9369-FB	01020-11	FBS426	296-1	MB715S	54151-CFB	N/A	N/A	N/A
9369-FBH	01250	FBS415S	N/A	N/A	N/A	N/A	N/A	N/A
9369-FRBKB	0152511	FBRS415	926-1	MB715H	54151CFB-BHL	N/A	55501	N/A
9370-FR	01030	FB407	N/A	N/A	N/A	N/A	N/A	S1-09-FAN
9373-FR	02000	FB443	7120	CFB-16	N/A	N/A	N/A	S1-16-FAN
9375-FR	02525	FB442/FB412	7120	CFB-12	N/A	N/A	N/A	N/A

Competitive Cross Reference

Fiberglass Outlet Boxes, Adjustable Boxes



ALLIED
MOULDED
PRODUCTS, Inc.

Vapor Seal fiberglassBOX™: Air-Sealed Fiberglass Boxes

Allied Moulded Vapor Seal	Carlton® PC	AIRFOIL, INC	Arlington Industries, Inc.	Nutek® (Airtight)	Hubbell (TradeSelect)
1099-NV	FN-23	SG-1	F101F / FN101F	F-WSW	2011FBA
1099-NV2	N/A	N/A	FN101FD	N/A	N/A
2302-HNKV2	N/A	N/A	FN102FD	N/A	N/A
2302-NKV	FN-236-V/NG-236-V	SG-2	F102F / FN102F	2-FWSW	2002FBA
3303-NKV	FN-354-V/NG-354-V	N/A	F103F / FN103F	3-FWSW	2003FBA
4304-NKV	FN-460-V/NG-460-V	N/A	F104F / FN104F	N/A	N/A
5305-NKV	N/A	N/A	N/A	N/A	N/A
5305-NBKV	N/A	N/A	N/A	N/A	N/A
9335-BHKV2	N/A	N/A	N/A	N/A	N/A
9335-HNKV2	N/A	N/A	N/A	N/A	N/A
9350-16KV	N/A	N/A	N/A	N/A	N/A
9350-BHKV	N/A	N/A	N/A	N/A	N/A
9350-BHKV2	N/A	N/A	N/A	N/A	N/A
9350-HNKV2	N/A	RD-1	FN440F	F-WOCT	2008FBA
9350-FRBKBV	N/A	N/A	FBR415F	N/A	N/A
9350-FRBKBV2	N/A	N/A	FBR425F	N/A	N/A
9351-NKV	FN-426-C-V	N/A	FN430F	N/A	N/A
9351-NKFRV	FN-CFB	FR-1	FB426F	N/A	N/A
9371-FRV	CFB-16-F	N/A	FB442F	N/A	7120VB
RD-42V	N/A	N/A	N/A	F-WRD	N/A

SLIDERBOX®: Adjustable Boxes

Allied Moulded SLIDERBOX®	Arlington Industries Inc. ONE-BOX™ & IN/OUT™ BOX	Carlton® PVC Adjust-A-Box™	Carlton® Steel Adjust-A-Box™	Smart Box Inc. Smart Box
SB-1	F101 / FA101 / FAS423	B121ADJ	MB120ADJ	MSB22+
SB-1H	F101H	B121ADJH	N/A	MSBHZ
SB-2	F102 / FA102	B234ADJ / B234ADJC	MB238ADJ	MSB2G
SB-3	F103 / FA103	B349ADJ	N/A	MSB3G
SB4	F104 / FA104	N/A	N/A	MSB4G
SB-CB	N/A	N/A	N/A	MSBRND
SB-CBG	N/A	N/A	N/A	N/A
SB-CBFR	FBS1423	N/A	N/A	MSBFAN

Competitive Cross Reference

Thermoplastic Outlet Boxes



**ALLIED
MOULDED
PRODUCTS, Inc.**

flexBOX®: Basic Series “Soft Box” Thermoplastic Boxes

Allied Moulded	Carlton® PC Black Polycarbonate	Carlton® PVC (Zip Blue)	Carlton® PVC (Super Blue) (T&B)	Cantex® (EZ BOX®)	Pass & Seymour (Slater®)
P-108E	N/A	B108R-UPC	N/A	EZ08SF	P108W
P-108H	N/A	B108B-UPC	N/A	EZ08SB	P108N
P-1160W	114-OW	E-16-8	N/A	EZ14SO	P116W
P-1180W	118-OW	B120R	BH118R	N/A	S118W
P-1220W	N/A	B120R	N/A	EZ21SO	S122W
P-122SC	N/A	SNO-18-M	N/A	N/A	N/A
P-181	118-N (18")	B118A (18")	N/A	EZ18SN (18")	P118R
P-181H	118-LB	B118B-UPC	N/A	EZ20SB	S118S50
P-181HZ	N/A	N/A	N/A	N/A	N/A
P-181QT	N/A	N/A	N/A	EZ18SNU	S118R
P-181RK	N/A	N1-710-M	N/A	N/A	P1-18-RN (18")
P-201	120-N (20.3")	B120A (20")	BH122A	EZ20SN (20")	P122R
P-201QT	120-N-FS (20.3)	N/A	N/A	EZ20SNU (20")	S1-18-R (18")
P-201R	N/A	RN-23	N/A	N/A	P122RN
P-2400W	232-OW	B225R	BH234R	EZ25DO	S2-32-W
P-241	122-N (22.5")	B122A (22")	N/A	EZ23SN (23")	P1-22-R (22.5")
P-241H	122-LB (22.5")	N/A	N/A	EZ20SB	P122C
P-241HQT	122-LBP (22.5")	N/A	N/A	N/A	S1-22-S50 (22.5")
P-241QT	122-N-FS (22.5")	N/A	N/A	EZ23SNU (23")	S1-22-R (22.5")
P-3520W	N/A	B355R	N/A	N/A	S3-52-W
P-442	234-N (34")	B232A (32")	BH235A	EZ32DN (32")/EZ48DN	P2-35-RAC (35")
P-442H	234-LB (34")	B232B (32")	N/A	N/A	N/A
P-442HQT	234-LBP (34")	N/A	N/A	N/A	S2-35-S50AC (35")
P-442QT	234-NP (34")	N/A	N/A	EZ32DNU	S2-35-RAC (35")
P-643	345-N (45")	B344A (44")	BH353A	EZ44TN (44")	S3-54-RAC (54")
P-643H	345-LB (45")	SB-357	N/A	EZ74TN	S354S50AC
P-643HQT	N/A	N/A	N/A	N/A	S3-54-S50AC (54")
P-643QT	N/A	N/A	N/A	N/A	S3-54-RAC (54")
P-764	N/A	N/A	BH464A	N/A	S468RAC
P-764B	460-SB-24 (60")	B455A	N/A	EZ55QNB (55")	N/A
P-764BQT	N/A	N/A	N/A	N/A	N/A
P-764H	460-LB (60")	N/A	N/A	N/A	N/A
P-764HB	N/A	B455AH	N/A	N/A	N/A
P-764HBQT	N/A	N/A	N/A	N/A	N/A
P-764HQT	N/A	N/A	N/A	N/A	N/A
P-764QT	N/A	N/A	N/A	N/A	S4-68-RAC (68")
PC213-16	N-321-C-94	N/A	N/A	N/A	N/A
PC213-16G	N-321-GC-94	N/A	N/A	N/A	N/A
PC213-BH	N-321-C-95	N/A	N/A	N/A	C118HAC
PC213-BHG	N-321-GC-95	N/A	N/A	N/A	C118HAGAC
PC213-N	3R-16-N (16")	B518A (18")	N/A	EZ18CN (18")	C1-18-RAC (18")
PC213-NG	3R-16-NGP (16")	B518P (18")	N/A	EZ18CNG (18")	C1-18-RGAC (18")
PC2230W	N/A	B618R	BH614R	EZ18CO	C1-18WAC
PC2230WG	N/A	B618RP	N/A	EZ18COG	C1-18WGAC
PC234-16	N-423-C-94-V	B620H-UPC	N/A	N/A	N/A
PC234-16G	N-423-GC-94-V	B620HG-UPC	N/A	N/A	N/A
PC234-BH	N-423-C-95-V	B620K	BH525H	EZ20CH	S120HAC
PC234-BHG	N-423-GC-95-V	B620KG-UPC	BH525HP	EZ20CHG	S120HGAC
PC234-N	N-423-C-V	B520A (20.5")	BH525A	EZ20CN (20")	S1-20-RAC (20.2")
PC234-NG	N-423-GC-V	B520P (20.5")	BH525P	EZ20CNG (20")	S1-20-RGAC (20.2")

Competitive Cross Reference

Thermoplastic Outlet Boxes



ALLIED
MOULDED
PRODUCTS, Inc.

flexBOX®: Basic Series “Soft Box” Thermoplastic Boxes continued

Allied Moulded	Carlton® PC Black Polycarbonate	Carlton® PVC (Zip Blue)	Carlton® PVC (Super Blue) (T&B)	Cantex® (EZ BOX®)	Pass & Seymour (Slater®)
PJ-20H	N/A	B418A	N/A	EZ18XN	S44-21-SAC
PJ-20N	N/A	B418A	N/A	EZ18XN	S44-21-RAC
PJ-32H	N/A	B432A	N/A	EZ32XN	S44-35-SAC
PJ-32N	4S-32-N	B432A	N/A	EZ32XN	S44-35-RAC
PJ-4B	A400	A400	N/A	EZXL	4SBC
PJ-4S1	A410	A410	N/A	EZ03SXA	RC-1
PJ-4S2	A411	A411	N/A	EZ04ES	N/A
PJ-4T1	A420	A420	N/A	EZ06DXA	RC-2
PJ-4T2	A421	A421	N/A	EZ08ED	N/A

Index

Cat. Part No.	Page No.	Cat. Part No.	Page No.	Cat. Part No.	Page No.	Cat. Part No.	Page No.	Cat. Part No.	Page No.	Cat. Part No.	Page No.
1096-N	8	2302-NK	11	3303-NKV	28	5305-NK	17	9329-EW	12	9336-16	20
1096-NR	8	2302-NKRED	11	3303-SS	13	5305-NKV	28	9329-EWK	12	9336-16C2	20
1096-SS	8	2302-NKV	28	3303-SSK	13	5305-Z4BK	17	9331-E	9	9336-16G	20
1096-Z2	8	2302-SS	11	3303-Z4	14	9301-E	9	9331-EC2	9	9336-16GC2	20
1096-Z4	8	2302-SSK	11	3303-Z4K	14	9301-EC2	9	9331-EK	9	9336-16GK	20
1098-N	8	2302-Z4	11	33213SSP	43	9303-H	10	9331-ES	9	9336-16K	20
1098-NR	8	2302-Z4K	11	4300-Z22	16	9304	22	9331-ESC2	9	9336-BH	20
1098-SS	8	2TP	12, 37	4300-Z22K	16	9304-G	22	9331-ESK	9	9336-BHC2	20
1098-Z2	8	3300-Z22	14	4300-N	15	9305	22	9331-EW	10	9336-BHG	20
1098-Z4	8	3300-Z22K	14	4300-NB	15	9305-C2	22	9331-EWC2	10	9336-BHGC2	20
1098-Z4H	8	3300-Z24	14	4300-NBC4	15	9305-G	22	9331-EWK	10	9336-BHGK	20
1099-N	8	3300-Z24K	14	4300-NBK	15	9305-GK	22	9335-16	20	9336-BHK	20
1099-NR	8	3300-N	13	4300-NC4	15	9305-K	22	9335-16C2	20	9336-HNGK	19
1099-NRED	8	3300-NB	13	4300-NK	15	9305-S	22	9335-16G	20	9336-HNK	19
1099-NV	28	3300-NBC3	13	4300-SS	15	9305-SC2	22	9335-16GC2	20	9336-N	19
1099-NV2	28	3300-NBK	13	4300-SSB	15	9305-SG	22	9335-16GK	20	9336-NC2	19
1099-SS	8	3300-NC3	13	4300-SSBK	15	9305-SGK	22	9335-16K	20	9336-NG	19
1099-Z4	8	3300-NC6	13	4300-SSK	15	9305-SK	22	9335-BH	20	9336-NGK	19
1K-100	37	3300-NK	13	4300-Z2	16	9312-E	12	9335-BHC2	20	9336-NK	19
1TP	10, 37	3300-SS	13	4300-Z2B	16	9312-EK	12	9335-BHG	20	9336-NKFR	26
2300-Z22	11	3300-SSB	13	4300-Z2BK	16	9312-EW	12	9335-BHGC2	20	9338-E	21
2300-Z22K	11	3300-SSBK	13	4300-Z2K	16	9312-EWC2	12	9335-BHGK	20	9338-EK	21
2300-N	11	3300-SSK	13	4300-Z4	16	9312-EWC4	12	9335-BHK	20	9338-EKT	21
2300-NC2	11	3300-Z2	14	4300-Z4K	16	9312-EWK	12	9335-BHKV2	29	9338-ES	21
2300-NC4	11	3300-Z2B	14	4304-Z24	16	9313-EW	14	9335-HNGK	19	9338-ESC2	21
2300-NK	11	3300-Z2BK	14	4304-Z24K	16	9313-EWC3	14	9335-HNK	19	9338-ESC2T	21
2300-SS	11	3300-Z2K	14	4304-N	15	9313-EWK	14	9335-HNKV2	29	9338-ESG	21
2300-SSK	11	3300-Z4	14	4304-NB	15	9314-EWK	16	9335-N	19	9338-ESGC2	21
2300-Z2	11	3300-Z4K	14	4304-NBK	15	9315	18	9335-NC2	19	9338-ESGK	21
2300-Z2K	11	3303-Z24	14	4304-NK	15	9315-WH	18	9335-NFR	26	9338-ESGKT	21
2300-Z4	11	3303-Z24K	14	4304-NKV	28	9318	10	9335-NG	19	9338-ESK	21
2300-Z4K	11	3303-N	13	4304-Z4B	16	9319	10	9335-NGC2	19	9338-ESKT	21
2302-HNKV2	28	3303-NB	13	4304-Z4BK	16	9320	10	9335-NGK	19	9338-EST	21
2302-N	11	3303-NBK	13	50PANST	37	9322	10	9335-NK	19	9339-Z+1	18
2302-NC2	11	3303-NC6	13	5305-NBK	17	9324-N	8	9335-NKFR	26	9339-Z+1C2	18
2302-NC4	11	3303-NK	13	5305-NBKV	28	9327-N	8	9335-NKRED	19	9342-C2	18

Cat. Part No.	Page No.	Cat. Part No.	Page No.	Cat. Part No.	Page No.	Cat. Part No.	Page No.	Cat. Part No.	Page No.	Cat. Part No.	Page No.
9342-HF	18	9351-NFR	26	9365-NK	23	FB-5DB	48	P-122SC	33	PJ-32H	35
9342-HN	18	9351-NG	23	9365-NKFR	26	FB-5DBCVR	48	P-181	33	PJ-32N	35
9343-N	18	9351-NGC2	23	9366-EK	9	FB-5N	48	P-181H	33	PJ-4B	35
9343-NC2	18	9351-NGK	23	9366-EW	10	FB-5NCVR	48	P-181HZ	33	PJ-4S1	35
9343-NK	18	9351-NK	23	9366-EWK	10	FB-6	46	P-181QT	33	PJ-4S2	35
9343-SS	18	9351-NKFR	26	9367-E	10	FB-6CVR	46	P-181RK	33	PJ-4T1	35
9343-SSK	18	9351-NKFRV	29	9367-EW	10	FB-6DB	46	P-201	33	PJ-4T2	35
9344	18	9351-NKRED	23	9368-E	9	FB-6DBCVR	46	P-201QT	33	RD-42	18
9345	18	9351-NKV	29	9368-EK	9	FB-6N	46	P-201R	33	RD-42SS	18
9345-58	18	9351-SS	23	9368-EW	10	FB-6NCVR	46	P-2400W	34	RD-42V	28
9346	18	9351-SSK	23	9368-EWK	10	FB-7	50	P-241	33	SB-1	31
9346-58	18	9355	22	9369-FB	26	FB-7CVR	50	P-241H	33	SB-1H	31
9347	18	9355-G	22	9369-FBH	26	FB-7DB	50	P-241HQT	33	SB-2	31
9348	18	9355-GK	22	9369-FRBKB	26	FB-7DBCVR	50	P-241QT	33	SB-3	31
9350	23	9355-K	22	9370-FR	26	FB-7N	50	P-3520W	34	SB-4	31
9350-16	25	9355-S	22	9371-FRV	29	FB-7NCVR	50	P-442	34	SB-CB	31
9350-16C2	25	9355-SGK	22	9372-NMHK	11	FB-8	50	P-442H	34	SB-CBFR	31
9350-16G	25	9355-SK	22	9373-FR	26	FB-8CVR	50	P-442HQT	34	SB-CBG	31
9350-16GC2	25	9361-E	9	9375-FR	26	FB-8DB	50	P-442QT	34	SBFB-1	46
9350-16GK	25	9361-EC2	9	9380-FR	27	FB-8DBCVR	50	P-643	34	SBFB-1DB	46
9350-16K	25	9361-EK	9	9380-FANB	27	FB-8N	50	P-643H	34	SBFB-1N	46
9350-16KV	29	9361-ES	9	AC9500	41	FB-8NCVR	50	P-643HQT	34	SBFB-1CVR	46
9350-BH	24	9361-ESC2	9	AC9500BULK	41	FB-BRPLG	46,50	P-643QT	34	SBFB-1DBCVR	46
9350-BHC2	24	9361-ESK	9	AC9501	41	FB-BRPLGLV	50	P-764	34	SBFB-1NCVR	46
9350-BHG	24	9363-E	9	AC9502	41	FB-CAK	51	P-764B	34	WIRE CLAMP	37
9350-BHGC2	24	9363-EC2	9	FB-1	46	FB-DBPLG	46,50	P-764BQT	34	WINGS	37
9350-BHGK	24	9363-EK	9	FB-1CVR	46	FB-DBPLGLV	50	P-764H	34		
9350-BHK	24	9363-EW	10	FB-1N	46	FB-NPLG	46,50	P-764HB	34		
9350-BHKV	29	9363-EWC2	10	FB-1NCVR	46	FB-NPLGLV	50	P-764HBQT	34		
9350-BHKV2	29	9363-EWK	10	FB-2	46	GRD STRAP	37	P-764HQT	34		
9350-FAN	27	9364	23	FB-2CVR	46	LH-11P	42	P-764QT	34		
9350-FANB	26	9364-16	25	FB-2DB	46	LH-11WP	42	PC213-16	36		
9350-FANV2B	29	9364-16C2	25	FB-2DBCVR	46	LH-12P	42	PC213-16G	36		
9350-FANVB	29	9364-16G	25	FB-2N	46	LH-12WP	42	PC213-BH	36		
9350-FRBKOW	27	9364-16GC2	25	FB-2NCVR	46	LH-13P	42	PC213-BHG	36		
9350-HFK	24	9364-16GK	25	FB-3	50	LH-21WP	42	PC213-N	36		
9350-HL	24	9364-16K	25	FB-3CVR	50	LH-22WP	42	PC213-NG	36		
9350-HLC2	24	9364-BH	24	FB-3DB	50	LH-CFL1	43	PC2230W	36		
9350-HLGK	24	9364-BHC2	24	FB-3DBCVR	50	LH-CFL2	43	PC2230WG	36		
9350-HLK	24	9364-BHG	24	FB-3N	50	LVB-1	40	PC2440W	36		
9350-HN	24	9364-BHGC2	24	FB-3NCVR	50	LVBOW-1	40	PC2440WG	36		
9350-HNK	24	9364-BHGK	24	FB-4	50	LVP-1	12, 14, 16, 17, 40	PC234-16	36		
9350-HNKV2	29	9364-BHK	24	FB-4CVR	50	LVP-2	31, 35, 40	PC234-16G	36		
9350-K	23	9364-FAN	27	FB-4DB	50	LVPR-1	40	PC234-BH	36		
9350-KFR	26	9364-FANB	26	FB-4DBCVR	50	P-108E	33	PC234-BHG	36		
9350-BHGKV	29	9364-FRBKOW	27	FB-4N	50	P-108H	33	PC234-N	36		
9351-NGKV	29	9364-K	23	FB-4NCVR	50	P-1160W	33	PC234-NG	36		
9351-N	23	9364-KFR	26	FB-5	48	P-1180W	33	PJ-20H	35		
9351-NC2	23	9365-N	23	FB-5CVR	48	P-1220W	33	PJ-20N	35		

- www.ul.com

UL certifies, validates, tests, inspects, audits, and advises and trains. UL provides the knowledge and expertise to help customers navigate growing complexities across the supply chain from compliance and regulatory issues to trade challenges and market access. In this way, UL facilitates global trade and delivers peace of mind.

UL's Online Certifications Directory

You can use the UL Online Certification Directory to:

- Verify a UL Listing, Classification, or Recognition
- Verify a UL Listed product use
- Verify a UL Recognized component use
- Verify a product safety standard



- www.iccsafe.org

The International Code Council is a member-focused association. It is dedicated to developing model codes and standards used in the design, build and compliance process to construct safe, sustainable, affordable and resilient structures.

Most U.S. communities and many global markets choose the International Codes.

The ICC has developed and made available a comprehensive and coordinated set of International Codes, including:

- International Building Code
- International Energy Conservation Code
- International Existing Building Code
- International Fire Code
- International Fuel Gas Code
- International Green Construction Code
- International Mechanical Code
- ICC Performance Code
- International Plumbing Code
- International Private Sewage Disposal Code
- International Property Maintenance Code
- International Residential Code
- International Swimming Pool and Spa Code
- International Wildland Urban Interface Code
- International Zoning Code

- www.naed.org

The National Association of Electrical Distributors (NAED) is the voice of the electrical distributor. They provide members with the best tools, information and assistance to help them thrive and improve the electrical distribution channel.

- www.nfpa.org

NFPA is a global, nonprofit organization devoted to eliminating death, injury, property and economic loss due to fire, electrical and related hazards. The association delivers information and knowledge through more than 300 consensus codes and standards, research, training, education, outreach and advocacy; and by partnering with others who share an interest in furthering the NFPA mission.

- www.necconnect.org

The National Electrical Code (NEC) is the benchmark for safe electrical design, installation, and inspection to protect people and property from electrical hazards. It is adopted in all 50 states.

- www.boma.org

The Building Owners and Managers Association (BOMA) International is a federation of 91 BOMA U.S. associations and 17 international affiliates. Founded in 1907, BOMA represents the owners and managers of all commercial property types including nearly 10.4 billion square feet of U.S. office space that supports 1.8 million jobs and contributes \$227.6 billion to the U.S. GDP. Its mission is to advance a vibrant commercial real estate industry through advocacy, influence and knowledge.

BOMA International is a primary source of information on building management and operations, development, leasing, building operating costs, energy consumption patterns, local and national building codes, legislation, occupancy statistics, technological developments and other industry trends.

- www.nahb.org

The National Association of Home Builders (NAHB) helps its members build communities. Each year, NAHB's members construct about 80% of the new homes built in the United States, both single-family and multifamily.

Since it was founded in the early 1940s, NAHB has served as the voice of America's housing industry. We work to ensure that housing is a national priority and that all Americans have access to safe, decent and affordable housing, whether they choose to buy a home or rent.

- www.nmhc.org

National Multi-Family Housing Council is the place where the leaders of the apartment industry come together to guide their future success. With the industry's most prominent and creative leaders, NMHC provides a forum for insight, advocacy and action that enable both members and the communities they build to thrive.

Underwriters Laboratories® (UL) partners with manufacturers to provide safe products to consumers through UL testing, certification and follow-up audits. UL's Data Acceptance Program (DAP) provides a means for UL to accept externally generated test data in support of UL Mark certification. Product investigations by UL typically involve testing of product samples. While UL maintains extensive test facilities, customers can also utilize their own or third-party facilities for product testing via UL's DAP.

Participating test facilities are required to have the appropriate physical resources, equipment and qualified personnel needed to conduct testing, equivalent to what would be used in UL's own laboratories for the same testing. UL offers five different types of data acceptance programs. **Allied Moulded Products, Inc. is certified through the Client Test Data Program (CTDP).**

After a data acceptance program is established, UL will reassess a test laboratory annually. All data submitted is thoroughly reviewed and audited by UL before being used for certification.

Benefits of DAP

UL's Data Acceptance Program provides qualified customers a number of advantages. The largest advantage is the increased control over the timing and schedule for their product testing and certification program. The number one delay for projects is a non-conforming test result. Having the ability to identify these issues and have their engineering team available at the test location results in faster resolution.

Providing UL with a data sheet ready package at the time of submittal eliminates test time and allows UL to decrease the turnaround time for DAP participant's projects. Our customers see an increase in delivering speed, market access and flexibility.

Conducting testing at your site on your own schedule is a more flexible way to enable your business to obtain our market-leading certifications for your products.



Allied Moulded's Certified Test Standard:

- **UL 514C**
(Standard for Nonmetallic Outlet Boxes, Flush-Device Boxes, and Covers)

Allied Moulded performs the following tests in accordance with the guidelines set forth by the CTDP:

- Flame test (shown below, right)
- Fan support test
- Fixture support test at elevated temperature and ambient temperature
- Deflection of outlet box under a rated load
- Volume
- Impact
- Crush (shown below, left)
- Strength of knockouts
- Water absorption

The UL certification allows manufacturers and consumers to feel confident that quality is maintained. Allied Moulded is committed to providing a trustworthy and innovative product offering to the residential and commercial electrical marketplace.

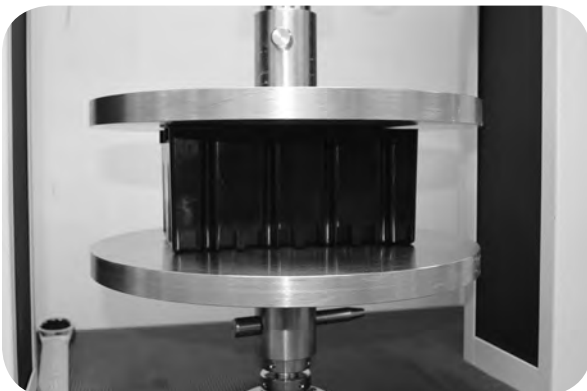

Allied Moulded's flexBOX® product undergoes various test procedures for UL certification

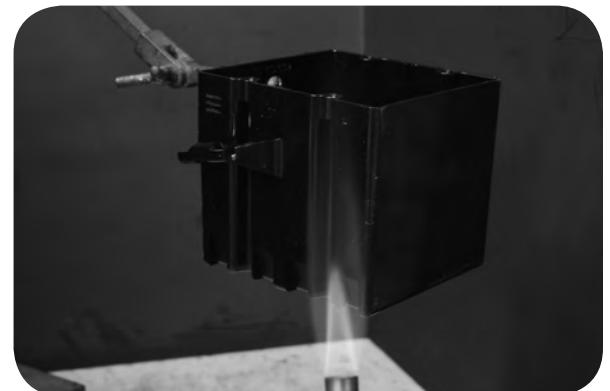

Have you used our new website lately?

We have recently updated our website to include new features and options, making it easier than ever to access the information you need, whenever you need it. Access our website on your computer, smartphone or tablet, no matter where you are!

Take a look below and find out how Allied Moulded's new website can benefit you and your new project!

- Download and save product specification pages in PDF format
- View and download high quality images for every product and accessory
- Download 2D PDF drawing files for every product
- Find your local sales representative by entering your state or zip code in our "Find a Rep" map
- Watch unique product feature videos and animations
- Live chat with our customer service team during normal business hours (EST)
- Access our entire library of PDF catalog files, inspector documents and technical data information
- Use our new search function to easily navigate your way to specific part numbers and information



222 North Union Street
Bryan, Ohio 43506

P: (419) 636.4217
F: (419) 636.2450
E: sales@alliedmoulded.com
www.alliedmoulded.com



**ALLIED
MOULDED
PRODUCTS, Inc.**

THE CONTRACTOR'S CHOICE

Allied Moulded Products, Inc. (Allied) is the Contractor's Choice of nonmetallic electrical boxes in today's residential markets. Leveraging more than half-a-century of experience, Allied Moulded has grown to become the benchmark of quality within the electrical industry. Our full-service molding operation includes expertise in compression and injection molding, using thermoset and thermoplastic materials, provide our customers with a superior product at a competitive price. Our unrelenting focus on service, delivery, value, innovation and technology in everything we make and do, has made us who we are today.

Allied Moulded offers a full range of residential electrical outlet box products for residential construction. All products are designed with both the electrical professional and the do-it-yourself home owner in mind and have earned a reputation for strength and rigidity while remaining innovative.

In addition, Allied Moulded offers a full line of NEMA 4X/IP66 nonmetallic electrical enclosures and accessories for a wide range of industrial applications found around the world. Their nonmetallic material properties provide a suitable substitution for steel and stainless steel products for corrosive applications.



**ALLIED
MOULDED
PRODUCTS, Inc.**

Allied Moulded Products, Inc.
Bryan, OH 43506

ph: 800-722-2679
fax: 800-237-7269

Find out more about us online at:
www.alliedmoulded.com

Available Through: