



SATCO

LED LAMPS





**NEW PRODUCT
INTRODUCTIONS**
JANUARY, 2020

40W & 60W replacement Econo LED A19 lamps

- Direct replacement for 40 Watt incandescent lamps or 9 Watt CFL, uses only 5.8 Watts
- Direct replacement for 60 Watt incandescent lamps or 13 Watt CFL, uses only 9.8 Watts
- Residential and commercial lighting
- 2700K, 3000K, 4000K & 5000K options
- Damp location
- 10,000 Hours
- Non-dimmable
- Approved for enclosed fixtures
- 3 Year warranty*

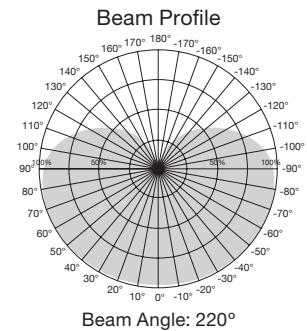

40W & 60W Replacement ECO A19 LED Lamps

Item #	Lamp Description	W	V	CRI	CCT	Lm	Bm	M.O.L. (Inches)	Life/Hrs.	UPC	Pk.
S11402	5.8A19/LED/27K/120V/ECO/ND	5.8	120	80	2700K	450	220°	4 5/16	10K	045923114021	24
S11403	5.8A19/LED/30K/120V/ECO/ND	5.8	120	80	3000K	450	220°	4 5/16	10K	045923114038	24
S11404	5.8A19/LED/40K/120V/ECO/ND	5.8	120	80	4000K	450	220°	4 5/16	10K	045923114045	24
S11405	5.8A19/LED/50K/120V/ECO/ND	5.8	120	80	5000K	450	220°	4 5/16	10K	045923114052	24
S11406	9.8A19/LED/27K/120V/ECO/ND	9.8	120	80	2700K	800	220°	4 5/16	10K	045923114069	24
S11407	9.8A19/LED/30K/120V/ECO/ND	9.8	120	80	3000K	800	220°	4 5/16	10K	045923114076	24
S11408	9.8A19/LED/40K/120V/ECO/ND	9.8	120	80	4000K	800	220°	4 5/16	10K	045923114083	24
S11409	9.8A19/LED/50K/120V/ECO/ND	9.8	120	80	5000K	800	220°	4 5/16	10K	045923114090	24

*See warranty for details. Visit www.satco.com

60W & 100W Replacement dimmable LED A19 4-packs

Applications

- Indoor residential and commercial lighting
- Down lighting
- Display lighting
- Accent lighting

Features

- 60 Watt replacement uses only 9.5 Watts
- 100 Watt replacement uses only 15.5 Watts
- 2700K, 3000K, 4000K and 5000K options
- Damp location
- Approved for totally enclosed fixtures**
- Long life—15,000 hours
- 3 Year warranty



S11414-S11417
60W Replacement

S11422-S11425
100W Replacement

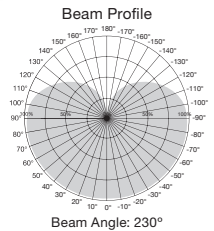

60W & 100W Replacement Dimmable LED A19 4-packs



Item Number	Lamp Description	W	V	CRI	CCT	Lm	Bm	M.O.L. (Inches)	Life/Hrs.	UPC	Pack/Master
60W Replacement											
S11414	9.5A19/LED/827/120V/D/4PK	9.5	120	80	2700K	800	230°	4 3/16	15K	045923114144	12 - 4pks
S11415	9.5A19/LED/830/120V/D/4PK	9.5	120	80	3000K	800	230°	4 3/16	15K	045923114151	12 - 4pks
S11416	9.5A19/LED/840/120V/D/4PK	9.5	120	80	4000K	800	230°	4 3/16	15K	045923114168	12 - 4pks
S11417	9.5A19/LED/850/120V/D/4PK	9.5	120	80	5000K	800	230°	4 3/16	15K	045923114175	12 - 4pks
100W Replacement											
S11422	15.5A19/LED/827/120V/D/4PK	15.5	120	80	2700K	1600	230°	4 9/16	15K	045923114229	12 - 4pks
S11423	15.5A19/LED/830/120V/D/4PK	15.5	120	80	3000K	1600	230°	4 9/16	15K	045923114236	12 - 4pks
S11424	15.5A19/LED/840/120V/D/4PK	15.5	120	80	4000K	1600	230°	4 9/16	15K	045923114243	12 - 4pks
S11425	15.5A19/LED/850/120V/D/4PK	15.5	120	80	5000K	1600	230°	4 9/16	15K	045923114250	12 - 4pks

60W replacement LED A19 10-packs

Direct replacements for 60W incandescent lamps

Value-packed for retail or contractor sales

- 60 Watt replacement uses only 9 Watts
- Direct replacement for 13 Watt screw-in CFLs
- Indoor residential and commercial lighting
- 3000K, and 5000K options
- Damp location
- Approved for totally enclosed fixtures
- Long life—10,000 hours
- 3 Year warranty

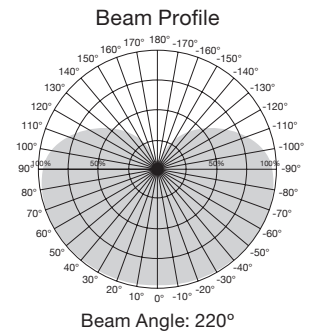

60W Replacement Multi-Directional A19 LED Lamp 10-packs



Item Number	Lamp Description	W	V	CRI	CCT	Lm	Bm	M.O.L. (Inches)	Life/Hrs.	UPC
S11400	9A19/LED/E26/3K/120V/10PK	9	120	80	3000K	800	220°	4 2/5	10K	045923114007
S11401	9A19/LED/E26/5K/120V/10PK	9	120	80	5000K	800	220°	4 2/5	10K	045923114014

*Sold per 10 pk

Master Cases 4/10 pks

T20 Compliant LED A19 & BR30 lamps in value packs

Applications

- Indoor residential and commercial lighting
- Down lighting
- Display lighting
- Accent lighting

Features

- Direct replacement for 60 Watt incandescent lamps, uses only 9.5 Watts
- Direct replacement for 65 Watt BR30 lamps, uses only 8.7 Watts
- T20 Compliant
- Damp location
- Approved for enclosed fixtures (A19)**
- 3 Year warranty
- **A19 - Non-dimmable**
- **BR30 - Dimmable**

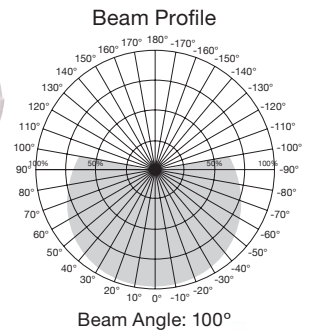
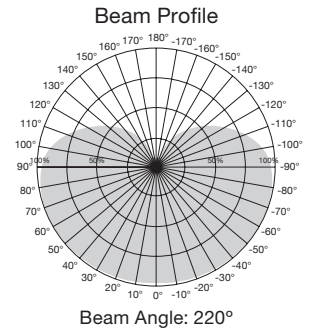

T10 Compliant LED A19 & BR30 Multi-packs



Item #	Lamp Description	W	V	CRI	Bulb Type	Base Type	CCT	Finish	Lm	Bm	MOL	Life/ Hrs	UPC	Pk/ Master
S11410**	9.5A19/LED/E26/3K/CEC	9.5	120	90	A19	E26	3000	Frost	760	220°	4.4"	10,000	045923114106	10Pk Box
S11411**	9.5A19/LED/E26/5K/CEC	9.5	120	90	A19	E26	5000	Frost	760	220°	4.4"	10,000	045923114113	10Pk Box
S11420*	8.7BR30/LED/927/CEC	8.7	120	90	BR30	E26	2700	Frost	700	100°	5.12"	25,000	45923114205	6Pk Box

60W replacement LED A19 Dusk to Dawn lamp

On at dusk, off at dawn

- Direct replacement for 60 Watt incandescent lamp uses only 8 Watts
- Indoor/outdoor residential and commercial lighting
- Automatic operation--no timers to set
- Internal sensor works in any direction
- Damp location
- Approved for totally enclosed fixtures
- E26 Medium base
- 2700K Warm White
- Non-dimmable
- Not compatible with external photo sensors, motion sensors or timers
- C-UL-us Listed
- Long life—up to 15,000 hours
- 3 Year warranty



60W Replacement LED A19 Dusk to Dawn Lamp



Item Number	Lamp Description	Watts	Voltage	CRI	CCT	Lm	Life/Hrs.	Beam Angle	UPC	Pk
S11421	8A19/DUSK/DAWN/LED/27K	8	120	80	2700	80	15K	200°	045923114212	1/24

Carded & multi-pack LED filament lamps

Types

- General purpose
- Vintage style
- Decorative

Features

- Direct replacements for incandescent lamps
- LED replacements use 80% less energy
- Carded and multi-packs
- Approved for totally enclosed fixtures**
- ENERGY STAR certified*
- Long life—15,000 hours
- 3 Year warranty



NEW PRODUCT INFORMATION — JANUARY, 2020



LED filament lamps - Carded

LED Filament Lamps



Item #	Lamp Description	W	Bulb Type	Base	V	Finish	CCT	Lm	Life/Hrs.	UPC	Pack
A15											
S8615*	4.5A15/CL/LED/E26/27K/ES/120V/1CD	4.5	A15	E26	120	Clear	2700K	450	15K	045923086151	12/1 cd
S21710*	5.5A15/LED/2700K/E12/120V/2CD	5.5	A15	E12	120	Clear	2700K	450	15K	045923217104	12/2 cd
S21733*	5A15/LED/WH/27K/E26/120V/2CD	5	A15	E26	120	White	2700K	450	15K	045923217333	12/2 cd
S21711*	5.5A15/LED/2700K/E26/120V/2CD	5.5	A15	E26	120	Clear	2700K	450	15K	045923217111	12/2 cd
A19											
S8616*	7A19/CL/LED/E26/27K/ES/120V/1CD	7	A19	E26	120	Clear	2700K	800	15K	045923086168	12/1 cd
B11/C11 - Torpedo Shape											
S21700*	2.5W CTC/LED/27K/CL/120V/2CD	2.5	B11	E12	120	Clear	2700K	180	15K	045923217005	12/2 cd
S28613*	4WCTC/LED/27K/CL/120V/1CD	4	C11	E12	120	Clear	2700K	350	15K	045923286131	12/1 cd
S21702*	4.5W CTC/LED/27K/CL/120V/2CD	4.5	B11	E12	120	Clear	2700K	350	15K	045923217029	12/2 cd
S21704*	4.5W CTF/LED/27K/FR/120V/2CD	4.5	B11	E12	120	Frosted	2700K	330	15K	045923217043	12/2 cd
S21728*	4.5W CTC/LED/5K/CL/120V/2CD	4.5	B11	E12	120	Clear	5000K	350	15K	045923217289	12/2 cd
S21706*	5.5W CTC/LED/27K/CL/120V/2CD	5.5	B11	E12	120	Clear	2700K	500	15K	045923217067	12/2 cd
S21701*	2.5W ETC/LED/27K/CL/120V/2CD	2.5	B11	E26	120	Clear	2700K	180	15K	045923217012	12/2 cd
S21703*	4.5W ETC/LED/27K/CL/120V/2CD	4.5	B11	E26	120	Clear	2700K	350	15K	045923217036	12/2 cd
S8609*	4.5WETC/LED/27K/120V/1CD	4.5	C11	E26	120	Clear	2700K	450	15K	045923086090	12/1 cd
S21705*	4.5W ETF/LED/27K/FR/120V/2CD	4.5	B11	E26	120	Frosted	2700K	330	15K	045923217050	12/2 cd
S21730*	4.5W ETC/LED/5K/CL/120V/2CD	4.5	B11	E26	120	Clear	5000K	350	15K	045923217302	12/2 cd
S21707*	5.5W ETC/LED/27K/CL/120V/2CD	5.5	B11	E26	120	Clear	2700K	500	15K	045923217074	12/2 cd
CA10/CA11 - Flame Tip											
S21720*	2.5W CFC/LED/27K/CL/120V/2CD	2.5	CA10	E12	120	Clear	2700K	180	15K	045923217203	12/2 cd
S28614*	4WCFC/LED/27K/CL/120V /1CD	4	CA11	E12	120	Clear	2700K	350	15K	045923286148	12/1 cd
S21721*	4.5W CFC/LED/27K/CL/120V/2CD	4.5	CA10	E12	120	Clear	2700K	350	15K	045923217210	12/2 cd
S21732*	4.5W CFF/LED/27K/FR/120V/2CD	4.5	CA10	E12	120	Frost	2700K	350	15K	045923217326	12/2 cd
S21722*	4.5W CFC/LED/5K/CL/120V/2CD	4.5	CA10	E12	120	Clear	5000K	350	15K	045923217227	12/2 cd
S21723*	5.5W CFC/LED/27K/CL/120V/2CD	5.5	CA10	E12	120	Clear	2700K	500	15K	045923217234	12/2 cd
S21724*	2.5W EFC/LED/27K/CL/120V/2CD	2.5	CA10	E26	120	Clear	2700K	180	15K	045923217241	12/2 cd
S21725*	4.5W EFC/LED/27K/CL/120V/2CD	4.5	CA10	E26	120	Clear	2700K	350	15K	045923217258	12/2 cd
S21731*	4.5W EFF/LED/27K/FR/120V/2CD	4.5	CA10	E26	120	Frost	2700K	350	15K	045923217319	12/2 cd
S21726*	4.5W EFC/LED/5K/CL/120V/2CD	4.5	CA10	E26	120	Clear	5000K	350	15K	045923217265	12/2 cd
S8610*	4.5WEFC/LED/27K/120V/1CD	4.5	CA11	E26	120	Clear	2700K	450	15K	045923086106	12/1 cd
S21727*	5.5W EFC/LED/27K/CL/120V/2CD	5.5	CA10	E26	120	Clear	2700K	500	15K	045923217272	12/2 cd



LED filament lamps - Carded

LED Filament Lamps



Item #	Lamp Description	W	Bulb Type	Base	V	Finish	CCT	Lm	Life/ Hrs.	UPC	Pack
G16											
S21735*	4.5G16/LED/CL/27K/E12/120V/2CD	4.5	G16	E12	120	Clear	2700K	350	15K	045923217357	12/2 cd
S21736*	5.5G16/LED/CL/27K/E12/120V/2CD	5.5	G16	E12	120	Clear	2700K	500	15K	045923217364	12/2 cd
ST19											
S8612	4.5ST19/AMB/LED/E26/2K/120V/1CD	4.5	ST19	E26	120	Amber	2000K	380	15K	045923086120	12/1 cd
S8611	6.5ST19/CL/LED/E26/27K/120V/1CD	6.5	ST19	E26	120	Clear	2700K	810	15K	045923086113	12/1 cd



LED filament lamps - Multi-Packs

LED Filament Lamps



Item #	Lamp Description	W	Bulb Type	Base	V	Finish	CCT	Lm	Life/ Hrs.	UPC	Pack
G25											
S21737*	4.5G25/LED/CL/27K/120V/2PK BOX	4.5	G25	E26	120	Clear	2700K	350	15K	045923217371	12/2 pk
S21738*	4.5G25/LED/WH/27K/120V/2PK BOX	4.5	G25	E26	120	White	2700K	350	15K	045923217388	12/2 pk
S21739*	5.5G25/LED/CL/27K/120V/2PK BOX	5.5	G25	E26	120	Clear	2700K	500	15K	045923217395	12/2 pk
S21740*	5.5G25/LED/WH/27K/120V/2PK BOX	5.5	G25	E26	120	White	2700K	500	15K	045923217401	12/2 pk

NEW PRODUCT INFORMATION — JANUARY, 2020



LED filament lamps - Multi-Packs

LED Filament Lamps



Item #	Lamp Description	W	Bulb Type	Base	V	Finish	CCT	Lm	Life/Hrs.	UPC	Pack
Decorative - 3 Pack Box											
S21729*	4.5W CTC/LED/3K/CL/120V/3PK	4.5	B11	E12	120	Clear	3000K	350	15K	045923217296	12-3pk
S21708*	4.5W CTC/LED/27K/CL/120V/3PK	4.5	B11	E12	120	Clear	2700K	350	15K	045923217081	12-3pk
A19 - 4 Pack Box											
40 Watt Replacement											
S21712*	5A19/CL/LED/E26/27K/120V/4PK	5	A19	E26	120	Clear	2700K	450	15K	045923217128	12-4pk
60 Watt Replacement											
S21713*	7.5A19/CL/LED/E26/27K/120V/4PK	7.5	A19	E26	120	Clear	2700K	800	15K	045923217135	12-4pk
S21714*	7.5A19/SW/LED/E26/27K/120V/4PK	7.5	A19	E26	120	Frosted	2700	800	15K	045923217142	12-4pk
S21734*	7.5A19/CL/LED/E26/3K/120V/4PK	7.5	A19	E26	120	Clear	3000K	800	15K	045923217340	12-4pk
75 Watt Replacement											
S11503	9A19/FR/LED/E26/827/120V/4PK	9	A19	E26	120	Frost	2700K	1100	15K	045923115035	12-4pk
S11504	9A19/FR/LED/E26/830/120V/4PK	9	A19	E26	120	Frost	3000K	1100	15K	045923115042	12-4pk
100 Watt Replacement											
S11508	13A19/FR/LED/E26/827/120V/4PK	13	A19	E26	120	Frost	2700K	1500	15K	045923115080	12-4pk
S11509	13A19/FR/LED/E26/830/120V/4PK	13	A19	E26	120	Frost	3000K	1500	15K	045923115097	12-4pk
S11513	12A19/CL/LED/E26/827/120V/4PK	12	A19	E26	120	Clear	2700K	1500	15K	045923115134	12-4pk
S11514	12A19/CL/LED/E26/830/120V/4PK	12	A19	E26	120	Clear	3000K	1500	15K	045923115141	12-4pk

Satco-Escent LED lamps

Elegance and efficiency, boxed or carded.

The most "decorative" decorative LED on the market. Adds elegance and style to any fixture even when not illuminated.

Features

- 2 Watt LED direct replacement for 25 watt incandescent lamps
- 4 Watt LED direct replacement for 40 watt incandescent lamps
- E26 & E12 Base options
- Unique satin-spun white or amber finish
- Dimmable
- Carded versions for peg board merchandising
- LED filament technology
- Approved for totally enclosed fixtures
- Long life—15,000 hours
- 3 Year warranty



Satco-escent LED lamps



Item No.	Description	W	Voltage	Base Type	Finish	CCT	Lm	CRI	Life/Hrs.	UPC	Case Pack
Boxed											
S11300	2CA11/LED/SA/E12/27K/120V	2	120V	E12	Satin Spun	2700	150	80	15000	045923113000	24
S11301	2CA11/LED/A/E12/21K/120V	2	120V	E12	AmberSpun	2100	100	80	15000	045923113017	24
S11302	4CA11/LED/SA/E12/27K/120V	4	120V	E12	Satin Spun	2700	300	80	15000	045923113024	24
S11303	4CA11/LED/A/E12/21K/120V	4	120V	E12	AmberSpun	2100	200	80	15000	045923113031	24
S23403	2C11/LED/SA/E26/27K/120V	2	120V	E26	Satin Spun	2700	120	80	15,000	045923234033	24
S23407	2C11/LED/A/E26/23K/120V	2	120V	E26	Amber Spun	2100	100	80	15,000	045923234071	24
S23413	4C15/LED/SA/E26/27K/120V	4	120V	E26	Satin Spun	2700	300	80	15,000	045923234132	24
S23412	4C15/LED/A/E26/23K/120V	4	120V	E26	Amber Spun	2100	240	80	15,000	045923234125	24
Carded											
S11304	2CA11/LED/SA/E12/27K/120V/CD	2	120V	E12	Satin Spun	2700	150	80	15,000	045923113048	24
S11305	2CA11/LED/A/E12/21K/120V/CD	2	120V	E12	AmberSpun	2100	100	80	15,000	045923113055	24
S11306	4CA11/LED/SA/E12/27K/120V/CD	4	120V	E12	Satin Spun	2700	300	80	15,000	045923113062	24
S11307	4CA11/LED/A/E12/21K/120V/CD	4	120V	E12	AmberSpun	2100	200	80	15,000	045923113079	24
S22703	2C11/LED/SA/E26/27K/120V/CD	2	120V	E26	Satin Spun	2700	120	80	15,000	045923227035	24
S22707	2C11/LED/A/E26/23K/120V/CD	2	120V	E26	Amber Spun	2100	100	80	15,000	045923227073	24
S22713	4C15/LED/SA/E26/27K/120V/CD	4	120V	E26	Satin Spun	2700	300	80	15,000	045923227134	24
S22712	4C15/LED/A/E26/23K/120V/CD	4	120V	E26	Amber Spun	2100	240	80	15,000	045923227127	24



PAR30L
S12214, S12215



PAR38
S12216, S12217



PAR30S
S12212, S12213



PAR20
S12210, S12211

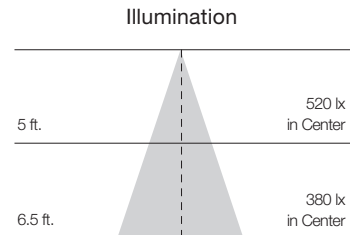

Beam Angle: 40°

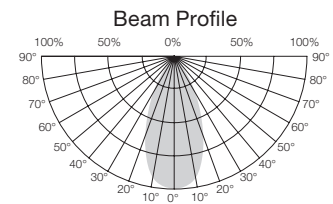

Beam Angle: 40°



Econo LED PAR lamps

High-value LED replacements for Halogen PAR lamps

Features

- Traditional lens
- Saves over 80% on energy costs
- 120V
- 3000K and 4000K options
- 40° Beam angle
- Approved for totally enclosed fixtures**
- Wet location - indoor/outdoor
- 3 Year limited warranty**

Econo PAR Lamps

Item Number	Lamp Description	W	V	CRI	CCT	Finish.	Lm	Bm	M.O.L. (Inches)	Life/Hrs.	UPC	Pack
50 PAR20 Replacement												
S12210	6PAR20/LED/830/FL/120V	6	120	80	3000K	WHITE	500	40°	3 7/8	11K	045923122101	24
S12211	6PAR20/LED/840/FL/120V	6	120	80	4000K	WHITE	500	40°	3 7/8	11K	045923122118	24
75 PAR30 Replacement												
S12212	8.9PAR30S/LED/830/FL/120V	8.9	120	80	3000K	WHITE	700	40°	3 3/8	11K	045923122125	12
S12213	8.9PAR30S/LED/840/FL/120V	8.9	120	80	4000K	WHITE	700	40°	3 3/8	11K	045923122132	12
S12214	8.9PAR30L/LED/830/FL/120V	8.9	120	80	3000K	WHITE	700	40°	4 7/16	11K	045923122149	12
S12215	8.9PAR30L/LED/840/FL/120V	8.9	120	80	4000K	WHITE	700	40°	4 7/16	11K	045923122156	12
90 PAR38 Replacement												
S12216	13PAR38/LED/830/FL/120V	13	120	80	3000K	WHITE	1000	40°	5 1/8	11K	045923122163	12
S12217	13PAR38/LED/840/FL/120V	13	120	80	4000K	WHITE	1000	40°	5 1/8	11K	045923122170	12

**Average rated life may vary depending on application, use, fixture type and environment.

High lumen LED PAR lamps

A high lumen, high efficiency option for all PAR38 and PAR30 long neck lamps

Features

- Direct replacement for 250W PAR38 lamps uses only 33 Watts
- Direct replacement for 75W PAR30LN lamps only 20.5 Watts
- Saves over 80% on energy costs
- 120V
- High efficiency
- 2700K, 3000K, 4000K, and 5000K options
- Approved for totally enclosed fixtures**
- Long life – 25,000 hours
- 3 Year limited warranty**

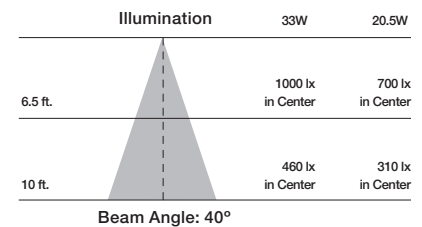
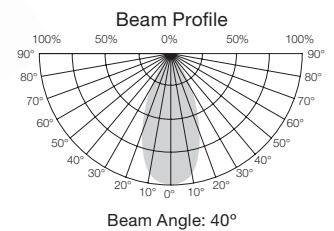

High Lumen PAR LED Lamps



Item Number	Lamp Description	W	V	CRI	CCT	Lm	Bm	M.O.L. (Inches)	Life/ Hrs.	UPC
S12240	20.5PAR30LN/LED/827/HL/120V/FL/D	20.5	120V	80	2700K	1800	40°	4.45	25K	045923122408
S12241	20.5PAR30LN/LED/830/HL/120V/FL/D	20.5	120V	80	3000K	1800	40°	4.45	25K	045923122415
S12242	20.5PAR30LN/LED/840/HL/120V/FL/D	20.5	120V	80	4000K	1800	40°	4.45	25K	045923122422
S12243	20.5PAR30LN/LED/850/HL/120V/FL/D	20.5	120V	80	5000K	1800	40°	4.45	25K	045923122439
S12250*	33PAR38/LED/827/HL/120V/FL/D	33	120V	80	2700K	3000	40°	5.13	25K	045923122507
S12251*	33PAR38/LED/830/HL/120V/FL/D	33	120V	80	3000K	3000	40°	5.13	25K	045923122514
S12252*	33PAR38/LED/840/HL/120V/FL/D	33	120V	80	4000K	3000	40°	5.13	25K	045923122521
S12253*	33PAR38/LED/850/HL/120V/FL/D	33	120V	80	5000K	3000	40°	5.13	25K	045923122538

** Average rated life may vary depending on application, use, fixture type and environment.

LED squat CFL lamp replacement with GU24 base

Applications

- Indoor residential and commercial lighting
- Utility fixtures
- Closet lighting

Features

- Direct replacement for squat GU24-based CFL lamps
- 13 Watt CFL replacement uses only 9.5 Watts (60W incandescent)
- 18 Watt CFL replacement uses only 12 Watts (75W incandescent)
- GU24 base
- Uniform luminance pattern
- 2700K and 4000K options
- 90 CRI
- Approved for totally enclosed fixtures**
- Damp location
- Long life—25,000 hours
- 5 Year warranty

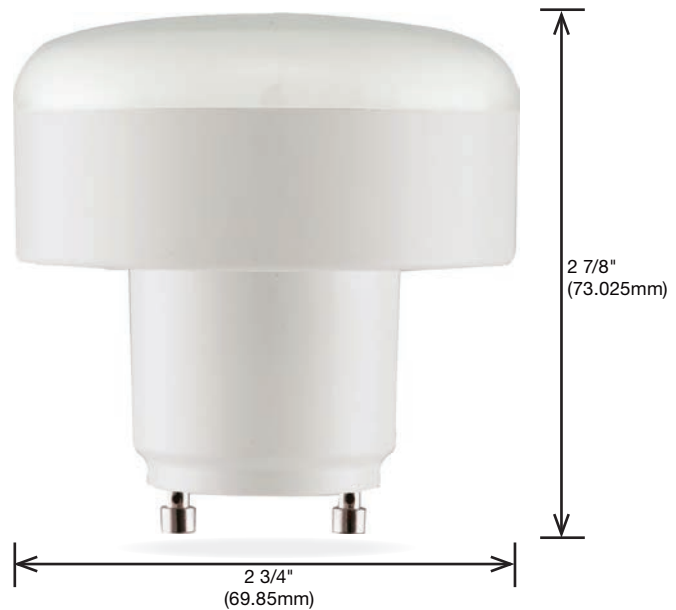

Replacement for CFL in Satco squat fixtures



- Fixtures:
- 90-2615
 - 90-2616
 - 90-2631
 - 90-2632

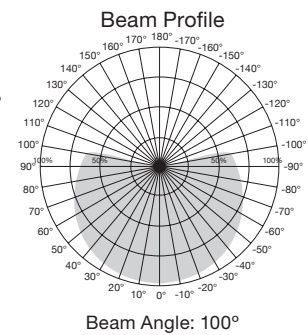

LED squat CFL lamp replacement with GU24 base

Item #	Lamp Description	W	CRI	Bulb Type	Bm	CCT	Lm	M.O.L. (Inches)	Life/Hrs.	UPC	Pk.
S11540	9.5W/SQUAT/LED/27K/GU24	9.5	90	LED/GU24	100°	2700K	800	2.835	25K	045923115400	24
S11541	9.5W/SQUAT/LED/40K/GU24	9.5	90	LED/GU24	100°	4000K	800	2.835	25K	045923015410	24
S11542	12W/SQUAT/LED/27K/GU24	12	90	LED/GU24	100°	2700K	1100	2.835	25K	045923115424	24
S11543	12W/SQUAT/LED/40K/GU24	12	90	LED/GU24	100°	4000K	1100	2.835	25K	045923115431	24

**Average rated life may vary depending on application, use, fixture type and environment



60W LED multi-beam Utility light with and without motion sensor

Applications

- Garage
- Barn
- Workshop
- Shed
- Utility room
- Large open spaces

Features

- Replaces high-wattage HID CFL and Incandescent lamps, but uses only 60 Watts
- LED panels adjust to 135° and a full 180°
- Rugged construction
- Built-in motion sensor option
- E26 medium base
- Direct wire range voltage 100-277V
- Damp location
- cULus Listed
- 3 Year warranty

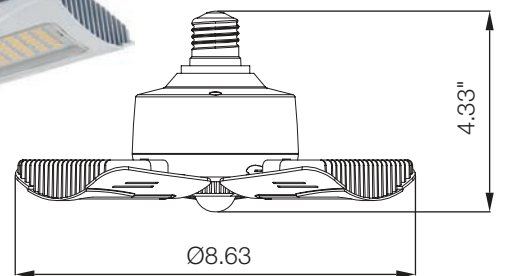
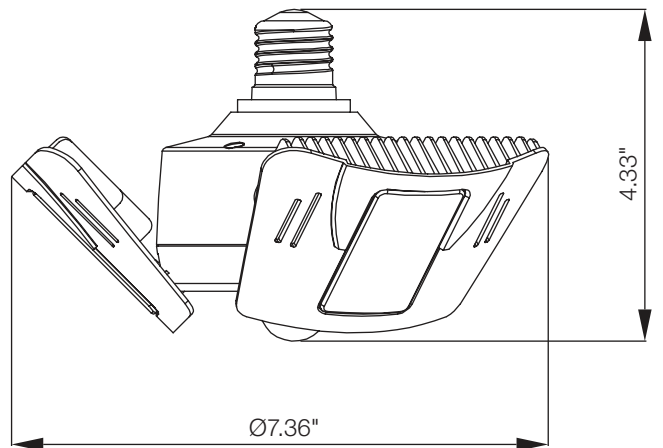

60W LED multi-beam Utility light with and without motion sensor



Item #	Lamp Description	W	V	CRI	Bulb Type	Base Type	CCT	Finish	Lm	Life/ Hrs	UPC	Pk/ Master
S13118	60W/LED/UTL/MB/4000K	60	100-277	80	MULTI-BEAM	E26	4000	White	5880	50,000	045923131189	12
S13119	60W/LED/UTL/MB/4000K/MOTION	60	100-277	80	MULTI-BEAM	E26	4000	White	5880	50,000	045923131196	12

Hi-Pro LED lamps

Third generation, high lumen, omni-directional lamps for industrial and commercial applications

Upgraded Features

- Improved heat sink design with advanced passive heat dissipation
- Reduced size / lighter weight
- Higher efficiency, increased lumen output
- Built-in surge protection on all items
18W – 22W 2.5KV
36W – 54W 4KV
80W – 120W 6KV

Standard Features

- Replaces HID, CFL, and Incandescent
- Direct wire range voltage 100-277V
- Approved for totally enclosed fixtures**
- IP64-Damp location
- 3 CCT options
- High bay/low bay/post top
- DLC listed*
- Long life — 50,000 hours
- 5 Year limited warranty**



High Lumen Industrial/Commercial LED Lamps

Item Number	Lamp Description	Replaces Inc/CFL/HID	W	V	Base Type	CCT	Lm	M.O.L. (Inches)	Life/ Hrs.	UPC	Pk/ Mstr.
S39670	18W/LED/HID/2700K/100-277V/E26	120/32/70	18	100-277	E26	2700K	2340	5.69	50K	045923306709	24
S39390	18W/LED/HID/5000K/100-277V/E26	120/32/70	18	100-277	E26	5000K	2610	5.69	50K	045923303906	24
S39671	22W/LED/HID/2700K/100-277V/E26	150/40/100	22	100-277	E26	2700K	2860	5.95	50K	045923306716	24
S39391	22W/LED/HID/5000K/100-277V/E26	150/40/100	22	100-277	E26	5000K	3080	5.95	50K	045923303913	24
S39672	36W/LED/HID/2700K/100-277V/E26	200/55/150	36	100-277	E26	2700K	4680	7.37	50K	045923306723	12
S39392	36W/LED/HID/5000K/100-277V/E26	200/55/150	36	100-277	E26	5000K	5148	7.37	50K	045923303920	12
S39738	45W/LED/HID/4000K/100-277V E26	300/65/175	45	100-277	E26	4000K	6300	8.51	50K	045923397387	12
S39739	45W/LED/HID/5000K/100-277V E26	300/65/175	45	100-277	E26	5000K	6435	8.51	50K	045923397394	12
S39673*	45W/LED/HID/4000K/100-277V/EX39	300/65/175	45	100-277	EX39	4000K	6300	8.81	50K	045923306730	12
S39393*	45W/LED/HID/5000K/100-277V/EX39	300/65/175	45	100-277	EX39	5000K	6435	8.81	50K	045923303937	12
S39674*	54W/LED/HID/4000K/100-277V/EX39	300/85/250	54	100-277	EX39	4000K	7560	9.01	50K	045923306747	12
S39394*	54W/LED/HID/5000K/100-277V/EX39	300/85/250	54	100-277	EX39	5000K	7722	9.01	50K	045923303944	12
S39675*	80W/LED/HID/4000K/100-277V/EX39	400/100/320	80	100-277	EX39	4000K	11200	8.78	50K	045923306754	4
S39395*	80W/LED/HID/5000K/100-277V/EX39	400/100/320	80	100-277	EX39	5000K	11440	8.78	50K	045923303951	4
S39676*	100W/LED/HID/4000K/100-277V/EX39	500/150/400	100	100-277	EX39	4000K	14000	9.76	50K	045923306761	4
S39396*	100W/LED/HID/5000K/100-277V/EX39	500/150/400	100	100-277	EX39	5000K	14300	9.76	50K	045923303968	4
S39677*	120W/LED/HID/4000K/100-277V/EX39	750/200/600	120	100-277	EX39	4000K	16800	10.35	50K	045923306778	4
S39397*	120W/LED/HID/5000K/100-277V/EX39	750/200/600	120	100-277	EX39	5000K	17160	10.35	50K	045923303975	4

Accessories											
92-406	Mog to Med Socket Reducer for S39390, S39391, S39392, S39670, S39671 and S39672									045923924064	
80-929	Hard Wire Surge Protector									045923809293	

** For minimum compartment size of enclosed fixture visit www.satco.com. Lamp life may vary depending on application and use. See warranty for details.



80-954



80-955



80-956



80-957

Hi-Pro Sensors

Adjustable controls for LED HID replacement lamps.

- Even more energy saving
- Increased functionality
- Simple installation (plug and play)

80-954 Hi-Pro WiFi Module

Features

- Access functions through mobile app, router ECS, etc.
- Dimming and time control
- Support single or group lamp control
- Available voice control: Amazon Echo, Google Home, etc.
- WiFi: 2.4GHz
- OS: Android 4.2 or newer, IOS 8.0 or newer



Specifications

- Operating voltage: 15V DC + 2V
- Current: 20mA
- IP rating: IP20
- WiFi: 2.4GHz
- OS: Android 4.2 or newer, IOS 8.0 or newer
- Operating Temperature: -20°C (+4°F) to +60°C (+140°F)
- Warranty: 5 years



80-956 Hi-Pro Photocell

Features

- Natural light detection
- Reaction lux options: 20 lx, 50 lx, 100 lx, 300 lx
- Adjustable hold time
- Standard 3.5mm Aux port connection



Specifications

- Operating voltage: 15V DC + 2V
- Output voltage: 0-10V
- Current: 20mA
- IP rating: IP20
- Operating Temperature: -20°C (4°F) to +60°C (+140°F)
- Warranty: 5 years

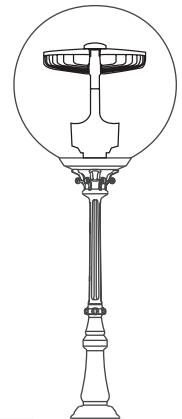
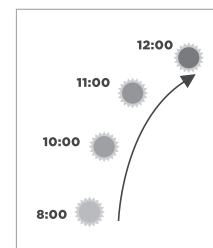
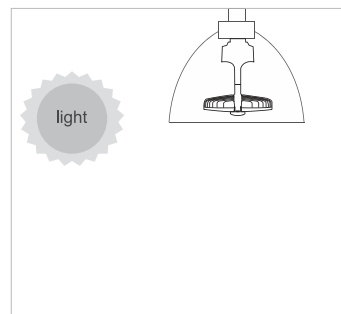
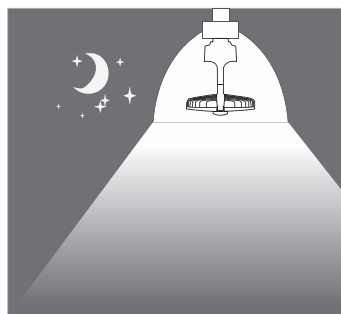

80-955 Hi-Pro Motion Sensor / PIR

Features

- Motion detection area: 6m (19.7')
- Standby bi-level dimming: Off, 20% dim, 40% dim or 60% dim
- Hold time: up to 10 minutes
- Standard 3.5mm Aux port connection
- Not for use in enclosed fixtures

Specifications

- Operating voltage: 15V DC + 2V
- Output voltage: 0-10V
- Current: 20mA
- IP rating: IP20
- Operating Temperature: -20°C (+4°F) to +35°C (+95°F)
- Warranty: 5 years



80-955

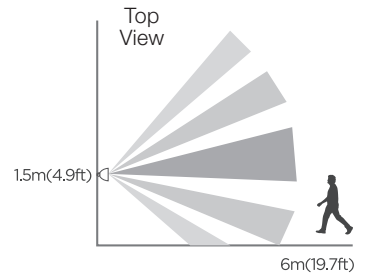
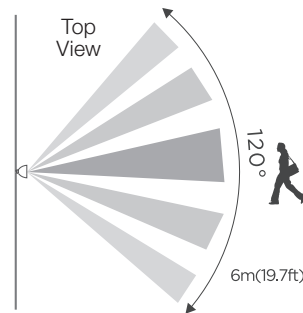
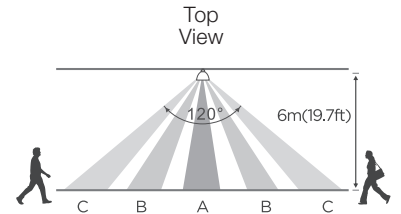

80-957 Hi-Pro Motion Sensor / MW

Features

- Motion detection area: 10m (33')
- Standby bi-level dimming: Off, 20% dim, 40% dim or 60% dim
- Hold time: up to 10 minutes
- Suitable for use in enclosed fixtures (non-metallic)

Specifications

- Operating voltage: 15V DC + 2V
- Output voltage: 0-10V
- Current: 20mA
- IP rating: IP20
- Operating Temperature: -20°C (+4°F) to +60°C (+140°F)
- Warranty: 5 years



80-957

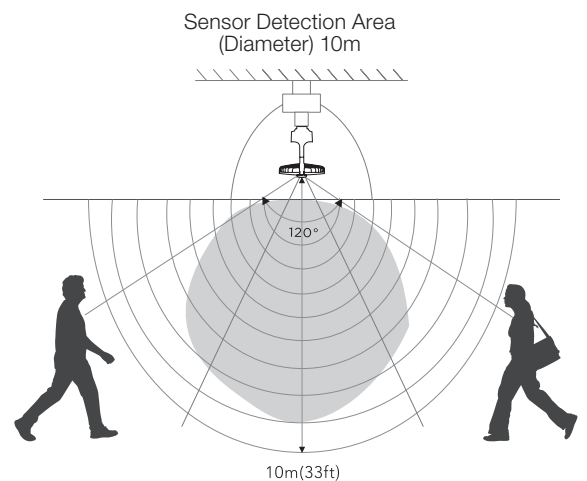



Hi-Pro Sensors

Item #	Description
80-954	Hi-Pro WiFi Module
80-955	Hi-Pro Motion Sensor / PIR
80-956	Hi-Pro Photocell
80-957	Hi-Pro Motion Sensor / MW

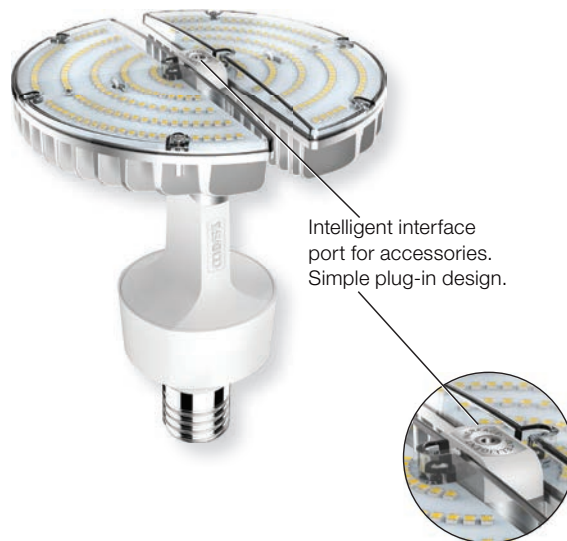

Linear LED T8, T5HO Type C system

Dedicated LED linear lamps and driver system with integral 0-10V dimming.

Applications:

Replacement of existing Linear Fluorescent lamps and ballast commonly found in commercial and industrial sites, and new installations.

Satco Type C systems include:

- Dedicated LED lamp and driver system
- DLC rated for use in utility programs



Note: Fluorescent lamps are not compatible with Type C drivers

Linear LED T8, T5HO Type C system

Features:

- For retrofit and installation in new fixtures
- Driver footprint matches ballast footprint
- High efficiency
- Compatible with instant start wiring
- Low flicker design
- 120-277V, 0-10V Dimming
- 3000, 35000, 4000, 5000K
- 82 CRI
- All glass lamps, damp rated, DLC listed
- Built-in surge protection
- 50,000 hour life
- 5 Year warranty

Linear LED
T8 Type C

Linear LED
T5 Type C



S8012
1-2 Lamp
driver



S8013
3-4 Lamp
driver



S8014
1-2 Lamp
driver



S8015
3-4 Lamp
driver



Linear LED T8 Type C lamps

Item #	Lamp Description	W	CRI	Bulb Type	Base Type	Bm	CCT	Lm	M.O.L. (Inches)	Life/ Hrs.	UPC	M/Case Qty
2FT												
S11930	8T8/LED/24-830/XD	8	82	LED	G13	220°	3000	1200	24.0	50,000	045923119309	25
S11931	8T8/LED/24-835/XD	8	82	LED	G13	220°	3500	1200	24.0	50,000	045923119316	25
S11932	8T8/LED/24-840/XD	8	82	LED	G13	220°	4000	1200	24.0	50,000	045923119323	25
S11933	8T8/LED/24-850/XD	8	82	LED	G13	220°	5000	1200	24.0	50,000	045923119330	25
3FT												
S11934	11T8/LED/36-830/XD	11	82	LED	G13	220°	3000	1600	36.0	50,000	045923119347	25
S11935	11T8/LED/36-835/XD	11	82	LED	G13	220°	3500	1600	36.0	50,000	045923119354	25
S11936	11T8/LED/36-840/XD	11	82	LED	G13	220°	4000	1600	36.0	50,000	045923119361	25
S11937	11T8/LED/36-850/XD	11	82	LED	G13	220°	5000	1600	36.0	50,000	045923119378	25
4FT												
S11938	12T8/LED/48-830/XD	12	82	LED	G13	220°	3000	1800	48.0	50,000	045923119385	25
S11939	12T8/LED/48-835/XD	12	82	LED	G13	220°	3500	1800	48.0	50,000	045923119392	25
S11940	12T8/LED/48-840/XD	12	82	LED	G13	220°	4000	1800	48.0	50,000	045923119408	25
S11941	12T8/LED/48-850/XD	12	82	LED	G13	220°	5000	1800	48.0	50,000	045923119415	25

LED T8 Type C drivers

Item #	Description	Lamps driven	V in	V out	Current in 120V	Current in 277V	Current out 120V, 277V	Freq. input HZ	Power factor 120V	Power factor 277V	Operating temp.	Storage temp.	UPC
S8012	LED driver/ 2', 3', 4'/Type C/T8	1, 2	120-277	24-48	300	130	290	50/60	0.95	0.93	-20° to 55°C	-40° to 85°C	045923090127
S8013	LED driver/ 2', 3', 4'/Type C/T8	3, 4	120-277	24-48	590	230	290	50/60	0.95	0.93	-20° to 55°C	-40° to 85°C	045923090134



Linear LED T5 Type C lamps

Item Number	Lamp Description	W	CRI	Bulb Type	Base Type	Bm	CCT	Lm	M.O.L. (Inches)	Life/ Hrs.	UPC	M/Case Qty
4FT T5												
S11942	23T5/LED/48-835/XD	23	82	LED	G5	220°	3500	3500	48.0	50,000	045923119422	25
S11943	23T5/LED/48-840/XD	23	82	LED	G5	220°	4000	3500	48.0	50,000	045923119439	25
S11944	23T5/LED/48-850/XD	23	82	LED	G5	220°	5000	3500	48.0	50,000	045923119446	25

LED T5 Type C drivers

Item #	Description	Lamps driven	V in	V out	Current in 120V	Current in 277V	Current out 120V, 277V	Freq. input HZ	Power factor 120V	Power factor 277V	Operating temp.	Storage temp.	UPC
S8014	LED driver/4' Type C/T5	1, 2	120-277	30-48	540	240	530	50/60	0.95	0.93	-20° to 55°C	-40° to 85°C	045923080142
S8015	LED driver/4' Type C/T5	3, 4	120-277	30-45	1020	450	530	50/60	0.98	0.96	-20° to 55°C	-40° to 85°C	045923080159

NEW PRODUCT INFORMATION — JANUARY, 2020

Installation

Type C drivers are designed to wire similar to instant start T8 ballasts. This feature keeps installation time to existing sockets to a minimum.

Installation requires removing existing tubes and ballasts and possible replacement of sockets. One driver can power multiple sockets in each fixture.

Satco cannot guarantee LED lamp performance using drivers other than those listed in this publication.

Components included:

- Installation instructions
- LED lamps
- LED drivers
- Luminaire markings (affix to luminaire)

Wiring Instruction - Electronic Ballast

Retrofit luminaire with 2 T8 lamps

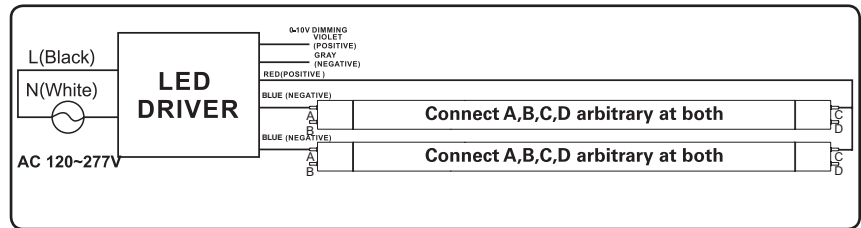

Retrofit luminaire with 2 T5 lamps

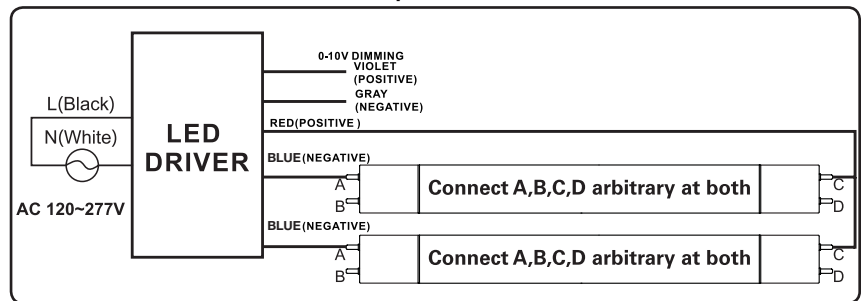

See installation manual for 1, 2, 3 and 4 lamp wiring guides.

System Performance

Item Number	Product Specification	CRI	Bare Lamp Wattage	CCT	Lumens	System Wattage per Lamp				System Efficacy per Lamp	
						Driver: S8012		Driver: S8013		2-Lamp Nominal Efficacy	4-Lamp Nominal Efficacy
S11930, S11931, S11932, S11933	T8-8W-1200lm-2ft	>80	8W	3000K	1150lm	10W	10.5W	10W	10W	115LPW	115LPS
				4000K 5000K	1200lm						
S11934, S11935, S11936, S11937	T8-11W-1600lm-3ft	>80	11W	3000K	1520lm	13.5W	13.5W	13W	13W	113LPW	117LPS
				4000K 5000K	1600lm						
S11938, S11939, S11940, S11941	T8-12W-1800lm-4ft	>80	12W	3000K	1700lm	15W	15W	14.5W	14.5W	113LPW	115LPS
				4000K 5000K	180lm						
						Driver: S8014		Driver: S8015			
S11942, S11932, S11944	T5-23W-3400lm-4ft	>80	23W	3500K	3250lm	27W	27W	25W	25W	120LPW	130LPW
				4000K 5000K	3400lm						



SATCO® | NUVO®

National Toll-Free:
800-43-SATCO
(800-437-2826)
www.satco.com

Copyright © 2020
Satco Products, Inc
All Rights Reserved.
1/20 SA2320



Distribution Centers:

FLORIDA
900 N.W. 159th Dr.
Miami, FL 33169
PH 305-624-2044
FX 305-623-0286

CALIFORNIA
31288 San Benito St.
Hayward, CA 94544
PH 510-487-4822
FX 510-487-8955

WASHINGTON
4710 116th St. S.W.
Mukilteo, WA 98275
PH 425-789-3300
FX 425-789-3310

TEXAS
2000 Valwood Pkwy.
Farmers Branch, TX
75234
PH 972-247-2437
FX 972-247-5408

PUERTO RICO
Campeche St. 23
Julio N. Matos
Industrial Park,
Carolina, PR 00984
PH 787-757-3510
FX 787-757-3540

**Corporate Offices and
Distribution Center:**

NEW YORK
110 Heartland Blvd.
Brentwood, NY 11717
PH 631-243-2022
FX 631-243-2027



LED LAMPS

**COMPLETE
REFERENCE
GUIDE**

AUGUST, 2019

We are pleased to present the latest edition of our LED Lamp Reference Guide. Many new LED lamps and fixtures have been added, and each section is arranged to make finding the right product easy.

Brilliance

Satco is committed to providing unsurpassed quality, service and product assortment. Many of our product categories are supported by merchandising systems, displays and a selection of attention-getting point of purchase materials. These efforts, along with our strategic locations, make Satco the preferred choice for light sources and electrical related products.



Six convenient locations

Contents

About Satco.....	2-5
LED Filament Lamps.....	6-13
Vintage Style LED Filament Lamps.....	14-16
Carded LED Lamps.....	17
Carded LED Specialty Lamps.....	18-19
Omni-Directional LED A19 Lamps.....	20-21
Replacement LED A19 4-Packs.....	22
Omni-Directional LED A19 Lamps Display Packs.....	23
Omni-Directional LED A19 Lamps.....	24
Replacement LED A19 4-Packs.....	25
Omni Directional LED A19 & A21 Lamps.....	26-27
High Lumen LED A21 Lamps.....	28
Decorative LED Lamps.....	29
Omni-Directional 3-Way LED Lamps.....	30
Candelabra Base A19 & Colored LED Lamps.....	31
Omni Directional A15 & Low Voltage A19 LED Lamps.....	32
Decorative & Linear T10 LED Lamps.....	33
LED Reflector Lamps.....	34
LED Reflector Lamps Display Packs.....	35
LED Reflector Lamps.....	36
LED PAR Lamps.....	37-40
High Lumen LED PAR Lamps.....	41-42
LED PAR16 & MR11 Lamps.....	43
MR16 LED Lamps.....	44
MR16 GU10 LED Lamps.....	45
MR16 E26 LED Lamps.....	46
LED Specialty Replacement Lamps.....	47-48
LED Recessed Downlight Retrofits.....	49-54
LED Direct Wire Edge-Lit Downlights.....	55-57
LED Direct Wire Back Lit Downlights.....	58-59
LED Direct Wire Gimbal Downlights.....	60-61
LED Direct Wire Back Lit Downlights.....	62-64
Low Profile LED Downlights.....	65-67
LED Commercial Downlight Retrofits.....	68-69
LED Recessed Downlight Retrofits & Elevator Lamps.....	70
High Lumen LED Lamps.....	71-80
LED High Bay/Low Bay Lamps.....	81
High Lumen LED PAR Lamps.....	82
Instant Hi Bay Fixture.....	83
High Lumen LED Lamps.....	84-85
PL/LED Ballast Bypass Lamps.....	86
LED/CFL Lamps.....	87-89
LED T8 & U-Bend Lamps.....	90
LED T8 Lamps.....	91-97
LED T5 Lamps.....	98-99
LED T8 Lamps.....	100-102
LED T9 Circline Lamps.....	103
LED T8 & T5 Lamps.....	104
LED T8 Sign Lamps.....	105
LED Modules.....	106
Retail Support.....	107-111
Index.....	112-115

Satco has two lines of product to help you meet California's Building and Appliance codes:

Building Code (Title 24):

The full line of Joint Appendix 8 (JA8) lamps are certified to the Title 24 2016 building code. These products will help you comply with the newest California residential building codes.

Appliance Code (Title 20):

Lamps and Retrofit Kits are considered appliances in the California Code, and Title 20 is one of the most stringent in the country. Satco has a full line of products that are compliant with this code.

As an ongoing effort on behalf of Satco Products, Inc. to remain dedicated to the improvement of our products, we reserve the right to change specifications. The information contained in this specification guide is subject to change without notice. We cannot be responsible for typographical errors.

At Satco, our business isn't about us. It's about you and your business.

Satco and our Nuvo® and Hygrade™ brands have grown to be industry leaders by offering you the widest selection of lamps, fixtures and lighting components.

The most innovative technology.

The highest standards of quality and efficiency. And a reputation for service earned one customer at a time for almost 50 years.

Satco. Setting the standards.

With a vast catalog of products built to the highest quality standards, massive inventories, a highly automated nationwide distribution network, and a growing investment in research and development, few lighting manufacturers can match Satco's depth of industry experience.

The widest selection.

Satco keeps homes across North America lit through the thousands of retail outlets we supply with replacements lamps and consumer lighting accessories.

The residential and commercial building trades rely on Satco's comprehensive line of fixtures, track and outdoor lighting and lamps, which are widely available through electrical distributors across the country.

Lighting fixture manufacturers turn to Satco Logistics for on-time shipping of thousands of component parts in orders of any size, including lamps, ballasts, sockets, switches, cords, canopies and glassware of every description.



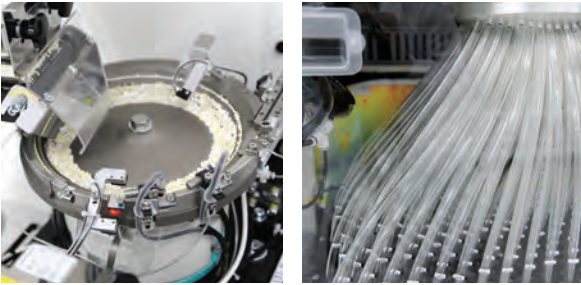

The most innovative technology.

Over the years, Satco's robust R&D programs have moved lighting technology forward with patented innovations that have been widely adopted throughout the industry that includes breaking new ground in the design and manufacture of high-efficiency LED lamps.

The highest quality and efficiency.

Every Satco product is designed, manufactured and tested to meet or exceed the highest industry standards for quality and performance. And we offer hundreds of products that have earned ENERGY STAR® certification. In fact, we were selected ENERGY STAR® Partner of the Year in 2009.

Over a million square feet of warehouse space.

The Satco brand has stood for quality, innovation and value in lighting products since 1966. From a 3,000 square foot warehouse in Elmont, NY, to more than 1.2 million square feet of U.S. Distribution space today. To be certain you'll have the parts you need where you need them, Satco maintains enormous amounts of inventories at our major distribution and sales centers.

Satco Distribution Centers

- New York
- Florida
- Texas
- California
- Washington
- Puerto Rico

Satco Express Stocking Locations

- | | |
|------------------|-----------------------|
| • Charlotte, NC | • Lavergne, TX |
| • Chicago, IL | • Phoenix, AZ |
| • Cincinnati, OH | • Ringland, MS |
| • Cleveland, OH | • Syracuse, NY |
| • Denver, CO | • British Columbia CN |
| • La Mirada, CA | • Mississauga CN |

Satco. An innovative family of brands.

LED lamps that only experience can deliver.

With one of the industry's largest R&D programs behind it, Satco is producing LED replacement lamps that meet all of the newest efficiency standards – and exceed user expectations for light output, color temperature, beam pattern, diffusion, and overall reliability.



Hygrade. The leader in commercial lighting.

Hygrade has been a trusted name in commercial and industrial lighting for more than a century. From fluorescent and compact fluorescent lamps to high intensity discharge bulbs of every description, Hygrade offers a variety of cost effective, energy efficient products for virtually any commercial application.



Nuvo. Inspired designs. Enlightened engineering.

Nuvo Lighting was launched in 2005 with more than 1,500 new lighting fixtures – one of the largest catalogs of any manufacturer – and our product line has continued to grow every year since. Today offering more than 3,000 chandeliers, pendants and sconces in designs that range from classic to contemporary, from elegant to understated and from simple to stylish.



LED FILAMENT LAMPS

LED filament lamps

- LED with a traditional incandescent look and feel
- Omni-directional light source
- Dimmable
- Damp location
- Approved for totally enclosed fixtures**
- c-UL-us listed
- CEC T120/T24 Available
- ENERGY STAR certified*
- 3 Year warranty



S29874
A15

S21102
A15

S8550
A15



LED Filament Lamps - A15 - 40W Replacement

Item Number	Lamp Description	W	Bulb Type	Base	V	Finish	CCT	Lm	CRI	M.O.L. (Inches)	Life/Hrs.	UPC	Pack
S29874*	5A15/CL/LED/E26/27K/ES/120V	5	A15	E26	120	Clear	2700K	450	80	3 3/8	15K	045923298745	24/6
S21100	5A15/CL/LED/E26/3K/ES/120V	5	A15	E26	120	Clear	3000K	450	80	3 3/8	15K	045923200021	24/6
S21101	5A15/CL/LED/E26/4K/ES/120V	5	A15	E26	120	Clear	4000K	450	80	3 3/8	15K	045923200038	24/6
S21102	5A15/FR/LED/E26/3K/ES/120V	5	A15	E26	120	Frost	3000K	450	80	3 3/8	15K	045923200045	24/6
90 CRI—CEC/T20													
S8550*	5A15/CL/LED/E26/27K/120V	5	A15	E26	120	Clear	2700K	450	90	3 3/8	15K	045923085505	24/6

Product sheet SA1980-2



S29875
A19

S29824
A19



LED Filament Lamps - A19 - 40W Replacement

Item Number	Lamp Description	W	Bulb Type	Base	V	Finish	CCT	Lm	CRI	M.O.L. (Inches)	Life/Hrs.	UPC	Pack
S29875*	5A19/CL/LED/E26/27K/ES/120V	5	A19	E26	120	Clear	2700K	450	80	4 1/8	15K	045923298752	24/6
S21103	5A19/CL/LED/E26/3K/ES/120V	5	A19	E26	120	Clear	3000K	450	80	4 1/8	15K	045923200052	24/6
S29824	5A19/SW/LED/E26/27K/ES/120V	5	A19	E26	120	Soft White	2700K	450	80	4 1/8	15K	045923298240	24/6
S21104	5A19/SW/LED/E26/3K/ES/120V	5	A19	E26	120	Soft White	3000K	450	80	4 1/8	15K	045923201042	24/6

Product sheet SA1980-2

LED FILAMENT LAMPS



S29876, S29894, S28850,
S29879
A19

S39825, S39809
A19

S9826
A19



LED Filament Lamps - A19 - 60W Replacement

Item Number	Lamp Description	W	Bulb Type	Base	V	Finish	CCT	Lm	CRI	M.O.L. (Inches)	Life/ Hrs.	UPC	Pack
S29876*	7A19/CL/LED/E26/27K/ES/120V	7	A19	E26	120	Clear	2700K	800	80	4 1/8	15K	045923298769	24/6
S29894	7A19/CL/LED/E26/3K/ES/120V	7	A19	E26	120	Clear	3000K	800	80	4 1/8	15K	045923298943	24/6
S28850*	7A19/CL/LED/E26/4K/ES/120V	7	A19	E26	120	Clear	4000K	800	80	4 1/8	15K	045923288500	24/6
S39825*	7.5A19/SW/LED/E26/27K/120V	7.5	A19	E26	120	Soft White	2700K	800	80	4 1/8	15K	045923398254	24/6
S39809	7.5A19/SW/LED/E26/3K/120V	7.5	A19	E26	120	Soft White	3000K	800	80	4 1/8	15K	045923398094	24/6
S9826†	6.5A19/SLV/LED/E26/27K/120V	6.5	A19	E26	120	Silver Crown	2700K	650	80	4 1/8	15K	045923098260	24/6

90 CRI—CEC/T20

S29879*■	8A19/CL/LED/E26/27K/90CRI	8	A19	E26	120	Clear	2700K	800	80	4	15K	045923298790	24/6
----------	---------------------------	---	-----	-----	-----	-------	-------	-----	----	---	-----	--------------	------

■ Also T24 compliant. † Silver crown are 180° beam angle.

Product sheet SA1980-2



S9845, S9846
A19



LED Filament Lamps - A19 - 75W Replacement

Item Number	Lamp Description	W	Bulb Type	Base	V	Finish	CCT	Lm	CRI	M.O.L. (Inches)	Life/ Hrs.	UPC	Pack
S9845	9A19/CL/LED/E26/27K/120V	9	A19	E26	120	Clear	2700K	1100	80	4 1/2	15K	045923098451	24/6
S9846	9A19/CL/LED/E26/30K/120V	9	A19	E26	120	Clear	3000K	1100	80	4 1/2	15K	045923098468	24/6

Product sheets SA1980-2, SA2251

LED Filament Lamp Multi-Packs

Item Number	Lamp Description	W	Bulb Type	Base	V	Finish	CCT	Lm	CRI	M.O.L. (Inches)	Life/ Hrs.	UPC	Pack
S21712*	5A19/CL/LED/E26/27K/120V/4PK	5	A19	E26	120	Clear	2700K	450	80	4 1/8	15K	045923217128	12-4pks
S21713*	7.5A19/CL/LED/E26/27K/120V/4PK	7.5	A19	E26	120	Clear	2700K	800	80	4 1/8	15K	045923217135	12-4pks
S21714*	7.5A19/SW/LED/E26/27K/120V/4PK	7.5	A19	E26	120	Soft White	2700K	800	80	4 1/8	15K	045923217142	12-4pks

Product sheet SA1980-2

**See warranty for details.

LED FILAMENT LAMPS

LED filament lamps

- LED with a traditional incandescent look and feel
- Omni-directional light source
- Dimmable
- Damp location
- Approved for totally enclosed fixtures**
- c-UL-us listed
- CEC T120/T24 Available
- ENERGY STAR certified*
- 3 Year warranty



S9870, S29871,
S9988, S8553
G16 1/2



S12101
G16



S12102, S12103,
S12104
G16



S12105
G16



LED Globe Filament Lamps - G16.5

Item Number	Lamp Description	W	Bulb Type	Base	V	Finish	CCT	Lm	CRI	M.O.L. (Inches)	Life/ Hrs.	UPC	Pack
25W Replacement													
S9870	2.5G16.5/LED/CL/27K/120V	2.5	G16 1/2	E12	120	Clear	2700K	200	80	3 3/16	15K	045923098703	24/6
40W Replacement													
S29871*	4G16.5/LED/CL/27K/120V	4	G16 1/2	E12	120	Clear	2700K	350	80	3 3/16	15K	045923298714	24/6
60W Replacement													
S9988*	5.5G16.5/LED/CL/27K/120V/E12	5.5	G16 1/2	E12	120	Clear	2700K	500	80	3 1/8	15K	045923099885	24/6
S12100*	5.5G16.5/LED/CL/3K/120V/E12	5.5	G16 1/2	E12	120	Clear	3000K	500	80	3 1/8	15K	045923121005	24/6
S12101*	5.5G16.5/LED/SW/3K/120V/E12	5.5	G16 1/2	E12	120	Soft White	3000K	500	80	3 1/8	15K	045923121012	24/6
S12102*	5.5G16.5/LED/CL/27K/120V/E26	5.5	G16 1/2	E26	120	Clear	2700K	500	80	3 1/8	15K	045923121029	24/6
S12103*	5.5G16.5/LED/CL/3K/120V/E26	5.5	G16 1/2	E26	120	Clear	3000K	500	80	3 1/8	15K	045923121036	24/6
S12104*	5.5G16.5/LED/CL/4K/120V/E26	5.5	G16 1/2	E26	120	Clear	4000K	500	80	3 1/8	15K	045923121043	24/6
S12105*	5.5G16.5/LED/SW/3K/120V/E26	5.5	G16 1/2	E26	120	Soft White	3000K	500	80	3 1/8	15K	045923121050	24/6
90 CRI – CEC/T20													
S8553*	4.5G16.5/LED/CL/27K/120V/E12	4.5	G16 1/2	E12	120	Clear	2700K	350	90	3 3/16	15K	045923085536	24/6

Product sheet SA1980-2

LED FILAMENT LAMPS



S29563, S9893, S8849,
S12106, S9564, S12110
G25

S9827, S12107,
S12108, S12109
G25

S9828
G25



LED Globe Filament Lamps - G25

Item Number	Lamp Description	W	Bulb Type	Base	V	Finish	CCT	Lm	CRI	M.O.L. (Inches)	Life/ Hrs.	UPC	Pack
40 Watt Replacement													
S29563*	4.5G25/CL/LED/E26/27K/120V	4.5	G25	E26	120	Clear	2700K	450	80	4 3/8	20K	045923295638	24/6
S9893*	4.5G25/CL/LED/E26/30K/120V	4.5	G25	E26	120	Clear	3000K	450	80	4 3/8	15K	045923098932	24/6
S8849*	4.5G25/CL/LED/E26/40K/120V	4.5	G25	E26	120	Clear	4000K	450	80	4 3/8	15K	045923088490	24/6
S12106	4.5G25/CL/LED/E26/5K/120V	4.5	G25	E26	120	Clear	5000K	450	80	4 1/2	15K	045923121067	24/6
S9827*	4.5G25/SW/LED/E26/27K/120V	4.5	G25	E26	120	Soft White	2700K	430	80	4 3/8	15K	045923098277	24/6
S12107	4.5G25/SW/LED/E26/3K/120V	4.5	G25	E26	120	Soft White	3000K	420	80	4 1/2	15K	045923121074	24/6
S9828†	4.5G25/SLV/LED/E26/27K/120V	4.5	G25	E26	120	Silver Crown	2700K	430	80	4 3/8	15K	045923098284	24/6
60 Watt Replacement													
S9564*	6.5G25/CL/LED/E26/27K/120V	6.5	G25	E26	120	Clear	2700K	810	80	4 3/8	15K	045923095641	24/6
S12110	6.5G25/CL/LED/E26/3K/120V	6.5	G25	E26	120	Clear	3000K	810	80	4 1/2	15K	045923121104	24/6
S12108	6.5G25/SW/LED/E26/27K/120V	6.5	G25	E26	120	Soft White	2700K	650	80	4 1/2	15K	045923121081	24/6
S12109	6.5G25/SW/LED/E26/3K/120V	6.5	G25	E26	120	Soft White	3000K	650	80	4 1/2	15K	045923121098	24/6
90 CRI—CEC/T20													
S29878*■	5.5G25/CL/LED/E26/27K/90CRI	5.5	G25	E26	120	Clear	2700K	500	90	4 3/8	15K	045923298783	24/6

† Silver crown are 180° beam angle. ■ Also T24 compliant.

Product sheet SA1980-2

**See warranty for details.

LED FILAMENT LAMPS

LED filament lamps

- LED with a traditional incandescent look and feel
- Omni-directional light source
- Dimmable
- Damp location
- Approved for totally enclosed fixtures**
- c-UL-us listed
- CEC T120/T24 Available
- ENERGY STAR certified*
- 3 Year warranty



S12112, S12113
G40



S9565, S9566,
S12111
G40

LED Globe Filament Lamps - G40



Item Number	Lamp Description	W	Bulb Type	Base	V	Finish	CCT	Lm	CRI	M.O.L. (Inches)	Life/Hrs.	UPC	Pack
40 Watt Replacement													
S9565	4.5G40/CL/LED/E26/27K/120V	4.5	G40	E26	120	Clear	2700K	450	80	6 ½	15K	045923095658	12
60 Watt Replacement													
S9566	6.5G40/CL/LED/E26/27K/120V	6.5	G40	E26	120	Clear	2700K	800	80	6 ½	15K	045923095665	12
S12111	6.5G40/CL/LED/E26/3K/120V	6.5	G40	E26	120	Clear	3000K	810	80	6 ½	15K	045923121111	12
S12112	6.5G40/SW/LED/E26/27K/120V	6.5	G40	E26	120	Soft White	2700K	650	80	6 ½	15K	045923121128	12
S12113	6.5G40/SW/LED/E26/3K/120V	6.5	G40	E26	120	Soft White	3000K	650	80	6 ½	15K	045923121135	12

LED FILAMENT LAMPS



S29877, S29866, S29920, S29922, S29890, S8839, S9960, S9961, S21708
C11/B11

S9570
C11

S9868
C11

LED Decorative Filament Lamps - Candelabra Base - Torpedo Shape



Item Number	Lamp Description	W	Bulb Type	Base	V	Finish	CCT	Lm	CRI	M.O.L. (Inches)	Life/Hrs.	UPC	Pack
25 Watt Replacement													
S29920*	2.5W CTC/LED/CL/27K/120V	2.5	C11	E12	120	Clear	2700K	200	80	3 7/8	15K	045923299209	24/6
40 Watt Replacement													
S9868	3.5CTF/LED/FR/27K/120V	3.5	C11	E12	120	Frosted	2700K	350	80	4 5/16	15K	045923098680	24/6
S29922*	4W CTC/LED/27K/CL/120V	4	C11	E12	120	Clear	2700K	350	80	3 7/8	15K	045923299223	24/6
S29890*	4W CTC/LED/30K/CL/120V	4	C11	E12	120	Clear	3000K	350	80	3 7/8	15K	045923298905	24/6
S8839	4W CTC/LED/40K/CL/120V	4	C11	E12	120	Clear	4000K	350	80	3 7/8	15K	045923088391	24/6
S29866*	4W CTC/LED/50K/CL/120V	4	C11	E12	120	Clear	5000K	350	80	4 5/16	15K	045923298660	24/6
S9570*	4.5W CTC/LED/27K/120V	4.5	C11	E12	120	Clear	2700K	450	80	4 5/16	20K	045923095702	24/6
60 Watt Replacement													
S9960*	5.5W CTC/LED/27K/CL/120V	5.5	C11	E12	120	Clear	2700K	500	80	3 7/8	15K	045923099601	24/6
S9961*	5.5W CTC/LED/30K/CL/120V	5.5	C11	E12	120	Clear	3000K	500	80	3 7/8	15K	045923099618	24/6
S9964*	5.5W ETC/LED/27K/CL/120V	5.5	C11	E26	120	Clear	2700K	500	80	3 1/2	15K	045923099649	24/6
Multi-Packs													
S21708	4.5W CTC/LED/27K/CL/120V/3PK	4.5	B11	E12	120	Clear	2700K	350	80	3 7/8	15K	045923217081	12-3pks
90 CRI—CEC/T20													
S29877*	4.5W CTC/LED/27K/CL	4.5	B10	E12	120	Clear	2700K	350	90	3 5/8	15K	045923098772	24/6

■ Also T24 compliant.

Product sheet SA1980-2



C11/B11

LED Decorative Filament Lamps - Medium Base - Torpedo Shape



Item Number	Lamp Description	W	Bulb Type	Base	V	Finish	CCT	Lm	CRI	M.O.L. (Inches)	Life/Hrs.	UPC	Pack
25 Watt Replacement													
S9567*	2.5W ETC/LED/27K/120V	2.5	C11	E26	120	Clear	2700K	250	80	3 1/2	25K	045923095672	24/6
40 Watt Replacement													
S9569*	4.5W ETC/LED/27K/120V	4.5	C11	E26	120	Clear	2700K	450	80	3 1/2	15K	045923095696	24/6
60 Watt Replacement													
S9964*	5.5W ETC/LED/27K/CL/120V	5.5	C11	E26	120	Clear	2700K	500	80	3 1/2	15K	045923099649	24/6
Multi-Packs													
S21709	4.5W ETC/LED/27K/CL/120V/3PK	4.5	B11	E26	120	Clear	2700K	350	80	3 7/8	15K	045923217098	12-3pks
90 CRI—CEC/T20													
S8551*	4W ETC/LED/27K/CL/120V	4	B11	E26	120	Clear	2700K	350	90	3 1/2	15K	045923085512	24/6

Product sheet SA1980-2

**See warranty for details.

LED FILAMENT LAMPS

LED filament lamps

- LED with a traditional incandescent look and feel
- Omni-directional light source
- Dimmable
- Damp location
- Approved for totally enclosed fixtures**
- c-UL-us listed
- CEC T120/T24 Available
- ENERGY STAR certified*
- 3 Year warranty



S29867, S29921, S29923,
S29891, S8840, S9962,
S9963, S8552
CA11

S9869
CA11

S9574
CA11



LED Decorative Filament Lamps - Candelabra Base - Flame Tip

Item Number	Lamp Description	W	Bulb Type	Base	V	Finish	CCT	Lm	CRI	M.O.L. (Inches)	Life/ Hrs.	UPC	Pack
25 Watt Replacement													
S29921*	2.5W CFC/LED/CL/27K/120V	2.5	CA11	E12	120	Clear	2700K	200	80	4 1/16	15K	045923299216	24/6
40 Watt Replacement													
S9869	3.5CFF/LED/FR/27K/120V	3.5	CA11	E12	120	Frosted	2700K	350	80	5	15K	045923098697	24/6
S29923*	4W CFC/LED/27K/CL/120V	4	CA11	E12	120	Clear	2700K	350	80	4 1/16	15K	045923299230	24/6
S29891*	4W CFC/LED/30K/CL/120V	4	CA11	E12	120	Clear	3000K	350	80	4 1/16	15K	045923298912	24/6
S8840*	4W CFC/LED/40K/CL/120V	4	CA11	E12	120	Clear	4000K	350	80	4 1/16	15K	045923088407	24/6
S29867*	4W CFC/LED/50K/CL/120V	4	CA11	E12	120	Clear	5000K	350	80	5	15K	045923298677	24/6
S9574	4.5W CFC/LED/27K/120V	4.5	CA11	E12	120	Clear	2700K	450	80	5	15K	045923095740	24/6
60 Watt Replacement													
S9962*	5.5W CFC/LED/27K/CL/120V	5.5	CA11	E12	120	Clear	2700K	500	80	4 1/16	15K	045923099625	24/6
S9963*	5.5W CFC/LED/30K/CL/120V	5.5	CA11	E12	120	Clear	3000K	500	80	4 1/16	15K	045923099632	24/6
90 CRI—CEC/T20													
S8552*	4.5W CFC/LED/27K/CL/120V	4.5	CA10	E12	120	Clear	2700K	350	90	4 1/16	15K	045923085529	24/6

Product sheet SA1980-2



S9571, S9965
CA11

LED Decorative Filament Lamps - Medium Base - Flame Tip



Item Number	Lamp Description	W	Bulb Type	Base	V	Finish	CCT	Lm	CRI	M.O.L. (Inches)	Life/ Hrs.	UPC	Pack
25 Watt Replacement													
S9571	2.5W EFC/LED/27K/120V	2.5	CA11	E26	120	Clear	2700K	250	80	4 5/16	15K	045923095719	24/6
60 Watt Replacement													
S9965*	5.5W EFC/LED/27K/CL/120V	5.5	CA11	E26	120	Clear	2700K	500	80	4 5/16	15K	045923099656	24/6

Product sheet SA1980-2

LED FILAMENT LAMPS

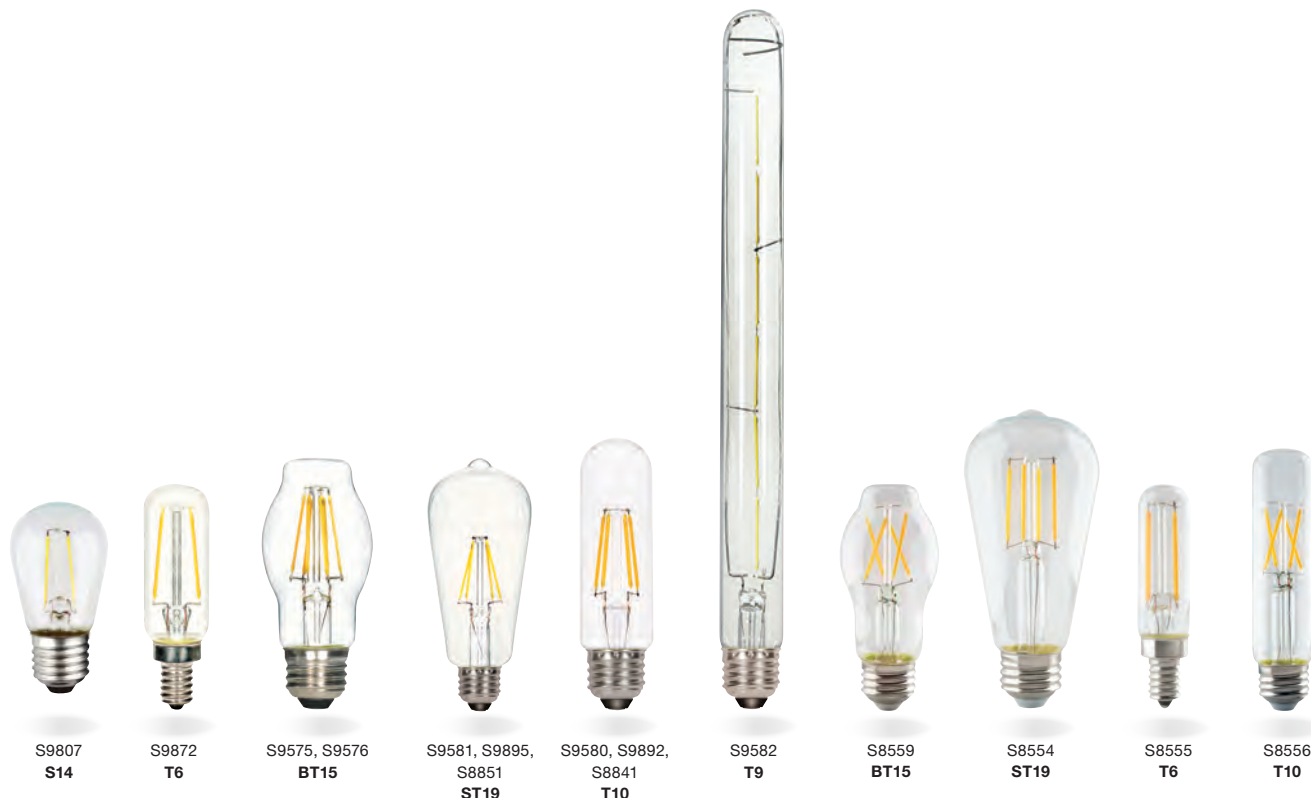

LED Specialty Filament Lamps



Item Number	Lamp Description	W	Bulb Type	Base	V	Finish	CCT	Lm	CRI	M.O.L. (Inches)	Life/ Hrs.	UPC	Pack
S9807	1WS14/LED/CL/27K/120V/ND	1	S14	E26	120	Clear	2700K	100	80	1 3/4	15K	045923098079	24/12
S9872	2.5T6/LED/CL/27K/E12/120V	2.5	T6	E12	120	Clear	2700K	200	80	3 3/16	15K	045923098727	24/6
S9575	4.5BT15/CL/LED/E26/27K/120V	4.5	BT15	E26	120	Clear	2700K	450	80	4 1/8	15K	045923095757	24/6
S9576	6.5BT15/CL/LED/E26/27K/120V	6.5	BT15	E26	120	Clear	2700K	800	80	4 1/8	15K	045923095764	24/6
S9581	6.5ST19/CL/LED/E26/27K/120V	6.5	ST19	E26	120	Clear	2700K	810	80	5 1/2	15K	045923095818	24/6
S9895	6.5ST19/CL/LED/E26/30K/120V	6.5	ST19	E26	120	Clear	3000K	810	80	5 1/2	15K	045923098956	24/6
S8851	6.5ST19/CL/LED/E26/40K/120V	6.5	ST19	E26	120	Clear	4000K	810	80	5 1/2	15K	045923088513	24/6
S9580	4.5T10/LED/E26/27K/120V	4.5	T10	E26	120	Clear	2700K	430	80	5	15K	045923095801	24/6
S9892	4.5T10/LED/E26/30K/120V	4.5	T10	E26	120	Clear	3000K	430	80	5	15K	045923098925	24/6
S8841	4.5T10/LED/E26/40K/120V	4.5	T10	E26	120	Clear	4000K	450	80	5	15K	045923088414	24/6
S9582	6.5T9/CL/LED/E26/27K/120V	6.5	T9	E26	120	Clear	2700K	800	80	12	15K	045923095825	24/6
90 CRI—CEC/T20													
S8559	5.5BT15/CL/LED/E26/27K/120V	5.5	BT15	E26	120	Clear	2700K	550	90	3 3/8	15K	045923085598	24/6
S8554*	5.5ST19/CL/LED/E26/27K/120V	5.5	ST19	E26	120	Clear	2700K	500	90	5 1/2	15K	045923085543	24/6
S8555*	2.5T6/LED/CL/27K/E12/120V	2.5	T6	E12	120	Clear	2700K	180	90	3 3/16	15K	045923085550	24/6
S8556	4T10/LED/E26/27K/120V	4	T10	E26	120	Clear	2700K	350	90	5	15K	045923085567	24/6

Product sheet SA1980-2

**See warranty for details.

SATCO | **NUVO**

www.satco.com

VINTAGE STYLE LED FILAMENT LAMPS

Vintage style LED filament lamps

- LED with a traditional vintage look and feel
- Amber finish
- Omni-directional light source
- Dimmable
- 2000K - warm tone color temperature
- Replaces up to 60 Watt lamps
- Damp location
- Approved for totally enclosed fixtures**
- c-UL-us listed
- Long life—15,000 hours
- 3 Year warranty

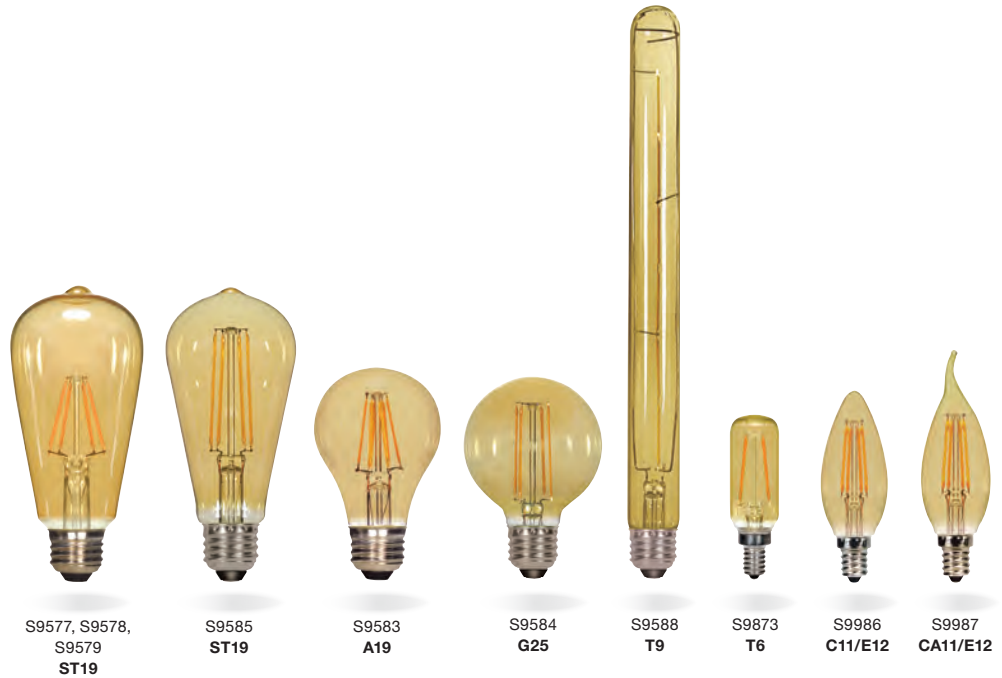

Vintage Style LED Filament Lamps



Item Number	Lamp Description	W	Bulb Type	Base	V	Finish	CCT	Lm	CRI	M.O.L. (Inches)	Life/Hrs.	UPC	Pack
ST19													
S9577	2.5ST19/AMB/LED/E26/2K/120V	2.5	ST19	E26	120	Amber	2000K	220	80	5 3/8	15K	045923095771	24/6
S9578	4.5ST19/AMB/LED/E26/2K/120V	4.5	ST19	E26	120	Amber	2000K	400	80	5 3/8	15K	045923095788	24/6
S9579	6.5ST19/AMB/LED/E26/2K/120V	6.5	ST19	E26	120	Amber	2000K	650	80	5 3/8	15K	045923095795	24/6
S9585	4.5ST19LONG/AMB/LED/E26/2K/120V	4.5	ST19	E26	120	Amber	2000K	380	80	5 1/2	15K	045923095856	24/6
A19													
S9583	4.5A19/AMB/LED/E26/2K/120V	4.5	A19	E26	120	Amber	2000K	380	80	4 1/8	15K	045923095832	24/6
G25													
S9584	4.5G25/AMB/LED/E26/2K/120V	4.5	G25	E26	120	Amber	2000K	380	80	4 3/8	15K	045923095849	24/6
T9													
S9588	6.5T9/AMB/LED/E26/2K/120V	6.5	T9	E26	120	Amber	2000K	620	80	12	15K	045923095887	24/6
T6													
S9873	2.5T6/AMB/LED/E12/2K/120V	2.5	T6	E12	120	Amber	2000K	150	80	3 3/16	15K	045923098734	24/6
C11													
S9986	3.5CTA/AMB/LED/2K/120V	3.5	C11	E12	120	Amber	2000K	300	80	4 5/16	15K	045923099861	24/6
CA11													
S9987	3.5CFA/AMB/LED/2K/120V	3.5	CA11	E12	120	Amber	2000K	300	80	5	15K	045923099878	24/6

Product sheets SA1980-2, SA1919

VINTAGE STYLE LED SPIRAL FILAMENT LAMPS

Vintage style LED spiral filament lamps

- LED with a traditional vintage look and feel
- Amber finish
- Omni-directional light source
- Dimmable
- 2000K - warm tone color temperature
- Replaces up to 60 Watt lamps
- Damp location
- Approved for totally enclosed fixtures**
- c-UL-us listed
- Long life—15,000 hours
- 3 Year warranty

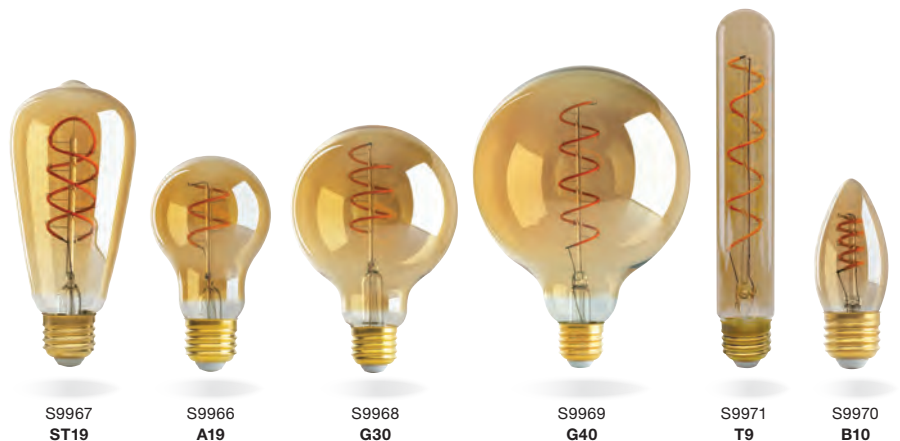

Vintage Style LED Spiral Filament Lamps



Item Number	Lamp Description	W	Bulb Type	Base	V	Finish	CCT	Lm	CRI	M.O.L. (Inches)	Life/ Hrs.	UPC	Pack
ST19													
S9967	4ST19/SPIRAL/LED/AMB/120V	4	ST19	E26	120	Amber	2000K	240	80	5 ¼	15K	045923099670	24/6
A19													
S9966	4A19/SPIRAL/LED/AMB/120V	4	A19	E26	120	Amber	2000K	220	80	4 ¼	15K	045923099663	24/6
G30													
S9968	4G30/SPIRAL/LED/AMB/120V	4	G30	E26	120	Amber	2000K	240	80	5 ⅞	15K	045923099687	24/6
G40													
S9969	4G40/SPIRAL/LED/AMB/120V	4	G40	E26	120	Amber	2000K	240	80	6 ⅞	15K	045923099694	24/6
T9													
S9971	4T9/SPIRAL/LED/AMB/120V	4	T9	E26	120	Amber	2000K	240	80	7 ⅞	15K	045923099717	24/6
B10													
S9970	2ETC/SPIRAL/LED/AMB/120V	2	B10	E26	120	Amber	2000K	90	80	3 ½	15K	045923099700	24/6

Product sheets SA1980-2, SA2228

**See warranty for details.

VINTAGE FILAMENT LED LAMPS

Vintage LED filament lamps in HID envelopes

Classic, warm glow and ambiance on an impressive scale.

- Restaurants
- Hotels
- Retail
- Restoration projects
- Themed venues
- Uses only 4 Watts
- Impressive size and presence
- Perfect for pendant fixtures and hanging sockets
- Approved for totally enclosed fixtures**
- Unique LED spiral filament
- Omni-directional light source
- Dimmable
- Wet location
- 2150K
- T24, BT38, BT56 and PS52 shapes
- E26 base
- Long life—25,000 hours
- 3 Year warranty

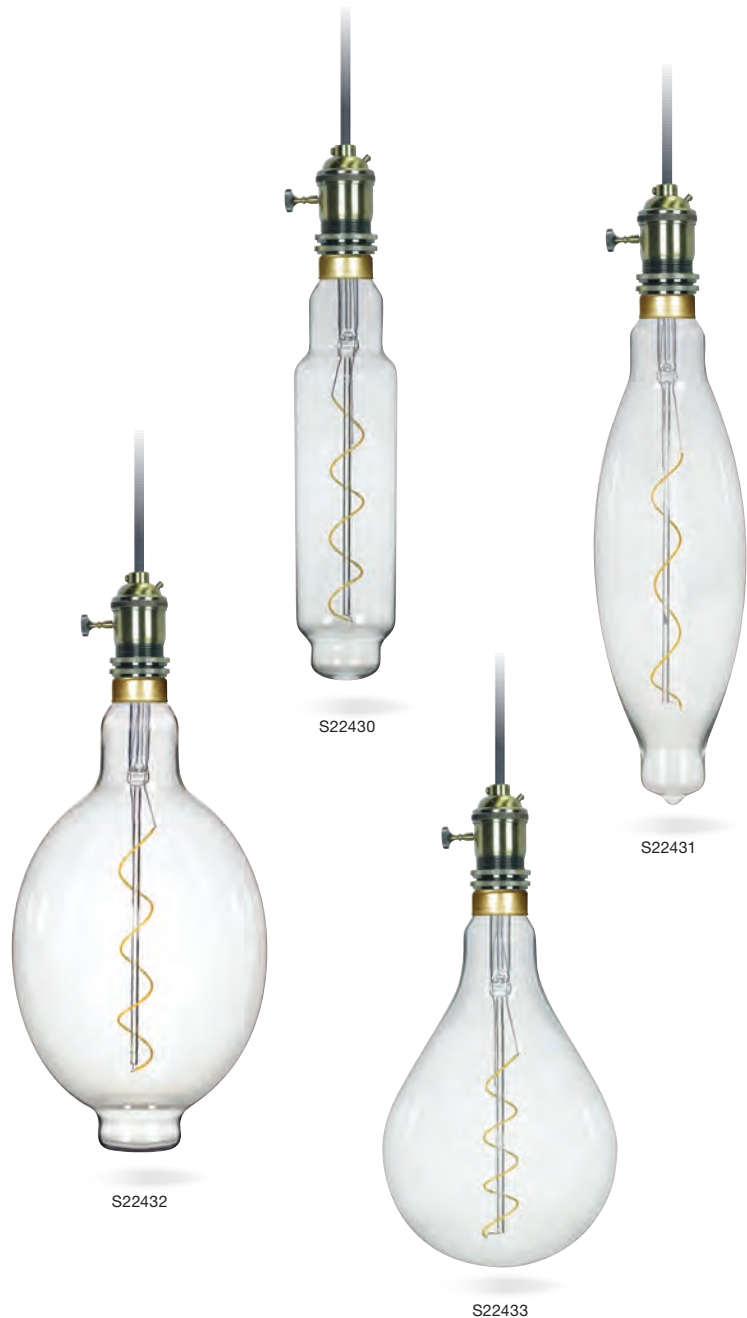

Spiral Filament LED Lamps in HID Envelopes



Item Number	Lamp Description	W	V	Bulb Type	Base Type	CCT	Lm	Finish	M.O.L. (Inches)	Life/Hrs.	UPC	Pack/Master
S22430	4T24/LED/CLEAR/E26/VINTAGE/120V	4	120	T24	E26	2150K	200	Clear	13	25K	045923224300	12
S22431	4BT38/LED/CLEAR/E26/VINTAGE/120V	4	120	BT38	E26	2150K	200	Clear	16 ½	25K	045923224317	12
S22432	4BT56/LED/CLEAR/E26/VINTAGE/120V	4	120	BT56	E26	2150K	200	Clear	13 13/16	25K	045923224324	6
S22433	4PS52/LED/CLEAR/E26/VINTAGE/120V	4	120	PS52	E26	2150K	200	Clear	11 13/16	25K	045923224331	6

Carded LED filament lamps

- General purpose
- Vintage style
- Miniatures
- Decorative
- Direct replacements for incandescent lamps
- LED replacements use 80% less energy
- Carded for peg board displays
- Tray packs for shelf merchandising
- Approved for totally enclosed fixtures**
- ENERGY STAR certified*
- Long life—15,000 hours
- 3 Year warranty



S21711, S8615
A15

S8616
A19

S8609, S21701, S21703, S21706
C11

S8610, S28614
CA11

S8611, S8612
ST19



Blister Carded
For boxed versions of these lamps, see pages 10-14.

Carded LED Lamps



Item Number	Lamp Description	W	Bulb Type	Base	V	Finish	CCT	Lm	Life/Hrs.	UPC	Cards
A15											
S8615*	4.5A15/CL/LED/E26/27K/ES/120V	4.5	A15	E26	120	Clear	2700K	450	15K	045923086151	12/1
S21710*	5.5A15/LED/2700K/E12/120V/2-CD	5.5	A15	E12	120	Clear	2700K	450	15K	045923217104	12-2pks
S21711*	5.5A15/LED/2700K/E26/120V/2-CD	5.5	A15	E26	120	Clear	2700K	450	15K	045923217111	12-2pks
A19											
S8616*	7A19/CL/LED/E26/27K/ES/120V	7	A19	E26	120	Clear	2700K	810	15K	045923086168	12/1
B11											
S21700*	2.5W CTC/LED/27K/CL/120V/2-CD	2.5	B11	E12	120	Clear	2700K	180	15K	045923217005	12-2pks
S21701*	2.5W ETC/LED/27K/CL/120V/2-CD	2.5	B11	E26	120	Clear	2700K	180	15K	045923217012	12-2pks
S21702*	4.5W CTC/LED/27K/CL/120V/2-CD	4.5	B11	E12	120	Clear	2700K	350	15K	045923217029	12-2pks
S21703*	4.5W ETC/LED/27K/CL/120V/2-CD	4.5	B11	E26	120	Clear	2700K	350	15K	045923217036	12-2pks
S21704*	4.5W CTF/LED/27K/CL/120V/2-CD	4.5	B11	E12	120	Frosted	2700K	330	15K	045923217043	12-2pks
S21705*	4.5W ETF/LED/27K/CL/120V/2-CD	4.5	B11	E26	120	Frosted	2700K	330	15K	045923217050	12-2pks
S21706*	5.5W CTC/LED/27K/CL/120V/2-CD	5.5	B11	E12	120	Clear	2700K	500	15K	045923217067	12-2pks
S21707*	5.5W ETC/LED/27K/CL/120V/2-CD	5.5	B11	E26	120	Clear	2700K	500	15K	045923217074	12-2pks
C11											
S28613*	4WCTC/LED/27K/CL/120V	4	C11	E12	120	Clear	2700K	350	15K	045923286131	12/1
S8609*	4.5WETC/LED/27K/120V	4.5	C11	E26	120	Clear	2700K	450	15K	045923086090	12/1
CA11											
S28614*	4WCF/LED/27K/CL/120V	4	CA11	E12	120	Clear	2700K	350	15K	045923286148	12/1
S8610*	4.5WEFC/LED/27K/120V	4.5	CA11	E26	120	Clear	2700K	450	15K	045923086106	12/1
ST19											
S8612	4.5ST19/AMB/LED/E26/2K/120V	4.5	ST19	E26	120	Amber	2000K	380	15K	045923086120	12/1
S8611	6.5ST19/CL/LED/E26/27K/120V	6.5	ST19	E26	120	Clear	2700K	810	15K	045923086113	12/1

**See warranty for details.

CARDED SPECIALTY LED LAMPS

Carded LED specialty lamps

- Sign bulbs
- Indicator
- Nightlights
- Decorative lamps
- Non-dimmable
- Direct replacements for incandescent & specialty lamps
- LED replacements use 80% less energy
- Wet location
- Long life—25,000 hours
- 3 Year warranty



S11



Decorative



A15



Carded Specialty LED Lamps



Item Number	Lamp Description	W	Base	V	Finish	CCT	Lm	M.O.L. (Inches)	Life/Hrs.	UPC	Cards
S9150	1.4W A15/CL/LED/120V/CD	1.4	Med.	120	Clear	2700K	36	3 15/16	25K	045923091506	12/1
S9151	1.4W A15/FR/LED/120V/CD	1.4	Med.	120	Frost	2700K	45	3 15/16	25K	045923091513	12/1
S9152	1W CTC/LED/120V/CD	1.0	Cand.	120	Clear	2700K	25	3 3/16	25K	045923091520	12/1
S9153	1W CFC/LED/120V/CD	1.0	Cand.	120	Clear	2700K	25	3 7/8	25K	045923091537	12/1
S9154	1.4W ETC/LED/120V/CD	1.4	Med.	120	Clear	2700K	36	3 13/16	25K	045923091544	12/1
S9155	1W CTD/LED/CRYSTAL/120V/CD	1.0	Cand.	120	Clear	2700K	25	3 3/16	25K	045923091551	12/1
S9156	0.5W C7/CL/LED/120V/CD	0.5	Cand.	120	Clear	2700K	14	2 1/16	25K	045923091568	12/1
S9157	0.5W C7/WH/LED/120V/CD	0.5	Cand.	120	White	2700K	14	2 1/16	25K	045923091575	12/1
S9158	1.4W G16.5/CL/LED/120V/CD	1.4	Med.	120	Clear	2700K	36	2 3/4	25K	045923091582	12/1
S9159	1.4W G16.5/WH/LED/120V/CD	1.4	Med.	120	White	2700K	45	2 13/16	25K	045923091599	12/1
S9160	1.2W S11/CL/LED/120V/CD	1.2	Med.	120	Clear	2700K	32	2 5/16	25K	045923091605	12/1
S9161	1.2W S11/WH/LED/120V/CD	1.2	Med.	120	White	2700K	40	2 5/16	25K	045923091612	12/1
S9162	1.2W S11/BL/LED/120V/CD	1.2	Med.	120	Blue	—	—	2 5/16	25K	045923091629	12/1
S9163	1.2W S11/GR/LED/120V/CD	1.2	Med.	120	Green	—	—	2 5/16	25K	045923091636	12/1
S9164	1.2W S11/OR/LED/120V/CD	1.2	Med.	120	Orange	—	—	2 5/16	25K	045923091643	12/1
S9165	1.2W S11/RED/LED/120V/CD	1.2	Med.	120	Red	—	—	2 5/16	25K	045923091650	12/1
S9166	1.2W S11/Y/LED/120V/CD	1.2	Med.	120	Yellow	—	—	2 5/16	25K	045923091667	12/1
S9167	1.0W S11/CL/LED/E17/120V/CD	1.0	Inter.	120	Clear	2700K	28	2 5/16	25K	045923091674	12/1
S9168	1.0W S11/WH/LED/E17/120V/CD	1.0	Inter.	120	White	2700K	35	2 5/16	25K	045923091681	12/1
S9169	1.4W S14/Y/LED/120V/CD	1.4	Med.	120	Yellow	—	—	3 5/16	25K	045923091698	12/1
S9170	1.4W S14/RED/LED/120V/CD	1.4	Med.	120	Red	—	—	3 5/16	25K	045923091704	12/1
S9171	1.4W S14/GR/LED/120V/CD	1.4	Med.	120	Green	—	—	3 5/16	25K	045923091711	12/1
S9172	1.4W S14/BL/LED/120V/CD	1.4	Med.	120	Blue	—	—	3 5/16	25K	045923091728	12/1
S9173	1.4W S14/OR/LED/120V/CD	1.4	Med.	120	Orange	—	—	3 5/16	25K	045923091735	12/1
S9174	1.4W S14/CL/LED/120V/CD	1.4	Med.	120	Clear	2700K	36	3 5/16	25K	045923091742	12/1
S9175	1.4W S14/FR/LED/120V/CD	1.4	Med.	120	Frost	2700K	45	3 5/16	25K	045923091759	12/1
S9176	0.8W T6/FR/LED/120V/CD	0.8	Cand.	120	Frost	2700K	25	2 1/16	25K	045923091766	12/1
S9177	0.8W T6/CL/LED/120V/CD	0.8	Cand.	120	Clear	2700K	20	2 1/16	25K	045923091773	12/1

CARDED SPECIALTY LED LAMPS

Satco-Escent LED lamps

Elegance and efficiency in one package.

The most "decorative" decorative LED on the market. Adds elegance and style to any fixture even when not illuminated.

A Satco exclusive!

Applications

- Decorative lighting
- Chandeliers
- Wall sconces
- Candle sticks
- Candelabras
- Direct replacements for incandescent lamps

Features

- 2 Watt LED direct replacement for 25 watt incandescent lamps
- 4 Watt LED direct replacement for 40 watt incandescent lamps
- Unique satin-spun white or amber finish
- Dimmable
- Carded versions for peg board merchandising
- LED filament technology
- Approved for totally enclosed fixtures**
- Long life—15,000 hours
- 3 Year warranty



Satco-escent LED lamps



Item No.	Description	W	Voltage	Finish	CCT	Lm	CRI	Life/Hrs.	UPC	Case Pack
Boxed										
S23403	2C11/LED/SA/E26/27K/120V	2	120V	Satin Spun	2700	120	80	15,000	045923234033	24
S23407	2C11/LED/A/E26/23K/120V	2	120V	Amber Spun	2300	100	80	15,000	045923234071	24
S23413	4C15/LED/SA/E26/27K/120V	4	120V	Satin Spun	2700	300	80	15,000	045923234132	24
S23412	4C15/LED/A/E26/23K/120V	4	120V	Amber Spun	2300	240	80	15,000	045923234125	24
Carded										
S22703	2C11/LED/SA/E26/27K/120V/CD	2	120V	Satin Spun	2700	120	80	15,000	045923227035	24
S22707	2C11/LED/A/E26/23K/120V/CD	2	120V	Amber Spun	2300	100	80	15,000	045923227073	24
S22713	4C15/LED/SA/E26/27K/120V/CD	4	120V	Satin Spun	2700	300	80	15,000	045923227134	24
S22712	4C15/LED/A/E26/23K/120V/CD	4	120V	Amber Spun	2300	240	80	15,000	045923227127	24

**See warranty for details.

OMNI-DIRECTIONAL LED A19 LAMPS

40W replacement omni-directional LED A19 lamps

- Direct replacement for 40 Watt incandescent lamps, uses only 5.5-6 Watts
- Indoor residential and commercial lighting
- Innovative design—smooth heat sink design to resemble traditional incandescent lamp
- 2700K, 3000K, 3500K, 4000K & 5000K options
- Damp location
- Dimmable and non-dimmable options
- Approved for totally enclosed fixtures**
- Long life—up to 25,000 hours
- ENERGY STAR certified*
- 3 Year warranty—15,000 hours
- 5 Year warranty—25,000 hours

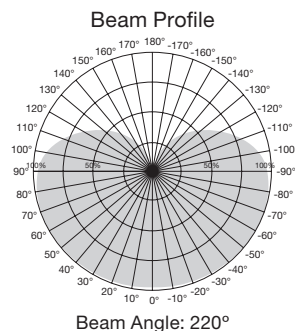

40W Replacement Omni-Directional A19 LED Lamps



Item Number	Lamp Description	W	V	CRI	CCT	Lm	Bm	M.O.L. (Inches)	Life/Hrs.	UPC	Pack
Dimmable											
S29830*	6A19/OMNI/220/LED/27K	6	120	80	2700K	480	220°	4 5/16	25K	045923298301	24/6
S29831*	6A19/OMNI/220/LED/30K	6	120	80	3000K	480	220°	4 5/16	25K	045923298318	24/6
S29832*	6A19/OMNI/220/LED/35K	6	120	80	3500K	480	220°	4 5/16	25K	045923298325	24/6
S29833*	6A19/OMNI/220/LED/40K	6	120	80	4000K	480	220°	4 5/16	25K	045923298332	24/6
S29834*	6A19/OMNI/220/LED/50K	6	120	80	5000K	480	220°	4 5/16	25K	045923298349	24/6
Non-Dimmable											
S9590*	6A19/LED/2700K/120V	6	120	80	2700K	480	220°	4 5/16	15K	045923095900	24/6
S9591*	6A19/LED/3000K/120V	6	120	80	3000K	480	220°	4 5/16	15K	045923095917	24/6
S9592*	6A19/LED/5000K/120V	6	120	80	5000K	480	220°	4 5/16	15K	045923095924	24/6
90 CRI—CEC/T20 - Non-Dimmable											
S28557	5.5A19/LED/927/120V/ND/4PK	5.5	120	90	2700K	450	220°	4 3/16	15K	045923285578	12-4pks
S28558	5.5A19/LED/930/120V/ND/4PK	5.5	120	90	3000K	450	220°	4 3/16	15K	045923285585	12-4pks
S28593	5.5A19/LED/940/120V/ND/4PK	5.5	120	90	4000K	450	220°	4 3/16	15K	045923285936	12-4pks
S28594	5.5A19/LED/950/120V/ND/4PK	5.5	120	90	5000K	450	220°	4 3/16	15K	045923285943	12-4pks

4-pks Must be ordered in full cases only.

Product sheet SA2630

OMNI-DIRECTIONAL LED A19 LAMPS

60W replacement omni-directional LED A19 lamps

- Direct replacement for 60 Watt incandescent lamps, uses only 8.5-10 Watts
- Indoor residential and commercial lighting
- Innovative design—smooth heat sink design to resemble traditional incandescent lamp
- 2700K, 3000K, 3500K, 4000K & 5000K options
- Damp location
- Dimmable and non-dimmable options
- Approved for totally enclosed fixtures**
- E26 & GU24 base options
- CEC/T20 Compliant options available
- Long life—up to 25,000 hours
- ENERGY STAR certified*
- 3 Year warranty—15,000 hours
- 5 Year warranty—25,000 hours

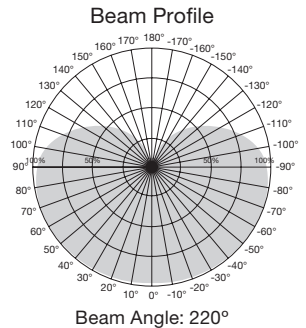

60W Replacement Omni-Directional A19 LED Lamps



Item Number	Lamp Description	W	V	CRI	CCT	Lm	Bm	M.O.L. (Inches)	Life/Hrs.	UPC	Pack
Dimmable											
S29835*	9.8A19/OMNI/220/LED/27K	9.8	120	80	2700K	800	220°	4 5/16	25K	045923298356	24/6
S29836*	9.8A19/OMNI/220/LED/30K	9.8	120	80	3000K	800	220°	4 5/16	25K	045923298363	24/6
S29837*	9.8A19/OMNI/220/LED/35K	9.8	120	80	3500K	800	220°	4 5/16	25K	045923298370	24/6
S29838*	9.8A19/OMNI/220/LED/40K	9.8	120	80	4000K	800	220°	4 5/16	25K	045923298387	24/6
S29839*	9.8A19/OMNI/220/LED/50K	9.8	120	80	5000K	800	220°	4 5/16	25K	045923298394	24/6
S29840*	9.8A19/OMNI/220/LED/27K/GU24	9.8	120	80	2700K	800	220°	4 5/16	25K	045923298400	24/6
S29844*	9.8A19/OMNI/220/LED/30K/GU24	9.8	120	80	3000K	800	220°	4 5/16	25K	045923298448	24/6
S29841*	9.8A19/OMNI/220/LED/35K/GU24	9.8	120	80	3500K	800	220°	4 5/16	25K	045923298417	24/6
S29842*	9.8A19/OMNI/220/LED/40K/GU24	9.8	120	80	4000K	800	220°	4 5/16	25K	045923298424	24/6
S29843	9.8A19/OMNI/220/LED/50K/GU24	9.8	120	80	5000K	800	220°	4 5/16	25K	045923298431	24/6
90 CRI—CEC/T20—JA8-2016											
S9703*■	10A19/OMNI/LED/27K/90CRI	10	120	90	2700K	800	220°	4 5/16	25K	045923097034	24/6
S9704*■	10A19/OMNI/LED/30K/90CRI	10	120	90	3000K	800	220°	4 5/16	25K	045923097041	24/6
S8480	10A19/OMNI/LED/40K/90CRI	10	120	90	4000K	800	220°	4 5/16	25K	045923084805	24/6
S8481	10A19/OMNI/LED/50K/90CRI	10	120	90	5000K	800	220°	4 5/16	25K	045923084812	24/6
S9707*■	10A19/OMNI/LED/27K/90CRI/GU24	10	120	90	2700K	800	220°	4 5/16	25K	045923097072	24/6
S9708*■	10A19/OMNI/LED/30K/90CRI/GU24	10	120	90	3000K	800	220°	4 5/16	25K	045923097089	24/6
S8482	10A19/OMNI/LED/40K/90CRI/GU24	10	120	90	4000K	800	220°	4 5/16	25K	045923084829	24/6
Non-Dimmable											
S9593*	9.5A19/LED/2700K/120V	9.5	120	80	2700K	800	220°	4 5/16	15K	045923095931	24/6
S9594*	9.5A19/LED/3000K/120V	9.5	120	80	3000K	800	220°	4 5/16	15K	045923095948	24/6
S9595*	9.5A19/LED/5000K/120V	9.5	120	80	5000K	800	220°	4 5/16	15K	045923095955	24/6
120-277V											
S8914*	8.5A19/LED/27K /120-277V	8.5	120-277	80	2700K	800	220°	4 5/16	25K	045923089145	24/6
S8915*	8.5A19/LED/30K /120-277V	8.5	120-277	80	3000K	800	220°	4 5/16	25K	045923089152	24/6
S8916	8.5A19/LED/40K /120-277V	8.5	120-277	80	4000K	800	220°	4 5/16	25K	045923089169	24/6
S8920	8.5A19/LED/50K /120-277V	8.5	120-277	80	5000K	800	220°	4 5/16	25K	045923089206	24/6

■ Also T24 compliant.

Product sheet SA2631

**See warranty for details.



www.satco.com

REPLACEMENT LED A19 4-PACKS

60W replacement LED A19 4-packs

Direct replacements for 60W incandescent lamps

- 60 Watt replacement uses only 9.5-10 Watts
- Indoor residential and commercial lighting
- Direct replacement for 13 Watt screw-in CFLs
- 2700K, 3000K, 4000K and 5000K options
- Damp location
- Approved for totally enclosed fixtures**
- Long life—15,000 hours
- ENERGY STAR certified*
- 3 Year warranty

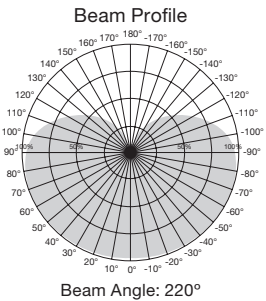

60W Replacement Multi-Directional A19 LED Lamps 4-packs



Item Number	Lamp Description	W	V	CRI	CCT	Lm	Bm	M.O.L. (Inches)	Life/ Hrs.	UPC	Pack/ Master
Non-Dimmable											
S29596*	9.5A19/LED/27K/ND/120V/4PK	9.5	120	80	2700K	800	220°	4 5/16	15K	045923295966	12 - 4pks
S29589*	9.5A19/LED/30K/ND/120V/4PK	9.5	120	80	3000K	800	220°	4 5/16	15K	045923295898	12 - 4pks
S29558*	9.5A19/LED/40K/ND/120V/4PK	9.5	120	80	4000K	800	220°	4 5/16	15K	045923295584	12 - 4pks
S29597*	9.5A19/LED/50K/ND/120V/4PK	9.5	120	80	5000K	800	220°	4 5/16	15K	045923295973	12 - 4pks
90 CRI—CEC/T20											
S28560	10A19/LED/927/120V/ND/4PK	10	120	90	2700K	750	220°	4 3/16	15K	045923285608	12-4pks
S28561	10A19/LED/930/120V/ND/4PK	10	120	90	3000K	750	220°	4 3/16	15K	045923285615	12-4pks
S28562	10A19/LED/940/120V/ND/4PK	10	120	90	4000K	750	220°	4 3/16	15K	045923285622	12-4pks
S28563	10A19/LED/950/120V/ND/4PK	10	120	90	5000K	750	220°	4 3/16	15K	045923285639	12-4pks

Must be ordered in full cases only.

Product sheet SA2215

60W replacement omni-directional LED A19 display pack

- Direct replacement for 60 Watt incandescent lamps, uses only 9.5 Watts
- Indoor residential and commercial lighting
- Warm white 2700K
- Damp location
- Approved for totally enclosed fixtures**
- Long life—25,000 hours
- ENERGY STAR certified*
- 3 Year warranty



Sold 72 per display



9.5 Watt Omni-Directional 240° LED A19 Display Packs

Item Number	Lamp Description	W	V	CRI	CCT	Lm	Bm	M.O.L. (Inches)	Life/Hrs.	UPC	Pack/Master
Dimmable											
S29629*	9.5A19/LED/2700K/800L/120V/D	9.5	120	80	2700K	800	240°	4 3/8	25K	045923096297	72

Must be ordered in full cases only.

Product sheet SA1994

60W replacement omni-directional LED A19 lamp 2-pack display

Great efficiency,
even greater value –
now in convenient 2-packs

- Indoor residential and commercial lighting
- Great for retail end caps and counter areas
- 60 Watt replacement uses only 9.8 Watts
- Innovative design—smooth heat sink design to resemble traditional incandescent lamp
- 2700K
- Damp location
- Approved for totally enclosed fixtures**
- Long life—25,000 hours
- ENERGY STAR certified*
- 5 Year warranty



Sold 60 2-Packs per display



60W Replacement Omni-Directional A19 LED Lamp 2-Packs

Item Number	Lamp Description	W	V	CRI	CCT	Lm	Bm	M.O.L. (Inches)	Life/Hrs.	UPC	Pack
Dimmable											
S29699*	9.8A19/LED/2700K/800L/2PK	9.8	120	80+	2700K	800	220°	4 3/8	25K	045923096990	60-2pks

Must be ordered in full cases only.

Product sheet SA2043

**See warranty for details.

OMNI-DIRECTIONAL LED A19 LAMPS

75W replacement omni-directional LED A19 lamps

- Direct replacement for 75 Watt incandescent lamps, uses only 11-13 Watts
- Indoor residential and commercial lighting
- Damp Location
- Approved for totally enclosed fixtures**
- E26 & GU24 base options
- Dimmable and non-dimmable options
- CEC/T20 Compliant options available
- Long life—25,000 hours
- ENERGY STAR certified*
- 3 Year warranty—15,000 hours
- 5 Year warranty—25,000 hours

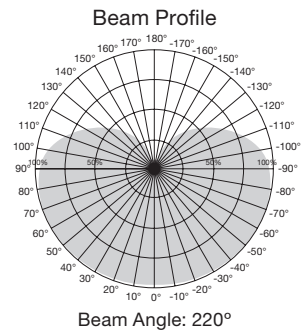

75W Replacement Omni-Directional LED A19 Lamps



Item Number	Lamp Description	W	V	CRI	CCT	Lm	Bm	M.O.L. (Inches)	Life/Hrs.	UPC	Pack
Dimmable											
S29810*	11A19/LED/2700K/1100L/120V/D	11	120	80	2700K	1100	220°	4 5/16	25K	045923298103	24/6
S29811*	11A19/LED/3000K/1100L/120V/D	11	120	80	3000K	1100	220°	4 5/16	25K	045923298110	24/6
S29812*	11A19/LED/4000K/1100L/120V/D	11	120	80	4000K	1100	220°	4 5/16	25K	045923298127	24/6
S29813*	11A19/LED/5000K/1100L/120V/D	11	120	80	5000K	1100	220°	4 5/16	25K	045923298134	24/6
S29814*	11A19/LED/2700K/120V/D/GU24	11	120	80	2700K	1100	220°	4 5/16	25K	045923298141	24/6
S29804*	11A19/LED/4000K/120V/D/GU24	11	120	80	4000K	1100	220°	4 5/16	25K	45923298042	24/6
90 CRI—CEC/T20											
S8650*■	13A19/LED/27K/90CRI	13	120	90	2700K	1100	220°	4 5/8	25K	045923086502	24/6
S8651*■	13A19/LED/30K/90CRI	13	120	90	3000K	1100	220°	4 5/8	25K	045923086519	24/6
S8484	13A19/LED/50K/90CRI	13	120	90	5000K	1100	220°	4 5/8	25K	045923084843	24/6
S8483	13A19/LED/40K/90CRI	13	120	90	4000K	1100	220°	4 5/8	25K	045923084836	24/6
S8485	13A19/LED/40K/90CRI/GU24	13	120	90	4000K	1100	220°	4 5/8	25K	045923084850	24/6
Non-Dimmable											
S28765*	11.5A19/LED/27K/ND/120V	11.5	120	80	2700K	1100	220°	4 5/16	15K	045923287657	24/6
S28766*	11.5A19/LED/30K/ND/120V	11.5	120	80	3000K	1100	220°	4 5/16	15K	045923287664	24/6
S28767*	11.5A19/LED/40K/ND/120V	11.5	120	80	4000K	1100	220°	4 5/16	15K	045923287671	24/6
S28768*	11.5A19/LED/50K/ND/120V	11.5	120	80	5000K	1100	220°	4 5/16	15K	045923287688	24/6

■ Also T24 compliant.

Product sheet SA2254

REPLACEMENT LED A19 4-PACKS

75W replacement LED A19 4-packs

Direct replacements for 75W incandescent lamps

- 75 Watt replacement uses only 11.5 Watts
- Indoor residential and commercial lighting
- Direct replacement for 18 Watt screw-in CFLs
- 2700K, 3000K, 4000K and 5000K options
- Damp location
- Approved for totally enclosed fixtures**
- Long life—15,000 hours
- ENERGY STAR certified*
- 3 Year warranty

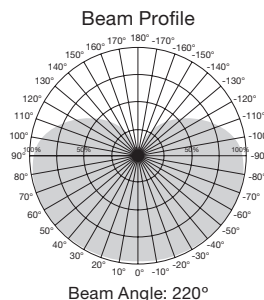

75W Replacement A19 LED 4-packs



Item Number	Lamp Description	W	V	CRI	CCT	Lm	Bm	M.O.L. (Inches)	Life/Hrs.	UPC	Pack/Master
Non-Dimmable											
S28769*	11.5A19/LED/27K/ND/120V/4PK	11.5	120	80	2700K	1100	220°	4 5/16	15K	045923287695	12-4pks
S28770*	11.5A19/LED/50K/ND/120V/4PK	11.5	120	80	5000K	1100	220°	4 5/16	15K	045923287701	12-4pks
90 CRI—CEC/T20											
S8564	12.5A19/LED/27K/ND/120V/4PK	12.5	120	90	2700K	1050	220°	4 3/8	15K	045923085642	12-4pks
S8499	12.5A19/LED/30K/ND/120V/4PK	12.5	120	90	3000K	1050	220°	4 3/8	15K	045923084997	12-4pks
S8489	12.5A19/LED/40K/ND/120V/4PK	12.5	120	90	4000K	1050	220°	4 3/8	15K	045923084898	12-4pks
S8565	12.5A19/LED/50K/ND/120V/4PK	12.5	120	90	5000K	1050	220°	4 3/8	15K	045923085659	12-4pks

Must be ordered in full cases only.

Product sheet SA2152

**See warranty for details.

OMNI-DIRECTIONAL LED A19 & A21 LAMPS

100W replacement omni-directional LED A19, A21 lamps

- Direct replacement for 100 Watt incandescent lamps, uses only 15-18 Watts
- Indoor residential and commercial lighting
- Damp location
- Dimmable and non-dimmable options
- Approved for totally enclosed fixtures**
- CEC/T20 Compliant options available
- Long life—up to 25,000 hours
- ENERGY STAR certified*
- 3 Year warranty—15,000 hours
- 5 Year warranty—25,000 hours

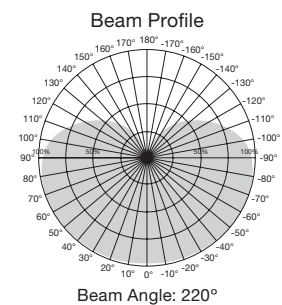

100W Replacement Omni-Directional LED A19 Lamps



Item Number	Lamp Description	W	V	CRI	CCT	Lm	Bm	M.O.L. (Inches)	Life/ Hrs.	UPC	Pack
Dimmable											
S29815*	15A19/LED/2700K/1600L/120V/D	15	120	80	2700K	1600	220°	4 5/8	25K	045923298158	24/6
S29816*	15A19/LED/3000K/1600L/120V/D	15	120	80	3000K	1600	220°	4 5/8	25K	045923298165	24/6
S29817*	15A19/LED/4000K/1600L/120V/D	15	120	80	4000K	1600	220°	4 5/8	25K	045923298172	24/6
S29818*	15A19/LED/5000K/1600L/120V/D	15	120	80	5000K	1600	220°	4 5/8	25K	045923298189	24/6
S29819*	15A19/LED/27K/1600/120V/GU24	15	120	80	2700K	1600	220°	4 1/2	25K	045923298196	24/6
S29805*	15A19/LED/40K/1600/120V/GU24	15	120	80	4000K	1600	220°	4 1/2	25K	045923298059	24/6
90 CRI—CEC/T20											
S8652*■	18A21/LED/27K/90CRI	18	120	90	2700K	1600	220°	5 7/16	25K	045923086526	24/6
S8653*■	18A21/LED/30K/90CRI	18	120	90	3000K	1600	220°	5 7/16	25K	045923086533	24/6
S8486	18A21/LED/40K/90CRI	18	120	90	4000K	1600	220°	5 7/16	25K	045923084867	24/6
S8487	18A21/LED/50K/90CRI	18	120	90	5000K	1600	220°	5 7/16	25K	045923084874	24/6
S8488	18A21/LED/40K/90CRI/GU24	18	120	90	4000K	1600	220°	5 7/16	25K	045923084881	24/6
Non-Dimmable											
S28785*	15.5A19/LED/27K/ND/120V	15.5	120	80	2700K	1600	220°	4 5/8	15K	045923287855	24/6
S28786*	15.5A19/LED/30K/ND/120V	15.5	120	80	3000K	1600	220°	4 5/8	15K	045923287862	24/6
S28787*	15.5A19/LED/40K/ND/120V	15.5	120	80	4000K	1600	220°	4 5/8	15K	045923287879	24/6
S28788*	15.5A19/LED/50K/ND/120V	15.5	120	80	5000K	1600	220°	4 5/8	15K	045923287886	24/6

■ Also T24 compliant.

Product sheet SA2255

OMNI-DIRECTIONAL LED A19 & A21 LAMPS

100W replacement LED A19 4-packs

Direct replacements for 100W incandescent lamps

- 100 Watt replacement, uses only 15.5 Watts
- Indoor residential and commercial lighting
- Direct replacement for 13, 18 & 23W screw-in CFLs
- 2700K and 5000K options
- Damp location
- Approved for totally enclosed fixtures**
- Long life—up to 25,000 hours
- ENERGY STAR certified* • 3 Year warranty

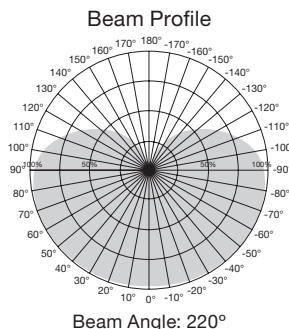

100W Replacement LED A19 4-packs



Item Number	Lamp Description	W	V	CRI	CCT	Lm	Bm	M.O.L. (Inches)	Life/Hrs.	UPC	Pack/Master
Non-Dimmable											
S28789*	15.5A19/LED/27K/ND/120V/4PK	15.5	120	80	2700K	1600	220°	4 5/8	15K	045923287893	12-4pks
S28790*	15.5A19/LED/50K/ND/120V/4PK	15.5	120	80	5000K	1600	220°	4 5/8	15K	045923287909	12-4pks
90 CRI—CEC/T20											
S8566	15.5A19/LED/27K/ND/120V/4PK	15.5	120	90	2700K	1490	220°	4 5/8	15K	045923085666	12-4pks
S8567	15.5A19/LED/30K/ND/120V/4PK	15.5	120	90	3000K	1490	220°	4 5/8	15K	045923085673	12-4pks
S8490	15.5A19/LED/40K/ND/120V/4PK	15.5	120	90	4000K	1490	220°	4 5/8	15K	045923084904	12-4pks
S8568	15.5A19/LED/50K/ND/120V/4PK	15.5	120	90	5000K	1490	220°	4 5/8	15K	045923085680	12-4pks

Must be ordered in full cases only.

125W replacement omni-directional 120-277V LED A21 lamps

- Direct replacement for 125 Watt incandescent & 25 Watt CFL lamps, uses only 19 Watts
- Indoor residential and commercial lighting
- Down lighting • Display lighting
- Accent lighting
- 2700K, 3000K, 4000K and 5000K options
- Damp location • Approved for totally enclosed fixtures**
- c-UL-us listed • Long life—25,000 hours
- ENERGY STAR certified*
- 5 Year warranty

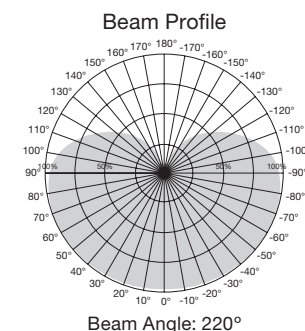

125W Replacement Omni-Directional 120-277V LED A21 Lamps

Item Number	Lamp Description	W	V	CRI	CCT	Lm	Bm	M.O.L. (Inches)	Life/Hrs.	UPC	Pack
S8646*	19A21/LED/27K/120-277V	19	120-277	80	2700K	2000	220°	5 5/16	25K	045923086465	24
S8647*	19A21/LED/30K/120-277V	19	120-277	80	3000K	2000	220°	5 5/16	25K	045923086472	24
S8648	19A21/LED/40K/120-277V	19	120-277	80	4000K	2000	220°	5 5/16	25K	045923086489	24
S8649	19A21/LED/50K/120-277V	19	120-277	80	5000K	2000	220°	5 5/16	25K	045923086496	24

**See warranty for details.

HIGH LUMEN LED A21 LAMPS

Hi-Pro LED A21 lamps

High lumen, A21 lamps for industrial and commercial applications

- For use in bollard and post top lighting
- High ceiling recessed lighting
- Replaces high lumen incandescent and CFL lamps
- Dimmable
- Damp location
- Saves over 80% on energy costs
- Advanced heat dissipation design
- Direct wire range voltage 120-277V options
- High efficiency—up to 150 LPW
- 2700K, 4000K and 5000K options
- Base up, base down or horizontal operation
- Long life—25,000 hours
- ENERGY STAR certified*
- 5 Year limited warranty

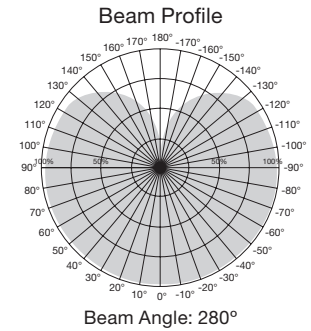

High Lumen A21 Industrial/Commercial LED Lamps



Item Number	Lamp Description	W	V	CRI	CCT	Lm	Bm	M.O.L. (Inches)	Life/Hrs.	UPC	Pack/Master
Dimmable											
S8735*	20WA21/LED/2700K/120V/DIM/E26	20	120	80+	2700K	2350	280°	5	25K	045923087356	24/6
S8778*	20WA21/LED/4000K/120V/DIM/E26	20	120	80+	4000K	2747	280°	5	25K	045923087783	24/6
S8736*	20WA21/LED/5000K/120V/DIM/E26	20	120	80+	5000K	2860	280°	5	25K	045923087363	24/6
Non-Dimmable											
S8737*	20WA21/LED/2700K/120-277V/E26	20	120-277	80+	2700K	2450	280°	5	25K	045923087370	24/6
S8779*	20WA21/LED/4000K/120-277V/E26	20	120-277	80+	4000K	2828	280°	5	25K	045923087790	24/6
S8738*	20WA21/LED/5000K/120-277V/E26	20	120-277	80+	5000K	2910	280°	5	25K	045923087387	24/6
Accessories											
92-410	Mog to Med Socket Reducer									045923924064	10/1
80-929	Hard Wire Surge Protector									045923809293	100/1

DECORATIVE LED LAMPS

5W LED decorative flame lamp

- Outdoor fixtures
- Wall sconces
- Faux fireplaces
- Holiday lighting
- Any decorative application
- Base up or base down operation
- 120-277V
- Medium base
- Long life—20,000 hours
- c-UL-us listed
- 2 Year warranty

Multi-function options-controlled by quickly turning wall switch on-off-on

- Flame mode
- Auto slow-dim cycle
- Constant warm glow 1300K



5W LED Decorative Flame Lamps



Item Number	Lamp Description	W	Bulb Type	Base	V	CCT	M.O.L. (Inches)	Life/Hrs.	UPC	Pack
S9806	5W/LED/FLAME BULB/120V	5	T10	E26	120-277	1300K	4 ½	20K	045923098062	24

Product sheet SA2326

**See warranty for details.

SATCO | **NUVO**

www.satco.com

OMNI-DIRECTIONAL 3-WAY LED LAMPS

Omni-directional 3-way LED lamps

- Direct replacement for 30/70/100W 3-Way incandescent lamps, uses only 3/9/12W
- Direct replacement for 50/100/150W 3-Way incandescent lamps uses only 5/15/21W
- Indoor residential and commercial lighting
- 220° Omni-directional
- 2700K, 3000K, 4000K and 5000K options
- Damp location rated
- Approved for totally enclosed fixtures**
- ENERGY STAR certified*
- Long life—25,000 hours
- 3 Year warranty



3/9/12

5/15/21

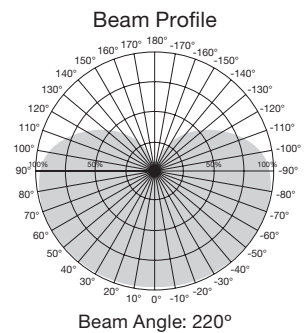

Omni-Directional 3-Way LED Lamps



Item Number	Lamp Description	W	V	CRI	CCT	Lumens	Bm	M.O.L. (Inches)	Life/Hrs.	UPC	Pack
30/70/100W 3-Way											
S9316*	3/9/12A19/3WAY LED/2700K/120V	3/9/12	120	80	2700K	280/950/1200	220°	4 5/8	25K	045923093166	24/6
S9317*	3/9/12A19/3WAY LED/3000K/120V	3/9/12	120	80	3000K	280/950/1200	220°	4 5/8	25K	045923093173	24/6
S9318	3/9/12A19/3WAY LED/4000K/120V	3/9/12	120	80	4000K	280/950/1200	220°	4 5/8	25K	045923093180	24/6
S9319	3/9/12A19/3WAY LED/5000K/120V	3/9/12	120	80	5000K	280/950/1200	220°	4 5/8	25K	045923093197	24/6
90 CRI—CEC/T20											
S8570*	3/9/12A19/3WAY LED/27K/120V	3/9/12	120	90	2700K	1050	220°	4 5/8	25K	045923085703	24/6
S8571*	3/9/12A19/3WAY LED/30K/120V	3/9/12	120	90	3000K	1050	220°	4 5/8	25K	045923085710	24/6
50/100/150W 3-Way											
S8542*	5/15/21A21/3-WAY LED/2700K/120V	5/15/21	120	80	2700K	600/1600/2150	220°	5 5/8	25K	045923085420	24/6
S8543*	5/15/21A21/3-WAY LED/3000K/120V	5/15/21	120	80	3000K	600/1600/2150	220°	5 5/8	25K	045923085437	24/6
S8544	5/15/21A21/3-WAY LED/4000K/120V	5/15/21	120	80	4000K	600/1600/2150	220°	5 5/8	25K	045923085444	24/6
S8545	5/15/21A21/3-WAY LED/5000K/120V	5/15/21	120	80	5000K	600/1600/2150	220°	5 5/8	25K	045923085451	24/6

Product sheet SA2608

CANDELABRA BASE A19 & COLORED LED LAMPS

40 & 60W Candelabra base replacement LED A19 lamps

- Direct replacements for 9 and 13 Watt candelabra base CFL
- Indoor residential and commercial lighting
- Display lighting
- Accent lighting
- Dimmable
- 2700K, 3000K, 4000K and 5000K options
- Damp location
- Approved for totally enclosed fixtures**
- Long life—25,000 hours
- 5 Year warranty

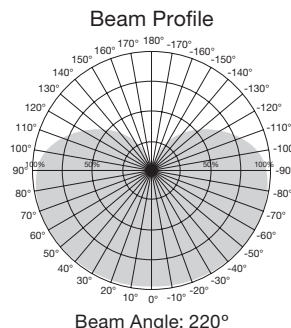

Candelabra Base A19 LED Lamps



Item Number	Lamp Description	W	V	CRI	CCT	Lm	Bm	M.O.L. (Inches)	Life/Hrs.	UPC	Pack/Master
Dimmable											
S21800*	6A19/OMNI/220/LED/E12/27K	6	120	80	2700K	480	220°	4 5/16	25K	045923218002	24/6
S21801*	6A19/OMNI/220/LED/E12/30K	6	120	80	3000K	480	220°	4 5/16	25K	045923218019	24/6
S21802	6A19/OMNI/220/LED/E12/40K	6	120	80	4000K	480	220°	4 5/16	25K	045923218026	24/6
S21803	6A19/OMNI/220/LED/E12/50K	6	120	80	5000K	480	220°	4 5/16	25K	045923218033	24/6
S21804*	9.8A19/OMNI/220/LED/E12/27K	9.8	120	80	2700K	800	220°	4 5/16	25K	045923218040	24/6
S21805*	9.8A19/OMNI/220/LED/E12/30K	9.8	120	80	3000K	800	220°	4 5/16	25K	045923218057	24/6
S21806	9.8A19/OMNI/220/LED/E12/40K	9.8	120	80	4000K	800	220°	4 5/16	25K	045923218064	24/6
S21807	9.8A19/OMNI/220/LED/E12/50K	9.8	120	80	5000K	800	220°	4 5/16	25K	045923218071	24/6

Product sheet SA2469

LED A19 colors

- Direct replacement for 60 Watt incandescent lamps, uses only 8 Watts
- Indoor residential and commercial lighting
- Party bulbs
- Display lighting
- Accent lighting
- Ceramic-lined glass envelopes
- 360° Beam angle
- Damp location
- Approved for totally enclosed fixtures**
- Long life—15,000 hours
- 3 Year warranty

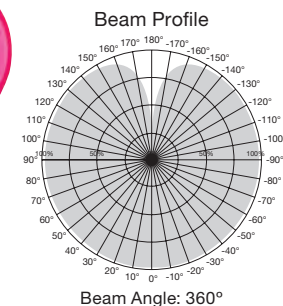

Colors for a reason

- Blue—in support of law enforcement/ Autism awareness
- Green—in support of veterans
- Yellow—bug lights
- Pink—Breast cancer awareness

Colored LED Lamps



Item Number	Lamp Description	W	V	CCT	Bm	M.O.L. (Inches)	Life/Hrs.	UPC	Pk./Mstr.
S14984	8A19/RED/LED/E26/120V	8	120	Red	360°	4 1/8	15K	045923149849	24/6
S14985	8A19/BLUE/LED/E26/120V	8	120	Blue	360°	4 1/8	15K	045923149856	24/6
S14986	8A19/GREEN/LED/E26/120V	8	120	Green	360°	4 1/8	15K	045923149863	24/6
S14987	8A19/YELLOW/E26/120V	8	120	Yellow	360°	4 1/8	15K	045923149870	24/6
S14988	8A19/ORANGE/LED/E26/120V	8	120	Orange	360°	4 1/8	15K	045923149887	24/6
S14989	8A19/PINK/LED/E26/120V	8	120	Pink	360°	4 1/8	15K	045923149894	24/6

Product sheet SA2482

**See warranty for details.

OMNI-DIRECTIONAL A15 & LOW VOLTAGE A19 LED LAMPS

40W replacement omni-directional LED A15 lamps

- Direct replacement for 40 Watt A15 incandescent lamps, uses only 5.5 Watts
- Indoor residential and commercial lighting
- Dimmable
- 2700K, 3000K, 4000K and 5000K options
- Damp location rated
- Approved for totally enclosed fixtures**
- Long life—25,000 hours
- ENERGY STAR certified*
- 3 Year warranty



E17 Base

E26 Base

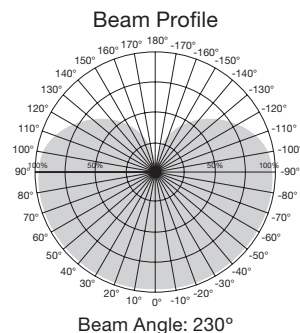

40W Replacement Omni-Directional LED Lamps

Item Number	Lamp Description	W	V	CRI	CCT	Lm	Bm	M.O.L. (Inches)	Life/Hrs.	UPC	Pack/Master
S9030*	5.5A15/LED/2700K/120V	5.5	120	80	2700K	450	230°	3 7/16	25K	045923090301	24/6
S9031*	5.5A15/LED/3000K/120V	5.5	120	80	3000K	450	230°	3 7/16	25K	045923090318	24/6
S9032	5.5A15/LED/4000K/120V	5.5	120	80	4000K	450	230°	3 7/16	25K	045923090325	24/6
S9033	5.5A15/LED/5000K/120V	5.5	120	80	5000K	450	230°	3 7/16	25K	045923090332	24/6
S9064	5.5A15/LED/2700K/E17/120V	5.5	120	80	2700K	450	230°	3 7/16	25K	045923090646	24/6
S9065	5.5A15/LED/3000K/E17/120V	5.5	120	80	3000K	450	230°	3 1/2	25K	045923090653	24/6
S9067	5.5A15/LED/4000K/E17/120V	5.5	120	80	4000K	450	230°	3 1/2	25K	045923090677	24/6
S9068	5.5A15/LED/5000K/E17/120V	5.5	120	80	5000K	450	230°	3 1/2	25K	045923090684	24/6
90 CRI—CEC/T20											
S8572	5A15/LED/27K/120V	5	120	90	2700K	450	230°	3 15/32	25K	045923085727	24/6
S8573	5A15/LED/30K/120V	5	120	90	3000K	450	230°	3 15/32	25K	045923085734	24/6

Product sheet SA2267

Low voltage 9 Watt LED A19 lamps

- 60 Watt incandescent replacement, uses only 9 Watts
- RVs and campers
- Marine applications
- High efficiency—reduces drain on battery
- 12-34V DC
- 800 Lumens
- Long life—25,000 hours
- 3 Year warranty

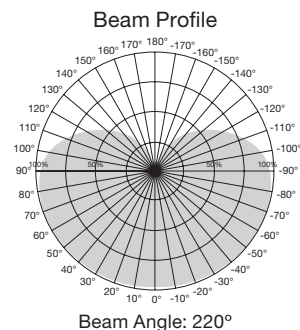

Low Voltage 9 Watt LED A19 Lamps

Item Number	Lamp Description	W	VDC	Base Type	CCT	CRI	M.O.L. (Inches)	Lm	Life/Hrs.	UPC	Pack/Master
S15011	9A19/LED/12-34VDC/827	9	12-34	E26	2700K	80	4 3/8	800	25K	045923150111	24/6
S15012	9A19/LED/12-34VDC/850	9	12-34	E26	5000K	80	4 3/8	800	25K	045923150128	24/6

Product sheet SA2476

DECORATIVE & LINEAR T10 LED LAMPS

Decorative LED lamps

- 25W candle replacement uses only 2.8 Watts
- 40W candle replacement uses only up to 4.5 Watts
- Accent lighting • Pendant lighting
- Dimmable • Damp location
- Approved for totally enclosed fixtures**
- Long life—25,000 hours
- ENERGY STAR certified*
- 3 Year warranty



Candle Beam Profile Globe Beam Profile

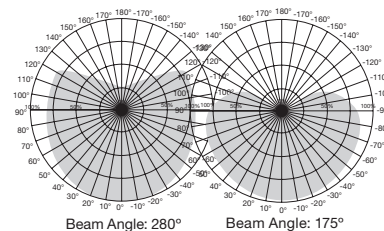

Decorative LED Lamps

Item Number	Lamp Description	W	V	CRI	CCT	Lm	Bm	M.O.L. (Inches)	Life/Hrs.	UPC	Pack
S8950	2.8CTC/LED/3000K/E12/120V	2.8	120	80	3000K	165	280°	3 ¾	25K	045923089503	12/1
S8951*	4.5CTC/LED/2700K/E12/120V	4.5	120	80	2700K	300	280°	3 ¾	25K	045923089510	12/1
S8952*	4.5CTC/LED/3000K/E12/120V	4.5	120	80	3000K	300	280°	3 ¾	25K	045923089527	12/1
S8953*	4.5ETC/LED/3000K/E26/120V	4.5	120	80	3000K	300	280°	3 ¾	25K	045923089534	12/1
90 CRI—CEC/T20											
S29618*■	3.5CTC/LED/927/E12/120V	3.5	120	90	2700K	300	290°	3 ¾	25K	045923296185	12/1
S28574	3.5CTC/LED/930/E12/120V	3.5	120	90	3000K	300	290°	3 ¾	25K	045923285745	12/1
S28617	3.5ETC/LED/927/E26/120V	3.5	120	90	2700K	300	290°	3 ¾	25K	045923286179	12/1
S28575	3.5ETC/LED/930/E26/120V	3.5	120	90	3000K	300	290°	3 ¾	25K	045923286179	12/1
GLOBES - G25											
S9200*	6G25/LED/2700K/E26	6	120	80	2700K	450	175°	4 ¼	25K	045923285752	24/6
S9201*	6G25/LED/3000K/E26	6	120	80	3000K	450	175°	4 ¼	25K	045923090530	24/6
S9202	6G25/LED/4000K/E26	6	120	80	4000K	450	175°	4 ¼	25K	045923090691	24/6
S9203	6G25/LED/5000K/E26	6	120	80	5000K	450	175°	4 ¼	25K	045923092039	24/6
90 CRI—CEC/T20											
S29619*■	4G25/LED/927/120V	4	120	90	2700K	360	170	4 ¼	25K	045923296192	24/6
S28576	4G25/LED/930/120V	4	120	90	3000K	360	170	4 ¼	25K	045923285769	24/6
S28618	4G25/LED/940/120V	4	120	90	4000	360	170	4 ¼	25K	045923286186	24/6
S28595	4G25/LED/950/120V	4	120	90	5000K	360	170	4 ¼	25K	045923285950	24/6

■ Also T24 compliant.

Product sheet SA1370

LED Linear T10 lamps

- Energy efficient alternative to traditional 35W, 60W and 150W T10 linear incandescent lamps, use only 5W, 7W and 13W
- Direct replacements for LN35, LN60 and LN150 lamps
- Full PC material (bulb opaque)
- Simple installation—no ballasts or transformers required
- S14S Base • Dimmable • 2700K
- Long life—30,000 hours
- 5 Year warranty



LED T10 Lamps

Item Number	Lamp Description	W	CRI	Base Type	CCT	Lm	M.O.L." (Nominal)	Life/Hrs.	UPC	Pack
S8191	5T10/LED/27K/S14S	5	80	S14s	2700K	330	11 13/16	30K	045923081910	12
S8189	7T10/LED/27K/S14S	7	80	S14s	2700K	500	18 11/16	30K	045923081897	12
S8190	13T10/LED/27K/S14S	13	80	S14s	2700K	1000	39 3/8	30K	045923081903	12

SA2427Product sheet

**See warranty for details.



www.satco.com

LED REFLECTOR LAMPS

Satco R20 LED reflectors 80 & 90 CRI

- 50R20 replacement uses only up to 6.5 Watts
- Indoor residential and commercial lighting
- Dimmable • Damp location • Long life—25,000 hours
- ENERGY STAR certified*
- 3 Year warranty
- CEC T20/T24

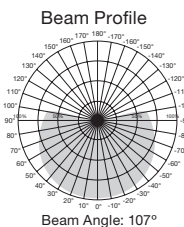

6.5W R20 LED Reflectors

Item Number	Lamp Description	W	V	CRI	CCT	Lm	Bulb Type	M.O.L. (Inches)	Life/ Hrs.	UPC	Pack
S9630*	6.5R20/LED/2700K/525L/120V	6.5	120	80	2700K	525	R20	3 1/16	25K	045923096303	24/6
S9631*	6.5R20/LED/3000K/525L/120V	6.5	120	80	3000K	525	R20	3 1/16	25K	045923096310	24/6
S9632*	6.5R20/LED/4000K/525L/120V	6.5	120	80	4000K	525	R20	3 1/16	25K	045923096327	24/6
S9633*	6.5R20/LED/5000K/525L/120V	6.5	120	80	5000K	525	R20	3 1/16	25K	045923096334	24/6

90 CRI—CEC/T20

S29614*■	6R20/LED/927/120V	6	120	90	2700K	525	R20	3 1/16	25K	045923296147	24/6
S28577*■	6R20/LED/930/120V	6	120	90	3000K	525	R20	3 1/16	25K	045923285776	24/6
S28491*■	6R20/LED/940/120V	6	120	90	4000K	525	R20	3 1/16	25K	045923284915	24/6
S28619*■	6R20/LED/950/120V	6	120	90	5000K	525	R20	3 1/16	25K	045923286193	24/6

■ Also T24 compliant.

Product sheet SA2629

Satco BR30 LED reflectors 80 & 90 CRI

- 65BR30 replacement uses only up to 9.5 Watts
- Indoor residential and commercial lighting
- Display lighting
- New one piece, lighter weight design
- Dimmable
- Long life—25,000 hours
- ENERGY STAR certified*
- 3 Year warranty
- CEC T20/T24

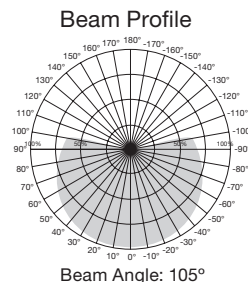

9.5W BR30 LED Reflectors

Item Number	Lamp Description	W	V	CRI	CCT	Lm	Bulb Type	M.O.L. (Inches)	Life/ Hrs.	UPC	Pack
S9620*	9.5BR30/LED/2700K/750L/120V/D	9.5	120	80	2700K	750	BR30	5 3/16	25K	045923096204	12/6
S9621*	9.5BR30/LED/3000K/750L/120V/D	9.5	120	80	3000K	750	BR30	5 3/16	25K	045923096211	12/6
S9622*	9.5BR30/LED/4000K/750L/120V/D	9.5	120	80	4000K	750	BR30	5 3/16	25K	045923096228	12/6
S9623*	9.5BR30/LED/5000K/750L/120V/D	9.5	120	80	5000K	750	BR30	5 3/16	25K	045923096235	12/6
S9624*	9.5BR30/LED/2700K/GU24/750L/120V	9.5	120	80	2700K	750	BR30	4 1/16	25K	045923096242	12/6
S9627	9.5BR30/LED/3000K/GU24/750L/120V	9.5	120	80	3000K	750	BR30	4 1/16	25K	045923096273	12/6

90 CRI—CEC/T20

S29625*■	7.5BR30/LED/927/120V	7.5	120	90	2700K	650	BR30	5 3/16	25K	045923296253	12/6
S28578*■	7.5BR30/LED/930/120V	7.5	120	90	3000K	650	BR30	5 3/16	25K	045923285783	12/6
S28547*■	7.5BR30/LED/935/120V	7.5	120	90	3500K	650	BR30	5 3/16	25K	045923285479	12/6
S28492*■	7.5BR30/LED/940/120V	7.5	120	90	4000K	650	BR30	5 3/16	25K	045923284922	12/6
S28596*	7.5BR30/LED/950/120V	7.5	120	90	5000K	650	BR30	5 3/16	25K	045923285967	12/6
S29626*■	7.5BR30/LED/927/GU24/120V	7.5	120	90	2700K	650	BR30	4 1/16	25K	045923296260	12/6
S28579*■	7.5BR30/LED/930/GU24/120V	7.5	120	90	3000K	650	BR30	4 1/16	25K	045923285790	12/6

■ Also T24 compliant.

Product sheet SA1784

LED REFLECTOR LAMPS DISPLAY PACKS

Satco 10W BR30 LED reflector display packs and 6 packs

- 65W BR30 replacement uses only 10 Watts
- Indoor residential and commercial lighting
- 2700K
- Dimmable
- Damp location
- Long life—25,000 hours
- ENERGY STAR certified*
- 3 Year warranty



6 pack
Contractor pack

Display Pack



10W BR30 LED Reflector Display Packs

Item Number	Lamp Description	W	V	CRI	CCT	Lm	M.O.L. (Inches)	Life/ Hrs.	UPC	Pack/ Master
S29628*	10BR30/LED/2700K/700L/120V/D	10	120	80	2700K	700	5 1/8	25K	045923296284	48
S9021	10BR30/LED/827/120V/6PK	10	120	80	2700K	700	5 1/8	25K	045923090219	4-6pks
S9022*	10BR30/LED/830/120V/6PK	10	120	80	3000K	700	5 1/8	25K	045923090226	4-6pks
S9029	10BR30/LED/840/120V/6PK	10	120	80	4000K	700	5 1/8	25K	045923090295	4-6pks

Must be ordered in full cases only.

Product sheet SA2281

Satco 8W BR30 LED 2-pack display

Great efficiency, even greater value – now in convenient 2-packs

- 65 Watt replacement uses only 8 Watts
- Indoor residential and commercial lighting
- Great for retail end caps or counter areas
- 2700K
- Dimmable*
- Damp location
- High efficiency
- Long life—25,000 hours
- ENERGY STAR certified*
- 3 Year warranty



Sold 24 2-Packs per display



8W BR30 LED 2-Pack Display

Item Number	Lamp Description	W	V	CRI	CCT	Lm	Bm	M.O.L. (Inches)	Life/ Hrs.	UPC	Pack/ Master
S9698*	8BR30/LED/2700K/650L/2PK	8	120	80+	2700K	650	105°	5 3/16	25K	045923096983	24-2pks

Must be ordered in full cases only.

Product sheet SA2042

**See warranty for details.

LED REFLECTOR LAMPS

Satco 11.5W & 16.5W BR40 LED reflectors 80 & 90 CRI

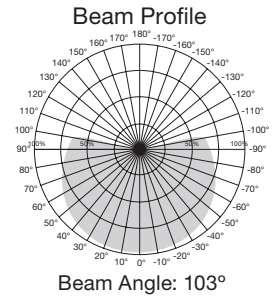

- 65W BR40 replacement uses only up to 13 Watts
- 85W BR40 replacement uses only 16.5 Watts
- Indoor residential and commercial lighting
- Dimmable
- Damp location
- Long life—25,000 hours
- ENERGY STAR certified*
- 3 Year warranty

11.5W & 16.5W BR40 LED Reflectors 80 & 90 CRI



Item Number	Lamp Description	W	V	CRI	CCT	Lm	Bulb Type	M.O.L. (Inches)	Life/Hrs.	UPC	Pack
S9634*	11.5BR40/LED/2700K/940L/120V	11.5	120	80	2700K	940	BR40	6 7/16	25K	045923096341	12/6
S9635*	11.5BR40/LED/3000K/940L/120V	11.5	120	80	3000K	940	BR40	6 7/16	25K	045923096358	12/6
S9636*	11.5BR40/LED/4000K/940L/120V	11.5	120	80	4000K	940	BR40	6 7/16	25K	045923096365	12/6
S9637*	11.5BR40/LED/5000K/940L/120V	11.5	120	80	5000K	940	BR40	6 7/16	25K	045923096372	12/6
S9638*	16.5BR40/LED/2700K/1200L/120V	16.5	120	80	2700K	1200	BR40	6 7/16	25K	045923096389	12/6
S9639*	16.5BR40/LED/3000K/1200L/120V	16.5	120	80	3000K	1200	BR40	6 7/16	25K	045923096396	12/6
S9640*	16.5BR40/LED/4000K/1200L/120V	16.5	120	80	4000K	1200	BR40	6 7/16	25K	045923096402	12/6
S9641*	16.5BR40/LED/5000K/1200L/120V	16.5	120	80	5000K	1200	BR40	6 7/16	25K	045923096419	12/6
90 CRI—CEC/T20											
S29615■	13BR40/LED/927/120V	13	120	90	2700K	1075	BR40	6 7/16	25K	045923296154	12/6
S28580■	13BR40/LED/930/120V	13	120	90	3000K	1075	BR40	6 7/16	25K	045923285806	12/6
S28493■	13BR40/LED/940/120V	13	120	90	4000K	1075	BR40	6 7/16	25K	045923284939	12/6
S28597*	13BR40/LED/950/120V	13	120	90	5000K	1075	BR40	6 7/16	25K	045923285974	12/6

■ Also T24 compliant.

Product sheet SA1812

Satco 7W LED PAR20 - amber



- Solid state LED lighting
- Reflector replacement lamp
- Long life—25,000 hours
- Amber color - 620nm - Sea turtle friendly

7W LED PAR20 - Amber

Item Number	Lamp Description	W	V	CCT	Lm	Bm	M.O.L. (Inches)	Life/Hrs.	UPC	Pack/Master
S29188	7PAR20/LED/40°/AMBER/120V	7	120	AMBER	340	40°	3 1/4	25K	045923291883	24/6

Product sheet SA1641

LED PAR LAMPS

Familiar appearance.
High efficiency.
Direct replacements.

Satco LED PAR Lamps.
LED efficiency, indoors or out.

Satco LED PAR lamps have the familiar look of the Halogen PAR lamps they replace, but deliver the high efficiency that only LEDs can. With the silvered reflector, traditional lens pattern, and exact dimensions of older Halogen PARs, Satco LED PARs represent an exact replacement. The only difference will be the greatly reduced energy and maintenance costs!

7W LED PAR20 lamps

- 50W PAR20 replacement uses only 7 Watts
- Down lighting
- Track lighting
- Dimmable
- IP65 Listed - indoor/outdoor
- Approved for totally enclosed fixtures**
- Long life—25,000 hours
- ENERGY STAR certified*
- 3 Year warranty

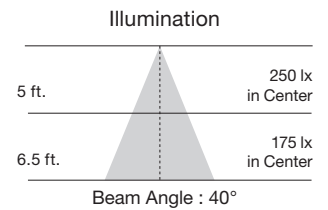
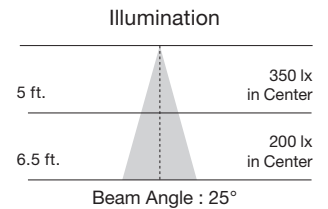

LED PAR Lamps

Item Number	Lamp Description	W	V	CRI	CCT	Color Temp.	Lm	Bm	M.O.L. (Inches)	Life/Hrs.	UPC	Pack
LED PAR20 - Replaces 50W												
S9400*	7PAR20/LED/25/2700K/120V/SP	7	120	80	2700K	Warm White	525	25°	3 1/16	25K	045923094002	24/6
S9401*	7PAR20/LED/25/3000K/120V/SP	7	120	80	3000K	Soft White	525	25°	3 1/16	25K	045923094019	24/6
S9402*	7PAR20/LED/25/3500K/120V/SP	7	120	80	3500K	Neutral White	525	25°	3 1/16	25K	045923094026	24/6
S9403*	7PAR20/LED/25/4000K/120V/SP	7	120	80	4000K	Cool White	525	25°	3 1/16	25K	045923094033	24/6
S9404*	7PAR20/LED/25/5000K/120V/SP	7	120	80	5000K	Natural Light	525	25°	3 1/16	25K	045923094040	24/6
S9405*	7PAR20/LED/40/2700K/120V/FL	7	120	80	2700K	Warm White	525	40°	3 1/16	25K	045923094057	24/6
S9406*	7PAR20/LED/40/3000K/120V/FL	7	120	80	3000K	Soft White	525	40°	3 1/16	25K	045923094064	24/6
S9407*	7PAR20/LED/40/3500K/120V/FL	7	120	80	3500K	Neutral White	525	40°	3 1/16	25K	045923094071	24/6
S9408*	7PAR20/LED/40/4000K/120V/FL	7	120	80	4000K	Cool White	525	40°	3 1/16	25K	045923094088	24/6
S9409*	7PAR20/LED/40/5000K/120V/FL	7	120	80	5000K	Natural Light	525	40°	3 1/16	25K	045923094095	24/6
90 CRI—CEC/T20												
S9485*■	7PAR20/LED/40/27K/90CRI	7	120	90	2700K	Warm White	470	40°	3	25K	045923094859	24/6
S8581*■	7PAR20/LED/40/30K/90CRI	7	120	90	3000K	Soft White	470	40°	3	25K	045923085819	24/6
S8494*	7PAR20/LED/40/40K/90CRI	7	120	90	4000K	Cool White	470	40°	3	25K	045923084942	24/6
S8598*	7PAR20/LED/40/50K/90CRI	7	120	90	5000K	Natural Light	470	40°	3	25K	045923085987	24/6

■ Also T24 compliant.

Product sheet SA1393

**See warranty for details.



www.satco.com

LED PAR LAMPS

13W LED PAR30 short neck lamps

- 50W PAR30 short neck replacement uses only 13 Watts
- Down lighting
- Track lighting
- Dimmable
- IP65 Listed - indoor/outdoor
- Approved for totally enclosed fixtures**
- Long life—25,000 hours
- ENERGY STAR certified*
- 3 Year warranty

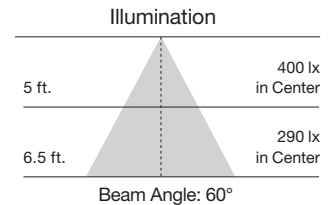
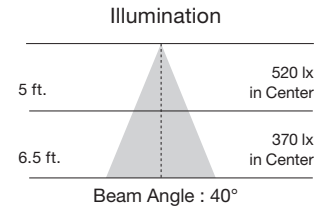
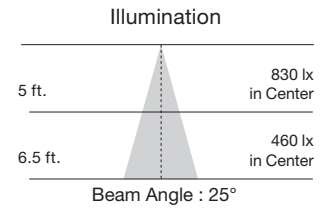

LED PAR Lamps



Item Number	Lamp Description	W	V	CRI	CCT	Color Temp.	Lm	Bm	M.O.L. (Inches)	Life/Hrs.	UPC	Pack
LED PAR30 Short Neck - Replaces 50W												
S9410*	13PAR30/SN/LED/25'/2700K/120V/SP	13	120	80	2700K	Warm White	1000	25°	3 3/8"	25K	045923094101	12/6
S9411*	13PAR30/SN/LED/25'/3000K/120V/SP	13	120	80	3000K	Soft White	1000	25°	3 3/8"	25K	045923094118	12/6
S9412*	13PAR30/SN/LED/25'/3500K/120V/SP	13	120	80	3500K	Neutral White	1000	25°	3 3/8"	25K	045923094125	12/6
S9413*	13PAR30/SN/LED/25'/4000K/120V/SP	13	120	80	4000K	Cool White	1000	25°	3 3/8"	25K	045923094132	12/6
S9414*	13PAR30/SN/LED/25'/5000K/120V/SP	13	120	80	5000K	Natural Light	1000	25°	3 3/8"	25K	045923094149	12/6
S9415*	13PAR30/SN/LED/40'/2700K/120V/FL	13	120	80	2700K	Warm White	1000	40°	3 3/8"	25K	045923094156	12/6
S9416*	13PAR30/SN/LED/40'/3000K/120V/FL	13	120	80	3000K	Soft White	1000	40°	3 3/8"	25K	045923094163	12/6
S9417*	13PAR30/SN/LED/40'/3500K/120V/FL	13	120	80	3500K	Neutral White	1000	40°	3 3/8"	25K	045923094170	12/6
S9418*	13PAR30/SN/LED/40'/4000K/120V/FL	13	120	80	4000K	Cool White	1000	40°	3 3/8"	25K	045923094187	12/6
S9419*	13PAR30/SN/LED/40'/5000K/120V/FL	13	120	80	5000K	Natural Light	1000	40°	3 3/8"	25K	045923094194	12/6
S9420*	13PAR30/SN/LED/60'/2700K/120V/WFL	13	120	80	2700K	Warm White	1000	60°	3 3/8"	25K	045923094200	12/6
S9421*	13PAR30/SN/LED/60'/3000K/120V/WFL	13	120	80	3000K	Soft White	1000	60°	3 3/8"	25K	045923094217	12/6
S9422*	13PAR30/SN/LED/60'/3500K/120V/WFL	13	120	80	3500K	Neutral White	1000	60°	3 3/8"	25K	045923094224	12/6
S9423*	13PAR30/SN/LED/60'/4000K/120V/WFL	13	120	80	4000K	Cool White	1000	60°	3 3/8"	25K	045923094231	12/6
S9424*	13PAR30/SN/LED/60'/5000K/120V/WFL	13	120	80	5000K	Natural Light	1000	60°	3 3/8"	25K	045923094248	12/6
90 CRI—CEC/T20												
S9486*■	13PAR30/SN/LED/40'/27K/90CRI	13	120	90	2700K	Warm White	820	40°	3 3/8"	25K	045923094866	12/6
S8582*■	13PAR30/SN/LED/40'/30K/90CRI	13	120	90	3000K	Soft White	820	40°	3 3/8"	25K	045923085826	12/6
S8495*	13PAR30/SN/LED/40'/40K/90CRI	13	120	90	4000K	Cool White	820	40°	3 3/8"	25K	045923084959	12/6

■ Also T24 compliant.

Product sheet SA1393

LED PAR LAMPS

13W LED PAR30 long neck lamps

- 75W PAR30 long neck replacement uses only 13 Watts
- Down lighting
- Track lighting
- Dimmable
- IP65 Listed - indoor/outdoor
- Approved for totally enclosed fixtures**
- Long life—25,000 hours
- ENERGY STAR certified*
- 3 Year warranty

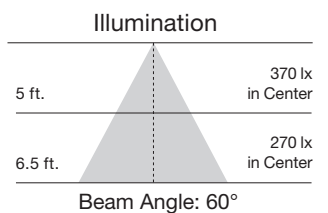
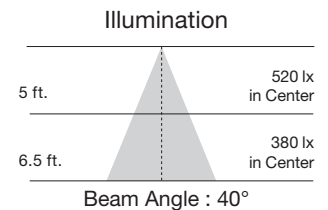
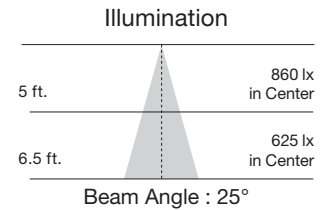

LED PAR Lamps



Item Number	Lamp Description	W	V	CRI	CCT	Color Temp.	Lm	Bm	M.O.L. (Inches)	Life/Hrs.	UPC	Pack
LED PAR30 Long Neck - Replaces 75W												
S9425*	13PAR30/LN/LED/25'/2700K/120V/SP	13	120	80	2700K	Warm White	1000	25°	4 1/16	25K	045923094255	12/6
S9426*	13PAR30/LN/LED/25'/3000K/120V/SP	13	120	80	3000K	Soft White	1000	25°	4 1/16	25K	045923094262	12/6
S9427*	13PAR30/LN/LED/25'/3500K/120V/SP	13	120	80	3500K	Neutral White	1000	25°	4 1/16	25K	045923094279	12/6
S9428*	13PAR30/LN/LED/25'/4000K/120V/SP	13	120	80	4000K	Cool White	1000	25°	4 1/16	25K	045923094286	12/6
S9429*	13PAR30/LN/LED/25'/5000K/120V/SP	13	120	80	5000K	Natural Light	1000	25°	4 1/16	25K	045923094293	12/6
S9430*	13PAR30/LN/LED/40'/2700K/120V/FL	13	120	80	2700K	Warm White	1000	40°	4 1/16	25K	045923094309	12/6
S9431*	13PAR30/LN/LED/40'/3000K/120V/FL	13	120	80	3000K	Soft White	1000	40°	4 1/16	25K	045923094316	12/6
S9432*	13PAR30/LN/LED/40'/3500K/120V/FL	13	120	80	3500K	Neutral White	1000	40°	4 1/16	25K	045923094323	12/6
S9433*	13PAR30/LN/LED/40'/4000K/120V/FL	13	120	80	4000K	Cool White	1000	40°	4 1/16	25K	045923094330	12/6
S9434*	13PAR30/LN/LED/40'/5000K/120V/FL	13	120	80	5000K	Natural Light	1000	40°	4 1/16	25K	045923094347	12/6
S9435*	13PAR30/LN/LED/60'/2700K/120V/WFL	13	120	80	2700K	Warm White	1000	60°	4 1/16	25K	045923094354	12/6
S9436*	13PAR30/LN/LED/60'/3000K/120V/WFL	13	120	80	3000K	Soft White	1000	60°	4 1/16	25K	045923094361	12/6
S9437*	13PAR30/LN/LED/60'/3500K/120V/WFL	13	120	80	3500K	Neutral White	1000	60°	4 1/16	25K	045923094378	12/6
S9438*	13PAR30/LN/LED/60'/4000K/120V/WFL	13	120	80	4000K	Cool White	1000	60°	4 1/16	25K	045923094385	12/6
S9439*	13PAR30/LN/LED/60'/5000K/120V/WFL	13	120	80	5000K	Natural Light	1000	60°	4 1/16	25K	045923094392	12/6
90 CRI—CEC/T20												
S9487*■	13PAR30/LN/LED/40'/27K/90CRI	13	120	90	2700K	Warm White	820	40°	4 19/32	25K	045923094873	12/6
S8583*■	13PAR30/LN/LED/40'/30K/90CRI	13	120	90	3000K	Soft White	820	40°	4 19/32	25K	045923085833	12/6
S8496*	13PAR30/LN/LED/40'/40K/90CRI	13	120	90	4000K	Cool White	820	40°	4 19/32	25K	045923084966	12/6

■ Also T24 compliant.

Product sheet SA1393

**See warranty for details.

SATCO | NUVO

www.satco.com

39

LED PAR LAMPS

15 & 18W LED PAR38 lamps

- 90 & 100W PAR38 replacement uses only 15-18 Watts
- Down lighting • Track lighting
- Dimmable
- IP65 Listed—indoor/outdoor
- Approved for totally enclosed fixtures**
- Long life—25,000 hours
- ENERGY STAR certified*
- 3 Year warranty

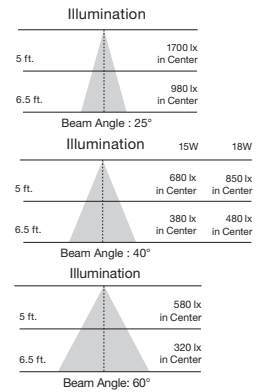

LED PAR Lamps



Item Number	Lamp Description	W	V	CRI	CCT	Color Temp.	Lm	Bm	M.O.L. (Inches)	Life/ Hrs.	UPC	Pack
LED PAR38 - Replaces 90W												
S9440*	15PAR38/LED/25'/2700K/120V/SP	15	120	80	2700K	Warm White	1200	25°	5 3/16	25K	045923094408	12/6
S9441*	15PAR38/LED/25'/3000K/120V/SP	15	120	80	3000K	Soft White	1200	25°	5 3/16	25K	045923094415	12/6
S9442*	15PAR38/LED/25'/3500K/120V/SP	15	120	80	3500K	Neutral White	1200	25°	5 3/16	25K	045923094422	12/6
S9443*	15PAR38/LED/25'/4000K/120V/SP	15	120	80	4000K	Cool White	1200	25°	5 3/16	25K	045923094439	12/6
S9444*	15PAR38/LED/25'/5000K/120V/SP	15	120	80	5000K	Natural Light	1200	25°	5 3/16	25K	045923094446	12/6
S9445*	15PAR38/LED/40'/2700K/120V/FL	15	120	80	2700K	Warm White	1200	40°	5 3/16	25K	045923094453	12/6
S9446*	15PAR38/LED/40'/3000K/120V/FL	15	120	80	3000K	Soft White	1200	40°	5 3/16	25K	045923094460	12/6
S9447*	15PAR38/LED/40'/3500K/120V/FL	15	120	80	3500K	Neutral White	1200	40°	5 3/16	25K	045923094477	12/6
S9448*	15PAR38/LED/40'/4000K/120V/FL	15	120	80	4000K	Cool White	1200	40°	5 3/16	25K	045923094484	12/6
S9449*	15PAR38/LED/40'/5000K/120V/FL	15	120	80	5000K	Natural Light	1200	40°	5 3/16	25K	045923094491	12/6
S9450*	15PAR38/LED/60'/2700K/120V/WFL	15	120	80	2700K	Warm White	1200	60°	5 3/16	25K	045923094507	12/6
S9451*	15PAR38/LED/60'/3000K/120V/WFL	15	120	80	3000K	Soft White	1200	60°	5 3/16	25K	045923094514	12/6
S9452*	15PAR38/LED/60'/3500K/120V/WFL	15	120	80	3500K	Neutral White	1200	60°	5 3/16	25K	045923094521	12/6
S9453*	15PAR38/LED/60'/4000K/120V/WFL	15	120	80	4000K	Cool White	1200	60°	5 3/16	25K	045923094538	12/6
S9454*	15PAR38/LED/60'/5000K/120V/WFL	15	120	80	5000K	Natural Light	1200	60°	5 3/16	25K	045923094545	12/6
90 CRI—CEC/T20												
S9488*■	15PAR38/LED/40'/27K	15	120	90	2700K	Warm White	1000	40°	5 3/16	25K	045923094880	12/6
S8584*■	15PAR38/LED/40'/30K	15	120	90	3000K	Soft White	1000	40°	5 3/16	25K	045923085840	12/6
S8497*	15PAR38/LED/40'/40K	15	120	90	4000K	Cool White	1000	40°	5 3/16	25K	045923084973	12/6
S8498*	15PAR38/LED/40'/50K	15	120	90	5000K	Natural Light	1000	40°	5 3/16	25K	045923084980	12/6
LED PAR38 - Replaces 100W												
S9455*	18PAR38/LED/40'/3000K/120V/FL	18	120	80	3000K	Soft White	1400	40°	5 3/16	25K	045923094552	12/6
S9456*	18PAR38/LED/40'/4000K/120V/FL	18	120	80	4000K	Cool White	1400	40°	5 3/16	25K	045923094569	12/6
LED PAR38 - Non-Dimmable 2 Pack - Replaces 90W												
S9457*	15PAR38/LED/60'/3000K/120V/2PK	15	120	80	3000K	Soft White	1150	60°	5 3/16	25K	045923094576	8-2pks
LED PAR38 - Colors												
S9480	15PAR38/LED/40'/RED/120V	15	120	—	—	Red	—	40°	5 3/16	25K	045923094804	12/6
S9481	15PAR38/LED/40'/GREEN/120V	15	120	—	—	Green	—	40°	5 3/16	25K	045923094811	12/6
S9482	15PAR38/LED/40'/BLUE/120V	15	120	—	—	Blue	—	40°	5 3/16	25K	045923094828	12/6
S9483	15PAR38/LED/40'/AMBER/120V	15	120	—	—	Amber	—	40°	5 3/16	25K	045923094835	12/6
S9484	15PAR38/LED/40'/YELLOW/120V	15	120	—	—	Yellow	—	40°	5 3/16	25K	045923094842	12/6

■ Also T24 compliant.

Product sheet SA1393

HIGH LUMEN LED PAR LAMPS



Econo PAR lamps

- Down lighting
- Track lighting
- Dimmable
- Indoor/outdoor
- Approved for enclosed fixtures**
- 3 Year warranty



Econo PAR Lamps

Item Number	Lamp Description	W	V	CRI	CCT	Finish.	Lm	Bm	M.O.L. (Inches)	Life/ Hrs.	UPC	Pack
50 PAR20 Replacement												
S12210	6PAR20/LED/830/FL/120V	6	120	80	3000K	WHITE	500	40°	3 7/8	11K	045923122101	24
S12211	6PAR20/LED/840/FL/120V	6	120	80	4000K	WHITE	500	40°	3 7/8	11K	045923122118	24
75 PAR30 Replacement												
S12212	8.9PAR30S/LED/830/FL/120V	8.9	120	80	3000K	WHITE	700	40°	3 3/8	11K	045923122125	12
S12213	8.9PAR30S/LED/840/FL/120V	8.9	120	80	4000K	WHITE	700	40°	3 3/8	11K	045923122132	12
S12214	8.9PAR30L/LED/830/FL/120V	8.9	120	80	3000K	WHITE	700	40°	4 7/16	11K	045923122149	12
S12215	8.9PAR30L/LED/840/FL/120V	8.9	120	80	4000K	WHITE	700	40°	4 7/16	11K	045923122156	12
90 PAR38 Replacement												
S12216	13PAR38/LED/830/FL/120V	13	120	80	3000K	WHITE	1000	40°	5 1/8	11K	045923122163	12
S12217	13PAR38/LED/840/FL/120V	13	120	80	4000K	WHITE	1000	40°	5 1/8	11K	045923122170	12

**See warranty for details.

HIGH LUMEN LED PAR LAMPS



High lumen LED PAR lamps

A high lumen, high efficiency option for all PAR38 lamps

Features

- Direct replacement for 250W PAR lamps only 33 Watts
- High ceiling applications
- Saves over 80% on energy costs
- 120V
- High efficiency and beam control
- 2700K, 3000K, 4000K, and 5000K options
- Approved for totally enclosed fixtures**
- Long life—25,000 hours
- 5 Year limited warranty

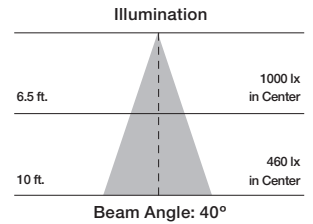
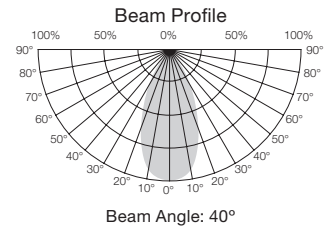

High Lumen PAR ED Lamps



Item Number	Lamp Description	W	V	CRI	CCT	Lm	Bm	M.O.L. (Inches)	Life/Hrs.	UPC	Pack/Mstr.
S12250*	33PAR38/LED/827/HL/120V/FL	33	120V	80	2700K	3000	40°	5.125	25K	045923122507	12/1
S12251*	33PAR38/LED/830/HL/120V/FL	33	120V	80	3000K	3000	40°	5.125	25K	045923122514	12/1
S12252*	33PAR38/LED/840/HL/120V/FL	33	120V	80	4000K	3000	40°	5.125	25K	045923122521	12/1
S12253*	33PAR38/LED/850/HL/120V/FL	33	120V	80	5000K	3000	40°	5.125	25K	045923122538	12/1

** Average rated life may vary depending on application, use, fixture type and environment.

Product sheet SA2563

LED PAR16 & MR11 LAMPS

LED PAR16 4.5 & 6.5W lamps

- 45W & 60W Halogen PAR16 lamp replacement uses only 4.5-6.5 Watts
- Indoor residential and commercial lighting
- Down lighting
- Accent lighting
- Pendant lighting
- Dimmable
- Damp location
- Approved for totally enclosed fixtures**
- Long life—25,000 hours
- 3 Year warranty

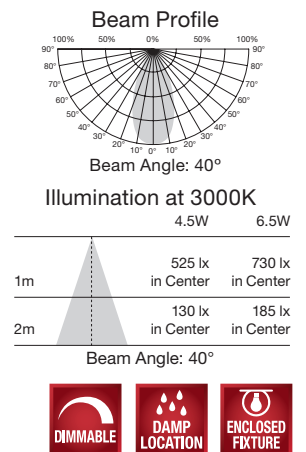

LED PAR16 Lamps

Item Number	Lamp Description	W	V	CRI	CCT	Lm	Bm	M.O.L. (Inches)	Life/Hrs.	UPC	Pack
S9386	4.5PAR16/LED/40°/3000K/120V	4.5	120	80	3000K	370	40°	2 7/8	25K	045923093869	12/1
S9387	4.5PAR16/LED/40°/5000K/120V	4.5	120	80	5000K	370	40°	2 7/8	25K	045923093876	12/1
S9388	6.5PAR16/LED/40°/3000K/120V	6.5	120	80	3000K	520	40°	2 7/8	25K	045923093883	12/1
S9389	6.5PAR16/LED/40°/5000K/120V	6.5	120	80	5000K	520	40°	2 7/8	25K	045923093890	12/1
90 CRI—CEC/T20											
S8585	4PAR16/LED/40°/30K/120V	4	120	90	3000K	360	40°	2 7/8	25K	045923085857	12/1

Product sheet SA1744

1.6W & 3W, 12V LED MR11 lamps

- 20 Watt MR11 replacement, uses up to 3 Watts
- Indoor residential and commercial lighting
- Down lighting
- Accent lighting
- Pendant lighting
- Non-dimmable
- Damp location
- Approved for totally enclosed fixtures**
- Long life—25,000 hours
- 3 Year warranty



S9280, S9281, S9282, S9283



S9550, S9551

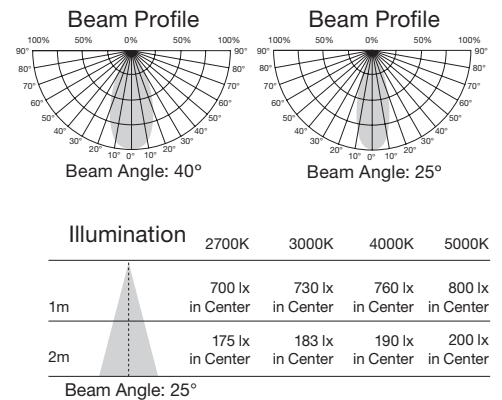

1.6W & 3W, 12V LED MR11 Lamps With GU4 Base

Item Number	Lamp Description	W	V	CRI	CCT	Lm	Bm	M.O.L. (Inches)	Life/Hrs.	UPC	Pack
S9280	3MR11/LED/25°/2700K/12V	3	12	80	2700K	210	25°	1 1/2	25K	045923092800	12/1
S9281	3MR11/LED/25°/3000K/12V	3	12	80	3000K	220	25°	1 1/2	25K	045923092817	12/1
S9282	3MR11/LED/25°/4000K/12V	3	12	80	4000K	230	25°	1 1/2	25K	045923092824	12/1
S9283	3MR11/LED/25°/5000K/12V	3	12	80	5000K	240	25°	1 1/2	25K	045923092831	12/1
S8603	3MR11/LED/25°/3000K/12V	3	12	80	3000K	210	25°	1 1/2	25K	045923086038	12/1
S9550	LED/1.6MR11/40°/3000K/12V/D	1.6	12	80	3000K	200	40°	1 1/2	25K	045923095504	20/1
S9551	LED/1.6MR11/40°/5000K/12V/D	1.6	12	80	5000K	200	40°	1 1/2	25K	045923095511	20/1

Product sheet SA1679

**See warranty for details.

MR16 LED LAMPS

LED MR16 lamps

- Down lighting
- Accent lighting
- Pendant lighting
- Dimmable
- Approved for totally enclosed fixtures**
- Long life—25,000 hours
- ENERGY STAR certified*
- 3 Year warranty



S9552, S9553



S9490, S9491, S9492, S9493, S9494, S9495, S9496, S9497, S9498, S9499, S9616



S8635, S8636, S8637, S8638, S8639, S8640, S8641, S8642, S8643, S8644

LED MR16 Lamps



Item Number	Lamp Description	W	V	CRI	CCT	Lm	Bm	M.O.L. (Inches)	Life/Hrs.	UPC	Pack
S9552	LED/3MR16/40/3000K/12V/D	3	12	80	3000K	330	40°	2	25K	045923095528	20/1
S9553	LED/3MR16/40/5000K/12V/D	3	12	80	5000K	330	40°	2	25K	045923095535	20/1
80 CRI - 50W Replacement - CEC/T20											
S9490*	6.5MR16/LED/25/27K/12V	6.5	12	80	2700K	500	25°	1 3/4	25K	045923094903	12/1
S9491*	6.5MR16/LED/25/30K/12V	6.5	12	80	3000K	500	25°	1 3/4	25K	045923094910	12/1
S9492	6.5MR16/LED/25/35K/12V	6.5	12	80	3500K	500	25°	1 3/4	25K	045923094927	12/1
S9493	6.5MR16/LED/25/40K/12V	6.5	12	80	4000K	500	25°	1 3/4	25K	045923094934	12/1
S9494	6.5MR16/LED/25/50K/12V	6.5	12	80	5000K	500	25°	1 3/4	25K	045923094941	12/1
S9495*	6.5MR16/LED/40/27K/12V	6.5	12	80	2700K	500	40°	1 3/4	25K	045923094958	12/1
S9496*	6.5MR16/LED/40/30K/12V	6.5	12	80	3000K	500	40°	1 3/4	25K	045923094965	12/1
S9497*	6.5MR16/LED/40/35K/12V	6.5	12	80	3500K	500	40°	1 3/4	25K	045923094972	12/1
S9498*	6.5MR16/LED/40/40K/12V	6.5	12	80	4000K	500	40°	1 3/4	25K	045923094989	12/1
S9499*	6.5MR16/LED/40/50K/12V	6.5	12	80	5000K	500	40°	1 3/4	25K	045923094996	12/1
S8604	6.5MR16/LED/40/30K/120V/GU10	6.5	120	80	3000K	500	40°	2	25K	045923086045	12/1
90 CRI											
S9616*■	6.5MR16/LED/40/30K/12V/90CRI	6.5	12	90	3000K	450	40°	1 3/4	25K	045923094965	12/1
Single Optic - 75W Replacement - CEC/T20											
S8635	8MR16/LED/15/27K/90CRI/12V	8	12	90	2700K	490	15°	1 7/8	25K	045923086359	12/1
S8636	8MR16/LED/15/30K/90CRI/12V	8	12	90	3000K	490	15°	1 7/8	25K	045923086366	12/1
S8637	8MR16/LED/15/35K/90CRI/12V	8	12	90	3500K	490	15°	1 7/8	25K	045923086373	12/1
S8638	8MR16/LED/15/40K/90CRI/12V	8	12	90	4000K	490	15°	1 7/8	25K	045923086380	12/1
S8639	8MR16/LED/15/50K/90CRI/12V	8	12	90	5000K	490	15°	1 7/8	25K	045923086397	12/1
S8640*	8MR16/LED/40/27K/90CRI/12V	8	12	90	2700K	490	40°	1 7/8	25K	045923086403	12/1
S8641*	8MR16/LED/40/30K/90CRI/12V	8	12	90	3000K	490	40°	1 7/8	25K	045923086410	12/1
S8642	8MR16/LED/40/35K/90CRI/12V	8	12	90	3500K	490	40°	1 7/8	25K	045923086427	12/1
S8643	8MR16/LED/40/40K/90CRI/12V	8	12	90	4000K	490	40°	1 7/8	25K	045923086434	12/1
S8644	8MR16/LED/40/50K/90CRI/12V	8	12	90	5000K	490	40°	1 7/8	25K	045923086441	12/1

All 12V MR16 lamps are compatible with electronic and magnetic transformers. Visit www.satco.com for compatibility information and warranty details.

■ Also T24 compliant.

Product sheet SA1902

MR16 GU10 LED LAMPS

MR16 GU10 base LED lamps

Applications

- Indoor residential and commercial lighting
- Down lighting
- Accent lighting
- Pendant lighting

Features

- Direct replacement for Halogen lamps
4.5W = 35 Watts
6.5W = 50 Watts – 25° (new) and 40°
- Dimmable
- Damp location
- Approved for enclosed fixtures**
- Long life - 25,000 hours
- High efficiency / environmentally friendly
- Innovative design
- No UV or IR radiation
- 3 year warranty

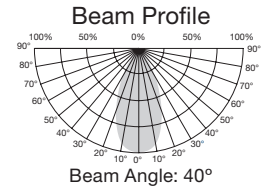

Beam Angle	4.5W	6.5W
3.25 ft.	565 lx in Center	760 lx in Center
6.5 ft.	141 lx in Center	190 lx in Center

Beam Angle : 40°

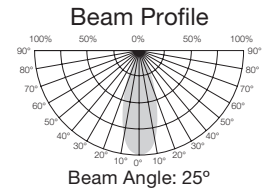

Beam Angle	6.5W
3.25 ft.	475 lx in Center
6.5 ft.	118 lx in Center

Beam Angle : 25°

MR16 GU10 LED Lamps



Item Number	Lamp Description	W	V	CRI	CCT	Lm	Bm	M.O.L. (Inches)	Life/Hrs.	UPC
S9380*	4.5MR16/LED/40°/30K/120V/GU10	4.5	120	80	3000K	370	40°	2 3/16	25K	045923093807
S9381	4.5MR16/LED/40°/50K/120V/GU10	4.5	120	80	5000K	370	40°	2 3/16	25K	045923093814
S8676	6.5MR16/LED/25°/27K/120V/GU10	6.5	120	80	2700K	500	25°	2 9/32	25K	045923086762
S8677	6.5MR16/LED/25°/30K/120V/GU10	6.5	120	80	3000K	500	25°	2 9/32	25K	045923086779
S8678	6.5MR16/LED/25°/40K/120V/GU10	6.5	120	80	4000K	500	25°	2 9/32	25K	045923086786
S8679	6.5MR16/LED/25°/50K/120V/GU10	6.5	120	80	5000K	500	25°	2 9/32	25K	045923086793
S9382	6.5MR16/LED/40°/27K/120V/GU10	6.5	120	80	2700K	500	40°	2 3/16	25K	045923093821
S9383*	6.5MR16/LED/40°/30K/120V/GU10	6.5	120	80	3000K	500	40°	2 3/16	25K	045923093838
S9384	6.5MR16/LED/40°/40K/120V/GU10	6.5	120	80	4000K	500	40°	2 3/16	25K	045923093845
S9385*	6.5MR16/LED/40°/50K/120V/GU10	6.5	120	80	5000K	500	40°	2 3/16	25K	045923093852
S8605	6.5MR16/LED/40°/30K/12V	6.5	12	80	3000K	500	40°	1 25/32	25K	045923086052

90 CRI – CEC/T20

S8588	6.5MR16/LED/40°/27K/120V/GU10	6.5	120	90+	2700K	450	40°	2 3/16	25K	045923085888
S8589	6.5MR16/LED/40°/30K/120V/GU10	6.5	120	90+	3000K	450	40°	2 3/16	25K	045923085895

Pack Master 12/1

Product sheet SA1729

**See warranty for details.

MR16 E26 LED LAMPS

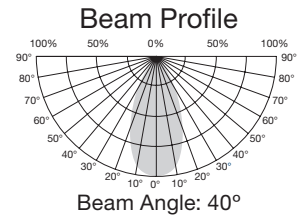

LED MR16 E26 base lamps

Applications

- Indoor residential and commercial lighting
- Downlighting
- Accent lighting
- Pendant lighting

Features

- Direct replacement for 50 Watt Halogen lamps — uses only 6.5 Watts
- Innovative design
- Dimmable
- Damp location
- Approved for enclosed fixtures
- Long life - 25,000 hours
- No UV or IR radiation
- 3 year warranty

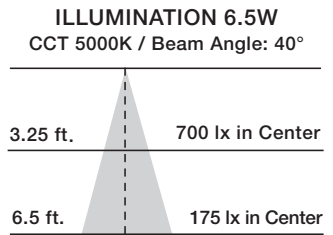

LED MR16 E26 Base Lamps



Item No.	Description	W	V	CCT	Lm	CRI	Life/Hrs.	Beam Angle	UPC
S9980	6.5MR16/E26/LED/40°/27K/120V	6.5	120V	2700K	500	80	25,000	40	045923099809
S9981	6.5MR16/E26/LED/40°/30K/120V	6.5	120V	3000K	500	80	25,000	40	045923099816
S9982	6.5MR16/E26/LED/40°/40K/120V	6.5	120V	4000K	500	80	25,000	40	045923099823
S9983	6.5MR16/E26/LED/40°/50K/120V	6.5	120V	5000K	500	80	25,000	40	045923099830

Silicon LED replacements for Halogen G4, G6.35, G8 and G9 lamps

- Solid state LED lighting
- High efficacy
- Omni-directional light
- Dimmable
- Long life—25,000 hours
- Approved for enclosed fixtures*

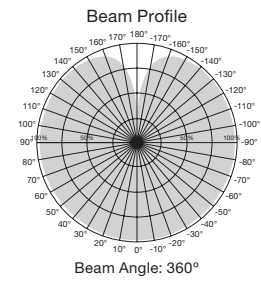

Silicon LED Replacements for Halogen G4, G6.35, G8 & G9 Lamps



Item Number	Lamp Description	W	V	Finish	Base	CRI	CCT	Lm	M.O.L. (Inches)	Life/Hrs.	UPC	Pk.
G4 Bi-Pin												
S9542	LED/1.6W/JC/G4/12V/3000K/200L/360°	1.6	12	Clear	G4	80	3000K	200	1 7/16	25K	045923095429	20/1
S8600	LED/1.6W/JC/G4/12V/3K/ CARDED	1.6	12	Clear	G4	80	3000K	200	1 7/16	25K	045923086007	12/1
S9543	LED/1.6W/JC/G4/12V/5000K/200L/360°	1.6	12	Clear	G4	80	5000K	200	1 7/16	25K	045923095436	20/1
G6.35												
S9544	LED/3W/JC/G6.35/12V/3000K/300L/360°	3	12	Clear	G6.35	80	3000K	300	1 5/8	25K	045923095443	20/1
S8601	LED/3W/JC/G6.35/12V/3K/ CARDED	3	12	Clear	G6.35	80	3000K	300	1 5/8	25K	045923086014	12/1
S9545	LED/3W/JC/G6.35/12V/5000K/300L/360°	3	12	Clear	G6.35	80	5000K	300	1 5/8	25K	045923095450	20/1
G8												
S28680	LED/4W/JC/G8/CL/3K/120V	4	120-130	Clear	G8	80	3000K	480	2	25K	045923286803	20/1
S28681	LED/4W/JC/G8/CL/5K/120V	4	120-130	Clear	G8	80	5000K	480	2	25K	045923286810	20/1
G9												
S9546	LED/1.6W/JCD/G9/120V/3000K	1.6	120	Clear	G9	80	3000K	200	1 7/8	25K	045923095467	20/1
S9547	LED/1.6W/JCD/G9/120V/5000K	1.6	120	Clear	G9	80	5000K	200	1 7/8	25K	045923095474	20/1
S29548	LED/4W/JCD/G9/120V/3000K	4	120-130	Clear	G9	80	3000K	480	2 7/16	25K	045923295485	20/1
S28602	LED/4W/JCD/G9/120V/3K/ CARDED	4	120-130	Clear	G9	80	3000K	480	2 7/16	25K	045923286025	12/1
S28682	LED/4W/JCD/G9/FR/3000K/120V	4	120-130	Frost	G9	80	3000K	460	2 7/16	25K	045923286827	20/1
S29549	LED/4W/JCD/G9/CL/120V/5000K	4	120-130	Clear	G9	80	5000K	480	2 7/16	25K	045923295492	20/1
S28683	LED/4W/JCD/G9/FR/5000K/120V	4	120-130	Frost	G9	80	5000K	460	2 7/16	25K	045923286834	20/1
S29697	LED/4W/JCD/G9/120V/3K/90CRI	4	120-130	Clear	G9	90	3000K	360	2 7/16	25K	045923296970	20/1

*Visit satco.com for use information.

**See warranty for details.

Silicon LED replacements for Halogen E11, E12, BA15D, and BA15S lamps

- Solid state LED lighting
- High efficacy
- Omni-directional light
- E11—Mini Can
- Dimmable
- Long life—25,000 hours



Silicon LED Replacements for Halogen E12 and BA15D Lamps

Item Number	Lamp Description	W	V	Finish	Base	CRI	CCT	Lm	M.O.L. (Inches)	Life/Hrs.	UPC	Pk.
E11 Mini Can												
S28684	LED/4W/E11/MC/CL/3K/120V	4	120-130	Clear	E11	80	3000K	480	2 5/16	25K	045923286841	20/1
S28685	LED/4W/E11/MC/CL/5K/120V	4	120-130	Clear	E11	80	5000K	480	2 5/16	25K	045923286858	20/1
S28686	LED/4W/E11/MC/FR/3K/120V	4	120-130	Frost	E11	80	3000K	460	2 5/16	25K	045923286865	20/1
S28687	LED/4W/E11/MC/FR/5K/120V	4	120-130	Frost	E11	80	5000K	460	2 5/16	25K	045923286872	20/1
E12												
S11210	LED/4W/E12/CL/3K	4	120-130	Clear	E12	80	3000K	480	1/2	25K	045923112102	20/1
S11211	LED/4W/E12/CL/5K	4	120-130	Clear	E12	80	5000K	480	1/2	25K	045923112119	20/1
S11212	LED/4W/E12/FR/3K	4	120-130	Frost	E12	80	3000K	460	1/2	25K	045923112126	20/1
S11213	LED/4W/E12/FR/5K	4	120-130	Frost	E12	80	5000K	460	1/2	25K	045923112133	20/1
BA15D												
S11214	LED/4W/BA15D/CL/3K	4	120-130	Clear	BA15D	80	3000K	480	2 1/2	25K	045923112140	20/1
S11215	LED/4W/BA15D/CL/5K	4	120-130	Clear	BA15D	80	5000K	480	2 1/2	25K	045923112157	20/1
S11216	LED/4W/BA15D/FR/3K	4	120-130	Frost	BA15D	80	3000K	460	2 1/2	25K	045923112164	20/1
S11217	LED/4W/BA15D/FR/5K	4	120-130	Frost	BA15D	80	5000K	460	2 1/2	25K	045923112171	20/1
BA15S												
S8688	LED/3W/BA15S/CL/3K/12V	3	12	Clear	BA15S	80	3000K	330	1 5/8	25K	045923086885	20/1
S8689	LED/3W/BA15S/CL/5K/12V	3	12	Clear	BA15S	80	5000K	330	1 9/16	25K	045923086892	20/1

Hi-Pro LED A23 & A25 lamps

Applications

- For use in bollard and post top lighting
- High ceiling recessed lighting

Features

- Replaces high lumen incandescent and CFL lamps and A25 series up to 150W HID
- 25W - E26 and EX39 / up to 3600 lumens
- 35W - EX39 / up to 4800 lumens
- Saves over 80% on energy costs
- Advanced heat dissipation design
- Direct wire range voltage 120-277V
- High efficiency—up to 145 LPW
- 2700K, 4000K, 5000K and 6500K options
- Base up, base down or horizontal operation
- Damp location
- Long life—50,000 hours
- 5 Year limited warranty



S13100



S13104

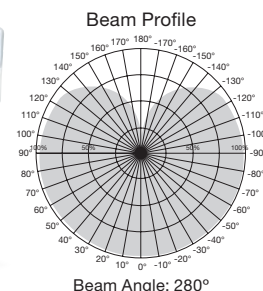

High Lumen A23 & A25 Industrial/Commercial Lamps



Item Number	Lamp Description	W	V	CRI	CCT	Lm	Bm	M.O.L. (Inches)	Life/Hrs.	UPC	Pack/Mstr.
S13100**	25WA23/LED/2700K/120-277V/E26	25	120-277V	80	2700K	3375	280°	6.28	50K	045923131004	24
S13101**	25WA23/LED/4000K/120-277V/E26	25	120-277V	80	4000K	3575	280°	6.28	50K	045923131011	24
S13102**	25WA23/LED/5000K/120-277V/E26	25	120-277V	80	5000K	3625	280°	6.28	50K	045923131028	24
S13103	25WA23/LED/6500K/120-277V/E26	25	120-277V	80	6500K	3625	280°	6.28	50K	045923131035	24
S13104*	25WA23/LED/HID/2700K/120-277V/EX39	25	120-277V	80	2700K	3375	280°	6.66	50K	045923131042	24
S13105*	25WA23/LED/HID/4000K/120-277V/EX39	25	120-277V	80	4000K	3575	280°	6.66	50K	045923131059	24
S13106*	25WA23/LED/HID/5000K/120-277V/EX39	25	120-277V	80	5000K	3625	280°	6.66	50K	045923131066	24
S13107	25WA23/LED/HID/6500K/120-277V/EX39	25	120-277V	80	6500K	3625	280°	6.66	50K	045923131073	24
S13108*	35WA25/LED/HID/2700K/120-277V/EX39	35	120-277V	80	2700K	4480	280°	7.25	50K	045923131080	24
S13109*	35WA25/LED/HID/4000K/120-277V/EX39	35	120-277V	80	4000K	4725	280°	7.25	50K	045923131097	24
S13110*	35WA25/LED/HID/5000K/120-277V/EX39	35	120-277V	80	5000K	4830	280°	7.25	50K	045923131103	24
S13111	35WA25/LED/HID/6500K/120-277V/EX39	35	120-277V	80	6500K	4830	280°	7.25	50K	045923131110	24

**See warranty for details.

Hi-Pro LED lamps

Third generation, high lumen, omni-directional lamps for industrial and commercial applications

Upgraded Features

- Improved heat sink design with advanced passive heat dissipation
- Reduced size / lighter weight
- Higher efficiency, increased lumen output
- Built-in surge protection on all items
 - 18W – 22W 2.5KV
 - 36W – 54W 4KV
 - 80W – 120W 6KV

Standard Features

- Replaces HID, CFL, and Incandescent
- Direct wire range voltage 100-277V
- Approved for totally enclosed fixtures**
- IP64-Damp location
- 3 CCT options
- High bay/low bay/post top
- DLC listed*
- Long life – 50,000 hours
- 5 Year limited warranty**



S39390
18W



S39392
36W



S39394
54W



S39397
120W

Hi-Pro LED lamps

- cULus listed – replacement lamps
- cULus classified – retrofits



High Lumen Industrial/Commercial LED Lamps



Item Number	Lamp Description	Replaces Inc/CFL/HID	W	V	Base Type	CCT	Lm	M.O.L. (Inches)	Life/ Hrs.	UPC	Pk/ Mstr.
S39670	18W/LED/HID/2700K/100-277V/E26	120/32/70	18	100-277	E26	2700K	2340	5.69	50K	045923306709	24
S39390	18W/LED/HID/5000K/100-277V/E26	120/32/70	18	100-277	E26	5000K	2520	5.69	50K	045923303906	24
S39671	22W/LED/HID/2700K/100-277V/E26	150/40/100	22	100-277	E26	2700K	2860	5.95	50K	045923306716	24
S39391	22W/LED/HID/5000K/100-277V/E26	150/40/100	22	100-277	E26	5000K	3080	5.95	50K	045923303913	24
S39672	36W/LED/HID/2700K/100-277V/E26	200/55/150	36	100-277	E26	2700K	4680	7.37	50K	045923306723	12
S39392	36W/LED/HID/5000K/100-277V E26	200/55/150	36	100-177	E26	5000K	4680	7.37	50K	045923303920	12
S39738	45W/LED/HID/4000K/100-277V E26	300/65/175	45	100-277	E26	4000K	6300	8.51	50K	045923397387	12
S39739	45W/LED/HID/5000K/100-277V E26	300/65/175	45	100-277	E26	5000K	6435	8.51	50K	045923397394	12
S39673	45W/LED/HID/4000K/100-277V/EX39	300/65/175	45	100-277	EX39	4000K	6300	8.81	50K	045923306730	12
S39393	45W/LED/HID/5000K/100-277V/EX39	300/65/175	45	100-277	EX39	5000K	6435	8.81	50K	045923303937	12
S39674	54W/LED/HID/4000K/100-277V/EX39	300/85/250	54	100-277	EX39	4000K	7560	9.01	50K	045923306747	12
S39394	54W/LED/HID/5000K/100-277V/EX39	300/85/250	54	100-277	EX39	5000K	7722	9.01	50K	045923303944	12
S39675	80W/LED/HID/4000K/100-277V/EX39	400/100/320	80	100-277	EX39	4000K	11200	8.78	50K	045923306754	4
S39395	80W/LED/HID/5000K/100-277V/EX39	400/100/320	80	100-277	EX39	5000K	11440	8.78	50K	045923303951	4
S39676	100W/LED/HID/4000K/100-277V/EX39	500/150/400	100	100-277	EX39	4000K	14000	9.76	50K	045923306761	4
S39396	100W/LED/HID/5000K/100-277V/EX39	500/150/400	100	100-277	EX39	5000K	14300	9.76	50K	045923303968	4
S39677	120W/LED/HID/4000K/100-277V/EX39	750/200/600	120	100-277	EX39	4000K	16800	10.35	50K	045923306778	4
S39397	120W/LED/HID/5000K/100-277V/EX39	750/200/600	120	100-277	EX39	5000K	17160	10.35	50K	045923303975	4
Accessories											
92-406	Mog to Med Socket Reducer for S39390, S39391, S39392, S39670, S39671 and S39672									045923924064	
80-929	Hard Wire Surge Protector									045923809293	

** For minimum compartment size of enclosed fixture visit www.satco.com. Lamp life may vary depending on application and use.

Product sheet SA2553

**See warranty for details.



www.satco.com

HIGH LUMEN LED LAMPS

Hi-Pro 277-347V high lumen LED lamps

High lumen, omni-directional lamps for industrial and commercial applications

- Replaces HID, CFL, and Incandescent
- Direct wire range voltage 277-347V
- Built-in surge protection 80-120W
- Approved for totally enclosed fixtures**
- IP65 rated
- 5000K
- Beam angle 300°
- CRI 80+
- High bay/low bay/post top
- DLC listed*
- 5 Year limited warranty



Stocked in Canada only.

High Lumen Industrial/Commercial 277-347V LED Lamps



Item Number	Lamp Description	Replaces Inc/CFL/HID	W	V	Base Type	CCT	Lm	M.O.L. (Inches)	Life/ Hrs.	UPC	Pk/ Mstr.
S28710	18W/LED/HID/5000K/277-347V/E26	120/32/70	18	277-347	E26	5000K	2400	6 3/4	40K	045923287107	48
S28711	22W/LED/HID/5000K/277-347V/E26	150/40/100	22	277-347	E26	5000K	2950	6 1/16	40K	045923287114	48
S28712	36W/LED/HID/5000K/277-347V/E26	200/55/150	36	277-347	E26	5000K	4800	9 3/16	40K	045923287121	12
S28713*	45W/LED/HID/5000K/277-347V/EX39	300/65/175	45	277-347	EX39	5000K	6000	10 11/16	40K	045923287138	12
S28714*	54W/LED/HID/5000K/277-347V/EX39	300/85/250	54	277-347	EX39	5000K	7200	10 11/16	40K	045923287145	12
S28715*	80W/LED/HID/5000K/277-347V/EX39	400/100/320	80	277-347	EX39	5000K	10640	9 1/4	40K	045923287152	4
S28716*	100W/LED/HID/5000K/277-347V/EX39	500/150/400	100	277-347	EX39	5000K	13300	9 5/8	40K	045923287169	4
S28717*	120W/LED/HID/5000K/277-347V/EX39	750/200/600	120	277-347	EX39	5000K	16000	10 3/8	40K	045923287176	4

Accessories

92-410	Mog to Med Socket Reducer									045923924064	
80-935	Hard Wire Surge Protector									045923809354	

** For minimum compartment size of enclosed fixture visit www.satco.com. Lamp life may vary depending on application and use.

Product sheet SA2308

Hi-Pro 360

Innovation in every direction—literally!
Rotating, multi-angle LED lamp.

Applications

- Indoor/outdoor direct replacement
- Street lamps
- High bays/low bays
- Parking garages
- Commercial and industrial security
- Gymnasiums and other high ceiling applications
- Outdoor canopies

Features

- Multi-angle rotating LED lamp with folding panel design
- Replaces HID, CFL, and incandescent
- Direct wire range voltage 100-277V
- Approved for totally enclosed fixtures
- 70 Watts
- 2700K 4000K or 5000K options
- EX39 base
- Wet location
- Long life—50,000 hours
- 5 Year limited warranty

Accessories

- 80/954 - Hi-Pro 360 WiFi Module
- 80/955 - Hi-Pro 360 Motion Sensor / PIR
- 80/956 - Hi-Pro 360 Photocell
- 80/957 - Hi-Pro 360 Motion Sensor / MW

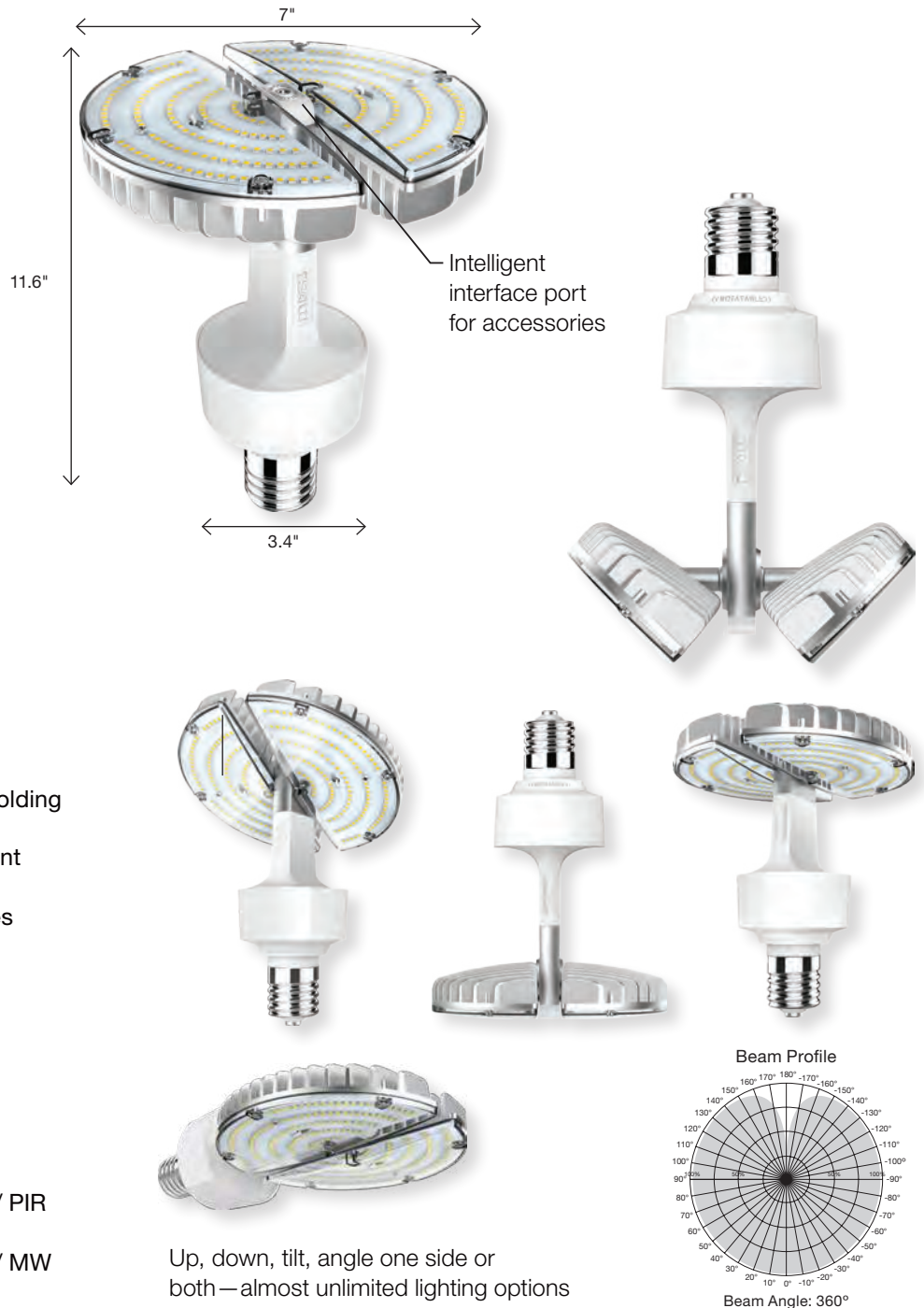

Up, down, tilt, angle one side or both—almost unlimited lighting options

Hi-Pro 360 Lamps



Item Number	Lamp Description	W	V	Base Type	CRI	CCT	Lm	Bm	M.O.L. (Inches)	Life/Hrs.	UPC	Pk./Mstr.
S13120*	70W/LED/HP360/827	70	100-277	EX39	80+	2700	10500	360	11.58	50K	045923131202	1
S13121*	70W/LED/HP360/840	70	100-277	EX39	80+	4000	10500	360	11.58	50K	045923131219	1
S13122*	70W/LED/HP360/850	70	100-277	EX39	80+	5000	10500	360	11.58	50K	045923131226	1

Product sheet SA2579

**See warranty for details.

HIGH LUMEN LED LAMPS

Hi-Pro LED 12-24V low voltage lamps

Low voltage, high lumen, omni-directional lamps for industrial and commercial applications

- Replaces HID, CFL, and Incandescent
- Approved for totally enclosed fixtures**
- IP65 rated
- 5000K
- Long life—50,000 hours
- 5 Year limited warranty



High Lumen Industrial/Commercial LED Lamps - 12-24V



Item Number	Lamp Description	Replaces INC/HID	W	V	Base Type	CCT	Lm	M.O.L. (Inches)	Life/Hrs.	UPC	Pack
S9753	10W/LED/HID/5000K/12V-24V E26	90/30	10	12-24	E26	5000K	1200	5 13/16	50K	045923097539	48
S9754	14W/LED/HID/5000K/12V-24V E26	150/50	14	12-24	E26	5000K	1680	6 3/16	50K	045923097546	48
S9755	18W/LED/HID/5000K/12V-24V E26	200/70	18	12-24	E26	5000K	2160	7	50K	045923097553	48

** For minimum compartment size of enclosed fixture visit www.satco.com. Lamp life may vary depending on application and use.

Product sheet SA2609

Hi-Pro LED lamps with motion sensor

High lumen, omni-directional lamps with adjustable motion sensor for industrial and commercial applications

- Replaces HID, CFL, and Incandescent
- Direct wire range voltage 100-277V
- Approved for totally enclosed fixtures**
- Microwave sensor
- 3000K, 5000K
- 5 Year limited warranty



Adjustable motion sensor

Adjustable Motion Sensor
Adjust the position and angle of the motion sensor according to the fixtures.

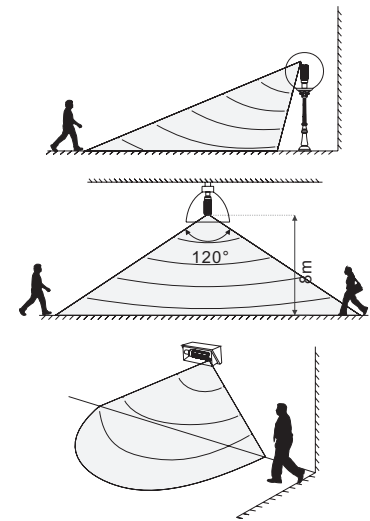

High Lumen Industrial/Commercial LED Lamps with Motion Sensors



Item Number	Lamp Description	Replaces Inc/CFL/HID	W	V	Base Type	CCT	Lm	M.O.L. (Inches)	Life/Hrs.	UPC	Pk/Mstr.
S8988	63W/LED/HID/3K/MS/100-277V	300/85/250	63	100-277	E39	3000K	7875	10 7/8	50K	045923089886	12
S8989	63W/LED/HID/5K/MS/100-277V	300/85/250	63	100-277	E39	5000K	7875	10 7/8	50K	045923089893	12

** For minimum compartment size of enclosed fixture visit www.satco.com. Lamp life may vary depending on application and use.

Product sheet SA2358

HIGH LUMEN LED LAMPS

Hi-Pro LED shoe box lamp series

High lumen, directional lamps for industrial and commercial fixture applications

- For use in shoe box fixtures
- 80/110 Watt options (10,000/14,000 lm) replaces 250/400 Watt HID
- Replaces HID
- Approved for totally enclosed fixtures**
- Damp location
- Direct wire range voltage 100-277V
- Higher efficiency, improved heat dissipation
- 2 CCT options
- Expandable 180° beam design with adjustable base (E39)
- Horizontal operation
- DLC listed*
- Long life—50,000 hours
- 5 Year limited warranty

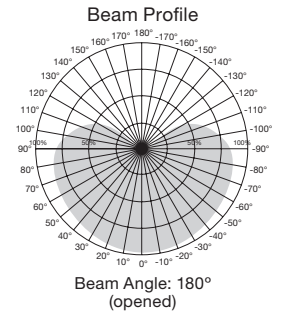
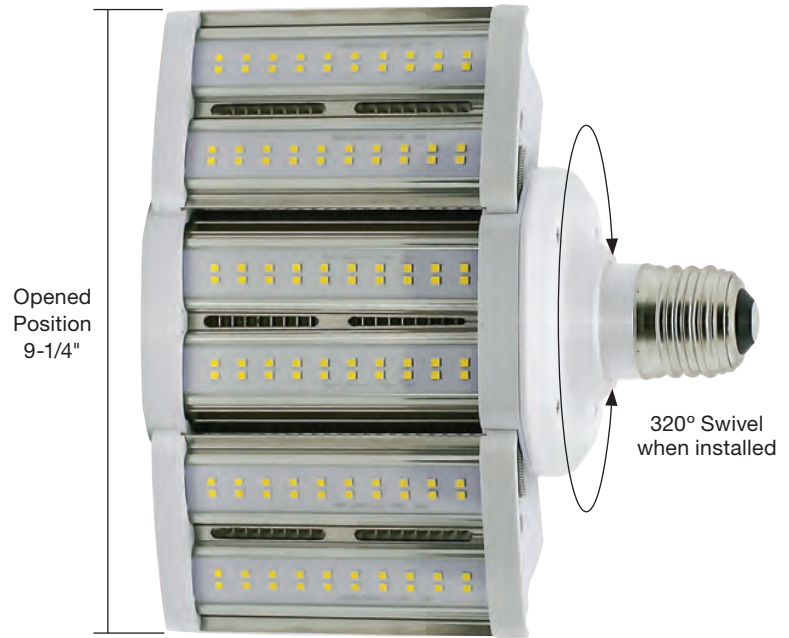

High Lumen Industrial/Commercial LED Lamps

Item Number	Lamp Description	W	V	Rpl.	Base Type	CCT	Lm	Bm	M.O.L. (Inches)	Life/Hrs.	UPC	Pack
S8931*	80W/LED/HID/SB/3K/E39/100-277V	80	100-277	250W	E39	3000K	10000	180°	8 1/16	50K	045923089312	4
S8932*	80W/LED/HID/SB/5K/E39/100-277V	80	100-277	250W	E39	5000K	10000	180°	8 1/16	50K	045923089329	4
S8937*	110W/LED/HID/SB/3K/E39/100-277V	110	100-277	400W	E39	3000K	14000	180°	11 1/8	50K	045923089374	4
S8938*	110W/LED/HID/SB/5K/E39/100-277V	110	100-277	400W	E39	5000K	14000	180°	11 1/8	50K	045923089381	4

Accessories

80-929	Hard Wire Surge Protector	045923809293
--------	---------------------------	--------------

** For minimum compartment size of enclosed fixture visit www.satco.com. Lamp life may vary depending on application and use.



**See warranty for details.

SATCO | NUVO

www.satco.com

Product sheet SA2063

77

HIGH LUMEN LED LAMPS

Hi-Pro LED wall pack lamp series

High lumen, directional lamps for industrial and commercial fixture applications

- For use in wall pack, canopy, shoe box, or cobra head fixtures
- 20/40/60 Watt options replaces 100/175/250 Watt HID
- Replaces HID
- Approved for totally enclosed fixtures**
- Direct wire range voltage 100-277V
- IP64, higher efficiency, improved heat dissipation
- Reduced size
- 180° beam/adjustable base (E26/E39)
- Horizontal operation
- DLC listed*
- Long life—50,000 hours
- 5 Year limited warranty

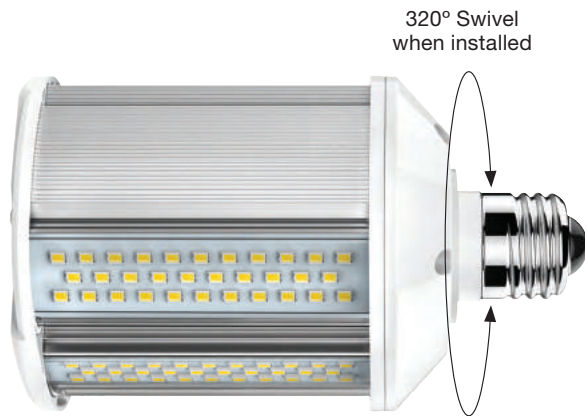

320° Swivel when installed

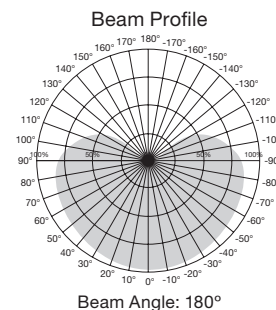

High Lumen Industrial/Commercial LED Lamps



Item Number	Lamp Description	W	V	Rpl.	Base Type	CCT	Lm	Bm	M.O.L. (Inches)	Life/Hrs.	UPC	Pack
S8928	20W/LED/HID/WP/5K/E26/100-277V	20	100-277	100W	E26	5000K	3000	180°	5 ¼	50K	045923089282	12
S8929	40W/LED/HID/WP/5K/E26/100-277V	40	100-277	175W	E26	5000K	6000	180°	7 7/8	50K	045923089299	12
S8930*	40W/LED/HID/WP/5K/E39/100-277V	40	100-277	175W	E39	5000K	6000	180°	8 ½	50K	045923089305	12
S8987*	60W/LED/HID/WP/5K/E39/100-277V	60	100-277	250W	E39	5000K	9000	180°	10 ¾	50K	045923089879	12

Accessories

92-410	Mog to Med Socket Reducer for S9750										045923924064	
80-929	Hard Wire Surge Protector										045923809293	

** For minimum compartment size of enclosed fixture visit www.satco.com. Lamp life may vary depending on application and use.

Product sheet SA2173

Hi-Pro LED multi-beam lamps

High lumen, adjustable, multi-directional lamps for industrial and commercial applications

- Replaces HID, CFL, and incandescent
- Direct wire range voltage 100-277V
- Approved for totally enclosed fixtures**
- High bay, low bay, hanging sockets, and post top
- 2700K or 5000K
- Light panels lock into place creating 3 separate beam angle options
- IP65 rated
- Long life—50,000 hours
- 5 Year limited warranty



360° Beam



270° Beam



180° Beam

High Lumen Multi-Beam Industrial/Commercial LED Lamps



Item Number	Lamp Description	Replaces Inc/CFL/HID	W	V	Base Type	CCT	Lm	CRI	M.O.L. (Inches)	Life/Hrs.	UPC	Pack/Master
S29768	30W/LED/HID/MB/2700K/100-277V	200/55/150	30	100-277	E26	2700K	3660	83	6 3/8	50K	045923297687	24
S29750	30W/LED/HID/MB/5000K/100-277V	200/55/150	30	100-277	E26	5000K	3900	83	6 3/8	50K	045923297502	24
S29798*	40W/LED/HID/MB/2700K/100-277V	300/65/175	40	100-277	EX39	2700K	4880	83	7 7/8	50K	045923297984	12
S29751*	40W/LED/HID/MB/5000K/100-277V	300/65/175	40	100-277	EX39	5000K	5200	83	7 7/8	50K	045923297519	12
S29799*	60W/LED/HID/MB/2700K/100-277V	500/85/250	60	100-277	EX39	2700K	7320	83	8 1/16	50K	045923297991	12
S29752*	60W/LED/HID/MB/5000K/100-277V	500/85/250	60	100-277	EX39	5000K	7800	83	8 1/16	50K	045923297526	12
S29769*	75W/LED/HID/MB/5000K/100-277V	750/105/400	75	100-277	EX39	5000K	9800	80+	8 5/8	50K	045923297694	12
S29679*	90W/LED/HID/MB/5000K/100-277V	750/200/600	90	100-277	EX39	5000K	11700	80+	8 5/8	50K	045923296796	4

Accessories

92-410	Mog to Med Socket Reducer for S29750, S29768 and S29750	045923924064
80-929	Hard Wire Surge Protector	045923809293

** For minimum compartment size of enclosed fixture visit www.satco.com. Lamp life may vary depending on application and use.

PATENT PENDING

HIGH LUMEN LED LAMPS

Hi-Pro LED post top lamps

- For use in any post top fixture to provide light out and down only
- Direct wire (ballast by-pass) 100-277V / E26
- Approved for enclosed fixtures**
- Long life—50,000 hours
- 5 Year limited warranty

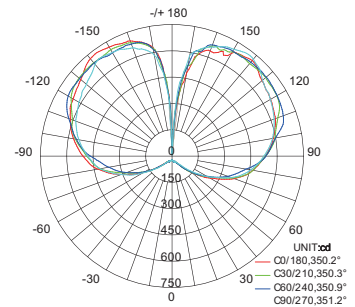

Controls light pollution



High Lumen LED Lamps

Item Number	Lamp Description	W	V	Base Type	CRI	CCT	Lm	M.O.L. (Inches)	Life/Hrs.	UPC	Pack/Mstr.
S9779	40W/LED/HID/PT/3000K/100-277V	40	100-277	E26	80+	3000K	5000	5 ½	50K	045923097799	12

Accessories

92-410	Mog to Med Socket Reducer									045923924064	
80-929	Hard Wire Surge Protector									045923809293	

LED HIGH BAY/LOW BAY LAMPS



Hi-Pro LED high bay/low bay lamps

High lumen LED lamps for industrial and commercial applications

Features

- Replaces HID, CFL, and Incandescent
- 115° beam angle
- Long neck option fits more fixtures
- Direct wire range voltage 120-277V
- Light weight
- Advanced passive heat dissipation
- Long life—50,000 hours
- 5 Year limited warranty

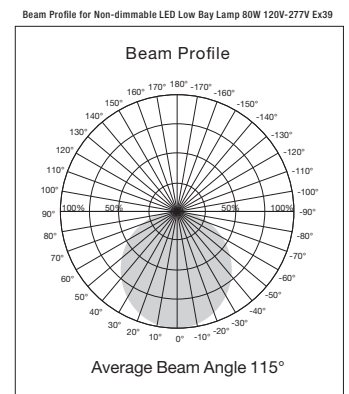

High Lumen Industrial/Commercial LED Lamps



Item Number	Lamp Description	W	V	Base Type	CRI	CCT	Lm	Bm	M.O.L. (Inches)	Life/Hrs.	UPC	Pk./Mstr.
S13112*	80W/LED/HID-HB/4K/120-277V	80	120-277	EX39	80+	4000	9300	115	10.12	50K	045923131127	4
S13113*	80W/LED/HID-HB/5K/120-277V	80	120-277	EX39	80+	5000	9700	115	10.12	50K	045923131134	4
S13114*	130W/LED/HID-HB/4K/120-277V	130	120-277	EX39	80+	4000	15500	115	12.40	50K	045923131141	4
S13115*	130W/LED/HID-HB/5K/120-277V	130	120-277	EX39	80+	5000	16100	115	12.40	50K	045923131158	4

Accessories

80-929	HARD WIRE SURGE PROTECTOR	045923809293
--------	---------------------------	--------------

**See warranty for details.

HIGH LUMEN LED PAR LAMPS

Hi-Pro LED PAR30 lamps

High lumen, PAR lamps for industrial and commercial applications

- Replaces Halogen and ceramic metal Halide lamps
- Saves over 80% on energy costs
- Direct wire range voltage 100-277V
- High efficiency—100LPW
- 3000 and 4000K options
- Base up, base down or horizontal operation
- Long life—50,000 hours
- ENERGY STAR certified*
- 5 Year limited warranty



S9762, S9763

S9764, S9765

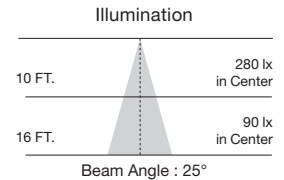
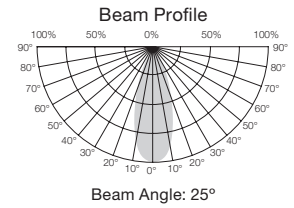

High Lumen PAR30 Industrial/Commercial LED Lamps

Item Number	Lamp Description	W	V	CRI	CCT	Lm	Bm	M.O.L. (Inches)	Life/ Hrs.	UPC	Pack/ Master
S9762*	12W/LED/PAR30/SN/3K/100-277V	12	100-277	83	3000K	1200	25°	3 1/2	50K	045923097621	24/6
S9763*	12W/LED/PAR30/SN/4K/100-277V	12	100-277	83	4000K	1200	25°	3 1/2	50K	045923097638	24/6
S9764*	12W/LED/PAR30/LN/3K/100-277V	12	100-277	83	3000K	1200	25°	4 5/16	50K	045923097645	24/6
S9765*	12W/LED/PAR30/LN/4K/100-277V	12	100-277	83	4000K	1200	25°	4 5/16	50K	045923097652	24/6
Accessories											
80-929	HARD WIRE SURGE PROTECTOR									045923809293	

Product sheet SA2039

Hi-Pro LED PAR38 lamps

High lumen, PAR lamps for industrial and commercial applications

- Replaces Halogen and ceramic metal Halide lamps
- Saves over 80% on energy costs
- Direct wire range voltage 100-277V
- High efficiency—over 100LPW
- 3000 and 4000K options
- Base up, base down or horizontal operation
- Long life—50,000 hours
- ENERGY STAR certified*
- 5 Year limited warranty

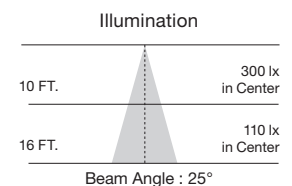
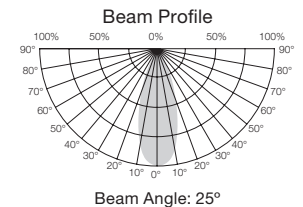

High Lumen PAR38 Industrial/Commercial LED Lamps

Item Number	Lamp Description	W	V	CRI	CCT	Lm	Bm	M.O.L. (Inches)	Life/ Hrs.	UPC	Pack/ Master
S9760*	18W/LED/PAR38/3000K/100-277V	18	100-277	83	3000K	1950	25°	5 1/16	50K	045923097607	12/6
S9761*	18W/LED/PAR38/4000K/100-277V	18	100-277	83	4000K	2000	25°	5 1/16	50K	045923097614	12/6
Accessories											
80-929	HARD WIRE SURGE PROTECTOR										045923809293

Product sheet SA2010

INSTANT HI BAY FIXTURE



E39 Mogul Base

Screw terminals

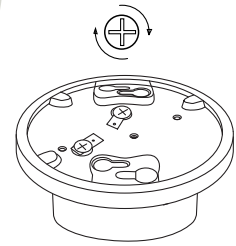

Instant hi-bay fixture

Keyless porcelain mogul base lamp holder with screw terminals

- Perfect for use with LED HID replacement lamps
- Commercial/industrial applications
- Screw-in eye hook for safety cable included
- Holder rated at 1500W Max.
- 600V
- Max lamp weight 5 lbs.



Lamp and cables not included



Screw-in safety eye hook included



Keyless Porcelain Mogul Base Lamp Holder



Item Number	Lamp Description	Max. W	Max. V	UPC	Pack
90-483	Keyless Mogul Lamp Holder	1500	600	045923904837	40

Product sheet SA2393

**See warranty for details.

SATCO | **NUVO**

www.satco.com

HIGH LUMEN LED LAMPS

Hi-Pro LED temporary hi-bay caged lamp series

High lumen, omni-directional lamps for industrial and commercial applications

- For use in any commercial work area replacing HID, CFL and Incandescent
- 60/100/150 Watt options (up to 15,000 lm)
- Includes 3' power cord/plug
- Portable
- Outlet for connecting multiple lamps
- Remote control "on/off"
- Cage is redesigned to be free standing with additional support
- IP64, higher efficiency, improved heat dissipation
- 360° Omni-directional light
- Damp location
- Long life—50,000 hours
- 5 Year limited warranty



S28939

S28946

S28975

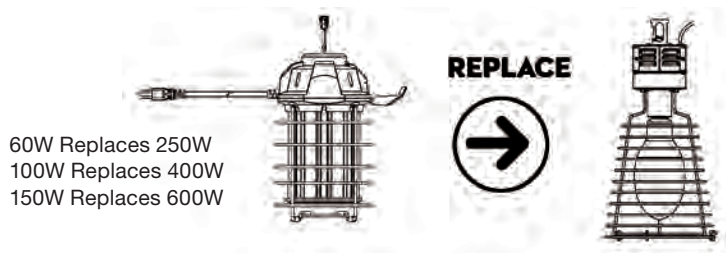

60W Replaces 250W
100W Replaces 400W
150W Replaces 600W



Linkable
60Wx10 pcs. max
100Wx6 pcs. max
150Wx4 pcs. max
600W max

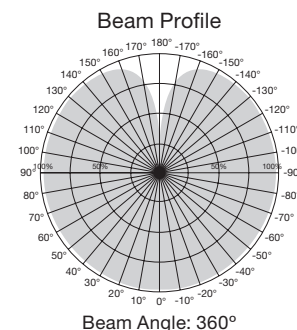

High Lumen Industrial/Commercial LED Lamps



Item Number	Lamp Description	Replaces	W	V	CRI	CCT	Lm	Bm	M.O.L. (Inches)	Life/Hrs.	UPC	Pack
S28939	60W/LED/HID/TEMP/5K/RC/120V	250W	60	120	85	5000K	6000	360°	10 1/16	50K	045923289392	4
S28946	100W/LED/HID/TEMP/5K/RC/120V	400W	100	120	85	5000K	10000	360°	12	50K	045923289460	4
S28975	150W/LED/HID/TEMP/5K/RC/120V	600W	150	120	85	5000K	15000	360°	13 3/8	50K	045923289750	4

Product sheet SA2283

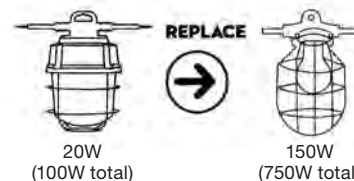
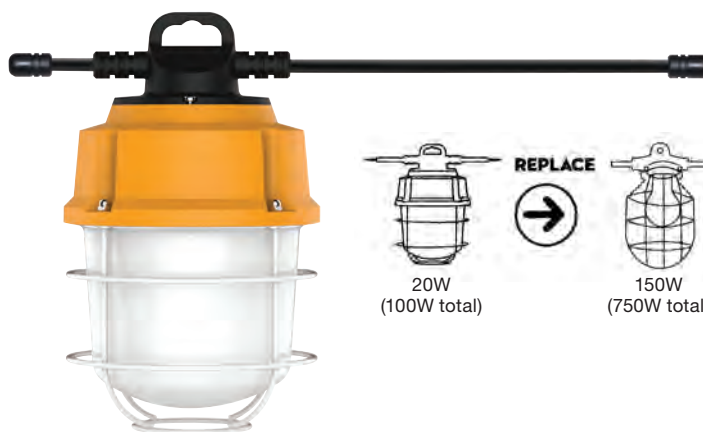

Hi-Pro LED temporary string light series

High lumen, omni-directional string lights for industrial and commercial applications

- For use in any commercial work area
- 5 lamps per string
- 20W / 2000 lumens per lamp (100W)
- 10' between lamps (50' per string)
- Replaces HID, CFL, and Incandescent
- 360° Omni-directional light
- Direct wire 120V
- Wet location
- IP65 - Water and dust proof
- Long life—50,000 hours
- 3 Year limited warranty



Beam Profile - Each Lamp

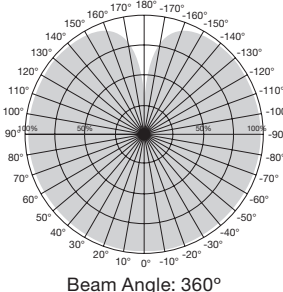

High Lumen Industrial/Commercial LED String Light



Item Number	Lamp Description	W	V	CRI	Base Type	CCT	Lm	Bm	M.O.L. (Inches)	Life/Hrs.	UPC	Pack
S8976	100W/LED/5PC/TEMP/STRING/120V	100	120	85	String/Plug	5000K	10000	360°	6 5/8	50K	045923089763	1

Product sheet SA2284

**See warranty for details.

PL/LED BALLAST BYPASS LAMPS

PL/LED ballast bypass replacement lamps

- UL Classified
- 2-pin replacement for up to 26 Watt pin based CFL, uses only 9 Watts
- 2-pin LED lamps works in both 2-pin (magnetic) and 4-pin (electronic) sockets
 - G24d (2-pin)—18 and 26W rep.
 - G24q (4-pin)—13, 18, and 26 rep.
- Direct wire 120-277V
- Instant on to full brightness / no flickering
- Rotates up to 270° for various fixture applications
- Vertical and horizontal options
- Up to 70% energy saving
- Damp location
- Long life—50,000 hours
- 5 Year warranty

Rotates 270°
when installed



S8530, S8531, S8532, S8533, S8534



S8535, S8536, S8537,
S8538, S8539

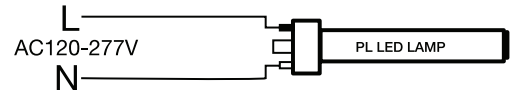
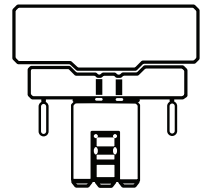
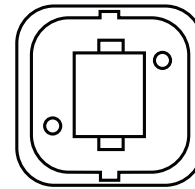

PL/LED Replacement Lamps



Item Number	Lamp Description	W	Base Type	CCT	CRI	M.O.L. (Inches)	Lm	Life/Hrs.	UPC	Pack/Master
S8530	9WPLH/LED/827/BP/2P	9	G24d	2700K	82	6 5/8	900	50K	045923085307	50/10
S8531	9WPLH/LED/830/BP/2P	9	G24d	3000K	82	6 5/8	950	50K	045923085314	50/10
S8532	9WPLH/LED/835/BP/2P	9	G24d	3500K	82	6 5/8	950	50K	045923085321	50/10
S8533	9WPLH/LED/840/BP/2P	9	G24d	4000K	82	6 5/8	1000	50K	045923085338	50/10
S8534	9WPLH/LED/850/BP/2P	9	G24d	5000K	82	6 5/8	1000	50K	045923085345	50/10
S8535	9WPLV/LED/827/BP/2P	9	G24d	2700K	82	4 1/4	900	50K	045923085352	50/10
S8536	9WPLV/LED/830/BP/2P	9	G24d	3000K	82	4 1/4	950	50K	045923085369	50/10
S8537	9WPLV/LED/835/BP/2P	9	G24d	3500K	82	4 1/4	950	50K	045923085376	50/10
S8538	9WPLV/LED/840/BP/2P	9	G24d	4000K	82	4 1/4	1000	50K	045923085383	50/10
S8539	9WPLV/LED/850/BP/2P	9	G24d	5000K	82	4 1/4	1000	50K	045923085390	50/10

Product sheet SA2328

LED/CFL direct replacement lamps

4-pin (electronic ballasts)
2-pin (magnetic ballasts)

- 4-pin 26, 32, 42 Watt direct replacement
- 2-pin 26 Watt direct replacement
- 4-pin lamps fit G24q-3 & GX24q-3 and GX24q-4 sockets
- 2-pin lamps fit G24d-3 sockets
- No re-wiring needed
- Instant on to full brightness / no flickering
- Vertical and horizontal options
- Up to 70% energy saving
- DLC listed* (4-pin only)
- c-UL-us listed
- Long life—50,000 hours
- 5 Year warranty



S29858, S29859,
S29860, S29861
G24Q



S9862, S9863,
S9864, S9865
G24D

Rotates 270°
when installed

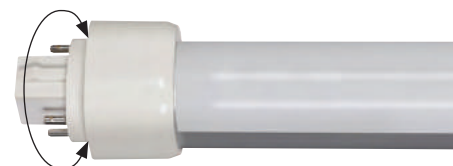

S29850, S29851, S29852, S29853
G24Q



S9854, S9855, S9856, S9857
G24D

LED/CFL Replacement Lamps



Item Number	Lamp Description	W	Base Type	CCT	CRI	M.O.L. (Inches)	Lm	Life/ Hrs.	UPC	Pack/ Master
4-Pin Horizontal										
S29850*	9WPLH/LED/830/DR/4P	9	G24Q	3000K	82	6 5/8	950	50K	045923298509	50/10
S29851*	9WPLH/LED/835/DR/4P	9	G24Q	3500K	82	6 5/8	950	50K	045923298516	50/10
S29852*	9WPLH/LED/840/DR/4P	9	G24Q	4000K	82	6 5/8	900	50K	045923098529	50/10
S29853*	9WPLH/LED/850/DR/4P	9	G24Q	5000K	82	6 5/8	900	50K	045923298530	50/10
2-Pin Horizontal										
S9854	9WPLH/LED/830/DR/2P	9	G24D	3000K	82	6 5/8	850	50K	045923098543	50/10
S9855	9WPLH/LED/835/DR/2P	9	G24D	3500K	82	6 5/8	850	50K	045923098550	50/10
S9856	9WPLH/LED/840/DR/2P	9	G24D	4000K	82	6 5/8	900	50K	045923098567	50/10
S9857	9WPLH/LED/850/DR/2P	9	G24D	5000K	82	6 5/8	900	50K	045923098574	50/10
4-Pin Vertical										
S29858*	9WPLV/LED/830/DR/4P	9	G24Q	3000K	82	4 11/16	950	50K	045923298585	50/10
S29859*	9WPLV/LED/835/DR/4P	9	G24Q	3500K	82	4 11/16	950	50K	045923298592	50/10
S29860*	9WPLV/LED/840/DR/4P	9	G24Q	4000K	82	4 11/16	900	50K	045923298608	50/10
S29861*	9WPLV/LED/850/DR/4P	9	G24Q	5000K	82	4 11/16	900	50K	045923298615	50/10
2-Pin Vertical										
S9862	9WPLV/LED/830/DR/2P	9	G24D	3000K	82	4 11/16	850	50K	045923098628	50/10
S9863	9WPLV/LED/835/DR/2P	9	G24D	3500K	82	4 11/16	850	50K	045923098635	50/10
S9864	9WPLV/LED/840/DR/2P	9	G24D	4000K	82	4 11/16	900	50K	045923098642	50/10
S9865	9WPLV/LED/850/DR/2P	9	G24D	5000K	82	4 11/16	900	50K	045923098659	50/10

Product sheet SA1979

**See warranty for details.

LED/CFL ballast bypass replacement lamps

2-Pin GX23 ballast bypass GU24 Base, E26 Base

- 2-Pin 13 Watt CFL direct replacement
- GU24 Base and E26 Base are 13-18 Watt CFL and 60 Watt incandescent direct replacements
- Instant on to full brightness / no flickering
- Rotates up to 270° for various fixture applications
- Vertical and horizontal options
- Up to 70% energy saving
- c-UL-us Classified—2-Pin ballast bypass
- c-UL-us listed—GU24 base, E26 base
- Long life—50,000 hours
- 5 Year warranty



2-Pin ballast bypass
S8725, S8726, S8728, S8729

Rotates 270°
when installed



GU24
S8745, S8746, S8747, S4748, S8749

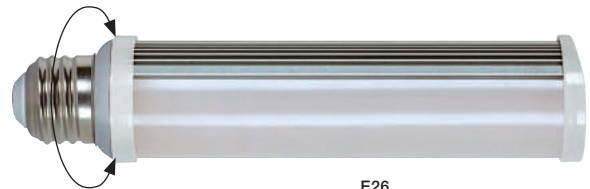

E26
S8755, S8756, S8757, S4758, S8759

LED/CFL Replacement Lamps



Item Number	Lamp Description	W	V	Base Type	CCT	CRI	M.O.L. (Inches)	Lm	Life/Hrs.	UPC	Pack/Master
2-Pin Ballast Bypass—c-UL-us Classified											
S8725	6W/H/LED/CFL/827/2P/BP	6	120-277V	GX23	2700K	83	5 3/4	570	50K	045923087257	50/10
S8726	6W/H/LED/CFL/830/2P/BP	6	120-277V	GX23	3000K	83	5 3/4	570	50K	045923087264	50/10
S8727	6W/H/LED/CFL/835/2P/BP	6	120-277V	GX23	3500K	83	5 3/4	600	50K	045923087271	50/10
S8728	6W/H/LED/CFL/840/2P/BP	6	120-277V	GX23	4000K	83	5 3/4	600	50K	045923087288	50/10
S8729	6W/H/LED/CFL/850/2P/BP	6	120-277V	GX23	5000K	83	5 3/4	600	50K	045923087295	50/10
GU24 Base—c-UL-us listed											
S8745	8W/H/LED/CFL/827/GU24	8	120-277V	GU24	2700K	83	6 1/2	920	50K	045923087455	50/10
S8746	8W/H/LED/CFL/830/GU24	8	120-277V	GU24	3000K	83	6 1/2	920	50K	045923087462	50/10
S8747	8W/H/LED/CFL/835/GU24	8	120-277V	GU24	3500K	83	6 1/2	960	50K	045923087479	50/10
S8748	8W/H/LED/CFL/840/GU24	8	120-277V	GU24	4000K	83	6 1/2	960	50K	045923087486	50/10
S8749	8W/H/LED/CFL/850/GU24	8	120-277V	GU24	5000K	83	6 1/2	960	50K	045923087493	50/10
E26 Base—c-UL-us listed											
S8755	8W/H/LED/CFL/827/E26	8	120-277V	E26	2700K	83	6 13/16	920	50K	045923087554	50/10
S8756	8W/H/LED/CFL/830/E26	8	120-277V	E26	3000K	83	6 13/16	920	50K	045923087561	50/10
S8757	8W/H/LED/CFL/835/E26	8	120-277V	E26	3500K	83	6 13/16	960	50K	045923087578	50/10
S8758	8W/H/LED/CFL/840/E26	8	120-277V	E26	4000K	83	6 13/16	960	50K	045923087585	50/10
S8759	8W/H/LED/CFL/850/E26	8	120-277V	E26	5000K	83	6 13/16	960	50K	045923087592	50/10

Product sheet SA2119

LED/CFL LAMPS

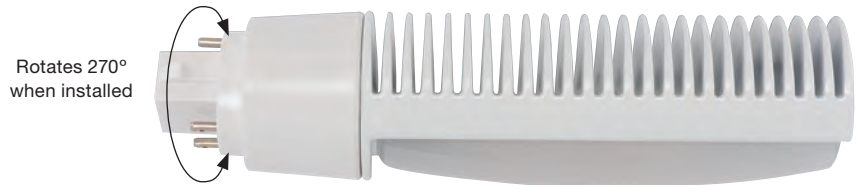

Rotates 270°
when installed

S21400, S21401, S21402, S21403



S21404, S21405, S21406, S21407

LED/CFL direct replacement lamps 4-pin (electronic ballasts)

- UL listed 4-pin 42 Watt direct replacement
- 4-pin lamps fit GX24q-4 sockets
- No re-wiring needed
- Instant on to full brightness / no flickering
- Vertical and horizontal options
- DLC Listed*
- c-UL-us listed
- Up to 60% energy saving
- Long life—50,000 hours
- 5 Year warranty

LED/CFL Replacement Lamps - Ballast Compatible♦



Item Number	Lamp Description	W	Base Type	CCT	CRI	M.O.L. (Inches)	Lm	Life/ Hrs.	UPC	Pk./ Mstr.
S21400*	PLT/16W/H/LED/830/4P/DR	16	G24Q	3000K	82	5 ¾	1750	50K	045923224003	20
S21401*	PLT/16W/H/LED/835/4P/DR	16	G24Q	3500K	82	5 ¾	1750	50K	045923224010	20
S21402*	PLT/16W/H/LED/840/4P/DR	16	G24Q	4000K	82	5 ¾	1850	50K	045923224027	20
S21403*	PLT/16W/H/LED/850/4P/DR	16	G24Q	5000K	82	5 ¾	1850	50K	045923224034	20
S21404*	PLT/16W/V/LED/830/4P/DR	16	G24Q	3000K	82	6 ½	1750	50K	045923224041	20
S21405*	PLT/16W/V/LED/835/4P/DR	16	G24Q	3500K	82	6 ½	1750	50K	045923224058	20
S21406*	PLT/16W/V/LED/840/4P/DR	16	G24Q	4000K	82	6 ½	1850	50K	045923224065	20
S21407*	PLT/16W/V/LED/850/4P/DR	16	G24Q	5000K	82	6 ½	1850	50K	045923224072	20

♦ Visit www.satco.com for ballast compatibility list.

Product sheet SA2471

**See warranty for details.



www.satco.com

Satco 2G11 23W LED/CFL replacement lamps

Ballast bypass replacement
for 4-pin 40W PL-L

- Direct wire 120-277V
- All glass tube
- Over 40% energy savings
- Instant on to full brightness/no flickering
- Damp location
- NSF certified
- c-UL-us Classified
- Long life—50,000 hours
- 5 Year warranty



Wiring diagram

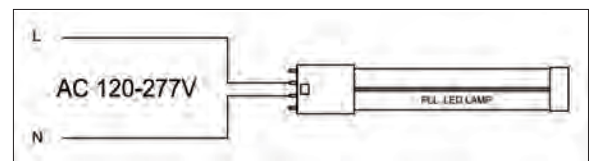

Satco 2G11 23W LED/CFL Replacement Lamps



Item Number	Lamp Description	W	CRI	Base Type	CCT	Lm	M.O.L. (Inches)	Life/ Hrs.	UPC	Pack
S9950*	23PLL/LED/835/BP	23	82	2G11	3500K	2600	22 ½	50K	045923099502	10
S9951*	23PLL/LED/840/BP	23	82	2G11	4000K	2800	22 ½	50K	045923099519	10

Product sheet SA2194

LED T8 & U-BEND LAMPS

Satco 2', 3' & 6" U-bend LED T8 lamps

Direct replacement for linear
or U-bend T8 fluorescent lamps
in existing fixtures with instant
or rapid start ballasts.

No rewiring required*

- Over 40% energy savings vs. standard T8 systems
- All glass tube
- Direct replacement solution allows the fixture to maintain the Original UL and CSA Compliance
- Compatible with emergency ballasts (2' & 3')**
- Integrated thermal fuse at pins
- Damp location
- DLC listed*
- NSF certified
- c-UL-us listed
- Long life—50,000 hours
- 5 Year warranty



LED T8 2', 3' & 6" U-Bend Ballast Compatible

Item Number	Lamp Description	W	CRI	Base Type	Bm	CCT	Lm	M.O.L. (Inches)	Life/ Hrs.	UPC	Pack
2' LED T8**											
S9946*	8T8/LED/24-830/DR	8	82	Med Bi-Pin	220°	3000K	1200	24	50K	045923099465	10
S9947*	8T8/LED/24-835/DR	8	82	Med Bi-Pin	220°	3500K	1200	24	50K	045923099472	10
S9948*	8T8/LED/24-840/DR	8	82	Med Bi-Pin	220°	4000K	1250	24	50K	045923099489	10
S9949*	8T8/LED/24-850/DR	8	82	Med Bi-Pin	220°	5000K	1250	24	50K	045923099496	10
3' LED T8**											
S29990*	10T8/LED/36-830/DR	10	82	Med Bi-Pin	220°	3000K	1400	36	50K	045923099908	10
S29991*	10T8/LED/36-835/DR	10	82	Med Bi-Pin	220°	3500K	1400	36	50K	045923099915	10
S29992*	10T8/LED/36-840/DR	10	82	Med Bi-Pin	220°	4000K	1450	36	50K	045923099922	10
S29993*	10T8/LED/36-850/DR	10	82	Med Bi-Pin	220°	5000K	1450	36	50K	045923099939	10
U-Bend 6" LED T8											
S9994*	11.5T8U6/LED/22.5-830/DR	11.5	82	Med Bi-Pin	230°	3000K	1700	22.5	50K	045923099946	12
S9995*	11.5T8U6/LED/22.5-835/DR	11.5	82	Med Bi-Pin	230°	3500K	1700	22.5	50K	045923099953	12
S9996*	11.5T8U6/LED/22.5-840/DR	11.5	82	Med Bi-Pin	230°	4000K	1800	22.5	50K	045923099960	12
S9997*	11.5T8U6/LED/22.5-850/DR	11.5	82	Med Bi-Pin	230°	5000K	1800	22.5	50K	045923099977	12

* May not be compatible with all ballasts. Visit www.satco.com for an approved list.

** 2' & 3' May not be compatible with all rapid start and emergency ballasts. Visit www.satco.com for an approved list.

Product sheets SA2361, SA2153

**See warranty for details.



www.satco.com

LED T8 LAMPS

Satco 12W and 15W, 4' LED T8 lamps

Direct replacement for linear fluorescent T8 lamps in existing fixtures with instant or rapid start ballasts. No rewiring required*

- Over 40% energy savings vs. standard 4' T8 systems
- All glass tube
- Compatible with emergency & dimming ballasts*
- Integrated thermal fuse at pins
- Damp location
- c-UL-us listed
- NSF certified
- DLC listed*
- Long life—50,000 hours
- 5 Year warranty



LED T8 Ballast Compatible - 12W

Item Number	Lamp Description	W	CRI	Bulb Type	Bm	CCT	Lm	M.O.L. (Inches)	Life/ Hrs.	UPC	Pack
S39934*	12T8/LED/48-830/DR	12	82	T8	210°	3000K	1700	48	50K	045923399343	10
S39935*	12T8/LED/48-835/DR	12	82	T8	210°	3500K	1700	48	50K	045923399350	10
S39936*	12T8/LED/48-840/DR	12	82	T8	210°	4000K	1800	48	50K	045923399367	10
S39937*	12T8/LED/48-850/DR	12	82	T8	210°	5000K	1800	48	50K	045923399374	10

* May not be compatible with all IS, RS, DM, and EM ballasts. Visit www.satco.com for an approved list.

Product sheet SA2305



LED T8 Ballast Compatible - 15W

Item Number	Lamp Description	W	CRI	Bulb Type	Bm	CCT	Lm	M.O.L. (Inches)	Life/ Hrs.	UPC	Pack
S39975*	15T8/LED/48-830/DR	15	80	T8	210°	3000K	2100	48	50K	045923399756	10
S39976*	15T8/LED/48-835/DR	15	80	T8	210°	3500K	2100	48	50K	045923399763	10
S39977*	15T8/LED/48-840/DR	15	80	T8	210°	4000K	2200	48	50K	045923399770	10
S39978*	15T8/LED/48-850/DR	15	80	T8	210°	5000K	2200	48	50K	045923399787	10

* May not be compatible with all IS, RS, DM, and EM ballasts. Visit www.satco.com for an approved list.

Product sheet SA2487

Linear LED ballast bypass T8 series

Double ended wiring

- Works with existing sockets –shunted or non-shunted
- Reduces labor costs for installation
- Built-in shock resistant circuit (not hot until both ends are installed)
- No ballast or external driver required
- Direct wire 120-277V line voltage
- All glass tube
- Approved for use with tube guards
- Damp location
- c-UL-us Classified
- DLC Listed
- Long life—50,000 hours
- 5 Year warranty



Double Ended
Wiring Diagram
AC120-277V

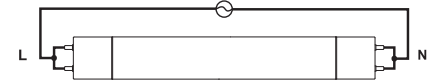

LED T8 Ballast Bypass

Item Number	Lamp Description	W	CRI	Base Type	Bm	CCT	Lm	M.O.L. (Inches)	Life/ Hrs.	UPC	Pack
9W, 2'											
S29900	9T8/LED/24-830/BP 120-277V	9	82	Med Bi-Pin	220°	3000K	1100	24	50K	045923299001	25
S29901	9T8/LED/24-835/BP 120-277V	9	82	Med Bi-Pin	220°	3500K	1100	24	50K	045923299018	25
S29902	9T8/LED/24-840/BP 120-277V	9	82	Med Bi-Pin	220°	4000K	1150	24	50K	045923299025	25
S29903	9T8/LED/24-850/BP 120-277V	9	82	Med Bi-Pin	220°	5000K	1150	24	50K	045923299032	25
12W, 3'											
S29926	12T8/LED/36-830/BP 120-277V	12	82	Med Bi-Pin	220°	3000K	1400	36	50K	045923299261	25
S29927	12T8/LED/36-835/BP 120-277V	12	82	Med Bi-Pin	220°	3500K	1400	36	50K	045923299278	25
S29928	12T8/LED/36-840/BP 120-277V	12	82	Med Bi-Pin	220°	4000K	1450	36	50K	045923299285	25
S29929	12T8/LED/36-850/BP 120-277V	12	82	Med Bi-Pin	220°	5000K	1450	36	50K	045923299292	25
14W, 4'											
S29913	14T8/LED/48-830/BP 120-277V	14	82	Med Bi-Pin	220°	3000K	1800	48	50K	045923299131	25
S29914	14T8/LED/48-835/BP 120-277V	14	82	Med Bi-Pin	220°	3500K	1800	48	50K	045923299148	25
S29915	14T8/LED/48-840/BP 120-277V	14	82	Med Bi-Pin	220°	4000K	1800	48	50K	045923299155	25
S29916	14T8/LED/48-850/BP 120-277V	14	82	Med Bi-Pin	220°	5000K	1800	48	50K	045923299162	25
S11924	14T8/LED/48-865/BP 120-277V	14	82	Med Bi-Pin	210°	6500K	1800	48	50K	045923119248	25
17W, 4'											
S29904	17T8/LED/48-830/BP 120-277V	17	82	Med Bi-Pin	220°	3000K	2100	48	50K	045923299049	25
S29905	17T8/LED/48-835/BP 120-277V	17	82	Med Bi-Pin	220°	3500K	2100	48	50K	045923299056	25
S29906	17T8/LED/48-840/BP 120-277V	17	82	Med Bi-Pin	220°	4000K	2200	48	50K	045923299063	25
S29907	17T8/LED/48-850/BP 120-277V	17	82	Med Bi-Pin	220°	5000K	2200	48	50K	045923299070	25

Product sheet SA2405

**See warranty for details.



www.satco.com

LED T8 LAMPS

Dimmable 13.5W linear LED T8 ballast bypass lamps

Features

- No ballast or external driver required
- Direct wire 120V line voltage*
- All glass tube
- Dimmable**
- Damp location
- Long life: 50,000 hours
- c-UL-us Classified
- DLC Listed
- NSF Certified
- 5 Year warranty

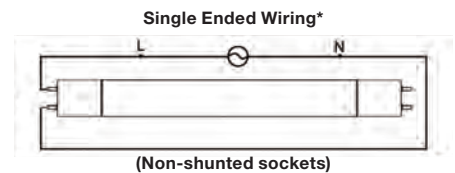

LED T8 fluorescent replacement lamps



Item Number	Lamp Description	W	V	CRI	Base Type	Bm	CCT	Lm	M.O.L. (Inches)	Life/ Hrs.	UPC	M/ Case Qty
S11920	13.5T8/LED/48-830/DIM-BP	13.5	120	82	G13	220°	3000K	1700	48	50K	045923119200	25
S11921	13.5T8/LED/48-835/DIM-BP	13.5	120	82	G13	220°	3500K	1700	48	50K	045923119217	25
S11922	13.5T8/LED/48-840/DIM-BP	13.5	120	82	G13	220°	4000K	1800	48	50K	045923119224	25
S11923	13.5T8/LED/48-850/DIM-BP	13.5	120	82	G13	220°	5000K	1800	48	50K	045923119231	25

**See satco.com for dimmer compatibility list.

Product sheet SA2533

LED T8 LAMPS

Premium LED T8 ballast bypass, true flicker-free lamps

- No ballast or external driver required
- Flicker free — Less than 2%
- Installation protection— will not light if ballast is not bypassed
- Low Wattage — only 11.5 watts
- High lumen — up to 2600
- Direct wire 120-277V line voltage*
- All glass tube
- PET Coated — shatterproof
- Long life: 50,000 hours
- c-UL-us Classified
- ETL Sanitation listed (conforms to NSF)
- DLC Listed
- 5 Year warranty



2 Installation Options

1. Double Ended Wiring

AC 120-277V

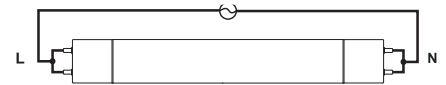

2. Single Ended Wiring

AC 120-277V

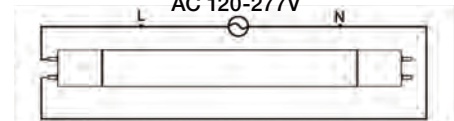

(Non-shunted sockets)



LED T8 fluorescent replacement lamps

Item Number	Lamp Description	W	CRI	Bm	CCT	Lm	M.O.L. (Inches)	Life/ Hrs.	UPC	Case Pack
S11910	11.5T8/LED/48-830/FF/BP 120-277V	11.5	80	190°	3000	1650	48	50K	045923119101	25
S11911	11.5T8/LED/48-835/FF/BP 120-277V	11.5	80	190°	3500	1650	48	50K	045923119118	25
S11912	11.5T8/LED/48-840/FF/BP 120-277V	11.5	80	190°	4000	1750	48	50K	045923119125	25
S11913	11.5T8/LED/48-850/FF/BP 120-277V	11.5	80	190°	5000	1800	48	50K	045923119132	25
S11914	18.5T8/LED/48-830/FF/BP 120-277V	18.5	80	190°	3000	2400	48	50K	045923119149	25
S11915	18.5T8/LED/48-835/FF/BP 120-277V	18.5	80	190°	3500	2400	48	50K	045923119156	25
S11916	18.5T8/LED/48-840/FF/BP 120-277V	18.5	80	190°	4000	2500	48	50K	045923119163	25
S11917	18.5T8/LED/48-850/FF/BP 120-277V	18.5	80	190°	5000	2600	48	50K	045923119170	25

Product sheet SA2527

**See warranty for details.

LED T8 LAMPS

15W Linear LED ballast bypass T8 series

Direct wire replacement for linear fluorescent T8 lamps in existing fixtures. Single ended wiring/non-shunted sockets.

- Single ended wiring/non-shunted sockets
- No ballast or external driver required
- Direct wire 120-277V line voltage**
- All glass tube
- Damp location
- c-UL-us Classified
- DLC listed*
- Long life—50,000 hours
- 5 Year warranty



Single Ended Wiring Diagram
AC120-277V

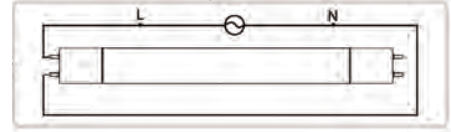

Wiring harnesses available including non-shunted sockets, sold separately

Item Number	Description
80/2626	1 LT BALLAST BYPASS WIRING HARNESS
80/2627	2 LT BALLAST BYPASS WIRING HARNESS
80/2628	3 LT BALLAST BYPASS WIRING HARNESS
80/2629	4 LT BALLAST BYPASS WIRING HARNESS

LED T8 Ballast Bypass



Item Number	Lamp Description	W	CRI	Base Type	Bm	CCT	Lm	M.O.L. (Inches)	Life/ Hrs.	UPC	Pack
S9720*	15T8/LED/48-830/BP	15	82	Med Bi-Pin	230°	3000K	1700	48	50K	045923097201	10
S9721*	15T8/LED/48-835/BP	15	82	Med Bi-Pin	230°	3500K	1700	48	50K	045923097218	10
S9722*	15T8/LED/48-840/BP	15	82	Med Bi-Pin	230°	4000K	1800	48	50K	045923097225	10
S9723*	15T8/LED/48-850/BP	15	82	Med Bi-Pin	230°	5000K	1800	48	50K	045923097232	10

** Install on non-shunted lampholders

Product sheet SA1887

Linear LED ballast bypass T8 U-bend series

- No ballast or external driver required
- Direct wire 120-277V line voltage**
- All glass tube
- Damp location
- c-UL-us Classified
- DLC listed*
- Long life—50,000 hours
- 5 Year warranty



Wiring Diagram
AC 120-277 V

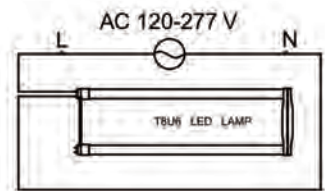

Linear LED Ballast Bypass T8 U-Bend Series

Item Number	Lamp Description	W	V	CRI	CCT	Lm	Bm	M.O.L. (inches)	Life/ Hrs.	UPC	Pack
S9930*	15T8U6/LED/22.5-830/BP	15	120-277	82	3000K	1700	220°	22 ½	50K	045923099304	12
S9931*	15T8U6/LED/22.5-835/BP	15	120-277	82	3500K	1700	220°	22 ½	50K	045923099311	12
S9932*	15T8U6/LED/22.5-840/BP	15	120-277	82	4000K	1800	220°	22 ½	50K	045923099328	12
S9933*	15T8U6/LED/22.5-850/BP	15	120-277	82	5000K	1800	220°	22 ½	50K	045923099335	12

** Install on non-shunted lampholders

Product sheet SA2189

LED T8 LAMPS

43W Linear LED ballast bypass 8' T8 series

- Double ended wiring
- Shatterproof coated
- Over 40% energy savings vs standard 8' T8 systems
- Slimline single pin base - replaces T8 & T12
- No ballast or external driver required
- Direct wire 120-277V line voltage
- All glass tube
- Damp location
- NSF certified
- c-UL-us Classified
- Long life—50,000 hours
- 5 Year warranty



Wiring Diagram

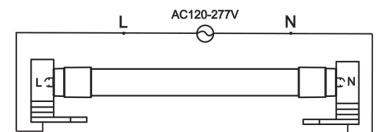

LED T8 Ballast Bypass

Item Number	Lamp Description	W	V	CRI	Base Type	Bm	CCT	Lm	M.O.L. (Inches)	Life/Hrs.	UPC	Pack
S9917*	43T8/LED/96-835/BP	43	120-277V	82	Single Pin	210°	3500K	5500	96	50K	045923099175	10
S9918*	43T8/LED/96-840/BP	43	120-277V	82	Single Pin	210°	4000K	5500	96	50K	045923099182	10
S9919*	43T8/LED/96-850/BP	43	120-277V	82	Single Pin	210°	5000K	5500	96	50K	045923099199	10
S11925	43T8/LED/96-865/BP	42	120-277V	82	Single Pin	210°	6500K	5500	96	50K	045923119255	10

Product sheet SA2438

43W Linear LED ballast bypass 8' T8 series

- Double ended wiring
- Shatterproof coated
- Over 40% energy savings vs standard 8' T8 systems
- R17d base designed to replace 8' T8 HO and T12 HO Fluorescent lamps
- No ballast or external driver required
- Direct wire 120-277V line voltage
- All glass tube
- Damp location
- NSF certified
- c-UL-us Classified
- Long life—50,000 hours
- 5 Year warranty



Wiring Diagram

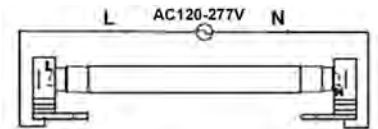

LED T8 Ballast Bypass

Item Number	Lamp Description	W	V	CRI	Base Type	Bm	CCT	Lm	M.O.L. (Inches)	Life/Hrs.	UPC	Pack
S9924	43T8/LED/96-840/BP/R17d	43	120-277V	82	R17d	210°	4000K	5500	96	50K	045923099243	10
S9925	43T8/LED/96-850/BP/R17d	43	120-277V	82	R17d	210°	5000K	5500	96	50K	045923099250	10
S9942	43T8/LED/96-865/BP/R17d	43	120-277V	82	R17d	210°	6500K	5500	96	50K	045923099427	10

Product sheet SA2611

**See warranty for details.

LED T5 LAMPS

25W, 4' Linear LED T5 lamps

Direct replacement for linear fluorescent F54T5HO lamps in existing fixtures with electronic ballasts. No rewiring required♦

- Over 50% energy savings vs. standard 4' T5 systems
- All glass tube
- Compatible with rapid start ballasts*
- Integrated thermal fuse at pins
- Damp location • NSF certified
- c-UL-us listed • DLC listed*
- Long life—50,000 hours
- 5 Year warranty



LED T5 Ballast Compatible

Item Number	Lamp Description	W	CRI	Base Type	Bm	CCT	Lm	Nominal (M.O.L.)	Life/Hrs.	UPC	Pack
S29912*	25T5/LED/46-835/DR	25	82	G5	185°	3500K	3300	48 (46)	50K	045923097126	10
S29910*	25T5/LED/46-840/DR	25	82	G5	185°	4000K	3500	48 (46)	50K	045923097102	10
S29911*	25T5/LED/46-850/DR	25	82	G5	185°	5000K	3500	48 (46)	50K	045923097119	10

* May not be compatible with all rapid start ballasts. Visit www.satco.com for an approved list.

Product sheet SA2306

Satco LED T5 ballast bypass series

Ballast bypass replacement for linear fluorescent T5 HO & HE lamps in existing fixtures.

- No ballast or external driver required
- Available in 2', 3' & 4'
- Direct wire 120-277V line voltage
- All glass tube • PET-shatterproof coated
- Damp location • c-UL-us Classified
- NSF certified • DLC listed*
- Long life—50,000 hours
- 5 Year warranty

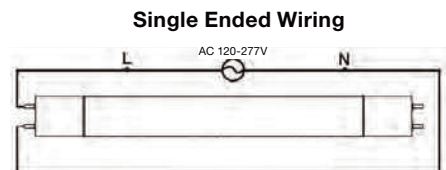

LED T5 Ballast Bypass Lamps

Item Number	Lamp Description	W	V	CRI	Base Type	Bm	CCT	Lm	Nominal (M.O.L.)	Life/Hrs.	UPC	Pack
S8693	12T5/LED/24-835/BP/HO	12	120-277	83	G5	240°	3500K	1400	24 (22.5)	50K	045923086939	25
S8694	12T5/LED/24-840/BP/HO	12	120-277	83	G5	240°	4000K	1450	24 (22.5)	50K	045923086946	25
S8695	12T5/LED/24-850/BP/HO	12	120-277	83	G5	240°	5000K	1500	24 (22.5)	50K	045923086953	25
S8696	16T5/LED/36-835/BP/HO	16	120-277	83	G5	240°	3500K	1800	36 (34)	50K	045923086960	25
S8697	16T5/LED/36-840/BP/HO	16	120-277	83	G5	240°	4000K	1850	36 (34)	50K	045923086977	25
S8698	16T5/LED/36-850/BP/HO	16	120-277	83	G5	240°	5000K	1900	36 (34)	50K	045923086984	25
S8690*	13T5/LED/46-835/BP/HE	13	120-277	83	G5	240°	3500K	1600	48 (46)	50K	045923086908	25
S8691*	13T5/LED/46-840/BP/HE	13	120-277	83	G5	240°	4000K	1650	48 (46)	50K	045923086915	25
S8692*	13T5/LED/46-850/BP/HE	13	120-277	83	G5	240°	5000K	1700	48 (46)	50K	045923086922	25
S29717*	25T5/LED/46-835/BP/HO	25	120-277	83	G5	240°	3500K	3200	48 (46)	50K	045923297175	25
S29718*	25T5/LED/46-840/BP/HO	25	120-277	83	G5	240°	4000K	3300	48 (46)	50K	045923297182	25
S29719*	25T5/LED/46-850/BP/HO	25	120-277	83	G5	240°	5000K	3400	48 (46)	50K	045923297199	25

Product sheet SA2195

Satco LED T5 mini bi-pin (G5) ballast bypass series

Ballast bypass replacement for mini bi-pin linear fluorescent T5 preheat lamps in existing fixtures.

- No ballast or external driver required
- Available in 6", 9", 12", & 21"
- Direct wire 120-277V line voltage
- PET Shatterproof coated
- Damp location
- c-UL-us classified
- Long life—50,000 hours
- 5 Year warranty

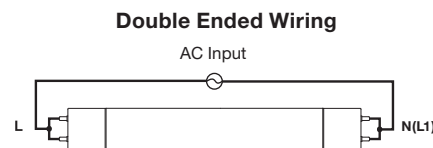

LED T5 Mini Bi-Pin Ballast Bypass Lamps

Item Number	Lamp Description	Replaces	W	V	CRI	Base Type	Bm	CCT	Lm	M.O.L. (Nominal)	Length (Inches)	Life/Hrs.	UPC	Pack
S11900	2W/LED/T5/840	F4T5/CW	2	120-277	80	G5	240°	4000K	150	5 29/32	6	50K	045923119002	10
S11901	2W/LED/T5/865	F4T5/D	2	120-277	80	G5	240°	6500K	150	5 29/32	6	50K	045923119019	10
S11902	3W/LED/T5/840	F6T5/CW	3	120-277	80	G5	240°	4000K	270	8 29/32	9	50K	045923119026	10
S11903	3W/LED/T5/865	F6T5/D	3	120-277	80	G5	240°	6500K	270	8 29/32	9	50K	045923119033	10
S11904	4W/LED/T5/830	F8T5/WW	4	120-277	80	G5	240°	3000K	400	11 29/32	12	50K	045923119040	10
S11905	4W/LED/T5/840	F8T5/CW	4	120-277	80	G5	240°	4000K	400	11 29/32	12	50K	045923119057	10
S11906	4W/LED/T5/865	F8T5/D	4	120-277	80	G5	240°	6500K	400	11 29/32	12	50K	045923119064	10
S11907	7W/LED/T5/830	F13T5/WW	7	120-277	80	G5	240°	3000K	700	20 29/32	21	50K	045923119071	10
S11908	7W/LED/T5/840	F13T5/CW	7	120-277	80	G5	240°	4000K	700	20 29/32	21	50K	045923119088	10
S11909	7W/LED/T5/865	F13T5/D	7	120-277	80	G5	240°	6500K	700	20 29/32	21	50K	045923119095	10

**See warranty for details.

LED T8 LAMPS

LED T8 dual mode (ballast bypass/ ballast compatible) 1-5/8" u-bend lamps

Direct replacements for fluorescent T8 u-bend lamps in existing fixtures with or without ballasts.

- Over 50% energy savings vs. standard T8 systems
- Ballast compatible and ballast bypass in one lamp
- Bypass mode works in single or double ended wiring†
- Protection from arcing
- 120-277V in bypass mode
- Damp location
- NSF certified
- DLC 4.2 listed
- C-UL-us listed—ballast compatible
- c-UL-us Classified—ballast bypass
- Long life—50,000 hours
- 5 Year warranty



LED T8 Dual Mode U-bend Lamps—Ballast Compatible



Item Number	Lamp Description	W	CRI	CCT	Lm	M.O.L. (Inches)	Life/ Hrs.	UPC	Pk./ Mstr.
S18450	13T8/U1-G13/LED/830/DUAL	13	80	3000K	1800	22 ½	50K	045923184505	24
S18451	13T8/U1-G13/LED/835/DUAL	13	80	3500K	1800	22 ½	50K	045923184512	24
S18452	13T8/U1-G13/LED/840/DUAL	13	80	4000K	1900	22 ½	50K	045923184529	24
S18453	13T8/U1-G13/LED/850/DUAL	13	80	5000K	2000	22 ½	50K	045923184536	24

May not be compatible with all instant start, rapid start, dimmable, and emergency ballasts. Visit www.satco.com for an approved list.

Product sheet SA2462

LED T8 Dual Mode U-bend Lamps—Ballast Bypass



Item Number	Lamp Description	W	V	CRI	CCT	Lm	M.O.L. (Inches)	Life/ Hrs.	UPC	Pk./ Mstr.
S18450	13T8/U1-G13/LED/830/DUAL	13	120-277	80	3000K	1800	22 ½	50K	045923184505	24
S18451	13T8/U1-G13/LED/835/DUAL	13	120-277	80	3500K	1800	22 ½	50K	045923184512	24
S18452	13T8/U1-G13/LED/840/DUAL	13	120-277	80	4000K	1900	22 ½	50K	045923184529	24
S18453	13T8/U1-G13/LED/850/DUAL	13	120-277	80	5000K	2000	22 ½	50K	045923184536	24

Product sheet SA2462

LED T8 dual mode (ballast bypass/ ballast compatible) linear lamps

Direct replacements for fluorescent T8 lamps in existing fixtures with or without ballasts.

- Over 40% energy savings vs. standard T8 systems
- Ballast compatible (12W) and ballast bypass (13W) in one lamp
- Bypass mode works in single or double ended wiring**
- Protection from arcing***
- All glass tube
- Compatible with emergency and dimming ballasts*
- 120-277V in bypass mode
- Damp location
- PET coated
- NSF certified
- DLC 4.2 listed
- C-UL-us listed—ballast compatible
- c-UL-us Classified—ballast bypass
- Long life—50,000 hours
- 5 Year warranty



LED T8 Dual Mode Linear Lamps

Item Number	Lamp Description	W	CRI	CCT	Lm	Bm	M.O.L. (Inches)	Life/ Hrs.	UPC	Pack/ Master
Ballast Compatible*										
S8890	12T8/LED/48-830/DUAL/BP-DR	12	83	3000K	1800	240°	48	50K	045923088902	25
S8891	12T8/LED/48-835/DUAL/BP-DR	12	83	3500K	1800	240°	48	50K	045923088919	25
S8892	12T8/LED/48-840/DUAL/BP-DR	12	83	4000K	1900	240°	48	50K	045923088926	25
S8893	12T8/LED/48-850/DUAL/BP-DR	12	83	5000K	1900	240°	48	50K	045923088933	25

* May not be compatible with all instant start, rapid start, dimmable, and emergency ballasts. Visit www.satco.com for an approved list.

Product sheet SA2316

LED T8 Dual Mode Linear Lamps



Item Number	Lamp Description	W	V	CRI	CCT	Lm	Bm	M.O.L. (Inches)	Life/ Hrs.	UPC	Pack/ Master
Ballast Bypass**											
S8890	13T8/LED/48-830/DUAL/BP-DR	13	120-277	83	3000K	1800	240°	48	50K	045923088902	25
S8891	13T8/LED/48-835/DUAL/BP-DR	13	120-277	83	3500K	1800	240°	48	50K	045923088919	25
S8892	13T8/LED/48-840/DUAL/BP-DR	13	120-277	83	4000K	1900	240°	48	50K	045923088926	25
S8893	13T8/LED/48-850/DUAL/BP-DR	13	120-277	83	5000K	1900	240°	48	50K	045923088933	25

* May not be compatible with all instant start, rapid start, dimmable, and emergency ballasts. Visit www.satco.com for an approved list.

** Bypass mode works wired as a single ended lamp on non-shunted sockets or as a double ended lamp on either shunted or non-shunted sockets.

Product sheet SA2316

**See warranty for details.

LED T8 LAMPS

LED T8 dual mode linear lamps

(Cont'd. from page 99)

Wiring-Ballast Compatible

- For instant start ballasts on the approved list, ensure that LED/fluorescent sockets are wired in a shunt configuration according to manufacturer's wiring diagram.
- For rapid start ballasts on the approved list, non-shunted LED/fluorescent sockets are needed and wired according to manufacturer's wiring diagram.

Wiring Options-Ballast Bypass - 120-277V

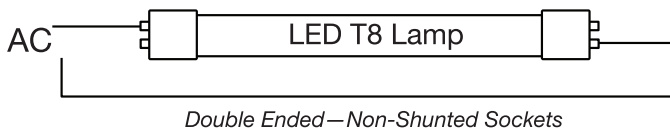
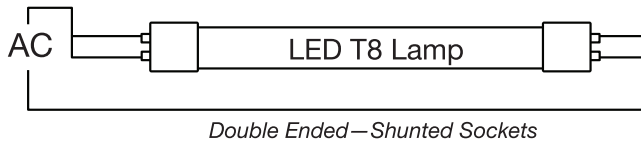
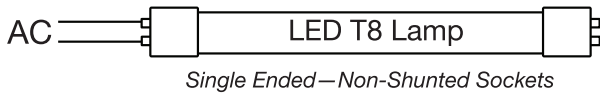

System Performance - LED T8 Dual Mode Linear Lamps—Ballast Compatible

System Performance Chart				Bare Lamp (Rated)		Bare Lamp Wattage			System Wattage			Initial Lumens			Lifetime		
Item Nmbr	Description	CCT	Length (ft)	Nominal Wattage	Nominal Lumens	LBF (0.78)	NBF (0.88)	HBF (1.18)	LBF (0.78)	NBF (0.88)	HBF (1.18)	LBF (0.78)	NBF (0.88)	HBF (1.18)	LBF (0.78)	NBF (0.88)	HBF (1.18)▼
S8890	12T8/LED/48-830/DUAL/BP-DR	3000K	4	12	1800	11.0	12.0	17	13.5	15.5	20.0	1600	1800	2500	>50Khrs	>50Khrs	50Khrs
S8891	12T8/LED/48-835/DUAL/BP-DR	3500K	4	12	1800	11.0	12.0	17	13.5	15.5	20.0	1600	1800	2500	>50Khrs	>50Khrs	50Khrs
S8892	12T8/LED/48-840/DUAL/BP-DR	4000K	4	12	1900	11.0	12.0	17	13.5	15.5	20.0	1700	1900	2600	>50Khrs	>50Khrs	50Khrs
S8893	12T8/LED/48-850/DUAL/BP-DR	5000K	4	12	1900	11.0	12.0	17	13.5	15.5	20.0	1700	1900	2600	>50Khrs	>50Khrs	50Khrs

*** Power must be turned off prior to installing lamps. Sockets must be in good working order, not broken, cracked or electrically compromised. If arcing occurs at the lamp pin, thermal fuse may activate to avoid overheating of lamp.

▼ LED tube life will change with ballast factor, configurations producing ballast factors above 1.18 are not allowed.

LED T9 CIRCLINE LAMPS

8" and 12" T9 LED ballast bypass Circline lamps

- No ballast or external driver required
- Over 40% energy savings vs. standard T9 systems
- Replaces 22W and 32W fluorescent Circlines
- 120–277V (direct wire)
- Damp location
- NSF certified
- c-ETL-us listed
- Long life—50,000 hours
- 5 Year warranty



12"–16 Watt



8"–11 Watt

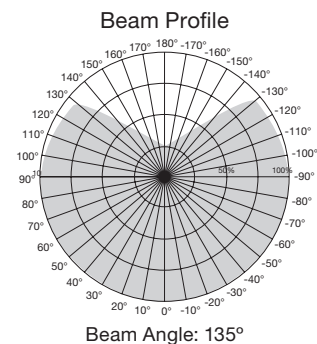

LED T9 8" and 12" Circline Lamps



Item Number	Lamp Description	W	CRI	Base Type	V	Bm	CCT	Lm	M.O.L. (Inches)	Life/Hrs.	UPC	Pack
S16500	FC8T9/11W/LED/CIR/830/BP	11	80	G10Q	120-277	135°	3000K	1100	8	50K	045923165009	20
S16501	FC8T9/11W/LED/CIR/840/BP	11	80	G10Q	120-277	135°	4000K	1210	8	50K	045923165016	20
S16502	FC8T9/11W/LED/CIR/865/BP	11	80	G10Q	120-277	135°	6500K	1210	8	50K	045923165023	20
S16503	FC12T9/16W/LED/CIR/830/BP	16	80	G10Q	120-277	135°	3000K	1600	12	50K	045923165030	20
S16504	FC12T9/16W/LED/CIR/840/BP	16	80	G10Q	120-277	135°	4000K	1760	12	50K	045923165047	20
S16505	FC12T9/16W/LED/CIR/865/BP	16	80	G10Q	120-277	135°	6500K	1760	12	50K	045923165054	20

**See warranty for details.

LED T8 & T5 LAMPS

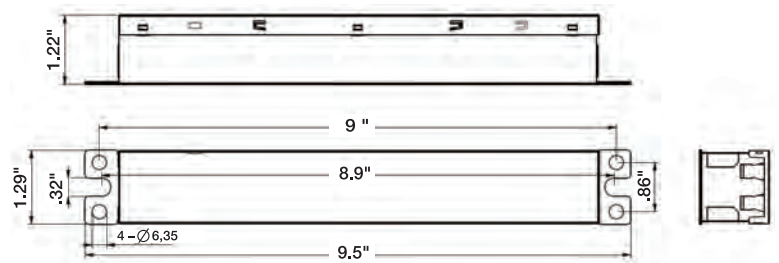
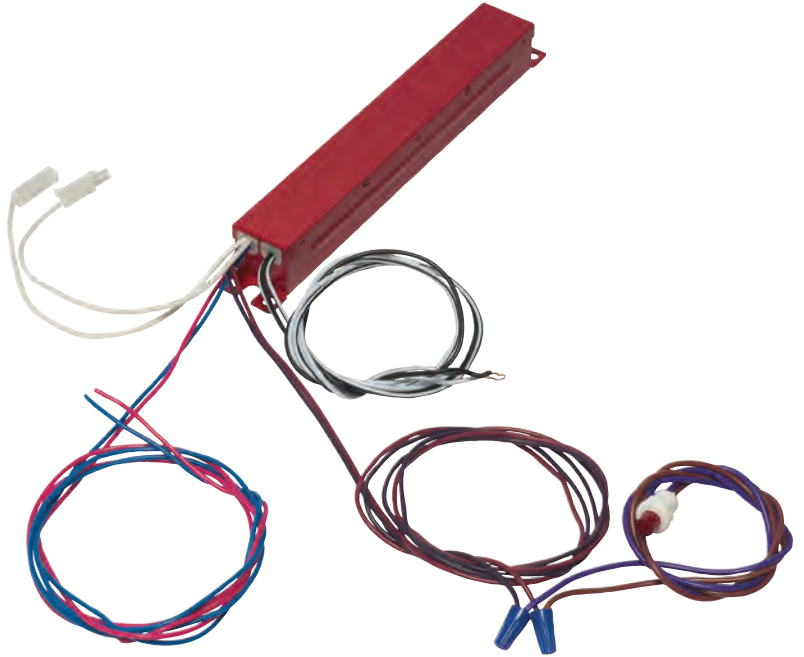

Emergency battery backup and LED driver.

For LED T8 and T5 ballast bypass lamps.

- 5 Watt output power
- 1.8 Watt standby power
- 90 minute battery run time at 5W
- Output and over-power protection
- Lithium Ion battery
- 0°C-50°C Operating temperature
- Recharge 24 hours max
- 5 Year warranty

For use with the following lamps:

1. Satco 4' T8 (S9720-S9723)
2. Satco U-Bend (S9930-S9933)
3. Satco 4' T5 LED bypass lamps (S29717-S29719)
4. Satco new generation double ended bypass lamps (S29900-S29907, S29926-S29929, S29913-S29916)

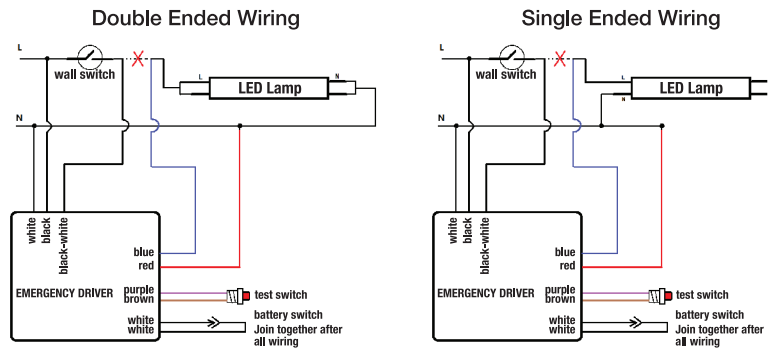

Emergency Battery Backup & LED Driver—For LED T8 and T5 Ballast Bypass Lamps

Item Number	Description	W	V	M.O.L. (inches)	Dimensions	UPC	Case
S8000	5W Emergency LED driver	5	120-277	9.5	1.3"W x 1.22"H x 9.5"L	045923080005	25

Product sheet SA2363

LED T8 SIGN LAMPS

LED T8 sign lamps extended line with new length options

- Over 40% savings vs. standard T8 systems
- 14 Length options from 2' to 10'
- Base rotates 90° for easy installation
- Full illumination for 2-way signs
- Wide, 330° beam angle
- CRI >83
- No ballast and no external driver required
- Direct wire 120-277V line voltage
- Damp location
- NSF Certified
- c-UL-us Classified
- Long life—50,000 hours
- 5 Year warranty



Wiring Diagram - AC 120-277V
Single Ended Wiring Required

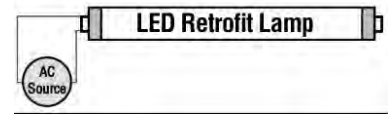

LED T8 Sign Lamps



Item Number	Lamp Description	W	CRI	Base	CCT	Lm	Nominal (MOL)	Life/ Hrs.	UPC	Pk./ Mstr.
S16412	7T8/LED/HO-SIGN/18-840/BP NEW	7	83	R17D	4000K	950	18 (15.9)	50K	045923164125	10
S16413	7T8/LED/HO-SIGN/18-865/BP NEW	7	83	R17D	6500K	950	18 (15.9)	50K	045923164132	10
S16400	9T8/LED/HO-SIGN/24-840/BP	9	83	R17D	4000K	1200	24 (21.9)	50K	045923164002	10
S16401	9T8/LED/HO-SIGN/24-865/BP	9	83	R17D	6500K	1200	24 (21.9)	50K	045923164019	10
S16414	11T8/LED/HO-SIGN/30-840/BP NEW	11	83	R17D	4000K	1500	30 (27.9)	50K	045923164149	10
S16415	11T8/LED/HO-SIGN/30-865/BP NEW	11	83	R17D	6500K	1500	30 (27.9)	50K	045923164156	10
S16402	12T8/LED/HO-SIGN/36-840/BP	12	83	R17D	4000K	1500	36 (33.9)	50K	045923164026	10
S16403	12T8/LED/HO-SIGN/36-865/BP	12	83	R17D	6500K	1500	36 (33.9)	50K	045923164033	10
S16416	15T8/LED/HO-SIGN/42-840/BP NEW	15	83	R17D	4000K	2100	42 (40)	50K	045923164163	10
S16417	15T8/LED/HO-SIGN/42-865/BP NEW	15	83	R17D	6500K	2100	42 (40)	50K	045923164170	10
S16404	18T8/LED/HO-SIGN/48-840/BP	18	83	R17D	4000K	2300	48 (46.0)	50K	045923164040	10
S16405	18T8/LED/HO-SIGN/48-865/BP	18	83	R17D	6500K	2300	48 (46.0)	50K	045923164057	10
S16406	24T8/LED/HO-SIGN/60-840/BP	24	83	R17D	4000K	3100	60 (57.9)	50K	045923164064	10
S16407	24T8/LED/HO-SIGN/60-865/BP	24	83	R17D	6500K	3100	60 (57.9)	50K	045923164071	10
S16418	26T8/LED/HO-SIGN/64-840/BP NEW	26	83	R17D	4000K	3650	64 (61.9)	50K	045923164187	10
S16419	26T8/LED/HO-SIGN/64-865/BP NEW	26	83	R17D	6500K	3650	64 (61.9)	50K	045923164194	10
S16408	30T8/LED/HO-SIGN/72-840/BP	30	83	R17D	4000K	4100	72 (69.9)	50K	045923164088	10
S16409	30T8/LED/HO-SIGN/72-865/BP	30	83	R17D	6500K	4100	72 (69.9)	50K	045923164095	10
S16420	32T8/LED/HO-SIGN/84-840/BP NEW	32	83	R17D	4000K	4500	84 (81.9)	50K	045923164200	10
S16421	32T8/LED/HO-SIGN/84-865/BP NEW	32	83	R17D	6500K	4500	84 (81.9)	50K	045923164217	10
S16410	36T8/LED/HO-SIGN/96-840/BP	36	83	R17D	4000K	5000	96 (93.9)	50K	045923164101	10
S16411	36T8/LED/HO-SIGN/96-865/BP	36	83	R17D	6500K	5000	96 (93.9)	50K	045923164118	10
S16422	42T8/LED/HO-SIGN/108-840/BP NEW	42	83	R17D	4000K	5800	108 (105)	50K	045923164224	10
S16423	42T8/LED/HO-SIGN/108-865/BP NEW	42	83	R17D	6500K	5800	108 (105)	50K	045923164231	10
S16424	45T8/LED/HO-SIGN/117-840/BP NEW	45	83	R17D	4000K	6300	117 (114)	50K	045923164248	10
S16425	45T8/LED/HO-SIGN/117-865/BP NEW	45	83	R17D	6500K	6300	117 (114)	50K	045923164255	10
S16426	48T8/LED/HO-SIGN/120-840/BP NEW	48	83	R17D	4000K	6700	120 (117)	50K	045923164262	10
S16427	48T8/LED/HO-SIGN/120-865/BP NEW	48	83	R17D	6500K	6700	120 (117)	50K	045923164279	10

**See warranty for details.

Circular LED module retrofit kits

Upgrades most flushmount fixtures to efficient LED light

- Replaces 3 60W incandescent lamps, uses only 20 Watts
- Dimmable
- Dimensions: 8" W x 0.65" H
- Life—30,000 hours
- 3 Year warranty
- LED Circular light engine
- All necessary hardware for installation into a variety of flushmount fixtures
- Instructions and wiring diagrams

- A) (1) circular light engine
- B) (6) small wire nuts
- C) (6) medium wire nuts
- D) (1) lock-down retaining ring & washer
- E) (3) 1" #4 screws
- F) (4 x 2 each) assorted snap-in grommets (install grommets where supply wires enter fixture for power).
- G) Wiring Diagram



Easily converts most standard flushmount fixtures to LED



Circular LED Module Retrofit Kits



Item Number	Lamp Description	W	V	CCT	CRI	Lm	Life/Hrs.	UPC	Pack
S9782	20W/LED/LIGHT ENGINE/27K/RK	20	120-277	2700K	90	1450	30K	045923097829	20/1
S9783	20W/LED/LIGHT ENGINE/30K/RK	20	120-277	3000K	90	1550	30K	045923097836	20/1
S9784	20W/LED/LIGHT ENGINE/40K/RK	20	120-277	4000K	90	1650	30K	045923097843	20/1

Product sheet SA2002



Satco retail support

At Satco we don't just bring great products and great value to market. We help our products sell! We offer powerful in-store selling tools to help make the lighting center a focal point and profit center.

Educate customers and increase sales!

Satco hanging signs and gondola headers clearly call-out the lighting center while shelf strips and aisle flags indicate lamp technologies to help customers find exactly what they're looking for. And the shelf strips correspond to the attractive, informative Satco packaging! Our educational gondola headers educate consumers about all the current lighting technologies, the energy efficiency of each and what energy savings they can expect from each.

Counter cards, hanging signs, shelf-talkers and gondola aisle flags all help customers find the exact replacement lamp they need.

Let Satco help you increase your lighting sales dramatically! For information and how to order, please contact your Satco sales representative.



Satco Brand Logo Banner
Item # SA1296

Logo banners

Measuring 5' x 2', Satco logo banners can be strategically placed, indoors or out, to direct customers to the lighting aisle or simply make customers aware you carry Satco lighting products.



Energy Efficient Lamps and Fixtures Counter Card
Item # SA1458

Counter cards

Place these informative cards in other busy departments to remind customers about their lighting needs.

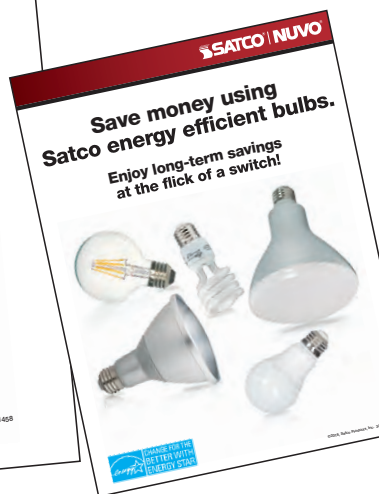

Energy Efficient Lamps Counter Card
Item # SA1207



Paint Department Counter Card
Item # SA1456

RETAIL SUPPORT

HID	HID	HID	SA1265/1
LED	LED	LED	SA1265/2
CFL	CFL	CFL	SA1265/3
HALOGEN	HALOGEN	HALOGEN	SA1265/4
INCANDESCENT	INCANDESCENT	INCANDESCENT	SA1265/5

Lighting Technology Gondola Shelf Strips

(Can be ordered separately)
Each strip measures 12" long
Item # SA1265

Packaging

Satco retail packaging is informative and attractive, creating an easy to navigate presentation for your customers. Coupled with consistent branding, lamp technology types are clearly indicated and all government regulations are adhered to for lumen output, wattage and cost to operate. Satco packaging makes choosing the right lamp easy.

Gondola shelf technology strips

Indicate what technologies are on what shelves. Grouping products by their technology has been shown to help customers find the products they want easily.

Shelf talkers

Are an important silent salesman, explaining a sale or calling attention to a new product.



Energy Efficient Shelf Talker
Item # SA1205

**See warranty for details.

RETAIL SUPPORT



Generic Lighting Center Gondola Header
 Item # SA1098
 Header mounting hardware available



Energy Efficient Gondola Header
 Item # SA1206
 Header mounting hardware available



LED Gondola Header
 Item # SA2006
 Header mounting hardware available

Gondola headers

Clearly call out your lighting center, and our educational versions help explain new vs. old lighting technologies and the savings your customers can expect from them. Customers making more informed decisions will be pleased with their purchase and remember the help they received in your store.



Product photos

Satco offers our entire library of product photos for use in your flyers and advertising. Our high-quality product and packaging images will show customers exactly what you're offering.

Aisle flags

Help define what's on each section of shelving for easy product location.

Lighting Technology Aisle Violator Tags
 Item # SA1292
 Mounting hardware available



SA1292/1 SA1292/2 SA1292/3 SA1292/4 SA1292/5 SA1292/6

RETAIL SUPPORT

SATCO | NUVO

Lamp Technology Wattage Comparison

www.satco.com

INCANDESCENT • Life: 1,000 Hours			HALOGEN • Life: 1,000 Hours • GOOD			CFL • Life: 10,000 Hours • BETTER			LED • Life: 25,000+ Hours • BEST		
Standard Wattage	Lumens/Brightness	Cost to Operate/Yr*	Wattage	Lumens/Brightness	Cost to Operate/Yr**	Wattage	Lumens/Brightness	Cost to Operate/Yr**	Wattage	Lumens/Brightness	Cost to Operate/Yr**
25W	= 200	\$3.01	=	=	=	5W	= 280	\$0.84	3W	= 180	\$0.36
40W [†]	= 450	\$4.82	29W	= 410	\$3.49	9W	= 550	\$1.08	8W	= 450	\$0.96
60W [†]	= 800	\$7.23	43W	= 750	\$5.18	13W	= 900	\$1.57	10W	= 800	\$1.20
75W [†]	= 1,100	\$9.03	53W	= 1,050	\$6.38	18W	= 1,200	\$2.17	13W	= 1,100	\$1.57
100W [†]	= 1,600	\$12.05	72W	= 1,490	\$8.67	23W	= 1,600	\$2.77	17W	= 1,600	\$2.05

† Discontinued technology.
* Estimated yearly energy cost is based on 3 hrs/day, 0.11¢ kWh. Cost depends on rates and use.
** Estimated yearly energy cost is based on 3 hrs/day, 0.11¢ kWh. Cost depends on rates and use.

SA1285/1
Lamp Comparison Guide

SATCO | NUVO

Lamp Savings Comparison - per lamp, per year*

www.satco.com

INCANDESCENT Standard Wattage	Savings for Halogen Life = 1,000 Hours	Savings for CFL Life = 10,000 Hours	Savings for LED Life = 25,000 Hours	SAVE MORE
25W	=	\$2.17	\$2.65	Long life = Less replacement lamps
40W	= \$1.33	\$3.74	\$3.86	
60W	= \$2.05	\$5.66	\$6.03	
75W	= \$2.65	\$6.86	\$7.46	
100W	= \$3.38	\$9.28	\$10.00	





* Estimated yearly energy cost is based on 3 hrs/day, 0.11¢ kWh. Cost depends on rates and use.

SA1285/2
Lamp Savings Comparison

SATCO | NUVO

Lamp Feature Comparison

www.satco.com

 <p>INCANDESCENT</p> <ul style="list-style-type: none"> • Good light quality • Low initial cost • Dimmable • Shortest life • Least Efficient 	 <p>HALOGEN</p> <ul style="list-style-type: none"> • Great light quality • Dimmable • Same bulb shape • Energy savings: GOOD 	 <p>CFL (COMPACT FLUORESCENT)</p> <ul style="list-style-type: none"> • Big jump in energy savings • Instant on • Long bulb life, recyclable • Energy savings: BETTER 	 <p>LED (LIGHT EMITTING DIODE)</p> <ul style="list-style-type: none"> • Most energy efficient • Immediate full brightness • Dimmable • Costs the least to operate • Longest bulb life available • Energy savings: BEST
---	---	---	---

SA1285/3
Lamp Features Comparison

SATCO | NUVO

Long Life = Less Replacements

www.satco.com

<p>1 CFL lasts as long as 10 Incandescents</p>  =  <p>A 13W CFL costs \$1.57 per year to operate in energy costs vs. a 60W incandescent that costs \$7.23 per year.*</p>	<p>1 LED lasts as long as 25 Incandescents</p>  =  <p>An 8W LED costs \$0.96 per year to operate in energy costs vs. a 60W incandescent that costs \$7.23 per year.*</p>
---	---

* Estimated yearly energy cost is based on 3 hrs/day, 0.11¢ kWh. Cost depends on rates and use.

SA1285/4
Long Life = Less Replacements



SA1285/5
Lumens: The new way to shop for light

SATCO | NUVO

Choosing Color Temperature

www.satco.com

Lighting sets the mood in your room.

COLOR TEMPERATURE SCALE		
Soft White	Bright White	Natural Light
2700K 3000K 3500K	4100K 5000K	7500K
<p>Warm</p> <p>2700K is inviting, warm, friendly and relaxing.</p> <ul style="list-style-type: none"> • Homes • Restaurants 	<p>Neutral</p> <p>3000K is inviting, comfortable and relaxing.</p> <ul style="list-style-type: none"> • Homes • Showrooms • Reception • Offices 	<p>Cool</p> <p>4100K is efficient, clean and organized.</p> <ul style="list-style-type: none"> • Offices • Hospitals • Conference rooms

<p>2700K</p>  <p>Warm</p>	<p>3000K</p>  <p>Neutral</p>	<p>4100K</p>  <p>Cool</p>	<p>5000K</p>  <p>Daylight</p>
--	---	--	--

SA1285/6
Choosing Color Temperature

Lamp Comparison Gondola Headers

SET: 6

(Can be ordered separately)

Item # SA1285

Header mounting hardware available

INDEX

Item #	Page #	Item #	Page #	Item #	Page #	Item #	Page #
80-92928, 73, 77, 78, 79, 80, 81, 82		S11702.....	62	S12217.....	41	S16503.....	105
80-935.....	74	S11703.....	62	S12250.....	42	S16504.....	105
80-936.....	69	S11704.....	63	S12251.....	42	S16505.....	105
80-937.....	69	S11705.....	63	S12252.....	42	S18450.....	100
80-938.....	69	S11706.....	63	S12253.....	42	S18451.....	100
80-939.....	69	S11707.....	63	S13100.....	71	S18452.....	100
80-942.....	65, 67	S11708.....	60	S13101.....	71	S18453.....	100
80-943.....	65, 67	S11709.....	60	S13102.....	71	S21100.....	6
80-944.....	65, 67	S11710.....	60	S13103.....	71	S21101.....	6
80-945.....	65, 67	S11711.....	60	S13104.....	71	S21102.....	6
80-946.....	65, 67	S11712.....	61	S13105.....	71	S21103.....	6
80-947.....	65, 67	S11713.....	61	S13106.....	71	S21104.....	6
80-948.....	65, 67	S11714.....	61	S13107.....	71	S21400.....	89
80-949.....	65, 67	S11715.....	61	S13108.....	71	S21401.....	89
90-483.....	83	S11716.....	57	S13109.....	71	S21402.....	89
92-406.....	73	S11717.....	57	S13110.....	71	S21403.....	89
92-410.....	28, 74, 78, 79, 80	S11718.....	57	S13111.....	71	S21404.....	89
S11210.....	48	S11719.....	57	S13112.....	81	S21405.....	89
S11211.....	48	S11900.....	99	S13113.....	81	S21406.....	89
S11212.....	48	S11901.....	99	S13114.....	81	S21407.....	89
S11213.....	48	S11902.....	99	S13115.....	81	S21700.....	17
S11214.....	48	S11903.....	99	S13120.....	75	S21701.....	17
S11215.....	48	S11904.....	99	S13121.....	75	S21702.....	17
S11216.....	48	S11905.....	99	S13122.....	75	S21703.....	17
S11217.....	48	S11906.....	99	S14984.....	31	S21704.....	17
S11600.....	65	S11907.....	99	S14985.....	31	S21705.....	17
S11601.....	65	S11908.....	99	S14986.....	31	S21706.....	17
S11602.....	65	S11909.....	99	S14987.....	31	S21707.....	17
S11603.....	65	S11910.....	95	S14988.....	31	S21708.....	11
S11604.....	65	S11911.....	95	S14989.....	31	S21709.....	11
S11605.....	65	S11912.....	95	S15011.....	32	S21710.....	17
S11606.....	65	S11913.....	95	S15012.....	32	S21711.....	17
S11607.....	65	S11914.....	95	S16400.....	105	S21712.....	7
S11608.....	65	S11915.....	95	S16401.....	105	S21713.....	7
S11609.....	65	S11916.....	95	S16402.....	105	S21714.....	7
S11610.....	65	S11917.....	95	S16403.....	105	S21800.....	31
S11611.....	65	S11920.....	94	S16404.....	105	S21801.....	31
S11612.....	65	S11921.....	94	S16405.....	105	S21802.....	31
S11613.....	65	S11922.....	94	S16406.....	105	S21803.....	31
S11614.....	65	S11923.....	94	S16407.....	105	S21804.....	31
S11615.....	65	S11924.....	93	S16408.....	105	S21805.....	31
S11616.....	65	S11925.....	97	S16409.....	105	S21806.....	31
S11617.....	65	S12100.....	8	S16410.....	105	S21807.....	31
S11618.....	67	S12101.....	8	S16411.....	105	S22430.....	16
S11619.....	67	S12102.....	8	S16412.....	105	S22431.....	16
S11620.....	67	S12103.....	8	S16413.....	105	S22432.....	16
S11621.....	67	S12104.....	8	S16414.....	105	S22433.....	16
S11622.....	67	S12105.....	8	S16415.....	105	S22703.....	19
S11623.....	67	S12106.....	9	S16416.....	105	S22707.....	19
S11624.....	67	S12107.....	9	S16417.....	105	S22712.....	19
S11625.....	67	S12108.....	9	S16418.....	105	S22713.....	19
S11626.....	67	S12109.....	9	S16419.....	105	S23403.....	19
S11627.....	67	S12110.....	9	S16420.....	105	S23407.....	19
S11628.....	67	S12111.....	10	S16421.....	105	S23412.....	19
S11629.....	67	S12112.....	10	S16422.....	105	S23413.....	19
S11630.....	67	S12113.....	10	S16423.....	105	S28491.....	34
S11631.....	67	S12210.....	41	S16424.....	105	S28492.....	34
S11632.....	67	S12211.....	41	S16425.....	105	S28493.....	36
S11633.....	67	S12212.....	41	S16426.....	105	S28547.....	34
S11634.....	67	S12213.....	41	S16427.....	105	S28557.....	20
S11635.....	67	S12214.....	41	S16500.....	103	S28558.....	20
S11700.....	62	S12215.....	41	S16501.....	103	S28560.....	22
S11701.....	62	S12216.....	41	S16502.....	103	S28561.....	22

INDEX

Item #	Page #	Item #	Page #	Item #	Page #	Item #	Page #
S28562	22	S29059	56	S29844	21	S39473	50
S28563	22	S29061	56	S29850	87	S39474	50
S28574	33	S29062	56	S29851	87	S39670	73
S28575	33	S29063	56	S29852	87	S39671	73
S28576	33	S29188	36	S29853	87	S39672	73
S28577	34	S29312	51	S29858	87	S39673	73
S28578	34	S29313	51	S29859	87	S39674	73
S28579	34	S29314	51	S29860	87	S39675	73
S28580	36	S29315	51	S29861	87	S39676	73
S28593	20	S29548	47	S29866	11	S39677	73
S28594	20	S29549	47	S29867	12	S39713	49
S28595	33	S29558	22	S29871	8	S39714	49
S28596	34	S29563	9	S29874	6	S39715	49
S28597	36	S29589	22	S29875	6	S39716	49
S28602	47	S29596	22	S29876	7	S39724	50
S28613	17	S29597	22	S29877	11	S39725	50
S28614	17	S29614	34	S29878	9	S39726	50
S28617	33	S29615	36	S29879	7	S39727	50
S28618	33	S29618	33	S29890	11	S39738	73
S28619	34	S29619	33	S29891	12	S39739	73
S28680	47	S29625	34	S29894	7	S39740	50
S28681	47	S29626	34	S29900	93	S39741	50
S28682	47	S29629	23	S29901	93	S39742	50
S28683	47	S29679	79	S29902	93	S39743	50
S28684	48	S29697	47	S29903	93	S39744	49
S28685	48	S29699	23	S29904	93	S39745	50
S28686	48	S29717	98	S29905	93	S39756	53
S28687	48	S29718	98	S29906	93	S39757	53
S28710	74	S29719	98	S29907	93	S39758	53
S28711	74	S29750	79	S29910	98	S39759	53
S28712	74	S29751	79	S29911	98	S39770	54
S28713	74	S29752	79	S29912	98	S39771	54
S28714	74	S29768	79	S29913	93	S39772	54
S28715	74	S29769	79	S29914	93	S39773	54
S28716	74	S29798	79	S29915	93	S39809	7
S28717	74	S29799	79	S29916	93	S39825	7
S28765	24	S29804	24	S29920	11	S39847	49
S28766	24	S29805	26	S29921	12	S39848	50
S28767	24	S29810	24	S29922	11	S39934	92
S28768	24	S29811	24	S29923	12	S39935	92
S28769	25	S29812	24	S29926	93	S39936	92
S28770	25	S29813	24	S29927	93	S39937	92
S28785	26	S29814	24	S29928	93	S39975	92
S28786	26	S29815	26	S29929	93	S39976	92
S28787	26	S29816	26	S29990	91	S39977	92
S28788	26	S29817	26	S29991	91	S39978	92
S28789	27	S29818	26	S29992	91	S8000	104
S28790	27	S29819	26	S29993	91	S8189	33
S28850	7	S29824	6	S39390	73	S8190	33
S28939	82	S29830	20	S39391	73	S8191	33
S28946	82	S29831	20	S39392	73	S8480	21
S28975	82	S29832	20	S39393	73	S8481	21
S29011	58	S29833	20	S39394	73	S8482	21
S29012	58	S29834	20	S39395	73	S8483	24
S29013	58	S29835	21	S39396	73	S8484	24
S29021	58	S29836	21	S39397	73	S8485	24
S29026	59	S29837	21	S39463	49	S8486	26
S29027	59	S29838	21	S39464	49	S8487	26
S29028	59	S29839	21	S39465	49	S8488	26
S29029	59	S29840	21	S39466	49	S8489	25
S29056	55	S29841	21	S39467	49	S8490	27
S29057	55	S29842	21	S39468	49	S8494	37
S29058	55	S29843	21	S39472	50	S8495	38

INDEX

Item #	Page #	Item #	Page #	Item #	Page #	Item #	Page #
S8496	39	S8644	44	S8929	78	S9380	45
S8497	40	S8646	27	S8930	78	S9381	45
S8498	40	S8647	27	S8931	77	S9382	45
S8499	25	S8648	27	S8932	77	S9383	45
S8530	86	S8649	27	S8937	77	S9384	45
S8531	86	S8650	24	S8938	77	S9385	45
S8532	86	S8651	24	S8950	33	S9386	43
S8533	86	S8652	26	S8951	33	S9387	43
S8534	86	S8653	26	S8952	33	S9388	43
S8535	86	S8676	45	S8953	33	S9389	43
S8536	86	S8677	45	S8976	85	S9400	37
S8537	86	S8678	45	S8987	78	S9401	37
S8538	86	S8679	45	S8988	76	S9402	37
S8539	86	S8688	48	S8989	76	S9403	37
S8542	30	S8689	48	S9004	70	S9404	37
S8543	30	S8690	98	S9030	32	S9405	37
S8544	30	S8691	98	S9031	32	S9406	37
S8545	30	S8692	98	S9032	32	S9407	37
S8550	6	S8693	98	S9033	32	S9408	37
S8551	11	S8694	98	S9064	32	S9409	37
S8552	12	S8695	98	S9065	32	S9410	38
S8553	8	S8696	98	S9067	32	S9411	38
S8554	13	S8697	98	S9068	32	S9412	38
S8555	13	S8698	98	S9150	18	S9413	38
S8556	13	S8705	69	S9151	18	S9414	38
S8559	13	S8706	69	S9152	18	S9415	38
S8564	25	S8707	69	S9153	18	S9416	38
S8565	25	S8708	69	S9154	18	S9417	38
S8566	27	S8725	88	S9155	18	S9418	38
S8567	27	S8726	88	S9156	18	S9419	38
S8568	27	S8727	88	S9157	18	S9420	38
S8570	30	S8728	88	S9158	18	S9421	38
S8571	30	S8729	88	S9159	18	S9422	38
S8572	32	S8735	28	S9160	18	S9423	38
S8573	32	S8736	28	S9161	18	S9424	38
S8581	37	S8737	28	S9162	18	S9425	39
S8582	38	S8738	28	S9163	18	S9426	39
S8583	39	S8745	88	S9164	18	S9427	39
S8584	40	S8746	88	S9165	18	S9428	39
S8585	43	S8747	88	S9166	18	S9429	39
S8588	45	S8748	88	S9167	18	S9430	39
S8589	45	S8749	88	S9168	18	S9431	39
S8598	37	S8755	88	S9169	18	S9432	39
S8600	47	S8756	88	S9170	18	S9433	39
S8601	47	S8757	88	S9171	18	S9434	39
S8603	43	S8758	88	S9172	18	S9435	39
S8604	44	S8759	88	S9173	18	S9436	39
S8605	45	S8778	28	S9174	18	S9437	39
S8609	17	S8779	28	S9175	18	S9438	39
S8610	17	S8839	11	S9176	18	S9439	39
S8611	17	S8840	12	S9177	18	S9440	40
S8612	17	S8841	13	S9200	33	S9441	40
S8615	17	S8849	9	S9201	33	S9442	40
S8616	17	S8851	13	S9202	33	S9443	40
S8635	44	S8890	101, 102	S9203	33	S9444	40
S8636	44	S8891	101, 102	S9280	43	S9445	40
S8637	44	S8892	101, 102	S9281	43	S9446	40
S8638	44	S8893	101, 102	S9282	43	S9447	40
S8639	44	S8914	21	S9283	43	S9448	40
S8640	44	S8915	21	S9316	30	S9449	40
S8641	44	S8916	21	S9317	30	S9450	40
S8642	44	S8920	21	S9318	30	S9451	40
S8643	44	S8928	78	S9319	30	S9452	40

INDEX

Item #	Page #	Item #	Page #	Item #	Page #
S9453	40	S9620	34	S9873	14
S9454	40	S9621	34	S9892	13
S9455	40	S9622	34	S9893	9
S9456	40	S9623	34	S9895	13
S9457	40	S9624	34	S9917	97
S9480	40	S9627	34	S9918	97
S9481	40	S9630	34	S9919	97
S9482	40	S9631	34	S9924	97
S9483	40	S9632	34	S9925	97
S9484	40	S9633	34	S9930	96
S9485	37	S9634	36	S9931	96
S9486	38	S9635	36	S9932	96
S9487	39	S9636	36	S9933	96
S9488	40	S9637	36	S9942	97
S9490	44	S9638	36	S9946	91
S9491	44	S9639	36	S9947	91
S9492	44	S9640	36	S9948	91
S9493	44	S9641	36	S9949	91
S9494	44	S9703	21	S9950	90
S9495	44	S9704	21	S9951	90
S9496	44	S9707	21	S9960	11
S9497	44	S9708	21	S9961	11
S9498	44	S9720	94	S9962	12
S9499	44	S9721	94	S9963	12
S9542	47	S9722	94	S9964	11
S9543	47	S9723	94	S9965	12
S9544	47	S9729	70	S9966	15
S9545	47	S9753	76	S9967	15
S9546	47	S9754	76	S9968	15
S9547	47	S9755	76	S9969	15
S9550	43	S9760	82	S9970	15
S9551	43	S9761	82	S9971	15
S9552	44	S9762	82	S9980	46
S9553	44	S9763	82	S9981	46
S9564	9	S9764	82	S9982	46
S9565	10	S9765	82	S9983	46
S9566	10	S9779	80	S9986	14
S9567	11	S9782	106	S9987	14
S9569	11	S9783	106	S9988	8
S9570	11	S9784	106	S9994	91
S9571	12	S9794	68	S9995	91
S9574	12	S9795	68	S9996	91
S9575	13	S9796	68	S9997	91
S9576	13	S9797	68		
S9577	14	S9806	29		
S9578	14	S9807	13		
S9579	14	S9826	7		
S9580	13	S9827	9		
S9581	13	S9828	9		
S9582	13	S9845	7		
S9583	14	S9846	7		
S9584	14	S9854	87		
S9585	14	S9855	87		
S9588	14	S9856	87		
S9590	20	S9857	87		
S9591	20	S9862	87		
S9592	20	S9863	87		
S9593	21	S9864	87		
S9594	21	S9865	87		
S9595	21	S9868	11		
S9598	52	S9869	12		
S9599	52	S9870	8		
S9616	44	S9872	13		



National Toll-Free:
800-43-SATCO
(800-437-2826)
www.satco.com

Copyright © 2019
Satco Products, Inc
All Rights Reserved.
8/19 SA2000-2
\$10.00



Distribution Centers:

FLORIDA
900 N.W. 159th Dr.
Miami, FL 33169
PH 305-624-2044
FX 305-623-0286

CALIFORNIA
31288 San Benito St.
Hayward, CA 94544
PH 510-487-4822
FX 510-487-8955

WASHINGTON
4710 116th St. S.W.
Mukilteo, WA 98275
PH 425-789-3300
FX 425-789-3310

TEXAS
2000 Valwood Pkwy.
Farmers Branch, TX
75234
PH 972-247-2437
FX 972-247-5408

PUERTO RICO
Campeche St. 23
Julio N. Matos
Industrial Park,
Carolina, PR 00984
PH 787-757-3510
FX 787-757-3540

**Corporate Offices and
Distribution Center:**

NEW YORK
110 Heartland Blvd.
Brentwood, NY 11717
PH 631-243-2022
FX 631-243-2027