



Identification Solutions

Contents



PORTABLE PRINTERS AND LABELS 3



THERMAL TRANSFER PRINTERS 67



THERMAL TRANSFER LABELS 78



LASER LABELS 125



INK JET LABELS 141

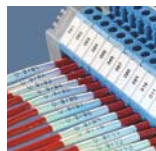

DOT MATRIX LABELS 150



SOFTWARE, SERVICES AND DATA COLLECTION 199



CUSTOM AND SPECIALTY PRODUCTS 222



PRE-PRINTED WIRE MARKERS 248

INDEX / REFERENCE 269

Portable Printers and Labels



Selecting Your Printers	4
ID Pal™ Labeling Tool	6
ID Pal Label Cartridges	7
IDXPERT™ Handheld Labeler	8
Label Index by Part Number	9
Electrical I.D. Labels	10
Voice / Data Communications I.D. Labels	12
MRO / Facility / Safety Labels	14
TLS 2200® / TLS PC Link™ Thermal Labeling System	16
Label Index by Part Number	21
Label Index by Size	24
Labels by Application	
Wire and Cable Marking	35
Data Communications Equipment and Cabling Labels	38
General and Industrial Application Labels	41
Security Identification Labels	41
Circuit Board and Component Identification	46
HandiMark® Label Maker	50
Brady LS2000 / I.D. Pro® Plus / BradyMarker XC Plus Supplies	
Label Index by Part Number	54
Labels by Application	56
Wire and Cable Marking	56
General and Industrial Application Labels	56
Circuit Board and Component Identification	56

Selecting Your Printers

ID Pal™ Labeling Tool	Lab Pal™ Labeling Tool	IDXPERT™ Handheld Labeler
 <p>This hand-held labeling tool offers electrical and data communication installers an unbeatable combination.</p> <p style="text-align: center;">Page 6</p>	 <p>The LAB PAL label printer is portable, easy-to-use and makes identifying your samples more quick and efficient.</p>	 <p>The IDXPERT is the first handheld cartridge based labeling system that can print die-cut labels, self-laminating labels and sleeves as well as continuous tapes.</p> <p style="text-align: center;">Page 8</p>

FEATURES			
Keyboard	ABC	ABC	ABC, QWERTY
Print Technology	Thermal Transfer 180 dpi	Thermal Transfer 180 dpi	Thermal Transfer 300 dpi
Weight	1.2 lbs.	1.2 lbs.	2.4 lbs
Label Width	0.750"	0.750"	1.500"
Text sizes	5 (7 to 28 point font)	5 (7 to 28 point font)	11 (7 to 128 point font)
Roll length (max)	21 feet	21 feet	30 feet
Consumables	Continuous 15 stock parts	Continuous 15 stock parts	Continuous/Die cut 89 stock label parts
PC Connectivity	None	None	For firmware upgrade
Memory	Last label	Last label	10 labels
Power Supply	6 AAs AC Power (optional)	6 AAs AC Power (optional)	6 AAs AC Power (optional)
Applications	Wire and Cable Marking Bins and Storage ID General Marking	Basic Laboratory Identification Slide Identification Vial Identification Well Plate Identification Tube Identification	Wire and Cable Marking (Wrap around, Self Laminating, Permasleeve) Data Communications Bins and Storage ID General and Industrial Marking

OTHER BRADY THERMAL TRANSFER PRINTING SOLUTIONS PRODUCTS



1244 / 1344

- ▶ Small, compact and economical desktop printing
- ▶ 203 or 300 dpi with a 4.100" print width
- ▶ For small to medium volume application

Page 73



MVP Plus

- ▶ Best value in an industrial thermal transfer printer
- ▶ 203 or 300 dpi with excellent print quality print width
- ▶ durable, die cast aluminum frame
- ▶ 12 hours/day, 5 days a week applications

Page 71



GlobalMark™ Industrial Label Maker

- ▶ Industrial label maker
- ▶ Quick and easy - color touch screen interface
- ▶ Multicolor spot printing
- ▶ Cuts characters and shapes

Page 75

LABXPERT™ Laboratory Labeling System	HandiMark® Portable Label Maker	TLS 2200® Thermal Labeling System	TLS PC Link™ Thermal Labeling System
 <p>Developed specifically for the lab market, the LABXPERT offers formats and materials specifically for that market.</p>	 <p>Specifically designed for industrial use, it's lightweight, rugged construction allows you to create custom labels whenever and wherever you need them.</p>	 <p>The TLS 2200 system offers the light weight of a hand-held printer, while providing capabilities such as thermal transfer printing, bar coding and multiple material configurations.</p>	 <p>The TLS PC Link Thermal Labeling System offers a rugged, small and lightweight desktop/portable solution. The printer provides capabilities such as thermal transfer printing, bar coding, and multiple material configurations.</p>
Page 50	Page 16	Page 17	
QWERTY	ABC	ABC	ABC
Thermal Transfer 300 dpi	Thermal Transfer 203 dpi	Thermal Transfer 203 dpi	Thermal Transfer 203 dpi
2.4 lbs	2.75 lbs.	2.75 lbs.	2.75 lbs.
1.500"	2.000"	2.000"	2.000"
11 (7 to 128 point font) 30 feet	19 (4 to 72 point) 50 feet/ 500 feet bulk	19 (4 to 72 point) 50 feet/ 500 feet bulk	19 (4 to 72 point) 50 feet/ 500 feet bulk
Continuous/Die cut 89 stock label parts	Continuous/Die cut Bulk 65 stock parts/custom	Continuous/Die cut Bulk Over 350 stock parts/custom	Continuous/Die cut Bulk Over 350 stock parts/custom
Firmware Peripheral printing 10 labels	Firmware Peripheral printing 10,000 characters 20+ individual labels	Firmware Peripheral printing 21,000 characters 10 label lists 10+ labels/list	Firmware Peripheral printing None
6 AAs AC Power (optional)	Rechargeable Battery AC Power (optional)	Rechargeable Battery AC Power (optional)	Rechargeable Battery AC Power (optional)
Laboratory Identification Slide Tracking Vial Identification Bar Coded Identification	Panel and Switch ID Junction Boxes Instrumentation ID Gauges Pipe Markers Bins and Storage ID Asset ID Warning Labels	Wire and Cable Marking (Wrap around, Self Laminating, Permasleeve) Data Communications Bins and Storage ID General and Industrial Marking Circuit Board and Component Identification Laboratory Identification Labels	Wire and Cable Marking (Wrap around, Self Laminating, Permasleeve) Data Communications Bins and Storage ID General and Industrial Marking Circuit Board and Component Identification Laboratory Identification Labels



BradySoft™ Label Design Software, MarkWare™ Facility Identification Software, IdentiLab™ Laboratory Labeling Software

- ▶ Windows based software
- ▶ Powerful, programmable and easy to use
- ▶ Print your labels in minutes

BradySoft - Page 202
MarkWare - Page 204
IdentiLab - Page 208



Code Reader 2.0

- ▶ 2D and linear bar code scanner
- ▶ Lightweight, ergonomic and portable
- ▶ Vial identification, component identification and work-in-process tracking applications

Page 220

ID PRO® Plus, LS2000, BradyMarker™ XC Plus

Materials, ribbons and accessories are still available.

Page 52

ID PAL™ Labeling Tool



The ID PAL Labeling Tool is an affordable, easy-to-use, portable thermal transfer printer designed for the field, not the office. The rugged design has been tested to withstand harsh environments and a tough four foot drop test to concrete.

The ID PAL printer uses Brady's high performance labeling materials. The labels stay in place on your toughest surfaces, from wire and cable to highly textured plastic. As a result, it eliminates the confusion caused by faded, smeared or poorly written labels, or labels that fall off leaving unidentified wires.

- ▶ Prints Brady-quality labels
- ▶ Easy-to-peel labels
- ▶ Fits great in your hand
- ▶ Job-tough construction
- ▶ Easy-to-see bright red color
- ▶ Quick, top-load, drop-in cartridge
- ▶ Built-in industrial cutter
- ▶ Intuitive keypad with electrical and datacomm symbols
- ▶ Special wire marking mode with 10 preset lengths
- ▶ Prints upper and lower case characters
- ▶ Multiple line printing and serialization
- ▶ Automatic shut-off
- ▶ Six month warranty (12 months if registered)

ID PAL Labeling Tool

Part Number	Description
IDPAL	ID PAL Labeling Tool - North America*
IDPAL-INTL	ID PAL Labeling Tool - International*

* Includes full label cartridge

▶ ACCESSORIES

Part Number	Description
IDPAL-AC	ID PAL AC Adapter - North America
IDPAL-ACEUR	ID PAL AC Adapter - Europe
CORD-NA	ID PAL Replacement Power Cord - North America
CORD-EUR	ID PAL Replacement Power Cord - Europe
CORD-UK	ID PAL Replacement Power Cord - UK
CORD-JAPAN	ID PAL Replacement Power Cord - Japan
IDPAL-IG	ID PAL Impact Guards
IDPAL-HC	ID PAL Hardside Carrying Case

▶ SPECIFICATIONS

Print method	Thermal transfer (non smearing)
Weight	1.2 lbs. (0.55 kg) with batteries and tape cartridge
Dimensions (L x W x H)	9,000 in x 4,500 in x 2,500 in (228.60 mm x 114.30 mm x 63.50 mm)
Power source	6 AA batteries print over 3500 1,000 in (25.40 mm) labels
Operating temperature	40° - 120° F (4° - 49° C)
Agency approvals	FCC Class A approved

▶ SYMBOLS

Press **FUNCTION** + Character

Character	Symbol	Character	Symbol	Character	Symbol
A	!	K	'	U	~
B	@	L	.	V	²
C	#	M	“	W	β
D	\$	N	/	X	≠
E	%	O	\	4	¢
F	&	P	°	5	€
G	*	Q	-	6	⊕
H	(R	±	7	-
I)	S	'	8	+
J	:	T	Ω	9	=

Prints as -

▶ FIVE FONT SIZES

7	POINT
10	POINT
14	POINT
20	POINT
28	POINT

▶ LABELS FOR MULTIPLE APPLICATIONS

Choose from Three Label Types

Wire

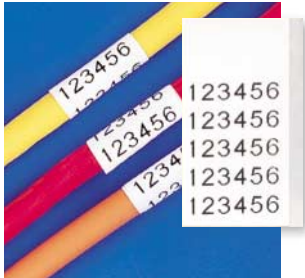

- ▶ Built-in leader for wrapping wire/cable
- ▶ Choose from 10 pre-programmed lengths: 0.750 in, 1.000 in, 1.200 in, 1.500 in, 2.000 in, 2.500 in, 3.000 in, 4.000 in, 5.000 in, 6.000 in

Banner



- ▶ Prints multiple lines of text

General



- ▶ Prints up to four lines of text



▶ EASY-PEEL LABEL

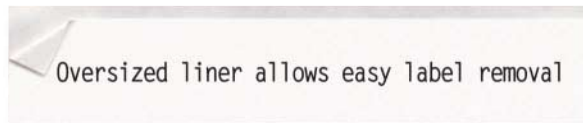

▶ LESS LABEL WASTE RESULTS IN MORE LABELS PER CARTRIDGE

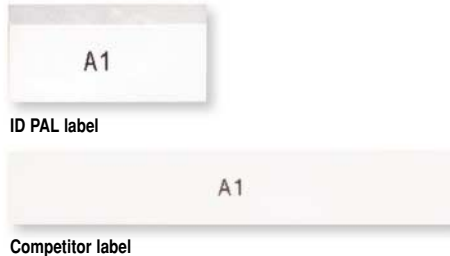

LABEL CARTRIDGE SELECTION CHART

Application	Material/Color	Max. Service Temperature	Part Number 0.375" (9.53 mm)	Part Number 0.500" (12.70 mm)	Part Number 0.750" (19.05 mm)	Roll Length Feet (m)	Agency Approvals
	Nylon Cloth B-499 / Black on White	194 (90) 30 days	PAL-375-499	PAL-500-499	PAL-750-499	19' (5.79 m)	
	Vinyl B-439 / Black on White	104 (40) 30 days	PAL-375-439	PAL-500-439	PAL-750-439	21' (6.40 m)	
	Vinyl B-439 / Black on Yellow	104 (40) 30 days	PAL-375-439-YL	PAL-500-439-YL	PAL-750-439-YL	21' (6.40 m)	
	Vinyl B-439 / Black on Red	104 (40) 30 days	PAL-375-439-RD	PAL-500-439-RD	PAL-750-439-RD	21' (6.40 m)	
	Vinyl B-439 / Black on Orange	104 (40) 30 days	PAL-375-439-OR	PAL-500-439-OR	PAL-750-439-OR	21' (6.40 m)	
	Vinyl B-439 / Black on Green	104 (40) 30 days	PAL-375-439-GR	PAL-500-439-GR	PAL-750-439-GR	21' (6.40 m)	
	Vinyl B-439 / Black on Blue	104 (40) 30 days	PAL-375-439-BL	PAL-500-439-BL	PAL-750-439-BL	21' (6.40 m)	
	Polyester B-430 / Black on Clear	212 (100) 30 days	PAL-375-430	PAL-500-430	PAL-750-430	21' (6.40 m)	
	Polyester B-423 / Black on White	248 (120) 30 days	PAL-375-423	PAL-500-423	PAL-750-423	21' (6.40 m)	

Plus... each cartridge comes preloaded with its own application-specific ribbon.

Application Key

- Smooth/Flat Surface
- Wire/Cable/Curved Surface
- Textured Surface
- Highly Textured Surface

IDXPERT™ Handheld Labeler



Keyboard Layout

ABC Layout

Two printer keyboard layouts. Identical functionality and supplies.

IDXPERT Labeling System

Part Number	Description
XPERT-ABC	IDXPERT Printer – ABC Layout*
XPERT-KEY	IDXPERT Printer – KEYBOARD Layout*

* Printer ships with: Hard carry case, 1,500' x 30' Continuous Tape, PC Cable for upgrades only, Product CD with Tutorials.

► ACCESSORIES

IDXPERT Labeling System Accessories

Part Number	Description
XPERT-AC	AC Adapter (for ABC or KEY printers)
PCCABLE-1	PC Cable for Upgrades Only (for ABC or KEY)
PCK-4	Cleaning Kit
XPERT-HC-ABC	Spare Hard Case for ABC Layout Printer
XPERT-HC-KEY	Spare Hard Case for KEYBOARD Layout Printer

► SPECIFICATIONS

Print method	Thermal transfer (non smearing)
Weight	2.4 lbs ABC / 2.15 lbs keyboard
Dimensions (L x W x H)	Keyboard layout: 9.500" x 3.500" x 7.500" (241.30 mm x 88.90 mm x 190.50 mm) ABC layout: 5.000" x 3.750" x 11.500" (127.00 mm x 95.25 mm x 292.10 mm)
Power source	6 AAs or optional AC adapter
Operating temperature	40 - 120°F (4° - 49°C)
Agency approvals	FCC Class A Approved

More Options. More Brains. More Brawn. Less Waste.

Here is the newest 300 dpi thermal, handheld labeling system that has everything it takes to make you an Identification Expert! Label patch panels, outlet faceplates and cables. Identify racks, bays, frames, public network and data centers all with one versatile tool. The IDXPERT is the first handheld cartridge based labeling system that can print die-cut labels, self-laminating labels and sleeves as well as continuous tapes... You name it IDXPERT prints it!

Choose from two keyboard layouts, then select from a wide range of label materials engineered just for your application. That includes wire and cable markers; panel, rack and frame ID; facilities labels; and specialty labels for labs and work spaces.

More Types of Labels

- Colored continuous tapes for pipe markers, equipment ID and safety warnings
- PermaSleeve™ wire marker sleeves
- Self-laminating wire and cable markers
- Terminal block markers
- Patch panel markers
- Face plate and outlet markers
- General-purpose die-cut labels

More Sizes

- Prints from 0.06" up to 1.25" characters on label stock up to 1.5" wide

More Symbols

- Code 39 bar codes
- 82 Symbols including electrical, voice/data, safety and protection, warning, and machine and operational

More Brains

- Drop Lock & Go™ Smart Cartridges™ are fast to install and remove
- Electronically pre-calibrated to orient the label just the way you need it with no special keys to press
- Memory to store frequently used set-ups
- Ergonomic design really fits your hand
- 300 dpi thermal transfer printing stays crisp and bright

More Brawn

- Users of dot-matrix printers will benefit from crisp, non-smearing thermal transfer print quality, faster print speed and more text-editing and symbols capabilities
- Larger, more informative display
- Rugged, drop-tested construction

Less Waste

- Edge-to-edge printing on continuous tapes so you don't pay for unused label material
- Die-cut labels are pre-cut to the size you need—no waste
- Runs on 6 AAs or optional AC adapter

IDXPERT™ Index by Part Number

Part Number	Size Inch (mm)	Specifications on Page	Part Number	Size Inch (mm)	Specifications on Page	Part Number	Size Inch (mm)	Specifications on Page
X-7-422	0.500 (12.70) x 0.500 (12.70)	12, 15	XC-500-580-GN-WT	30 ft. (9.14 m) x 0.500 (12.70)	14	XPS-187-CONT-YL-BK	8 ft. (2.44 m) x 0.335 (8.50)	11
X-7-498	0.500 (12.70) x 0.500 (12.70)	10	XC-500-580-OR-BK	30 ft. (9.14 m) x 0.500 (12.70)	14	XPS-250-1	1.015 (25.78) x 0.439 (11.15)	11
X-11-498	0.500 (12.70) x 0.750 (19.05)	10	XC-500-580-RD-WT	30 ft. (9.14 m) x 0.500 (12.70)	14	XPS-250-CONT	8 ft. (2.44 m) x 0.439 (11.15)	11
X-11-499	0.750 (19.05) x 0.500 (12.70)	12, 15	XC-500-580-WT-BK	30 ft. (9.14 m) x 0.500 (12.70)	14	XPS-250-CONT-YL-BK	8 ft. (2.44 m) x 0.439 (11.15)	11
X-17-422	1.000 (25.40) x 0.500 (12.70)	12-13	XC-500-580-WT-RD	30 ft. (9.14 m) x 0.500 (12.70)	14	XPS-375-1	1.015 (25.78) x 0.645 (16.38)	11
X-17-428-SV-BK	1.000 (25.40) x 0.500 (12.70)	12, 15	XC-500-580-YL-BK	30 ft. (9.14 m) x 0.500 (12.70)	13-15	XPS-375-CONT	8 ft. (2.44 m) x 0.645 (16.38)	11
X-17-483	1.000 (25.40) x 0.500 (12.70)	13, 15	XC-1000-422	30 ft. (9.14 m) x 1.000 (25.40)	12-13	XSL-11-427	0.500 (12.70) x 0.750 (19.05)	10
X-18-498	0.750 (19.05) x 1.000 (25.40)	10	XC-1000-580-BL-WT	30 ft. (9.14 m) x 1.000 (25.40)	14	XSL-17-427	0.500 (12.70) x 1.000 (25.40)	10
X-19-422	1.000 (25.40) x 1.000 (25.40)	12-13, 15	XC-1000-580-CL-BK	30 ft. (9.14 m) x 1.000 (25.40)	14	XSL-18-427	0.750 (19.05) x 1.000 (25.40)	10
X-19-498	1.000 (25.40) x 1.000 (25.40)	10	XC-1000-580-GN-WT	30 ft. (9.14 m) x 1.000 (25.40)	14	XSL-19-427	1.000 (25.40) x 1.000 (25.40)	10, 13
X-20-428-SV-BK	2.000 (50.80) x 1.000 (25.40)	12, 15	XC-1000-580-OR-BK	30 ft. (9.14 m) x 1.000 (25.40)	14	XSL-21-427	1.000 (25.40) x 2.500 (63.50)	10, 13
X-20-483	2.000 (50.80) x 1.000 (25.40)	13, 15	XC-1000-580-RD-WT	30 ft. (9.14 m) x 1.000 (25.40)	14	XSL-21-427-YL-BK	1.000 (25.40) x 2.500 (63.50)	10, 13
X-24-428-SVBB-BK	1.130 (28.70) x 0.500 (12.70)	12, 15	XC-1000-580-WT-BK	30 ft. (9.14 m) x 1.000 (25.40)	14	XSL-23-427	1.000 (25.40) x 4.000 (101.60)	10, 13
X-29-422	1.500 (38.10) x 0.500 (12.70)	12-13	XC-1000-580-WT-RD	30 ft. (9.14 m) x 1.000 (25.40)	14	XSL-23-427-YL-BK	1.000 (25.40) x 4.000 (101.60)	10, 13
X-29-428-SV-BK	1.500 (38.10) x 0.500 (12.70)	12, 15	XC-1000-580-YL-BK	30 ft. (9.14 m) x 1.000 (25.40)	13-15	XSL-29-427	0.500 (12.70) x 1.500 (38.10)	10, 13
X-30-422	1.500 (38.10) x 0.750 (19.05)	12-13, 15	XC-1500-580-BL-WT	30 ft. (9.14 m) x 1.500 (38.10)	14	XSL-30-427	0.750 (19.05) x 1.500 (38.10)	10, 13
X-61-483	2.000 (50.80) x 0.500 (12.70)	13, 15	XC-1500-580-CL-BK	30 ft. (9.14 m) x 1.500 (38.10)	14	XSL-31-427	1.000 (25.40) x 1.500 (38.10)	10, 13
X-82-499	0.375 dia x 9.53 dia	15	XC-1500-580-GN-WT	30 ft. (9.14 m) x 1.500 (38.10)	14	XSL-31-427-YL-BK	1.000 (25.40) x 1.500 (38.10)	10, 13
X-83-499	0.500 dia x 12.70 dia	15	XC-1500-580-OR-BK	30 ft. (9.14 m) x 1.500 (38.10)	14	XSL-32-427	1.500 (38.10) x 1.500 (38.10)	10, 13
X-84-499	0.900 (22.86) x 0.500 (12.70)	12, 15	XC-1500-580-RD-WT	30 ft. (9.14 m) x 1.500 (38.10)	14	XSL-33-427	1.500 (38.10) x 4.000 (101.60)	10, 13
X-103-498	1.000 (25.40) x 1.250 (31.75)	10	XC-1500-580-WT-BK	30 ft. (9.14 m) x 1.500 (38.10)	14	XSL-34-427	1.500 (38.10) x 6.000 (152.40)	10, 13
XC-240-498	0.240 (6.10) x 20 ft. (6.09 m)	11	XC-1500-580-WT-RD	30 ft. (9.14 m) x 1.500 (38.10)	14	XSL-96-427	1.000 (25.40) x 0.750 (19.05)	10
XC-318-498	0.318 (8.07) x 20 ft. (6.09 m)	11	XC-1500-580-YL-BK	30 ft. (9.14 m) x 1.500 (38.10)	13-15	XSL-102-427	0.500 (12.70) x 1.250 (31.75)	10, 13
XC-375-422	30 ft. (9.14 m) x 0.375 (9.53)	12	XPS-125-1	1.015 (25.78) x 0.235 (5.96)	11	XSL-103-427	1.000 (25.40) x 1.250 (31.75)	10, 13
XC-375-498	0.375 (9.53) x 26 ft. (7.90 m)	11	XPS-125-CONT	8 ft. (2.44 m) x 0.235 (5.96)	11	XSL-115-427	1.500 (38.10) x 1.250 (31.75)	10, 13
XC-500-422	30 ft. (9.14 m) x 0.500 (12.70)	12	XPS-125-CONT-YL-BK	8 ft. (2.44 m) x 0.235 (5.96)	11	XSL-116-427	1.500 (38.10) x 2.500 (63.50)	13
XC-500-580-BL-WT	30 ft. (9.14 m) x 0.500 (12.70)	14	XPS-187-1	1.015 (25.78) x 0.335 (8.50)	11			
XC-500-580-CL-BK	30 ft. (9.14 m) x 0.500 (12.70)	14	XPS-187-CONT	8 ft. (2.44 m) x 0.335 (8.50)	11			

PORTABLE PRINTERS AND LABELS IDXPERT INDEX BY PART NUMBER

IDXPERT™ Electrical I.D. Labels

▶ WIRE AND CABLE MARKERS — ADHESIVE WRAP AROUND

Durable vinyl cloth wrap-around wire & cable marker. Stays in place, but can be removed cleanly and reapplied if necessary. Printer automatically "multiple repeats" your text to create a wrap-around marker with 360° visibility of legend.

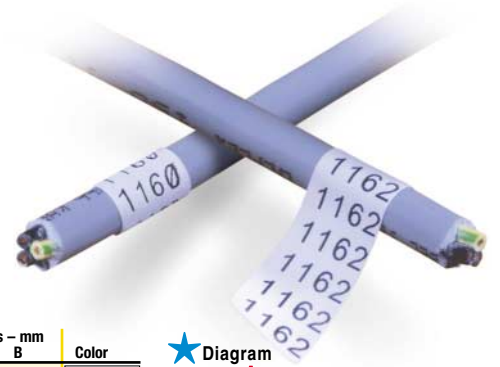

▶ **B-498 Vinyl Cloth** material. Temp Range: -40°F to 175°F (-40°C to 70°C).

Wire Gauge*	Max. Wire Diameter	Diagram	Part Number	Labels per Cartridge	Dimensions – inches		Dimensions – mm		Color
					A	B	A	B	
22-16 Gauge	0.110" max dia (2.80 mm)	★	X-7-498	300	0.500	0.500	12.70	12.70	BK on WT
16-10 Gauge	0.160" max dia (4.00 mm)	★	X-11-498	275	0.500	0.750	12.70	19.05	BK on WT
12-10 Gauge	0.210" max dia (5.00 mm)	★	X-19-498	200	1.000	1.000	25.40	25.40	BK on WT
12-10 Gauge	0.210" max dia (5.00 mm)	★	X-18-498	225	0.750	1.000	19.05	25.40	BK on WT
10-4 Gauge	0.270" max dia (7.00 mm)	★	X-103-498	200	1.000	1.250	25.40	31.75	BK on WT

*Approx based on AWG for THHN wire

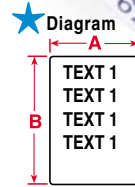

▶ WIRE AND CABLE MARKERS — SELF LAMINATING

This wire and cable marker's protected printing offers superior chemical and abrasion resistance. Marker features a non-printed clear area which wraps around and overlaminates the printed text. Printer automatically "multiple repeats" your text in the white print area.



▶ **B-427 Vinyl Self-Laminating** material, resistant to water, oil, solvents and abrasion. Temp range: -94°F to 158°F (-70°C to 70°C). UL recognized.

Wire Gauge*	Max. Wire Diameter	Diagram	Part Number	Labels per Cartridge	Dimensions – inches			Dimensions – mm			Color
					A	B	C	A	B	C	
16-10 Gauge	0.160" max dia (4.00 mm)	▶	XSL-11-427	500	0.500	0.750	0.375	12.70	19.05	9.53	BK on WT
16-10 Gauge	0.160" max dia (4.00 mm)	▶	XSL-96-427	250	1.000	0.750	0.375	25.40	19.05	9.53	BK on WT
12-10 Gauge	0.210" max dia (5.00 mm)	▶	XSL-17-427	500	0.500	1.000	0.375	12.70	25.40	9.53	BK on WT
12-10 Gauge	0.210" max dia (5.00 mm)	▶	XSL-18-427	250	0.750	1.000	0.375	19.05	25.40	9.53	BK on WT
12-10 Gauge	0.210" max dia (5.00 mm)	▶	XSL-19-427	250	1.000	1.000	0.375	25.40	25.40	9.53	BK on WT
10-4 Gauge	0.270" max dia (7.00 mm)	▶	XSL-102-427	250	0.500	1.250	0.375	12.70	31.75	9.53	BK on WT
10-4 Gauge	0.270" max dia (7.00 mm)	▶	XSL-103-427	250	1.000	1.250	0.500	25.40	31.75	12.70	BK on WT
10-4 Gauge	0.270" max dia (7.00 mm)	▶	XSL-115-427	250	1.500	1.250	0.500	38.10	31.75	12.70	BK on WT
10-4 Gauge	0.320" max dia (8.00 mm)	▶	XSL-29-427	450	0.500	1.500	0.500	12.70	38.10	12.70	BK on WT
10-4 Gauge	0.320" max dia (8.00 mm)	▶	XSL-30-427	250	0.750	1.500	0.500	19.05	38.10	12.70	BK on WT
10-4 Gauge	0.320" max dia (8.00 mm)	▶	XSL-31-427	250	1.000	1.500	0.500	25.40	38.10	12.70	BK on WT
10-4 Gauge	0.320" max dia (8.00 mm)	▶	XSL-31-427-YL-BK	250	1.000	1.500	0.500	25.40	38.10	12.70	BK on YL
10-4 Gauge	0.320" max dia (8.00 mm)	▶	XSL-32-427	225	1.500	1.500	0.500	38.10	38.10	12.70	BK on WT
3 Gauge-2/0	0.530" max dia (14.00 mm)	▶	XSL-21-427	100	1.000	2.500	0.750	25.40	63.50	19.05	BK on WT
3 Gauge-2/0	0.530" max dia (14.00 mm)	▶	XSL-21-427-YL-BK	100	1.000	2.500	0.750	25.40	63.50	19.05	BK on YL
3 Gauge-2/0	0.530" max dia (14.00 mm)	▶	XSL-116-427	100	1.500	2.500	0.750	38.10	63.50	19.05	BK on WT
3/0-400 kcmil	0.850" max dia (22.00 mm)	▶	XSL-23-427	85	1.000	4.000	1.000	25.40	101.60	25.40	BK on WT
3/0-400 kcmil	0.850" max dia (22.00mm)	▶	XSL-23-427-YL-BK	100	1.000	4.000	1.000	25.40	101.60	25.40	BK on YL
3/0-400 kcmil	0.850" max dia (22.00 mm)	▶	XSL-33-427	85	1.500	4.000	1.000	38.10	101.60	25.40	BK on WT
500-900 kcmil	1.300" max dia (33.00 mm)	▶	XSL-34-427	50	1.500	6.000	1.500	38.10	152.40	38.10	BK on WT

*Approx based on AWG for THHN wire

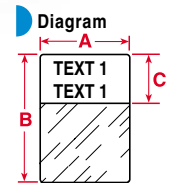

► WIRE AND CABLE MARKERS — PERMASLEEVE™ SLEEVES

These full circle heat-shrink sleeves are the ultimate in marker durability, permanence and aesthetic appearance. Fast-shrink rate saves time & cost during installation. Available as individual 1-inch long markers or cut-to-length continuous supply.

► B-342 Heat Shrink Polyolefin material, 3-to-1 shrink ratio, self-extinguishing, meets material & physical properties requirements of MIL-DTL-23053/5C class 1, MIL-M-81531, MIL-STD-202F, method 215 and UL 224. Temp Range: -67°F to 275°F (-55°C to 135°C).



Wire Gauge*	Wire Diameter Range	Diagram	Part Number	Labels per Cartridge	Dimensions – inches		Dimensions – mm		Color
					A	B	A	B	
1.015" MARKER LENGTH									
22-16 Gauge	0.046 - 0.110 dia (1.20 - 2.80 mm)		XPS-125-1	100	1.015	0.235	25.78	5.96	BK on WT
18-12 Gauge	0.062 - 0.150 dia (1.60 - 3.80 mm)		XPS-187-1	100	1.015	0.335	25.78	8.50	BK on WT
16-10 Gauge	0.094 - 0.215 dia (2.40 - 5.50 mm)		XPS-250-1	100	1.015	0.439	25.78	11.15	BK on WT
12-6 Gauge	0.125 - 0.320 dia (3.20 - 8.10 mm)		XPS-375-1	100	1.015	0.645	25.78	16.38	BK on WT
CONTINUOUS (CUT TO LENGTH)									
22-16 Gauge	0.046 - 0.110 dia (1.20 - 2.80 mm)		XPS-125-CONT	1 roll (cont.)	8 ft.	0.235	2.44 m	5.96	BK on WT
22-16 Gauge	0.046 - 0.110 dia (1.20 - 2.80 mm)		XPS-125-CONT-YL-BK	1 roll (cont.)	8 ft.	0.235	2.44 m	5.96	BK on YL
18-12 Gauge	0.062 - 0.150 dia (1.60 - 3.80 mm)		XPS-187-CONT	1 roll (cont.)	8 ft.	0.335	2.44 m	8.50	BK on WT
18-12 Gauge	0.062 - 0.150 dia (1.60 - 3.80 mm)		XPS-187-CONT-YL-BK	1 roll (cont.)	8 ft.	0.335	2.44 m	8.50	BK on YL
16-10 Gauge	0.094 - 0.215 dia (2.40 - 5.50 mm)		XPS-250-CONT	1 roll (cont.)	8 ft.	0.439	2.44 m	11.15	BK on WT
16-10 Gauge	0.094 - 0.215 dia (2.40 - 5.50 mm)		XPS-250-CONT-YL-BK	1 roll (cont.)	8 ft.	0.439	2.44 m	11.15	BK on YL
12-6 Gauge	0.125 - 0.320 dia (3.20 - 8.10 mm)		XPS-375-CONT	1 roll (cont.)	8 ft.	0.645	2.44 m	16.38	BK on WT

*Approx based on NEC for THHN wire.



► TERMINAL BLOCK MARKERS

These specially-designed narrow-width markers automatically set to fixed spacing and separation between legends and rotate to top-down orientation for perfect alignment on terminal blocks. Printer can auto-serialize to save additional time.

► B-498 Vinyl Cloth material. Temp Range: -40°F to 175°F (-40°C to 70°C).

Width of Strip	Diagram	Part Number	Labels per Cartridge	Dimensions – inches		Dimensions – mm		Color
				A	B	A	B	
0.240" wide		XC-240-498	1 roll (cont.)	0.240	20 ft.	6.10	6.09 m	BK on WT
0.318 wide		XC-318-498	1 roll (cont.)	0.318	20 ft.	8.07	6.09 m	BK on WT
0.375" wide		XC-375-498	1 roll (cont.)	0.375	20 ft.	9.53	6.09 m	BK on WT

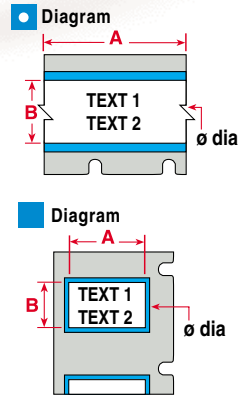
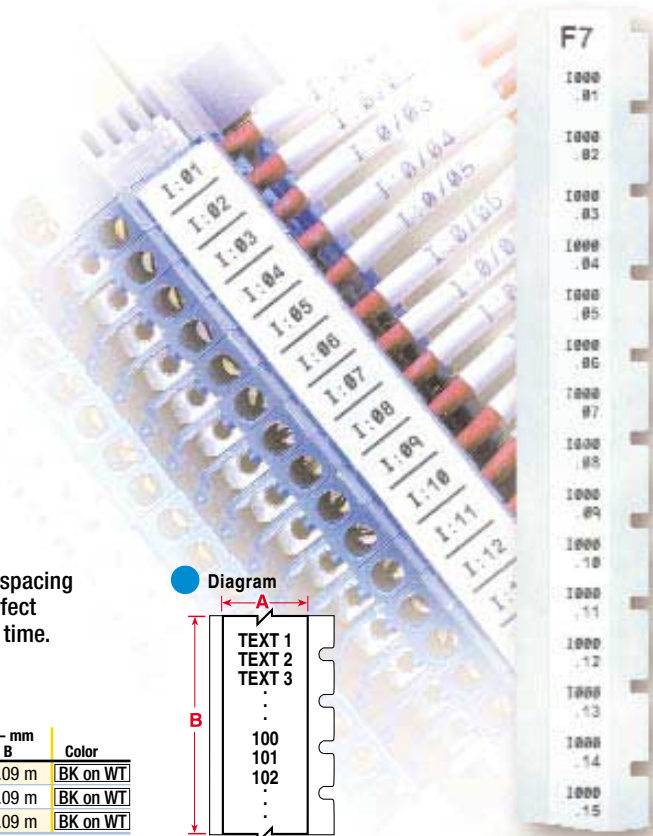
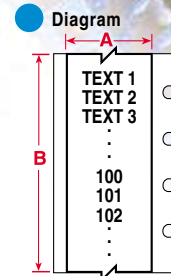

PORTABLE PRINTERS AND LABELS IDXPERT ELECTRICAL I.D. LABELS

IDXPERT™ Electrical I.D. Labels

AUTOMATION AND ELECTRICAL COMPONENT MARKERS

Various sizes & label types for marking relays, solenoids, switches, drive motors or just about any component you have to label.

- ▶ **B-499 Nylon Cloth** material, permanent adhesive. Pliable for rough or smooth surfaces. Temp Range: -94°F to 194°F (-70°C to 90°C). UL recognized.
- ▶ **B-428 Metallized Polyester** material, permanent adhesive, silver finish. Temp Range: -40°F to 176°F (-40°C to 80°C). UL recognized.
- ▶ **B-422 Gloss Polyester** material, permanent adhesive. For smooth surfaces. Temp Range: -40°F to 212°F (-40°C to 100°C). UL recognized.



Material Notes	Diagram	Part Number	Labels per Cartridge	Dimensions – inches		Dimensions – mm		Color
				A	B	A	B	
General Purpose Nylon Cloth	▲	X-11-499	275	0.750	0.500	19.05	12.70	BK on WT
General Purpose Nylon Cloth	▲	X-84-499	350	0.900	0.500	22.86	12.70	BK on WT
Metallized Polyester	▲	X-17-428-SV-BK	450	1.000	0.500	25.40	12.70	BK on SV
Metallized Polyester (Black Border)	▲	X-24-428-SVBB-BK	450	1.130	0.500	28.70	12.70	BK on SV
Metallized Polyester	▲	X-29-428-SV-BK	450	1.500	0.500	38.10	12.70	BK on SV
Metallized Polyester	▲	X-20-428-SV-BK	100	2.000	1.000	50.80	25.40	BK on SV
Gloss Polyester	▲	X-19-422	250	1.000	1.000	25.40	25.40	BK on WT
Gloss Polyester	▲	X-30-422	250	1.500	0.750	38.10	19.05	BK on WT
Gloss Polyester	⊙	XC-1000-422	1 roll (cont.)	30 ft.	1.000	9.14 m	25.40	BK on WT

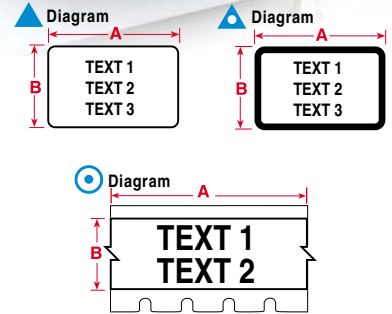

IDXPERT™ Voice / Data Communications I.D. Labels

PATCH PANEL, OUTLET AND FACEPLATE MARKERS

Label patch panels with continuous supplies that set automatically to user-defined fixed spacing intervals. Die cut parts available for marking individual ports and wall faceplates.

- ▶ **B-422 Gloss Polyester** material, permanent adhesive. Temp Range: -40°F to 212°F (-40°C to 100°C). UL recognized.

Application	Diagram	Part Number	Labels per Cartridge	Dimensions – inches		Dimensions – mm		Color
				A	B	A	B	
Label Each Port	▲	X-7-422	350	0.500	0.500	12.70	12.70	BK on WT
Label Multiple Ports on Cont. Tape	⊙	XC-375-422	1 roll (cont.)	30 ft.	0.375	9.14 m	9.53	BK on WT
Label Multiple Ports on Cont. Tape	⊙	XC-500-422	1 roll (cont.)	30 ft.	0.500	9.14 m	12.70	BK on WT
Label Faceplate	▲	X-17-422	500	1.000	0.500	25.40	12.70	BK on WT
Label Faceplate	▲	X-29-422	500	1.500	0.500	38.10	12.70	BK on WT

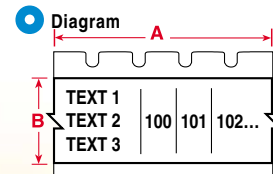
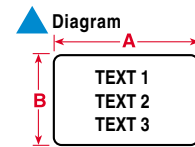

IDXPERT ELECTRICAL I.D. LABELS PORTABLE PRINTERS AND LABELS

IDXPERT™ Voice / Data Communications I.D. Labels

CABLE MARKERS

Ideal for marking data cabling, this cable marker's protected printing offers superior abrasion resistance and resistance to dirt, oils, solvents and water.

Marker features a clear non-printed area which wraps around and overlaminates the printed text. Printer automatically "multiple repeats" your text in white print area.

- ▶ **B-427 Vinyl Self-Laminating** material, resistant to water, oil, solvents and abrasion. Temp range: -94°F to 158°F (-70°C to 70°C). UL recognized.

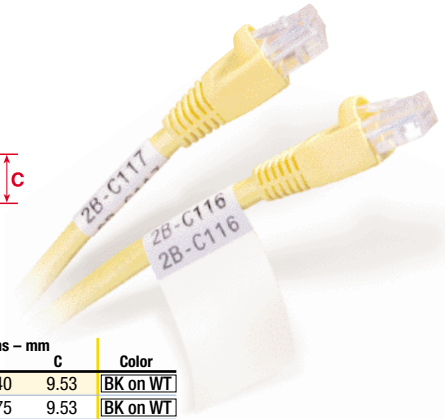
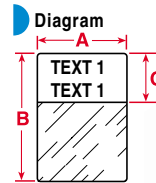

Sized to Fit	Diagram	Part Number	Labels per Cartridge	Dimensions – inches			Dimensions – mm			Color
				A	B	C	A	B	C	
2pair Fiber/Coaxial, Single/Multi-Mode	▶	XSL-19-427	250	1.000	1.000	0.375	25.40	25.40	9.53	BK on WT
CAT-5, 4pair UTP Copper	▶	XSL-102-427	250	0.500	1.250	0.375	12.70	31.75	9.53	BK on WT
CAT-5, 4pair UTP Copper, Fiber, Coaxial	▶	XSL-103-427	250	1.000	1.250	0.500	25.40	31.75	12.70	BK on WT
CAT-5, 4pair UTP Copper	▶	XSL-115-427	250	1.500	1.250	0.500	38.10	31.75	12.70	BK on WT
CAT-5, 4pair UTP Copper	▶	XSL-29-427	450	0.500	1.500	0.500	12.70	38.10	12.70	BK on WT
CAT-5, 4pair UTP Copper	▶	XSL-30-427	250	0.750	1.500	0.500	19.05	38.10	12.70	BK on WT
CAT-5, 4pair UTP Copper, Fiber, Coaxial	▶	XSL-31-427	250	1.000	1.500	0.500	25.40	38.10	12.70	BK on WT
CAT-5, 4pair UTP Copper, Fiber, Coaxial	▶	XSL-31-427-YL-BK	250	1.000	1.500	0.500	25.40	38.10	12.70	BK on YL
CAT-5, 4pair UTP Copper, Fiber, Coaxial	▶	XSL-32-427	227	1.500	1.500	0.500	38.10	38.10	12.70	BK on WT
25pair Copper, 4-12pair Fiber, Coaxial	▶	XSL-21-427	100	1.000	2.500	0.750	25.40	63.50	19.05	BK on WT
25pair Copper, 4-12pair Fiber, Coaxial	▶	XSL-21-427-YL-BK	100	1.000	2.500	0.750	25.40	63.50	19.05	BK on YL
25pair Copper, 4-12pair Fiber, Coaxial	▶	XSL-116-427	100	1.500	2.500	0.750	38.10	63.50	19.05	BK on WT
50pair Copper, 24pair Fiber, Backbone	▶	XSL-23-427	85	1.000	4.000	1.000	25.40	101.60	25.40	BK on WT
50pair Copper, 24pair Fiber, Backbone	▶	XSL-23-427-YL-BK	100	1.000	4.000	1.000	25.40	101.60	25.40	BK on YL
50pair Copper, 24pair Fiber, Backbone	▶	XSL-33-427	85	1.500	4.000	1.000	38.10	101.60	25.40	BK on WT
100pair Copper, 36pair Fiber, Backbone	▶	XSL-34-427	50	1.500	6.000	1.500	38.10	152.40	38.10	BK on WT

ID FOR RACKS, BAYS, FRAMES, PUBLIC NETWORK AND DATA CENTERS

Variety of sizes and permanent materials for marking Racks, Bays, Frames, Slots and other voice/data equipment.

- ▶ **B-422 Gloss Polyester** material, permanent adhesive. Temp Range: -40°F to 212°F (-40°C to 100°C). UL recognized.
- ▶ **B-483 Ultra Aggressive Polyester**, permanent adhesive for powder-coated/textured surfaces. Temp Range: -40°F to 248°F (-40°C to 120°C). UL recognized.
- ▶ **B-580 Indoor/Outdoor Vinyl** material, permanent adhesive, good for rough surfaces, wide range of colors. Temp Range: -40°F to 248°F (-40°C to 120°C).



Material Notes	Diagram	Part Number	Labels per Cartridge	Dimensions – inches		Dimensions – mm		Color
				A	B	A	B	
Ultra Polyester for powder-coated/textured surfaces	▲	X-17-483	500	1.000	0.500	25.40	12.70	BK on WT
Ultra Polyester for powder-coated/textured surfaces	▲	X-20-483	100	2.000	1.000	50.80	25.40	BK on WT
Ultra Polyester for powder-coated/textured surfaces	▲	X-61-483	100	2.000	0.500	50.80	12.70	BK on WT
Gloss Polyester for smooth/lightly textured surfaces	▲	X-17-422	500	1.000	0.500	25.40	12.70	BK on WT
Gloss Polyester for smooth/lightly textured surfaces	▲	X-19-422	250	1.000	1.000	25.40	25.40	BK on WT
Gloss Polyester for smooth/lightly textured surfaces	▲	X-29-422	500	1.500	0.500	38.10	12.70	BK on WT
Gloss Polyester for smooth/lightly textured surfaces	▲	X-30-422	250	1.500	0.750	38.10	19.05	BK on WT
Gloss Polyester for smooth/lightly textured surfaces	○	XC-1000-422	1 roll (cont.)	30 ft.	1.000	9.14 m	25.40	BK on WT
Indoor/Outdoor Vinyl (colored supplies)*	○	XC-500-580-YL-BK	1 roll (cont.)	30 ft.	0.500	9.14 m	12.70	BK on YL
Indoor/Outdoor Vinyl (colored supplies)*	○	XC-1000-580-YL-BK	1 roll (cont.)	30 ft.	1.000	9.14 m	25.40	BK on YL
Indoor/Outdoor Vinyl (colored supplies)*	○	XC-1500-580-YL-BK	1 roll (cont.)	30 ft.	1.500	9.14 m	38.10	BK on YL

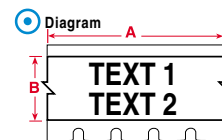
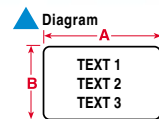

*Also available in Red, Orange, Green, Blue, White and Clear—refer to "Facility and Safety Labels" elsewhere in this brochure.

IDXPERT™ MRO / Facility / Safety Labels

▶ INDOOR / OUTDOOR GRADE FACILITY AND SAFETY LABELS

This indoor/5-yr outdoor vinyl is very pliable and conforms well to smooth or rough surfaces such as pipes, walls, door, panels, shelving, bins and equipment. Aggressive permanent adhesive. Excellent resistance to oils, detergents, dirt, grime and many solvents.

- ▶ *B-580 Indoor/Outdoor Vinyl material, permanent adhesive, good for rough surfaces. Temp Range: -40°F to 248°F (-40°C to 120°C).*

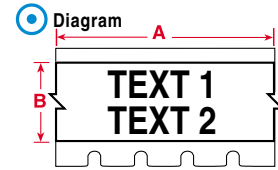

Diagram	Part Number	Labels per Cartridge	Dimensions – inches		Dimensions – mm		Color
			A	B	A	B	
⊙	XC-500-580-WT-BK	1 roll (cont.)	30 ft.	0.500	9.14 m	12.70	BK on WT
⊙	XC-1000-580-WT-BK	1 roll (cont.)	30 ft.	1.000	9.14 m	25.40	BK on WT
⊙	XC-1500-580-WT-BK	1 roll (cont.)	30 ft.	1.500	9.14 m	38.10	BK on WT
⊙	XC-500-580-OR-BK	1 roll (cont.)	30 ft.	0.500	9.14 m	12.70	BK on OR
⊙	XC-1000-580-OR-BK	1 roll (cont.)	30 ft.	1.000	9.14 m	25.40	BK on OR
⊙	XC-1500-580-OR-BK	1 roll (cont.)	30 ft.	1.500	9.14 m	38.10	BK on OR
⊙	XC-500-580-YL-BK	1 roll (cont.)	30 ft.	0.500	9.14 m	12.70	BK on YL
⊙	XC-1000-580-YL-BK	1 roll (cont.)	30 ft.	1.000	9.14 m	25.40	BK on YL
⊙	XC-1500-580-YL-BK	1 roll (cont.)	30 ft.	1.500	9.14 m	38.10	BK on YL
⊙	XC-500-580-CL-BK	1 roll (cont.)	30 ft.	0.500	9.14 m	12.70	BK on CL
⊙	XC-1000-580-CL-BK	1 roll (cont.)	30 ft.	1.000	9.14 m	25.40	BK on CL
⊙	XC-1500-580-CL-BK	1 roll (cont.)	30 ft.	1.500	9.14 m	38.10	BK on CL
⊙	XC-500-580-RD-WT	1 roll (cont.)	30 ft.	0.500	9.14 m	12.70	WT on RD
⊙	XC-1000-580-RD-WT	1 roll (cont.)	30 ft.	1.000	9.14 m	25.40	WT on RD
⊙	XC-1500-580-RD-WT	1 roll (cont.)	30 ft.	1.500	9.14 m	38.10	WT on RD
⊙	XC-500-580-GN-WT	1 roll (cont.)	30 ft.	0.500	9.14 m	12.70	WT on GN
⊙	XC-1000-580-GN-WT	1 roll (cont.)	30 ft.	1.000	9.14 m	25.40	WT on GN
⊙	XC-1500-580-GN-WT	1 roll (cont.)	30 ft.	1.500	9.14 m	38.10	WT on GN
⊙	XC-500-580-BL-WT	1 roll (cont.)	30 ft.	0.500	9.14 m	12.70	WT on BL
⊙	XC-1000-580-BL-WT	1 roll (cont.)	30 ft.	1.000	9.14 m	25.40	WT on BL
⊙	XC-1500-580-BL-WT	1 roll (cont.)	30 ft.	1.500	9.14 m	38.10	WT on BL
⊙	XC-500-580-WT-RD	1 roll (cont.)	30 ft.	0.500	9.14 m	12.70	RD on WT
⊙	XC-1000-580-WT-RD	1 roll (cont.)	30 ft.	1.000	9.14 m	25.40	RD on WT
⊙	XC-1500-580-WT-RD	1 roll (cont.)	30 ft.	1.500	9.14 m	38.10	RD on WT

IDXPERT MRO / FACILITY / SAFETY LABELS PORTABLE PRINTERS AND LABELS



► BINS AND STORAGE ID, GENERAL INDUSTRIAL ID

Choose from several aggressive label materials in a variety of sizes.

- **B-422 Gloss Polyester** material, permanent adhesive. For smooth surfaces. Temp Range: -40°F to 212°F (-40°C to 100°C). UL recognized.
- **B-428 Metallized Polyester** material, permanent adhesive, silver finish. Temp Range: -40°F to 176°F (-40°C to 80°C). UL recognized.
- **B-499 Nylon Cloth** material, permanent adhesive. Pliable for rough or smooth surfaces. Temp Range: -94°F to 194°F (-70°C to 90°C). UL recognized.
- **B-483 Ultra Aggressive Polyester**, permanent adhesive for powder-coated/textured surfaces. Temp Range: -40°F to 248°F (-40°C to 120°C). UL recognized.
- **B-580 Indoor/Outdoor Vinyl** material, permanent adhesive, good for rough surfaces, wide range of colors. Temp Range: -40°F to 248°F (-40°C to 120°C).

Diagram	Part Number	Labels per Cartridge	Dimensions – inches		Dimensions – mm		Material Notes	Color
			A	B	A	B		
▲	X-7-422	350	0.500	0.500	12.70	12.70	Gloss Polyester	[BK on WT]
▲	X-11-499	350	0.750	0.500	19.05	12.70	Permanent Nylon Cloth	[BK on WT]
▲	X-17-483	500	1.000	0.500	25.40	12.70	Ultra Polyester for Textured surfaces	[BK on WT]
▲	X-84-499	250	0.900	0.500	22.86	12.70	Permanent Nylon Cloth	[BK on WT]
▲	X-17-428-SV-BK	500	1.000	0.500	25.40	12.70	Metallized Polyester	[BK on SV]
▲	X-19-422	250	1.000	1.000	25.40	25.40	Gloss Polyester	[BK on WT]
▲	X-24-428-SVBB-BK	500	1.130	0.500	28.70	12.70	Metallized Polyester (Black Border)	[BK on SV]
▲	X-29-428-SV-BK	500	1.500	0.500	38.10	12.70	Metallized Polyester	[BK on SV]
▲	X-30-422	250	1.500	0.750	38.10	19.05	Gloss Polyester	[BK on WT]
▲	X-61-483	100	2.000	0.500	50.80	12.70	Ultra Polyester for Textured surfaces	[BK on WT]
▲	X-20-483	100	2.000	1.000	50.80	25.40	Ultra Polyester for Textured surfaces	[BK on WT]
▲	X-20-428-SV-BK	100	2.000	1.000	50.80	25.40	Metallized Polyester	[BK on SV]
✖	X-82-499	300	0.375 dia		9.53 dia		Permanent Nylon Cloth (Round Label)	[BK on WT]
✖	X-83-499	300	0.500 dia		12.70 dia		Permanent Nylon Cloth (Round Label)	[BK on WT]
⊙	XC-1000-483	1 roll (cont.)	30 ft.	1.000	9.14 m	25.40	Ultra Polyester for Textured surfaces	[BK on WT]
⊙	XC-500-580-YL-BK	1 roll (cont.)	30 ft.	0.500	9.14 m	12.70	Indoor/Outdoor Vinyl (colored supplies)*	[BK on YL]
⊙	XC-1000-580-YL-BK	1 roll (cont.)	30 ft.	1.000	9.14 m	25.40	Indoor/Outdoor Vinyl (colored supplies)*	[BK on YL]
⊙	XC-1500-580-YL-BK	1 roll (cont.)	30 ft.	1.500	9.14 m	38.10	Indoor/Outdoor Vinyl (colored supplies)*	[BK on YL]

*Also available in Red, Orange, Green, Blue, White and Clear—refer to "Facility & Safety Labels" on facing page.

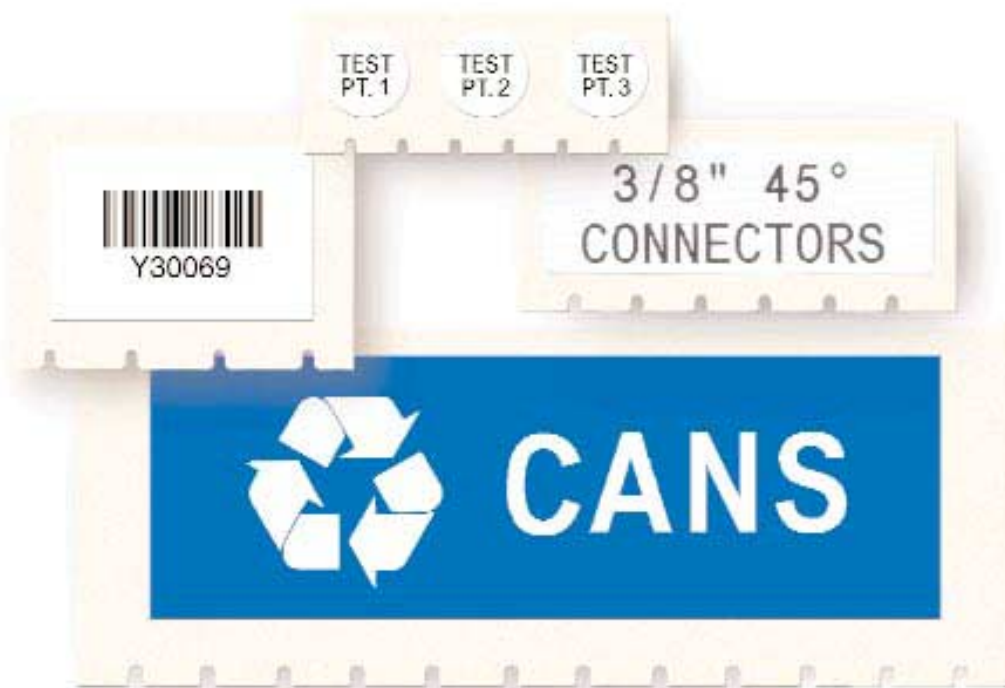
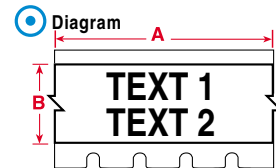
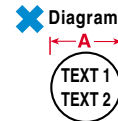
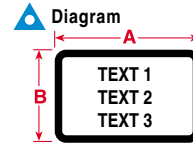
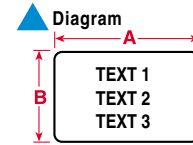

TLS 2200® Thermal Labeling System



TLS2200®
THERMAL LABELING SYSTEM

The Brady TLS 2200 printer is the most versatile and powerful portable labeling system available. The hand held, lightweight (2.75 lb/1.25 kg) design allows you to print labels whenever and wherever you want.

Smart-Cell Technology makes printing fast and easy. No calibration is required since the printer automatically formats the label. The non-smearing, thermal transfer printing and bar coding capability makes this the perfect tool for electrical, datacomm and industrial applications. Over 350 stock label sizes are available including die cut labels, self-laminating markers, heat shrink markers, terminal block markers and continuous tape.

Other features include memory (allowing you to create and save legends in lists), banner printing and PC connectivity using the optional LabelMark™ design software. The TLS 2200 printer is recommended for medium volume printing (approximately 500 labels per print run) with a maximum label width of 4.000 in.

- ▶ Prints 203 dpi (8 dots/mm)
- ▶ Custom TrueType font
- ▶ Prints bar codes (Code 39)
- ▶ Labels up to 2.000" wide (50.80 mm)
- ▶ Print width 1.810" (45.97 mm)
- ▶ Print length up to 54.000" (1371.60 mm)
- ▶ Two line liquid crystal display (LCD), 16 characters wide
- ▶ UL and CUL listed battery charger - 120V/60hz input 9VDC 183mA output
- ▶ 6 month warranty (12 months if registered)
- ▶ Adjustable for 6 different widths of labels
- ▶ Built-in industrial label cutter
- ▶ Patent numbers D409, 230; 5,918,989; 5,951,177; 6,113,293 and 6,142,686

TLS 2200 Thermal Labeling System

Part Number	Description
TLS2200	TLS 2200 Thermal Labeling System*
TLS2200-INTL	International TLS 2200 Thermal Labeling System*

*Ships with hard case, R6210 ribbon, battery pack, battery charger, Quick Start Guide, manual, communications cable, test labels (PTL-19-423), one cleaning card.

▶ ACCESSORIES

TLS 2200 Thermal Labeling System Accessories

Part Number	Description
TLS2200-AC	AC adapter
TLS2200-ACINTL	AC adapter - International
TLS2200-BC	Battery charger
TLS2200-BP	Battery pack
TLS2200-BPINTL	Battery pack - International
TLS2200-HC	Hard side carrying case
TLS2200-SC	Soft side users case
TLS2200-CABLE	Communications cable
TLS2200-UPDISKS	Upgrade disks (includes 3.5" disks)
TLS2200-UPKIT	Upgrade kit (includes 3.5" disks and cable)
TLSHM-QUICKCH	Quick charger for TLS
PCK-5	Cleaning kit (includes 5 cleaning cards)

▶ SPECIFICATIONS

Print method	Thermal transfer (non smearing)
Weight	2.75 lbs. (1.25 kg)
Dimensions (L x W x H)	11.500 in x 4.250 in x 4.000 in (292.10 mm x 107.95 mm x 101.60 mm)
Power source	Rechargeable battery prints over 500 labels
Operating temperature	40° - 120° F (4° - 49° C)
Agency approvals	FCC Class A approved



TLS2200-SC

TLS2200-AC

TLS PC Link™ Thermal Labeling System



TLS PC Link Thermal Labeling System

Part Number	Description
TLSPC	TLS PC Link Thermal Labeling System*
TLSPC-EUR/UK	TLS PC Link Thermal Labeling System* - Europe and UK
TLSPC-INTL	TLS PC Link Thermal Labeling System* - Asia-Pacific

*Ships with LabelMark™ labeling software, rechargeable battery pack, power supply/battery charger, R6210 ribbon, sample labels (PTL-19-423), Quick Start Guide, manuals, communications cable, and Windows drivers

► ACCESSORIES

TLS PC Link Thermal Labeling System Accessories

Part Number	Description
TLSPC-AC	Replacement power supply/battery charger
TLSPC-ACEUR/UK	Replacement power supply/battery charger - Europe and UK
TLSPC-ACINTL	Replacement power supply/battery charger - Japan
TLSPC-BP	Rechargeable battery pack
TLSPC-BPINTL	Rechargeable battery pack - International
TLSPC-CABLE	Communications cable
TLSPC-CABLEINTL	Communications cable - International
CORD-EUR	Replacement power cord - Europe
CORD-UK	Replacement power cord - UK
CORD-JAPAN	Replacement power cord - Japan
PCK-5	Cleaning Kit (includes 5 cleaning cards)

The Brady TLS PC Link thermal labeling system is the best value desktop printing system. The small footprint and lightweight, rugged design makes it a nice fit for a variety of medium volume (approximately 500 labels per print run) applications. It connects to a PC for use with LabelMark™ software (included) or other Windows based programs.

The same basic design as the TLS 2200® allows you to utilize the same consumables (including bulk rolls) in both the TLS 2200 and the TLS PC Link. Smart-Cell Technology makes printing fast and easy. No calibration is required since the printer automatically formats the label. In addition, the printer has its own printer control language allowing the unit to be integrated with other PC controlled equipment.

- Custom TrueType font
- Labels up to 2.000" wide (50.80 mm)
- Print width 1.810" (45.97 mm)
- Print length up to 6.000" (152.40 mm)
- UL and CUL listed AC adapter/battery charger - 120V/60hz input 12VDC 3000mA output
- Adjustable for 6 different widths of labels
- Built-in industrial label cutter
- 6 month warranty (12 months if registered)

► SPECIFICATIONS

Print method	Thermal transfer (non smearing)
Weight	2.50 lbs. (1.14 kg)
Dimensions (L x W x H)	9.250 in x 4.000 in x 4.250 in (234.95 mm x 101.60 mm x 107.95 mm)
Power source	Rechargeable battery prints over 500 labels
Operating temperature	40° - 120° F (4° - 49° C)
Agency approvals	FCC Class A approved

TLS 2200® / TLS PC Link™ Thermal Labeling Systems

► RIBBONS

TLS 2200 / TLS PC Link Thermal Labeling Systems Ribbons

Part Number	Description	Length ft (m)
R4310	R4310 black ribbon	75 ft (22.90 m)
R6010	R6010 black ribbon	75 ft (22.90 m)
R6210	R6210 black ribbon	75 ft (22.90 m)
R4410-BL	R4410 blue ribbon	75 ft (22.90 m)
R4410-RD	R4410 red ribbon	75 ft (22.90 m)
R4410-WT	R4410 white ribbon	75 ft (22.90 m)

FYI

Ever wonder how many labels you can get from our TLS2200 ribbons??? Try this formula:

Our TLS2200 ribbons are 900 inches long. To estimate how many labels you will get out of one ribbon, use the following formula:

900 divided by label height (B dimension) + 0.10

Example: pti-19-422 is 1.0" tall. $1.0 + 0.10 = 1.10$
 900 divided by 1.1 = 818 labels

TLS 2200 / TLS PC Link Ribbon Cross Reference Guide

B#’s	Material	Series R4310	Series R4410 (colors)	Series R6010	Series ^R6210
109	Tag	●			
321	Polyolefin				●
342	Polyolefin	●			
351	Vinyl				●
352	Vinyl			●	
353	Paper	●			
412	Polypropylene				●
422	Polyester		△	● UL/CSA	△
423	Polyester		△	● UL/CSA/AGA	△
424	Paper	●			
426	Polyimide	●			
427	Vinyl	● UL			△
428	Polyester	● UL/CSA/AGA			
430	Polyester		△	● UL/CSA	△
432	Polyester		△	● UL/CSA	
433	Polyester		△	● UL	
435	Polyester			● UL/CSA	
437	Tedlar®	●			
439	Vinyl		△	●	△
457	Polyimide			● UL	
459	Polyester		△ UL	● UL/CSA	
461	Polyester	●			△
473	Polyester			● UL/CSA	△
477	Polyimide			● UL	△
478	Polyimide			● UL	
479	Polyimide			● UL	
483	Polyester		△	● UL/CSA	△
486	Polyester	● UL/CSA			
488	Polyester	● UL/CSA/AGA			△ UL/CSA
489	Polyester	● UL/CSA			
495	PEN			● UL	
498	Vinyl Cloth	△			●
499	Nylon Cloth	● UL/CSA			△
642	Tedlar®	●			△
7546	Polyester			● UL/CSA	
7566	Polyester		△	●	
7576	Polyester		△	● UL	
8425	Polyolefin		△	● UL	

Tedlar® is a registered trademark of DuPont.

► BULK LABELS

Bulk labels are designed for the TLS 2200 and TLS PC Link thermal labeling systems to save customers money, and provide the perfect low volume* labeling solution. A reusable dispenser box protects labels from dust and debris and allows easy storage until the next identification job. Bulk labels utilize Brady's Smart-Cell Technology and allow the TLS 2200 and TLS PC Link printers to recognize label sizes and printer settings automatically, eliminating wasted time and materials.



* TLS 2200 and TLS PC Link printers are recommended for printing 500 or less labels per print run. You may experience a printer slowdown if printing large quantities of labels at one time depending on the material, label size and amount of print coverage.

●	Recommended ribbon for use with respective material.
△	Acceptable ribbon for use with respective material.
UL	These materials are UL recognized with its respective ribbon.
CSA	These materials are CSA approved with its respective ribbon.
UL/CSA	These materials are UL & CSA approved with its respective ribbon.
AGA	These materials are AGA approved.
^	R6210 ribbon included with printers.

► VARIABLE FONT SIZES

Font sizes range from 1 (4 point) to 19 (72 point). The maximum font size available depends on factors such as label size, number of characters, number of lines, as well as font sizes in other lines.

Font Number	Point Size	Print Sample
1	4	ABC 12345
2	5	ABC 12345
3	6	ABC 12345
4	7	ABC 12345
5	9	ABC 12345
6	10	ABC 12345
7	11	ABC 12345
8	13	ABC 12345
9	14	ABC 12345
10	17	ABC 12345
11	20	ABC 12345
12	23	ABC 12345
13	26	ABC 12345
14	28	ABC 1234
(PC Link Only)		
15	35	ABC 12
15	36	ABC 12

Font Number	Point Size	Print Sample
16	45	ABC 1
17	51	ABC 1
18	56	ABC
(PC Link Only)		
19	70	ABC
19	72	ABC

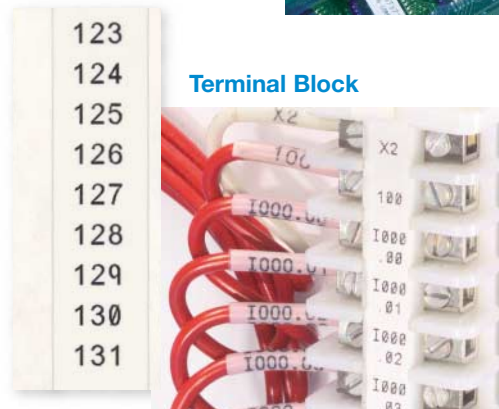
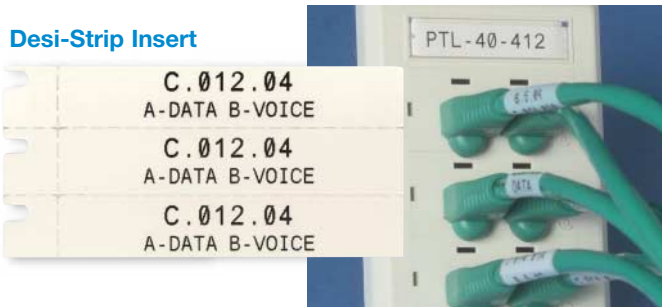
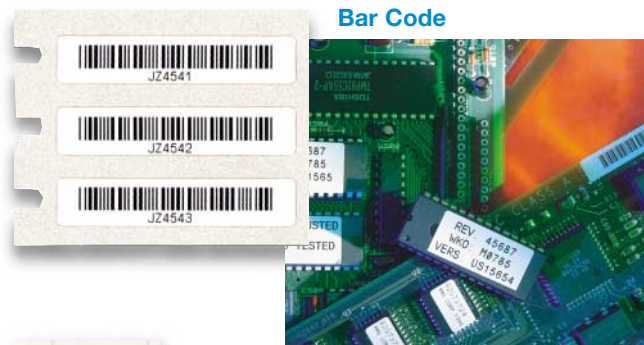
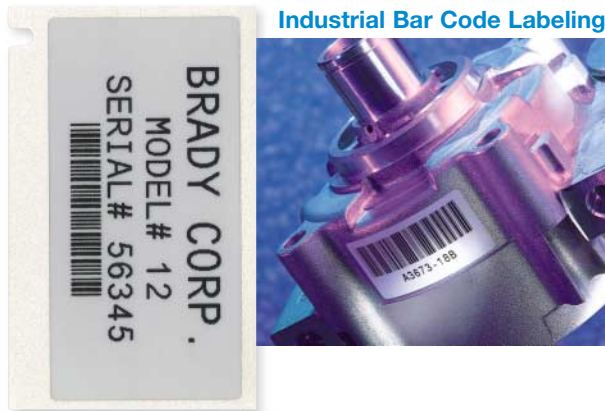



TLS 2200® / TLS PC Link™ Materials Chart

TLS 2200 / TLS PC LINK MATERIALS CHART PORTABLE PRINTERS AND LABELS

Type	Max. Service Temp. °F (°C)	Color	Finish	Use	Special Properties
NYLON CLOTH					
B-499	194 (90) 30 days	White	Matte	Low profile through-conduit wire marking, component and general labeling	High adhesion makes all-purpose wire marker ideal for environments where heat, oil and dirt are present   HF
PAPER					
B-424	122 (50) 30 days	White	Matte	Bar code and general labeling	Good contrast and smear resistance
POLYESTER					
B-422	212 (100) 30 days	White	Gloss	Electronic PCB ID and component, bar code label and rating plate, outlet and patch panel identification	2 mil adhesive recommended for application on textured surfaces  
B-423	248 (120) 30 days	White	Gloss	Electronic PCB ID and component, bar code label, rating plates and outlets	  HF 
B-428	176 (80) 30 days	Silver	Matte	Rating plates; electronic component marking	  HF 
B-430	212 (100) 30 days	Clear	Gloss	General labeling rating/name plates, outlet and general communications	High adhesion make it ideal for highly textured and other surfaces that are difficult to adhere to; Translucent  
B-432	212 (100) 30 days	Clear	Gloss	General labeling rating/name plates, outlet and general communications	Clear glossy polyester for highly textured and hard to adhere to surfaces.  
B-433	212 (100) 30 days	White	Gloss	Electronic component marking, bar code and general purpose labeling	Good solvent and heat resistance; label can be easily removed 
B-435	194 (90) 30 days	Silver	Gloss	Rating plates and general labeling	Designed to withstand solvents while maintaining excellent image quality   
B-459	212 (100) 30 days	White	Matte	Electronic PCB ID and component; bar code labeling and rating plates	 
B-461	212 (100) 30 days	White	Matte	Self-laminating marker	Excellent abrasion and smudge resistance HF
B-473	248 (120) 30 days	White	Gloss	Electronic PCB ID and component; bar code labeling and rating plates	Static dissipative adhesive and liner   
B-483	248 (120) 30 days	White	Gloss	General labeling; bar code label and rating plates	Ultra-aggressive adhesive for thermal transfer printing, designed for powder coated surfaces  
B-486	248 (120) 30 days	Silver	Matte	General labeling; bar code labeling and rating plates	Ultra-aggressive adhesive for oily, greasy, and powder coated surfaces  
B-488	320 (160) 30 days	White	Matte	Electronic PCB and component; bar code label and rating plates	High performance matte white
B-489	248 (120) 30 days	White	Matte	General labeling; bar code labeling and rating plates	Ultra-aggressive adhesive for oily, greasy, and powder coated surfaces; UL/CSA approval pending  
B-7546	175 (80) 30 days	White	Gloss	Tamper-evident labels	Leaves "void" footprint when removed  
B-7566	175 (80) 30 days	Clear	Gloss	Tamper-evident labels	Leaves "void" footprint when removed  
B-7576	212 (100) 30 days	Silver	Matte	Tamper-evident labels	Leaves "void" footprint when removed  
POLYETHYLENE					
B-109	120 (49) 30 days	White	Matte	Multi-purpose identification tag, where durability is required	Cross-laminated polyethylene provides extreme tear resistance and excellent cold-weather performance HF
B-145	—	Gray	Matte	Power and ground labels	Tear-resistant 2-sided printable tag
POLYIMIDE					
B-426	662 (350) 80 sec.	Amber	Matte	Underside PCB ID and other high temperature, high performance applications	Withstands extremely high temperatures
B-457	662 (350) 80 sec.	White	Gloss	Top- or bottom-side board application for SMT or Through hole	Good contrast and smear resistance 
B-477	662 (350) 80 sec.	White	Gloss	Top- or bottom-side board application for SMT or Through hole	Static dissipative adhesive and liner  
B-478	662 (350) 80 sec.	White	Gloss	1 mil low profile top- or bottom-side board application for SMT or Through hole	Static dissipative adhesive and liner  
B-479	662 (350) 80 sec.	White	Matte	1 mil low profile top- or bottom-side board application for SMT or Through hole	Static dissipative adhesive and liner  
POLYOLEFIN					
B-321	221 (105) 30 days	White	Matte	Wire marking	Heat-shrinkable
B-342	267 (130) 30 days	White/Yellow	Matte	Wire marking	3-to-1 shrink ratio; self-extinguishing, meets the material and physical property of MIL-DTL-23053/5 Class 1, MIL-M-81531, MIL-STD-202F, Method 215 and UL 224
POLYPROPYLENE					
B-412	212 (100) 30 days	White	Matte	Wire, cable and product inventory information	Designed for outdoor and harsh environmental applications or where tensile strength is needed HF
B-8425	194 (90) 30 days	White	Gloss	Wire marking, fiber optic marking, and general labeling	Good solvent resistance and print permanence  
POLYETHYLENE NAPHTHALATE (PEN)					
B-495	464 (240) 5 min.	White	Gloss	Top- or bottom-side board application for SMT or Top Side for Through hole	Good contrast and smear resistance 
TEDLAR®					
B-437	275 (135) 30 days	White/Yellow	Matte	Aerospace and military cable marking	Self-extinguishing
B-642	266 (130) 30 days	White	Matte	Self-laminating; wire and cable marking	Self-extinguishing, low smoke and flame spread; Excellent abrasion and smudge resistance
VINYL					
B-351	176 (80) 30 days	White	Matte	Tamper-resistant labels	Designed to fracture easily
B-352	176 (80) 30 days	Silver	Matte	Tamper-resistant labels	Designed to fracture easily
B-427	158 (70) 30 days	White	Matte	Self-laminating wire and cable marking	Excellent abrasion and smudge resistance 
B-439	104 (40) 30 days	White/Yellow/Orange/Red	Matte	Pathway, racks, voltage markers, wire bundle, rating plates and general labeling	Various colors available
VINYL CLOTH					
B-498	175 (80) 30 days	White	Semi-Gloss	Wire and electronic component marking	Repositionable adhesive 

Tedlar® is a registered trademark of DuPont.

 These materials have static dissipative adhesives.
 *These materials are UL recognized.
 *These materials are CSA approved.

 *These materials are AGA approved.
 Halogen-Free (DIN VDE 0472/parts 815)

*Refer to the full page charts on pages 280-281 for more information and complete listing of parts.

TLS 2200® / TLS PC Link™ Index by Part Number

Part Number	Size Inch (mm)	Specifications on Page	Part Number	Size Inch (mm)	Specifications on Page	Part Number	Size Inch (mm)	Specifications on Page			
BPSPT-094-1-WT	0.094 dia. x 1.015	(2.39 x 25.78)	36	PSPT-250-175-YL	0.250 dia. x 1.765	(6.35 x 44.83)	36	PTL-9-479	0.650 x 0.200	(16.51 x 5.08)	26
BPSPT-125-1-WT	0.125 dia. x 1.015	(3.18 x 25.78)	36	PSPT-375-175-YL	0.375 dia. x 1.765	(9.53 x 44.83)	36	PTL-9-495	0.650 x 0.200	(16.51 x 5.08)	26
BPSPT-187-1-WT	0.187 dia. x 1.015	(4.75 x 25.78)	36	PSPT-500-175-YL	0.500 dia. x 1.765	(12.70 x 44.83)	36	PTL-10-423	0.750 x 0.250	(19.05 x 6.35)	26
BPSPT-250-1-WT	0.250 dia. x 1.015	(6.35 x 25.78)	36	PSPT-1000-175-YL	1.000 dia. x 1.765	(25.40 x 44.83)	36	PTL-10-425	0.750 x 0.250	(19.05 x 6.35)	26
BPSPT-375-1-WT	0.375 dia. x 1.015	(9.53 x 25.78)	36	PTDS-15-390	0.590 x 0.163	(15.00 x 4.14)	36	PTL-10-426	0.750 x 0.250	(19.05 x 6.35)	26
BPSPT-500-1-WT	0.500 dia. x 1.015	(12.70 x 25.78)	36	PTDS-30-390	1.181 x 0.163	(30.00 x 4.14)	36	PTL-10-427	0.250 x 0.750	(6.35 x 19.05)	24
BPSPT-094-175-WT	0.094 dia. x 1.765	(2.39 x 44.83)	36	PTL-1-423	0.250 x 0.250	(6.35 x 6.35)	24	PTL-10-427-YL	0.250 x 0.750	(6.35 x 19.05)	24
BPSPT-125-175-WT	0.125 dia. x 1.765	(3.18 x 44.83)	36	PTL-1-426	0.250 x 0.250	(6.35 x 6.35)	24	PTL-10-432	0.750 x 0.250	(19.05 x 6.35)	26
BPSPT-187-175-WT	0.187 dia. x 1.765	(4.75 x 44.83)	36	PTL-1-457	0.250 x 0.250	(6.35 x 6.35)	24	PTL-10-437	0.750 x 0.250	(19.05 x 6.35)	26
BPSPT-250-175-WT	0.250 dia. x 1.765	(6.35 x 44.83)	36	PTL-1-473	0.250 x 0.250	(6.35 x 6.35)	24	PTL-10-457	0.750 x 0.250	(19.05 x 6.35)	26
BPSPT-375-175-WT	0.375 dia. x 1.765	(9.53 x 44.83)	36	PTL-1-477	0.250 x 0.250	(6.35 x 6.35)	24	PTL-10-473	0.750 x 0.250	(19.05 x 6.35)	26
BPSPT-500-175-WT	0.500 dia. x 1.765	(12.70 x 44.83)	36	PTL-1-478	0.250 x 0.250	(6.35 x 6.35)	24	PTL-10-477	0.750 x 0.250	(19.05 x 6.35)	26
BPSPT-1000-175-WT	1.000 dia. x 1.765	(25.40 x 44.83)	36	PTL-1-479	0.250 x 0.250	(6.35 x 6.35)	24	PTL-10-478	0.750 x 0.250	(19.05 x 6.35)	26
BPTDS-15-390	0.590 x 0.163	(15.00 x 4.14)	36	PTL-1-495	0.250 x 0.250	(6.35 x 6.35)	24	PTL-10-479	0.750 x 0.250	(19.05 x 6.35)	26
BPTDS-30-390	1.181 x 0.163	(30.00 x 4.14)	36	PTL-2-423	2.000 x 0.250	(50.80 x 6.35)	32	PTL-10-495	0.750 x 0.250	(19.05 x 6.35)	26
BPTL-7-423	0.500 x 0.500	(12.70 x 12.70)	25	PTL-2-426	2.000 x 0.250	(50.80 x 6.35)	32	PTL-10-498	0.250 x 0.750	(6.35 x 19.05)	25
BPTL-11-427	0.500 x 0.750	(12.70 x 19.05)	25	PTL-2-457	2.000 x 0.250	(50.80 x 6.35)	32	PTL-10-8425	0.750 x 0.250	(19.05 x 6.35)	27
BPTL-11-498	0.500 x 0.750	(12.70 x 19.05)	25	PTL-2-477	2.000 x 0.250	(50.80 x 6.35)	32	PTL-11-427	0.750 x 0.500	(19.05 x 12.70)	27
BPTL-11-499	0.500 x 0.750	(12.70 x 19.05)	25	PTL-2-478	2.000 x 0.250	(50.80 x 6.35)	32	PTL-11-427-YL	0.750 x 0.500	(19.05 x 12.70)	27
BPTL-12-109	0.750 x 3.000	(19.05 x 76.20)	27	PTL-2-479	2.000 x 0.250	(50.80 x 6.35)	32	PTL-11-432	0.750 x 0.500	(19.05 x 12.70)	27
BPTL-16-423	1.000 x 0.375	(25.40 x 9.53)	28	PTL-2-495	2.000 x 0.250	(50.80 x 6.35)	32	PTL-11-498	0.750 x 0.500	(19.05 x 12.70)	27
BPTL-17-423	1.000 x 0.500	(25.40 x 12.70)	28	PTL-3-423	0.375 x 0.375	(9.53 x 9.53)	24	PTL-11-499	0.750 x 0.500	(19.05 x 12.70)	27
BPTL-17-427	0.500 x 1.000	(12.70 x 25.40)	25	PTL-3-426	0.375 x 0.375	(9.53 x 9.53)	24	PTL-12-109	0.750 x 3.000	(19.05 x 76.20)	27
BPTL-17-428	1.000 x 0.500	(25.40 x 12.70)	28	PTL-3-457	0.375 x 0.375	(9.53 x 9.53)	24	PTL-13-423	0.900 x 0.250	(22.86 x 6.35)	27
BPTL-18-427	0.750 x 1.000	(19.05 x 25.40)	27	PTL-3-477	0.375 x 0.375	(9.53 x 9.53)	25	PTL-13-426	0.900 x 0.250	(22.86 x 6.35)	27
BPTL-18-498	0.750 x 1.000	(19.05 x 25.40)	27	PTL-3-478	0.375 x 0.375	(9.53 x 9.53)	25	PTL-13-457	0.900 x 0.250	(22.86 x 6.35)	27
BPTL-19-423	1.000 x 1.000	(25.40 x 25.40)	28	PTL-3-479	0.375 x 0.375	(9.53 x 9.53)	25	PTL-13-478	0.900 x 0.250	(22.86 x 6.35)	27
BPTL-19-427	1.000 x 1.000	(25.40 x 25.40)	28	PTL-3-495	0.375 x 0.375	(9.53 x 9.53)	25	PTL-13-479	0.900 x 0.250	(22.86 x 6.35)	27
BPTL-19-498	1.000 x 1.000	(25.40 x 25.40)	28	PTL-4-423	0.400 x 0.400	(10.16 x 10.16)	25	PTL-13-495	0.900 x 0.250	(22.86 x 6.35)	27
BPTL-20-422	2.000 x 1.000	(50.80 x 25.40)	32	PTL-4-426	0.400 x 0.400	(10.16 x 10.16)	25	PTL-14-423	1.000 x 0.187	(25.40 x 4.74)	27
BPTL-20-423	2.000 x 1.000	(50.80 x 25.40)	32	PTL-4-457	0.400 x 0.400	(10.16 x 10.16)	25	PTL-14-457	1.000 x 0.187	(25.40 x 4.74)	27
BPTL-20-424	2.000 x 1.000	(50.80 x 25.40)	32	PTL-4-478	0.400 x 0.400	(10.16 x 10.16)	25	PTL-14-477	1.000 x 0.187	(25.40 x 4.74)	27
BPTL-20-428	2.000 x 1.000	(50.80 x 25.40)	32	PTL-4-479	0.400 x 0.400	(10.16 x 10.16)	25	PTL-14-478	1.000 x 0.187	(25.40 x 4.74)	27
BPTL-21-427	1.000 x 2.500	(25.40 x 63.50)	29	PTL-4-495	0.400 x 0.400	(10.16 x 10.16)	25	PTL-14-479	1.000 x 0.187	(25.40 x 4.74)	27
BPTL-23-427	1.000 x 4.000	(25.40 x 101.60)	29	PTL-5-422	0.500 x 0.200	(12.70 x 5.08)	25	PTL-14-495	1.000 x 0.187	(25.40 x 4.74)	27
BPTL-29-423	1.500 x 0.500	(38.10 x 12.70)	30	PTL-5-423	0.500 x 0.200	(12.70 x 5.08)	25	PTL-15-423	1.000 x 0.275	(25.40 x 6.98)	27
BPTL-29-427	0.500 x 1.500	(12.70 x 38.10)	25	PTL-5-473	0.500 x 0.200	(12.70 x 5.08)	25	PTL-15-428	1.000 x 0.275	(25.40 x 6.98)	27
BPTL-29-498	0.500 x 1.500	(12.70 x 38.10)	26	PTL-6-423	0.500 x 0.275	(12.70 x 6.98)	25	PTL-15-437	1.000 x 0.275	(25.40 x 6.98)	27
BPTL-30-427	0.750 x 1.500	(19.05 x 38.10)	27	PTL-6-426	0.500 x 0.275	(12.70 x 6.98)	25	PTL-15-498	1.000 x 0.275	(25.40 x 6.98)	27
BPTL-31-427	1.000 x 1.500	(25.40 x 38.10)	29	PTL-6-430	0.500 x 0.275	(12.70 x 6.98)	25	PTL-16-422	1.000 x 0.375	(25.40 x 9.53)	27
BPTL-32-427	1.500 x 1.500	(38.10 x 38.10)	31	PTL-6-457	0.500 x 0.275	(12.70 x 6.98)	25	PTL-16-423	1.000 x 0.375	(25.40 x 9.53)	28
BPTL-33-427	1.500 x 4.000	(38.10 x 101.60)	31	PTL-6-473	0.500 x 0.275	(12.70 x 6.98)	25	PTL-16-426	1.000 x 0.375	(25.40 x 9.53)	28
BPTL-34-427	1.500 x 6.000	(38.10 x 152.40)	31	PTL-6-478	0.500 x 0.275	(12.70 x 6.98)	25	PTL-16-430	1.000 x 0.375	(25.40 x 9.53)	28
BPTL-40-412	1.938 x 0.375	(49.23 x 9.53)	32	PTL-6-479	0.500 x 0.275	(12.70 x 6.98)	25	PTL-16-435	1.000 x 0.375	(25.40 x 9.53)	28
BPTL-75-461	2.625 x 1.000	(66.68 x 25.40)	33	PTL-6-495	0.500 x 0.275	(12.70 x 6.98)	25	PTL-16-457	1.000 x 0.375	(25.40 x 9.53)	28
BPTL-107-427	2.000 x 1.500	(50.80 x 38.10)	33	PTL-7-422	0.500 x 0.500	(12.70 x 12.70)	25	PTL-16-473	1.000 x 0.375	(25.40 x 9.53)	28
BPTL-498-240	0.240 x 300 ft	(6.10 x 91.44 m)	37	PTL-7-423	0.500 x 0.500	(12.70 x 12.70)	25	PTL-16-478	1.000 x 0.375	(25.40 x 9.53)	28
BPTL-498-318	0.318 x 300 ft	(8.08 x 91.44 m)	37	PTL-7-430	0.500 x 0.500	(12.70 x 12.70)	25	PTL-16-479	1.000 x 0.375	(25.40 x 9.53)	28
BPTL-498-375	0.375 x 300 ft	(9.53 x 91.44 m)	37	PTL-7-432	0.500 x 0.500	(12.70 x 12.70)	25	PTL-16-483	1.000 x 0.375	(25.40 x 9.53)	28
PSPT-094-1-WT	0.094 dia. x 1.015	(2.39 x 25.78)	36	PTL-7-498	0.500 x 0.500	(12.70 x 12.70)	25	PTL-16-486	1.000 x 0.375	(25.40 x 9.53)	28
PSPT-125-1-WT	0.125 dia. x 1.015	(3.18 x 25.78)	36	PTL-7-499	0.500 x 0.500	(12.70 x 12.70)	25	PTL-16-489	1.000 x 0.375	(25.40 x 9.53)	28
PSPT-187-1-WT	0.187 dia. x 1.015	(4.75 x 25.78)	36	PTL-8-422	0.500 x 50 ft	(12.70 x 15.24 m)	26	PTL-16-495	1.000 x 0.375	(25.40 x 9.53)	19
PSPT-250-1-WT	0.250 dia. x 1.015	(6.35 x 25.78)	36	PTL-8-423	0.500 x 50 ft	(12.70 x 15.24 m)	26	PTL-16-498	0.375 x 1.000	(9.53 x 25.40)	25
PSPT-375-1-WT	0.375 dia. x 1.015	(9.53 x 25.78)	36	PTL-8-428	0.500 x 50 ft	(12.70 x 15.24 m)	26	PTL-16-499	0.375 x 1.000	(9.53 x 25.40)	25
PSPT-500-1-WT	0.500 dia. x 1.015	(12.70 x 25.78)	36	PTL-8-430	0.500 x 50 ft	(12.70 x 15.24 m)	26	PTL-17-351	1.000 x 0.500	(25.40 x 12.70)	28
PSPT-1000-1-WT	1.000 dia. x 1.015	(25.40 x 25.78)	36	PTL-8-432	0.500 x 50 ft	(12.70 x 15.24 m)	26	PTL-17-352	1.000 x 0.500	(25.40 x 12.70)	28
PSPT-094-1-YL	0.094 dia. x 1.015	(2.39 x 25.78)	36	PTL-8-439	0.500 x 50 ft	(12.70 x 15.24 m)	26	PTL-17-422	1.000 x 0.500	(25.40 x 12.70)	28
PSPT-125-1-YL	0.125 dia. x 1.015	(3.18 x 25.78)	36	PTL-8-439-BK	0.500 x 50 ft	(12.70 x 15.24 m)	26	PTL-17-423	1.000 x 0.500	(25.40 x 12.70)	28
PSPT-187-1-YL	0.187 dia. x 1.015	(4.75 x 25.78)	36	PTL-8-439-BL	0.500 x 50 ft	(12.70 x 15.24 m)	26	PTL-17-426	1.000 x 0.500	(25.40 x 12.70)	28
PSPT-250-1-YL	0.250 dia. x 1.015	(6.35 x 25.78)	36	PTL-8-439-GN	0.500 x 50 ft	(12.70 x 15.24 m)	26	PTL-17-427	0.500 x 1.000	(12.70 x 25.40)	25
PSPT-375-1-YL	0.375 dia. x 1.015	(9.53 x 25.78)	36	PTL-8-439-OR	0.500 x 50 ft	(12.70 x 15.24 m)	26	PTL-17-427-YL	0.500 x 1.000	(12.70 x 25.40)	25
PSPT-500-1-YL	0.500 dia. x 1.015	(12.70 x 25.78)	36	PTL-8-439-RD	0.500 x 50 ft	(12.70 x 15.24 m)	26	PTL-17-428	1.000 x 0.500	(25.40 x 12.70)	28
PSPT-1000-1-YL	1.000 dia. x 1.015	(25.40 x 25.78)	36	PTL-8-439-YL	0.500 x 50 ft	(12.70 x 15.24 m)	26	PTL-17-430	1.000 x 0.500	(25.40 x 12.70)	28
PSPT-094-175-WT	0.094 dia. x 1.765	(2.39 x 44.83)	36	PTL-8-483	0.500 x 50 ft	(12.70 x 15.24 m)	26	PTL-17-432	1.000 x 0.500	(25.40 x 12.70)	28
PSPT-125-175-WT	0.125 dia. x 1.765	(3.18 x 44.83)	36	PTL-8-489	0.500 x 50 ft	(12.70 x 15.24 m)	26	PTL-17-435	1.000 x 0.500	(25.40 x 12.70)	28
PSPT-187-175-WT	0.187 dia. x 1.765	(4.75 x 44.83)	36	PTL-8-498	0.500 x 30 ft	(12.70 x 9.10 m)	26	PTL-17-449	1.000 x 0.500	(25.40 x 12.70)	28
PSPT-250-175-WT	0.250 dia. x 1.765	(6.35 x 44.83)	36	PTL-9-423	0.650 x 0.200	(16.51 x 50.08)	26	PTL-17-473	1.000 x 0.500	(25.40 x 12.70)	28
PSPT-375-175-WT	0.375 dia. x 1.765	(9.53 x 44.83)	36	PTL-9-426	0.650 x 0.200	(16.51 x 50.08)	26	PTL-17-478	1.000 x 0.500	(25.40 x 12.70)	28
PSPT-500-175-WT	0.500 dia. x 1.765	(12.70 x 44.83)	36	PTL-9-437	0.650 x 0.200	(16.51 x 50.08)	26	PTL-17-479	1.000 x 0.500	(25.40 x 12.70)	28
PSPT-1000-175-WT	1.000 dia. x 1.765	(25.40 x 44.83)	36	PTL-9-457	0.650 x 0.200	(16.51 x 50.08)	26	PTL-17-483	1.000 x 0.500	(25.40 x 12.70)	28
PSPT-094-175-YL	0.094 dia. x 1.765	(2.39 x 44.83)	36	PTL-9-473	0.650 x 0.200	(16.51 x 50.08)	26	PTL-17-486	1.000 x 0.500	(25.40 x 12.70)	28
PSPT-125-175-YL	0.125 dia. x 1.765	(3.18 x 44.83)	36	PTL-9-477	0.650 x 0.200	(16.51 x 50.08)	26				

TLS 2200® / TLS PC Link™ Index by Part Number

TLS 2200 / TLS PC LINK INDEX BY PART NUMBER PORTABLE PRINTERS AND LABELS

Part Number	Size Inch (mm)	Specifications on Page	Part Number	Size Inch (mm)	Specifications on Page	Part Number	Size Inch (mm)	Specifications on Page
PTL-17-498	1.000 x 0.500 (25.40 x 12.70)	28	PTL-24-428-BK	1.130 x 0.500 (28.70 x 12.70)	29	PTL-30-427-GY	0.750 x 1.500 (19.05 x 38.10)	27
PTL-17-7546	1.000 x 0.500 (25.40 x 12.70)	28	- with Black Border			PTL-30-427-OR	0.750 x 1.500 (19.05 x 38.10)	27
PTL-17-7566	1.000 x 0.500 (25.40 x 12.70)	28	PTL-24-483-BK	1.130 x 0.500 (28.70 x 12.70)	29	PTL-30-427-PL	0.750 x 1.500 (19.05 x 38.10)	27
PTL-17-7576	1.000 x 0.500 (25.40 x 12.70)	28	- with Black Border			PTL-30-427-RD	0.750 x 1.500 (19.05 x 38.10)	27
PTL-18-427	0.750 x 1.000 (19.05 x 25.40)	27	PTL-24-486-BK	1.130 x 0.500 (28.70 x 12.70)	29	PTL-30-427-YL	0.750 x 1.500 (19.05 x 38.10)	27
PTL-18-427-YL	0.750 x 1.000 (19.05 x 25.40)	27	- with Black Border			PTL-30-428-CALI	1.500 x 0.750 (38.10 x 19.05)	43
PTL-18-498	0.750 x 1.000 (19.05 x 25.40)	27	PTL-25-423	1.250 x 0.250 (31.75 x 6.35)	30	PTL-30-428-INSP	1.500 x 0.750 (38.10 x 19.05)	43
PTL-18-499	0.750 x 1.000 (19.05 x 25.40)	27	PTL-25-426	1.250 x 0.250 (31.75 x 6.35)	30	PTL-30-428-TEST	1.500 x 0.750 (38.10 x 19.05)	43
PTL-19-422	1.000 x 1.000 (25.40 x 25.40)	28	PTL-25-457	1.250 x 0.250 (31.75 x 6.35)	30	PTL-30-435	1.500 x 0.750 (38.10 x 19.05)	31
PTL-19-423	1.000 x 1.000 (25.40 x 25.40)	28	PTL-25-477	1.250 x 0.250 (31.75 x 6.35)	30	PTL-30-459	1.500 x 0.750 (38.10 x 19.05)	31
PTL-19-427	1.000 x 1.000 (25.40 x 25.40)	28	PTL-25-478	1.250 x 0.250 (31.75 x 6.35)	30	PTL-30-483	1.500 x 0.750 (38.10 x 19.05)	31
PTL-19-427-BL	1.000 x 1.000 (25.40 x 25.40)	28	PTL-25-479	1.250 x 0.250 (31.75 x 6.35)	30	PTL-30-486	1.500 x 0.750 (38.10 x 19.05)	31
PTL-19-427-BR	1.000 x 1.000 (25.40 x 25.40)	28	PTL-25-495	1.250 x 0.250 (31.75 x 6.35)	30	PTL-30-489	1.500 x 0.750 (38.10 x 19.05)	31
PTL-19-427-GN	1.000 x 1.000 (25.40 x 25.40)	28	PTL-26-423	2.750 x 1.250 (69.85 x 31.75)	33	PTL-30-498	0.750 x 1.500 (19.05 x 38.10)	27
PTL-19-427-GY	1.000 x 1.000 (25.40 x 25.40)	28	PTL-26-428	2.750 x 1.250 (69.85 x 31.75)	33	PTL-30-499	0.750 x 1.500 (19.05 x 38.10)	27
PTL-19-427-OR	1.000 x 1.000 (25.40 x 25.40)	28	PTL-26-459	2.750 x 1.250 (69.85 x 31.75)	33	PTL-30-7566	1.500 x 0.750 (38.10 x 19.05)	31
PTL-19-427-PL	1.000 x 1.000 (25.40 x 25.40)	28	PTL-27-423	1.500 x 0.125 (38.10 x 3.18)	30	PTL-31-351	1.500 x 1.000 (38.10 x 25.40)	31
PTL-19-427-RD	1.000 x 1.000 (25.40 x 25.40)	28	PTL-27-426	1.500 x 0.125 (38.10 x 3.18)	30	PTL-31-352	1.500 x 1.000 (38.10 x 25.40)	31
PTL-19-427-YL	1.000 x 1.000 (25.40 x 25.40)	28	PTL-27-457	1.500 x 0.125 (38.10 x 3.18)	30	PTL-31-423	1.500 x 1.000 (38.10 x 25.40)	31
PTL-19-435	1.000 x 1.000 (25.40 x 25.40)	28	PTL-27-477	1.500 x 0.125 (38.10 x 3.18)	30	PTL-31-427	1.000 x 1.500 (25.40 x 38.10)	29
PTL-19-483	1.000 x 1.000 (25.40 x 25.40)	28	PTL-27-478	1.500 x 0.125 (38.10 x 3.18)	30	PTL-31-427-BL	1.000 x 1.500 (25.40 x 38.10)	29
PTL-19-486	1.000 x 1.000 (25.40 x 25.40)	28	PTL-27-479	1.500 x 0.125 (38.10 x 3.18)	30	PTL-31-427-BR	1.000 x 1.500 (25.40 x 38.10)	29
PTL-19-489	1.000 x 1.000 (25.40 x 25.40)	28	PTL-27-495	1.500 x 0.125 (38.10 x 3.18)	30	PTL-31-427-GN	1.000 x 1.500 (25.40 x 38.10)	29
PTL-19-498	1.000 x 1.000 (25.40 x 25.40)	28	PTL-28-423	1.500 x 0.125 (38.10 x 3.18)	30	PTL-31-427-GY	1.000 x 1.500 (25.40 x 38.10)	29
PTL-19-499	1.000 x 1.000 (25.40 x 25.40)	29	PTL-28-426	1.500 x 0.125 (38.10 x 3.18)	30	PTL-31-427-OR	1.000 x 1.500 (25.40 x 38.10)	29
PTL-19-642	1.000 x 1.000 (25.40 x 25.40)	29	PTL-28-427	0.250 x 1.500 (6.35 x 38.10)	24	PTL-31-427-PL	1.000 x 1.500 (25.40 x 38.10)	29
PTL-20-351	2.000 x 1.000 (50.80 x 25.40)	32	PTL-28-427-BL	0.250 x 1.500 (6.35 x 38.10)	24	PTL-31-427-RD	1.000 x 1.500 (25.40 x 38.10)	29
PTL-20-352	2.000 x 1.000 (50.80 x 25.40)	32	PTL-28-427-BR	0.250 x 1.500 (6.35 x 38.10)	24	PTL-31-427-YL	1.000 x 1.500 (25.40 x 38.10)	29
PTL-20-422	2.000 x 1.000 (50.80 x 25.40)	32	PTL-28-427-GN	0.250 x 1.500 (6.35 x 38.10)	24	PTL-31-435	1.500 x 1.000 (38.10 x 25.40)	31
PTL-20-423	2.000 x 1.000 (50.80 x 25.40)	32	PTL-28-427-GY	0.250 x 1.500 (6.35 x 38.10)	24	PTL-31-483	1.500 x 1.000 (38.10 x 25.40)	31
PTL-20-424	2.000 x 1.000 (50.80 x 25.40)	32	PTL-28-427-OR	0.250 x 1.500 (6.35 x 38.10)	24	PTL-31-486	1.500 x 1.000 (38.10 x 25.40)	31
PTL-20-428	2.000 x 1.000 (50.80 x 25.40)	32	PTL-28-427-PL	0.250 x 1.500 (6.35 x 38.10)	24	PTL-31-489	1.500 x 1.000 (38.10 x 25.40)	31
PTL-20-435	2.000 x 1.000 (50.80 x 25.40)	32	PTL-28-427-RD	0.250 x 1.500 (6.35 x 38.10)	24	PTL-31-498	1.000 x 1.500 (25.40 x 38.10)	29
PTL-20-459	2.000 x 1.000 (50.80 x 25.40)	32	PTL-28-427-YL	0.250 x 1.500 (6.35 x 38.10)	24	PTL-31-499	1.000 x 1.500 (25.40 x 38.10)	29
PTL-20-483	2.000 x 1.000 (50.80 x 25.40)	32	PTL-28-430	1.500 x 0.250 (38.10 x 6.35)	30	PTL-31-642	1.000 x 1.500 (25.40 x 38.10)	29
PTL-20-486	2.000 x 1.000 (50.80 x 25.40)	32	PTL-28-457	1.500 x 0.250 (38.10 x 6.35)	30	PTL-31-7546	1.000 x 1.500 (25.40 x 38.10)	29
PTL-20-489	2.000 x 1.000 (50.80 x 25.40)	33	PTL-28-473	1.500 x 0.250 (38.10 x 6.35)	30	PTL-31-7566	1.500 x 1.000 (38.10 x 25.40)	31
PTL-20-7546	2.000 x 1.000 (50.80 x 25.40)	33	PTL-28-477	1.500 x 0.250 (38.10 x 6.35)	30	PTL-31-7576	1.500 x 1.000 (38.10 x 25.40)	31
PTL-20-7566	2.000 x 1.000 (50.80 x 25.40)	33	PTL-28-478	1.500 x 0.250 (38.10 x 6.35)	30	PTL-32-422	1.500 x 1.500 (38.10 x 38.10)	31
PTL-20-7576	2.000 x 1.000 (50.80 x 25.40)	33	PTL-28-479	1.500 x 0.250 (38.10 x 6.35)	30	PTL-32-423	1.500 x 1.500 (38.10 x 38.10)	31
PTL-21-427	1.000 x 2.500 (25.40 x 63.50)	29	PTL-28-495	1.500 x 0.250 (38.10 x 6.35)	30	PTL-32-427	1.500 x 1.500 (38.10 x 38.10)	31
PTL-21-427-BL	1.000 x 2.500 (25.40 x 63.50)	29	PTL-28-498	0.250 x 1.500 (6.35 x 38.10)	24	PTL-32-427-BL	1.500 x 1.500 (38.10 x 38.10)	31
PTL-21-427-BR	1.000 x 2.500 (25.40 x 63.50)	29	PTL-28-499	0.250 x 1.500 (6.35 x 38.10)	24	PTL-32-427-BR	1.500 x 1.500 (38.10 x 38.10)	31
PTL-21-427-GN	1.000 x 2.500 (25.40 x 63.50)	29	PTL-29-422	1.500 x 0.500 (38.10 x 12.70)	30	PTL-32-427-GN	1.500 x 1.500 (38.10 x 38.10)	31
PTL-21-427-GY	1.000 x 2.500 (25.40 x 63.50)	29	PTL-29-423	1.500 x 0.500 (38.10 x 12.70)	30	PTL-32-427-GY	1.500 x 1.500 (38.10 x 38.10)	31
PTL-21-427-OR	1.000 x 2.500 (25.40 x 63.50)	29	PTL-29-427	0.500 x 1.500 (12.70 x 38.10)	25	PTL-32-427-OR	1.500 x 1.500 (38.10 x 38.10)	31
PTL-21-427-PL	1.000 x 2.500 (25.40 x 63.50)	29	PTL-29-427-BL	0.500 x 1.500 (12.70 x 38.10)	25	PTL-32-427-PL	1.500 x 1.500 (38.10 x 38.10)	31
PTL-21-427-RD	1.000 x 2.500 (25.40 x 63.50)	29	PTL-29-427-BR	0.500 x 1.500 (12.70 x 38.10)	25	PTL-32-427-RD	1.500 x 1.500 (38.10 x 38.10)	31
PTL-21-427-YL	1.000 x 2.500 (25.40 x 63.50)	29	PTL-29-427-GN	0.500 x 1.500 (12.70 x 38.10)	25	PTL-32-427-YL	1.500 x 1.500 (38.10 x 38.10)	31
PTL-21-498	1.000 x 2.500 (25.40 x 63.50)	29	PTL-29-427-GY	0.500 x 1.500 (12.70 x 38.10)	25	PTL-32-435	1.500 x 1.500 (38.10 x 38.10)	31
PTL-21-499	1.000 x 2.500 (25.40 x 63.50)	29	PTL-29-427-OR	0.500 x 1.500 (12.70 x 38.10)	25	PTL-32-483	1.500 x 1.500 (38.10 x 38.10)	31
PTL-21-642	1.000 x 2.500 (25.40 x 63.50)	29	PTL-29-427-PL	0.500 x 1.500 (12.70 x 38.10)	25	PTL-32-486	1.500 x 1.500 (38.10 x 38.10)	31
PTL-22-422	3.000 x 1.000 (76.20 x 25.40)	33	PTL-29-427-RD	0.500 x 1.500 (12.70 x 38.10)	25	PTL-32-489	1.500 x 1.500 (38.10 x 38.10)	31
PTL-22-423	3.000 x 1.000 (76.20 x 25.40)	33	PTL-29-427-YL	0.500 x 1.500 (12.70 x 38.10)	25	PTL-32-498	1.500 x 1.500 (38.10 x 38.10)	31
PTL-22-424	3.000 x 1.000 (76.20 x 25.40)	33	PTL-29-428	1.500 x 0.500 (38.10 x 12.70)	30	PTL-33-427	1.500 x 4.000 (38.10 x 101.60)	31
PTL-22-428	3.000 x 1.000 (76.20 x 25.40)	33	PTL-29-430	1.500 x 0.500 (38.10 x 12.70)	30	PTL-33-427-BL	1.500 x 4.000 (38.10 x 101.60)	31
PTL-22-459	3.000 x 1.000 (76.20 x 25.40)	33	PTL-29-435	1.500 x 0.500 (38.10 x 12.70)	30	PTL-33-427-BR	1.500 x 4.000 (38.10 x 101.60)	31
PTL-23-422	4.000 x 1.000 (101.60 x 25.40)	34	PTL-29-437	1.500 x 0.500 (38.10 x 12.70)	30	PTL-33-427-GN	1.500 x 4.000 (38.10 x 101.60)	31
PTL-23-423	4.000 x 1.000 (101.60 x 25.40)	34	PTL-29-459	1.500 x 0.500 (38.10 x 12.70)	30	PTL-33-427-GY	1.500 x 4.000 (38.10 x 101.60)	31
PTL-23-427	1.000 x 4.000 (25.40 x 101.60)	29	PTL-29-483	1.500 x 0.500 (38.10 x 12.70)	30	PTL-33-427-OR	1.500 x 4.000 (38.10 x 101.60)	31
PTL-23-427-BL	1.000 x 4.000 (25.40 x 101.60)	29	PTL-29-486	1.500 x 0.500 (38.10 x 12.70)	30	PTL-33-427-PL	1.500 x 4.000 (38.10 x 101.60)	31
PTL-23-427-BR	1.000 x 4.000 (25.40 x 101.60)	29	PTL-29-489	1.500 x 0.500 (38.10 x 12.70)	30	PTL-33-427-RD	1.500 x 4.000 (38.10 x 101.60)	31
PTL-23-427-GN	1.000 x 4.000 (25.40 x 101.60)	29	PTL-29-498	1.500 x 0.500 (38.10 x 12.70)	30	PTL-33-427-YL	1.500 x 4.000 (38.10 x 101.60)	31
PTL-23-427-GY	1.000 x 4.000 (25.40 x 101.60)	29	PTL-29-499	0.500 x 1.500 (12.70 x 38.10)	36	PTL-33-498	1.500 x 4.000 (38.10 x 101.60)	31
PTL-23-427-OR	1.000 x 4.000 (25.40 x 101.60)	29	PTL-30-422	1.500 x 0.750 (38.10 x 19.05)	41	PTL-34-427	1.500 x 6.000 (38.10 x 152.40)	31
PTL-23-427-PL	1.000 x 4.000 (25.40 x 101.60)	29	PTL-30-423-CALI	1.500 x 0.750 (38.10 x 19.05)	43	PTL-34-427-BL	1.500 x 6.000 (38.10 x 152.40)	31
PTL-23-427-RD	1.000 x 4.000 (25.40 x 101.60)	29	PTL-30-423-INSP	1.500 x 0.750 (38.10 x 19.05)	43	PTL-34-427-BR	1.500 x 6.000 (38.10 x 152.40)	31
PTL-23-427-YL	1.000 x 4.000 (25.40 x 101.60)	29	PTL-30-423-TEST	1.500 x 0.750 (38.10 x 19.05)	43	PTL-34-427-GN	1.500 x 6.000 (38.10 x 152.40)	31
PTL-23-483	1.000 x 4.000 (25.40 x 101.60)	34	PTL-30-427	0.750 x 1.500 (19.05 x 38.10)	27	PTL-34-427-GY	1.500 x 6.000 (38.10 x 152.40)	31
PTL-23-498	1.000 x 4.000 (25.40 x 101.60)	29	PTL-30-427-AW	1.500 x 0.750 (38.10 x 19.05)	27	PTL-34-427-OR	1.500 x 6.000 (38.10 x 152.40)	31
PTL-23-499	4.000 x 1.000 (101.60 x 25.40)	34	PTL-30-427-BL	0.750 x 1.500 (19.05 x 38.10)	27	PTL-34-427-PL	1.500 x 6.000 (38.10 x 152.40)	31
PTL-24-423-BK	1.130 x 0.500 (28.70 x 12.70)	29	PTL-30-427-BR	0.750 x 1.500 (19.05 x 38.10)	27	PTL-34-427-RD	1.500 x 6.000 (38.10 x 152.40)	31
- with Black Border			PTL-30-427-GN	0.750 x 1.500 (19.05 x 38.10)	27			

TLS 2200® / TLS PC Link™ Index by Part Number

Part Number	Size Inch (mm)	Specifications on Page	Part Number	Size Inch (mm)	Specifications on Page	Part Number	Size Inch (mm)	Specifications on Page
PTL-34-427-YL	1.500 x 6.000 (38.10 x 152.40)	31	PTL-68-430	0.240 x 0.150 (6.00 x 4.00)	24	PTS-095-350-321	0.950 x 0.350 (24.13 x 8.89)	37
PTL-34-498	1.500 x 6.000 (38.10 x 152.40)	31	PTL-69-430	0.350 x 0.150 (9.00 x 4.00)	24	PTS-095-500-321	0.950 x 0.500 (24.13 x 12.70)	37
PTL-35-422-PROP	1.630 x 0.750 (41.40 x 19.05)	43	PTL-70-430	0.240 x 0.200 (6.00 x 5.00)	24	PTS-095-750-321	0.950 x 0.750 (24.13 x 19.05)	37
PTL-35-423-PROP	1.630 x 0.750 (41.40 x 19.05)	43	PTL-71-430	0.350 x 0.200 (9.00 x 5.00)	24	PTS-095-1000-321	0.950 x 1.000 (24.13 x 25.40)	37
PTL-35-428-PROP	1.630 x 0.750 (41.40 x 19.05)	43	PTL-72-461	1.800 x 0.500 (45.72 x 12.70)	32	PTS-190-350-321	1.900 x 0.350 (48.26 x 8.89)	37
PTL-35-435-PROP	1.630 x 0.750 (41.40 x 19.05)	43	PTL-73-461	1.800 x 0.375 (45.72 x 9.53)	32	PTS-190-500-321	1.900 x 0.500 (48.26 x 12.70)	37
PTL-36-109	1.750 x 1.125 (44.45 x 28.57)	32	PTL-74-427	2.200 x 0.500 (55.88 x 12.70)	33	PTS-190-750-321	1.900 x 0.750 (48.26 x 19.05)	37
PTL-37-351	3.000 x 1.900 (76.20 x 48.26)	33	PTL-74-461	2.200 x 0.500 (55.88 x 12.70)	33	PTS-190-1000-321	1.900 x 1.000 (48.26 x 25.40)	37
PTL-37-352	3.000 x 1.900 (76.20 x 48.26)	33	PTL-75-427	2.625 x 1.000 (66.68 x 25.40)	33			
PTL-37-422	3.000 x 1.900 (76.20 x 48.26)	33	PTL-75-461	2.625 x 1.000 (66.68 x 25.40)	33			
PTL-37-423	3.000 x 1.900 (76.20 x 48.26)	33	PTL-75-461-YL	2.625 x 1.000 (66.68 x 25.40)	33			
PTL-37-424	3.000 x 1.900 (76.20 x 48.26)	33	PTL-76-461	1.625 x 0.600 (41.28 x 15.24)	31			
PTL-37-428	3.000 x 1.900 (76.20 x 48.26)	33	PTL-76-490	1.625 x 0.600 (41.28 x 15.24)	31			
PTL-37-435	3.000 x 1.900 (76.20 x 48.26)	33	PTL-77-461	3.500 x 1.500 (88.90 x 38.10)	33			
PTL-37-459	3.000 x 1.900 (76.20 x 48.26)	33	PTL-78-427-AW	1.900 x 1.000 (48.26 x 25.40)	32			
PTL-37-483	3.000 x 1.900 (76.20 x 48.26)	33	PTL-78-488	1.900 x 1.000 (48.26 x 25.40)	32			
PTL-37-486	3.000 x 1.900 (76.20 x 48.26)	33	PTL-78-490	1.900 x 1.000 (48.26 x 25.40)	32			
PTL-37-489	3.000 x 1.900 (76.20 x 48.26)	33	PTL-78-499	1.900 x 1.000 (48.26 x 25.40)	32			
PTL-37-7546	3.000 x 1.900 (76.20 x 48.26)	33	PTL-79-461	3.750 x 0.750 (95.25 x 19.05)	33			
PTL-37-7566	3.000 x 1.900 (76.20 x 48.26)	33	PTL-80-424	0.750 x 0.900 (19.05 x 22.86)	27			
PTL-37-7576	3.000 x 1.900 (76.20 x 48.26)	33	PTL-80-488	0.750 x 0.900 (19.05 x 22.86)	27			
PTL-38-422	4.000 x 1.900 (101.60 x 48.26)	34	PTL-81-488	1.900 x 0.250 (48.26 x 6.35)	32			
PTL-38-423	4.000 x 1.900 (101.60 x 48.26)	34	PTL-81-499	1.900 x 0.250 (48.26 x 6.35)	32			
PTL-38-424	4.000 x 1.900 (101.60 x 48.26)	34	PTL-82-499	0.375 (9.53) diameter	24			
PTL-38-428	4.000 x 1.900 (101.60 x 48.26)	34	PTL-82-499-YL	0.375 (9.53) diameter	24			
PTL-38-435	4.000 x 1.900 (101.60 x 48.26)	34	PTL-83-499	0.500 (12.70) diameter	25			
PTL-38-459	4.000 x 1.900 (101.60 x 48.26)	34	PTL-83-499-YL	0.500 (12.70) diameter	25			
PTL-38-483	4.000 x 1.900 (101.60 x 48.26)	34	PTL-84-499	0.900 x 0.500 (22.86 x 12.70)	27			
PTL-38-486	4.000 x 1.900 (101.60 x 48.26)	34	PTL-85-430	0.740 x 0.240 (19.00 x 6.00)	26			
PTL-38-489	4.000 x 1.900 (101.60 x 48.26)	34	PTL-86-461	0.600 x 2.625 (15.24 x 66.66)	26			
PTL-39-422	0.375 x 0.600 (9.53 x 15.24)	25	PTL-87-427	1.750 x 1.000 (44.45 x 25.40)	32			
PTL-39-430	0.375 x 0.600 (9.53 x 15.24)	25	PTL-88-427	1.750 x 1.500 (44.45 x 38.10)	32			
PTL-40-412	1.938 x 0.375 (49.23 x 9.53)	32	PTL-96-427	1.000 x 0.750 (25.40 x 19.05)	28			
PTL-42-422	1.000 x 50 ft (25.40 x 15.24 m)	29	PTL-99-430	0.740 x 0.320 (19.00 x 8.00)	26			
PTL-42-430	1.000 x 50 ft (25.40 x 15.24 m)	29	PTL-100-432	1.300 x 50 ft (33.02 x 15.24 m)	30			
PTL-42-432	1.000 x 50 ft (25.40 x 15.24 m)	29	PTL-100-483	1.300 x 50 ft (33.02 x 15.24 m)	30			
PTL-42-439	1.000 x 50 ft (25.40 x 15.24 m)	29	PTL-100-489	1.300 x 50 ft (33.02 x 15.24 m)	30			
PTL-42-439-BK	1.000 x 50 ft (25.40 x 15.24 m)	29	PTL-101-432	0.250 x 50 ft (6.35 x 15.24 m)	24			
PTL-42-439-BL	1.000 x 50 ft (25.40 x 15.24 m)	29	PTL-101-483	0.250 x 50 ft (6.35 x 15.24 m)	24			
PTL-42-439-GR	1.000 x 50 ft (25.40 x 15.24 m)	29	PTL-101-489	0.250 x 50 ft (6.35 x 15.24 m)	24			
PTL-42-439-OR	1.000 x 50 ft (25.40 x 15.24 m)	29	PTL-102-427	0.500 x 1.250 (12.70 x 31.75)	25			
PTL-42-439-RD	1.000 x 50 ft (25.40 x 15.24 m)	29	PTL-103-427	1.000 x 1.250 (25.40 x 31.75)	29			
PTL-42-439-YL	1.000 x 50 ft (25.40 x 15.24 m)	29	PTL-104-427	1.500 x 1.000 (38.10 x 25.40)	31			
PTL-42-483	1.000 x 50 ft (25.40 x 15.24 m)	29	PTL-105-427-AW	1.100 x 0.250 (27.94 x 6.35)	29			
PTL-42-489	1.000 x 50 ft (25.40 x 15.24 m)	29	PTL-106-427	1.500 x 50 ft (38.10 x 15.24 m)	31			
PTL-43-422	1.900 x 50 ft (48.26 x 15.24 m)	32	PTL-107-427	2.000 x 1.500 (50.80 x 38.10)	33			
PTL-43-430	1.900 x 50 ft (48.26 x 15.24 m)	32	PTL-108-461	1.500 x 0.187 (38.10 x 4.75)	30			
PTL-43-432	1.900 x 50 ft (48.26 x 15.24 m)	32	PTL-109-427	1.500 x 4.000 (38.10 x 101.60)	31			
PTL-43-439	1.900 x 50 ft (48.26 x 15.24 m)	32	PTL-110-145-GY	1.750 x 1.000 (44.45 x 25.40)	32			
PTL-43-439-BK	1.900 x 50 ft (48.26 x 15.24 m)	32	PTL-111-145-GY	0.758 x 1.206 (19.25 x 30.63)	29			
PTL-43-439-BL	1.900 x 50 ft (48.26 x 15.24 m)	32	PTL-112-490	1.250 x 0.375 (31.75 x 9.53)	30			
PTL-43-439-GR	1.900 x 50 ft (48.26 x 15.24 m)	32	PTL-113-490	2.200 x 1.500 (55.88 x 38.10)	33			
PTL-43-439-OR	1.900 x 50 ft (48.26 x 15.24 m)	32	PTL-114-490	3.875 x 1.500 (98.43 x 38.10)	34			
PTL-43-439-RD	1.900 x 50 ft (48.26 x 15.24 m)	32	PTL-117-499	0.900 x 0.500 (22.86 x 12.70)	27			
PTL-43-439-YL	1.900 x 50 ft (48.26 x 15.24 m)	32	PTLCM-41-437-WT	1.500 x 50 ft (38.10 x 15.24 m)	31			
PTL-43-483	1.900 x 50 ft (48.26 x 15.24 m)	32	PTLCM-41-437-YL	1.500 x 50 ft (38.10 x 15.24 m)	31			
PTL-43-489	1.900 x 50 ft (48.26 x 15.24 m)	32	PTLFP-1-8425	1.181 x 0.788 (30.00 x 20.00)	29			
PTL-44-422	0.500 x 0.375 (12.70 x 9.53)	25	PTLFT-1-8425	1.181 x 0.788 (30.00 x 20.00)	29			
PTL-44-430	0.500 x 0.375 (12.70 x 9.53)	25	PTLSL-17-473	1.000 x 0.500 (25.40 x 12.70)	43			
PTL-45-422	1.500 x 0.375 (38.10 x 9.53)	30	PTLTB-498-240	0.240 x 30 ft (6.10 x 91.0 m)	24			
PTL-45-430	1.500 x 0.375 (38.10 x 9.53)	30	PTLTB-498-318	0.318 x 30 ft (8.07 x 91.0 m)	24			
PTL-46-422	0.375 x 50 ft (9.53 x 15.24 m)	25	PTLTB-498-375	0.375 x 30 ft (9.53 x 91.0 m)	25			
PTL-46-430	0.375 x 50 ft (9.53 x 15.24 m)	25	PTPSL-17-422	1.000 x 0.500 (25.40 x 12.70)	43			
PTL-55-412	0.230 x 50 ft (5.84 x 15.24 m)	24	PTPSL-17-424	1.000 x 0.500 (25.40 x 12.70)	43			
PTL-56-412	0.375 x 50 ft (9.53 x 15.24 m)	25	PTPSL-17-428	1.000 x 0.500 (25.40 x 12.70)	43			
PTL-57-412	0.500 x 50 ft (12.70 x 15.24 m)	26	PTPSL-20-422	2.000 x 1.000 (50.80 x 25.40)	43			
PTL-58-412	0.535 x 50 ft (13.59 x 15.24 m)	26	PTPSL-20-424	2.000 x 1.000 (50.80 x 25.40)	43			
PTL-59-412	0.785 x 50 ft (19.94 x 15.24 m)	27	PTPSL-20-428	2.000 x 1.000 (50.80 x 25.40)	43			
PTL-61-483	0.500 x 2.000 (12.70 x 50.80)	26	PTPSL-26-422	2.750 x 1.250 (69.85 x 31.75)	43			
PTL-62-483	0.750 x 4.000 (19.05 x 101.60)	27	PTPSL-26-428	2.750 x 1.250 (69.85 x 31.75)	43			
PTL-63-483	0.750 x 8.000 (19.05 x 203.20)	27	PTPSL-50-422	3.000 x 1.650 (76.20 x 41.91)	43			
PTL-64-427	1.000 x 3.375 (25.40 x 85.73)	29	PTPSL-50-428	3.000 x 1.650 (76.20 x 41.91)	43			
PTL-65-483	1.375 x 1.000 (34.93 x 25.40)	30	PTS-045-350-321	0.450 x 0.350 (11.43 x 8.89)	37			
PTL-66-427	1.940 x 3.150 (49.23 x 80.00)	32	PTS-045-500-321	0.450 x 0.500 (11.43 x 12.70)	37			

PORTABLE PRINTERS AND LABELS TLS 2200 / TLS PC LINK INDEX BY PART NUMBER

TLS 2200® / TLS PC Link™ Label Index by Size



PTL-55-412
 TLS 2200 technology
 Die # 55, 0.230" x 50 ft
 Material B-412, White Polypropylene

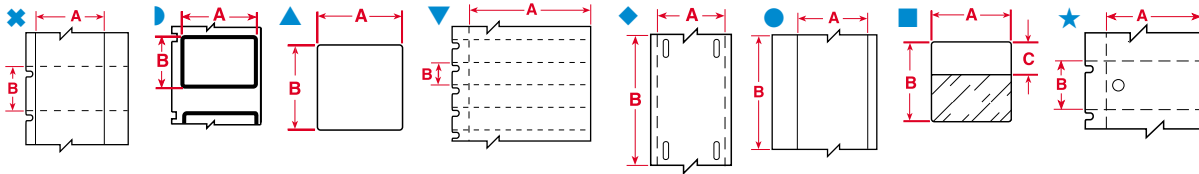

Diagram	Part Number	Pieces Per Package	Material	Color	Label Width A Inch (mm)	Label Height B Inch (mm)	Write-On Height C Inch (mm)	Maximum Characters Per Line For Font: 2	Maximum Lines Of Text For Font: 2
0.230" Label Width									
●	PTL-55-412	1	Polypropylene	White	0.230 (5.84)	50 ft (15.24 m)		4	N/A
0.240" Label Width									
●	PTL-68-430	750	Polyester	Clear	0.240 (6.10)	0.150 (3.81)		4	2
●	PTL-70-430	750	Polyester	Clear	0.240 (6.10)	0.150 (3.81)		4	2
●	PTLTB-498-240	1	Vinyl Cloth	White	0.240 (6.10)	30 ft (9.10 m)		4	N/A
●	BPTLTB-498-240	1	Vinyl Cloth	White	0.240 (6.10)	300 ft (91.44 m)		4	N/A
0.250" Label Width									
▲	PTL-1-423	750	Polyester	White	0.250 (6.35)	0.250 (6.35)		5	2
▲	PTL-1-426	750	Polyimide	Amber	0.250 (6.35)	0.250 (6.35)		5	2
▲	PTL-1-457	750	Polyimide	White	0.250 (6.35)	0.250 (6.35)		5	2
▲	PTL-1-473	750	Polyester	White	0.250 (6.35)	0.250 (6.35)		5	2
▲	PTL-1-477	750	Polyimide	White	0.250 (6.35)	0.250 (6.35)		5	2
▲	PTL-1-478	750	Polyimide	White	0.250 (6.35)	0.250 (6.35)		5	2
▲	PTL-1-479	750	Polyimide	White	0.250 (6.35)	0.250 (6.35)		5	2
▲	PTL-1-495	750	PEN	White	0.250 (6.35)	0.250 (6.35)		5	2
■	PTL-10-427*	750	Self-laminating Vinyl	Translucent	0.250 (6.35)	0.750 (19.05)	0.375 (9.53)	5	3
▲	PTL-10-498	750	Vinyl Cloth	White	0.250 (6.35)	0.750 (19.05)		5	8
■	PTL-28-427**	750	Self-laminating Vinyl	Translucent	0.250 (6.35)	1.500 (38.10)	0.50 (12.70)	5	5
▲	PTL-28-498	750	Vinyl Cloth	White	0.250 (6.35)	1.500 (38.10)		5	16
▲	PTL-28-499	750	Nylon Cloth	White	0.250 (6.35)	1.500 (38.10)		5	16
●	PTL-101-432	1	Polyester	Clear	0.250 (6.35)	50 ft (15.24 m)		50	2
●	PTL-101-483	1	Polyester	White	0.250 (6.35)	50 ft (15.24 m)		50	2
●	PTL-101-489	1	Polyester	White	0.250 (6.35)	50 ft (15.24 m)		50	2
0.318" Label Width									
●	PTLTB-498-318	1	Vinyl Cloth	White	0.318 (8.08)	30 ft (9.10 m)		7	N/A
●	BPTLTB-498-318	1	Vinyl Cloth	White	0.318 (8.08)	300 ft (91.44 m)		7	N/A
0.350" Label Width									
●	PTL-69-430	750	Polyester	Clear	0.350 (8.89)	0.150 (3.81)		7	2
●	PTL-71-430	500	Polyester	Clear	0.350 (8.89)	0.200 (5.08)		7	2
0.375" Label Width									
	PTL-82-499	500	Nylon Cloth	White	0.375 (9.53) diameter			8	3
	PTL-82-499-YL	500	Nylon Cloth	White	0.375 (9.53) diameter			8	3
▲	PTL-3-423	500	Polyester	White	0.375 (9.53)	0.375 (9.53)		8	3
▲	PTL-3-426	500	Polyimide	Amber	0.375 (9.53)	0.375 (9.53)		8	3
▲	PTL-3-457	500	Polyimide	White	0.375 (9.53)	0.375 (9.53)		8	3

Any label two inches or larger in width is rotated on liner.

Note: Labels in chart are sorted in order by width, height, 3 digit material number (within part number), then die number (within part number).

* Also available in: YL=Yellow

**Also available in: BL=blue, BR=brown, GN=green, GY=grey, OR=orange, PL=purple, RD=red, YL=yellow.

To order a color, add a dash "-" after the material number, then add the color suffix.

Standard product: Contact your Brady Identification Solutions distributor or Customer Service representative for ordering information.

TLS 2200 / TLS PC LINK LABEL INDEX BY SIZE PORTABLE PRINTERS AND LABELS

TLS 2200® / TLS PC Link™ Label Index by Size

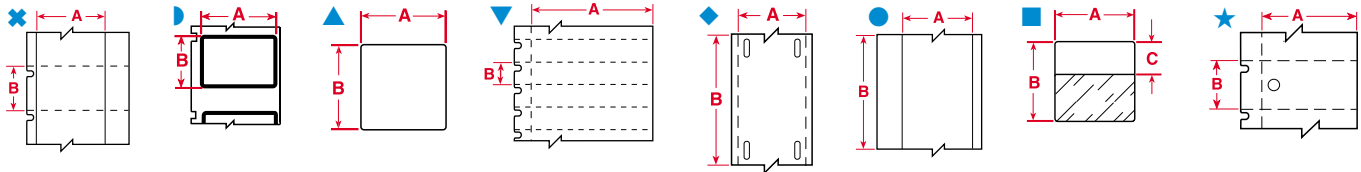

Diagram	Part Number	Pieces Per Package	Material	Color	Label Width A Inch (mm)	Label Height B Inch (mm)	Write-On Height C Inch (mm)	Maximum Characters Per Line For Font: 2	Maximum Lines Of Text For Font: 2
0.375" Label Width (continued)									
▲	PTL-3-477	500	Polyimide	White	0.375 (9.53)	0.375 (9.53)		8	3
▲	PTL-3-478	500	Polyimide	White	0.375 (9.53)	0.375 (9.53)		8	3
▲	PTL-3-479	500	Polyimide	White	0.375 (9.53)	0.375 (9.53)		8	3
▲	PTL-3-495	500	Polyimide	White	0.375 (9.53)	0.375 (9.53)		8	3
✱	PTL-39-422	750	Polyester	White	0.375 (9.53)	0.600 (15.24)		8	6
✱	PTL-39-430	750	Polyester	Clear	0.375 (9.53)	0.600 (15.24)		8	6
▲	PTL-16-498	500	Vinyl Cloth	White	0.375 (9.53)	1.000 (25.40)		8	10
▲	PTL-16-499	500	Nylon Cloth	White	0.375 (9.53)	1.000 (25.40)		8	10
●	PTL-46-422	1	Polyester	White	0.375 (9.53)	50 ft (15.24 m)		50	3
●	PTL-46-430	1	Polyester	Clear	0.375 (9.53)	50 ft (15.24 m)		50	3
●	PTL-56-412	1	Polypropylene	White	0.375 (9.53)	50 ft (15.24 m)		50	3
●	PTLTB-498-375	1	Vinyl Cloth	White	0.375 (9.53)	30 ft (9.10 m)		8	N/A
●	BPTLTB-498-375	1	Vinyl Cloth	White	0.375 (9.53)	300 ft (91.44 m)		8	N/A
0.400" Label Width									
▲	PTL-4-423	500	Polyester	White	0.400 (10.16)	0.400 (10.16)		9	4
▲	PTL-4-426	500	Polyimide	Amber	0.400 (10.16)	0.400 (10.16)		9	4
▲	PTL-4-457	500	Polyimide	White	0.400 (10.16)	0.400 (10.16)		9	4
▲	PTL-4-478	500	Polyimide	White	0.400 (10.16)	0.400 (10.16)		9	4
▲	PTL-4-479	500	Polyimide	White	0.400 (10.16)	0.400 (10.16)		9	4
▲	PTL-4-495	500	PEN	White	0.400 (10.16)	0.400 (10.16)		9	4
0.500" Label Width									
	PTL-83-499	500	Nylon Cloth	White	0.500 (12.70)	diameter		11	1
	PTL-83-499-YL	500	Nylon Cloth	White	0.500 (12.70)	diameter		11	1
▲	PTL-5-422	750	Polyester	White	0.500 (12.70)	0.200 (5.08)		11	1
▲	PTL-5-423	750	Polyester	White	0.500 (12.70)	0.200 (5.08)		11	1
▲	PTL-5-473	750	Polyester	White	0.500 (12.70)	0.200 (5.08)		11	1
▲	PTL-6-423	750	Polyester	White	0.500 (12.70)	0.275 (6.98)		11	2
▲	PTL-6-426	750	Polyimide	Amber	0.500 (12.70)	0.275 (6.98)		11	2
▲	PTL-6-430	750	Polyester	Clear	0.500 (12.70)	0.275 (6.98)		11	2
▲	PTL-6-457	750	Polyimide	White	0.500 (12.70)	0.275 (6.98)		11	2
▲	PTL-6-473	750	Polyester	White	0.500 (12.70)	0.275 (6.98)		11	2
▲	PTL-6-478	750	Polyimide	White	0.500 (12.70)	0.275 (6.98)		11	2
▲	PTL-6-479	750	Polyimide	White	0.500 (12.70)	0.275 (6.98)		11	2
▲	PTL-6-495	750	PEN	White	0.500 (12.70)	0.275 (6.98)		11	2
▲	PTL-44-422	500	Polyester	White	0.500 (12.70)	0.375 (9.53)		11	3
▲	PTL-44-430	500	Polyester	Clear	0.500 (12.70)	0.375 (9.53)		11	3
▲	PTL-44-432	500	Polyester	Clear	0.500 (12.70)	0.500 (12.70)		11	5
▲	PTL-7-422	500	Polyester	White	0.500 (12.70)	0.500 (12.70)		11	5
▲	PTL-7-423	500	Polyester	White	0.500 (12.70)	0.500 (12.70)		11	5
▲	BPTL-7-423	5000	Polyester	White	0.500 (12.70)	0.500 (12.70)		11	5
▲	PTL-7-430	500	Polyester	Clear	0.500 (12.70)	0.500 (12.70)		11	5
▲	PTL-7-498	500	Vinyl Cloth	White	0.500 (12.70)	0.500 (12.70)		11	5
▲	PTL-7-499	500	Nylon Cloth	White	0.500 (12.70)	0.500 (12.70)		11	5
■	BPTL-11-427	5000	Self-laminating Vinyl	Translucent	0.500 (12.70)	0.750 (19.05)	0.375 (9.53)	11	3
▲	BPTL-11-498	5000	Vinyl Cloth	White	0.500 (12.70)	0.750 (19.05)		11	8
▲	BPTL-11-499	5000	Nylon Cloth	White	0.500 (12.70)	0.750 (19.05)		11	8
■	PTL-17-427*	500	Self-laminating Vinyl	Translucent	0.500 (12.70)	1.000 (25.40)	0.375 (9.53)	11	3
■	BPTL-17-427	5000	Self-laminating Vinyl	Translucent	0.500 (12.70)	1.000 (25.40)	0.375 (9.53)	11	3
■	PTL-102-427	250	Self-laminating Vinyl	Translucent	0.500 (12.70)	1.250 (31.75)	0.375 (9.53)	11	3
■	PTL-29-427**	500	Self-laminating Vinyl	Translucent	0.500 (12.70)	1.500 (38.10)	0.500 (12.70)	11	5
■	BPTL-29-427	5000	Self-laminating Vinyl	Translucent	0.500 (12.70)	1.500 (38.10)	0.500 (12.70)	11	5

Any label two inches or larger in width is rotated on liner.

Note: Labels in chart are sorted in order by width, height, 3 digit material number (within part number), then die number (within part number).

* Also available in: YL=Yellow

** Also available in: BL=blue, BR=brown, GN=green, GY=grey, OR=orange, PL=purple, RD=red, YL=yellow.

To order a color, add a dash "-" after the material number, then add the color suffix. Standard product: Contact your Brady Identification Solutions distributor or Customer Service representative for ordering information.

TLS 2200® / TLS PC Link™ Label Index by Size

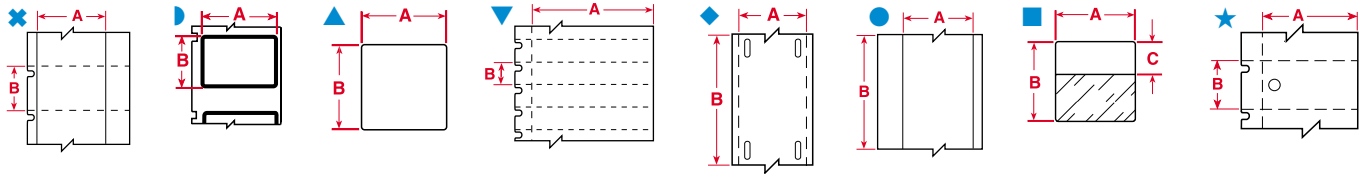

TLS 2200 / TLS PC LINK LABEL INDEX BY SIZE PORTABLE PRINTERS AND LABELS

Diagram	Part Number	Pieces Per Package	Material	Color	Label Width A Inch (mm)	Label Height B Inch (mm)	Write-On Height C Inch (mm)	Maximum Characters Per Line For Font: 2	Maximum Lines Of Text For Font: 2
0.500" Label Width (continued)									
▲	BPTL-29-498	5000	Vinyl Cloth	White	0.500 (12.70)	1.500 (38.10)		11	16
▲	PTL-29-499	500	Nylon Cloth	White	0.500 (12.70)	1.500 (38.10)		11	16
▲	PTL-61-483	100	Polyester	White	0.500 (12.70)	2.000 (50.80)		50	5
●	PTL-8-498	1	Vinyl Cloth	White	0.500 (12.70)	30 ft (9.10 m)		50	5
●	PTL-8-422	1	Polyester	White	0.500 (12.70)	50 ft (15.24 m)		50	5
●	PTL-8-423	1	Polyester	White	0.500 (12.70)	50 ft (15.24 m)		50	5
●	PTL-8-428	1	Metallized Polyester	Silver	0.500 (12.70)	50 ft (15.24 m)		5	5
●	PTL-8-430	1	Polyester	Clear	0.500 (12.70)	50 ft (15.24 m)		50	5
●	PTL-8-432	1	Polyester	Clear	0.500 (12.70)	50 ft (15.24 m)		50	5
●	PTL-8-439	1	Vinyl	White	0.500 (12.70)	50 ft (15.24 m)		50	5
●	PTL-8-439-BK	1	Vinyl	Black	0.500 (12.70)	50 ft (15.24 m)		50	5
●	PTL-8-439-BL	1	Vinyl	Blue	0.500 (12.70)	50 ft (15.24 m)		50	5
●	PTL-8-439-GN	1	Vinyl	Green	0.500 (12.70)	50 ft (15.24 m)		50	5
●	PTL-8-439-OR	1	Vinyl	Orange	0.500 (12.70)	50 ft (15.24 m)		50	5
●	PTL-8-439-RD	1	Vinyl	Red	0.500 (12.70)	50 ft (15.24 m)		50	51
●	PTL-8-439-YL	1	Vinyl	Yellow	0.500 (12.70)	50 ft (15.24 m)		50	5
●	PTL-57-412	1	Polypropylene	White	0.500 (12.70)	50 ft (15.24 m)		50	5
0.530" Label Width									
▲	PTL-69-430	750	Polyester	Clear	0.530 (13.46)	0.150 (3.81)		11	2
0.535" Label Width									
●	PTL-58-412	1	Polypropylene	White	0.535 (13.59)	50 ft (15.24 m)		50	5
0.600" Label Width									
●	PTL-86-461	100	Polyester	White	0.600 (15.24)	2.625 (66.66)		13	2
0.650" Label Width									
▲	PTL-9-423	750	Polyester	White	0.650 (16.51)	0.200 (5.08)		15	1
▲	PTL-9-426	750	Polyimide	Amber	0.650 (16.51)	0.200 (5.08)		15	1
▲	PTL-9-437	750	Tedlar®	White	0.650 (16.51)	0.200 (5.08)		15	1
▲	PTL-9-457	750	Polyimide	White	0.650 (16.51)	0.200 (5.08)		15	1
▲	PTL-9-473	750	Polyester	White	0.650 (16.51)	0.200 (5.08)		15	1
▲	PTL-9-477	750	Polyimide	White	0.650 (16.51)	0.200 (5.08)		15	1
▲	PTL-9-478	750	Polyimide	White	0.650 (16.51)	0.200 (5.08)		15	1
▲	PTL-9-479	750	Polyimide	White	0.650 (16.51)	0.200 (5.08)		15	1
▲	PTL-9-495	750	PEN	White	0.650 (16.51)	0.200 (5.08)		15	1
0.740" Label Width									
●	PTL-85-430	750	Polyester	Clear	0.740 (18.80)	0.240 (6.10)		17	2
●	PTL-99-430	750	Polyester	Clear	0.740 (18.80)	0.320 (8.13)		17	2
0.750" Label Width									
▲	PTL-10-423	750	Polyester	White	0.750 (19.05)	0.250 (6.35)		18	2
▲	PTL-10-426	750	Polyimide	Amber	0.750 (19.05)	0.250 (6.35)		18	2
▲	PTL-10-432	750	Polyester	Clear	0.750 (19.05)	0.250 (6.35)		18	2
▲	PTL-10-437	750	Tedlar	White	0.750 (19.05)	0.250 (6.35)		18	2
▲	PTL-10-457	750	Polyimide	White	0.750 (19.05)	0.250 (6.35)		18	2
▲	PTL-10-473	750	Polyester	White	0.750 (19.05)	0.250 (6.35)		18	2
▲	PTL-10-477	750	Polyimide	White	0.750 (19.05)	0.250 (6.35)		18	2
▲	PTL-10-478	750	Polyimide	White	0.750 (19.05)	0.250 (6.35)		18	2
▲	PTL-10-479	750	Polyimide	White	0.750 (19.05)	0.250 (6.35)		18	2
▲	PTL-10-495	750	PEN	White	0.750 (19.05)	0.250 (6.35)		18	2

Tedlar® is a registered trademark of DuPont.

Any label two inches or larger in width is rotated on liner.

Note: Labels in chart are sorted in order by width, height, 3 digit material number (within part number), then die number (within part number).

TLS 2200® / TLS PC Link™ Label Index by Size

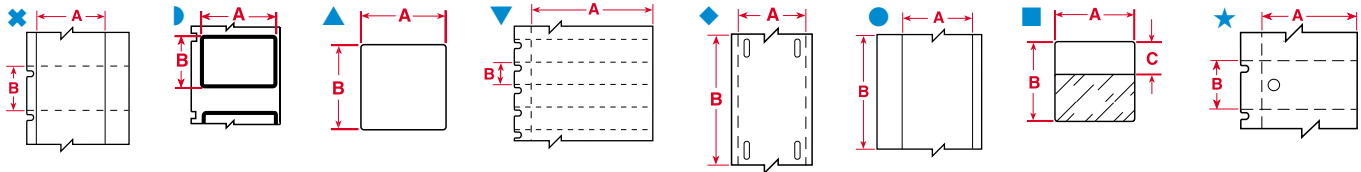

Diagram	Part Number	Pieces Per Package	Material	Color	Label Width A Inch (mm)	Label Height B Inch (mm)	Write-On Height C Inch (mm)	Maximum Characters Per Line For Font: 2	Maximum Lines Of Text For Font: 2
0.750" Label Width (continued)									
▲	PTL-10-8425	750	Polypropylene	White	0.750 (19.05)	0.250 (6.35)		18	2
■	PTL-11-427*	500	Self-laminating Vinyl	Translucent	0.750 (19.05)	0.500 (12.70)	0.375 (9.53)	11	3
■	PTL-11-432	500	Polyester	Clear	0.750 (19.05)	0.500 (12.70)		11	8
▲	PTL-11-498	500	Vinyl Cloth	White	0.750 (19.05)	0.500 (12.70)		11	8
▲	PTL-11-499	500	Nylon Cloth	White	0.750 (19.05)	0.500 (12.70)		11	8
▲	PTL-80-424	250	Paper	White	0.750 (19.05)	0.900 (22.86)		18	10
▲	PTL-80-488	250	Polyester	White	0.750 (19.05)	0.900 (22.86)		18	10
■	PTL-18-427*	250	Self-laminating Vinyl	Translucent	0.750 (19.05)	1.000 (25.40)	0.375 (9.53)	18	3
■	BPTL-18-427	2500	Self-laminating Vinyl	Translucent	0.750 (19.05)	1.000 (25.40)	0.375 (9.53)	18	3
▲	PTL-18-498	250	Vinyl Cloth	White	0.750 (19.05)	1.000 (25.40)		18	10
▲	BPTL-18-498	2500	Vinyl Cloth	White	0.750 (19.05)	1.000 (25.40)		18	10
▲	PTL-18-499	250	Nylon Cloth	White	0.750 (19.05)	1.000 (25.40)		18	10
■	PTL-30-427**	250	Self-laminating Vinyl	Translucent	0.750 (19.05)	1.500 (38.10)	0.500 (12.70)	18	5
■	BPTL-30-427	2500	Self-laminating Vinyl	Translucent	0.750 (19.05)	1.500 (38.10)	0.500 (12.70)	18	5
▲	PTL-30-498	250	Vinyl Cloth	White	0.750 (19.05)	1.500 (38.10)		18	16
▲	PTL-30-499	250	Nylon Cloth	White	0.750 (19.05)	1.500 (38.10)		18	16
◆	PTL-12-109*	100	Polyethylene	White	0.750 (19.05)	3.000 (76.20)		45	6
◆	BPTL-12-109	1000	Polyethylene	White	0.750 (19.05)	3.000 (76.20)		45	6
▲	PTL-62-483	50	Polyester	White	0.750 (19.05)	4.000 (101.60)		50	8
▲	PTL-63-483***	50	Polyester	White	0.750 (19.05)	8.000 (203.20)		50	7
0.785" Label Width									
●	PTL-59-412	1	Polypropylene	White	0.785 (19.94)	50 ft (15.24 m)		50	8
0.900" Label Width									
▲	PTL-13-423	750	Polyester	White	0.900 (22.86)	0.250 (6.35)		22	2
▲	PTL-13-426	750	Polyimide	Amber	0.900 (22.86)	0.250 (6.35)		22	2
▲	PTL-13-457	750	Polyimide	White	0.900 (22.86)	0.250 (6.35)		22	2
▲	PTL-13-478	750	Polyimide	White	0.900 (22.86)	0.250 (6.35)		22	2
▲	PTL-13-479	750	Polyimide	White	0.900 (22.86)	0.250 (6.35)		22	2
▲	PTL-13-495	750	PEN	White	0.900 (22.86)	0.250 (6.35)		22	2
▲	PTL-84-499	500	Nylon Cloth	White	0.900 (22.86)	0.500 (12.70)		22	2
▲	PTL-117-499	500	Nylon Cloth	White	0.900 (22.86)	0.500 (12.70)		22	2
1.000" Label Width									
▲	PTL-14-423	750	Polyester	White	1.000 (25.40)	0.187 (4.74)		24	1
▲	PTL-14-457	750	Polyimide	White	1.000 (25.40)	0.187 (4.74)		24	1
▲	PTL-14-477	750	Polyimide	White	1.000 (25.40)	0.187 (4.74)		24	1
▲	PTL-14-478	750	Polyimide	White	1.000 (25.40)	0.187 (4.74)		24	1
▲	PTL-14-479	750	Polyimide	White	1.000 (25.40)	0.187 (4.74)		24	1
▲	PTL-14-495	750	PEN	White	1.000 (25.40)	0.187 (4.74)		24	1
▲	PTL-15-423	750	Polyester	White	1.000 (25.40)	0.275 (6.98)		24	2
▲	PTL-15-428	750	Metallized Polyester	Silver	1.000 (25.40)	0.275 (6.98)		24	2
▲	PTL-15-437	750	Tedlar	White	1.000 (25.40)	0.275 (6.98)		24	2
▲	PTL-15-498	750	Vinyl Cloth	White	1.000 (25.40)	0.275 (6.98)		24	2
▲	PTL-16-422	500	Polyester	White	1.000 (25.40)	0.375 (9.53)		24	3

Tedlar® is a registered trademark of DuPont.

Any label two inches or larger in width is rotated on liner.

Note: Labels in chart are sorted in order by width, height, 3 digit material number (within part number), then die number (within part number).

* Also available in: YL=Yellow

**Also available in: BL=blue, BR=brown, GN=green, GY=grey, OR=orange, PL=purple, RD=red, YL=yellow. To order a color, add a dash "-" after the material number, then add the color suffix.

Standard product: Contact your Brady Identification Solutions distributor or Customer Service representative for ordering information.

*** PTL-63-483 only for use in TLS 2200.

TLS 2200® / TLS PC Link™ Label Index by Size

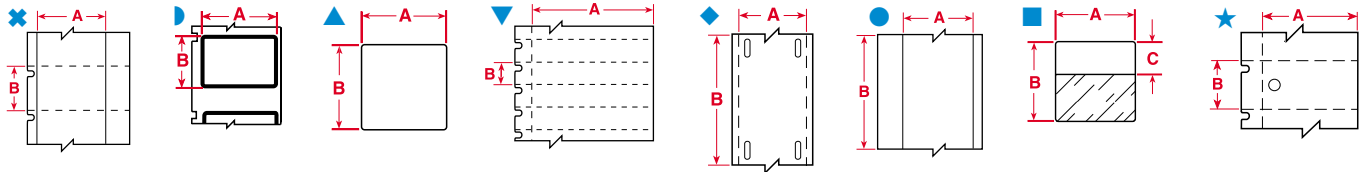

TLS 2200 / TLS PC LINK LABEL INDEX BY SIZE PORTABLE PRINTERS AND LABELS

Diagram	Part Number	Pieces Per Package	Material	Color	Label Width A Inch (mm)	Label Height B Inch (mm)	Write-On Height C Inch (mm)	Maximum Characters Per Line For Font: 2	Maximum Lines Of Text For Font: 2
1.000" Label Width (continued)									
▲	PTL-16-423	500	Polyester	White	1.000 (25.40)	0.375 (9.53)		24	3
▲	BPTL-16-423	5000	Polyester	White	1.000 (25.40)	0.375 (9.53)		24	3
▲	PTL-16-426	500	Polyimide	Amber	1.000 (25.40)	0.375 (9.53)		24	3
▲	PTL-16-430	500	Polyester	Clear	1.000 (25.40)	0.375 (9.53)		24	3
▲	PTL-16-435	500	Polyester	Metallized	1.000 (25.40)	0.375 (9.53)		24	3
▲	PTL-16-457	500	Polyimide	White	1.000 (25.40)	0.375 (9.53)		24	3
▲	PTL-16-473	500	Polyester	White	1.000 (25.40)	0.375 (9.53)		24	3
▲	PTL-16-478	500	Polyimide	White	1.000 (25.40)	0.375 (9.53)		24	4
▲	PTL-16-479	500	Polyimide	White	1.000 (25.40)	0.375 (9.53)		24	4
▲	PTL-16-483	500	Polyester	White	1.000 (25.40)	0.375 (9.53)		24	3
▲	PTL-16-486	500	Polyester	Silver	1.000 (25.40)	0.375 (9.53)		24	3
▲	PTL-16-495	500	PEN	White	1.000 (25.40)	0.375 (9.53)		24	3
▲	PTL-98-499	500	Nylon Cloth	White	1.000 (25.40)	0.375 (9.53)		24	3
▲	PTL-17-351	500	Vinyl	White	1.000 (25.40)	0.500 (12.70)		24	5
▲	PTL-17-352	500	Vinyl	Silver	1.000 (25.40)	0.500 (12.70)		24	5
▲	PTL-17-422	500	Polyester	White	1.000 (25.40)	0.500 (12.70)		24	5
▲	PTL-17-423	500	Polyester	White	1.000 (25.40)	0.500 (12.70)		24	5
▲	PTLSL-17-423	5000	Polyester	White	1.000 (25.40)	0.500 (12.70)		24	5
▲	BPTL-17-423	5000	Polyester	White	1.000 (25.40)	0.500 (12.70)		24	5
▲	PTL-17-426	500	Polyimide	Amber	1.000 (25.40)	0.500 (12.70)		24	5
▲	PTL-17-428	500	Metallized Polyester	Silver	1.000 (25.40)	0.500 (12.70)		24	5
▲	BPTL-17-428	5000	Metallized Polyester	Silver	1.000 (25.40)	0.500 (12.70)		24	5
▲	PTL-17-430	500	Polyester	Clear	1.000 (25.40)	0.500 (12.70)		24	5
▲	PTL-17-432	500	Polyester	Clear	1.000 (25.40)	0.500 (12.70)		24	5
▲	PTL-17-435	500	Polyester	Silver	1.000 (25.40)	0.500 (12.70)		24	5
▲	PTL-17-449	500	Polypropylene	White	1.000 (25.40)	0.500 (12.70)		24	5
▲	PTL-17-473	500	Polyester	White	1.000 (25.40)	0.500 (12.70)		24	5
▲	PTL-17-478	500	Polyimide	White	1.000 (25.40)	0.500 (12.70)		24	5
▲	PTL-17-479	500	Polyimide	White	1.000 (25.40)	0.500 (12.70)		24	5
▲	PTL-17-483	500	Polyester	White	1.000 (25.40)	0.500 (12.70)		24	5
▲	PTL-17-486	500	Polyester	Silver	1.000 (25.40)	0.500 (12.70)		24	5
▲	PTL-17-489	500	Polyester	White	1.000 (25.40)	0.500 (12.70)		24	5
▲	PTL-17-495	500	PEN	White	1.000 (25.40)	0.500 (12.70)		24	5
▲	PTL-17-498	500	Vinyl Cloth	White	1.000 (25.40)	0.500 (12.70)		24	5
▲	PTL-17-7546	500	Polyester	White	1.000 (25.40)	0.500 (12.70)		24	5
▲	PTL-17-7566	500	Polyester	Clear	1.000 (25.40)	0.500 (12.70)		24	5
▲	PTL-17-7576	500	Polyester	Silver	1.000 (25.40)	0.500 (12.70)		24	5
■	PTL-96-427	250	Vinyl	White	1.000 (25.40)	0.750 (19.05)	0.375 (9.53)	24	3
▲	PTL-19-422	250	Polyester	White	1.000 (25.40)	1.000 (25.40)		24	10
▲	PTL-19-423	250	Polyester	White	1.000 (25.40)	1.000 (25.40)		24	10
▲	BPTL-19-423	2500	Polyester	White	1.000 (25.40)	1.000 (25.40)		24	10
■	PTL-19-427**	250	Self-laminating Vinyl	Translucent	1.000 (25.40)	1.000 (25.40)	0.375 (9.53)	24	3
■	BPTL-19-427	2500	Self-laminating Vinyl	Translucent	1.000 (25.40)	1.000 (25.40)	0.375 (9.53)	24	3
▲	PTL-19-435	250	Polyester	Metallized	1.000 (25.40)	1.000 (25.40)		24	10
▲	PTL-19-483	250	Polyester	White	1.000 (25.40)	1.000 (25.40)		24	10
▲	PTL-19-486	250	Polyester	Silver	1.000 (25.40)	1.000 (25.40)		24	10
▲	PTL-19-489	250	Polyester	White	1.000 (25.40)	1.000 (25.40)		24	10
▲	PTL-19-498	250	Vinyl Cloth	White	1.000 (25.40)	1.000 (25.40)		24	10
▲	BPTL-19-498	2500	Vinyl Cloth	White	1.000 (25.40)	1.000 (25.40)		24	10

Tedlar® is a registered trademark of DuPont.

Any label two inches or larger in width is rotated on liner.

Note: Labels in chart are sorted in order by width, height, 3 digit material number (within part number), then die number (within part number).

**** Also available in: BL=blue, BR=brown, GN=green, GY=grey, OR=orange, PL=purple, RD=red, YL=yellow.**

To order a color, add a dash "-" after the material number, then add the color suffix.

Standard product: Contact your Brady Identification Solutions distributor or Customer Service representative for ordering information.

TLS 2200® / TLS PC Link™ Label Index by Size

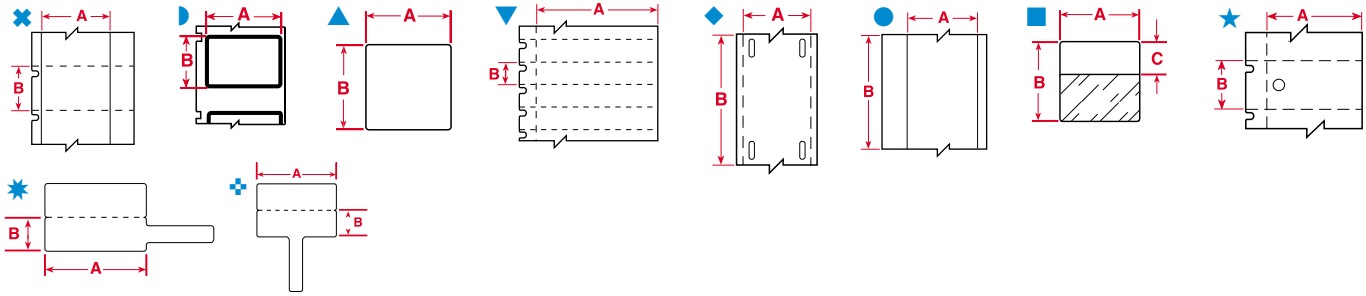

Diagram	Part Number	Pieces Per Package	Material	Color	Label Width A Inch (mm)	Label Height B Inch (mm)	Write-On Height C Inch (mm)	Maximum Characters Per Line For Font: 2	Maximum Lines Of Text For Font: 2
1.000" Label Width (continued)									
▲	PTL-19-499	250	Nylon Cloth	White	1.000 (25.40)	1.000 (25.40)		24	10
■	PTL-19-642	250	Tedlar®	White	1.000 (25.40)	1.000 (25.40)	0.375 (9.53)	24	3
■	PTL-103-427	250	Self-laminating Vinyl	White	1.000 (25.40)	1.250 (31.75)	0.500 (12.70)	24	5
▲	PTL-31-498	250	Vinyl Cloth	White	1.000 (25.40)	1.500 (38.10)		24	16
■	PTL-31-427**	250	Self-laminating Vinyl	Translucent	1.000 (25.40)	1.500 (38.10)	0.500 (12.70)	24	5
■	BPTL-31-427	2500	Self-laminating Vinyl	Translucent	1.000 (25.40)	1.500 (38.10)	0.500 (12.70)	24	5
▲	PTL-31-498	250	Vinyl Cloth	White	1.000 (25.40)	1.500 (38.10)		24	16
▲	PTL-31-499	250	Nylon Cloth	White	1.000 (25.40)	1.500 (38.10)		24	16
■	PTL-31-642	250	Tedlar	White	1.000 (25.40)	1.500 (38.10)	0.500 (12.70)	24	5
■	PTL-21-427**	100	Self-laminating Vinyl	Translucent	1.000 (25.40)	2.500 (63.50)	0.750 (19.05)	24	8
▲	PTL-21-498	100	Vinyl Cloth	White	1.000 (25.40)	2.500 (63.50)		24	23
■	BPTL-21-427	1000	Self-laminating Vinyl	Translucent	1.000 (25.40)	2.500 (63.50)	0.750 (19.05)	24	8
▲	PTL-21-498	100	Vinyl Cloth	White	1.000 (25.40)	2.500 (63.50)		24	23
▲	PTL-21-499	100	Nylon Cloth	White	1.000 (25.40)	2.500 (63.50)		24	23
■	PTL-21-642	100	Tedlar	White	1.000 (25.40)	2.500 (63.50)	0.750 (19.05)	24	8
■	PTL-64-427***	100	Self-laminating Vinyl	Translucent	1.000 (25.40)	3.375 (85.73)	1.125 (28.58)	24	12
■	PTL-23-427**	100	Self-laminating Vinyl	Translucent	1.000 (25.40)	4.000 (101.60)	1.000 (25.40)	24	10
■	BPTL-23-427	1000	Self-laminating Vinyl	Translucent	1.000 (25.40)	4.000 (101.60)	1.000 (25.40)	24	10
▲	PTL-23-498	100	Vinyl Cloth	White	1.000 (25.40)	4.000 (101.60)		24	23
●	PTL-42-422	1	Polyester	White	1.000 (25.40)	50 ft (15.24 m)		50	10
●	PTL-42-430	1	Polyester	Clear	1.000 (25.40)	50 ft (15.24 m)		50	10
●	PTL-42-432	1	Polyester	Clear	1.000 (25.40)	50 ft (15.24 m)		50	10
●	PTL-42-439	1	Vinyl	White	1.000 (25.40)	50 ft (15.24 m)		50	10
●	PTL-42-439-BK	1	Vinyl	Black	1.000 (25.40)	50 ft (15.24 m)		50	10
●	PTL-42-439-BL	1	Vinyl	Blue	1.000 (25.40)	50 ft (15.24 m)		50	10
●	PTL-42-439-GR	1	Vinyl	Green	1.000 (25.40)	50 ft (15.24 m)		50	10
●	PTL-42-439-OR	1	Vinyl	Orange	1.000 (25.40)	50 ft (15.24 m)		50	10
●	PTL-42-439-RD	1	Vinyl	Red	1.000 (25.40)	50 ft (15.24 m)		50	10
●	PTL-42-439-YL	1	Vinyl	Yellow	1.000 (25.40)	50 ft (15.24 m)		50	10
●	PTL-42-483	1	Polyester	White	1.000 (25.40)	50 ft (15.24 m)		50	10
●	PTL-42-489	1	Polyester	White	1.000 (25.40)	50 ft (15.24 m)		50	10
1.100" Label Width									
■	PTL-105-427-AW		Self-laminating Vinyl	Translucent	1.100 (27.94)	0.250 (6.35)		24	3
1.130" Label Width									
▶	PTL-24-423-BK	500	Polyester	White	1.130 (28.70)	0.500 (12.70)		24	3
▶	PTL-24-428-BK	500	Metallized Polyester	Silver	1.130 (28.70)	0.500 (12.70)		24	3
▲	PTL-24-483-BK	500	Polyester	White	1.130 (28.70)	0.500 (12.70)		24	3
▲	PTL-24-486-BK	500	Polyester	Silver	1.130 (28.70)	0.500 (12.70)		24	3
1.180" Label Width									
❖	PTLFP-01-8425	250	Polypropylene	White	1.180 (30.00)	0.788 (20.00)		26	3
*	PTLFT-01-8425	250	Polypropylene	White	1.180 (30.00)	0.788 (20.00)		26	3
1.206" Label Width									
■	PTL-111-145-GY	100	Polyethylene	Gray	1.206 (19.25)	0.758 (30.63)		24	3

Tedlar® is a registered trademark of DuPont.

Any label two inches or larger in width is rotated on liner.

Note: Labels in chart are sorted in order by width, height, 3 digit material number (within part number), then die number (within part number).

****Also available in:** BL=blue, BR=brown, GN=green, GY=grey, OR=orange, PL=purple, RD=red, YL=yellow.

To order a color, add a dash "-" after the material number, then add the color suffix.

Standard product: Contact your Brady Identification Solutions distributor or Customer Service representative for ordering information.

*** PTL-64-247 has two write-on areas, one at each end of the label.

TLS 2200® / TLS PC Link™ Label Index by Size

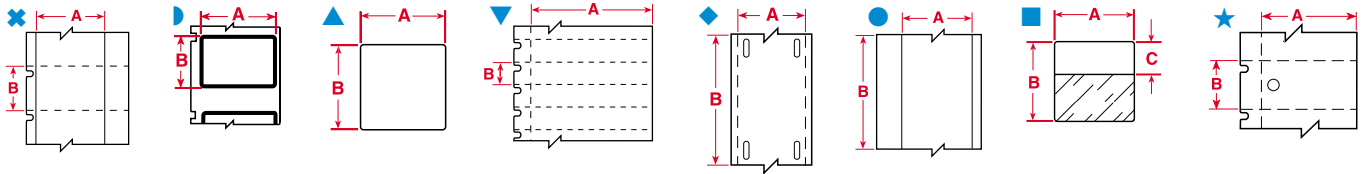

Diagram	Part Number	Pieces Per Package	Material	Color	Label Width A Inch (mm)	Label Height B Inch (mm)	Write-On Height C Inch (mm)	Maximum Characters Per Line For Font: 2	Maximum Lines Of Text For Font: 2
1.250" Label Width									
▲	PTL-25-423	750	Polyester	White	1.250 (31.75)	0.250 (6.35)		31	2
▲	PTL-25-426	750	Polyimide	Amber	1.250 (31.75)	0.250 (6.35)		31	2
▲	PTL-25-457	750	Polyimide	White	1.250 (31.75)	0.250 (6.35)		31	2
▲	PTL-25-477	750	Polyimide	White	1.250 (31.75)	0.250 (6.35)		31	2
▲	PTL-25-478	750	Polyimide	White	1.250 (31.75)	0.250 (6.35)		31	2
▲	PTL-25-479	750	Polyimide	White	1.250 (31.75)	0.250 (6.35)		31	2
▲	PTL-25-495	750	PEN	White	1.250 (31.75)	0.250 (6.35)		31	2
▲	PTL-112-490	500	Polyester	White	1.250 (31.75)	0.375 (9.53)		31	2
1.300" Label Width									
●	PTL-100-432	1	Polyester	Clear	1.300 (33.02)	50 ft (15.24 m)		31	2
●	PTL-100-483	1	Polyester	White	1.300 (33.02)	50 ft (15.24 m)		31	2
●	PTL-100-489	1	Polyester	White	1.300 (33.02)	50 ft (15.24 m)		31	2
1.375" Label Width									
▲	PTL-65-483	250	Polyester	White	1.375 (34.93)	1.00 (25.40)		35	10
1.500" Label Width									
▲	PTL-27-423	750	Polyester	White	1.500 (38.10)	0.125 (3.18)		37	1
▲	PTL-27-426	750	Polyimide	Amber	1.500 (38.10)	0.125 (3.18)		37	1
▲	PTL-27-457	750	Polyimide	White	1.500 (38.10)	0.125 (3.18)		37	1
▲	PTL-27-477	750	Polyimide	White	1.500 (38.10)	0.125 (3.18)		37	1
▲	PTL-27-478	750	Polyimide	White	1.500 (38.10)	0.125 (3.18)		37	1
▲	PTL-27-479	750	Polyimide	White	1.500 (38.10)	0.125 (3.18)		37	1
▲	PTL-27-495	750	PEN	White	1.500 (38.10)	0.125 (3.18)		37	1
▲	PTL-108-461	750	Self-laminating Polyester	Translucent	1.500 (38.10)	0.187 (4.75)	0.700 (17.78)	15	1
▲	PTL-28-423	750	Polyester	White	1.500 (38.10)	0.250 (6.35)		37	2
▲	PTL-28-426	750	Polyimide	Amber	1.500 (38.10)	0.250 (6.35)		37	2
▲	PTL-28-430	750	Polyester	Clear	1.500 (38.10)	0.250 (6.35)		37	2
▲	PTL-28-457	750	Polyimide	White	1.500 (38.10)	0.250 (6.35)		37	2
▲	PTL-28-473	750	Polyester	White	1.500 (38.10)	0.250 (6.35)		37	2
▲	PTL-28-477	750	Polyimide	White	1.500 (38.10)	0.250 (6.35)		37	2
▲	PTL-28-478	750	Polyimide	White	1.500 (38.10)	0.250 (6.35)		37	2
▲	PTL-28-479	750	Polyimide	White	1.500 (38.10)	0.250 (6.35)		37	2
▲	PTL-28-495	750	PEN	White	1.500 (38.10)	0.250 (6.35)		37	2
▲	PTL-45-422	500	Polyester	White	1.500 (38.10)	0.375 (9.53)		37	3
▲	PTL-45-430	500	Polyester	Clear	1.500 (38.10)	0.375 (9.53)		37	3
▲	PTL-29-422	500	Polyester	White	1.500 (38.10)	0.500 (12.70)		37	5
▲	PTL-29-423	500	Polyester	White	1.500 (38.10)	0.500 (12.70)		37	5
▲	BPTL-29-423	5000	Polyester	White	1.500 (38.10)	0.500 (12.70)		37	5
▲	PTL-29-428	500	Metallized	Silver	1.500 (38.10)	0.500 (12.70)		37	5
▲	PTL-29-430	500	Clear	Gloss	1.500 (38.10)	0.500 (12.70)		37	5
▲	PTL-29-434	500	Polyester	Metallized	1.500 (38.10)	0.500 (12.70)		37	5
▲	PTL-29-435	500	Polyester	Metallized	1.500 (38.10)	0.500 (12.70)		37	5
▲	PTL-29-437	500	Tedlar®	White	1.500 (38.10)	0.500 (12.70)		37	5
▲	PTL-29-459	500	Polyester	White	1.500 (38.10)	0.500 (12.70)		37	5
▲	PTL-29-483	500	Polyester	White	1.500 (38.10)	0.500 (12.70)		37	5
▲	PTL-29-486	500	Polyester	Silver	1.500 (38.10)	0.500 (12.70)		37	5
▲	PTL-29-489	500	Polyester	White	1.500 (38.10)	0.500 (12.70)		37	5
▲	PTL-29-498	500	Vinyl Cloth	White	1.500 (38.10)	0.500 (12.70)		11	16

Any label two inches or larger in width is rotated on liner.

Note: Labels in chart are sorted in order by width, height, 3 digit material number (within part number), then die number (within part number).

TLS 2200 / TLS PC LINK LABEL INDEX BY SIZE PORTABLE PRINTERS AND LABELS

TLS 2200® / TLS PC Link™ Label Index by Size

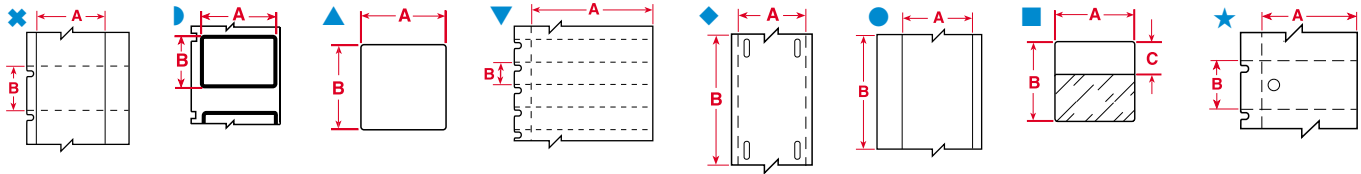

Diagram	Part Number	Pieces Per Package	Material	Color	Label Width A Inch (mm)	Label Height B Inch (mm)	Write-On Height C Inch (mm)	Maximum Characters Per Line For Font: 2	Maximum Lines Of Text For Font: 2
1.500" Label Width (continued)									
▲	PTL-30-422	250	Polyester	White	1.500 (38.10)	0.750 (19.05)		37	8
■	PTL-30-427**	250	Vinyl	White	1.500 (38.10)	0.750 (19.05)		37	8
▲	PTL-30-427-AW	250	Vinyl	White	1.500 (38.10)	0.750 (19.05)		37	8
▲	PTL-30-435	250	Polyester	Metallized	1.500 (38.10)	0.750 (19.05)		37	8
▲	PTL-30-459	250	Polyester	White	1.500 (38.10)	0.750 (19.05)		37	8
▲	PTL-30-483	250	Polyester	White	1.500 (38.10)	0.750 (19.05)		37	8
▲	PTL-30-486	250	Polyester	Silver	1.500 (38.10)	0.750 (19.05)		37	8
▲	PTL-30-489	250	Polyester	Silver	1.500 (38.10)	0.750 (19.05)		37	8
▲	PTL-30-499	250	Vinyl	White	1.500 (38.10)	0.750 (19.05)		37	8
▲	PTL-30-7566	250	Polyester	Clear	1.500 (38.10)	0.750 (19.05)		37	8
▲	PTL-31-351	250	Vinyl	White	1.500 (38.10)	1.000 (25.40)		37	10
▲	PTL-31-352	250	Vinyl	Silver	1.500 (38.10)	1.000 (25.40)		37	10
▲	PTL-31-423	250	Polyester	White	1.500 (38.10)	1.000 (25.40)		37	10
▲	PTL-31-435	250	Polyester	Metallized	1.500 (38.10)	1.000 (25.40)		37	10
▲	PTL-31-483	250	Polyester	White	1.500 (38.10)	1.000 (25.40)		37	10
▲	PTL-31-486	250	Polyester	Silver	1.500 (38.10)	1.000 (25.40)		37	10
▲	PTL-31-489	250	Polyester	White	1.500 (38.10)	1.000 (25.40)		37	10
▲	PTL-31-7546	250	Polyester	White	1.500 (38.10)	1.000 (25.40)		37	10
▲	PTL-31-7566	250	Polyester	Clear	1.500 (38.10)	1.000 (25.40)		37	10
▲	PTL-31-7576	250	Polyester	Silver	1.500 (38.10)	1.000 (25.40)		37	10
■	PTL-104-427	250	Vinyl	White	1.500 (38.10)	1.000 (25.40)	0.375 (9.53)	37	3
▲	PTL-32-422	250	Polyester	White	1.500 (38.10)	1.500 (38.10)		37	16
▲	PTL-32-423	250	Polyester	White	1.500 (38.10)	1.500 (38.10)		37	16
■	PTL-32-427**	250	Self-laminating Vinyl	Translucent	1.500 (38.10)	1.500 (38.10)	0.500 (12.70)	37	5
■	BPTL-32-427	1000	Self-laminating Vinyl	Translucent	1.500 (38.10)	1.500 (38.10)	0.500 (12.70)	37	5
▲	PTL-32-435	250	Polyester	Metallized	1.500 (38.10)	1.500 (38.10)		37	16
▲	PTL-32-483	250	Polyester	White	1.500 (38.10)	1.500 (38.10)		37	16
▲	PTL-32-486	250	Polyester	Silver	1.500 (38.10)	1.500 (38.10)		37	16
▲	PTL-32-489	250	Polyester	White	1.500 (38.10)	1.500 (38.10)		37	16
▲	PTL-32-498	250	Vinyl Cloth	White	1.500 (38.10)	1.500 (38.10)		37	16
■	PTL-33-427**	100	Self-laminating Vinyl	Translucent	1.500 (38.10)	4.000 (101.60)	1.000 (25.40)	37	10
■	BPTL-33-427**	500	Self-laminating Vinyl	Translucent	1.500 (38.10)	4.000 (101.60)	1.000 (25.40)	37	10
▲	PTL-33-498	100	Vinyl Cloth	White	1.500 (38.10)	4.000 (101.60)		37	16
▲	PTL-109-427	100	Vinyl	White	1.500 (38.10)	4.000 (101.60)		37	16
■	PTL-34-427**	50	Self-laminating Vinyl	Translucent	1.500 (38.10)	6.000 (152.40)	1.500 (38.10)	37	16
■	BPTL-34-427	500	Self-laminating Vinyl	Translucent	1.500 (38.10)	6.000 (152.40)	1.500 (38.10)	37	16
▲	PTL-34-498	50	Vinyl Cloth	White	1.500 (38.10)	6.000 (152.40)		37	22
■	PTL-106-427	1	Vinyl	White	1.500 (38.10)	50 ft (15.24 m)			
●	PTLCM-41-437-WT	1	Tedlar®	White	1.500 (38.10)	50 ft (15.24 m)		50	14
●	PTLCM-41-437-YL	1	Tedlar	Yellow	1.500 (38.10)	50 ft (15.24 m)		50	14
1.625" Label Width									
▲	PTL-76-461	250	Polyester	White	1.625 (41.28)	0.600 (15.24)	0.600 (15.24)	37	2
▲	PTL-76-490	250	Polyester	White	1.625 (41.28)	0.600 (15.24)	0.600 (15.24)	37	2

Tedlar® is a registered trademark of DuPont.

Any label two inches or larger in width is rotated on liner.

Note: Labels in chart are sorted in order by width, height, 3 digit material number (within part number), then die number (within part number).

**Also available in: BL=blue, BR=brown, GN=green, GY=grey, OR=orange, PL=purple, RD=red, YL=yellow.

To order a color, add a dash "-" after the material number, then add the color suffix.

Standard product: Contact your Brady Identification Solutions distributor or Customer Service representative for ordering information.

TLS 2200® / TLS PC Link™ Label Index by Size

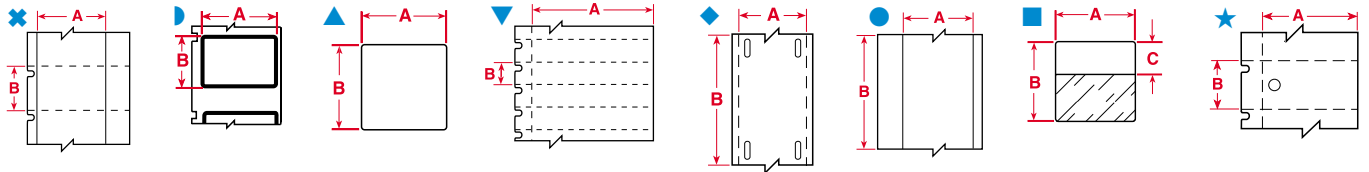

Diagram	Part Number	Pieces Per Package	Material	Color	Label Width A Inch (mm)	Label Height B Inch (mm)	Write-On Height C Inch (mm)	Maximum Characters Per Line For Font: 2	Maximum Lines Of Text For Font: 2
1.750" Label Width									
■	PTL-87-427	250	Vinyl	White	1.750 (44.45)	1.000 (25.40)	0.375 (9.53)	40	3
■	PTL-110-145-GY	100	Polyethylene	Gray	1.750 (44.45)	1.000 (25.40)	0.375 (9.53)	40	3
★	PTL-36-109	250	Polyethylene	White	1.750 (44.45)	1.125 (28.57)		40	15
■	PTL-88-427	250	Vinyl	White	1.750 (44.45)	1.500 (38.10)	0.500 (12.70)	40	5
1.800" Label Width									
★	PTL-73-461	500	Polyester	White	1.800 (45.72)	0.375 (9.53)	0.375 (9.53)	40	3
★	PTL-72-461	500	Polyester	White	1.800 (45.72)	0.500 (12.70)	0.500 (12.70)	40	5
1.900" Label Width									
●	PTL-81-488	750	Polyester	White	1.900 (48.26)	0.250 (6.35)		46	10
●	PTL-81-499	750	Nylon Cloth	Yellow	1.900 (48.26)	0.250 (6.35)		46	10
●	PTL-78-427-AW	250	Vinyl	White	1.900 (48.26)	1.000 (25.40)		46	10
●	PTL-78-488	250	Polyester	White	1.900 (48.26)	1.000 (25.40)		46	10
●	PTL-78-490	250	Polyester	White	1.900 (48.26)	1.000 (25.40)		46	10
●	PTL-78-499	250	Nylon Cloth	White	1.900 (48.26)	1.000 (25.40)		46	10
●	PTL-43-422	1	Polyester	White	1.900 (48.26)	50 ft (15.24 m)		50	10
●	PTL-43-430	1	Polyester	Clear	1.900 (48.26)	50 ft (15.24 m)		50	10
●	PTL-43-432	1	Polyester	Clear	1.900 (48.26)	50 ft (15.24 m)		50	10
●	PTL-43-439	1	Vinyl	White	1.900 (48.26)	50 ft (15.24 m)		50	10
●	PTL-43-439-BK	1	Vinyl	Black	1.900 (48.26)	50 ft (15.24 m)		50	10
●	PTL-43-439-BL	1	Vinyl	Blue	1.900 (48.26)	50 ft (15.24 m)		50	10
●	PTL-43-439-GN	1	Vinyl	Green	1.900 (48.26)	50 ft (15.24 m)		50	10
●	PTL-43-439-OR	1	Vinyl	Orange	1.900 (48.26)	50 ft (15.24 m)		50	10
●	PTL-43-439-RD	1	Vinyl	Red	1.900 (48.26)	50 ft (15.24 m)		50	10
●	PTL-43-439-YL	1	Vinyl	Yellow	1.900 (48.26)	50 ft (15.24 m)		50	10
●	PTL-43-483	1	Polyester	White	1.900 (48.26)	50 ft (15.24 m)		50	10
●	PTL-43-489	1	Polyester	White	1.900 (48.26)	50 ft (15.24 m)		50	10
1.938" Label Width									
▼	PTL-40-412	750	Polypropylene	White	1.938 (49.23)	0.375 (9.53)		40	3
▼	BPTL-40-412	5000	Polypropylene	White	1.938 (49.23)	0.375 (9.53)		40	3
■	PTL-66-427	100	Vinyl	White	1.938 (49.23)	3.150 (80.00)	1.000 (25.40)	46	10
2.000" Label Width									
▲	PTL-2-423	100	Polyester	White	2.000 (50.80)	0.250 (6.35)		46	2
▲	PTL-2-426	100	Polyimide	Amber	2.000 (50.80)	0.250 (6.35)		46	2
▲	PTL-2-457	100	Polyimide	White	2.000 (50.80)	0.250 (6.35)		46	2
▲	PTL-2-477	100	Polyimide	White	2.000 (50.80)	0.250 (6.35)		46	2
▲	PTL-2-478	100	Polyimide	White	2.000 (50.80)	0.250 (6.35)		46	2
▲	PTL-2-479	100	Polyimide	White	2.000 (50.80)	0.250 (6.35)		46	2
▲	PTL-2-495	100	PEN	White	2.000 (50.80)	0.250 (6.35)		46	2
▲	PTL-20-351	100	Vinyl	White	2.000 (50.80)	1.000 (25.40)		46	10
▲	PTL-20-352	100	Vinyl	Silver	2.000 (50.80)	1.000 (25.40)		46	10
▲	PTL-20-422	100	Polyester	White	2.000 (50.80)	1.000 (25.40)		46	10
▲	BPTL-20-422	1000	Polyester	White	2.000 (50.80)	1.000 (25.40)		46	10
▲	PTL-20-423	100	Polyester	White	2.000 (50.80)	1.000 (25.40)		46	10
▲	BPTL-20-423	1000	Polyester	White	2.000 (50.80)	1.000 (25.40)		46	10
▲	PTL-20-424	100	Paper	White	2.000 (50.80)	1.000 (25.40)		46	10
▲	BPTL-20-424	1000	Paper	White	2.000 (50.80)	1.000 (25.40)		46	10
▲	PTL-20-428	100	Metallized Polyester	Silver	2.000 (50.80)	1.000 (25.40)		46	10
▲	BPTL-20-428	1000	Metallized Polyester	Silver	2.000 (50.80)	1.000 (25.40)		46	10
▲	PTL-20-459	100	Polyester	White	2.000 (50.80)	1.000 (25.40)		46	10
▲	PTL-20-483	100	Polyester	White	2.000 (50.80)	1.000 (25.40)		46	10
▲	PTL-20-486	100	Polyester	Silver	2.000 (50.80)	1.000 (25.40)		46	10

Any label two inches or larger in width is rotated on liner.

Note: Labels in chart are sorted in order by width, height, 3 digit material number (within part number), then die number (within part number).

TLS 2200 / TLS PC LINK LABEL INDEX BY SIZE PORTABLE PRINTERS AND LABELS

TLS 2200® / TLS PC Link™ Label Index by Size

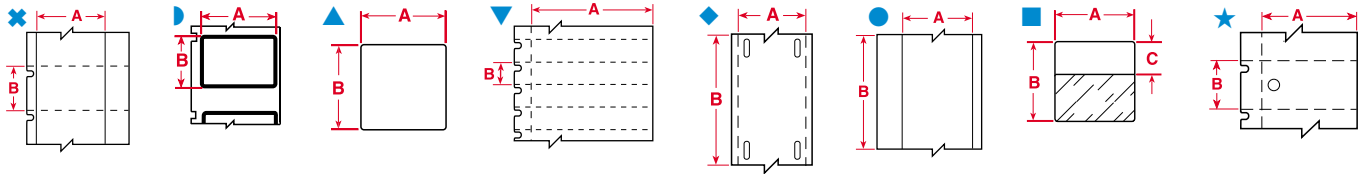

Diagram	Part Number	Pieces Per Package	Material	Color	Label Width A Inch (mm)	Label Height B Inch (mm)	Write-On Height C Inch (mm)	Maximum Characters Per Line For Font: 2	Maximum Lines Of Text For Font: 2
2.000" Label Width (continued)									
▲	PTL-20-489	100	Polyester	White	2.000 (50.80)	1.000 (25.40)		46	10
▲	PTL-20-7546	100	Polyester	White	2.000 (50.80)	1.000 (25.40)		46	10
▲	PTL-20-7566	100	Polyester	Clear	2.000 (50.80)	1.000 (25.40)		46	10
▲	PTL-20-7576	100	Polyester	Silver	2.000 (50.80)	1.000 (25.40)		46	10
■	PTL-107-427	100	Vinyl	White	2.000 (50.80)	1.500 (38.10)	0.500 (12.70)	46	5
■	BPTL-107-427	1000	Vinyl	White	2.000 (50.80)	1.500 (38.10)	0.500 (12.70)	46	5
2.200" Label Width									
■	PTL-74-427	100	Vinyl	White	2.200 (55.88)	0.500 (12.70)	0.750 (19.05)	18	5
■	PTL-74-461	100	Polyester	White	2.200 (55.88)	0.500 (12.70)	0.750 (19.05)	18	5
■	PTL-113-490	100	Polyester	White	2.200 (55.88)	1.500 (38.10)	0.750 (19.05)	18	5
2.625" Label Width									
■	PTL-75-427	100	Vinyl	White	2.625 (66.68)	1.000 (24.40)	1.000 (25.40)	24	10
■	BPTL-75-461	1000	Polyester	White	2.625 (66.68)	1.000 (24.40)	1.000 (25.40)	24	10
■	PTL-75-461 *	100	Polyester	White	2.625 (66.68)	1.000 (24.40)	1.000 (25.40)	24	10
2.750" Label Width									
▲	PTL-26-423	100	Polyester	White	2.750 (69.85)	1.250 (31.75)		50	13
▲	PTL-26-428	100	Polyester	Silver	2.750 (69.85)	1.250 (31.75)		50	13
▲	PTL-26-459	100	Polyester	White	2.750 (69.85)	1.250 (31.75)		50	13
3.000" Label Width									
▲	PTL-22-422	100	Polyester	White	3.000 (76.20)	1.000 (25.40)		50	10
▲	PTL-22-423	100	Polyester	White	3.000 (76.20)	1.000 (25.40)		50	10
▲	PTL-22-424	100	Paper	White	3.000 (76.20)	1.000 (25.40)		50	10
▲	PTL-22-428	100	Polyester	Silver	3.000 (76.20)	1.000 (25.40)		50	10
▲	PTL-22-459	100	Polyester	White	3.000 (76.20)	1.000 (25.40)		50	10
▲	PTL-37-351	100	Vinyl	White	3.000 (76.20)	1.900 (48.26)		50	20
▲	PTL-37-352	100	Vinyl	Silver	3.000 (76.20)	1.900 (48.26)		50	20
▲	PTL-37-422	100	Polyester	White	3.000 (76.20)	1.900 (48.26)		50	20
▲	PTL-37-423	100	Polyester	White	3.000 (76.20)	1.900 (48.26)		50	20
▲	PTL-37-424	100	Paper	White	3.000 (76.20)	1.900 (48.26)		50	20
▲	PTL-37-428	100	Polyester	Silver	3.000 (76.20)	1.900 (48.26)		50	20
▲	PTL-37-435	100	Polyester	Metallized	3.000 (76.20)	1.900 (48.26)		50	20
▲	PTL-37-483	100	Polyester	White	3.000 (76.20)	1.900 (48.26)		50	20
▲	PTL-37-486	100	Polyester	Silver	3.000 (76.20)	1.900 (48.26)		50	20
▲	PTL-37-489	100	Polyester	White	3.000 (76.20)	1.900 (48.26)		50	20
▲	PTL-37-7546	100	Polyester	White	3.000 (76.20)	1.900 (48.26)		50	20
▲	PTL-37-7566	100	Polyester	Clear	3.000 (76.20)	1.900 (48.26)		50	20
▲	PTL-37-7576	100	Polyester	Silver	3.000 (76.20)	1.900 (48.26)		50	20
3.500" Label Width									
■	PTL-77-461	250	Polyester	White	3.500 (88.90)	1.500 (38.10)	1.250 (31.75)	37	13
3.750" Label Width									
■	PTL-79-461	100	Polyester	White	3.750 (95.25)	0.750 (19.05)	1.000 (25.40)	24	5

Tedlar® is a registered trademark of DuPont.

Any label two inches or larger in width is rotated on liner.

Note: Labels in chart are sorted in order by width, height, 3 digit material number (within part number), then die number (within part number).

* Also available in: YL=Yellow

To order a color, add a dash "-" after the material number, then add the color suffix.

Standard product: Contact your Brady Identification Solutions distributor or Customer Service representative for ordering information.

TLS 2200® / TLS PC Link™ Label Index by Size

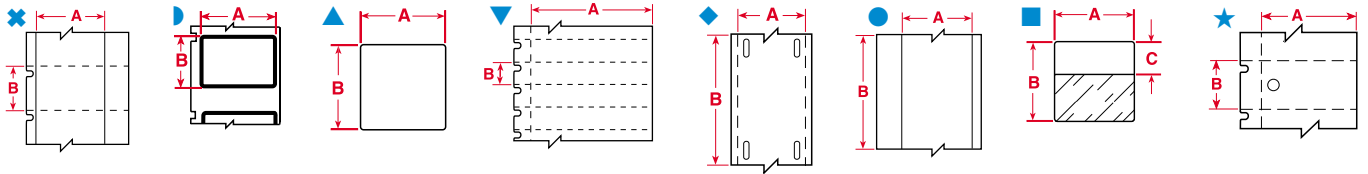

Diagram	Part Number	Pieces Per Package	Material	Color	Label Width A Inch (mm)	Label Height B Inch (mm)	Maximum Characters Per Line For Font: 2	Maximum Lines Of Text For Font: 2
3.875" Label Width								
▲	PTL-114-490	100	Polyester	White	3.875 (98.43)	1.500 (38.10)	50	9
4.000" Label Width								
▲	PTL-23-422	100	Polyester	White	4.000 (101.60)	1.000 (25.40)	50	9
▲	PTL-23-423	100	Polyester	White	4.000 (101.60)	1.000 (25.40)	50	9
▲	PTL-23-483	100	Polyester	White	4.000 (101.60)	1.000 (25.40)	50	9
▲	PTL-23-499	100	Nylon Cloth	White	4.000 (101.60)	1.000 (25.40)	50	9
▲	PTL-38-422	100	Polyester	White	4.000 (101.60)	1.900 (48.26)	50	20
▲	PTL-38-423	100	Polyester	White	4.000 (101.60)	1.900 (48.26)	50	20
▲	PTL-38-424	100	Paper	White	4.000 (101.60)	1.900 (48.26)	50	20
▲	PTL-38-428	100	Polyester	Silver	4.000 (101.60)	1.900 (48.26)	50	20
▲	PTL-38-435	100	Polyester	Metallized	4.000 (101.60)	1.900 (48.26)	50	20
▲	PTL-38-459	100	Polyester	White	4.000 (101.60)	1.900 (48.26)	50	20
▲	PTL-38-483	100	Polyester	White	4.000 (101.60)	1.900 (48.26)	50	20
▲	PTL-38-486	100	Polyester	Silver	4.000 (101.60)	1.900 (48.26)	50	20
▲	PTL-38-489	100	Polyester	White	4.000 (101.60)	1.900 (48.26)	50	20
▲	PTL-38-489	100	Polyester	White	4.000 (101.60)	1.900 (48.26)	50	20

Any label two inches or larger in width is rotated on liner.

Note: Labels in chart are sorted in order by width, height, 3 digit material number (within part number), then die number (within part number).

FYI

Ever wonder how to find the correct height for your self lam labels if you have the wire diameter or wire circumference? Try this formula:

$$\text{wire diameter} \times 3.147 (\text{pie}) = \text{circumference}$$

$$\text{circumference} \times 1.5 (\text{wrapping label 1.5 times around wire}) = \text{length (B dimension of self lam label)}$$

TLS 2200® / TLS PC Link™ Wire and Cable Marking

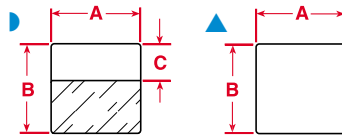

► WIRE MARKING LABELS

Self-Laminating Vinyl (B-427), White or Yellow Tedlar® Film (B-437) (Roll-form cable marking, cut to length), Repositional Vinyl Cloth (B-498), Nylon Cloth (B-499), Self-Laminating Tedlar® (B-642)

Diagram	Part Number	Labels Per Roll	Label Dimensions		Write-On Height	Maximum Characters Per Line For Font:	Maximum Lines Of Text For Font:
			Inch (mm)	Inch (mm)	Inch (mm)	2	2
4 to 10 GAUGE WIRE (AWG) Based on THHN Wire - Maximum Wire Diameter - 0.260 in (6.64 mm)							
▶	PTL-28-427**	750	0.250 (6.35)	1.500 (38.10)	0.500 (12.70)	5	5
▲	PTL-28-498	750	0.250 (6.35)	1.500 (38.10)		5	16
▲	PTL-28-499	750	0.250 (6.35)	1.500 (38.10)		5	16
▲	PTL-29-498	500	0.500 (12.70)	1.500 (38.10)		11	16
▲	BPTL-29-498	5000	0.500 (12.70)	1.500 (38.10)		11	16
▶	PTL-29-427**	500	0.500 (12.70)	1.500 (38.10)	0.500 (12.70)	11	5
▲	PTL-29-499	500	0.500 (12.70)	1.500 (38.10)		11	16
▶	PTL-30-427**	250	0.750 (19.05)	1.500 (38.10)	0.500 (12.70)	18	5
▶	BPTL-30-427	2500	0.750 (19.05)	1.500 (38.10)	0.500 (12.70)	18	5
▲	PTL-30-498	250	0.750 (19.05)	1.500 (38.10)		18	16
▲	PTL-30-499	250	0.750 (19.05)	1.500 (38.10)		18	16
▶	PTL-31-427**	250	1.000 (25.40)	1.500 (38.10)	0.500 (12.70)	24	5
▶	BPTL-31-427	2500	1.000 (25.40)	1.500 (38.10)	0.500 (12.70)	24	5
▲	PTL-31-498	250	1.000 (25.40)	1.500 (38.10)		24	16
▲	PTL-31-499	250	1.000 (25.40)	1.500 (38.10)		24	16
▶	PTL-31-642	250	1.000 (25.40)	1.500 (38.10)	0.500 (12.70)	24	5
▶	PTL-32-427**	250	1.500 (38.10)	1.500 (38.10)	0.500 (12.70)	37	5
▶	BPTL-32-427	1000	1.500 (38.10)	1.500 (38.10)	0.500 (12.70)	37	5
▶	BPTL-32-498	1000	1.500 (38.10)	1.500 (38.10)		37	5
▶	PTL-88-427	250	1.750 (44.45)	1.500 (38.10)	0.500 (12.70)	40	5
▶	PTL-102-427	250	0.500 (12.70)	1.250 (31.75)	0.375 (9.53)	11	3
▶	PTL-103-427	250	1.000 (25.40)	1.250 (31.75)	0.500 (12.70)	24	5
▶	PTL-106-427	1	continuous	1.500 (38.10)	0.500 (12.70)	N/A	5
▶	PTL-107-427	100	2.000 (50.80)	1.500 (38.10)	0.500 (12.70)	46	5
▶	BPTL-107-427	1000	2.000 (50.80)	1.500 (38.10)	0.500 (12.70)	46	5
10 to 12 GAUGE WIRE (AWG) Based on THHN Wire - Maximum Wire Diameter - 0.210 in (5.30 mm)							
▲	PTL-16-498	500	0.375 (9.52)	1.000 (25.40)		8	10
▲	PTL-16-499	500	0.375 (9.52)	1.000 (25.40)		8	10
▶	PTL-17-427*	500	0.500 (12.70)	1.000 (25.40)	0.375 (9.53)	11	3
▶	BPTL-17-427	5000	0.500 (12.70)	1.000 (25.40)	0.375 (9.53)	11	3
▶	PTL-17-498	500	0.500 (12.70)	1.000 (25.40)		11	3
▶	PTL-18-427*	250	0.750 (19.05)	1.000 (25.40)	0.375 (9.53)	18	3
▶	BPTL-18-427	2500	0.750 (19.05)	1.000 (25.40)	0.375 (9.53)	18	3
▲	PTL-18-498	250	0.750 (19.05)	1.000 (25.40)		18	10
▲	BPTL-18-498	2500	0.750 (19.05)	1.000 (25.40)		18	10
▲	PTL-18-499	250	0.750 (19.05)	1.000 (25.40)		18	10
▶	PTL-19-427**	250	1.000 (25.40)	1.000 (25.40)	0.375 (9.53)	24	3
▶	BPTL-19-427	2500	1.000 (25.40)	1.000 (25.40)	0.375 (9.53)	24	3
▲	PTL-19-498	250	1.000 (25.40)	1.000 (25.40)		24	10
▲	BPTL-19-498	2500	1.000 (25.40)	1.000 (25.40)		24	10
▲	PTL-19-499	250	1.000 (25.40)	1.000 (25.40)		24	10
▶	PTL-19-642	250	1.000 (25.40)	1.000 (25.40)	0.375 (9.53)	24	3
▶	PTL-87-427	250	1.750 (44.45)	1.000 (25.40)	0.375 (9.53)	40	3
▶	PTL-104-427	250	1.500 (38.10)	1.000 (25.40)	0.375 (9.53)	37	3
10 to 16 GAUGE WIRE (AWG) Based on THHN Wire - Maximum Wire Diameter - 0.160 in (4.10 mm)							
▶	PTL-10-427*	750	0.250 (6.35)	0.750 (19.05)	0.375 (9.53)	5	3
▶	PTL-10-498	750	0.250 (6.35)	0.750 (19.05)		5	3
▶	PTL-11-427*	500	0.500 (12.70)	0.750 (19.05)	0.375 (9.53)	11	3
▶	BPTL-11-427	5000	0.500 (12.70)	0.750 (19.05)	0.375 (9.53)	11	3
▲	PTL-11-498	500	0.500 (12.70)	0.750 (19.05)		11	8
▲	BPTL-11-498	5000	0.500 (12.70)	0.750 (19.05)		11	8
▲	PTL-11-499	500	0.500 (12.70)	0.750 (19.05)		11	8
▲	BPTL-11-499	5000	0.500 (12.70)	0.750 (19.05)		11	8
▶	PTL-96-427	250	1.000 (25.40)	0.750 (19.05)	0.375 (9.53)	24	3
16 to 22 GAUGE WIRE (AWG) Based on THHN Wire - Maximum Wire Diameter - 0.110 (2.80 mm)							
▲	PTL-7-498	500	0.500 (12.70)	0.500 (12.70)		11	5
▲	PTL-7-499	500	0.500 (12.70)	0.500 (12.70)		11	5

Tedlar® is a registered trademark of DuPont.

* Also available in: YL=Yellow

** Also available in: BL=blue, BR=brown, GN=green, GY=grey, OR=orange, PL=purple, RD=red, YL=yellow.

To order a color, add a dash "-" after the material number, then add the color suffix.

Standard product: Contact your Brady Identification Solutions distributor or Customer Service representative for ordering information.

TLS 2200® / TLS PC Link™ Wire and Cable Marking

TLS 2200 / TLS PC LINK WIRE AND CABLE MARKING PORTABLE PRINTERS AND LABELS

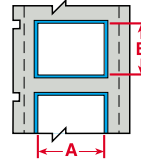
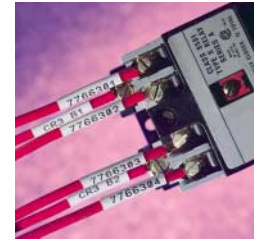

▶ PERMASLEEVE™ WIRE MARKING SLEEVES

Heat-Shrinkable White Polyolefin (B-342)

Part Number	Sleeves Per Roll	Sleeve Dimensions		Range of Wire Dia.		Approx. Wire Gauge*	Maximum Characters Per Line For Font: 2	Maximum Lines Of Text For Font: 2
		A Inch (mm)	B Inch (mm)	Inch (mm) Min	Inch (mm) Max			
1.015" Marker Width								
WHITE 3:1 SHRINK RATIO								
PSPT-094-1-WT	100	1.015 (25.78)	0.182 (4.62)	0.023 (0.58)	0.080 (2.03)	28-18	22	1
BPSPT-094-1-WT	2500	1.015 (25.78)	0.182 (4.62)	0.023 (0.58)	0.080 (2.03)	28-18	22	1
PSPT-125-1-WT	100	1.015 (25.78)	0.235 (5.96)	0.046 (1.17)	0.110 (2.79)	22-16	22	1
BPSPT-125-1-WT	1000	1.015 (25.78)	0.235 (5.96)	0.046 (1.17)	0.110 (2.79)	22-16	22	1
PSPT-187-1-WT	100	1.015 (25.78)	0.335 (8.50)	0.062 (1.57)	0.150 (3.81)	18-12	22	2
BPSPT-187-1-WT	1000	1.015 (25.78)	0.335 (8.50)	0.062 (1.57)	0.150 (3.81)	18-12	22	2
PSPT-250-1-WT	100	1.015 (25.78)	0.439 (11.15)	0.094 (2.39)	0.215 (5.46)	16-10	22	3
BPSPT-250-1-WT	1000	1.015 (25.78)	0.439 (11.15)	0.094 (2.39)	0.215 (5.46)	16-10	22	3
PSPT-375-1-WT	100	1.015 (25.78)	0.645 (16.38)	0.125 (3.18)	0.320 (8.13)	12-6	22	5
BPSPT-375-1-WT	1000	1.015 (25.78)	0.645 (16.38)	0.125 (3.18)	0.320 (8.13)	12-6	9	5
PSPT-500-1-WT	100	1.015 (25.78)	0.851 (21.61)	0.187 (4.75)	0.450 (11.43)	8-1	22	7
BPSPT-500-1-WT	100	1.015 (25.78)	0.851 (21.61)	0.187 (4.75)	0.450 (11.43)	8-1	22	7
PSPT-1000-1-WT	50	1.015 (25.78)	1.660 (42.16)	0.450 (11.43)	0.950 (24.13)	1-500	22	16

YELLOW 3:1 SHRINK RATIO								
PSPT-094-1-YL	100	1.015 (25.78)	0.182 (4.62)	0.023 (0.58)	0.080 (2.03)	28-18	22	1
PSPT-125-1-YL	100	1.015 (25.78)	0.235 (5.96)	0.046 (1.17)	0.110 (2.79)	22-16	22	1
PSPT-187-1-YL	100	1.015 (25.78)	0.335 (8.50)	0.062 (1.57)	0.150 (3.81)	18-12	22	2
PSPT-250-1-YL	100	1.015 (25.78)	0.439 (11.15)	0.094 (2.39)	0.215 (5.46)	16-10	22	3
PSPT-375-1-YL	100	1.015 (25.78)	0.645 (16.38)	0.125 (3.18)	0.320 (8.13)	12-6	22	5
PSPT-500-1-YL	100	1.015 (25.78)	0.851 (21.61)	0.187 (4.75)	0.450 (11.43)	8-1	22	7
PSPT-1000-1-YL	50	1.015 (25.78)	1.660 (42.16)	0.450 (11.43)	0.950 (24.13)	1-500	22	16

1.765" Marker Width								
WHITE 3:1 SHRINK RATIO								
PSPT-094-175-WT	100	1.765 (44.83)	0.182 (4.62)	0.023 (0.58)	0.080 (2.03)	28-18	41	1
BPSPT-094-175-WT	2500	1.765 (44.83)	0.182 (4.62)	0.023 (0.58)	0.080 (2.03)	28-18	41	1
PSPT-125-175-WT	100	1.765 (44.83)	0.235 (5.96)	0.046 (1.17)	0.110 (2.79)	22-16	41	1
BPSPT-125-175-WT	1000	1.765 (44.83)	0.235 (5.96)	0.046 (1.17)	0.110 (2.79)	22-16	41	1
PSPT-187-175-WT	100	1.765 (44.83)	0.335 (8.50)	0.062 (1.57)	0.150 (3.81)	18-12	41	3
BPSPT-187-175-WT	1000	1.765 (44.83)	0.335 (8.50)	0.062 (1.57)	0.150 (3.81)	18-12	41	3
PSPT-250-175-WT	100	1.765 (44.83)	0.439 (11.15)	0.094 (2.39)	0.215 (5.46)	16-10	41	3
BPSPT-250-175-WT	1000	1.765 (44.83)	0.439 (11.15)	0.094 (2.39)	0.215 (5.46)	16-10	41	3
PSPT-375-175-WT	100	1.765 (44.83)	0.645 (16.38)	0.125 (3.18)	0.320 (8.13)	12-6	41	5
BPSPT-375-175-WT	1000	1.765 (44.83)	0.645 (16.38)	0.125 (3.18)	0.320 (8.13)	12-6	41	5
PSPT-500-175-WT	100	1.765 (44.83)	0.851 (21.61)	0.187 (4.75)	0.450 (11.43)	8-1	41	7
BPSPT-500-175-WT	1000	1.765 (44.83)	0.851 (21.61)	0.187 (4.75)	0.450 (11.43)	8-1	41	7
PSPT-1000-175-WT	50	1.765 (44.83)	1.660 (42.16)	0.450 (11.43)	0.950 (24.13)	1-500	41	16
BPSPT-1000-175-WT	500	1.765 (44.83)	1.660 (42.16)	0.450 (11.43)	0.950 (24.13)	1-500	41	16

YELLOW 3:1 SHRINK RATIO								
PSPT-094-175-YL	100	1.765 (44.83)	0.182 (4.62)	0.023 (0.58)	0.080 (2.03)	28-18	41	1
PSPT-125-175-YL	100	1.765 (44.83)	0.235 (5.96)	0.046 (1.17)	0.110 (2.79)	22-16	41	1
PSPT-187-175-YL	100	1.765 (44.83)	0.335 (8.50)	0.062 (1.57)	0.150 (3.81)	18-12	41	3
PSPT-250-175-YL	100	1.765 (44.83)	0.439 (11.15)	0.094 (2.39)	0.215 (5.46)	16-10	41	3
PSPT-375-175-YL	100	1.765 (44.83)	0.645 (16.38)	0.125 (3.18)	0.320 (8.13)	12-6	41	5
PSPT-500-175-YL	100	1.765 (44.83)	0.851 (21.61)	0.187 (4.75)	0.450 (11.43)	8-1	41	7
PSPT-1000-175-YL	50	1.765 (44.83)	1.660 (42.16)	0.450 (11.43)	0.950 (24.13)	1-500	41	16

* Based on National Electric Code insulation measurement of THHN Wire.

Note: Labels are sorted in order by width, height, 3 digit material number (within part number), then die number (within part number).

▶ DURASLEEVE® WIRE MARKER SLEEVES

DuraSleeve White Polypropylene Inserts (B-390)

Part Number	Sleeves Per Roll	Sleeve Dimensions	
		Inch Width (mm)	Inch Height (mm)
PTDS-15-390	300	0.590 (15.00)	0.163 (4.14)
PTDS-30-390	300	1.181 (30.00)	0.163 (4.14)
BPTDS-15-390	3000	0.590 (15.00)	0.163 (4.14)
BPTDS-30-390	3000	1.181 (30.00)	0.163 (4.14)

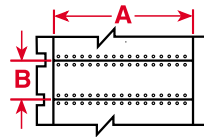

► **BRADYSLEEVE™ WIRE MARKING SLEEVES**

Heat-Shrinkable White Polyolefin (B-321)

Part Number	Sleeves Per Roll	Sleeve Dimensions		Range of Wire Dia.		Approx. Wire Gauge*	Maximum Characters Per Line For Font: 2	Maximum Lines Of Text For Font: 2
		A Inch (mm)	B Inch (mm)	Inch (mm) Min	Inch (mm) Max			
0.450" Sleeve Width								
PTS-045-350-321	500	0.450 (11.43)	0.350 (8.89)	0.075 (1.91)	0.160 (4.06)	10-16	9	2
PTS-045-500-321	500	0.450 (11.43)	0.500 (12.70)	0.160 (4.06)	0.235 (5.97)	8-10	9	4
0.950" Sleeve Width								
PTS-095-350-321	500	0.950 (24.13)	0.350 (8.89)	0.075 (1.91)	0.160 (4.06)	10-16	21	2
PTS-095-500-321	500	0.950 (24.13)	0.500 (12.70)	0.160 (4.06)	0.235 (5.97)	8-10	21	4
PTS-095-750-321	250	0.950 (24.13)	0.750 (19.05)	0.335 (8.51)	0.390 (9.91)	2-4	21	7
PTS-095-1000-321	250	0.950 (24.13)	1.000 (25.40)	0.375 (9.53)	0.540 (13.72)	00-1	21	10
1.900" Sleeve Width								
PTS-190-350-321	500	1.900 (48.26)	0.350 (8.89)	0.075 (1.91)	0.160 (4.06)	10-16	44	2
PTS-190-500-321	500	1.900 (48.26)	0.500 (12.70)	0.160 (4.06)	0.235 (5.97)	8-10	44	4
PTS-190-750-321	250	1.900 (48.26)	0.750 (19.05)	0.335 (8.51)	0.390 (9.91)	2-4	44	7
PTS-190-1000-321	250	1.900 (48.26)	1.000 (25.40)	0.375 (9.53)	0.540 (13.72)	00-1	44	10

* Based on National Electric Code insulation measurement of THHN Wire.

Note: Labels are sorted in order by width, height, 3 digit material number (within part number), then die number (within part number).

► **BRADYTAG® PRINTABLE TAGS**

Polyethylene (B-109)

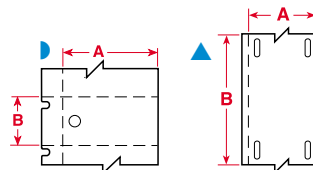

Diagram	Part Number	Tags Per Roll	Tag Dimensions		Maximum Characters Per Line For Font: 2	Maximum Lines Of Text For Font: 2	Applications/Description
			Inch (mm) A	Inch (mm) B			
▲	PTL-12-109	100	0.750 (19.05)	3.000 (76.20)	45	6	Product ID for harsh environments/tear resistant
▲	BPTL-12-109	1000	0.750 (19.05)	3.000 (76.20)	45	6	Product ID for harsh environments/tear resistant
▶	PTL-36-109	250	1.750 (44.45)	1.125 (28.57)	34	12	Product ID for harsh environments/tear resistant

► **ELECTRICAL COMPONENT MARKERS**

Polypropylene (B-412)

Part Number	Labels Per Roll	Label Dimensions		Maximum Characters Per Line For Font: 2	Maximum Lines Of Text For Font: 2
		Inch (mm) A	Inch (mm) B		
PTL-57-412	50 ft (15.24 m)	0.500 (12.70)	continuous	50	5

► **TERMINAL BLOCK MARKERS**

Repositional Vinyl Cloth (B-498)

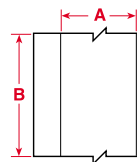

Part Number	Roll Length Ft. (m)	Label Dimensions		Maximum Characters Per Line For Font: 2	Maximum Lines Of Text For Font: 2
		Inch (mm) A	Ft. (m) B		
PTLTB-498-240	30 ft (9.10 m)	0.240 (6.09)	30 ft (9.10 m)	5	N/A
BPTLTB-498-240	300 ft (91.44 m)	0.240 (6.09)	300 ft (91.44 m)	5	N/A
PTLTB-498-318	30 ft (9.10 m)	0.318 (8.07)	30 ft (9.10 m)	7	N/A
BPTLTB-498-318	300 ft (91.44 m)	0.318 (8.07)	300 ft (91.44 m)	7	N/A
PTLTB-498-375	30 ft (9.10 m)	0.375 (9.52)	30 ft (9.10 m)	8	N/A
BPTLTB-498-375	300 ft (91.44 m)	0.375 (9.52)	300 ft (91.44 m)	8	N/A

TLS 2200® / TLS PC Link™ Data Communications Equipment and Cabling Labels

TLS 2200 / TLS PC LINK DATA COMMUNICATIONS EQUIPMENT AND CABLING LABELS PORTABLE PRINTERS AND LABELS

▶ VOICE AND DATA CABLING LABELS AND TAGS

All *B-427 parts listed in Voice and Data Cabling section are available in the following colors:

- BL = Blue (For horizontal cable terminations)
- BR = Brown (For campus backbone cable terminations)
- GN = Green (Network connections)
- GY = Gray (For backbone cable between intermediate cross-connect and a telecommunications closet)
- OR = Orange (Central office termination)
- PL = Purple (Major switching and data equipment terminations)
- RD = Red (For all key telephone equipment terminations)
- YL = Yellow (For auxiliary, maintenance, alarms, security, etc.)

* Standard product, contact your distributor or customer service representative for ordering information

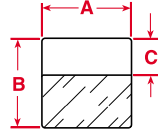

Self-Laminating Vinyl (B-427), Low Smoke Self-Laminating Tedlar® (B-642)

Part Number	Labels Per Roll	Label Dimension			Application	Maximum Characters Per Line For Font:	Maximum Lines Of Text For Font:
		A Inches (mm)	B Inches (mm)	C Inches (mm)		2	2
PTL-12-109	100	0.750 (19.05)	3.000 (76.20)	—	Cable Tag	18	—
PTL-19-427	250	1.000 (25.40)	1.000 (25.40)	0.375 (9.53)	2 pair Fiber, Single/Multi-Mode	24	3
BPTL-19-427	2500	1.000 (25.40)	1.000 (25.40)	0.375 (9.53)	2 pair Fiber, Single/Multi-Mode	24	3
PTL-19-642	250	1.000 (25.40)	1.000 (25.40)	0.375 (9.53)	2 pair Fiber, Plenum Grade	24	3
PTL-21-427	100	1.000 (25.40)	2.500 (63.50)	0.750 (19.05)	25 pair Copper, 4-12 pair Fiber	24	8
BPTL-21-427	1000	1.000 (25.40)	2.500 (63.50)	0.750 (19.05)	25 pair Copper, 4-12 pair Fiber	24	8
PTL-21-642	100	1.000 (25.40)	2.500 (63.50)	0.750 (19.05)	25 pair Copper, Plenum Grade	24	8
PTL-23-427	100	1.000 (25.40)	4.000 (101.60)	1.000 (25.40)	50 pair Copper, 24 pair Fiber	24	10
BPTL-23-427	1000	1.000 (25.40)	4.000 (101.60)	1.000 (25.40)	50 pair Copper, 24 pair Fiber	24	10
PTL-29-427	500	0.500 (12.70)	1.500 (38.10)	0.500 (12.70)	CAT-5, 4 pair UTP Copper	11	5
BPTL-29-427	5000	0.500 (12.70)	1.500 (38.10)	0.500 (12.70)	CAT-5, 4 pair UTP Copper	11	5
PTL-30-427	250	0.750 (19.05)	1.500 (38.10)	0.500 (12.70)	CAT-5, 4 pair UTP Copper	18	5
BPTL-30-427	2500	0.750 (19.05)	1.500 (38.10)	0.500 (12.70)	CAT-5, 4 pair UTP Copper	18	5
PTL-31-427	250	1.000 (25.40)	1.500 (38.10)	0.500 (12.70)	CAT-5, 4 pair UTP Copper	24	5
BPTL-31-427	2500	1.000 (25.40)	1.500 (38.10)	0.500 (12.70)	CAT-5, 4 pair UTP Copper	24	5
PTL-31-642	250	1.000 (25.40)	1.500 (38.10)	0.500 (12.70)	CAT-5, Plenum Grade	24	5
PTL-32-427	250	1.500 (38.10)	1.500 (38.10)	0.500 (12.70)	CAT-5, 4 pair UTP Copper	37	5
PTL-33-427	100	1.500 (38.10)	4.000 (101.60)	1.000 (25.40)	50 pair Copper, 24 pair Fiber	37	10
BPTL-33-427	1000	1.500 (38.10)	4.000 (101.60)	1.000 (25.40)	50 pair Copper, 24 pair Fiber	37	10
PTL-34-427	50	1.500 (38.10)	6.000 (152.40)	1.500 (38.10)	100 pair Copper, 36 pair Fiber	37	16
BPTL-34-427	500	1.500 (38.10)	6.000 (152.40)	1.500 (38.10)	100 pair Copper, 36 pair Fiber	37	16
PTL-36-109	250	1.750 (44.45)	1.125 (28.57)	—	Cable Tag	40	—
PTL-64-427	100	1.000 (25.40)	3.375 (85.73)	1.125 (28.58)	CAT -5, 4 pair UTP Copper	24	12
PTL-66-427	100	1.940 (49.23)	3.150 (80.00)	1.000 (25.40)	50 pair Copper, 24 pair Fiber	40	10
PTL-87-427	250	1.750 (44.45)	1.000 (25.40)	0.375 (9.53)	2 pair Fiber, Single/Multi-Mode	21	3
PTL-88-427	250	1.750 (44.45)	1.500 (38.10)	0.500 (12.70)	CAT -5, 4 pair UTP Copper	40	5
PTL-102-427	250	0.500 (12.70)	1.250 (31.75)	0.375 (9.53)	CAT -5, 4 pair UTP Copper	11	3
PTL-103-427	250	1.000 (25.40)	1.250 (31.75)	0.500 (12.70)	CAT -5, 4 pair UTP Copper	24	5
PTL-104-427	250	1.500 (38.10)	1.000 (25.40)	0.375 (9.53)	2 pair Fiber, Single/Multi-Mode	37	3
PTL-106-427	1	50 ft (15.24 m)	1.500 (38.10)	0.500 (12.70)	CAT -5, 4 pair UTP Copper	N/A	5
PTL-107-427	1000	2.000 (50.80)	1.500 (38.10)	0.500 (12.70)	CAT -5, 4 pair UTP Copper	46	5
BPTL-107-427	1000	2.000 (50.80)	1.500 (38.10)	0.500 (12.70)	CAT -5, 4 pair UTP Copper	46	5
PTL-109-427	100	1.500 (38.10)	4.000 (101.60)	1.500 (38.10)	50 pair Copper, 24 pair Fiber	37	16

Tedlar® is a registered trademark of DuPont.

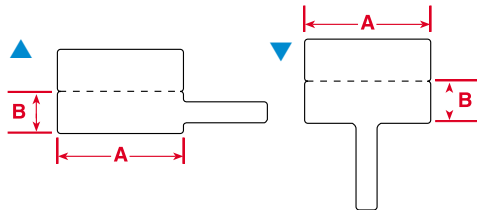

PTLFP-01-8425



PTLFT-01-8425

▶ FIBER OPTIC LABELS (B-8425), FLAG

Polypropylene (B-8425)

Diagram	Part Number	Labels Per Roll	Label Dimensions		Applications	Maximum Characters Per Line For Font:	Maximum Lines Of Text For Font:
			A Inch (mm)	B Inch (mm)		2	2
▲	PTLFP-01-8425	250	1.180 (30.00)	0.788 (20.00)	Pig-tail and single fiber ID	26	3
▼	PTLFT-01-8425	250	1.180 (30.00)	0.788 (20.00)	Pig-tail and single fiber ID	26	3

TLS 2200® / TLS PC Link™ Data Communications Equipment and Cabling Labels

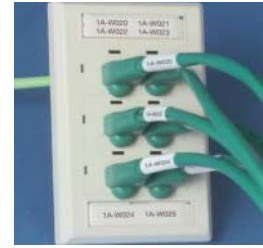
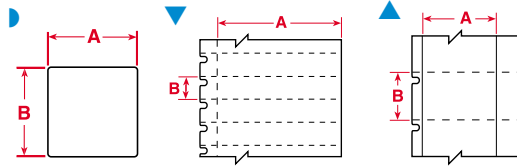

▶ WORKSTATION LABELS

Polypropylene (B-412), Permanent Glossy Polyester (B-422), Clear Polyester (B-430), Vinyl (B-427)

Diagram	Part Number	Labels Per Roll	Label Dimensions		Applications	Maximum Characters	Maximum Lines Of
			A Inch (mm)	B Inch (mm)		Per Line For Font:	Text For Font:
▶	PTL-7-422	500	0.500 (12.70)	0.500 (12.70)	1-6 Outlet Faceplates	11	5
▶	PTL-7-430	500	0.500 (12.70)	0.500 (12.70)	1-6 Outlet Faceplates	11	5
▶	PTL-16-422	500	1.000 (25.40)	0.375 (9.52)	1-4 Outlet Faceplates	24	3
▶	PTL-16-430	500	1.000 (25.40)	0.375 (9.52)	1-4 Outlet Faceplates	24	3
▶	PTL-17-422	500	1.000 (25.40)	0.500 (12.70)	1-4 Outlet Faceplates	24	5
▶	PTL-17-430	500	1.000 (25.40)	0.500 (12.70)	1-4 Outlet Faceplates	24	5
▶	PTL-29-422	500	1.500 (38.10)	0.500 (12.70)	1-2 Outlet Faceplates	37	5
▶	PTL-29-430	500	1.500 (38.10)	0.500 (12.70)	1-2 Outlet Faceplates	37	5
▶	PTL-39-422	750	0.375 (9.52)	0.600 (15.24)	1-6 Outlet Faceplates	8	6
▶	PTL-39-430	750	0.375 (9.52)	0.600 (15.24)	1-6 Outlet Faceplates	8	6
▶	PTL-40-412	750	1.938 (49.23)	0.375 (9.52)	Faceplates with DESI-STRIP	40	3
▶	BPTL-40-412	5000	1.938 (49.23)	0.375 (9.52)	Faceplates with DESI-STRIP	40	3
▶	PTL-44-422	500	0.500 (12.70)	0.375 (9.52)	1-6 Outlet Faceplates	11	3
▶	PTL-44-430	500	0.500 (12.70)	0.375 (9.52)	1-6 Outlet Faceplates	11	3
▶	PTL-45-422	500	1.500 (38.10)	0.375 (9.52)	1-2 Outlet Faceplates	37	3
▶	PTL-45-430	500	1.500 (38.10)	0.375 (9.52)	1-2 Outlet Faceplates	37	3
▶	PTL-68-430	750	0.240 (6.10)	0.150 (3.81)	Siemen Faceplates	4	2
▶	PTL-69-430	750	0.530 (13.46)	0.150 (3.81)	Siemen Faceplates	11	2
▶	PTL-70-430	750	0.240 (6.10)	0.200 (5.08)	Siemen Faceplates	4	2
▶	PTL-71-430	750	0.350 (8.89)	0.200 (5.08)	Siemen Faceplates	7	2
▶	PTL-85-430	750	0.740 (18.80)	0.240 (6.10)	Siemen Faceplates	17	2
▶	PTL-99-430	750	0.740 (18.80)	0.320 (8.12)	Siemen Faceplates	17	2

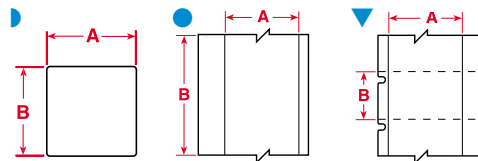

▶ PATCH PANEL IDENTIFICATION

Polypropylene (B-412), Permanent Glossy Polyester (B-422), Clear Polyester (B-430), Rough Surface Clear Polyester (B-432), Vinyl (B-439)

Diagram	Part Number	Labels Per Roll	Label Dimensions		Applications	Maximum Characters	Maximum Lines Of
			A Inch (mm)	B Inch (mm)		Per Line For Font:	Text For Font:
▶	PTL-7-422	500	0.500 (12.70)	0.500 (12.70)	Patch Panel - Label Each Port	11	5
▶	PTL-7-430	500	0.500 (12.70)	0.500 (12.70)	Patch Panel - Label Each Port	11	5
●	PTL-8-422	1	0.500 (12.70)	50 ft (15.24 m)	Outlet, Patch Panel, Cont. Tape - Cut to Size	50	5
●	PTL-8-430	1	0.500 (12.70)	50 ft (15.24 m)	Outlet, Patch Panel, Cont. Tape - Cut to Size	50	5
●	PTL-8-432	1	0.500 (12.70)	50 ft (15.24 m)	Outlet, Patch Panel, Cont. Tape - Cut to Size	50	5
●	PTL-8-439	1	0.500 (12.70)	50 ft (15.24 m)	Outlet, Patch Panel, Cont. Tape - Cut to Size	50	5
●	PTL-8-439-BK	1	0.500 (12.70)	50 ft (15.24 m)	Outlet, Patch Panel, Cont. Tape - Cut to Size	50	5
●	PTL-8-439-BL	1	0.500 (12.70)	50 ft (15.24 m)	Outlet, Patch Panel, Cont. Tape - Cut to Size	50	5
●	PTL-8-439-GN	1	0.500 (12.70)	50 ft (15.24 m)	Outlet, Patch Panel, Cont. Tape - Cut to Size	50	5
●	PTL-8-439-OR	1	0.500 (12.70)	50 ft (15.24 m)	Outlet, Patch Panel, Cont. Tape - Cut to Size	50	5
●	PTL-8-439-RD	1	0.500 (12.70)	50 ft (15.24 m)	Outlet, Patch Panel, Cont. Tape - Cut to Size	50	5
●	PTL-8-439-YL	1	0.500 (12.70)	50 ft (15.24 m)	Outlet, Patch Panel, Cont. Tape - Cut to Size	50	5
▶	PTL-39-422	750	0.375 (9.52)	0.600 (15.24)	Patch Panel	8	6
▶	PTL-39-430	750	0.375 (9.52)	0.600 (15.24)	Patch Panel	8	6
●	PTL-46-422	1	0.375 (9.52)	50 ft (15.24 m)	Outlet, Patch Panel, Cont. Tape - Cut to Size	50	3
●	PTL-46-430	1	0.375 (9.52)	50 ft (15.24 m)	Outlet, Patch Panel, Cont. Tape - Cut to Size	50	3
●	PTL-55-412	1	0.230 (5.84)	50 ft (15.24 m)	Broadcast Patch Bay Strips	50	NA
●	PTL-56-412	1	0.375 (9.53)	50 ft (15.24 m)	Broadcast Patch Bay Strips	50	3
●	PTL-57-412	1	0.500 (12.70)	50 ft (15.24 m)	Broadcast Patch Bay Strips	50	5
●	PTL-58-412	1	0.535 (13.59)	50 ft (15.24 m)	Broadcast Patch Bay Strips	50	5
●	PTL-59-412	1	0.785 (19.90)	50 ft (15.24 m)	Broadcast Patch Bay Strips	50	8

TLS 2200® / TLS PC Link™ Data Communications Equipment and Cabling Labels

TLS 2200 / TLS PC LINK DATA COMMUNICATIONS EQUIPMENT AND CABLING LABELS PORTABLE PRINTERS AND LABELS

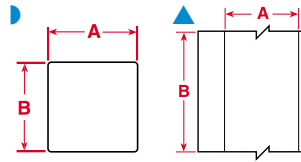

► RACK, BAY, FRAME AND GENERAL COMMUNICATION IDENTIFICATION

Permanent Glossy Polyester (B-422), Clear Polyester (B-430),
 Rough Surface Clear Polyester (B-432), Vinyl (B-439), Ultra Aggressive Glossy Polyester (B-483),
 Ultra-Aggressive Matte White Polyester (B-489)

Diagram	Part Number	Labels Per Roll	Label Dimensions		Applications	Maximum Characters	Maximum Lines Of
			A Inch (mm)	B Inch (mm)		Per Line For Font: 2	Text For Font: 2
▲	PTL-8-422	1	0.500 (12.70)	50 ft (15.24 m)	Outlet, Patch Panel, Cont. Tape - Cut to Size	50	5
▲	PTL-8-430	1	0.500 (12.70)	50 ft (15.24 m)	Outlet, Patch Panel, Cont. Tape - Cut to Size	50	5
▲	PTL-8-432	1	0.500 (12.70)	50 ft (15.24 m)	Outlet, Patch Panel, Cont. Tape - Cut to Size	50	5
▲	PTL-8-439	1	0.500 (12.70)	50 ft (15.24 m)	Outlet, Patch Panel, Cont. Tape - Cut to Size	50	5
▲	PTL-8-439-BK	1	0.500 (12.70)	50 ft (15.24 m)	Outlet, Patch Panel, Cont. Tape - Cut to Size	50	5
▲	PTL-8-439-BL	1	0.500 (12.70)	50 ft (15.24 m)	Outlet, Patch Panel, Cont. Tape - Cut to Size	50	5
▲	PTL-8-439-GN	1	0.500 (12.70)	50 ft (15.24 m)	Outlet, Patch Panel, Cont. Tape - Cut to Size	50	5
▲	PTL-8-439-OR	1	0.500 (12.70)	50 ft (15.24 m)	Outlet, Patch Panel, Cont. Tape - Cut to Size	50	5
▲	PTL-8-439-RD	1	0.500 (12.70)	50 ft (15.24 m)	Outlet, Patch Panel, Cont. Tape - Cut to Size	50	5
▲	PTL-8-439-YL	1	0.500 (12.70)	50 ft (15.24 m)	Outlet, Patch Panel, Cont. Tape - Cut to Size	50	5
▲	PTL-8-498	1	0.500 (12.70)	30 ft (9.10 m)	Outlet, Patch Panel, Cont. Tape - Cut to Size	50	5
▶	PTL-20-422	100	2.000 (50.80)	1.000 (25.40)	General identification	46	10
▶	BPTL-20-422	1000	2.000 (50.80)	1.000 (25.40)	General identification	46	10
▲	PTL-20-483	100	2.000 (50.80)	1.000 (25.40)	Shelf/general identification	46	10
▶	PTL-28-430	750	1.500 (38.10)	0.250 (6.35)	General identification	37	2
▲	PTL-30-483	250	1.500 (38.10)	0.750 (19.05)	Shelf/general identification	37	8
▲	PTL-32-483	250	1.500 (38.10)	1.500 (38.10)	Shelf/general identification	37	16
▲	PTL-37-483	100	3.000 (76.20)	1.900 (48.26)	Rack/end aisle	50	20
▲	PTL-38-483	100	4.000 (101.60)	1.900 (48.26)	Rack/end aisle	50	20
▲	PTL-42-430	1	1.000 (25.40)	50 ft (15.24 m)	General identification	50	5
●	PTL-42-432*	1	1.000 (25.40)	50 ft (15.24 m)	General identification	50	5
▲	PTL-42-439	1	1.000 (25.40)	50 ft (15.24 m)	General identification	50	5
▲	PTL-42-439-OR	1	1.000 (25.40)	50 ft (15.24 m)	General identification	50	5
▲	PTL-42-439-RD	1	1.000 (25.40)	50 ft (15.24 m)	General identification	50	5
▲	PTL-42-439-YL	1	1.000 (25.40)	50 ft (15.24 m)	General identification	50	5
▲	PTL-42-483	1	1.000 (25.40)	50 ft (15.24 m)	General identification	50	5
▲	PTL-42-422	1	1.000 (25.40)	50 ft (15.24 m)	General identification	50	5
▲	PTL-42-489	1	1.000 (25.40)	30 ft (9.10 m)	General identification	50	5
●	PTL-43-432*	1	1.900 (48.26)	50 ft (15.24 m)	Rack/general identification	50	10
●	PTL-43-483	1	1.900 (48.26)	50 ft (15.24 m)	General identification	50	10
●	PTL-43-489	1	1.900 (48.26)	50 ft (15.24 m)	Rack/general identification	50	10
▲	PTL-61-483	100	0.500 (12.70)	2.000 (50.80)	Shelf	50	5
▲	PTL-62-483	50	0.750 (19.05)	4.000 (101.60)	Rack/end aisle	50	8
▲	PTL-63-483	50	0.750 (19.05)	8.000 (203.20)	DWDM/site names	50	7
▲	PTL-65-483	250	1.375 (34.93)	1.000 (25.40)	Shelf	35	10
●	PTL-100-432**/1	1	1.300 (33.02)	50 ft (15.24 m)	Rack/general identification	31	2
●	PTL-100-483**	1	1.300 (33.02)	50 ft (15.24 m)	Rack/general identification	31	2
●	PTL-100-489**	1	1.300 (33.02)	50 ft (15.24 m)	Rack/general identification	31	2
●	PTL-101-432*	1	0.250 (6.35)	50 ft (15.24 m)	Panel/general identification	50	2
●	PTL-101-483	1	0.250 (6.35)	50 ft (15.24 m)	Panel/general identification	50	2

* B-432 material available in additional label sizes. Red, White and Blue ribbon colors also available.

** This is the minimum width continuous tape needed to print a 3/4" font.

TLS 2200® / TLS PC Link™ General and Industrial Identification Labels

MATERIAL TO SURFACE CROSS REFERENCE GUIDE

Part Number	SMOOTH (Examples: Uncoated Metal, Plastic, Glass)	TEXTURED/ROUGH (Examples: Textured ABS, Cast Metal, Polycarbonate)	HIGHLY TEXTURED/LOW SURFACE ENERGY (Examples: Powder Coated, Low Surface Energy ABS, Polypropylene)
BRADYBONDZ™ B-423 B-424* B-428*• B-430 B-459* B-473 B-488 B-7546* B-7566 B-7576* B-8425	◆ YES	NO	NO
SUPER BRADYBONDZ™ B-351 B-352 B-422* B-432 B-435*• B-439	● YES	● YES	NO
ULTRA BRADYBONDZ™ B-483* B-486* B-489 B-499	■ YES	■ YES	■ YES

* Material UL recognized/CSA approved

• Material AGA approved

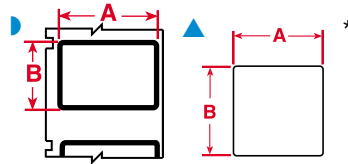

▶ RATING / NAMEPLATE LABELS

Permanent Glossy Polyester (B-422, B-423, B-459), General Purpose White Paper (B-424), Flexible Vinyl (B-427), Permanent Metallized Polyester (B-428, B-435), Ultra-Aggressive Glossy Polyester (B-483), Ultra-Aggressive Matte Metallized Polyester (B-486), Matte Polyester (B-488), Ultra-Aggressive Matte Polyester (B-489), Nylon Cloth (B-499)

Surface Suitability	Diagram	Part Number	Labels Per Roll	Label Dimensions		Applications/Description	Maximum Characters Per Line For Font: 2	Maximum Lines Of Text For Font: 2
				A Inch (mm)	B Inch (mm)			
●	▲	PTL-8-428	1	0.500 (12.70)	50 ft (15.24 m)	Small ICs; silver finish	50	5
●	▲	PTL-8-483	1	0.500 (12.70)	50 ft (15.24 m)	Small ICs; silver finish	50	5
●	▲	PTL-8-489	1	0.500 (12.70)	50 ft (15.24 m)	Small ICs	50	5
●	▲	PTL-11-432	250	0.500 (12.70)	0.750 (19.05)	Asset ID for textured surfaces	11	9
■	▲	PTL-16-435	500	1.000 (25.40)	0.375 (9.52)	Asset ID for textured surfaces	24	3
■	▲	PTL-16-483	500	1.000 (25.40)	0.375 (9.52)	Asset ID for textured surfaces	24	3
■	▲	PTL-16-486	500	1.000 (25.40)	0.375 (9.52)	Asset ID for oily, greasy, and textured surfaces	24	3
■	▲	PTL-16-489	500	1.000 (25.40)	0.375 (9.52)	Asset ID for oily, greasy, and textured surfaces	24	3
●	▲	PTL-17-435	500	1.000 (25.40)	0.500 (12.70)	General-purpose	24	5
●	▲	PTL-17-428	500	1.000 (25.40)	0.500 (12.70)	General-purpose over-laminated ID	24	5
●	▲	BPTL-17-428	5000	1.000 (25.40)	0.500 (12.70)	General-purpose over-laminated ID	24	5
■	▲	PTL-17-483	500	1.000 (25.40)	0.500 (12.70)	Asset ID for textured surfaces	24	5
■	▲	PTL-17-486	500	1.000 (25.40)	0.500 (12.70)	Asset ID for oily, greasy, and textured surfaces	24	5
■	▲	PTL-17-489	500	1.000 (25.40)	0.500 (12.70)	Asset ID for oily, greasy, and textured surfaces	24	5
●	▲	PTL-19-422	250	1.000 (25.40)	1.000 (25.40)	Asset ID for textured surfaces	24	10
◆	▲	PTL-19-423	250	1.000 (25.40)	1.000 (25.40)	Rating plate	24	10
◆	▲	PTL-19-435	250	1.000 (25.40)	1.000 (25.40)	Rating plate	24	10
◆	▲	BPTL-19-423	2500	1.000 (25.40)	1.000 (25.40)	Rating plate	24	10
■	▲	PTL-19-483	250	1.000 (25.40)	1.000 (25.40)	Asset ID for textured surfaces	24	10
■	▲	PTL-19-486	250	1.000 (25.40)	1.000 (25.40)	Asset ID for oily, greasy, and textured surfaces	24	10
■	▲	PTL-19-489	250	1.000 (25.40)	1.000 (25.40)	Asset ID for oily, greasy, and textured surfaces	24	10
◆	▲	PTL-20-424	100	2.000 (50.80)	1.000 (25.40)	General ID and Asset ID	46	10
◆	▲	BPTL-20-424	100	2.000 (50.80)	1.000 (25.40)	General ID and Asset ID	46	10
●	▲	PTL-20-435	100	2.000 (50.80)	1.000 (25.40)	Asset ID, silver finish	46	10
●	▲	PTL-20-428	100	2.000 (50.80)	1.000 (25.40)	Asset ID, silver finish	46	10
●	▲	BPTL-20-428	1000	2.000 (50.80)	1.000 (25.40)	Asset ID, silver finish	46	10
■	▲	PTL-20-483	100	2.000 (50.80)	1.000 (25.40)	Asset ID for textured surfaces	46	10
■	▲	PTL-20-486	100	2.000 (50.80)	1.000 (25.40)	Asset ID for oily, greasy, and textured surfaces	46	10
■	▲	PTL-20-489	100	2.000 (50.80)	1.000 (25.40)	Asset ID for oily, greasy, and textured surfaces	46	10
●	▲	PTL-22-422	100	3.000 (46.20)	1.000 (25.40)	General ID	50	10
◆	▲	PTL-22-423	100	3.000 (46.20)	1.000 (25.40)	General ID	50	10
◆	▲	PTL-22-424	100	3.000 (46.20)	1.000 (25.40)	General ID	50	10
●	▲	PTL-22-428	100	3.000 (46.20)	1.000 (25.40)	Rating plate	50	10
◆	▲	PTL-22-459	100	3.000 (46.20)	1.000 (25.40)	General ID	50	10
●	▲	PTL-23-422	100	4.000 (101.60)	1.000 (25.40)	General ID	50	10
◆	▲	PTL-23-423	100	4.000 (101.60)	1.000 (25.40)	General ID	50	10
■	▲	PTL-23-483	100	4.000 (101.60)	1.000 (25.40)	Asset ID for textured surfaces	50	10
◆	▲	PTL-23-499	100	4.000 (101.60)	1.000 (25.40)	General ID	50	10
◆	▶	PTL-24-423-BK	500	1.130 (28.70)	0.500 (12.70)	1/16" (1.60 mm) Black-bordered component ID	24	3
●	▶	PTL-24-428-BK	500	1.130 (28.70)	0.500 (12.70)	1/16" (1.60 mm) Black-bordered component ID	24	3
■	▶	PTL-24-483-BK	500	1.130 (28.70)	0.500 (12.70)	1/16" (1.60 mm) Black-bordered component ID	24	3
■	▶	PTL-24-486-BK	500	1.130 (28.70)	0.500 (12.70)	1/16" (1.60 mm) Black-bordered component ID	24	3

* Any label two inches or larger is rotated on liner.

◆ Material suitable for smooth surfaces.

● Material suitable for smooth and textured surfaces.

■ Material suitable for smooth, textured and highly textured surfaces.

TLS 2200® / TLS PC Link™ General and Industrial Identification Labels

TLS 2200 / TLS PC LINK GENERAL AND INDUSTRIAL IDENTIFICATION LABELS PORTABLE PRINTERS AND LABELS

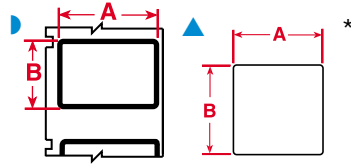

▶ RATING / NAMEPLATE LABELS CONTINUED

Permanent Glossy Polyester (B-422, B-423, B-459), General Purpose White Paper (B-424), Flexible Vinyl (B-427), Permanent Metallized Polyester (B-428, B-435), Ultra-Aggressive Glossy Polyester (B-483), Ultra-Aggressive Matte Metallized Polyester (B-486), Matte Polyester (B-488), Ultra-Aggressive Matte Polyester (B-489), Nylon Cloth (B-499)

Surface Suitability	Diagram	Part Number	Labels Per Roll	Label Dimensions		Applications/Description	Maximum Characters Per Line For Font:		Maximum Lines Of Text For Font:	
				A Inch (mm)	B Inch (mm)		2	2	2	2
◆	▲	PTL-26-423	100	2.750 (69.85)	1.250 (31.75)	General ID and Asset ID	50			13
◆	▲	PTL-26-428	100	2.750 (69.85)	1.250 (31.75)	General ID and Asset ID	50			13
●	▲	PTL-29-428	500	1.500 (38.10)	0.500 (12.70)	Faceplates, panels, equipment, silver finish	37			5
■	▲	PTL-29-435	500	1.500 (38.10)	0.500 (12.70)	Asset ID for textured surfaces	37			5
■	▲	PTL-29-483	500	1.500 (38.10)	0.500 (12.70)	Asset ID for textured surfaces	37			5
■	▲	PTL-29-486	500	1.500 (38.10)	0.500 (12.70)	Asset ID for oily, greasy, and textured surfaces	37			5
■	▲	PTL-29-489	500	1.500 (38.10)	0.500 (12.70)	Asset ID for oily, greasy, and textured surfaces	37			5
●	▲	PTL-30-422	250	1.500 (38.10)	0.750 (19.05)	Asset ID for textured surfaces	37			8
●	▲	PTL-30-427-AW	250	1.500 (38.10)	0.750 (19.05)	Asset ID for curved surfaces	37			8
●	▲	PTL-30-435	250	1.500 (38.10)	0.750 (19.05)	Asset ID for textured surfaces	37			8
■	▲	PTL-30-483	250	1.500 (38.10)	0.750 (19.05)	Asset ID for oily, greasy, and textured surfaces	37			8
■	▲	PTL-30-486	250	1.500 (38.10)	0.750 (19.05)	Asset ID for oily, greasy, and textured surfaces	37			8
■	▲	PTL-30-489	250	1.500 (38.10)	0.750 (19.05)	Asset ID for oily, greasy, and textured surfaces	37			8
■	▲	PTL-30-499	250	1.500 (38.10)	0.750 (19.05)	Asset ID for oily, greasy, and textured surfaces	37			8
◆	▲	PTL-31-423	250	1.500 (38.10)	1.000 (25.40)	General ID	37			10
◆	▲	PTL-31-435	250	1.500 (38.10)	1.000 (25.40)	General ID	37			10
◆	▲	PTL-31-483	250	1.500 (38.10)	1.000 (25.40)	Asset ID for textured surfaces	37			10
■	▲	PTL-31-486	250	1.500 (38.10)	1.000 (25.40)	Asset ID for oily, greasy, and textured surfaces	37			10
■	▲	PTL-31-489	250	1.500 (38.10)	1.000 (25.40)	Asset ID for oily, greasy, and textured surfaces	37			10
◆	▲	PTL-32-423	250	1.500 (38.10)	1.500 (38.10)	General ID	37			16
◆	▲	PTL-32-435	250	1.500 (38.10)	1.500 (38.10)	General ID	37			16
■	▲	PTL-32-483	250	1.500 (38.10)	1.500 (38.10)	Asset ID for textured surfaces	37			16
■	▲	PTL-32-486	250	1.500 (38.10)	1.500 (38.10)	Asset ID for oily, greasy, and textured surfaces	37			16
■	▲	PTL-32-489	250	1.500 (38.10)	1.500 (38.10)	Asset ID for oily, greasy, and textured surfaces	37			16
●	▲	PTL-37-422	100	3.000 (76.20)	1.900 (48.26)	Asset ID for textured surfaces	50			20
◆	▲	PTL-37-423	100	3.000 (76.20)	1.900 (48.26)	General ID and Asset ID	50			20
◆	▲	PTL-37-424	100	3.000 (76.20)	1.900 (48.26)	General ID and Asset ID	50			20
●	▲	PTL-37-428	100	3.000 (76.20)	1.900 (48.26)	Asset ID, silver finish	50			20
●	▲	PTL-37-435	100	3.000 (76.20)	1.900 (48.26)	Asset ID, silver finish	50			20
■	▲	PTL-37-483	100	3.000 (76.20)	1.900 (48.26)	Asset ID for oily, greasy, and textured surfaces	50			20
■	▲	PTL-37-486	100	3.000 (76.20)	1.900 (48.26)	Asset ID for oily, greasy, and textured surfaces	50			20
■	▲	PTL-37-489	100	3.000 (76.20)	1.900 (48.26)	Asset ID for oily, greasy, and textured surfaces	50			20
●	▲	PTL-38-422	100	4.000 (101.60)	1.900 (48.26)	Asset ID for textured surfaces	50			20
◆	▲	PTL-38-423	100	4.000 (101.60)	1.900 (48.26)	General ID and Asset ID	50			20
◆	▲	PTL-38-424	100	4.000 (101.60)	1.900 (48.26)	General ID and Asset ID	50			20
●	▲	PTL-38-428	100	4.000 (101.60)	1.900 (48.26)	Asset ID, silver finish	50			20
●	▲	PTL-38-435	100	4.000 (101.60)	1.900 (48.26)	Asset ID, silver finish	50			20
■	▲	PTL-38-483	100	4.000 (101.60)	1.900 (48.26)	Asset ID for oily, greasy, and textured surfaces	50			20
■	▲	PTL-38-486	100	4.000 (101.60)	1.900 (48.26)	Asset ID for oily, greasy, and textured surfaces	50			20
■	▲	PTL-38-489	100	4.000 (101.60)	1.900 (48.26)	Asset ID for oily, greasy, and textured surfaces	50			20
●	▲	PTL-78-427-AW	250	1.900 (48.26)	1.000 (25.40)	Asset ID for curved surfaces	50			20
■	▲	PTL-78-499	250	1.900 (48.26)	1.000 (25.40)	General ID	50			20
◆	▲	PTL-80-424	250	0.750 (19.05)	0.900 (22.86)	General ID	50			20
◆	▲	PTL-80-488	250	0.750 (19.05)	0.900 (22.86)	Asset ID with print durability	50			20
◆	▲	PTL-81-488	750	1.900 (48.26)	0.250 (6.35)	Asset ID with print durability	50			20
■	▲	PTL-81-499	750	1.900 (48.26)	0.250 (6.35)	General ID	50			20
■	▲	PTL-84-499	500	0.900 (22.86)	0.500 (12.70)	General ID	50			20
◆	▲	PTL-97-488	250	0.900 (22.86)	0.900 (22.86)	Asset ID with print durability	50			20

* Any label two inches or larger is rotated on liner.

- ◆ Material suitable for smooth surfaces.
- Material suitable for smooth and textured surfaces.
- Material suitable for smooth, textured and highly textured surfaces.

TLS 2200® / TLS PC Link™ General and Industrial Identification Labels

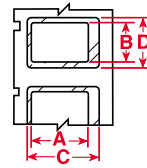

► PERMASHIELD™* LABELS

Permanent Glossy Polyester (B-422), General Purpose White Paper (B-424), Permanent Metallized Polyester (B-428)

Surface Suitability	Part Number	Labels Per Roll	Label Dimensions		Overlamine Dimensions		Maximum Characters Per Line For Font: 2	Maximum Lines Of Text For Font: 2
			A Inch (mm)	B Inch (mm)	C Inch (mm)	D Inch (mm)		
●	PTPSL-17-422	500	1.000 (25.40)	0.500 (12.70)	1.250 (31.75)	0.750 (19.05)	24	5
◆	PTPSL-17-424	500	1.000 (25.40)	0.500 (12.70)	1.250 (31.75)	0.750 (19.05)	24	5
●	PTPSL-17-428	500	1.000 (25.40)	0.500 (12.70)	1.250 (31.75)	0.750 (19.05)	24	5
●	PTPSL-20-422	100	2.000 (50.80)	1.000 (25.40)	2.250 (57.15)	1.250 (31.75)	46	10
◆	PTPSL-20-424	100	2.000 (50.80)	1.000 (25.40)	2.250 (57.15)	1.250 (31.75)	46	10
●	PTPSL-20-428	100	2.000 (50.80)	1.000 (25.40)	2.250 (57.15)	1.250 (31.75)	46	10
●	PTPSL-26-422	100	1.250 (31.75)	2.750 (69.85)	1.500 (38.10)	3.000 (76.20)	50	13
●	PTPSL-26-428	100	1.250 (31.75)	2.750 (69.85)	1.500 (38.10)	3.000 (76.20)	50	13
●	PTPSL-50-422	100	1.650 (41.91)	3.000 (76.20)	1.900 (48.26)	3.250 (82.55)	75	18
●	PTPSL-50-428	100	1.650 (41.91)	3.000 (76.20)	1.900 (48.26)	3.250 (82.55)	75	18

- ◆ Material suitable for smooth surfaces.
- Material suitable for smooth and textured surfaces.
- Material suitable for smooth, textured and highly textured surfaces.

* This product is sold in Japan only under the Overlamine Labels name and not under the PermaShield name.

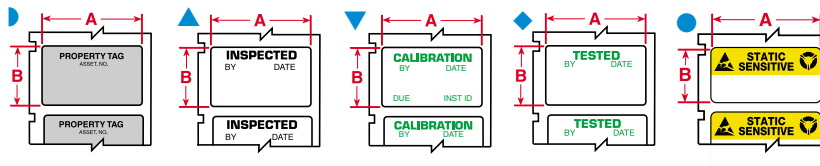

► PRE-PRINTED LABELS

Permanent Glossy Polyester (B-422, B-423), Permanent Metallized Polyester (B-428), Permanent Silver Polyester (B-435), Static Dissipative Polyester (B-473)

Surface Suitability	Diagram	Part Number	Labels Per Roll	Label Dimensions		Pre-Printed Legend Description
				A Inch (mm)	B Inch (mm)	
◆	●	PTLSL-17-473	500	1.000 (25.40)	0.500 (12.70)	STATIC SENSITIVE
◆	▼	PTL-30-423-CALI	250	1.500 (38.10)	0.750 (19.05)	CALIBRATION
◆	▼	PTL-30-428-CALI	250	1.500 (38.10)	0.750 (19.05)	CALIBRATION
◆	◆	PTL-30-423-TEST	250	1.500 (38.10)	0.750 (19.05)	TESTED
◆	◆	PTL-30-428-TEST	250	1.500 (38.10)	0.750 (19.05)	TESTED
◆	▲	PTL-30-423-INSP	250	1.500 (38.10)	0.750 (19.05)	INSPECTED BY
◆	▲	PTL-30-428-INSP	250	1.500 (38.10)	0.750 (19.05)	INSPECTED BY
●	►	PTL-35-422-PROP	250	1.630 (41.40)	0.750 (19.05)	PROPERTY TAG
◆	►	PTL-35-423-PROP	250	1.630 (41.40)	0.750 (19.05)	PROPERTY TAG
◆	►	PTL-35-428-PROP	250	1.630 (41.40)	0.750 (19.05)	PROPERTY TAG
◆	►	PTL-35-435-PROP	250	1.630 (41.40)	0.750 (19.05)	PROPERTY TAG

TLS 2200® / TLS PC Link™ General and Industrial Identification Labels

TLS 2200 / TLS PC LINK GENERAL AND INDUSTRIAL IDENTIFICATION LABELS PORTABLE PRINTERS AND LABELS

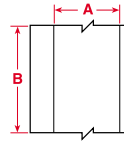

► GENERAL INDUSTRIAL LABELS

Permanent Glossy Polyester (B-422), Permanent Clear Polyester (B-430), Permanent Clear Rough Surface Polyester (B-432), Permanent Colored Vinyl (B-439), Ultra-Aggressive Glossy Polyester (B-483), Ultra-Aggressive Matte White Polyester (B-489)

Surface Suitability	Part Number	Labels Per Row	Label Dimensions		Maximum Characters Per Line For Font: 7	Maximum Lines Of Text For Font: 7
			A Inch (mm)	B Inch (mm)		
●	PTL-42-422	1	1.000 (25.40)	50 ft (15.24 m)	50	5
◆	PTL-42-430	1	1.000 (25.40)	50 ft (15.24 m)	50	5
◆	PTL-42-439	1	1.000 (25.40)	50 ft (15.24 m)	50	5
◆	PTL-42-439-BK	1	1.000 (25.40)	50 ft (15.24 m)	50	5
◆	PTL-42-439-BL	1	1.000 (25.40)	50 ft (15.24 m)	50	5
◆	PTL-42-439-GR	1	1.000 (25.40)	50 ft (15.24 m)	50	5
◆	PTL-42-439-OR	1	1.000 (25.40)	50 ft (15.24 m)	50	5
◆	PTL-42-439-RD	1	1.000 (25.40)	50 ft (15.24 m)	50	5
◆	PTL-42-439-YL	1	1.000 (25.40)	50 ft (15.24 m)	50	5
■	PTL-42-483	1	1.000 (25.40)	50 ft (15.24 m)	50	5
■	PTL-42-498	1	1.000 (25.40)	50 ft (15.24 m)	50	5
●	PTL-43-422	1	1.900 (48.26)	50 ft (15.24 m)	50	10
◆	PTL-43-430	1	1.900 (48.26)	50 ft (15.24 m)	50	10
◆	PTL-43-432	1	1.900 (48.26)	50 ft (15.24 m)	50	10
◆	PTL-43-439	1	1.900 (48.26)	50 ft (15.24 m)	50	10
◆	PTL-43-439-BK	1	1.900 (48.26)	50 ft (15.24 m)	50	10
◆	PTL-43-439-BL	1	1.900 (48.26)	50 ft (15.24 m)	50	10
◆	PTL-43-439-GR	1	1.900 (48.26)	50 ft (15.24 m)	50	10
◆	PTL-43-439-OR	1	1.900 (48.26)	50 ft (15.24 m)	50	10
◆	PTL-43-439-RD	1	1.900 (48.26)	50 ft (15.24 m)	50	10
◆	PTL-43-439-YL	1	1.900 (48.26)	50 ft (15.24 m)	50	10
■	PTL-43-483	1	1.900 (48.26)	50 ft (15.24 m)	50	10
■	PTL-43-489	1	1.900 (48.26)	50 ft (15.24 m)	50	10
◆	PTL-100-432	1	1.300 (33.02)	50 ft (15.24 m)	50	6
■	PTL-100-483	1	1.300 (33.02)	50 ft (15.24 m)	50	6
■	PTL-100-489	1	1.300 (33.02)	50 ft (15.24 m)	50	6
◆	PTL-101-432	1	0.250 (33.02)	50 ft (15.24 m)	50	1
■	PTL-101-483	1	0.250 (33.02)	50 ft (15.24 m)	50	1
■	PTL-101-489	1	0.250 (33.02)	50 ft (15.24 m)	50	1

- ◆ Material suitable for smooth surfaces.
- Material suitable for smooth and textured surfaces.
- Material suitable for smooth, textured and highly textured surfaces.

TLS 2200® / TLS PC Link™ Security Identification Labels

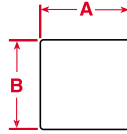

TAMPER INDICATING LABELS

Tamper-Resistant White Vinyl (B-351), Tamper-Resistant Metallized Vinyl (B-352), Tamper-Resistant White Paper (B-353), Tamper-Evident White Polyester (B-7546), Tamper-Evident Clear Polyester (B-7566), Tamper-Evident Metallized Polyester (B-7576)

Surface Suitability	Part Number	Labels Per Roll	Label Dimensions		Maximum Characters Per Line For Font: 2	Maximum Lines Of Text For Font: 2
			A Inch (mm)	B Inch (mm)		
●	PTL-17-351	500	1.000 (25.40)	0.500 (12.70)	24	5
●	PTL-17-352	500	1.000 (25.40)	0.500 (12.70)	24	5
●	PTL-17-353	500	1.000 (25.40)	0.500 (12.70)	24	5
●	PTL-17-7546	500	1.000 (25.40)	0.500 (12.70)	24	5
●	PTL-17-7566	500	1.000 (25.40)	0.500 (12.70)	24	5
●	PTL-17-7576	500	1.000 (25.40)	0.500 (12.70)	24	5
●	PTL-20-351	100	2.000 (50.80)	1.000 (25.40)	46	10
●	PTL-20-352	100	2.000 (50.80)	1.000 (25.40)	46	10
●	PTL-20-353	100	2.000 (50.80)	1.000 (25.40)	46	10
●	PTL-20-7546	100	2.000 (50.80)	1.000 (25.40)	46	10
●	PTL-20-7566	100	2.000 (50.80)	1.000 (25.40)	46	10
●	PTL-20-7576	100	2.000 (50.80)	1.000 (25.40)	46	10
●	PTL-30-353	250	1.500 (38.10)	0.750 (19.10)	37	10
●	PTL-30-7566	250	1.500 (38.10)	0.750 (19.10)	37	10
●	PTL-31-351	250	1.500 (38.10)	1.000 (25.40)	37	10
●	PTL-31-352	250	1.500 (38.10)	1.000 (25.40)	37	10
●	PTL-31-353	250	1.500 (38.10)	1.000 (25.40)	37	10
●	PTL-31-7546	250	1.500 (38.10)	1.000 (25.40)	37	10
●	PTL-31-7566	250	1.500 (38.10)	1.000 (25.40)	37	10
●	PTL-31-7576	250	1.500 (38.10)	1.000 (25.40)	37	10
●	PTL-37-351	100	3.000 (76.20)	1.900 (48.26)	50	20
●	PTL-37-352	100	3.000 (76.20)	1.900 (48.26)	50	20
●	PTL-37-353	100	3.000 (76.20)	1.900 (48.26)	50	20
●	PTL-37-7546	100	3.000 (76.20)	1.900 (48.26)	50	20
●	PTL-37-7566	100	3.000 (76.20)	1.900 (48.26)	50	20
●	PTL-37-7576	100	3.000 (76.20)	1.900 (48.26)	50	20

- ◆ Material suitable for smooth surfaces.
- Material suitable for smooth and textured surfaces.
- Material suitable for smooth, textured and highly textured surfaces.

TLS 2200® / TLS PC Link™ Custom Label Options

Custom sizes, colors and partially preprinted labels are also available. Contact your Brady Identification Solutions distributor or Brady Customer Service at **1-888-272-3946** for ordering information.



TLS 2200® / TLS PC Link™ Circuit Board and Component Identification Labels

THERMAL TRANSFER PRINTABLE PRODUCTS CIRCUIT BOARD PROCESS CHART

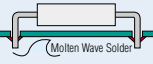
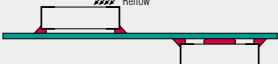
				 Through Hole Technology Top Bottom		 Surface Mount Technology (SMT) Top or Bottom		After Process
B-426 B-479	B-457	B-477	B-478	● Yes	● Yes	● Yes		● Yes
B-422 B-459	B-423, B-473	B-428 B-488	B-430 B-498		▲ Yes*	✗ No		✗ No ● Yes
B-495				● Yes	✗ No	● Yes		● Yes

* In extreme high temperatures, testing of these materials is recommended.

► POLYIMIDES

High Temperature Amber Polyimide (B-426),
High Temperature White Polyimide (B-457),
Static Dissipative Polyimide (B-477, B-478, B-479),
High Temperature White PEN (B-495)

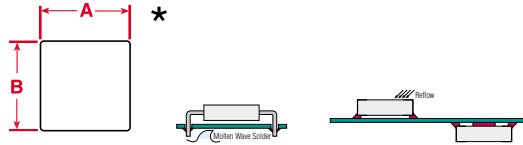

Part Number	Labels Per Roll	Label Dimensions		Maximum Characters Per Line For Font:	Maximum Lines Of Text For Font:	Maximum Bar Code Characters:	Through Hole Technology		SMT Top / Bottom	After Process
		A Inch (mm)	B Inch (mm)				Top	Bottom		
PTL-1-426	750	0.250 (6.35)	0.250 (6.35)	6	2	0	●	●	●	●
PTL-1-457	750	0.250 (6.35)	0.250 (6.35)	6	2	0	●	●	●	●
PTL-1-477	750	0.250 (6.35)	0.250 (6.35)	6	2	0	●	●	●	●
PTL-1-478	750	0.250 (6.35)	0.250 (6.35)	6	2	0	●	●	●	●
PTL-1-479	750	0.250 (6.35)	0.250 (6.35)	6	2	0	●	●	●	●
PTL-1-495	750	0.250 (6.35)	0.250 (6.35)	6	2	0	●	✗	●	●
PTL-2-426	100	2.000 (50.80)	0.250 (6.35)	52	2	11	●	●	●	●
PTL-2-457	100	2.000 (50.80)	0.250 (6.35)	52	2	11	●	●	●	●
PTL-2-477	100	2.000 (50.80)	0.250 (6.35)	52	2	11	●	●	●	●
PTL-2-478	100	2.000 (50.80)	0.250 (6.35)	52	2	11	●	●	●	●
PTL-2-479	100	2.000 (50.80)	0.250 (6.35)	52	2	11	●	●	●	●
PTL-2-495	100	2.000 (50.80)	0.250 (6.35)	52	2	11	●	✗	●	●
PTL-3-426	500	0.375 (9.52)	0.375 (9.52)	10	4	0	●	●	●	●
PTL-3-457	500	0.375 (9.52)	0.375 (9.52)	10	4	0	●	●	●	●
PTL-3-477	500	0.375 (9.52)	0.375 (9.52)	10	4	0	●	●	●	●
PTL-3-478	500	0.375 (9.52)	0.375 (9.52)	10	4	0	●	●	●	●
PTL-3-479	500	0.375 (9.52)	0.375 (9.52)	10	4	0	●	●	●	●
PTL-3-495	500	0.375 (9.52)	0.375 (9.52)	10	4	0	●	✗	●	●
PTL-4-426	500	0.400 (10.16)	0.400 (10.16)	10	4	0	●	●	●	●
PTL-4-457	500	0.400 (10.16)	0.400 (10.16)	10	4	0	●	●	●	●
PTL-4-478	500	0.400 (10.16)	0.400 (10.16)	10	4	0	●	●	●	●
PTL-4-479	500	0.400 (10.16)	0.400 (10.16)	10	4	0	●	●	●	●
PTL-4-495	500	0.400 (10.16)	0.400 (10.16)	10	4	0	●	✗	●	●
PTL-6-426	750	0.500 (12.70)	0.275 (6.98)	13	3	0	●	●	●	●
PTL-6-457	750	0.500 (12.70)	0.275 (6.98)	13	3	0	●	●	●	●
PTL-6-478	750	0.500 (12.70)	0.275 (6.98)	13	3	0	●	●	●	●
PTL-6-479	750	0.500 (12.70)	0.275 (6.98)	13	3	0	●	●	●	●
PTL-6-495	750	0.500 (12.70)	0.275 (6.98)	13	3	0	●	✗	●	●
PTL-9-426	750	0.650 (16.51)	0.200 (5.08)	18	2	2	●	●	●	●
PTL-9-457	750	0.650 (16.51)	0.200 (5.08)	18	2	2	●	●	●	●
PTL-9-477	750	0.650 (16.51)	0.200 (5.08)	18	2	2	●	●	●	●
PTL-9-478	750	0.650 (16.51)	0.200 (5.08)	18	2	2	●	●	●	●
PTL-9-479	750	0.650 (16.51)	0.200 (5.08)	18	2	2	●	●	●	●
PTL-9-495	750	0.650 (16.51)	0.200 (5.08)	18	2	2	●	✗	●	●
PTL-10-426	750	0.750 (19.05)	0.250 (6.35)	20	2	2	●	●	●	●
PTL-10-457	750	0.750 (19.05)	0.250 (6.35)	20	2	2	●	●	●	●
PTL-10-477	750	0.750 (19.05)	0.250 (6.35)	20	2	2	●	●	●	●
PTL-10-478	750	0.750 (19.05)	0.250 (6.35)	20	2	2	●	●	●	●
PTL-10-479	750	0.750 (19.05)	0.250 (6.35)	20	2	2	●	●	●	●

* Any label two inches or larger is rotated on liner.

● Yes, this material will work with this application.

✗ No, this material does not work with this application.

▲ In extreme high temperatures, testing of these materials is recommended.

TLS 2200 / TLS PC LINK CIRCUIT BOARD AND COMPONENT IDENTIFICATION LABELS PORTABLE PRINTERS AND LABELS

TLS 2200® / TLS PC Link™ Circuit Board and Component Identification Labels

► POLYIMIDES

High Temperature Amber Polyimide (B-426),
 High Temperature White Polyimide (B-457),
 Static Dissipative Polyimide (B-477, B-478, B-479),
 High Temperature White PEN (B-495)

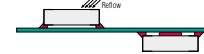
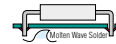
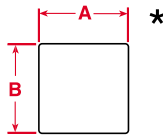

Part Number	Labels Per Roll	Label Dimensions		Maximum Characters Per Line For Font: 1	Maximum Lines Of Text For Font: 1	Maximum Bar Code Characters:	Through Hole Technology		SMT Top / Bottom	After Process
		A Inch (mm)	B Inch (mm)				Top	Bottom		
PTL-10-495	750	0.750 (19.05)	0.250 (6.35)	20	2	2	●	✘	●	●
PTL-13-426	750	0.900 (22.86)	0.250 (6.35)	25	2	4	●	●	●	●
PTL-13-457	750	0.900 (22.86)	0.250 (6.35)	25	2	4	●	●	●	●
PTL-13-478	750	0.900 (22.86)	0.250 (6.35)	25	2	4	●	●	●	●
PTL-13-479	750	0.900 (22.86)	0.250 (6.35)	25	2	4	●	●	●	●
PTL-13-495	750	0.900 (22.86)	0.250 (6.35)	25	2	4	●	✘	●	●
PTL-14-457	750	1.000 (25.40)	0.187 (4.74)	28	2	4	●	●	●	●
PTL-14-477	750	1.000 (25.40)	0.187 (4.74)	28	2	4	●	●	●	●
PTL-14-478	750	1.000 (25.40)	0.187 (4.74)	28	2	4	●	●	●	●
PTL-14-479	750	1.000 (25.40)	0.187 (4.74)	28	2	4	●	●	●	●
PTL-14-495	750	1.000 (25.40)	0.187 (4.74)	28	2	4	●	✘	●	●
PTL-16-426	500	1.000 (25.40)	0.375 (9.52)	28	4	4	●	●	●	●
PTL-16-457	500	1.000 (25.40)	0.375 (9.52)	28	4	4	●	●	●	●
PTL-16-478	500	1.000 (25.40)	0.375 (9.52)	28	4	4	●	●	●	●
PTL-16-479	500	1.000 (25.40)	0.375 (9.52)	28	4	4	●	●	●	●
PTL-16-495	500	1.000 (25.40)	0.375 (9.52)	28	4	4	●	✘	●	●
PTL-17-426	500	1.000 (25.40)	0.500 (12.70)	28	5	4	●	●	●	●
PTL-17-478	500	1.000 (25.40)	0.500 (12.70)	28	5	4	●	●	●	●
PTL-17-479	500	1.000 (25.40)	0.500 (12.70)	28	5	4	●	●	●	●
PTL-17-495	500	1.000 (25.40)	0.500 (12.70)	28	5	4	●	✘	●	●
PTL-25-426	750	1.250 (31.75)	0.250 (6.35)	35	2	6	●	●	●	●
PTL-25-457	750	1.250 (31.75)	0.250 (6.35)	35	2	6	●	●	●	●
PTL-25-477	750	1.250 (31.75)	0.250 (6.35)	35	2	6	●	●	●	●
PTL-25-478	750	1.250 (31.75)	0.250 (6.35)	35	2	6	●	●	●	●
PTL-25-479	750	1.250 (31.75)	0.250 (6.35)	35	2	6	●	●	●	●
PTL-25-495	750	1.250 (31.75)	0.250 (6.35)	35	2	6	●	✘	●	●
PTL-27-426	750	1.500 (38.10)	0.125 (3.175)	42	1	8	●	●	●	●
PTL-27-457	750	1.500 (38.10)	0.125 (3.175)	42	1	8	●	●	●	●
PTL-27-477	750	1.500 (38.10)	0.125 (3.175)	42	1	8	●	●	●	●
PTL-27-478	750	1.500 (38.10)	0.125 (3.175)	42	1	8	●	●	●	●
PTL-27-479	750	1.500 (38.10)	0.125 (3.175)	42	1	8	●	●	●	●
PTL-27-495	750	1.500 (38.10)	0.125 (3.175)	42	1	8	●	✘	●	●
PTL-28-426	750	1.500 (38.10)	0.250 (6.35)	42	2	8	●	●	●	●
PTL-28-457	750	1.500 (38.10)	0.250 (6.35)	42	2	8	●	●	●	●
PTL-28-477	750	1.500 (38.10)	0.250 (6.35)	42	2	8	●	●	●	●
PTL-28-478	750	1.500 (38.10)	0.250 (6.35)	42	2	8	●	●	●	●
PTL-28-479	750	1.500 (38.10)	0.250 (6.35)	42	2	8	●	●	●	●
PTL-28-495	750	1.500 (38.10)	0.250 (6.35)	42	2	8	●	✘	●	●

* Any label two inches or larger is rotated on liner.

- Yes, this material will work with this application.
- ✘ No, this material does not work with this application.
- ▲ In extreme high temperatures, testing of these materials is recommended.

► TEDLAR®

Flame-Retardant White Tedlar® (B-437)

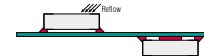
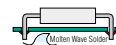
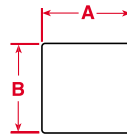

Part Number	Labels Per Roll	Label Dimensions		Maximum Characters Per Line For Font: 1	Maximum Lines Of Text For Font: 1	Maximum Bar Code Characters:	Through Hole Technology		SMT Top / Bottom	After Process
		A Inch (mm)	B Inch (mm)				Top	Bottom		
PTL-9-437	750	0.650 (16.51)	0.200 (5.08)	18	2	2	▲	✘	✘	●
PTL-10-437	750	0.750 (19.05)	0.250 (6.35)	20	2	2	▲	✘	✘	●
PTL-15-437	750	1.000 (25.40)	0.275 (6.98)	28	2	4	▲	✘	✘	●
PTL-29-437	500	1.500 (38.10)	0.500 (12.70)	42	5	8	▲	✘	✘	●

Tedlar® is a registered trademark of DuPont.

- Yes, this material will work with this application.
- ✘ No, this material does not work with this application.
- ▲ In extreme high temperatures, testing of these materials is recommended.

TLS 2200® / TLS PC Link™ Circuit Board and Component Identification Labels

TLS 2200 / TLS PC LINK CIRCUIT BOARD AND COMPONENT IDENTIFICATION LABELS PORTABLE PRINTERS AND LABELS

► POLYESTER

Permanent White Polyester (B-422, B-423, B-459)
 Static Dissipative Polyester (B-473)
 Permanent Metallized Polyester (B-428)

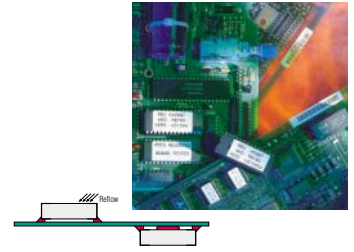
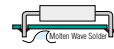
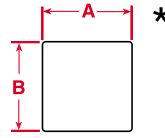

Part Number	Labels Per Roll	Label Dimensions		Maximum Characters Per Line For Font: 1	Maximum Lines Of Text For Font: 1	Maximum Bar Code Characters:	Through Hole Technology		SMT Top / Bottom	After Process
		A Inch (mm)	B Inch (mm)				Top	Bottom		
PTL-1-423	750	0.250 (6.35)	0.250 (6.35)	6	2	0	▲	✘	✘	●
PTL-1-473	750	0.250 (6.35)	0.250 (6.35)	6	2	0	▲	✘	✘	●
PTL-2-423	100	2.000 (50.80)	0.250 (6.35)	52	2	11	▲	✘	✘	●
PTL-3-423	500	0.375 (9.52)	0.375 (9.52)	10	4	0	▲	✘	✘	●
PTL-4-423	500	0.400 (10.16)	0.400 (10.16)	10	4	0	▲	✘	✘	●
PTL-5-423	750	0.500 (12.70)	0.200 (5.08)	13	2	0	▲	✘	✘	●
PTL-6-473	750	0.500 (12.70)	0.275 (6.98)	13	3	0	▲	✘	✘	●
PTL-6-423	750	0.500 (12.70)	0.275 (6.98)	13	3	0	▲	✘	✘	●
PTL-7-423	500	0.500 (12.70)	0.500 (12.70)	13	5	0	▲	✘	✘	●
PTL-5-473	750	0.500 (12.70)	0.200 (5.08)	13	2	0	▲	✘	✘	●
PTL-9-423	750	0.650 (16.51)	0.200 (5.08)	18	2	2	▲	✘	✘	●
PTL-9-473	750	0.650 (16.51)	0.200 (5.08)	18	2	2	▲	✘	✘	●
PTL-10-423	750	0.750 (19.05)	0.250 (6.35)	20	2	2	▲	✘	✘	●
PTL-10-473	750	0.750 (19.05)	0.250 (6.35)	20	2	2	▲	✘	✘	●
PTL-13-423	750	0.900 (22.86)	0.250 (6.35)	25	2	4	▲	✘	✘	●
PTL-14-423	750	1.000 (25.40)	0.187 (4.74)	28	2	4	▲	✘	✘	●
PTL-15-423	750	1.000 (25.40)	0.275 (6.98)	28	2	4	▲	✘	✘	●
PTL-15-428	750	1.000 (25.40)	0.275 (6.98)	28	2	4	▲	✘	✘	●
PTL-16-473	500	1.000 (25.40)	0.375 (9.52)	28	4	4	▲	✘	✘	●
PTL-16-423	500	1.000 (25.40)	0.375 (9.52)	28	4	4	▲	✘	✘	●
BPTL-16-423	5000	1.000 (25.40)	0.375 (9.52)	28	4	4	▲	✘	✘	●
PTL-17-473	500	1.000 (25.40)	0.500 (12.70)	28	5	4	▲	✘	✘	●
PTL-17-423	500	1.000 (25.40)	0.500 (12.70)	28	5	4	▲	✘	✘	●
PTL-17-428	500	1.000 (25.40)	0.500 (12.70)	28	5	4	▲	✘	✘	●
PTL-19-422	250	1.000 (25.40)	1.000 (25.40)	28	12	4	▲	✘	✘	●
PTL-19-423	250	1.000 (25.40)	1.000 (25.40)	28	12	4	▲	✘	✘	●
BPTL-19-423	2500	1.000 (25.40)	1.000 (25.40)	28	12	4	▲	✘	✘	●
PTL-20-423	100	2.000 (50.80)	1.000 (25.40)	52	12	11	▲	✘	✘	●
BPTL-20-423	1000	2.000 (50.80)	1.000 (25.40)	52	12	11	▲	✘	✘	●
PTL-20-459	100	2.000 (50.80)	1.000 (25.40)	52	12	11	▲	✘	✘	●
PTL-25-423	750	1.250 (31.75)	0.250 (6.35)	35	2	6	▲	✘	✘	●
PTL-26-423	100	2.750 (69.85)	1.250 (31.75)	50	13	18	▲	✘	✘	●
PTL-26-459	100	2.750 (69.85)	1.250 (31.75)	50	15	18	▲	✘	✘	●
PTL-27-423	750	1.500 (38.10)	0.125 (3.18)	42	1	8	▲	✘	✘	●
PTL-28-423	750	1.500 (38.10)	0.250 (6.35)	42	2	8	▲	✘	✘	●
PTL-28-473	750	1.500 (38.10)	0.250 (6.35)	42	2	8	▲	✘	✘	●
PTL-29-423	500	1.500 (38.10)	0.500 (12.70)	42	5	8	▲	✘	✘	●
BPTL-29-423	5000	1.500 (38.10)	0.500 (12.70)	42	5	8	▲	✘	✘	●
PTL-29-459	500	1.500 (38.10)	0.500 (12.70)	42	5	8	▲	✘	✘	●
PTL-30-459	250	1.500 (38.10)	0.750 (19.05)	42	9	8	▲	✘	✘	●
PTL-37-423	100	3.000 (76.20)	1.900 (48.26)	50	22	20	▲	✘	✘	●
PTL-38-423	100	4.000 (101.60)	1.900 (48.26)	50	22	25	▲	✘	✘	●
PTL-38-459	100	4.000 (101.60)	1.900 (48.26)	50	22	25	▲	✘	✘	●

* Any label two inches or larger is rotated on liner.

- Yes, this material will work with this application.
- ✘ No, this material does not work with this application.
- ▲ In extreme high temperatures, testing of these materials is recommended.

TLS 2200® / TLS PC Link™ Circuit Board and Component Identification Labels

► VINYL CLOTH

White Vinyl Cloth Repositional Adhesive (B-498)

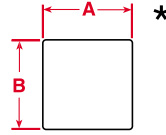

Part Number	Labels Per Roll	Label Dimensions		Maximum Characters Per Line For Font: 1	Maximum Lines Of Text For Font: 1	Through Hole Technology		SMT		After Process
		A Inch (mm)	B Inch (mm)			Top	Bottom	Top / Bottom	Bottom	
PTL-7-498	500	0.500 (12.70)	0.500 (12.70)	13	5	▲	✘	✘	✘	●
PTL-10-498	750	0.750 (19.05)	0.250 (6.35)	6	9	▲	✘	✘	✘	●
PTL-15-498	750	1.000 (25.40)	0.275 (6.98)	28	2	▲	✘	✘	✘	●
PTL-16-498	500	1.000 (25.40)	0.375 (9.52)	10	12	▲	✘	✘	✘	●
PTL-17-498	500	1.000 (25.40)	0.500 (12.70)	28	5	▲	✘	✘	✘	●
PTL-29-498	500	1.500 (38.10)	0.500 (12.70)	13	18	▲	✘	✘	✘	●
BPTL-29-498	5000	1.500 (38.10)	0.500 (12.70)	13	18	▲	✘	✘	✘	●
PTL-32-498	250	1.500 (38.10)	1.500 (38.10)	42	18	▲	✘	✘	✘	●

* Vinyl cloth material is not recommended for bar code printing.

- Yes, this material will work with this application.
- ✘ No, this material does not work with this application.
- ▲ In extreme high temperatures, testing of these materials is recommended.

HandiMark® Label Maker



- ▶ Create custom labels whenever and wherever you need them
- ▶ Versatile text capabilities for high visibility product, regulatory and instructional labeling needs
- ▶ Larger printing and larger tapes, up to 2.000" wide
- ▶ Widest range of print colors and material colors
- ▶ Fits in the palm of your hand
- ▶ Rugged construction designed for use in industrial environments
- ▶ Super-tough vinyl tapes are specially formulated to perform for years outdoors and in industrial environments
- ▶ Lightweight, weighs 2.2 lbs
- ▶ Runs on a rechargeable battery or AC power
- ▶ Patent # 5, 318, 370; 5, 918, 989' 5, 951, 177; 6, 113, 293; 6, 142, 686; D409, 230
- ▶ Alpha-numeric sequence
- ▶ 113 built-in symbols and pictos
- ▶ Type sizes 0.080" x 1.700"
- ▶ 12 operating languages
- ▶ 0.500", 1.000", 2.000" tape widths
- ▶ Outdoor grade vinyl tape (14 tape colors, 7 ribbon colors)
- ▶ Store 10,000 characters in memory or download from your PC

HandiMark Label Maker

Part Number	Description
42001	HandiMark Portable Label Maker*
42002	220 Volt HandiMark Portable Label Maker* International

* System includes printer, standard battery, battery charger, 25' roll of 2.000" tape, one black ribbon, hard carrying case and symbols reference chart

▶ ACCESSORIES

Part Number	Description
42008	Spare Battery (Std. Battery)
42006	AC Power Supply
42124	Quick Charger
42073	Super Charge*
42072	Mega Charge**
42009	Alcohol Cleaning Strips (5 per pkg.)
49199	Soft Case
42010	Spare Hard Carrying Case
42005	Protective Dust Cover for Printer
42004	PC Connecting Cable

*Contents: Quick charger and spare battery.

**Contents: Quick charger, spare battery and AC Power Supply.

▶ COMBO PACKAGES

Part Number	Description
20709	HandiMark®, MarkWare™, Cable Kit
80159	HandiMark®, LOTO toolbox, Lockout Pro Software
89235	HandiMark®, GlobalMark™ mono & ValuePlus Pkg.
89238	HandiMark®, GlobalMark™ color & ValuePlus Pkg.
89241	HandiMark®, GlobalMark™ color cut & ValuePlus Pkg.
30652	HandiMark®, PowerMark™ & ValuePlus Pkg.
89237	HandiMark®, GlobalMark™ mono, PowerMark™ & ValuePlus Combo Pkg.
89240	HandiMark®, GlobalMark™ color, PowerMark™ & ValuePlus Combo Pkg.
89243	HandiMark®, GlobalMark™ color cut, PowerMark™ & ValuePlus Combo Pkg.
42004	PC Connecting Cable

All PowerMark™ combo packages include the BLS1200 & serial cable

▶ SPECIFICATIONS

Print method	Thermal transfer (non smearing)
Weight	2.75 lbs. (1.25 kg)
Dimensions (L x W x H)	11.500 in x 4.250 in x 4.000 in (292.10 mm x 107.95 mm x 101.60 mm)
Power source	Rechargeable battery prints over 500 labels
Operating temperature	40° - 120° F (4° - 49° C)
Agency approvals	FCC Class A approved

▶ INDUSTRIAL GRADE PRINT RIBBONS

- ▶ Super-tough, smear-proof ribbons ensure your printed text lasts for years outdoors and in demanding environments
- ▶ One size ribbon fits all tape widths
- ▶ Available in seven colors



Size	Part Number						
	Black	White	Red	Blue	Green	Magenta	Yellow
2,000" x 75' (51 mm x 23 m)	42011	42012	42013	42014	42015	42016	42123

► **INDOOR/OUTDOOR GRADE VINYL TAPE (B-580)**

- ▶ Labels adhere well to pipes, walls, equipment, windows – most clean, dry surfaces
- ▶ Conforms well to irregular, curved or rough surfaces – it even stands up to grease, oil and most industrial chemicals
- ▶ Five-year average outdoor durability in temperatures from 180°F to -40°F (82°C to -40°C), can be applied as low as 0°F (-18°C)



Size	Part Number													
	White	Clear	Yellow	Green	Red	Blue	Lt. Blue	Orange	Black	Tan	Grey	Brown	Gold	Purple
0.500" x 50' (13 mm x 15.2 m)	42018	42076	42022	42026	42030	42034	—	42038	42042	—	42046	42050	42054	42058
1.000" x 50' (25 mm x 15.2 m)	42019	42077	42023	42027	42031	42035	42133	42039	42043	42135	42047	42051	42055	42059
2.000" x 50' (51 mm x 15.2m)	42021	42079	42025	42029	42033	42037	42134	42041	42045	42136	42049	42053	42057	42061

► **REFLECTIVE TAPE (B-584)**

- ▶ Suitable for indoor or outdoor use
- ▶ Reflective capabilities are ideal for reading labels in low light conditions with a flashlight or from a vehicle
- ▶ Applications include utility pole and box labeling, door labeling, labeling rooftop equipment and equipment that needs to be viewed from a road side



Size	Part Number		
	Reflective White	Reflective Orange	Reflective Yellow
1.000" x 33' (25.0 mm x 10.0 m)	42062	42066	42064
2.000" x 33' (51.0 mm x 10.0 m)	42063	42067	42065

► **ECONOMY POLYPROPYLENE TAPE (B-529)**

- ▶ Ideal, low-cost label
- ▶ For use indoors on smooth, flat surfaces
- ▶ Available in three sizes, white only



Size	Part Number
	White
0.500" x 50' (13.0 mm x 15.2 m)	42068
1.000" x 50' (25.0 mm x 15.2 m)	42069
2.000" x 50' (51.0 mm x 15.2 m)	42071

► **REPOSITIONABLE VINYL TAPE (B-581)**

- ▶ Vinyl tape has a special adhesive that allows easy removal of label to reapply again... and again
- ▶ Best choice for indoor marking where frequent repositioning is required, such as shelves



Size	Part Number	
	Yellow	White
0.500" x 50' (13.0 mm x 15.2 m)	42103	42100
1.000" x 50' (25.0 mm x 15.2 m)	42104	42101
2.000" x 50' (51.0 mm x 15.2 m)	42105	42102

► **TAMPER RESISTANT TAPE (B-530)**

- ▶ Tape destructs into tiny fragments when tampered with, making removal very tedious and difficult
- ▶ White only



Size	Part Number
	White
0.500" x 50' (13.0 mm x 15.2 m)	42137
1.000" x 50' (25.0 mm x 15.2 m)	42138
2.000" x 50' (51.0 mm x 15.2 m)	42139

Brady LS2000 / I.D. PRO Plus® Supplies

Brady still manufacturers and fully stocks the complete range of tapes, ribbons and accessories for the LS2000 Labeling System and I.D. PRO Plus Wire Marker Printer.



► RIBBONS

LS2000 Printer Ribbons

Part Number	Description
R5200	Black High-Performance Ribbon for all Labels and Sleeves
R2200	Black Solvent-Resistant Ribbon for PCB Applications

► ACCESSORIES

LS2000 Printer Accessories

Part Number	Description
LS2000-SC	Soft Side Carrying Case
LS2000-HC	Hard Side Carrying Case
LS2000-BC	Battery Charger
LS2000-BP	Battery Pack
LS2000-DTS	Download Package (3.5" disk only)
LS2000-AC	AC Adapter

► RIBBONS

I.D. PRO Plus Printer Ribbon

Part Number	Description
R5300	Black High-Performance Ribbon for PermaSleeve™ and DuraSleeve® (Darker print, less smear resistant)
<i>Introducing a more smear resistant ribbon</i>	
R7300	Black High-Performance Ribbon for all labels and BradySleeve™ (Lighter print, more smear resistant)

► ACCESSORIES

I.D. PRO Plus Printer Accessories

Part Number	Description
IDPRO-HC	Hard Side Carrying Case
IDPRO-BC12V	12-Volt Battery Charger (plugs into auto cigarette lighter)
IDPRO-BP	Battery Pack
IDPRO-BC	Battery Charger
PCK-4	Printer Cleaning Kit (50 self-saturating swabs)

BRADY LS2200 LABELING SYSTEM PORTABLE PRINTERS AND LABELS



LS2000-SC



LS2000-HC













IDPRO-HC





IDPRO-BC12V

Dot Matrix Portable Printer Materials Chart

Type	Max. Service Temp. °F (°C)	Color	Finish	Use	Special Properties
NYLON CLOTH					
B-499	193 (90)	White	Matte	Low profile through-conduit wire marker	Low-profile; permanent adhesive 
PAPER					
B-122	150 (66)	White	Matte	General labeling	Destroys on removal
POLYESTER					
B-619	311 (155)	White	Matte	Bar code labels	Solvent and heat resistant  
B-620	311 (155)	White	Matte	Tag for outdoor or harsh environments	Solvent, heat, abrasion resistant
B-621	221 (105)	Clear	Matte	Computer-printable overlamine	Transparent write-on coating
B-969	311 (155)	Silver	Matte	Metallized permanent label	Print receptive  
POLYIMIDE					
B-652	572 (300)	Amber	Matte	Top- or bottom-side board application for SMT or Through hole	Withstands extremely high temperatures
POLYOLEFIN					
B-319	221 (105)	White	Matte	Sleeve markers	Permanent, non-shrinkable
B-321	221 (105)	White/Yellow	Matte	Sleeve markers	Permanent, shrinkable
B-322	221 (105)	White/Yellow	Matte	Sleeve markers	Permanent, shrinkable, self-extinguishing
B-330	NA (NA)	White	Matte	Bundle, conduit and cable marking	Permanent, shrinkable; heat-activated adhesive
B-341	275 (135)	White	Matte	Wire marking	2-to-1 shrink ratio self-extinguishing sleeve; meets MIL-I-23053/5 Class 1; MIL-M-81531; MIL-STD-202F; METHOD 215 and UL224 
B-342	275 (135)	White/Yellow	Matte	Wire marking	3-to-1 shrink ratio self-extinguishing sleeve; meets MIL-I-23053/5 Class 1; MIL-M-81531; MIL-STD-202F; METHOD 215 and UL224 
POLYPROPYLENE					
B-389	212 (100)	White	Matte	Wire marking	Printable rigid inserts designed to be printed and affixed to a wire using carriers
TEDLAR® FILM					
B-632	266 (130)	White	Matte	Printable wire-marker	Self-extinguishing, smear-resistant
B-637	266 (130)	White/Yellow	Matte	Printable wire-marker	Self-extinguishing
VINYL					
B-292	150 (66)	White	Matte	Wire and cable labels	Heat and solvent resistant; conformable 
B-607	211 (100)	White	Matte	Non-removable applications	Tamper resistant  
VINYL CLOTH					
B-502	180 (82)	White	Matte	General marking	Oil, water and humidity resistant; permanent or removable

Tedlar® is a registered trademark of DuPont.

 *These materials are UL recognized.
 *These materials are CSA approved.

*Refer to the full page charts on pages 282-283 for more information and complete listing of parts.

UL and CSA approvals are based on use with R5300 ribbon.

I.D. PRO Plus® / Brady LS2000 Label Index by Part Number

I.D. PRO PLUS / BRADY LS2000 LABEL INDEX BY PART NUMBER PORTABLE PRINTERS AND LABELS

Part Number	Size Inch (mm)	Specifications on Page	Part Number	Size Inch (mm)	Specifications on Page	Part Number	Size Inch (mm)	Specifications on Page
CL-105-499	0.500 x 0.275 (12.70 x 7.00)	63	CL-517-619	1.500 x 0.750 (38.10 x 19.50)	64	DMIDP-111-389-YL	1.000 x 0.155 (25.40 x 3.93)	61
CL-105-502	0.500 x 0.275 (12.70 x 7.00)	63	CL-517-621	1.500 x 0.750 (38.10 x 19.50)	64	ECL-107-502	0.670 x 0.225 (17.02 x 5.72)	66
CL-105-607	0.500 x 0.275 (12.70 x 7.00)	63	CL-517-637	1.500 x 0.750 (38.10 x 19.50)	64	ECL-107-619	0.670 x 0.225 (17.02 x 5.72)	66
CL-105-619	0.500 x 0.275 (12.70 x 7.00)	63	CL-517-969	1.500 x 0.750 (38.10 x 19.50)	64	ECL-107-652	0.670 x 0.225 (17.02 x 5.72)	66
CL-105-621	0.500 x 0.275 (12.70 x 7.00)	63	CL-917-122	1.500 x 1.250 (38.10 x 31.75)	64	ECL-111-502	1.000 x 0.225 (25.40 x 5.72)	66
CL-105-652	0.500 x 0.275 (12.70 x 7.00)	63	CL-917-619	1.500 x 1.250 (38.10 x 31.75)	64	ECL-111-619	1.000 x 0.225 (25.40 x 5.72)	66
CL-105-969	0.500 x 0.275 (12.70 x 7.00)	63	CL-917-637	1.500 x 1.250 (38.10 x 31.75)	64	ECL-111-652	1.000 x 0.225 (25.40 x 5.72)	66
CL-111-122	1.000 x 0.275 (25.40 x 7.00)	63	CL-917-969	1.500 x 1.250 (38.10 x 31.75)	64	ECL-204-619	0.420 x 0.350 (10.67 x 8.89)	66
CL-111-499	1.000 x 0.275 (25.40 x 7.00)	63	CL-0309-502	0.650 x 0.187 (16.51 x 40.75)	63	ECL-204-652	0.420 x 0.350 (10.67 x 8.89)	66
CL-111-502	1.000 x 0.275 (25.40 x 7.00)	63	CL-0309-619	0.650 x 0.187 (16.51 x 40.75)	63	ECL-211-502	1.000 x 0.350 (25.40 x 8.89)	66
CL-111-607	1.000 x 0.275 (25.40 x 7.00)	63	CL-0311-619	0.800 x 0.200 (20.32 x 5.08)	63	ECL-211-619	1.000 x 0.350 (25.40 x 8.89)	66
CL-111-619	1.000 x 0.275 (25.40 x 7.00)	63	CL-0311-652	0.800 x 0.200 (20.32 x 5.08)	63	ECL-311-502	1.000 x 0.475 (25.40 x 12.07)	66
CL-111-619-BK	1.130 x 0.500 (28.70 x 12.70) - incl. 0.062 in Black Border	65	CL-0411-502	0.750 x 0.250 (19.05 x 6.35)	63	ECL-311-619	1.000 x 0.475 (25.40 x 12.07)	66
CL-111-621	1.000 x 0.275 (25.40 x 7.00)	63	CL-0411-619	0.750 x 0.250 (19.05 x 6.35)	63	PS-0231-094-WT	0.094 dia. x 2.000 (2.39 x 50.80)	59
CL-111-621-BK	1.130 x 0.500 (28.70 x 12.70) - incl. 0.062 in Black Border	65	CL-0411-652	0.750 x 0.250 (19.05 x 6.35)	63	PS-0231-125-WT	0.125 dia. x 2.000 (3.18 x 50.80)	59
CL-111-637	1.000 x 0.275 (25.40 x 7.00)	63	CL-0411-969	0.750 x 0.250 (19.05 x 6.35)	63	PS-0331-187-WT	0.187 dia. x 2.000 (4.75 x 50.80)	59
CL-111-652	1.000 x 0.275 (25.40 x 7.00)	63	CL-0413-619	0.900 x 0.250 (22.86 x 6.35)	63	PS-0531-250-WT	0.250 dia. x 2.000 (6.35 x 50.80)	59
CL-111-969	1.000 x 0.275 (25.40 x 7.00)	63	CL-0413-652	0.900 x 0.250 (22.86 x 6.35)	63	PS-0831-375-WT	0.375 dia. x 2.000 (9.53 x 50.80)	59
CL-111-969-BK	1.130 x 0.500 (28.70 x 12.70) - incl. 0.062 in Black Border	65	CL-0423-502	1.500 x 0.250 (38.10 x 6.35)	63	PS-1031-500-WT	0.500 dia. x 2.000 (12.70 x 50.80)	59
CL-117-499	1.500 x 0.275 (38.10 x 7.00)	63	CL-0423-619	1.500 x 0.250 (38.10 x 6.35)	63	PS-2231-1000-WT	1.000 dia. x 2.000 (25.40 x 50.80)	59
CL-117-502	1.500 x 0.275 (38.10 x 7.00)	63	CL-0423-652	1.500 x 0.250 (38.10 x 6.35)	63	PS-0231-094-YL	0.094 dia. x 2.000 (2.39 x 50.80)	59
CL-117-619	1.500 x 0.275 (38.10 x 7.00)	63	CL-0431-502	2.000 x 0.250 (50.80 x 6.35)	63	PS-0231-125-YL	0.125 dia. x 2.000 (3.18 x 50.80)	59
CL-117-621	1.500 x 0.275 (38.10 x 7.00)	63	CL-0431-619	2.000 x 0.250 (50.80 x 6.35)	63	PS-0331-187-YL	0.187 dia. x 2.000 (4.75 x 50.80)	59
CL-117-637	1.500 x 0.275 (38.10 x 7.00)	63	CL-0431-652	2.000 x 0.250 (50.80 x 6.35)	63	PS-0531-250-YL	0.250 dia. x 2.000 (6.35 x 50.80)	59
CL-117-652	1.500 x 0.275 (38.10 x 7.00)	63	CL-0431-969	2.000 x 0.250 (50.80 x 6.35)	63	PS-0831-375-YL	0.375 dia. x 2.000 (9.53 x 50.80)	59
CL-117-969	1.500 x 0.275 (38.10 x 7.00)	63	CL-0619-502	1.250 x 0.375 (31.75 x 9.53)	64	PS-1031-500-YL	0.500 dia. x 2.000 (12.70 x 50.80)	59
CL-211-499	1.000 x 0.400 (25.40 x 10.16)	63	CL-0619-619	1.250 x 0.375 (31.75 x 9.53)	64	PS-2231-1000-YL	1.000 dia. x 2.000 (25.40 x 50.80)	59
CL-211-502	1.000 x 0.400 (25.40 x 10.16)	63	CL-0619-969	1.250 x 0.375 (31.75 x 9.53)	64	PSBXP-111-125	0.125 dia. x 1.000 (3.18 x 25.40)	59
CL-211-619	1.000 x 0.400 (25.40 x 10.16)	63	CL-0807-619	0.500 x 0.500 (12.70 x 12.70)	63	PSBXP-111-187	0.187 dia. x 1.000 (4.75 x 25.40)	59
CL-211-621	1.000 x 0.400 (25.40 x 10.16)	63	CL-0807-969	0.500 x 0.500 (12.70 x 12.70)	63	PSBXP-114-125	0.125 dia. x 1.250 (3.18 x 31.75)	59
CL-211-637	1.000 x 0.400 (25.40 x 10.16)	64	CL-1429-619-BK	2.000 x 1.000 (50.80 x 25.40) - incl. 0.062 in Black Border	65	PSBXP-114-187	0.187 dia. x 1.250 (4.75 x 31.75)	59
CL-211-652	1.000 x 0.400 (25.40 x 10.16)	64	CL-1429-969-BK	2.000 x 1.000 (50.80 x 25.40) - incl. 0.062 in Black Border	65	PSBXP-211-250	0.250 dia. x 1.000 (6.35 x 25.40)	59
CL-217-619	1.000 x 0.400 (25.40 x 10.16)	64	CL-1631-502	2.000 x 1.000 (50.80 x 25.40)	64	PSBXP-214-250	0.250 dia. x 1.250 (6.35 x 31.75)	59
CL-217-621	1.000 x 0.400 (25.40 x 10.16)	64	CL-1631-619	2.000 x 1.000 (50.80 x 25.40)	64	PSBXP-311-375	0.375 dia. x 1.000 (9.53 x 25.40)	59
CL-217-637	1.000 x 0.400 (25.40 x 10.16)	64	CL-2439-502	2.500 x 1.500 (63.50 x 38.10)	64	PSBXP-314-375	0.375 dia. x 1.250 (9.53 x 31.75)	59
CL-217-969	1.000 x 0.400 (25.40 x 10.16)	64	CL-2439-502-YL	2.500 x 1.500 (63.50 x 38.10)	64	PSBXP-411-500	0.500 dia. x 1.000 (12.70 x 25.40)	59
CL-305-499	0.500 x 0.500 (12.70 x 12.70)	64	CL-2439-619	2.500 x 1.500 (63.50 x 38.10)	64	PSBXP-414-500	0.500 dia. x 1.250 (12.70 x 31.75)	59
CL-305-502	0.500 x 0.500 (12.70 x 12.70)	64	CL-2439-969	2.500 x 1.500 (63.50 x 38.10)	64	PSIDP-111-125	0.125 dia. x 1.000 (3.18 x 25.40)	59
CL-305-607	0.500 x 0.500 (12.70 x 12.70)	64	CLSL-111-502	1.000 x 0.500 (25.40 x 12.70)	65	PSIDP-111-187	0.187 dia. x 1.000 (4.75 x 25.40)	59
CL-305-619	0.500 x 0.500 (12.70 x 12.70)	64	CLWO-217-3	1.500 x 0.750 (38.10 x 19.05)	65	PSIDP-211-250	0.250 dia. x 1.000 (6.35 x 25.40)	59
CL-305-652	0.500 x 0.500 (12.70 x 12.70)	64	CLWO-217-6	1.500 x 0.500 (38.10 x 12.70)	65	PSIDP-311-375	0.375 dia. x 1.000 (9.53 x 25.40)	59
CL-305-969	0.500 x 0.500 (12.70 x 12.70)	64	CLWO-217-607	1.630 x 0.750 (41.40 x 19.05)	65	PSIDP-411-500	0.500 dia. x 1.000 (12.70 x 25.40)	59
CL-311-122	1.000 x 0.500 (25.40 x 12.70)	64	CLWO-217-7	1.500 x 0.500 (38.10 x 12.70)	65	PSIDP-111-125-YL	0.125 dia. x 1.000 (3.18 x 25.40)	59
CL-311-499	1.000 x 0.500 (25.40 x 12.70)	64	CLWO-217-969	1.630 x 0.750 (41.40 x 19.05)	65	PSIDP-111-187-YL	0.187 dia. x 1.000 (4.75 x 25.40)	59
CL-311-502	1.000 x 0.500 (25.40 x 12.70)	64	CLWO-317-1	1.500 x 0.500 (38.10 x 12.70)	65	PSIDP-211-250-YL	0.250 dia. x 1.000 (6.35 x 25.40)	59
CL-311-607	1.000 x 0.500 (25.40 x 12.70)	64	CLWO-317-2	1.500 x 0.500 (38.10 x 12.70)	65	PSIDP-311-375-YL	0.375 dia. x 1.000 (9.53 x 25.40)	59
CL-311-619	1.000 x 0.500 (25.40 x 12.70)	64	CLWO-317-4	1.500 x 0.500 (38.10 x 12.70)	65	PSIDP-411-500-YL	0.500 dia. x 1.000 (12.70 x 25.40)	59
CL-311-621	1.000 x 0.500 (25.40 x 12.70)	64	DM-105-389	0.500 x 0.155 (12.70 x 3.93)	61	PSL-1833-619-BK	2.250 X 1.250 (57.15 x 31.75) - incl. 0.062 in Black Border	62
CL-311-637	1.000 x 0.500 (25.40 x 12.70)	64	DM-105-389-YL	0.500 x 0.155 (12.70 x 3.93)	61	PSL-1833-969-BK	2.250 X 1.250 (57.15 x 31.75) - incl. 0.062 in Black Border	62
CL-311-652	1.000 x 0.500 (25.40 x 12.70)	64	DM-111-389	1.000 x 0.155 (25.40 x 3.93)	61	PSL-311-122	1.000 x 0.500 (25.40 x 12.70)	62
CL-311-969	1.000 x 0.500 (25.40 x 12.70)	64	DM-111-389-YL	1.000 x 0.155 (25.40 x 3.93)	61	PSL-311-619	1.000 x 0.500 (25.40 x 12.70)	62
CL-317-122	1.500 x 0.500 (38.10 x 12.70)	64	DM-117-389	1.500 x 0.155 (38.10 x 3.93)	61	PSL-311-969	1.000 x 0.500 (25.40 x 12.70)	62
CL-317-499	1.500 x 0.500 (38.10 x 12.70)	64	DM-117-389-YL	1.500 x 0.155 (38.10 x 3.93)	61	PSL-514-619	1.250 x 0.750 (31.75 x 19.05)	62
CL-317-502	1.500 x 0.500 (38.10 x 12.70)	64	DMC-1-3-15	0.590 (15.00)	61	PSL-514-969	1.250 x 0.750 (31.75 x 19.05)	62
CL-317-619	1.500 x 0.500 (38.10 x 12.70)	64	DMC-1-3-30	1.180 (30.00)	61	TB03-502-281	0.281 x 30 ft (7.14 x 914 m)	62
CL-317-619-BK	1.630 x 0.750 (41.45 x 19.05) - incl. 0.062 in Black Border	65	DMC-2-5/5-15	0.590 (15.00)	61	TB03-502-312	0.312 x 30 ft (7.92 x 914 m)	62
CL-317-621	1.500 x 0.500 (38.10 x 12.70)	64	DMC-2-5/5-30	1.180 (30.00)	61	TB05-502-375	0.375 x 30 ft (9.53 x 914 m)	62
CL-317-621-BK	1.630 x 0.750 (41.45 x 19.05) - incl. 0.062 in Black Border	65	DMC-4/10-15	0.590 (15.00)	61	WML-117-502-PF	1.500 x 0.275 (38.10 x 7.00)	58
CL-317-637	1.500 x 0.500 (38.10 x 12.70)	64	DMC-4/10-30	1.180 (30.00)	61	WML-202-292-4S	0.250 x 0.750 (6.35 x 19.05) - 4 Across	58
CL-317-969-BK	1.630 x 0.750 (41.45 x 19.05) - incl. 0.062 in Black Border	65	DMC-8/16-15	0.590 (15.00)	61	WML-205-292-1	0.500 x 1.000 (12.70 x 25.40)	57
CL-511-122	1.000 x 0.750 (25.40 x 19.50)	64	DMC-8/16-30	1.180 (30.00)	61	WML-205-292-2S	0.500 x 0.750 (12.70 x 19.05) - 2 Across	58
CL-517-122	1.500 x 0.750 (38.10 x 19.50)	64	DMIDP-105-389	0.500 x 0.155 (12.70 x 3.93)	61	WML-205-292-75	0.500 x 0.750 (12.70 x 19.05)	57
			DMIDP-105-389-YL	0.500 x 0.155 (12.70 x 3.93)	61	WML-211-292-1	1.000 x 1.000 (25.40 x 25.40)	57
			DMIDP-111-389	1.000 x 0.155 (25.40 x 3.93)	61			

I.D. PRO Plus® / Brady LS2000 Label Index by Part Number

Part Number	Size Inch (mm)	Specifications on Page	Part Number	Size Inch (mm)	Specifications on Page	Part Number	Size Inch (mm)	Specifications on Page
WML-211-292-1-BL	1.000 x 1.000 (25.40 x 25.40)	57	WML-511-499	1.000 x 0.750 (25.40 x 19.05)	57	WML-2411-502	0.800 x 1.500 (20.32 x 38.10)	57
WML-211-292-1-BR	1.000 x 1.000 (25.40 x 25.40)	57	WML-511-502	1.000 x 0.750 (25.40 x 19.05)	57	WML-2431-292-60	2.000 x 6.000 (50.80 x 152.40)	56
WML-211-292-1-GR	1.000 x 1.000 (25.40 x 25.40)	57	WML-511-632	1.000 x 0.750 (25.40 x 19.05)	57	WML-2431-292-60-BL	2.000 x 6.000 (50.80 x 152.40)	56
WML-211-292-1-GY	1.000 x 1.000 (25.40 x 25.40)	57	WML-517-292	1.500 x 2.500 (38.10 x 63.50)	56	WML-2431-292-60-BR	2.000 x 6.000 (50.80 x 152.40)	56
WML-211-292-1-OR	1.000 x 1.000 (25.40 x 25.40)	57	WML-517-292-BL	1.500 x 2.500 (38.10 x 63.50)	56	WML-2431-292-60-GR	2.000 x 6.000 (50.80 x 152.40)	56
WML-211-292-1-PL	1.000 x 1.000 (25.40 x 25.40)	57	WML-517-292-BR	1.500 x 2.500 (38.10 x 63.50)	56	WML-2431-292-60-GY	2.000 x 6.000 (50.80 x 152.40)	56
WML-211-292-1-RD	1.000 x 1.000 (25.40 x 25.40)	57	WML-517-292-GR	1.500 x 2.500 (38.10 x 63.50)	56	WML-2431-292-60-OR	2.000 x 6.000 (50.80 x 152.40)	56
WML-211-292-1-YL	1.000 x 1.000 (25.40 x 25.40)	57	WML-517-292-GY	1.500 x 2.500 (38.10 x 63.50)	56	WML-2431-292-60-PL	2.000 x 6.000 (50.80 x 152.40)	56
WML-211-292-75	1.000 x 0.750 (25.40 x 19.05)	57	WML-517-292-OR	1.500 x 2.500 (38.10 x 63.50)	56	WML-2431-292-60-RD	2.000 x 6.000 (50.80 x 152.40)	56
WML-211-292-75-BL	1.000 x 0.750 (25.40 x 19.05)	57	WML-517-292-PL	1.500 x 2.500 (38.10 x 63.50)	56	WML-2431-292-60-YL	2.000 x 6.000 (50.80 x 152.40)	56
WML-211-292-75-BR	1.000 x 0.750 (25.40 x 19.05)	57	WML-517-292-RD	1.500 x 2.500 (38.10 x 63.50)	56	WML-2431-292-75	2.000 x 7.500 (50.80 x 190.50)	56
WML-211-292-75-GR	1.000 x 0.750 (25.40 x 19.05)	57	WML-517-292-YL	1.500 x 2.500 (38.10 x 63.50)	56	WML-2431-292-75-BL	2.000 x 7.500 (50.80 x 190.50)	56
WML-211-292-75-GY	1.000 x 0.750 (25.40 x 19.05)	57	WML-517-499	1.500 x 0.750 (38.10 x 19.05)	57	WML-2431-292-75-BR	2.000 x 7.500 (50.80 x 190.50)	56
WML-211-292-75-OR	1.000 x 0.750 (25.40 x 19.05)	57	WML-517-502	1.500 x 0.750 (38.10 x 19.05)	57	WML-2431-292-75-GR	2.000 x 7.500 (50.80 x 190.50)	56
WML-211-292-75-PL	1.000 x 0.750 (25.40 x 19.05)	57	WML-705-499	0.500 x 1.000 (12.70 x 25.40)	57	WML-2431-292-75-GY	2.000 x 7.500 (50.80 x 190.50)	56
WML-211-292-75-RD	1.000 x 0.750 (25.40 x 19.05)	57	WML-705-502	0.500 x 1.000 (12.70 x 25.40)	57	WML-2431-292-75-OR	2.000 x 7.500 (50.80 x 190.50)	56
WML-211-292-75-YL	1.000 x 0.750 (25.40 x 19.05)	57	WML-705-632	0.500 x 1.000 (12.70 x 25.40)	57	WML-2431-292-75-PL	2.000 x 7.500 (50.80 x 190.50)	56
WML-302-292-4S	0.250 x 1.250 (6.35 x 31.75) - 4 Across	58	WML-711-292	1.000 x 4.000 (25.40 x 101.60)	56	WML-2431-292-75-RD	2.000 x 7.500 (50.80 x 190.50)	56
WML-305-292	0.500 x 1.250 (12.70 x 31.75)	57	WML-711-292-BL	1.000 x 4.000 (25.40 x 101.60)	56	WML-2431-292-75-YL	2.000 x 7.500 (50.80 x 190.50)	56
WML-305-292-2S	0.500 x 1.250 (12.70 x 31.75) - 2 Across	58	WML-711-292-BR	1.000 x 4.000 (25.40 x 101.60)	56	WMS-105-319	0.500 x 0.350 (12.70 x 8.90)	60
WML-305-499	0.500 x 0.500 (12.70 x 12.70)	57	WML-711-292-GR	1.000 x 4.000 (25.40 x 101.60)	56	WMS-105-321	0.500 x 0.350 (12.70 x 8.90)	60
WML-305-502	0.500 x 0.500 (12.70 x 12.70)	57	WML-711-292-GY	1.000 x 4.000 (25.40 x 101.60)	56	WMS-105-322	0.500 x 0.350 (12.70 x 8.90)	60
WML-305-632	0.500 x 0.500 (12.70 x 12.70)	57	WML-711-292-OR	1.000 x 4.000 (25.40 x 101.60)	56	WMS-111-319	1.000 x 0.350 (25.40 x 8.90)	60
WML-308-292-2S	0.750 x 1.250 (19.05 x 31.75) - 2 Across	58	WML-711-292-PL	1.000 x 4.000 (25.40 x 101.60)	56	WMS-111-321	1.000 x 0.350 (25.40 x 8.90)	60
WML-311-292	1.000 x 1.250 (25.40 x 31.75)	57	WML-711-292-RD	1.000 x 4.000 (25.40 x 101.60)	56	WMS-111-322	1.000 x 0.350 (25.40 x 8.90)	60
WML-311-292-BL	1.000 x 1.250 (25.40 x 31.75)	57	WML-711-292-YL	1.000 x 4.000 (25.40 x 101.60)	56	WMS-117-319	1.500 x 0.350 (38.10 x 8.90)	60
WML-311-292-BR	1.000 x 1.250 (25.40 x 31.75)	57	WML-711-499	1.000 x 1.000 (25.40 x 25.40)	57	WMS-117-321	1.500 x 0.350 (38.10 x 8.90)	60
WML-311-292-GR	1.000 x 1.250 (25.40 x 31.75)	57	WML-711-502	1.000 x 1.000 (25.40 x 25.40)	57	WMS-117-322	1.500 x 0.350 (38.10 x 8.90)	60
WML-311-292-GY	1.000 x 1.250 (25.40 x 31.75)	57	WML-711-632	1.000 x 1.000 (25.40 x 25.40)	57	WMS-205-319	0.500 x 0.500 (12.70 x 12.70)	60
WML-311-292-OR	1.000 x 1.250 (25.40 x 31.75)	57	WML-717-292	1.500 x 4.000 (38.10 x 101.60)	56	WMS-205-321	0.500 x 0.500 (12.70 x 12.70)	60
WML-311-292-PL	1.000 x 1.250 (25.40 x 31.75)	57	WML-717-292-BL	1.500 x 4.000 (38.10 x 101.60)	56	WMS-205-322	0.500 x 0.500 (12.70 x 12.70)	60
WML-311-292-RD	1.000 x 1.250 (25.40 x 31.75)	57	WML-717-292-BR	1.500 x 4.000 (38.10 x 101.60)	56	WMS-211-319	1.000 x 0.500 (25.40 x 12.70)	60
WML-311-292-YL	1.000 x 1.250 (25.40 x 31.75)	57	WML-717-292-GR	1.500 x 4.000 (38.10 x 101.60)	56	WMS-211-321	1.000 x 0.500 (25.40 x 12.70)	60
WML-317-292	1.500 x 1.250 (38.10 x 31.75)	57	WML-717-292-GY	1.500 x 4.000 (38.10 x 101.60)	56	WMS-211-322	1.000 x 0.500 (25.40 x 12.70)	60
WML-502-502-2S	0.250 x 0.750 (6.35 x 19.05) - 2 Across	58	WML-717-292-OR	1.500 x 4.000 (38.10 x 101.60)	56	WMS-217-319	1.000 x 0.500 (25.40 x 12.70)	60
WML-502-502-4S	0.250 x 0.750 (6.35 x 19.05) - 4 Across	58	WML-717-292-PL	1.500 x 4.000 (38.10 x 101.60)	56	WMS-217-321	1.000 x 0.500 (25.40 x 12.70)	60
WML-505-499	0.500 x 0.750 (12.70 x 19.05)	57	WML-717-292-RD	1.500 x 4.000 (38.10 x 101.60)	56	WMS-217-322	1.500 x 0.500 (38.10 x 12.70)	60
WML-505-499-2S	0.500 x 0.750 (12.70 x 19.05) - 2 Across	58	WML-717-292-YL	1.500 x 4.000 (38.10 x 101.60)	56	WMS-411-319	1.000 x 0.750 (25.40 x 19.05)	60
WML-505-502	0.500 x 0.750 (12.70 x 19.05)	57	WML-902-502-2S	0.250 x 1.250 (6.35 x 31.75) - 2 Across	58	WMS-411-321	1.000 x 0.750 (25.40 x 19.05)	60
WML-505-502-2S	0.500 x 0.750 (12.70 x 19.05) - 2 Across	58	WML-902-502-4S	0.250 x 1.250 (6.35 x 31.75) - 4 Across	58	WMS-411-322	1.000 x 0.750 (25.40 x 19.05)	60
WML-505-632	0.500 x 0.750 (12.70 x 19.05)	57	WML-905-499	0.500 x 1.250 (12.70 x 31.75)	57	WMS-417-319	1.500 x 0.750 (38.10 x 25.40)	60
WML-508-502-2S	0.750 x 0.750 (19.05 x 19.05) - 2 Across	58	WML-905-499-2S	0.500 x 1.250 (12.70 x 31.75) - 2 Across	58	WMS-417-321	1.500 x 0.750 (38.10 x 25.40)	60
WML-511-292	1.000 x 2.500 (25.40 x 63.50)	56	WML-905-502	0.500 x 1.250 (12.70 x 31.75)	57	WMS-417-322	1.500 x 0.750 (38.10 x 25.40)	60
WML-511-292-BL	1.000 x 2.500 (25.40 x 63.50)	56	WML-905-502-2S	0.500 x 1.250 (12.70 x 31.75) - 2 Across	58	WMS-611-319	1.000 x 1.000 (25.40 x 25.40)	60
WML-511-292-BR	1.000 x 2.500 (25.40 x 63.50)	56	WML-905-632	0.500 x 1.250 (12.70 x 31.75)	57	WMS-611-321	1.000 x 1.000 (25.40 x 25.40)	60
WML-511-292-GR	1.000 x 2.500 (25.40 x 63.50)	56	WML-911-499	1.000 x 1.250 (25.40 x 31.75)	57	WMS-611-322	1.000 x 1.000 (25.40 x 25.40)	60
WML-511-292-GY	1.000 x 2.500 (25.40 x 63.50)	56	WML-911-502	1.000 x 1.250 (25.40 x 31.75)	57	WMS-617-319	1.500 x 1.000 (38.10 x 25.40)	60
WML-511-292-OR	1.000 x 2.500 (25.40 x 63.50)	56	WML-911-632	1.000 x 1.250 (25.40 x 31.75)	57	WMS-617-321	1.500 x 1.000 (38.10 x 25.40)	60
WML-511-292-PL	1.000 x 2.500 (25.40 x 63.50)	56	WML-917-499	1.500 x 1.250 (38.10 x 31.75)	57	WMS-617-322	1.500 x 1.000 (38.10 x 25.40)	60
WML-511-292-RD	1.000 x 2.500 (25.40 x 63.50)	56	WML-917-502	1.500 x 1.250 (38.10 x 31.75)	57	WMT-313-620	1.750 x 0.625 (44.45 x 15.88)	62
WML-511-292-YL	1.000 x 2.500 (25.40 x 63.50)	56	WML-0811-292	0.800 x 1.500 (20.32 x 38.10)	57	WMT-713-620	1.750 x 1.125 (44.45 x 28.58)	62
			WML-1215-292	1.000 x 2.250 (25.40 x 57.15)	56	WRCM-711-637-WT	1.000 x 50 ft (25.40 x 15.24 m)	56
			WML-1231-292-22	2.000 x 2.250 (50.80 x 57.15)	56	WRCM-711-637-YL	1.000 x 50 ft (25.40 x 15.24 m)	56
			WML-1231-292-30	2.000 x 3.000 (50.80 x 76.20)	56	WRCM-717-637-WT	1.500 x 50 ft (38.10 x 15.24 m)	56
						WRCM-717-637-YL	1.500 x 50 ft (38.10 x 15.24 m)	56

PORTABLE PRINTERS AND LABELS I.D. PRO PLUS / BRADY LS2000 LABEL INDEX BY PART NUMBER

I.D. PRO Plus®, Brady LS2000 and BradyMarker™ XC Plus Labels

I.D. PRO PLUS, BRADY LS2000 AND BRADYMARKER XC PLUS LABELS PORTABLE PRINTERS AND LABELS

PRINTER MODEL	
PRO	= ID PRO/PRO Plus
LS	= LS2000
BMXC	= BradyMarker XC Plus
ALL	= All ID PRO, LS2000, BMXC

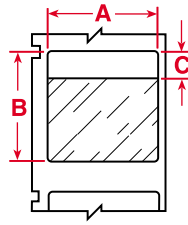

CABLE MARKING LABELS

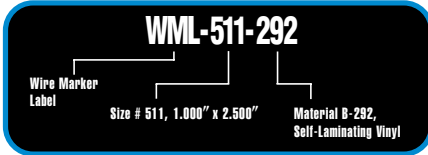

PART NUMBER EXPLANATION:

Most Brady part numbers for portable printer labels follow the same three-part format:

The first code indicates the application, the second part is a number indicating the die size used (where applicable), the third part indicates the Brady material used.

Self-Laminating White/Transparent Vinyl (B-292)

Part Number	Portable Printer Model	Labels Per Roll	Label Width		Label Height		Write-On Height C	Maximum Lines of Print (PRO/LS)	Maximum Characters Across	
			Inch (mm) A	(mm)	Inch (mm) B	(mm)			Large (PRO/LS)	Small (PRO/LS)
WML-511-292**	ALL	100	1.000 (25.40)	2.500 (63.50)	0.750 (19.05)	4/5	7/7	10/15		
WML-517-292**	ALL	100	1.500 (38.10)	2.500 (63.50)	0.750 (19.05)	4/5	10/11	15/23		
WML-711-292**	ALL	100	1.000 (25.40)	4.000 (101.60)	1.000 (25.40)	6/7	7/7	10/15		
WML-717-292**	ALL	100	1.500 (38.10)	4.000 (101.60)	1.000 (25.40)	6/7	10/11	15/23		
WML-1215-292	LS	250	1.000 (25.40)	2.250 (57.15)	0.750 (19.05)	6	7	15		
WML-1231-292-22	LS	250	2.000 (50.80)	2.250 (57.15)	0.750 (19.05)	6	15	31		
WML-1231-292-30	LS	100	2.000 (50.80)	3.000 (76.20)	0.750 (19.05)	6	15	31		
WML-2431-292-60**	LS	75	2.000 (50.80)	6.000 (152.40)	1.500 (38.10)	12	15	31		
WML-2431-292-75**	LS	75	2.000 (50.80)	7.500 (190.50)	1.500 (38.10)	12	15	31		

** Also available in: BL=blue, BR=brown, GR=green, GY=grey, OR=orange, PL=purple, RD=red, YL=yellow. Standard product: Contact your Brady Identification Solutions distributor or Customer Service representative for ordering information.

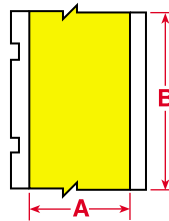

White or Yellow Tedlar® Film (B-637)

Part Number	Portable Printer Model	Roll Length Ft. (m)	Label Width		Label Height		Maximum Lines of Print	Maximum Characters Across	
			Inch (mm) A	(mm)	Feet (m) B	(m)		Large	Small
WRCM-711-637-WT*	LS/BMXC	50 ft (15.24 m)	1.000 (25.40)	50 ft (15.24 m)	9	7	15		
WRCM-711-637-YL*	LS/BMXC	50 ft (15.24 m)	1.000 (25.40)	50 ft (15.24 m)	9	7	15		
WRCM-717-637-WT*	LS/BMXC	50 ft (15.24 m)	1.500 (38.10)	50 ft (15.24 m)	9	11	23		
WRCM-717-637-YL*	LS/BMXC	50 ft (15.24 m)	1.500 (38.10)	50 ft (15.24 m)	9	11	23		

Tedlar® is a registered trademark of DuPont.

*Roll-form cable marking. Cut to length.

PORTABLE PRINTERS AND LABELS

I.D. PRO Plus®, Brady LS2000 and BradyMarker™ XC Plus Labels

PRINTER MODEL

PRO = ID PRO/PRO Plus

LS = LS2000

BMXC = BradyMarker XC Plus

ALL = All ID PRO, LS2000, BMXC

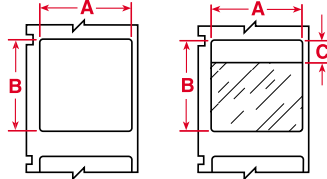

► WIRE MARKING LABELS

Part Number	Portable Printer Model	Labels Per Roll	Label Material	Label Width Inch (mm) A	Label Height Inch (mm) B	Write-On Height C	Maximum Lines Of Print (PRO/LS)	Maximum Characters Across Large (PRO/LS)	Maximum Characters Across Small (PRO/LS)
6 to 10 Gauge Wire (AWG) Based on THHN Wire — Maximum Wire Diameter - 0.260 in (6.60 mm)									
WML-905-502	ALL	250	Vinyl Cloth	0.500 (12.70)	1.250 (31.75)	N/A	8/10	3/3	4/7
WML-905-499	ALL	250	Nylon Cloth	0.500 (12.70)	1.250 (31.75)	N/A	8/9	3/3	4/7
WML-905-632	ALL	250	Tedlar®	0.500 (12.70)	1.250 (31.75)	N/A	8/9	3/3	4/7
WML-305-292	ALL	250	Self-Laminating Vinyl	0.500 (12.70)	1.250 (31.75)	0.500 (12.70)	3/4	3/3	4/7
WML-2411-502	LS	250	Vinyl Cloth	0.800 (20.32)	1.500 (38.10)	N/A	12	5	11
WML-0811-292	LS	250	Self-Laminating Vinyl	0.800 (20.32)	1.500 (38.10)	0.500 (12.70)	4	5	11
WML-911-499	ALL	250	Nylon Cloth	1.000 (25.40)	1.250 (31.75)	N/A	8/9	7/7	10/15
WML-911-502	ALL	250	Vinyl Cloth	1.000 (25.40)	1.250 (31.75)	N/A	8/10	7/7	10/15
WML-911-632	ALL	250	Tedlar	1.000 (25.40)	1.250 (31.75)	N/A	8/9	7/7	10/15
WML-311-292**	ALL	250	Self-Laminating Vinyl	1.000 (25.40)	1.250 (31.75)	0.500 (12.70)	3/4	7/7	10/15
WML-917-499	ALL	250	Nylon Cloth	1.500 (38.10)	1.250 (31.75)	N/A	8/9	10/11	15/23
WML-917-502	ALL	250	Vinyl Cloth	1.500 (38.10)	1.250 (31.75)	N/A	8/9	10/11	15/23
WML-317-292	ALL	250	Self-Laminating Vinyl	1.500 (38.10)	1.250 (31.75)	0.500 (12.70)	3/4	10/11	15/23
10 to 12 Gauge Wire (AWG) Based on THHN Wire — Maximum Wire Diameter - 0.210 in (5.30 mm)									
WML-705-499	ALL	250	Nylon Cloth	0.500 (12.70)	1.000 (25.40)	N/A	6/7	3/3	4/7
WML-705-502	ALL	250	Vinyl Cloth	0.500 (12.70)	1.000 (25.40)	N/A	6/8	3/3	4/7
WML-705-632	ALL	250	Tedlar	0.500 (12.70)	1.000 (25.40)	N/A	6/7	3/3	4/7
WML-205-292-1	ALL	250	Self-Laminating Vinyl	0.500 (12.70)	1.000 (25.40)	0.375 (9.53)	2/3	3/3	4/7
WML-711-499	ALL	250	Nylon Cloth	1.000 (25.40)	1.000 (25.40)	N/A	6/7	7/7	10/15
WML-711-502	ALL	250	Vinyl Cloth	1.000 (25.40)	1.000 (25.40)	N/A	6/8	7/7	10/15
WML-711-632	ALL	250	Tedlar	1.000 (25.40)	1.000 (25.40)	N/A	6/7	7/7	10/15
WML-211-292-1**	ALL	250	Self-Laminating Vinyl	1.000 (25.40)	1.000 (25.40)	0.375 (9.53)	2/3	7/7	10/15
10 to 16 Gauge Wire (AWG) Based on THHN Wire — Maximum Wire Diameter - 0.160 in (4.10 mm)									
WML-505-499	ALL	250	Nylon Cloth	0.500 (12.70)	0.750 (19.05)	N/A	4/8	3/3	4/7
WML-505-502	ALL	250	Vinyl Cloth	0.500 (12.70)	0.750 (19.05)	N/A	4/8	3/3	4/7
WML-505-632	ALL	250	Tedlar	0.500 (12.70)	0.750 (19.05)	N/A	4/8	3/3	4/7
WML-205-292-75	ALL	250	Self-Laminating Vinyl	0.500 (12.70)	0.750 (19.05)	0.375 (9.53)	2/3	3/3	4/7
WML-511-499	ALL	250	Nylon Cloth	1.000 (25.40)	0.750 (19.05)	N/A	4/5	7/7	10/15
WML-511-502	ALL	250	Vinyl Cloth	1.000 (25.40)	0.750 (19.05)	N/A	4/8	7/7	10/15
WML-511-632	ALL	250	Tedlar	1.000 (25.40)	0.750 (19.05)	N/A	4/5	7/7	10/15
WML-211-292-75**	ALL	250	Self-Laminating Vinyl	1.000 (25.40)	0.750 (19.05)	0.375 (9.53)	2/3	7/7	10/15
WML-517-499	ALL	250	Nylon Cloth	1.500 (38.10)	0.750 (19.05)	N/A	4/5	10/11	15/23
WML-517-502	ALL	250	Vinyl Cloth	1.500 (38.10)	0.750 (19.05)	N/A	4/5	10/11	15/23
16 to 22 Gauge Wire (AWG) Based on THHN Wire — Maximum Wire Diameter - 0.110 in (2.80 mm)									
WML-305-499	ALL	500	Nylon Cloth	0.500 (12.70)	0.500 (12.70)	N/A	3/3	3/3	4/7
WML-305-502	ALL	500	Vinyl Cloth	0.500 (12.70)	0.500 (12.70)	N/A	3/4	3/3	4/7
WML-305-632	ALL	500	Tedlar	0.500 (12.70)	0.500 (12.70)	N/A	3/4	3/3	4/7

Tedlar® is a registered trademark of DuPont.

**Also available in: BL=blue, BR=brown, GR=green, GY=grey, OR=orange, PL=purple, RD=red, YL=yellow.

Standard product: Contact your Brady Identification Solutions distributor or Customer Service representative for ordering information.

I.D. PRO Plus®, Brady LS2000 and BradyMarker™ XC Plus Labels

I.D. PRO PLUS, BRADY LS2000 AND BRADYMARKER XC PLUS LABELS PORTABLE PRINTERS AND LABELS

PRINTER MODEL	
PRO	= ID PRO/PRO Plus
LS	= LS2000
BMXC	= BradyMarker XC Plus
ALL	= All ID PRO, LS2000, BMXC

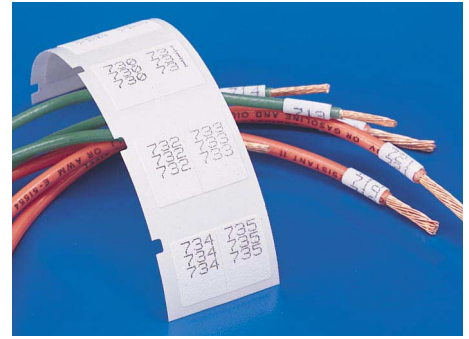
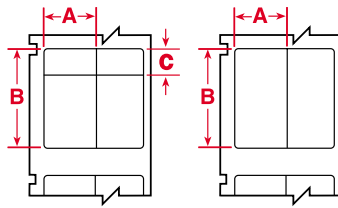

► MULTIPLE-ACROSS WIRE MARKING STRIPS

White Vinyl Cloth (B-502), White/Transparent Self-Laminating Vinyl (B-292), Nylon Cloth (B-499)

Part Number	Marker Size Code	Quantity Per Roll Strips	Number of Strips Across	Marker Strip Inch (mm) A	Dimension B	Write-On Height C	Wire Gauge*	Maximum Lines of Print (PRO/LS)	Maximum Characters Across Large (PRO/LS)	Small (PRO/LS)
WML-205-292-2S	ALL	500	2	0.500 (12.70)	0.750 (19.05)	0.400 (10.16)	10-14	2/2	3/3	4/7
WML-305-292-2S	ALL	500	2	0.500 (12.70)	1.250 (31.75)	0.520 (13.21)	6-10	3/3	3/3	4/3
WML-308-292-2S	ALL	500	2	0.750 (19.05)	1.250 (31.75)	0.500 (12.70)	6-10	3/3	5/5	7/11
WML-505-499-2S	ALL	250	2	0.500 (12.70)	0.750 (19.05)	N/A	10-14	4/5	3/5	4/7
WML-505-502-2S	ALL	500	2	0.500 (12.70)	0.750 (19.05)	N/A	10-14	4/5	3/5	4/7
WML-508-502-2S	ALL	500	2	0.750 (19.05)	0.750 (19.05)	N/A	10-16	4/5	3/5	7/11
WML-905-499-2S	ALL	500	2	0.500 (12.70)	1.250 (31.75)	N/A	6-10	8/9	3/3	4/7
WML-905-502-2S	ALL	500	2	0.500 (12.70)	1.250 (31.75)	N/A	6-10	8/9	3/3	4/7
WML-502-502-2S	LS/BMXC	500	2	0.250 (6.35)	0.750 (19.05)		10-14	5	1	3
WML-502-502-4S	LS/BMXC	1000	4	0.250 (6.35)	0.750 (19.05)		10-14	5	1	3
WML-902-502-2S	LS/BMXC	500	2	0.250 (6.35)	1.250 (31.75)		6-10	9	1	3
WML-902-502-4S	LS/BMXC	1000	4	0.250 (6.35)	1.250 (31.75)		6-10	9	1	3
WML-202-292-4S	LS/BMXC	1000	4	0.250 (6.35)	0.750 (19.05)	0.400 (10.16)	10-14	2	1	3
WML-302-292-4S	LS/BMXC	1000	4	0.250 (6.35)	1.250 (31.75)	0.520 (13.21)	6-10	3	1	3

*Based on THHN wire.

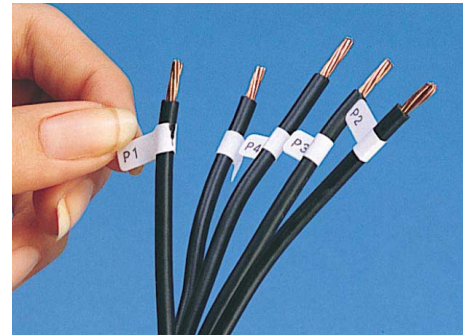
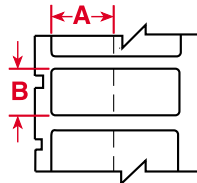

► TEMPORARY WIRE MARKER FLAG

Removable Vinyl Cloth (B-502)

Part Number	Portable Printer Model	Labels Per Roll	Label Width Inch (mm) A	Label Height Inch (mm) B	Maximum Lines of Print (PRO/LS)	Maximum Characters Across Large (PRO/LS)	Small (PRO/LS)
WML-117-502-PF	ALL	500	1.500 (38.10)	0.275 (7.00)	1/1	10/11	15/23

PORTABLE PRINTERS AND LABELS

I.D. PRO Plus®, Brady LS2000 and BradyMarker™ XC Plus Labels

PRINTER MODEL
PRO = ID PRO/PRO Plus
LS = LS2000
BMXC = BradyMarker XC Plus
ALL = All ID PRO, LS2000, BMXC

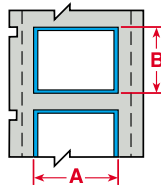

▶ PERMASLEEVE™ WIRE MARKING SLEEVES

Heat-Shrink White Polyolefin (B-342)

Part Number	Portable Printer Model	Sleeves Per Roll	Range of Wire Dia. Inch (mm)		Approx. Wire Gauge*	Sleeve Dimension Inch (mm)		Maximum Lines of Print (PRO/LS)	Maximum Characters Across	
			Min.	Max.		A	B		Large (PRO/LS)	Small (PRO/LS)
1000" Marker Width										
PSIDP-111-125	ALL	100	0.046 (1.17)	0.110 (2.79)	22-16	1.000 (25.40)	0.235 (6.00)	1/1	8/7	11/15
PSIDP-111-187	ALL	100	0.062 (1.57)	0.150 (3.81)	18-12	1.000 (25.40)	0.335 (8.50)	1/1	8/7	11/15
PSIDP-211-250	ALL	100	0.094 (2.39)	0.215 (5.46)	16-10	1.000 (25.40)	0.439 (11.20)	2/2	8/7	11/15
PSIDP-311-375	ALL	100	0.125 (3.18)	0.320 (8.13)	12-6	1.000 (25.40)	0.645 (16.40)	3/3	8/7	11/15
PSIDP-411-500	ALL	100	0.187 (4.75)	0.450 (11.43)	8-1	1.000 (25.40)	0.851 (21.60)	4/4	8/7	11/15
PSBXP-111-125	LS/BMXC	500	0.046 (1.17)	0.110 (2.79)	22-16	1.000 (25.40)	0.235 (5.97)	1	7	15
PSBXP-111-187	LS/BMXC	500	0.062 (1.57)	0.150 (3.81)	18-12	1.000 (25.40)	0.335 (8.51)	1	7	15
PSBXP-211-250	LS/BMXC	500	0.094 (2.39)	0.215 (5.46)	16-10	1.000 (25.40)	0.439 (11.15)	2	7	15
PSBXP-311-375	LS/BMXC	250	0.125 (3.18)	0.320 (8.13)	12-6	1.000 (25.40)	0.645 (16.38)	3	7	15
PSBXP-411-500	LS/BMXC	250	0.187 (4.75)	0.450 (11.43)	8-1	1.000 (25.40)	0.851 (21.62)	4	7	15
1250" Marker Width										
PSBXP-114-125	LS/BMXC	500	0.046 (1.17)	0.110 (2.79)	22-16	1.250 (31.75)	0.235 (5.97)	1	10	19
PSBXP-114-187	LS/BMXC	500	0.062 (1.57)	0.150 (3.81)	18-12	1.250 (31.75)	0.335 (8.51)	1	10	19
PSBXP-214-250	LS/BMXC	500	0.094 (2.39)	0.215 (5.46)	16-10	1.250 (31.75)	0.439 (11.15)	2	10	19
PSBXP-314-375	LS/BMXC	250	0.125 (3.18)	0.320 (8.13)	12-6	1.250 (31.75)	0.645 (16.38)	3	10	19
PSBXP-414-500	LS/BMXC	250	0.187 (4.75)	0.450 (11.43)	8-1	1.250 (31.75)	0.851 (21.62)	4	10	19
2.000" Marker Width										
PS-0231-094-WT	LS	500	0.047 (1.19)	0.080 (2.03)	18-16	2.000 (50.80)	0.182 (4.62)	1	15	31
PS-0231-125-WT	LS	500	0.046 (1.17)	0.110 (2.79)	22-16	2.000 (50.80)	0.235 (5.97)	1	15	31
PS-0331-187-WT	LS	500	0.062 (1.57)	0.150 (3.81)	18-12	2.000 (50.80)	0.335 (8.51)	1	15	31
PS-0531-250-WT	LS	500	0.094 (2.39)	0.215 (5.46)	16-10	2.000 (50.80)	0.439 (11.15)	2	15	31
PS-0831-375-WT	LS	250	0.125 (3.18)	0.320 (8.13)	12-6	2.000 (50.80)	0.645 (16.38)	4	15	31
PS-1031-500-WT	LS	250	0.187 (4.75)	0.450 (11.43)	8-1	2.000 (50.80)	0.851 (21.62)	5	15	31
PS-2231-1000-WT**	LS	100	0.450 (11.43)	0.950 (24.13)	1-500	2.000 (50.80)	1.660 (42.16)	11	15	31

Heat-Shrink Yellow Polyolefin (B-342)

Part Number	Portable Printer Model	Sleeves Per Roll	Range of Wire Dia. Inch (mm)		Approx. Wire Gauge*	Sleeve Dimension Inch (mm)		Maximum Lines of Print (PRO/LS)	Maximum Characters Across	
			Min.	Max.		A	B		Large (PRO/LS)	Small (PRO/LS)
1000" Marker Width										
PSIDP-111-125-YL	ALL	100	0.046 (1.17)	0.110 (2.79)	22-16	1.000 (25.40)	0.235 (6.00)	1/1	8/15	11/31
PSIDP-111-187-YL	ALL	100	0.062 (1.57)	0.150 (3.81)	18-12	1.000 (25.40)	0.335 (8.50)	1/1	8/15	11/31
PSIDP-211-250-YL	ALL	100	0.094 (2.39)	0.215 (5.46)	16-10	1.000 (25.40)	0.439 (11.20)	2/2	8/15	11/31
PSIDP-311-375-YL	ALL	100	0.125 (3.18)	0.320 (8.13)	12-6	1.000 (25.40)	0.645 (16.40)	3/3	8/15	11/31
PSIDP-411-500-YL	ALL	100	0.187 (4.75)	0.450 (11.43)	8-1	1.000 (25.40)	0.851 (21.60)	4/4	8/15	11/31
PS-0231-094-YL	LS	500	0.023 (0.58)	0.080 (2.03)	28-18	2.000 (50.80)	0.182 (4.62)	1	15	31
PS-0231-125-YL	LS	500	0.046 (1.17)	0.110 (2.79)	22-16	2.000 (50.80)	0.235 (5.97)	1	15	31
PS-0331-187-YL	LS	500	0.062 (1.57)	0.150 (3.81)	18-12	2.000 (50.80)	0.335 (8.51)	1	15	31
PS-0531-250-YL	LS	500	0.094 (2.39)	0.215 (5.46)	16-10	2.000 (50.80)	0.439 (11.15)	2	15	31
PS-0831-375-YL	LS	250	0.125 (3.18)	0.320 (8.13)	12-6	2.000 (50.80)	0.645 (16.38)	4	15	31
PS-1031-500-YL	LS	250	0.187 (4.75)	0.450 (11.43)	8-1	2.000 (50.80)	0.851 (21.62)	5	15	31
PS-2231-1000-YL**	LS	100	0.450 (11.43)	0.950 (24.13)	1-500	2.000 (50.80)	1.660 (42.16)	5	15	31

**Material is B-341

*Based on National Electric Code insulation measurement of THHN wire.

I.D. PRO Plus®, Brady LS2000 and BradyMarker™ XC Plus Labels

PRINTER MODEL

- PRO = ID PRO/PRO Plus
- LS = LS2000
- BMXC = BradyMarker XC Plus
- ALL = All ID PRO, LS2000, BMXC

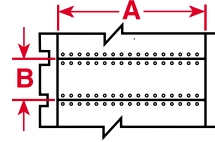

► **BRADYSLEEVE™ WIRE MARKING SLEEVES**

WMS Series – Non-Shrink White Polyolefin (B-319)

Part Number	Portable Printer Model	Sleeves Per Roll	Range of Wire Dia. Inch (mm)		Approx. Wire Gauge*	Sleeve Dimension Inch (mm)		Maximum Lines of Print (PRO/LS)	Maximum Characters Across	
			Min.	Max.		A	B		Large (PRO/LS)	Small (PRO/LS)
WMS-105-319	ALL	500	0.075 (1.90)	0.130 (3.30)	12-18	0.500 (12.70)	0.350 (8.90)	1/1	3/3	4/7
WMS-111-319	ALL	500	0.075 (1.90)	0.130 (3.30)	12-18	1.000 (25.40)	0.350 (8.90)	1/1	7/7	10/15
WMS-117-319	ALL	500	0.075 (1.90)	0.130 (3.30)	12-18	1.500 (38.10)	0.350 (8.90)	1/1	10/11	15/23
WMS-205-319	ALL	500	0.130 (3.30)	0.235 (5.97)	8-10	0.500 (12.70)	0.500 (12.70)	2/2	3/3	4/7
WMS-211-319	ALL	500	0.130 (3.30)	0.235 (5.97)	8-10	1.000 (25.40)	0.500 (12.70)	2/2	7/7	10/15
WMS-217-319	ALL	500	0.130 (3.30)	0.235 (5.97)	8-10	1.500 (38.10)	0.500 (12.70)	2/2	10/11	15/23
WMS-411-319	ALL	500	0.235 (5.97)	0.375 (9.50)	3-6	1.000 (25.40)	0.750 (19.05)	4/4	7/7	10/15
WMS-417-319	ALL	500	0.235 (5.97)	0.375 (9.50)	3-6	1.500 (38.10)	0.750 (19.05)	4/4	10/11	15/23
WMS-611-319	ALL	250	0.375 (9.50)	0.540 (13.72)	2/0-2	1.000 (25.40)	1.000 (25.40)	6/6	7/7	10/15
WMS-617-319	ALL	250	0.375 (9.50)	0.540 (13.72)	2/0-2	1.500 (38.10)	1.000 (25.40)	6/6	10/11	15/23

WMS Series – Heat-Shrink White Polyolefin (B-321)

Part Number	Portable Printer Model	Sleeves Per Roll	Range of Wire Dia. Inch (mm)		Approx. Wire Gauge*	Sleeve Dimension Inch (mm)		Maximum Lines of Print (PRO/LS)	Maximum Characters Across	
			Min.	Max.		A	B		Large (PRO/LS)	Small (PRO/LS)
WMS-105-321	ALL	500	0.075 (1.90)	0.130 (3.30)	12-18	0.500 (12.70)	0.350 (8.90)	1/1	3/3	4/7
WMS-111-321	ALL	500	0.075 (1.90)	0.130 (3.30)	12-18	1.000 (25.40)	0.350 (8.90)	1/1	7/7	10/15
WMS-117-321	ALL	500	0.075 (1.90)	0.130 (3.30)	12-18	1.500 (38.10)	0.350 (8.90)	1/1	10/11	15/23
WMS-205-321	ALL	500	0.130 (3.30)	0.235 (5.97)	8-10	0.500 (12.70)	0.500 (12.70)	2/2	3/3	4/7
WMS-211-321	ALL	500	0.130 (3.30)	0.235 (5.97)	8-10	1.000 (25.40)	0.500 (12.70)	2/2	7/7	10/15
WMS-217-321	ALL	500	0.130 (3.30)	0.235 (5.97)	8-10	1.500 (38.10)	0.500 (12.70)	2/2	10/11	15/23
WMS-411-321	ALL	500	0.235 (5.97)	0.375 (9.50)	3-6	1.000 (25.40)	0.750 (19.05)	4/4	7/7	10/15
WMS-417-321	ALL	500	0.235 (5.97)	0.375 (9.50)	3-6	1.500 (38.10)	0.750 (19.05)	4/4	10/11	15/23
WMS-611-321	ALL	250	0.375 (9.50)	0.540 (13.72)	2/0-2	1.000 (25.40)	1.000 (25.40)	6/6	7/7	10/15
WMS-617-321	ALL	250	0.375 (9.50)	0.540 (13.72)	2/0-2	1.500 (38.10)	1.000 (25.40)	6/6	10/11	15/23

WMS Series – Self-Extinguishing White Polyolefin (B-322)

Part Number	Portable Printer Model	Sleeves Per Roll	Range of Wire Dia. Inch (mm)		Approx. Wire Gauge*	Sleeve Dimension Inch (mm)		Maximum Lines of Print (PRO/LS)	Maximum Characters Across	
			Min.	Max.		A	B		Large (PRO/LS)	Small (PRO/LS)
WMS-105-322	ALL	500	0.075 (1.90)	0.130 (3.30)	12-18	0.500 (12.70)	0.350 (8.90)	1/1	3/3	4/7
WMS-111-322	ALL	500	0.075 (1.90)	0.130 (3.30)	12-18	1.000 (25.40)	0.350 (8.90)	1/1	7/7	10/15
WMS-117-322	ALL	500	0.075 (1.90)	0.130 (3.30)	12-18	1.500 (38.10)	0.350 (8.90)	1/1	10/11	15/23
WMS-205-322	ALL	500	0.130 (3.30)	0.235 (5.97)	8-10	0.500 (12.70)	0.500 (12.70)	2/2	3/3	4/7
WMS-211-322	ALL	500	0.130 (3.30)	0.235 (5.97)	8-10	1.000 (25.40)	0.500 (12.70)	2/2	7/7	10/15
WMS-217-322	ALL	500	0.130 (3.30)	0.235 (5.97)	8-10	1.500 (38.10)	0.500 (12.70)	2/2	10/11	15/23
WMS-411-322	ALL	500	0.235 (5.97)	0.375 (9.50)	3-6	1.000 (25.40)	0.750 (19.05)	4/4	7/7	10/15
WMS-417-322	ALL	500	0.235 (5.97)	0.375 (9.50)	3-6	1.500 (38.10)	0.750 (19.05)	4/4	10/11	15/23
WMS-611-322	ALL	250	0.375 (9.50)	0.540 (13.72)	2/0-2	1.000 (25.40)	1.000 (25.40)	6/6	7/7	10/15
WMS-617-322	ALL	250	0.375 (9.50)	0.540 (13.72)	2/0-2	1.500 (38.10)	1.000 (25.40)	6/6	10/11	15/23

*Based on National Electric Code insulation measurement of THHN wire.

I.D. PRO PLUS, BRADY LS2000 AND BRADYMARKER XC PLUS LABELS PORTABLE PRINTERS AND LABELS

I.D. PRO Plus®, Brady LS2000 and BradyMarker™ XC Plus Labels

PRINTER MODEL
PRO = ID PRO/PRO Plus
LS = LS2000
BMXC = BradyMarker XC Plus
ALL = All ID PRO, LS2000, BMXC

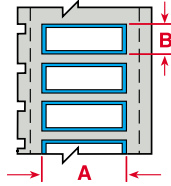

► **DURASLEEVE® WIRE MARKING INSERTS**

Polypropylene Inserts (B-389)

Part Number	Portable Printer Model	Inserts Per Roll	Insert Dimension Inch (mm)		Maximum Lines of Print	Maximum Characters Across Small
			A	B		
DMIDP-105-389	PRO	100	0.500 (12.70)	0.155 (3.93)	1	4
DMIDP-105-389-YL*	PRO	100	0.500 (12.70)	0.155 (3.93)	1	4
DMIDP-111-389	PRO	100	1.000 (25.40)	0.155 (3.93)	1	10
DMIDP-111-389-YL*	PRO	100	1.000 (25.40)	0.155 (3.93)	1	10
0.500" (12.70 mm) Insert Width						
DM-105-389	LS	500	0.500 (12.70)	0.155 (3.93)	1	7
DM-105-389-YL*	LS	500	0.500 (12.70)	0.155 (3.93)	1	7
1.000" (25.40 mm) Insert Width						
DM-111-389	LS	500	1.000 (25.40)	0.155 (3.93)	1	15
DM-111-389-YL*	LS	500	1.000 (25.40)	0.155 (3.93)	1	15
1.500" (38.10 mm) Insert Width						
DM-117-389	LS	500	1.500 (38.10)	0.155 (3.93)	1	23
DM-117-389-YL*	LS	500	1.500 (38.10)	0.155 (3.93)	1	23

*Yellow product is designated with a "YL" at the end of the part number.

► **DURASLEEVE® WIRE MARKING CARRIERS**

Part Number	Carrier Length Inches (mm)	Wire O.D. Inches (mm)	Type THHN Approximate Wire Gauge	Carriers per Box
DMC-1.3/3-15	0.590 (15.00)	0.051 (1.30) – 0.118 (3.00)	20 – 12	1000
DMC-1.3/3-30	1.180 (30.00)	0.051 (1.30) – 0.118 (3.00)	20 – 12	500
DMC-2.5/5-15	0.590 (15.00)	0.098 (2.50) – 0.197 (5.00)	16 – 10	1000
DMC-2.5/5-30	1.180 (30.00)	0.098 (2.50) – 0.197 (5.00)	16 – 10	500
DMC-4/10-15	0.590 (15.00)	0.157 (4.00) – 0.393 (10.00)	10 – 4	500
DMC-4/10-30	1.180 (30.00)	0.157 (4.00) – 0.393 (10.00)	10 – 4	200
DMC-8/16-15	0.590 (15.00)	0.315 (8.00) – 0.630 (16.00)	6 – 250	500
DMC-8/16-30	1.180 (30.00)	0.315 (8.00) – 0.630 (16.00)	6 – 250	200

I.D. PRO Plus®, Brady LS2000 and BradyMarker™ XC Plus Labels

I.D. PRO PLUS, BRADY LS2000 AND BRADYMARKER XC PLUS LABELS PORTABLE PRINTERS AND LABELS

PRINTER MODEL
PRO = ID PRO/PRO Plus
LS = LS2000
BMXC = BradyMarker XC Plus
ALL = All ID PRO, LS2000, BMXC

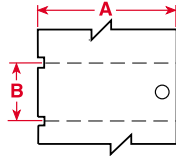

► BRADYTAG® PRINTABLE TAGS

White Polyester (B-620)

Part Number	Portable Printer Model	Tags Per Roll	Tag Dimension Inch (mm)		Maximum Lines of Print (LS/BMXC)	Maximum Characters Across Large (LS/BMXC)	Maximum Characters Across Small (LS/BMXC)
			A	B			
WMPT-313-620	LS/BMXC	500	1.750 (44.45)	0.625 (15.88)	3/3	8/8	17/17
WMPT-713-620	LS/BMXC	250	1.750 (44.45)	1.125 (28.58)	7/7	8/8	17/17

► TERMINAL BLOCK MARKERS

White Vinyl Cloth (B-502)

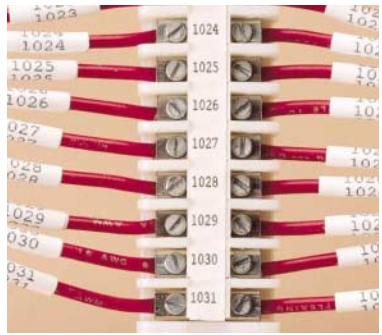
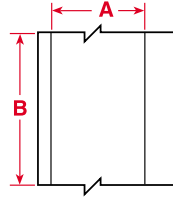

Part Number	Portable Printer Model	Roll Length Ft. (m)	Label Width Inch (mm)		Label Height Inch (mm)		Maximum Lines of Print	Maximum Characters Across Large	Maximum Characters Across Small
			A	B	B	C			
TB03-502-281	LS	30 ft (9.14 m)	0.281 (7.14)	30 ft (9.14 m)	1	1	3		
TB03-502-312	LS	30 ft (9.14 m)	0.312 (7.92)	30 ft (9.14 m)	1	1	3		
TB05-502-375	LS	30 ft (9.14 m)	0.375 (9.53)	30 ft (9.14 m)	1	2	5		

*First two digits of size code may change, depending on number of lines you need on your marker.
 (Example: entering 0403 would give you 4 lines of half height or 2 lines of normal height print.)

► PERMASHIELD™* LABELS

White Paper (B-122), White Polyester (B-619), Metallized Polyester (B-969)

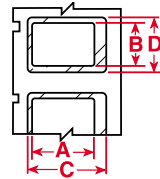

Part Number	Portable Printer Model	Labels Per Roll	Marker Label Material	Label Width Inch (mm)		Label Height Inch (mm)		Overlamine Inch (mm)	Dimensions	Maximum Lines of Print (PRO/LS)	Maximum Characters Across Large (PRO/LS)	Maximum Characters Across Small (PRO/LS)
				A	B	B	C					
PSL-311-122	ALL	250	Paper	1.000 (25.40)	0.500 (12.70)	1.060 (26.92)	0.750 (19.05)	3/3	7/7	10/15		
PSL-311-619	ALL	250	Polyester	1.000 (25.40)	0.500 (12.70)	1.060 (26.92)	0.750 (19.05)	3/3	7/7	10/15		
PSL-311-969	ALL	250	Metallized Polyester	1.000 (25.40)	0.500 (12.70)	1.060 (26.92)	0.750 (19.05)	3/3	7/7	10/15		
PSL-514-619	LS	250	Polyester	1.250 (31.75)	0.750 (19.05)	1.500 (38.10)	1.000 (25.40)	5	9	19		
PSL-514-969	LS	250	Metallized Polyester	1.250 (31.75)	0.750 (19.05)	1.500 (38.10)	1.000 (25.40)	5	9	19		
PSL-1833-619-BK	LS	250	Polyester	2.250 (57.15)	1.250 (31.75)	2.500 (63.50)	1.500 (38.10)	9	16	33		
PSL-1833-969-BK	LS	250	Metallized Polyester	2.250 (57.15)	1.250 (31.75)	2.500 (63.50)	1.500 (38.10)	9	16	33		

* This product is sold in Japan only under the Overlamine Labels name and not under the PermaShield name.

PORTABLE PRINTERS AND LABELS

I.D. PRO Plus®, Brady LS2000 and BradyMarker™ XC Plus Labels

PRINTER MODEL	
PRO	= ID PRO/PRO Plus
LS	= LS2000
BMXC	= BradyMarker XC Plus
ALL	= All ID PRO, LS2000, BMXC

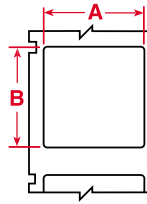

For use on components in control panels, electronic components and circuit boards, faceplates and electronic receptacles.



COMPONENT AND GENERAL IDENTIFICATION LABELS

Part Number	Portable Printer Model	Labels Per Roll	Label Material	Label Width Inch (mm) A	Label Height Inch (mm) B	Maximum Lines of Print (PRO/LS)	Maximum Characters Across Large (PRO/LS)	Maximum Characters Across Small (PRO/LS)
CL-105-499	ALL	500	Nylon Cloth	0.500 (12.70)	0.275 (7.00)	1/1	3/3	4/7
CL-105-502	ALL	500	Vinyl Cloth	0.500 (12.70)	0.275 (7.00)	1/1	3/3	4/7
CL-105-607	ALL	500	Tamper-Proof Vinyl	0.500 (12.70)	0.275 (7.00)	1/1	3/3	4/7
CL-105-619	ALL	500	Polyester	0.500 (12.70)	0.275 (7.00)	1/1	3/3	4/7
CL-105-621	ALL	500	Translucent Polyester	0.500 (12.70)	0.275 (7.00)	1/1	3/3	4/7
CL-105-652	ALL	500	Polyimide	0.500 (12.70)	0.275 (7.00)	1/1	3/3	4/7
CL-105-969	ALL	500	Metallized Polyester	0.500 (12.70)	0.275 (7.00)	1/1	3/3	4/7
CL-0807-619	LS	500	Polyester	0.500 (12.70)	0.500 (12.70)	4	3	7
CL-0807-969	LS	500	Metallized Polyester	0.500 (12.70)	0.500 (12.70)	4	3	7
CL-0309-502	LS	500	Vinyl Cloth	0.650 (16.51)	0.187 (4.75)	1	4	9
CL-0309-619	LS	500	Polyester	0.650 (16.51)	0.187 (4.75)	1	4	9
CL-0311-619	LS	500	Polyester	0.800 (20.32)	0.200 (5.08)	1	5	11
CL-0311-652	LS	500	Polyimide Film	0.800 (20.32)	0.200 (5.08)	1	5	11
CL-0411-502	LS	500	Vinyl Cloth	0.750 (19.05)	0.250 (6.35)	2	5	11
CL-0411-619	LS	500	Polyester	0.750 (19.05)	0.250 (6.35)	2	5	11
CL-0411-652	LS	500	Polyimide Film	0.750 (19.05)	0.250 (6.35)	2	5	11
CL-0411-969	LS	500	Metallized Polyester	0.750 (19.05)	0.250 (6.35)	2	5	11
CL-0413-619	LS	500	Polyester	0.900 (22.86)	0.250 (6.35)	2	6	13
CL-0413-652	LS	500	Polyimide	0.900 (22.86)	0.250 (6.35)	2	6	13
CL-111-122	ALL	500	Paper	1.000 (25.40)	0.275 (7.00)	1/1	7/7	10/15
CL-111-499	ALL	500	Nylon Cloth	1.000 (25.40)	0.275 (7.00)	1/1	7/7	10/15
CL-111-502	ALL	500	Vinyl Cloth	1.000 (25.40)	0.275 (7.00)	1/1	7/7	10/15
CL-111-607	ALL	500	Tamper-Proof Vinyl	1.000 (25.40)	0.275 (7.00)	1/1	7/7	10/15
CL-111-619	ALL	500	Polyester	1.000 (25.40)	0.275 (7.00)	1/1	7/7	10/15
CL-111-621	ALL	500	Translucent Polyester	1.000 (25.40)	0.275 (7.00)	1/1	7/7	10/15
CL-111-637	ALL	500	Tedlar®	1.000 (25.40)	0.275 (7.00)	1/1	7/7	10/15
CL-111-652	ALL	500	Polyimide	1.000 (25.40)	0.275 (7.00)	1/1	7/7	10/15
CL-111-969	ALL	500	Metallized Polyester	1.000 (25.40)	0.275 (7.00)	1/1	7/7	10/15
CL-0423-502	LS	500	Vinyl Cloth	1.500 (38.10)	0.250 (6.35)	2	11	23
CL-0423-619	LS	500	Polyester	1.500 (38.10)	0.250 (6.35)	2	11	23
CL-0423-652	LS	500	Polyimide Film	1.500 (38.10)	0.250 (6.35)	2	11	23
CL-117-499	ALL	500	Nylon Cloth	1.500 (38.10)	0.275 (7.00)	1/1	10/11	15/23
CL-117-502	ALL	500	Vinyl Cloth	1.500 (38.10)	0.275 (7.00)	1/1	10/11	15/23
CL-117-619	ALL	500	Polyester	1.500 (38.10)	0.275 (7.00)	1/1	10/11	15/23
CL-117-621	ALL	500	Translucent Polyester	1.500 (38.10)	0.275 (7.00)	1/1	10/11	15/23
CL-117-637	ALL	500	Tedlar	1.500 (38.10)	0.275 (7.00)	1/1	10/11	15/23
CL-117-652	ALL	500	Polyimide	1.500 (38.10)	0.275 (7.00)	1/1	10/11	15/23
CL-117-969	ALL	500	Metallized Polyester	1.500 (38.10)	0.275 (7.00)	1/1	10/11	15/23
CL-0431-502	LS	500	Vinyl Cloth	2.000 (50.80)	0.250 (6.35)	1/1	10/11	15/23
CL-0431-619	LS	500	Polyester	2.000 (50.80)	0.250 (6.35)	2	15	31
CL-0431-652	LS	500	Polyimide Film	2.000 (50.80)	0.250 (6.35)	2	15	31
CL-0431-969	LS	500	Metallized Polyester	2.000 (50.80)	0.250 (6.35)	2	15	31
CL-211-499	ALL	500	Nylon Cloth	1.000 (25.40)	0.400 (10.16)	2/2	7/7	10/15
CL-211-502	ALL	500	Vinyl Cloth	1.000 (25.40)	0.400 (10.16)	2/2	7/7	10/15
CL-211-619	ALL	500	Polyester	1.000 (25.40)	0.400 (10.16)	2/2	7/7	10/15
CL-211-621	ALL	500	Translucent Polyester	1.000 (25.40)	0.400 (10.16)	2/2	7/7	10/15

Tedlar® is a registered trademark of DuPont.

I.D. PRO Plus®, Brady LS2000 and BradyMarker™ XC Plus Labels

PRINTER MODEL

- PRO** = ID PRO/PRO Plus
- LS** = LS2000
- BMXC** = BradyMarker XC Plus
- ALL** = All ID PRO, LS2000, BMXC

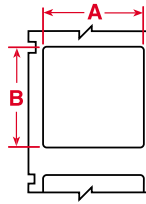

For use on components in control panels, electronic components and circuit boards, faceplates and electronic receptacles.



► COMPONENT AND GENERAL IDENTIFICATION LABELS

Part Number	Portable Printer Model	Labels Per Roll	Label Material	Label Width Inch (mm) A	Label Height Inch (mm) B	Maximum Lines of Print (PRO/LS)	Maximum Characters Across Large (PRO/LS)	Maximum Characters Across Small (PRO/LS)
CL-211-637	ALL	500	Tedlar®	1.000 (25.40)	0.400 (10.16)	2/2	7/7	10/15
CL-211-652	ALL	500	Polyimide	1.000 (25.40)	0.400 (10.16)	2/2	7/7	10/15
CL-0619-502	LS	500	Vinyl Cloth	1.250 (31.75)	0.375 (9.53)	3	9	19
CL-0619-619	LS	500	Polyester	1.250 (31.75)	0.375 (9.53)	3	9	19
CL-0619-969	LS	500	Metallized Polyester	1.250 (31.75)	0.375 (9.53)	3	9	19
CL-217-619	ALL	500	Polyester	1.500 (38.10)	0.400 (10.16)	2/3	10/11	15/23
CL-217-621	ALL	500	Translucent Polyester	1.500 (38.10)	0.400 (10.16)	2/3	10/11	15/23
CL-217-637	ALL	500	Tedlar	1.500 (38.10)	0.400 (10.16)	2/3	10/11	15/23
CL-217-969	ALL	500	Metallized Polyester	1.500 (38.10)	0.400 (10.16)	2/3	10/11	15/23
CL-305-499	ALL	500	Nylon Cloth	0.500 (12.70)	0.500 (12.70)	3/3	3/3	4/7
CL-305-502	ALL	500	Vinyl Cloth	0.500 (12.70)	0.500 (12.70)	3/3	3/3	4/7
CL-305-607	ALL	500	Tamper-Proof Vinyl	0.500 (12.70)	0.500 (12.70)	3/3	3/3	4/7
CL-305-619	ALL	500	Polyester	0.500 (12.70)	0.500 (12.70)	3/3	3/3	4/7
CL-305-652	ALL	500	Polyimide	0.500 (12.70)	0.500 (12.70)	3/3	3/3	4/7
CL-305-969	ALL	500	Metallized Polyester	0.500 (12.70)	0.500 (12.70)	3/3	3/3	4/7
CL-311-122	ALL	500	Paper	1.000 (25.40)	0.500 (12.70)	3/3	7/7	10/15
CL-311-499	ALL	500	Nylon Cloth	1.000 (25.40)	0.500 (12.70)	3/3	7/7	10/15
CL-311-502	ALL	500	Vinyl Cloth	1.000 (25.40)	0.500 (12.70)	3/3	7/7	10/15
CL-311-607	ALL	500	Tamper-Proof Vinyl	1.000 (25.40)	0.500 (12.70)	3/3	7/7	10/15
CL-311-619	ALL	500	Polyester	1.000 (25.40)	0.500 (12.70)	3/3	7/7	10/15
CL-311-621	ALL	500	Translucent Polyester	1.000 (25.40)	0.500 (12.70)	3/3	7/7	10/15
CL-311-637	ALL	500	Tedlar	1.000 (25.40)	0.500 (12.70)	3/3	7/7	10/15
CL-311-652	ALL	500	Polyimide	1.000 (25.40)	0.500 (12.70)	3/3	7/7	10/15
CL-311-969	ALL	500	Metallized Polyester	1.000 (25.40)	0.500 (12.70)	3/3	7/7	10/15
CL-317-122	ALL	500	Paper	1.500 (38.10)	0.500 (12.70)	3/3	10/11	10/23
CL-317-499	ALL	500	Nylon Cloth	1.500 (38.10)	0.500 (12.70)	3/3	10/11	15/23
CL-317-502	ALL	500	Vinyl Cloth	1.500 (38.10)	0.500 (12.70)	3/4	10/11	15/23
CL-317-619	ALL	500	Polyester	1.500 (38.10)	0.500 (12.70)	3/4	10/11	15/23
CL-317-621	ALL	500	Translucent Polyester	1.500 (38.10)	0.500 (12.70)	3/4	10/11	15/23
CL-317-637	ALL	500	Tedlar	1.500 (38.10)	0.500 (12.70)	3/4	10/11	15/23
CL-511-122	ALL	250	Paper	1.000 (25.40)	0.750 (19.50)	4/5	7/7	10/15
CL-517-122	ALL	250	Paper	1.500 (38.10)	0.750 (19.05)	4/5	10/11	15/23
CL-517-619	ALL	250	Polyester	1.500 (38.10)	0.750 (19.05)	5/8	10/11	15/23
CL-517-621	ALL	250	Translucent Polyester	1.500 (38.10)	0.750 (19.05)	5/8	10/11	15/23
CL-517-637	ALL	250	Tedlar	1.500 (38.10)	0.750 (19.05)	4/5	10/11	15/23
CL-517-969	ALL	250	Metallized Polyester	1.500 (38.10)	0.750 (19.05)	5/8	10/11	15/23
CL-917-122	ALL	250	Paper	1.500 (38.10)	1.250 (31.75)	9/9	10/11	15/23
CL-917-619	ALL	250	Polyester	1.500 (38.10)	1.250 (31.75)	9/8	10/11	15/23
CL-917-637	ALL	250	Tedlar	1.500 (38.10)	1.250 (31.75)	9/9	10/11	15/23
CL-917-969	ALL	250	Metallized Polyester	1.500 (38.10)	1.250 (31.75)	9/9	10/11	15/23
CL-1631-502	LS	250	Vinyl Cloth	2.000 (50.80)	1.000 (25.40)	8	15	31
CL-1631-619	LS	250	Polyester	2.000 (50.80)	1.000 (25.40)	8	15	31
CL-2439-502	LS	250	Vinyl Cloth	2.500 (63.50)	1.500 (38.10)	12	19	39
CL-2439-502-YL	LS	250	Yellow Vinyl Cloth	2.500 (63.50)	1.500 (38.10)	12	19	39
CL-2439-619	LS	250	Polyester	2.500 (63.50)	1.500 (38.10)	12	19	39
CL-2439-969	LS	250	Metallized Polyester	2.500 (63.50)	1.500 (38.10)	12	19	39

Tedlar® is a registered trademark of DuPont.

I.D. PRO PLUS, BRADY LS2000 AND BRADYMARKER XC PLUS LABELS PORTABLE PRINTERS AND LABELS

PORTABLE PRINTERS AND LABELS

I.D. PRO Plus®, Brady LS2000 and BradyMarker™ XC Plus Labels

PRINTER MODEL

PRO = ID PRO/PRO Plus

LS = LS2000

BMXC = BradyMarker XC Plus

ALL = All ID PRO, LS2000, BMXC

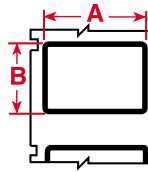

Labels designed for use in control panels to identify motors, starters, relays, contractors, etc.

▶ CONTROL PANEL IDENTIFICATION LABELS

0.062" Black-Bordered Identification CL – BK Series

Part Number	Portable Printer Model	Labels Per Roll	Label Material	Label Width		Maximum Lines of Print (PRO/LS)	Maximum Characters Across	
				Inch (mm) A	Inch (mm) B		Large (PRO/LS)	Small (PRO/LS)
CL-111-619-BK	ALL	500	Polyester	1.130 (28.70)	0.500 (12.70)	1/1	7/7	10/15
CL-111-621-BK	ALL	500	Translucent Polyester	1.130 (28.70)	0.500 (12.70)	1/1	7/7	10/15
CL-111-969-BK	ALL	500	Metallized Polyester	1.130 (28.70)	0.500 (12.70)	1/1	7/7	10/15
CL-317-619-BK	ALL	250	Polyester	1.625 (41.28)	0.750 (19.05)	3/3	10/11	15/23
CL-317-621-BK	ALL	250	Translucent Polyester	1.625 (41.28)	0.750 (19.05)	3/3	10/11	15/23
CL-317-969-BK	ALL	250	Metallized Polyester	1.625 (41.28)	0.750 (19.05)	3/5	10/11	15/23
CL-1429-619-BK	LS	250	Polyester	2.000 (50.80)	1.000 (25.40)	7	14	29
CL-1429-969-BK	LS	250	Metallized Polyester	2.000 (50.80)	1.000 (25.40)	7	14	29

▶ PRE-PRINTED LABELS

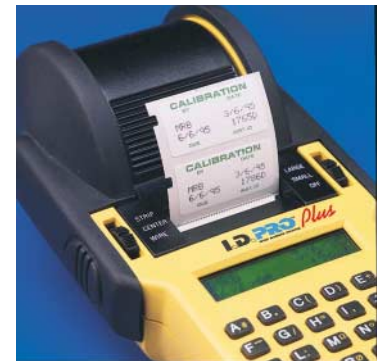
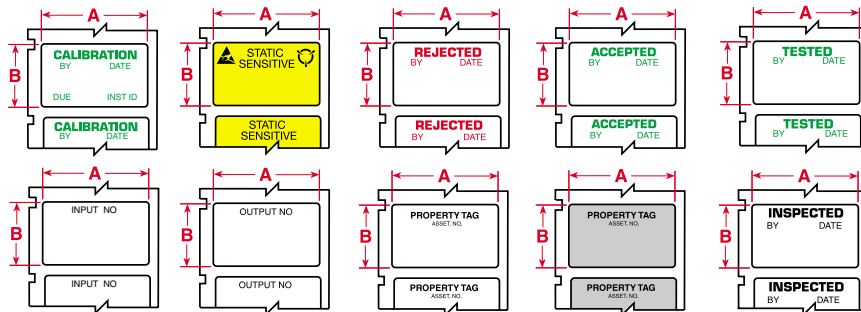

Vinyl Cloth (B-502), Tamper-Evident Vinyl (B-607), Metallized Polyester (B-969)

Part Number	Portable Printer Model	Labels Per Roll	Label Material	Label Width		Maximum Lines of Print (PRO/LS)	Maximum Characters Across		Pre-Printed Legends	Print Color
				Inch (mm) A	Inch (mm) B		Large (PRO/LS)	Small (PRO/LS)		
CLWO-317-1	ALL	500	Vinyl Cloth	1.500 (38.10)	0.750 (19.05)	3/3	10/11	15/23	REJECTED	Red
CLWO-317-2	ALL	500	Vinyl Cloth	1.500 (38.10)	0.750 (19.05)	3/3	10/11	15/23	ACCEPTED	Green
CLWO-217-3	ALL	500	Vinyl Cloth	1.500 (38.10)	0.750 (19.05)	2/2	10/11	15/23	CALIBRATION	Green
CLWO-317-4	ALL	500	Vinyl Cloth	1.500 (38.10)	0.750 (19.05)	3/3	10/11	15/23	TESTED	Green
CLWO-317-5	ALL	500	Vinyl Cloth	1.500 (38.10)	0.750 (19.05)	3/3	10/11	15/23	INSPECTED	Black
CLWO-217-6	ALL	500	Vinyl Cloth	1.500 (38.10)	0.500 (12.70)	2/2	10/11	15/23	INPUT NO.	Black
CLWO-217-7	ALL	500	Vinyl Cloth	1.500 (38.10)	0.500 (12.70)	2/2	10/11	15/23	OUTPUT NO.	Black
CLSL-111-502	ALL	500	Vinyl Cloth	1.000 (25.40)	0.500 (12.70)	1/1	7/7	10/15	STATIC SENSITIVE	Black
CLWO-217-607	ALL	250	Vinyl	1.630 (41.40)	0.750 (19.05)	2/2	10/11	15/23	PROPERTY TAG	Black
CLWO-217-969	ALL	250	Metallized Polyester	1.630 (41.40)	0.750 (19.05)	2/2	10/11	15/23	PROPERTY TAG	Black

I.D. PRO Plus®, Brady LS2000 and BradyMarker™ XC Plus Labels

I.D. PRO PLUS, BRADY LS2000 AND BRADYMARKER XC PLUS LABELS PORTABLE PRINTERS AND LABELS

PRINTER MODEL
PRO = ID PRO/PRO Plus
LS = LS2000
BMXC = BradyMarker XC Plus
ALL = All ID PRO, LS2000, BMXC

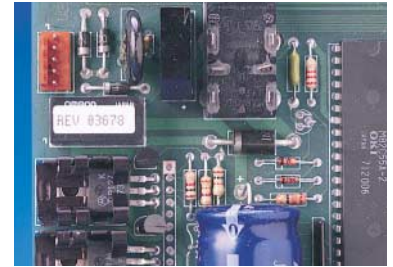
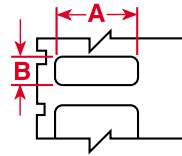

► **CIRCUIT BOARD AND COMPONENT LABELS**

White Vinyl Cloth (B-502), White Polyester (B-619), Amber Polyimide (B-652)

Part Number	Marker Size Code	Labels Per Roll	Label Material	Label Width Inch (mm) A	Label Height Inch (mm) B	Maximum Lines of Print (LS/BMXC)	Maximum Characters Across Large (LS/BMXC)	Maximum Characters Across Small (LS/BMXC)
ECL-107-502	LS/BMXC	750	Vinyl Cloth	0.670 (17.02)	0.225 (5.72)	1/1	4/4	9/9
ECL-107-619	LS/BMXC	750	Polyester	0.670 (17.02)	0.225 (5.72)	1/1	4/4	9/9
ECL-107-652	LS/BMXC	750	Polyimide	0.670 (17.02)	0.225 (5.72)	1/1	4/4	9/9
ECL-111-502	LS/BMXC	750	Vinyl Cloth	1.000 (25.40)	0.225 (5.72)	1/1	7/7	15/15
ECL-111-619	LS/BMXC	750	Polyester	1.000 (25.40)	0.225 (5.72)	1/1	7/7	15/15
ECL-111-652	LS/BMXC	750	Polyimide	1.000 (25.40)	0.225 (5.72)	1/1	7/7	15/15
ECL-204-619	LS/BMXC	750	Polyester	0.420 (10.67)	0.350 (8.89)	2/2	2/2	5/5
ECL-204-652	LS/BMXC	750	Polyimide	0.420 (10.67)	0.350 (8.89)	2/2	2/2	5/5
ECL-211-502	LS/BMXC	750	Vinyl Cloth	1.000 (25.40)	0.350 (8.89)	2/2	7/7	15/15
ECL-211-619	LS/BMXC	750	Polyester	1.000 (25.40)	0.350 (8.89)	2/2	7/7	15/15
ECL-311-502	LS/BMXC	500	Vinyl Cloth	1.000 (25.40)	0.475 (12.07)	3/3	7/7	15/15
ECL-311-619	LS/BMXC	500	Polyester	1.000 (25.40)	0.475 (12.07)	3/3	7/7	15/15

I.D. PRO Plus® Wire Marker Printer Ribbons and Accessories

► **RIBBONS**

I.D. PRO Plus Printer Ribbon

Part Number	Description
R5300	Black High-Performance Ribbon for PermaSleeve™ and DuraSleeve® (Darker print, less smear resistant)
<i>Introducing a more smear resistant ribbon</i>	
R7300	Black High-Performance Ribbon for all labels and BradySleeve™ (Lighter print, more smear resistant)



► **ACCESSORIES**

I.D. PRO Plus Printer Accessories

Part Number	Description
IDPRO-HC	Hard Side Carrying Case
IDPRO-BC12V	12-Volt Battery Charger (plugs into auto cigarette lighter)
IDPRO-BP	Battery Pack
IDPRO-BC	Battery Charger
PCK-4	Printer Cleaning Kit (50 self-saturating swabs)



IDPRO-HC



IDPRO-BC12V





Thermal Transfer Printers



Selecting Your Printers	68
X-Plus II Series	
Models 300X-Plus II, 360X-Plus II and 600X-Plus II	70
MVP Series	
Models 200MVP and 300MVP	71
Tagus Series	
Models T200 and T300	72
Models 1244 and 1344	73
Thermal Transfer Accessories	74
GlobalMark™ Industrial Label Maker	75
Wraprotor™ Wire ID Printer Applicator	76
Printer Applicator Machine 3000 (PAM)	77

Selecting Your Printers

SELECTING YOUR PRINTERS THERMAL TRANSFER PRINTERS

X-Plus II Series	MVP Series	Tagus Series	
 360X-Plus II With 6.6" of print width, this printer has the versatility for many applications in electronics, computer and telecommunications.	 600X-Plus II / 300X-Plus II Ideal for identifying components and assemblies in electronics, computer and telecommunications.	 200MVP Plus / 300MVP Plus The best value in an industrial thermal transfer printer, easy to operate and loaded with features.	
 T200 / T300 Rugged, sturdy, and developed for use in medium volume applications such as healthcare, laboratory research, light manufacturing and inventory.			
Page 70	Page 70	Page 71	Page 72

FEATURES

Recommended Throughput	7,000+ labels / day	7,000+ labels / day	up to 5,000 labels / day	up to 3,500 labels / day
Operational Hours	24 hrs / 7 days	24 hrs / 7 days	12 hrs / 5 days	10 hrs / 5 days
Resolution (DPI)	300 dpi	600 dpi / 300 dpi	203 dpi / 300 dpi	203 dpi / 300 dpi
Max Label Width	7.200"	4.500"	4.520"	4.250"
Max Print Width	6.600"	3.200" / 4.090"	4.090"	4.160"
Min Label Length	0.125"	0.125"	0.250" / 0.125"	0.250"
Memory RAM	16 MB	16 MB	8 MB	4 MB / 8 MB
Flash	4 MB	4 MB	2 MB	2 MB
Material Supported	Die Cut, Notched, Sleeve, Cont.	Die Cut, Notched, Sleeve, Cont.	Die Cut, Notched, Sleeve, Cont.	Die Cut, Notched, Sleeve, Cont.
Peripheral Printing (Connected to a PC)	YES	YES	YES	YES
Stand Alone Printing (Detatched from PC)	Optional	Optional	Optional	Optional
Color Capability	Monocolor	Monocolor	Monocolor	Monocolor
Connectivity	Serial, Parallel, USB Ethernet (Wired and Wireless)	Serial, Parallel, USB Ethernet (Wired and Wireless)	Serial, Parallel, Ethernet (Wired and Wireless)	Serial, Parallel, USB Ethernet (Wired Only)
Options	Cutter, Rewind Peel Off	Cutter, Rewind Peel Off	Cutter, Rewind Peel Off	Cutter

EXAMPLE APPLICATION SETS

Facility Identification	—	—	—	—
Ribbons	—	—	—	—
Labels	—	—	—	—
Design Software	—	—	—	—
Asset Identification, Bar Coding	R4300 (Page 123)	R4300 (Page 123)	R4300 (Page 123)	R4300 (Page 123)
Ribbons	B-489 (Page 119)	B-489 (Page 119)	B-489 (Page 119)	B-489 (Page 119)
Labels	Bradysoft™ (Page 202)	Bradysoft™ (Page 202)	Bradysoft™ (Page 202)	Bradysoft™ (Pg 202)
Design Software	—	—	—	—
Cable and Wire Identification	—	—	R4300 (Page 123)	R4300 (Page 123)
Ribbons	—	—	B-427 (Page 110)	B-427 (Page 110)
Labels	—	—	LabelMark™ (Page 206)	LabelMark™ (Page 206)
Design Software	—	—	—	—
Circuit Board Identification	R6000 (Page 123)	R6000 (Page 123)	—	—
Ribbons	B-457 (Page 101)	B-457 (Page 101)	—	—
Labels	Bradysoft™ (Page 202)	Bradysoft™ (Page 202)	—	—
Design Software	—	—	—	—

OTHER BRADY PRODUCTS



Code Reader 2.0

- ▶ Versatile, rugged platform
- ▶ Supports all popular linear and 2D symbologies
- ▶ 333 Mhz AMD
- ▶ Low power consumption
- ▶ Dual optics, read both near and far fields with one unit

Page 220



IDXPERT™ Thermal Labeling System

- ▶ Wire and cable printer
- ▶ 2 styles of keypads available
- ▶ Simple lock and load consumables
- ▶ Prints on both continuous and die-cut labels





Page 8



TLS 2200® Thermal Labeling System

- ▶ Wire and cable printer
- ▶ Custom labels available
- ▶ 29 label materials
- ▶ Can be connected to PC

Page 16

1244 / 1344 Series	GlobalMark™	Wraptor™	PAM 3000
			
1244 / 1344 Small, compact and economical. Ideal for general purpose product identification, wire and cable marking and laboratory identification.	The GlobalMark Industrial Label Maker is a make-it-yourself industrial-grade, heavy-duty label-production printer. Users have the ability to print custom labels, tags, decals, badges, and signs on demand.	Unique print and apply machine built specifically to automate cable and wire identification. Prints and wraps labels to wires from 0.060" to 0.600" within 5 seconds automatically.	Ideal for print and apply solutions requiring accurate placement (+/- 0.012") of medium to very small labels.
Page 73	Page 75	Page 76	Page 77
up to 1,500 labels / day 8 hrs / 5 days	500 signs / day (2000 labels/day)	7,000+ labels / day 24 hrs / 7 days	7,000+ labels / day 24 hrs / 7 days
203 dpi / 300 dpi	300 dpi	300 dpi	300 dpi
4.300"	4.000"	2.000"	4.567"
4.100"	3.800"	2.000"	4.200"
0.250"	2.000"	0.750"	0.138"
2 MB 1 MB	16 MB 32 MB	8 MB 32 MB	2 MB 4 MB
Die Cut, Notched, Sleeve, Cont.	Continuous (Specific to GlobalMark)	Die Cut (Specific to Wraptor)	Die Cut
YES	YES	YES	YES
Optional	YES	YES	YES
Monocolor Serial, Parallel, USB	Monocolor and Multicolor USB, Serial	Monocolor USB, Serial Ethernet (Wired Only)	Monocolor Serial, Parallel
Cutter, Peel Off	Die cut capabilities (Only on Color and Cut model)	N/A	Light tower, bar code validator, ribbon and label low sensors
—	Mix and Match Tapes/Ribbons (Page 75)	—	—
—	Mix and Match Tapes/Ribbons (Page 75)	—	—
—	MarkWare™ (Page 204)	—	—
R4300 (Page 123) B-489 (Page 119) Bradysoft™ (Page 202)	Mix and Match Tapes/Ribbons (Page 75) Mix and Match Tapes/Ribbons (Page 75) MarkWare™ (Page 204)	— — —	R6000 (Page 123) B-483 (Page 119) Bradysoft™ (Page 202)
R4300 (Page 123) B-427 (Page 110) LabelMark™ (Page 206)	— — —	R4306 (Page 123) B-427 (Page 110) LabelMark™ (Page 206)	— — —
—	—	—	R6000 (Page 123) B-477 (Page 101) Bradysoft™ (Page 202)
—	—	—	—



TLS PC Link™ Thermal Labeling System

- ▶ Peripheral wire and cable printer
- ▶ Uses the same labels as TLS2200
- ▶ Perfect for bulk consumables
- ▶ LabelMark™ Label Software included with printer

Page 17



HandiMark® Portable Label Maker

- ▶ Warning and pipe marker printer
- ▶ Pipemarker and bar code application built right within the printer
- ▶ Can be connected to PC
- ▶ Industrial grade outdoor vinyl tapes available

Page 50

X-Plus II Series



The X-Plus II series printers are designed with mission critical applications in mind. Able to withstand long (In excess of 7,000 labels per day), continuous (24/7) operation in harsh environments. Available in 300 dpi (4.000" and 6.000" print widths) and 600 dpi resolutions, this range of printers is ideal for labeling components, electronic assemblies and computer telecommunications.

The X-Plus II series of printers have been specifically engineered to provide consistent, high quality print on our full range of labeling materials including polyester, polyimide, paper and vinyl. And, they come with the reliability and technical support you expect from Brady.

X-Plus II Series Printers

Part Number	Description
Model 300X-Plus II	
BP-THT-300X+II	Brady THT Model 300X-PLUS II
Model 360X-Plus II	
BP-THT-360X+II	Brady THT Model 360X-PLUS II
Model 600X-Plus II	
BP-THT-600X+II	Brady THT Model 600X-PLUS II

SPECIFICATIONS

Model 300X-Plus II

Print resolution	300 dots per inch (12 dots per mm) thermal transfer printer
Maximum print width	4.090" (103.89 mm)
Maximum media width	4.500" (114.30 mm)
Labels/day	7,000
Hours/operation	24 hours / 7 days a week

Model 360X-Plus II

Print resolution	300 dots per inch (12 dots per mm) thermal transfer printer
Maximum print width	6.600" (167.64 mm)
Maximum media width	7.100" (180.34 mm)
Labels/day	7,000
Hours/operation	24 hours / 7 days a week

Model 600X-Plus II

Print resolution	600 dots per inch (24 dots per mm) thermal transfer printer
Maximum print width	3.200" (81.28 mm)
Maximum media width	4.500" (114.30 mm)
Labels/day	7,000
Hours/operation	24 hours / 7 days a week

Communication Interfaces

- ▶ RS-232 serial port
- ▶ Bi-directional parallel port
- ▶ USB 2.0 (480 Mbits/second) port
- ▶ 10/100 ethernet print server option
- ▶ Wireless print server option

Options

- ▶ Rewind (full label roll onto core)
- ▶ Label peel (full roll liner rewind)
- ▶ Cutter (full width rotary knife)

Additional options available. Please visit www.bradyid.com for options and specifications.

COMMON MATERIALS / RIBBONS



RATING PLATES

Material	B-428 (Page 117)
Ribbons	R4300 (Page 123)



ELECTRONIC (PCB) IDENTIFICATION

Material	B-487 (Page 101)
Ribbons	R6000 (Page 123)

MVP Series Models 200MVP Plus and 300MVP Plus



Available in either 203 or 300 dpi, the MVP printers are easy to operate and loaded with features, including color-coded operator cues and an LCD display.

The durable, die cast aluminum frame provides a rugged platform for printing in operations that require label production 12 hours/day, 5 days/week. Enhanced firmware ensures accurate printing on labels as small as 0.125"*.

The 200MVP and 300MVP printers are application flexible and print on a wide range of materials from paper and vinyl to polyester and polyimide*.

* Minimum 300 dpi resolution is recommended for printing 0.125" high labels or polyimide material.

200MVP / 300MVP

Part Number	Description
Model 200MVP	
BP-THT-200MVP-PLUS	Brady THT Model 200MVP
Model 300MVP	
BP-THT-300MVP-PLUS	Brady THT Model 300MVP

► SPECIFICATIONS

Model 200MVP

Print resolution	203 dots per inch (8 dots per mm) thermal transfer printer
Print speeds	Selectable print speeds at 1" increments from 2.000" (50.80 mm) to 10.000" (254.00 mm) per second
Minimum Label Length	0.250" (6.35 mm)
Labels / Day	Up to 5,000 labels / day
Hours / Operation	12 hours / 5 days

Model 300MVP

Print resolution	300 dots per inch (12 dots per mm) thermal transfer printer
Print speeds	Selectable print speeds at 1" increments from 2.000" (50.80 mm) to 6.000" (152.40 mm) per second
Minimum Label Length	0.125" (3.18 mm)
Labels / Day	Up to 5,000 labels / day
Hours / Operation	12 hours / 5 days

Communication Interfaces

- RS-232 serial port
- Bi-directional parallel port
- 10/100 ethernet print server option
- Wireless print server option

Options

- Internal rewind
- Label peel (full roll liner rewind)
- Standard media cutter

Additional options available. Please visit www.bradyid.com for options and specifications.

► COMMON MATERIALS / RIBBONS



TAMPER-EVIDENT IDENTIFICATION

Material	B-351 (Page 121)
Ribbons	R6200 (Page 123)



WORK-IN-PROCESS LABELING ON TEXTURED OR CURVED SURFACES

Material	B-484 (Page 119)
Ribbons	R6000 (Page 123)

Tagus Series



► SPECIFICATIONS

Model T200

Print resolution	200 dots per inch (8 dots per mm) thermal transfer printer
Print speeds	Selectable print speeds at 1" increments from 2,000" (50.80 mm) to 10,000" (254.00 mm) per second
Minimum Label Length	0.250" (6.35 mm)
Labels / Day	Up to 4,000 labels / day
Hours / Operation	10 hours / 5 days

Model T300

Print resolution	300 dots per inch (12 dots per mm) thermal transfer printer
Print speeds	Selectable print speeds at 1" increments from 2,000" (50.80 mm) to 6,000" (152.40 mm) per second
Minimum Label Length	0.250" (6.35 mm)
Labels / Day	Up to 4,000 labels / day
Hours / Operation	10 hours / 5 days

► COMMON MATERIALS / RIBBONS



LABORATORY SAMPLE IDENTIFICATION

Material	B-461
Ribbons	R4300 (Page 123)



WIRE AND CABLE MARKING

Material	Heat Shrinkable PermaSleeve (Page 111)
Ribbons	R4300 (Page 123)



GENERAL IDENTIFICATION

Material	B-424 (Page 117)
Ribbons	R6000 (Page 123)

Don't be fooled by the smaller sized Tagus series of thermal transfer printers. Housed within that small shell is an industrial workhorse of a machine. Built with the same durable die cast aluminum materials found on our larger heavy duty printers, the T200 and T300 printers won't disappoint. Available in a 200 dpi model without LCD display and a 300 dpi model with, the Tagus series can appeal to a wide variety of applications and budgets. Engineered and tested for use with Brady's performance material, no other Benchtop THT printer can provide a better value.

► FEATURES

- Supplies loading diagram embossed into the frame
- Unique collapsible ribbon hub
- Upgradeable flash memory
- Cantilever printhead mechanism

T200 / T300 Series

Part Number	Description
Model T300	
BP-T300	300 dpi Tagus with LCD
BP-T300-C	300 dpi Tagus with LCD and cutter
Model T200	
BP-T200	200 dpi Tagus, no LCD
BP-T200-C	200 dpi Tagus, no LCD with cutter

► FIELD-INSTALLED OPTIONS

Models T200 / T300

Part Number	Description
TAG-CUTTER	Field installable cutter
BP-T300-LAN	Field installable 10/100 ethernet card

Communication Interfaces

- RS-232 serial (standard)
- Centronics parallel (standard)
- USB 2.0 (standard)
- Ethernet card with print server (optional)



Printers are available in either 203 dpi or 300 dpi print resolution.

Models 1244 and 1344 are available with optional media stand.

► SPECIFICATIONS

Model 1244

Print resolution	203 dots per inch (8 dots per mm)
Minimum label length	0.250" (6.35 mm)
Labels / Day	Up to 1,500 labels / day
Hours / Operation	8 hours / 5 days

Model 1344

Print resolution	300 dots per inch (12 dots per mm)
Minimum label length	0.250" (6.35 mm)
Labels / Day	Up to 1,500 labels / day
Hours / Operation	8 hours / 5 days

► COMMON APPLICATIONS



GENERAL LABELING ON TEXTURED SURFACES

Material	B-423 (Page 119)
Ribbons	R6001 (Page 123)



ASSET IDENTIFICATION

Material	B-433 (Page 119)
Ribbons	R6001 (Page 123)



WIRE AND CABLE MARKING

Material	B-427 (Page 110)
Ribbons	R4301 (Page 123)

The models 1244 and 1344 are small, compact and economical. Featuring print resolutions of either 203 dpi or 300 dpi and a wide print width of 4.100", the 1244 and 1344 printers are ideal for general purpose product identification, wire and cable marking and laboratory identification.

For small to medium volume printing, the models 1244 and 1344 provide all the power and quality you need for on-demand in-house printing. The moveable transmissive sensor allows the use of all Brady stock configurations in a variety of materials including polyester, paper, vinyl and sleeves.

Bradyprinter Models 1244 / 1344

Part Number	Description
BP-1244	Brady Model 1244
BP-1344	Brady Model 1344

► FIELD-INSTALLED OPTIONS

Models 1244 / 1344

Part Number	Description
BP-12/13-3MB-FLASH	1244/1344 3MB memory expansion+H4
BP-12/13-CUTTER	1244/1344 standard cutter option
BP-12/13-LD-CUTTER	1244/1344 light duty cutter option
BP-12/13-MS	1244/1344 media stand

Communication Interfaces

- USB serial and parallel interfaces standard

Options

- Label peel
- Additional options available

Ribbons and Materials

- Must be 4" x 360"

Thermal Transfer Accessories



Thermal Transfer Label Dispensers

Part Number	Description
DSP-2	Label dispenser, 2.250" maximum width
DSP-5	Label dispenser, 4.500" maximum width
DSP-2-INT-220V	Label dispenser, 2.500" maximum width, 220V
DSP-5-INT-220V	Label dispenser, 4.500" maximum width, 220V
DSP-2CABLE	Daisy chain cable

Label Dispenser Specifications

Specifications	DSP-2	DSP-5
Minimum Liner Capacity Width	0.250" (6.35 mm)	0.250" (6.35 mm)
Maximum Liner Capacity Width	2.250" (57.15 mm)	4.500" (115.00 mm)
Minimum Label Length	0.250" (6.35 mm)	0.125" (3.20 mm)
Maximum Label Length	3.000" (76.20 mm)	7.000" (178.00 mm)
Feed Speed	2.200"/sec (55.88 mm/sec)	1.300"/sec (33.00 mm/sec)
Dimensions	7.300" (L) x 4.900" (W) x 9.500" (H) (185.42 mm x 124.46 mm x 241.30 mm)	10.800" (L) x 10.800" (W) x 14.500" (H) (274.32 mm x 274.32 mm x 368.30 mm)
Weight	2.00 lb. (0.90 kg)	10.5 lb. (4.76 kg)
Electrical Requirements:		
115V Versions	12V DC with 115V adapter	117V 50/60Hz, < 1 amp
220V Versions	12V DC with 220V adapter	220V 50/60Hz

Printer Cleaning Kit

Part Number	Description
PCK-4	Thermal Transfer Printer Cleaning Kit (50 Self Saturating Cotton Swabs)

Printhead Cleaning Film (3 strips/package)

Part Number	Description
CL-FILM-P-2	Printhead Cleaning Film 2.000" x 6.000"
CL-FILM-P-4	Printhead Cleaning Film 4.000" x 6.000"
CL-FILM-P-5	Printhead Cleaning Film 5.000" x 6.000"

The Brady label dispenser family automatically peels, releases and presents labels for identification purposes for any industrial or assembly application. Adjustable photo sensor allows proper presentation of label regardless of length (see chart below for min/max label sizes). Each dispenser is equipped with an automated scrap rewind with a built in lock rod for easy scrap removal. The dispensers are engineered for minimum operator intervention when changing to a different label size.

► DSP-2

Brady's lightweight DSP-2 label dispenser is portable and easy to use. The small footprint dispenser makes it ideal for applications where space limitations are of concern. The DSP-2 dispenser can be daisy chained to multiple machines for dispensing different labels at the same time.

► DSP-5

Brady's DSP-5 label dispenser provides a dispensing platform for wider and longer labels. Although the footprint of the DSP-5 is larger than that of the DSP-2, its weight and size still makes transportability an option.

► REWINDER



Rewinds labels externally as they print. Rewinds labels onto a standard 8" (outside diameter) core.

Serial Cabling Kit

Part Number	Description
SCK-9	Serial Cabling Kit — 9 ft
UCK-10	USB Kit
PCK-11	Parallel Kit
ECK-12	Ethernet Kit

Rewinder

Part Number	Description
60975	Rewinder



Part Number	Description
76801	GlobalMark* Color & Cut
76800	GlobalMark* MultiColor
76798	GlobalMark* MonoColor
90835	ValuePLUS Package for GlobalMark Printer

*GlobalMark ships with a keyboard, power cord, cleaning kit, USB cable and Brady File Management Utility

▶ **VALUEPLUS PACKAGE FOR GLOBALMARK**

Save big with the ValuePLUS Package. When purchased with your printer, you get more label making capabilities and warranty protection. Here's what you get:

- ▶ MarkWare™ Facility Identification Software with its extensive library of ready-to-print label, tag and sign templates, plus expanded label-making capabilities
- ▶ Extended Warranty: one full year added to your standard 6-month warranty (18 months total). Return your warranty card and you get 6 months more for 2 years total!
- ▶ One roll of 4" white vinyl tape
- ▶ One roll of black ribbon



▶ **INDOOR / OUTDOOR GRADE VINYL TAPE**

- ▶ Labels adhere well to pipes, walls, equipment, windows – most clean, dry surfaces
- ▶ Conforms well to irregular, curved or rough surfaces – it even stands up to grease, oil and most industrial chemicals
- ▶ Five-year average outdoor durability in temperatures from 180°F to -40°F (82°C to -40°C)

Size	Part Number							
	White	Yellow	Red	Green	Blue	Black	Orange	Clear
4.000" x 100'	76542	46547	76552	76556	76560	76564	76594	97734
3.000" x 100'	76543	73548	—	—	—	—	—	—
2.250" x 100'	76544	76549	76553	76557	76561	76565	76595	97735
1.125" x 100'	76545	46550	76554	76558	76562	76566	76596	97736
0.500" x 100'	76546	76551	76555	76559	76563	76567	76597	97737

Unprecedented ease of use... Unprecedented choice of materials... Touch... Print... Presto!

- ▶ Color touch screen interface... Quick and Easy!
- ▶ Multicolor spot printing or full-color process printing
- ▶ New materials including tag stock, magnetic and static cling
- ▶ Cuts characters and shapes

Brady File Management Utility allows you to:

- ▶ Transfer files from your PC to your GlobalMark and from your GlobalMark to PC
- ▶ Manage your existing GlobalMark files
- ▶ Update your GlobalMark operating system when upgrades are available. Simple to run when connected to your PC

Choose from 3 GlobalMark Models that will meet all your labeling requirements!

COLOR & CUT

- ▶ Prints in one color, multiple spot colors, blended colors and full process color
- ▶ Unit has a built-in cutter for cutting out characters and shapes
- ▶ With optional MarkWare™ label making software, import and print full color logos, artwork, even photographs

MULTICOLOR

- ▶ Prints the same color options as the Color & Cut system, including the optional MarkWare software enhancements, without the built-in cutter

MONOCOLOR

- ▶ Prints one color only on one color tape. It is compatible with MarkWare software
- ▶ Monochrome touchscreen display
- ▶ Does not have a built-in cutter

▶ **INDUSTRIAL GRADE PRINT RIBBONS**

- ▶ Super-tough smear-proof ribbons assure your printed text lasts for years outdoors and in an industrial environment
- ▶ Ribbons ship self-contained in cartridges that drop straight in to the GlobalMark with a "click"
- ▶ 2 and 4-color "paneled" ribbons are used to print labels and signs containing more than 1 print color

SINGLE COLOR PRINT RIBBON CARTRIDGES

Size	Part Number				
200 ft/roll	Black	White	Red	Yellow	Orange
4.110" x 200'	76739	76741	76743	76751	76752

2-COLOR PRINT RIBBON CARTRIDGES **4-COLOR PRINT RIBBON CARTRIDGES**

Size	Part Number			
200 ft/roll Not available for MonoColor	Black/Red	Black/Orange	Black/Red/Blue/Green	Black/Red/Blue/Yellow
4.110" x 8.000"	76763	76771	76787	76791
4.110" x 16.000"	76762	76770	76786	76790

Wraprot™ Wire ID Printer Applicator



Wraprot Wire ID Printer Applicator from Brady: the automated print-and-apply machine that brings the efficiency you need to wire and cable identification.

Wraprot brings **production efficiency** to wire and cable ID by combining the printing and application of labels in a single unit. With zero queue print and apply, create the label you need, when you need it, with no additional waste --- in less than 5 seconds!

Wraprot brings unprecedented **quality** to labeling cable and wire. High performance wire labels are wrapped consistently to perfection, every time.

Wraprot's smart consumables **simplify** the task of labeling wires and cables and eliminate the need for time consuming and wasteful calibration steps. The combined print and apply process makes it easy to label different wire diameters without any tool changes or mechanical adjustments.

WRAPROT WIRE ID PRINTER APPLICATOR THERMAL TRANSFER PRINTERS

SPECIFICATIONS

Print resolution	300 dots per inch (12 dots per mm) thermal transfer printer
Labels/day	7,000+
Hours/operation	24 hours/7days a week
Internal memory	8 MB
Minimum wire diameter	0.060" (1.52 mm)
Maximum wire diameter	0.600" (15.24 mm)
Machine cycle time	4.5-5.0 seconds
Maximum print width	2.000" (50.80 mm)
Maximum print length	1.625" (41.30mm)
Maximum label width	2.000" (50.80 mm)
Maximum label length	3.000" (76.20 mm)
Minimum label width	0.250" (6.35 mm)
Minimum label length	0.750" (19.05 mm)



Select job, insert wire or cable.



Print and wrap in two easy steps... with one machine in 5 seconds or less!

MATERIALS /B-427 SELF-LAMINATING VINYL

Wraprot Material Name	Label Size W x H		Printable/Write-On Area		Pcs./Roll	Recommended Ribbon UL Recognized	Recommended Wire Size Use		
	(in.)	(mm.)	(in.)	(mm.)			Min Diameter	Max Diameter	Wire Gauges
WRAP-1-427	0.500" x 0.750"	12.70 mm x 19.05 mm	0.500" x 0.375"	12.70 mm x 9.53 mm	6,800	R4311	0.060"	0.080"	18 - 22
WRAP-2-427	1.000" x 1.000"	25.40 mm x 12.40 mm	1.000" x 0.375"	25.40 mm x 9.53 mm	5,300	R4306	0.080"	0.159"	12 - 18
WRAP-3-427	1.000" x 1.250"	25.40 mm x 31.75 mm	1.000" x 0.500"	25.40 mm x 12.70 mm	4,300	R4306	0.159"	0.199"	10 - 14
WRAP-4-427	1.000" x 1.500"	25.40 mm x 38.10 mm	1.000" x 0.500"	25.40 mm x 12.70 mm	3,600	R4306	0.159"	0.279"	6 - 14
WRAP-5-427	1.500" x 2.500"	38.10 mm x 63.50 mm	1.500" x 0.750"	38.10 mm x 19.05 mm	2,200	R4306	0.239"	0.517"	1/0 - 8
WRAP-6-427	2.000" x 3.000"	50.80 mm x 76.20 mm	2.000" x 1.000"	12.70 mm x 25.40 mm	1,900	R4302	0.318"	0.597"	3/0 - 6
WRAP-10-427	1.000" x 2.250"	25.40 mm x 57.15 mm	1.000" x 0.750"	25.40 mm x 19.05 mm	2,500	R4306	0.239"	0.438"	1/0 - 8
WRAP-11-427	0.500" x 1.500"	12.70 mm x 38.10 mm	0.500" x 0.500"	12.70 mm x 12.70 mm	3,600	R4311	0.159"	0.279"	6 - 14
WRAP-12-427	2.000" x 1.500"	50.80 mm x 38.10 mm	2.000" x 0.500"	50.80 mm x 12.70 mm	3,600	R4302	0.159"	0.279"	6 - 14

MATERIALS /B-499 NYLON CLOTH

Wraprot Material Name	Label Size W x H		Printable/Write-On Area		Pcs./Roll	Recommended Ribbon UL Recognized	Recommended Wire Size Use		
	(in.)	(mm.)	(in.)	(mm.)			Min Diameter	Max Diameter	Wire Gauges
WRAP-7-499	0.500" x 0.750"	12.70 mm x 19.05 mm	0.500" x 0.750"	12.70 mm x 19.05 mm	4,500	R4311	0.060"	0.199"	10 - 22
WRAP-8-499	1.000" x 1.500"	25.40 mm x 38.10 mm	1.000" x 1.500"	25.40 mm x 38.10 mm	2,800	R4306	0.159"	0.438"	2 - 14
WRAP-9-499	2.000" x 2.000"	50.80 mm x 50.80 mm	2.000" x 2.000"	50.80 mm x 50.80 mm	2,100	R4302	0.212"	0.597"	3/0 - 8
WRAP-13-499	1.000" x 1.000"	25.40 mm x 25.40 mm	1.000" x 1.000"	25.40 mm x 25.40 mm	4,100	R4306	0.106"	0.279"	6 - 14

Part Number	Description
WRAPROT-PTR	Wraprot Wire ID printer, including LabelMark™ label design and printing software, Wraprot print driver, File Management Utility (FMU), USB cable, 64 MB CF card, Stylus 3PK, roll of WRAP-4-427 and roll of R4302 ribbon
64MB-CF	64 MB CompactFlash® Card
STYLUS-3PK	Stylus pens (3-pack)
SER-STRAIGHT	Straight through 9 pin serial cable
WRAPROT-VBLK	Spare wrapper assembly
WRAPROT PRNTHD*	Wraprot printhead replacement kit

*Wraprot warranty is one year, not including the WRAPROT-VBLK assembly or printhead. Original printhead is warranted for 6 months. Both VBLK and printhead are field replaceable.

Communication Interfaces

- Serial: RS-232C
- USB
- Ethernet
- PCMCIA
- CompactFlash®

Physical

- Height: 17.750" (450.90 mm)
- Width: 14.500" (368.30 mm)
- Depth: 22.500" (571.50 mm)
- Weight: 85 lbs. (38.5 kg)
- Operating temperature: 50° to 105°F (10° to 41°C)

Printer Applicator Machine (PAM) 3000



PAM 3000

Part Number	Description
PAM 3000 PTR	PAM 3000 Printer
PAM 3000 APP	PAM 3000 Applicator
PAM 3000 AIRSTD	PAM 3000 Air Service Unit Standard

► SPECIFICATIONS

PAM 3000

Print resolution	300 dots per inch (12 dots per mm) thermal transfer printer
Standard memory	2 MB
Maximum memory card	4 MB PCMCIA
Maximum print width	4.200" (106.60 mm)
Minimum label width	0.200" (5.00 mm)
Maximum label width	4.567" (116.00 mm)
Minimum label height	0.138" (3.50 mm)
Maximum label height	3.150" (80.00 mm)
Labels/day	7000+
Hours/operation	24 hours/7days a week
Print speeds	2.600" (66.00 mm) to 7.890" (200.00 mm) per second
Applicator rotation	0° and 90°
Application cycle time	2.5 - 5.0 seconds
Placement accuracy	+/- 0.012 (0.3 mm)*

*Application dependent. Consult Brady ASE.

The PAM 3000 brings label print and apply automation to a new level. Where traditional printer-applicators struggle with small labels, difficult label release, and tight placement accuracy, the PAM 3000 excels with its patented dispensing mechanisms.

Integration - Standard 24V input/out PLC interface allows easy integration into production lines and other automated processes. Large selection of resident fonts and bar codes as well as onboard date/time clock allows stand-alone operation.

Placement Flexibility - Use as a printer/dispenser and integrate with robotics to place labels in numerous orientations. Or use the standard Applicator option to place at either 0° or 90° from print orientation.

Validation - 1D and 2D bar codes can be validated as readable before they are applied and can automatically reprint the label with no human intervention.

Zero Queue print/apply - Eliminates the need to preprint any labels before applying.

Communication Interfaces

- ▶ Serial: RS 232C, RS-422, RS-485
- ▶ Parallel Centronics
- ▶ 24V PLC Interface: 6 outputs, 3 inputs

Physical

- ▶ Height: 15.749" (400.00 mm)
- ▶ Width: 10.630" (270.00 mm)
- ▶ Depth: 19.685" (500.00 mm)
- ▶ Weight: 77 lbs. (35 kg)

Electronic/Pneumatic

- ▶ Operational Voltage: 115V - 60Hz or 203V - 50Hz
- ▶ Air Pressure: 58-87 psi (4-6 bar)































► QUOTING





Because Applicator Systems have very unique configurations per application; contact customer service and ask for a Brady Automation Support Engineer (ASE) for more information or e-mail: auto_apply@bradycorp.com.

Thermal Transfer Labels

Thermal Transfer Materials Chart	79
Label Index by Part Number	81
Label Index by Size	85
Labels by Application	
Circuit Board and Component Identification	101
Wire and Cable Marking	110
Sleeves for Wire and Cable Marking by Size	111
Terminal Block Marking	113
Data Communications Equipment and Cabling Labels and Tags	114
Industrial Thermal Transfer Materials	115
Industrial Material Comparison	116
General and Industrial Identification	117
Security Identification	121
Ribbon Information and Cross-Reference Guide	123

























Type	Max. Service Temp. °F (°C)	Color	Finish	Use	Special Properties
ACETATE					
B-358	176 (80) 30 days	Clear	Gloss	Package seals and tamper-evident labeling	Flexible; tamper-resistant
B-359	176 (80) 30 days	White	Gloss	Package seals and tamper-evident labeling	Flexible; tamper-resistant
GLASS CLOTH					
B-520	932 (500) 10 min.	White	Matte	High temperature work in process ID	Label is pressure sensitive at room temperature and becomes permanently affixed at temperatures above 400°C
NYLON CLOTH					
B-499	194 (90) 30 days	White	Matte	Wire and electronic component marking	Permanent adhesive 
PAPER					
B-353	194 (90) 30 days	White	Matte	Package seals and tamper-evident labeling	Low internal strength; tamper-resistant
B-402	158 (70) 30 days	White	Matte	Bar code and general labeling	Aggressive adhesive for bonding to corrugated, films, plastic and steel
B-408	70 (21) 30 days	White	Matte	Bar code and general labeling	Repositionable adhesive
B-424	158 (70) 30 days	White	Matte	Bar code and general labeling	Good contrast and smear resistance
POLYESTER					
B-422	248 (120) 30 days	White	Gloss	Electronic PCB and component; bar code label and rating plates	2 mil adhesive recommended for application on textured surfaces  
B-423	248 (120) 30 days	White	Gloss	Electronic PCB and component; bar code label and rating plates	  
B-428	176 (80) 30 days	Silver	Matte	Rating plates; electronic component marking	  
B-430	212 (100) 30 days	Clear	Gloss	General labeling rating/name plates	Translucent 
B-432	212 (100) 30 days	Clear	Gloss	General labeling rating/name plates	Translucent; 2 mil adhesive recommended for application on textured surfaces 
B-433	248 (120) 30 days	White	Gloss	Electronic component and PCB marking; bar code label and general-purpose ID	Removable adhesive 
B-434	194 (90) 30 days	Silver	Gloss	Rating plates and general-purpose labeling	2 mil adhesive recommended for application on textured surfaces  
B-435	212 (100) 30 days	Silver	Gloss	Rating plates and general-purpose labeling	Designed to withstand solvents while maintaining excellent image quality   
B-438	104 (40) 30 days	Silver	Matte	Rating plates and tamper-evident labeling	Metallized; checkerboard footprints when removed
B-459	212 (100) 30 days	White	Matte	Electronic PCB and component; bar code label and rating plates	 
B-461	230 (110) 30 days	Clear	Matte	Laboratory applications such as liquid nitrogen, autoclave, freezer and hot water bath	Can be offered in a self-laminating format with a white printable zone
B-464	176 (80) 30 days	Silver	Gloss	Long distance bar code scanning	Retro-reflective surface
B-473	248 (120) 30 days	White	Gloss	Electronic PCB and component; bar code labeling and rating plates	Static dissipative adhesive and liner   
B-483	248 (120) 30 days	White	Gloss	General purpose labeling	Highest adhesion product for thermal transfer printing, designed for powder coated surfaces  
B-484	248 (120) 30 days	White	Gloss	Textured/rough surfaces, angled/curved surfaces	Low profile construction 
B-486	248 (120) 30 days	Silver	Matte	Rating plates; electronic component marking	Highest adhesion product for thermal transfer printing, designed for powder coated surfaces 
B-488	248 (120) 30 days	White	Matte	Electronic PCB and component; bar code label and rating plates	High performance matte white   
B-489	212 (100) 30 days	White	Matte	General purpose labeling	Highest adhesion product for thermal transfer printing, designed for powder coated surfaces
B-490	—	White	Matte	Thermal transfer printable label stock capable of adhering to cold/frozen surfaces	This material offers the unique ability to apply identification to a frost covered/cryogenically frozen surfaces
B-7546	175 (80) 30 days	White	Gloss	Rating plates and tamper-evident labeling	"Void" footprint when removed 
B-7566	175 (80) 30 days	Clear	Gloss	Rating plates and tamper-evident labeling	"Void" footprint when removed 
B-7576	212 (100) 30 days	Silver	Matte	Rating plates and tamper-evident labeling	Metallized; leaves "Void" footprint when removed 
B-8423	248 (120) 30 days	White	Satin	General purpose labeling	 
POLYESTER/PAPER					
B-350	194 (90) 30 days	White	Gloss	Control of invalid warranty claims	Provides evidence of exposure to water 
B-354	194 (90) 30 days	White	Gloss	Control of invalid warranty claims	Provides evidence of exposure to water 
POLYETHYLENE NAPHTHALATE (PEN)					
B-495	464 (240) 5 min.	White	Gloss	Top- or bottom-side board application for SMT, or Topside or Through hole	Good contrast and smear resistance
POLYIMIDE					
B-426	662 (350) 80 sec.	Amber	Matte	Top- or bottom-side board application for SMT or Through hole	Withstands extremely high temperatures
B-436	662 (350) 80 sec.	Amber	Matte	Printed circuit board and component marking	Label will remove cleanly after high-temperature exposure
B-457	662 (350) 80 sec.	White	Gloss	Top- or bottom-side board application for SMT or Through hole	Good contrast and smear resistance 

	These materials have static dissipative adhesives.
	*These materials are UL recognized.
	*These materials are CSA approved.
	*These materials are AGA approved.

*Refer to the full page charts on pages 280-281 for more information and complete listing of parts.
 **Currently in testing.

Thermal Transfer Materials Chart

Type	Max. Service Temp. °F (°C)	Color	Finish	Use	Special Properties
POLYIMIDE (continued)					
B-477	662 (350) 80 sec.	White	Gloss	Top- or bottom-side board application for SMT or Through hole	Static dissipative adhesive and liner  
B-478	662 (350) 80 sec.	White	Gloss	Top- or bottom-side board application for SMT or Through hole	Static dissipative adhesive and liner, low profile construction, good contrast and smear resistance  
B-479	662 (350) 80 sec.	White	Matte	Top- or bottom-side board application for SMT or Through hole	Static dissipative adhesive and liner, low profile construction, excellent resistance to solder balling, matte finish  
B-487	662 (350) 80 sec.	White	Matte	Top- or bottom-side board application for SMT or Through hole	Excellent resistance to solder balling, matte finish 
B-497	662 (350) 80 sec.	White	Matte	Top- or bottom-side board application for SMT or Through hole	Low-profile construction, excellent resistance to solder balling, matte finish 
POLYOLEFIN					
B-407	194 (90) 30 days	Clear	Matte	General purpose labeling	Clear Polyolefin  
B-449	194 (90) 30 days	White	Matte	Temporary labeling application	Removable; good solvent resistance and print performance 
POLYPROPYLENE					
B-8425	194 (90) 30 days	White	Gloss	Rating plates and general purpose labeling	Excellent abrasion and smudge resistance  
SLEEVE MATERIALS					
B-341 Polyolefin	275 (135) 30 days	White	Matte	Wire marking	2-to-1 shrink ratio, self-extinguishing; meets MIL-1-23053/5 class 1; MIL-M-81531; MIL-STD-202F; method 215 and UL 224  
B-342 Polyolefin	275 (135) 30 days	White/Yellow	Matte	Wire marking	3-to-1 shrink ratio, self-extinguishing; meets MIL-1-23053/5 class 1; MIL-M-81531; MIL-STD-202F; method 215 and UL 224  
TAG MATERIAL					
B-109	176 (80) 30 days	White	Matte	Multi-purpose identification tag, where durability and computer printability are required	Cross-laminated polyethylene provides extreme tear resistance and excellent cold-weather performance
B-411	122 (50) 30 days	White	Matte	Tag material designed for general purpose marking	Spunbound polyolefin provides resistance to water and chemicals
B-412	212 (100) 30 days	White	Matte	Wire, cable and product inventory identification	Polypropylene tag designed for outdoor and harsh environmental applications or where tensile strength is needed
TEDLAR®					
B-437	275 (135) 30 days	White/Yellow	Matte	Aerospace and military cable marking	Self-extinguishing; available in white or yellow
VINYL					
B-351	212 (100) 30 days	White	Matte	Tamper-resistant labels	Flexible; solvent resistant; tamper-resistant
B-352	176 (80) 30 days	Silver	Matte	Tamper-resistant labels	Flexible; solvent resistant; tamper-resistant
B-427	158 (70) 30 days	White	Matte	Self-laminating wire and cable marking	Excellent abrasion and smudge resistance, perforations exist between each row of labels for easy tear-off or fan folding  
B-439	104 (40) 30 days	White/Colors	Gloss	Rating plates and general-purpose labeling	Available in 9 colors
VINYL CLOTH					
B-498	175 (80) 30 days	White	Semi-Gloss	Wire and electronic component marking	Repositionable adhesive 

-  These materials have static dissipative adhesives.
-  *These materials are UL recognized.
-  *These materials are CSA approved.

*Refer to the full page charts on pages 280-281 for more information and complete listing of parts.

Label Index by Part Number

Part Number	Size Inch (mm)	Specifications on Page	Part Number	Size Inch (mm)	Specifications on Page	Part Number	Size Inch (mm)	Specifications on Page
THTHD-45-478*	0.250 x 1.500 (6.35 x 38.10)	86	THTHD-49-487*	0.250 x 0.900 (6.35 x 22.86)	86	THTHD-108-495*	0.150 x 1.500 (3.81 x 38.10)	86
THTHD-45-487*	0.250 x 1.500 (6.35 x 38.10)	86	THTHD-49-495*	0.250 x 0.900 (6.35 x 22.86)	86	XTHT-1-8423	0.750 x 0.250 (19.05 x 6.35)	89
THTHD-45-495*	0.250 x 1.500 (6.35 x 38.10)	86	THTHD-70-426*	0.250 x 0.250 (6.35 x 6.35)	85	XTHT-2-8423	0.900 x 0.250 (22.86 x 6.35)	89
THTHD-46-426*	0.250 x 0.750 (6.35 x 19.05)	85	THTHD-70-457*	0.250 x 0.250 (6.35 x 6.35)	85	XTHT-3-8423	1.000 x 0.375 (25.40 x 9.53)	90
THTHD-46-457*	0.250 x 0.750 (6.35 x 19.05)	85	THTHD-70-477*	0.250 x 0.250 (6.35 x 6.35)	85	XTHT-4-8423	1.500 x 0.250 (38.10 x 6.35)	93
THTHD-46-477*	0.250 x 0.750 (6.35 x 19.05)	85	THTHD-70-478*	0.250 x 0.250 (6.35 x 6.35)	85	XTHT-5-8423	1.000 x 0.500 (25.40 x 12.70)	91
THTHD-46-478*	0.250 x 0.750 (6.35 x 19.05)	85	THTHD-70-487*	0.250 x 0.250 (6.35 x 6.35)	85	XTHT-5-8425	1.000 x 0.500 (25.40 x 12.70)	91
THTHD-46-487*	0.250 x 0.750 (6.35 x 19.05)	85	THTHD-70-495*	0.250 x 0.250 (6.35 x 6.35)	85	XTHT-7-8425	2.750 x 1.250 (69.85 x 31.75)	95
THTHD-46-495*	0.250 x 0.750 (6.35 x 19.05)	85	THTHD-103-426*	0.250 x 1.000 (6.35 x 25.40)	86	XTHT-17-8423	2.000 x 1.000 (50.80 x 25.40)	95
THTHD-47-426*	0.200 x 0.650 (5.08 x 16.51)	85	THTHD-103-457*	0.250 x 1.000 (6.35 x 25.40)	86	XTHT-17-8425	2.000 x 1.000 (50.80 x 25.40)	95
THTHD-47-457*	0.200 x 0.650 (5.08 x 16.51)	85	THTHD-103-477*	0.250 x 1.000 (6.35 x 25.40)	86	XTHT-18-8423	3.000 x 1.000 (76.20 x 25.40)	96
THTHD-47-477*	0.200 x 0.650 (5.08 x 16.51)	85	THTHD-103-478*	0.250 x 1.000 (6.35 x 25.40)	86	XTHT-18-8425	3.000 x 1.000 (76.20 x 25.40)	96
THTHD-47-478*	0.200 x 0.650 (5.08 x 16.51)	85	THTHD-103-487*	0.250 x 1.000 (6.35 x 25.40)	86	XTHT-19-8423	3.000 x 2.000 (76.20 x 50.80)	96
THTHD-47-487*	0.200 x 0.650 (5.08 x 16.51)	85	THTHD-103-495*	0.250 x 1.000 (6.35 x 25.40)	86	XTHT-19-8425	3.000 x 2.000 (76.20 x 50.80)	96
THTHD-47-495*	0.200 x 0.650 (5.08 x 16.51)	85	THTHD-108-426*	0.150 x 1.500 (3.81 x 38.10)	86	XTHT-20-8425	3.000 x 5.000 (76.20 x 127.00)	96
THTHD-49-426*	0.250 x 0.900 (6.35 x 22.86)	85	THTHD-108-457*	0.150 x 1.500 (3.81 x 38.10)	86	XTHT-55-8423	4.000 x 2.000 (101.60 x 50.80)	97
THTHD-49-457*	0.250 x 0.900 (6.35 x 22.86)	86	THTHD-108-477*	0.150 x 1.500 (3.81 x 38.10)	86	XTHT-55-8425	4.000 x 2.000 (101.60 x 50.80)	97
THTHD-49-477*	0.250 x 0.900 (6.35 x 22.86)	86	THTHD-108-478*	0.150 x 1.500 (3.81 x 38.10)	86	XTHT-76-8425	4.000 x 3.000 (101.60 x 76.20)	97
THTHD-49-478*	0.250 x 0.900 (6.35 x 22.86)	86	THTHD-108-487*	0.150 x 1.500 (3.81 x 38.10)	86			

LABEL INDEX BY PART NUMBER THERMAL TRANSFER LABELS

THTHD-108-426-2.5

Thermal Transfer technology
Die # 108, 0.150" x 1.500"
Package Quantity, 2,500
Material B-426, White Vinyl Cloth

PART NUMBER EXPLANATION:

Most Brady part numbers for printable labels follow the same four-part format:

The first code indicates the technology, the second part is a number indicating the die size used (where applicable), the third part indicates the Brady material used (where applicable), and the final code indicates package quantity.

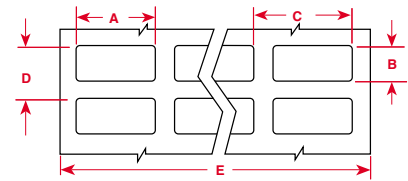

Part Number	Pieces Per Package	Material	Color	Labels Per Row	Label Width Inch (mm) A	Label Height Inch (mm) B	Horizontal Repeat Inch (mm) C	Vertical Repeat Inch (mm) D	Web Width Inch (mm) E	Recommended Ribbon
0.150" Label Width										
THTHD-108-426-2.5*	2,500	Polyimide	Amber	1	0.150 (3.81)	1.500 (38.10)	—	1.600 (40.64)	0.450 (11.43)	R4311
THTHD-108-457-2.5*	2,500	Polyimide	White	1	0.150 (3.81)	1.500 (38.10)	—	1.600 (40.64)	0.450 (11.43)	R6011
THTHD-108-477-2.5*	2,500	Polyimide	White	1	0.150 (3.81)	1.500 (38.10)	—	1.600 (40.64)	0.450 (11.43)	R6011
THTHD-108-478-2.5*	2,500	Polyimide	White	1	0.150 (3.81)	1.500 (38.10)	—	1.600 (40.64)	0.450 (11.43)	R6011
THTHD-108-487-2.5*	2,500	Polyimide	White	1	0.150 (3.81)	1.500 (38.10)	—	1.600 (40.64)	0.450 (11.43)	R6011
THTHD-108-495-2.5*	2,500	PEN	White	1	0.150 (3.81)	1.500 (38.10)	—	1.600 (40.64)	0.450 (11.43)	R6011
0.187" Label Width										
THTHD-42-426-4*	4,000	Polyimide	Amber	1	0.187 (4.75)	1.000 (25.40)	—	1.100 (27.94)	0.450 (11.43)	R4311
THTHD-42-457-4*	4,000	Polyimide	White	1	0.187 (4.75)	1.000 (25.40)	—	1.100 (27.94)	0.450 (11.43)	R6011
THTHD-42-477-4*	4,000	Polyimide	White	1	0.187 (4.75)	1.000 (25.40)	—	1.100 (27.94)	0.450 (11.43)	R6011
THTHD-42-478-4*	4,000	Polyimide	White	1	0.187 (4.75)	1.000 (25.40)	—	1.100 (27.94)	0.450 (11.43)	R6011
THTHD-42-487-4*	4,000	Polyimide	White	1	0.187 (4.75)	1.000 (25.40)	—	1.100 (27.94)	0.450 (11.43)	R6011
THTHD-42-495-4*	4,000	PEN	White	1	0.187 (4.75)	1.000 (25.40)	—	1.100 (27.94)	0.450 (11.43)	R6011
0.200" Label Width										
THTHD-47-426-5.5*	5,500	Polyimide	Amber	1	0.200 (5.08)	0.650 (16.51)	—	0.725 (18.42)	0.450 (11.43)	R4311
THTHD-47-457-5.5*	5,500	Polyimide	White	1	0.200 (5.08)	0.650 (16.51)	—	0.725 (18.42)	0.450 (11.43)	R6011
THTHD-47-477-5.5*	5,500	Polyimide	White	1	0.200 (5.08)	0.650 (16.51)	—	0.725 (18.42)	0.450 (11.43)	R6011
THTHD-47-478-5.5*	5,500	Polyimide	White	1	0.200 (5.08)	0.650 (16.51)	—	0.725 (18.42)	0.450 (11.43)	R6011
THTHD-47-487-5.5*	5,500	Polyimide	White	1	0.200 (5.08)	0.650 (16.51)	—	0.725 (18.42)	0.450 (11.43)	R6011
THTHD-47-495-5.5*	5,500	PEN	White	1	0.200 (5.08)	0.650 (16.51)	—	0.725 (18.42)	0.450 (11.43)	R6011
0.240" Label Width										
THT-94-498-2	1	Vinyl Cloth	White	1	0.240 (6.10)	165 ft (50.80 m)	—	—	1000 (25.40)	R4311
0.250" Label Width										
THT-70-350-5	5,000	Polyester/Paper	White	7	0.250 (6.35)	0.250 (6.35)	0.320 (8.13)	0.350 (8.89)	2.370 (60.20)	R6000
THT-70-350-20	20,000	Polyester/Paper	White	7	0.250 (6.35)	0.250 (6.35)	0.320 (8.13)	0.350 (8.89)	2.370 (60.20)	R6000
THT-70-354-20	20,000	Polyester/Paper	White	7	0.250 (6.35)	0.250 (6.35)	0.320 (8.13)	0.350 (8.89)	2.370 (60.20)	R6200
THT-11-423-10	10,000	Polyester	White	12	0.250 (6.35)	0.250 (6.35)	0.250 (6.35)	0.375 (9.53)	3.200 (81.28)	R6002
THT-11-426-10	10,000	Polyimide	Amber	12	0.250 (6.35)	0.250 (6.35)	0.250 (6.35)	0.375 (9.53)	3.200 (81.28)	R4300
THTHD-70-426-12*	12,000	Polyimide	Amber	1	0.250 (6.35)	0.250 (6.35)	—	0.350 (8.89)	0.450 (11.43)	R4311
THT-11-436-10	10,000	Polyimide	Amber	12	0.250 (6.35)	0.250 (6.35)	0.250 (6.35)	0.375 (9.53)	3.200 (81.28)	R4300
THT-11-457-10	10,000	Polyimide	White	12	0.250 (6.35)	0.250 (6.35)	0.250 (6.35)	0.375 (9.53)	3.200 (81.28)	R6002
THT-70-457-20	20,000	Polyimide	White	7	0.250 (6.35)	0.250 (6.35)	0.320 (8.13)	0.350 (8.89)	2.370 (60.20)	R6000
THTHD-70-457-12*	12,000	Polyimide	White	1	0.250 (6.35)	0.250 (6.35)	—	0.350 (8.89)	0.450 (11.43)	R6011
THT-11-473-10	10,000	Polyester	White	12	0.250 (6.35)	0.250 (6.35)	0.250 (6.35)	0.375 (9.53)	3.200 (81.28)	R6002
THT-70-473-20	20,000	Polyester	White	7	0.250 (6.35)	0.250 (6.35)	0.320 (8.13)	0.350 (8.89)	2.370 (60.20)	R6000
THT-70-477-20	20,000	Polyimide	White	7	0.250 (6.35)	0.250 (6.35)	0.320 (8.13)	0.350 (8.89)	2.370 (60.20)	R6000
THTHD-70-477-12*	12,000	Polyimide	White	1	0.250 (6.35)	0.250 (6.35)	—	0.350 (8.89)	0.450 (11.43)	R6011
THT-70-478-20	20,000	Polyimide	White	7	0.250 (6.35)	0.250 (6.35)	0.320 (8.13)	0.350 (8.89)	2.370 (60.20)	R6000
THTHD-70-478-12*	12,000	Polyimide	White	1	0.250 (6.35)	0.250 (6.35)	—	0.350 (8.89)	0.450 (11.43)	R6011
THT-70-479-20	20,000	Polyimide	White	7	0.250 (6.35)	0.250 (6.35)	0.320 (8.13)	0.350 (8.89)	2.370 (60.20)	R6000
THT-70-487-20	20,000	Polyimide	White	7	0.250 (6.35)	0.250 (6.35)	0.320 (8.13)	0.350 (8.89)	2.370 (60.20)	R6000
THTHD-70-487-12*	12,000	Polyimide	White	1	0.250 (6.35)	0.250 (6.35)	—	0.350 (8.89)	0.450 (11.43)	R6011
THT-70-495-20	20,000	PEN	White	7	0.250 (6.35)	0.250 (6.35)	0.320 (8.13)	0.350 (8.89)	2.370 (60.20)	R6000
THTHD-70-495-12*	12,000	PEN	White	1	0.250 (6.35)	0.250 (6.35)	—	0.350 (8.89)	0.450 (11.43)	R6011
THT-70-497-20	20,000	Polyimide	White	7	0.250 (6.35)	0.250 (6.35)	0.320 (8.13)	0.350 (8.89)	2.370 (60.20)	R6000
THTHD-46-426-5*	5,000	Polyimide	Amber	1	0.250 (6.35)	0.750 (18.75)	—	0.850 (21.59)	0.450 (11.43)	R4311
THTHD-46-457-5*	5,000	Polyimide	White	1	0.250 (6.35)	0.750 (18.75)	—	0.850 (21.59)	0.450 (11.43)	R6011
THTHD-46-477-5*	5,000	Polyimide	White	1	0.250 (6.35)	0.750 (18.75)	—	0.850 (21.59)	0.450 (11.43)	R6011
THTHD-46-478-5*	5,000	Polyimide	White	1	0.250 (6.35)	0.750 (18.75)	—	0.850 (21.59)	0.450 (11.43)	R6011
THTHD-46-487-5*	5,000	Polyimide	White	1	0.250 (6.35)	0.750 (18.75)	—	0.850 (21.59)	0.450 (11.43)	R6011
THTHD-46-495-5*	5,000	PEN	White	1	0.250 (6.35)	0.750 (18.75)	—	0.850 (21.59)	0.450 (11.43)	R6011
THTHD-49-426-4.5*	4,500	Polyimide	Amber	1	0.250 (6.35)	0.900 (22.86)	—	1.000 (25.40)	0.450 (11.43)	R4311

Note: Labels in chart are sorted in order by width, height, 3 or 4 digit material number (within part number), then die number (within part number).

*For use with Hover-Davis vertical format label feeders.

Label Index by Size

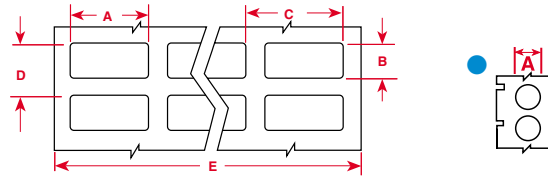

LABEL INDEX BY SIZE THERMAL TRANSFER LABELS

Part Number	Pieces Per Package	Material	Color	Labels Per Row	Label Width Inch (mm) A	Label Height Inch (mm) B	Horizontal Repeat Inch (mm) C	Vertical Repeat Inch (mm) D	Web Width Inch (mm) E	Recommended Ribbon
0.250" Label Width (Cont.)										
THTHD-49-457-4.5*	4,500	Polyimide	White	1	0.250 (6.35)	0.900 (22.86)	—	1.000 (25.40)	0.450 (11.43)	R6011
THTHD-49-477-4.5*	4,500	Polyimide	White	1	0.250 (6.35)	0.900 (22.86)	—	1.000 (25.40)	0.450 (11.43)	R6011
THTHD-49-478-4.5*	4,500	Polyimide	White	1	0.250 (6.35)	0.900 (22.86)	—	1.000 (25.40)	0.450 (11.43)	R6011
THTHD-49-487-4.5*	4,500	Polyimide	White	1	0.250 (6.35)	0.900 (22.86)	—	1.000 (25.40)	0.450 (11.43)	R6011
THTHD-49-495-4.5*	4,500	PEN	White	1	0.250 (6.35)	0.900 (22.86)	—	1.000 (25.40)	0.450 (11.43)	R6011
THTHD-103-426-4*	4,000	Polyimide	Amber	1	0.250 (6.35)	1.000 (25.40)	—	1.100 (27.94)	0.450 (11.43)	R4311
THTHD-103-457-4*	4,000	Polyimide	White	1	0.250 (6.35)	1.000 (25.40)	—	1.100 (27.94)	0.450 (11.43)	R6011
THTHD-103-477-4*	4,000	Polyimide	White	1	0.250 (6.35)	1.000 (25.40)	—	1.100 (27.94)	0.450 (11.43)	R6011
THTHD-103-478-4*	4,000	Polyimide	White	1	0.250 (6.35)	1.000 (25.40)	—	1.100 (27.94)	0.450 (11.43)	R6011
THTHD-103-487-4*	4,000	Polyimide	White	1	0.250 (6.35)	1.000 (25.40)	—	1.100 (27.94)	0.450 (11.43)	R6011
THTHD-103-495-4*	4,000	PEN	White	1	0.250 (6.35)	1.000 (25.40)	—	1.100 (27.94)	0.450 (11.43)	R6011
THTHD-43-426-3.5*	3,500	Polyimide	Amber	1	0.250 (6.35)	1.250 (31.75)	—	1.350 (34.29)	0.450 (11.43)	R4311
THTHD-43-457-3.5*	3,500	Polyimide	White	1	0.250 (6.35)	1.250 (31.75)	—	1.350 (34.29)	0.450 (11.43)	R6011
THTHD-43-477-3.5*	3,500	Polyimide	White	1	0.250 (6.35)	1.250 (31.75)	—	1.350 (34.29)	0.450 (11.43)	R6011
THTHD-43-478-3.5*	3,500	Polyimide	White	1	0.250 (6.35)	1.250 (31.75)	—	1.350 (34.29)	0.450 (11.43)	R6011
THTHD-43-487-3.5*	3,500	Polyimide	White	1	0.250 (6.35)	1.250 (31.75)	—	1.350 (34.29)	0.450 (11.43)	R6011
THTHD-43-495-3.5*	3,500	PEN	White	1	0.250 (6.35)	1.250 (31.75)	—	1.350 (34.29)	0.450 (11.43)	R6011
THTHD-44-426-3*	4,000	Polyimide	Amber	1	0.250 (6.35)	1.375 (34.93)	—	1.475 (37.47)	0.450 (11.43)	R4311
THTHD-44-457-3*	3,000	Polyimide	White	1	0.250 (6.35)	1.375 (34.93)	—	1.475 (37.47)	0.450 (11.43)	R6011
THTHD-44-477-3*	3,000	Polyimide	White	1	0.250 (6.35)	1.375 (34.93)	—	1.475 (37.47)	0.450 (11.43)	R6011
THTHD-44-478-3*	3,000	Polyimide	White	1	0.250 (6.35)	1.375 (34.93)	—	1.475 (37.47)	0.450 (11.43)	R6011
THTHD-44-487-3*	3,000	Polyimide	White	1	0.250 (6.35)	1.375 (34.93)	—	1.475 (37.47)	0.450 (11.43)	R6011
THTHD-44-495-3*	3,000	PEN	White	1	0.250 (6.35)	1.375 (34.93)	—	1.475 (37.47)	0.450 (11.43)	R6011
THT-90-498-5	5,000	Vinyl Cloth	White	6	0.250 (6.35)	1.437 (36.50)	0.350 (8.89)	1.562 (39.68)	2.200 (55.88)	R4300
THTHD-45-426-2.5*	2,500	Polyimide	Amber	1	0.250 (6.35)	1.500 (38.10)	—	1.600 (40.64)	0.450 (11.43)	R4311
THTHD-45-457-2.5*	2,500	Polyimide	White	1	0.250 (6.35)	1.500 (38.10)	—	1.600 (40.64)	0.450 (11.43)	R6011
THTHD-45-477-2.5*	2,500	Polyimide	White	1	0.250 (6.35)	1.500 (38.10)	—	1.600 (40.64)	0.450 (11.43)	R6011
THTHD-45-478-2.5*	2,500	Polyimide	White	1	0.250 (6.35)	1.500 (38.10)	—	1.600 (40.64)	0.450 (11.43)	R6011
THTHD-45-487-2.5*	2,500	Polyimide	White	1	0.250 (6.35)	1.500 (38.10)	—	1.600 (40.64)	0.450 (11.43)	R6011
THTHD-45-495-2.5*	2,500	PEN	White	1	0.250 (6.35)	1.500 (38.10)	—	1.600 (40.64)	0.450 (11.43)	R6011
0.315" Label Width										
THT-104-354-20	20,000	Polyester/Paper	White	6	0.315 (8.00)	0.177 (4.50)	0.375 (9.53)	0.278 (7.06)	2.39 (60.71)	R6200
THT-104-497-20	20,000	Polyimide	White	6	0.315 (8.00)	0.177 (4.50)	0.375 (9.53)	0.278 (7.06)	2.39 (60.71)	R6000
THT-71-457-20	20,000	Polyimide	White	6	0.315 (8.00)	0.315 (8.00)	0.375 (9.53)	0.415 (10.54)	2.39 (60.71)	R6000
THT-71-478-20	20,000	Polyimide	White	6	0.315 (8.00)	0.315 (8.00)	0.375 (9.53)	0.415 (10.54)	2.39 (60.71)	R6000
THT-71-479-20	20,000	Polyimide	White	6	0.315 (8.00)	0.315 (8.00)	0.375 (9.53)	0.415 (10.54)	2.39 (60.71)	R6000
THT-71-495-20	20,000	PEN	White	6	0.315 (8.00)	0.315 (8.00)	0.375 (9.53)	0.415 (10.54)	2.39 (60.71)	R6000
0.318" Label Width										
THT-93-498-2	1	Vinyl Cloth	White	1	0.318 (8.08)	165 ft (50.80 m)	—	—	1.000 (25.40)	R4311
0.375" Label Width										
THT-143-499-3●	3,000	Nylon Cloth	White	4	0.375 (9.53) dia.	—	0.475 (12.07)	0.500 (12.70)	2.000 (50.80)	R4302
THT-38-423-10	10,000	Polyester	White	7	0.375 (9.53)	0.375 (9.53)	0.437 (11.10)	0.475 (12.07)	3.200 (81.28)	R6002
THT-38-426-10	10,000	Polyimide	Amber	7	0.375 (9.53)	0.375 (9.53)	0.437 (11.10)	0.475 (12.07)	3.200 (81.28)	R4300
THT-38-457-10	10,000	Polyimide	White	7	0.375 (9.53)	0.375 (9.53)	0.437 (11.10)	0.475 (12.07)	3.200 (81.28)	R6002
THT-38-473-10	10,000	Polyester	White	7	0.375 (9.53)	0.375 (9.53)	0.437 (11.10)	0.475 (12.07)	3.200 (81.28)	R6002
THT-38-477-10	10,000	Polyimide	White	7	0.375 (9.53)	0.375 (9.53)	0.437 (11.10)	0.475 (12.07)	3.200 (81.28)	R6002
THT-38-478-10	10,000	Polyimide	White	7	0.375 (9.53)	0.375 (9.53)	0.437 (11.10)	0.475 (12.07)	3.200 (81.28)	R6002
THT-38-479-10	10,000	Polyimide	White	7	0.375 (9.53)	0.375 (9.53)	0.437 (11.10)	0.475 (12.07)	3.200 (81.28)	R6002
THT-38-487-10	10,000	Polyimide	White	7	0.375 (9.53)	0.375 (9.53)	0.437 (11.10)	0.475 (12.07)	3.200 (81.28)	R6002
THT-38-495-10	10,000	PEN	White	7	0.375 (9.53)	0.375 (9.53)	0.437 (11.10)	0.475 (12.07)	3.200 (81.28)	R6002
THT-38-497-10	10,000	Polyimide	White	7	0.375 (9.53)	0.375 (9.53)	0.437 (11.10)	0.475 (12.07)	3.200 (81.28)	R6002
THT-92-498-2	1	Vinyl Cloth	White	1	0.375 (9.53)	165 ft (50.80 m)	—	—	1.000 (25.40)	R4311

Note: Labels in chart are sorted in order by width, height, 3 or 4 digit material number (within part number), then die number (within part number).

*For use with Hover-Davis vertical format label feeders.

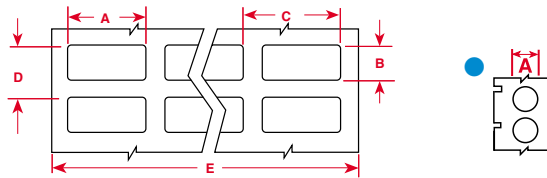

Part Number	Pieces Per Package	Material	Color	Labels Per Row	Label Width Inch (mm) A	Label Height Inch (mm) B	Horizontal Repeat Inch (mm) C	Vertical Repeat Inch (mm) D	Web Width Inch (mm) E	Recommended Ribbon
0.500" Label Width										
THT-144-499-3●	3,000	Nylon Cloth	White	3	0.500 (12.70)	dia.	0.600 (15.24)	0.625 (15.88)	1.900 (48.26)	R4302
THT-36-422-10	10,000	Polyester	White	5	0.500 (12.70)	0.200 (5.08)	0.625 (15.88)	0.300 (7.62)	3.200 (81.28)	R6002
THT-36-423-10	10,000	Polyester	White	5	0.500 (12.70)	0.200 (5.08)	0.625 (15.88)	0.300 (7.62)	3.200 (81.28)	R6002
THT-36-473-10	10,000	Polyester	White	5	0.500 (12.70)	0.200 (5.08)	0.625 (15.88)	0.300 (7.62)	3.200 (81.28)	R6002
THT-97-423-10	10,000	Polyester	White	1	0.500 (12.70)	0.200 (5.08)	—	0.300 (7.62)	0.700 (17.78)	R6011
THT-97-457-10	10,000	Polyimide	White	1	0.500 (12.70)	0.200 (5.08)	—	0.300 (7.62)	0.700 (17.78)	R6011
THT-97-473-10	10,000	Polyester	White	1	0.500 (12.70)	0.200 (5.08)	—	0.300 (7.62)	0.700 (17.78)	R6011
THT-97-477-10	10,000	Polyimide	White	1	0.500 (12.70)	0.200 (5.08)	—	0.300 (7.62)	0.700 (17.78)	R6011
THT-97-478-10	10,000	Polyimide	White	1	0.500 (12.70)	0.200 (5.08)	—	0.300 (7.62)	0.700 (17.78)	R6011
THT-97-479-10	10,000	Polyimide	White	1	0.500 (12.70)	0.200 (5.08)	—	0.300 (7.62)	0.700 (17.78)	R6011
THT-97-487-10	10,000	Polyimide	White	1	0.500 (12.70)	0.200 (5.08)	—	0.300 (7.62)	0.700 (17.78)	R6011
THT-97-495-10	10,000	PEN	White	1	0.500 (12.70)	0.200 (5.08)	—	0.300 (7.62)	0.700 (17.78)	R6011
THT-97-497-10	10,000	Polyimide	White	1	0.500 (12.70)	0.200 (5.08)	—	0.300 (7.62)	0.700 (17.78)	R6011
THT-96-354-10	10,000	Polyester/Paper	White	4	0.500 (12.70)	0.275 (6.99)	0.600 (15.24)	0.375 (9.53)	2.500 (63.50)	R6200
THT-96-473-10	10,000	Polyester	White	4	0.500 (12.70)	0.275 (6.99)	0.600 (15.24)	0.375 (9.53)	2.500 (63.50)	R6000
THT-96-477-10	10,000	Polyimide	White	4	0.500 (12.70)	0.275 (6.99)	0.600 (15.24)	0.375 (9.53)	2.500 (63.50)	R6000
THT-96-487-10	10,000	Polyimide	White	4	0.500 (12.70)	0.275 (6.99)	0.600 (15.24)	0.375 (9.53)	2.500 (63.50)	R6000
THT-96-497-10	10,000	Polyimide	White	4	0.500 (12.70)	0.275 (6.99)	0.600 (15.24)	0.375 (9.53)	2.500 (63.50)	R6000
THT-148-422-10	10,000	Polyester	White	4	0.500 (12.70)	0.375 (9.50)	0.600 (15.24)	0.475 (12.07)	2.500 (63.50)	R6002
THT-148-430-10	10,000	Polyester	Clear	4	0.500 (12.70)	0.375 (9.50)	0.600 (15.24)	0.500 (12.70)	2.500 (63.50)	R6002
THT-12-351-10	10,000	Tamper-Resistant Vinyl	White	5	0.500 (12.70)	0.437 (11.10)	0.662 (16.81)	0.537 (13.64)	3.350 (85.09)	R6202
THT-12-423-10	10,000	Polyester	White	5	0.500 (12.70)	0.437 (11.10)	0.662 (16.81)	0.537 (13.64)	3.350 (85.09)	R6002
THT-12-426-10	10,000	Polyimide	Amber	5	0.500 (12.70)	0.437 (11.10)	0.662 (16.81)	0.537 (13.64)	3.350 (85.09)	R4300
THT-12-428-10	10,000	Metallized Polyester	Silver	5	0.500 (12.70)	0.437 (11.10)	0.662 (16.81)	0.537 (13.64)	3.350 (85.09)	R4300
THT-12-433-10	10,000	Removable Polyester	White	5	0.500 (12.70)	0.437 (11.10)	0.662 (16.81)	0.537 (13.64)	3.350 (85.09)	R6002
THT-12-435-10	10,000	Glossy Metallized Polyester	Silver	5	0.500 (12.70)	0.437 (11.10)	0.662 (16.81)	0.537 (13.64)	3.350 (85.09)	R6002
THT-12-438-10	10,000	Tamper-Evident Polyester	Silver	5	0.500 (12.70)	0.437 (11.10)	0.662 (16.81)	0.537 (13.64)	3.350 (85.09)	R4300
THT-12-457-10	10,000	Polyimide	White	5	0.500 (12.70)	0.437 (11.10)	0.662 (16.81)	0.537 (13.64)	3.350 (85.09)	R6002
THT-12-473-10	10,000	Polyester	White	5	0.500 (12.70)	0.437 (11.10)	0.662 (16.81)	0.537 (13.64)	3.350 (85.09)	R6002
THT-12-477-10	10,000	Polyimide	White	5	0.500 (12.70)	0.437 (11.10)	0.662 (16.81)	0.537 (13.64)	3.350 (85.09)	R6002
THT-12-478-10	10,000	Polyimide	White	5	0.500 (12.70)	0.437 (11.10)	0.662 (16.81)	0.537 (13.64)	3.350 (85.09)	R6002
THT-12-479-10	10,000	Polyimide	White	5	0.500 (12.70)	0.437 (11.10)	0.662 (16.81)	0.537 (13.64)	3.350 (85.09)	R6002
THT-12-487-10	10,000	Polyimide	White	5	0.500 (12.70)	0.437 (11.10)	0.662 (16.81)	0.537 (13.64)	3.350 (85.09)	R6002
THT-12-495-10	10,000	PEN	White	5	0.500 (12.70)	0.437 (11.10)	0.662 (16.81)	0.537 (13.64)	3.350 (85.09)	R6002
THT-12-497-10	10,000	Polyimide	White	5	0.500 (12.70)	0.437 (11.10)	0.662 (16.81)	0.537 (13.64)	3.350 (85.09)	R6002
THT-149-358-10	10,000	Tamper-Resistant Acetate	Clear	4	0.500 (12.70)	0.500 (12.70)	0.600 (15.24)	0.600 (15.24)	2.500 (63.50)	R6202
THT-99-359-10	10,000	Tamper-Resistant Acetate	White	4	0.500 (12.70)	0.500 (12.70)	—	0.600 (15.24)	0.700 (17.78)	R6211
THT-149-422-10	10,000	Polyester	White	4	0.500 (12.70)	0.500 (12.70)	0.600 (15.24)	0.600 (15.24)	2.500 (63.50)	R6002
THT-149-430-10	10,000	Polyester	Clear	4	0.500 (12.70)	0.500 (12.70)	0.600 (15.24)	0.605 (15.38)	2.500 (63.50)	R6002
THT-99-473-10	10,000	Polyimide	White	1	0.500 (12.70)	0.500 (12.70)	—	0.600 (15.24)	0.700 (17.78)	R6011
THT-99-477-10	10,000	Polyimide	White	1	0.500 (12.70)	0.500 (12.70)	—	0.600 (15.24)	0.700 (17.78)	R6011
THT-99-478-10	10,000	Polyimide	White	1	0.500 (12.70)	0.500 (12.70)	—	0.600 (15.24)	0.700 (17.78)	R6011
THT-99-479-10	10,000	Polyimide	White	1	0.500 (12.70)	0.500 (12.70)	—	0.600 (15.24)	0.700 (17.78)	R6011
THT-99-487-10	10,000	Polyimide	White	1	0.500 (12.70)	0.500 (12.70)	—	0.600 (15.24)	0.700 (17.78)	R6011
THT-99-495-10	10,000	PEN	White	1	0.500 (12.70)	0.500 (12.70)	—	0.600 (15.24)	0.700 (17.78)	R6011
THT-99-497-10	10,000	Polyimide	White	1	0.500 (12.70)	0.500 (12.70)	—	0.600 (15.24)	0.700 (17.78)	R6011
THT-149-7566-10	10,000	Tamper-Evident Polyester	Clear	4	0.500 (12.70)	0.500 (12.70)	0.600 (15.24)	0.600 (15.24)	2.500 (63.50)	R6002
THT-68-498-10	10,000	Vinyl Cloth	White	4	0.500 (12.70)	0.750 (19.05)	0.600 (15.24)	0.850 (21.59)	2.500 (63.50)	R4300
THT-68-499-10	10,000	Nylon Cloth	White	4	0.500 (12.70)	0.750 (19.05)	0.600 (15.24)	0.850 (21.59)	2.500 (63.50)	R4902
THT-87-498-10	10,000	Vinyl Cloth	White	6	0.500 (12.70)	1.440 (36.50)	0.600 (15.24)	1.562 (39.68)	3.700 (93.98)	R4300
0.590" Label Width										
DSTHT-15-390-1	1,000	Polypropylene	White	1	0.590 (15.00)	0.163 (4.14)	—	0.402 (10.21)	—	R6200
DSTHT-15-390-2.5	2,500	Polypropylene	White	1	0.590 (15.00)	0.163 (4.14)	—	0.402 (10.21)	—	R6200

Note: Labels in chart are sorted in order by width, height, 3 or 4 digit material number (within part number), then die number (within part number).

Label Index by Size

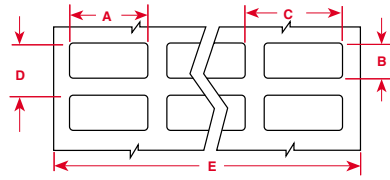

Part Number	Pieces Per Package	Material	Color	Labels Per Row	Label Width Inch (mm) A	Label Height Inch (mm) B	Horizontal Repeat Inch (mm) C	Vertical Repeat Inch (mm) D	Web Width Inch (mm) E	Recommended Ribbon
0.650" Label Width										
THT-14-351-10	10,000	Tamper-Resistant Vinyl	White	4	0.650 (16.51)	0.200 (5.08)	0.700 (17.78)	0.300 (7.62)	2.950 (74.93)	R6202
THT-14-354-10	10,000	Polyester/Paper	White	4	0.650 (16.51)	0.200 (5.08)	0.700 (17.78)	0.300 (7.62)	2.950 (74.93)	R6202
THT-14-423-10	10,000	Polyester	White	4	0.650 (16.51)	0.200 (5.08)	0.700 (17.78)	0.300 (7.62)	2.950 (74.93)	R6002
THT-47-423-10	10,000	Polyester	White	1	0.650 (16.51)	0.200 (5.08)	—	0.300 (7.62)	0.850 (21.59)	R6011
THT-14-426-10	10,000	Polyimide	Amber	4	0.650 (16.51)	0.200 (5.08)	0.700 (17.78)	0.300 (7.62)	2.950 (74.93)	R4300
THT-47-426-10	10,000	Polyimide	Amber	1	0.650 (16.51)	0.200 (5.08)	—	0.300 (7.62)	0.850 (21.59)	R4311
THT-14-436-10	10,000	Removable Polyimide	Amber	4	0.650 (16.51)	0.200 (5.08)	0.700 (17.78)	0.300 (7.62)	2.950 (74.93)	R4311
THT-14-437-10	10,000	Tedlar®	White	4	0.650 (16.51)	0.200 (5.08)	0.700 (17.78)	0.300 (7.62)	2.950 (74.93)	R4311
THT-14-438-10	10,000	Tamper-Evident Polyester	Silver	4	0.650 (16.51)	0.200 (5.08)	0.700 (17.78)	0.300 (7.62)	2.950 (74.93)	R4311
THT-14-457-10	10,000	Polyimide	White	4	0.650 (16.51)	0.200 (5.08)	0.700 (17.78)	0.300 (7.62)	2.950 (74.93)	R6002
THT-47-457-10	10,000	Polyimide	White	1	0.650 (16.51)	0.200 (5.08)	—	0.300 (7.62)	0.850 (21.59)	R6011
THT-14-459-10	10,000	Polyester	White	4	0.650 (16.51)	0.200 (5.08)	0.700 (17.78)	0.300 (7.62)	2.950 (74.93)	R6002
THT-14-473-10	10,000	Polyester	White	4	0.650 (16.51)	0.200 (5.08)	0.700 (17.78)	0.300 (7.62)	2.950 (74.93)	R6002
THT-47-473-10	10,000	Polyester	White	1	0.650 (16.51)	0.200 (5.08)	—	0.300 (7.62)	0.850 (21.59)	R6011
THT-14-477-10	10,000	Polyimide	White	4	0.650 (16.51)	0.200 (5.08)	0.700 (17.78)	0.300 (7.62)	2.950 (74.93)	R6002
THT-47-477-10	10,000	Polyimide	White	1	0.650 (16.51)	0.200 (5.08)	—	0.300 (7.62)	0.850 (21.59)	R6011
THT-14-478-10	10,000	Polyimide	White	4	0.650 (16.51)	0.200 (5.08)	0.700 (17.78)	0.300 (7.62)	2.950 (74.93)	R6002
THT-47-478-10	10,000	Polyimide	White	1	0.650 (16.51)	0.200 (5.08)	—	0.300 (7.62)	0.850 (21.59)	R6011
THT-14-479-10	10,000	Polyimide	White	4	0.650 (16.51)	0.200 (5.08)	0.700 (17.78)	0.300 (7.62)	2.950 (74.93)	R6002
THT-47-479-10	10,000	Polyimide	White	1	0.650 (16.51)	0.200 (5.08)	—	0.300 (7.62)	0.850 (21.59)	R6011
THT-14-487-10	10,000	Polyimide	White	4	0.650 (16.51)	0.200 (5.08)	0.700 (17.78)	0.300 (7.62)	2.950 (74.93)	R6002
THT-47-487-10	10,000	Polyimide	White	1	0.650 (16.51)	0.200 (5.08)	—	0.300 (7.62)	0.850 (21.59)	R6011
THT-14-488-10	10,000	Polyester	White	4	0.650 (16.51)	0.200 (5.08)	0.700 (17.78)	0.300 (7.62)	2.950 (74.93)	R4300
THT-14-495-10	10,000	PEN	White	4	0.650 (16.51)	0.200 (5.08)	0.700 (17.78)	0.300 (7.62)	2.950 (74.93)	R6002
THT-47-495-10	10,000	PEN	White	1	0.650 (16.51)	0.200 (5.08)	—	0.300 (7.62)	0.850 (21.59)	R6011
THT-14-497-10	10,000	Polyimide	White	4	0.650 (16.51)	0.200 (5.08)	0.700 (17.78)	0.300 (7.62)	2.950 (74.93)	R6002
THT-47-497-10	10,000	Polyimide	White	1	0.650 (16.51)	0.200 (5.08)	—	0.300 (7.62)	0.850 (21.59)	R6011
THT-14-498-10	10,000	Vinyl Cloth	White	4	0.650 (16.51)	0.200 (5.08)	0.700 (17.78)	0.300 (7.62)	2.950 (74.93)	R4311
0.700" Label Width										
THT-57-423-10	10,000	Polyester	White	4	0.700 (17.78)	0.375 (9.53)	0.800 (20.32)	0.475 (12.07)	3.350 (85.09)	R6002
THT-57-426-10	10,000	Polyimide	Amber	4	0.700 (17.78)	0.375 (9.53)	0.800 (20.32)	0.475 (12.07)	3.350 (85.09)	R4300
THT-57-473-10	10,000	Polyester	White	4	0.700 (17.78)	0.375 (9.53)	0.800 (20.32)	0.475 (12.07)	3.350 (85.09)	R6002
THT-100-473-10	10,000	Polyester	White	1	0.700 (17.78)	0.375 (9.53)	—	0.475 (12.07)	0.900 (22.86)	R6011
0.750" Label Width										
THT-1-351-10	10,000	Tamper-Resistant Vinyl	White	4	0.750 (19.05)	0.250 (6.35)	0.800 (20.32)	0.350 (8.89)	3.350 (85.09)	R6202
THT-46-354-10	10,000	Polyester/Paper	White	1	0.750 (19.05)	0.250 (6.35)	—	0.350 (8.89)	0.950 (24.13)	R6206
THT-1-423-10	10,000	Polyester	White	4	0.750 (19.05)	0.250 (6.35)	0.800 (20.32)	0.350 (8.89)	3.350 (85.09)	R6002
THT-46-423-10	10,000	Polyester	White	1	0.750 (19.05)	0.250 (6.35)	—	0.350 (8.89)	0.950 (24.13)	R6006
THT-1-426-10	10,000	Polyimide	Amber	4	0.750 (19.05)	0.250 (6.35)	0.800 (20.32)	0.350 (8.89)	3.350 (85.09)	R4300
THT-46-426-10	10,000	Polyimide	Amber	1	0.750 (19.05)	0.250 (6.35)	—	0.350 (8.89)	0.950 (24.13)	R4311
THT-1-428-10	10,000	Metallized Polyester	Silver	4	0.750 (19.05)	0.250 (6.35)	0.800 (20.32)	0.350 (8.89)	3.350 (85.09)	R4300
THT-1-435-10	10,000	Glossy Metallized Polyester	Silver	4	0.750 (19.05)	0.250 (6.35)	0.800 (20.32)	0.350 (8.89)	3.350 (85.09)	R6002
THT-1-436-10	10,000	Removable Polyimide	Amber	4	0.750 (19.05)	0.250 (6.35)	0.800 (20.32)	0.350 (8.89)	3.350 (85.09)	R4300
THT-1-437-10	10,000	Tedlar	White	4	0.750 (19.05)	0.250 (6.35)	0.800 (20.32)	0.350 (8.89)	3.350 (85.09)	R4300
THT-1-438-10	10,000	Tamper-Evident Polyester	Silver	4	0.750 (19.05)	0.250 (6.35)	0.800 (20.32)	0.350 (8.89)	3.350 (85.09)	R4300
THT-1-457-10	10,000	Polyimide	White	4	0.750 (19.05)	0.250 (6.35)	0.800 (20.32)	0.350 (8.89)	3.350 (85.09)	R6002
THT-46-457-10	10,000	Polyimide	White	1	0.750 (19.05)	0.250 (6.35)	—	0.350 (8.89)	0.950 (24.13)	R6006
THT-1-459-10	10,000	Polyester	White	4	0.750 (19.05)	0.250 (6.35)	0.800 (20.32)	0.350 (8.89)	3.350 (85.09)	R6002
THT-1-473-10	10,000	Polyester	White	4	0.750 (19.05)	0.250 (6.35)	0.800 (20.32)	0.350 (8.89)	3.350 (85.09)	R6002
THT-46-473-10	10,000	Polyester	White	1	0.750 (19.05)	0.250 (6.35)	—	0.350 (8.89)	0.950 (24.13)	R6006

Note: Labels in chart are sorted in order by width, height, 3 or 4 digit material number (within part number), then die number (within part number).
 Tedlar® is a registered trademark of DuPont.

LABEL INDEX BY SIZE THERMAL TRANSFER LABELS

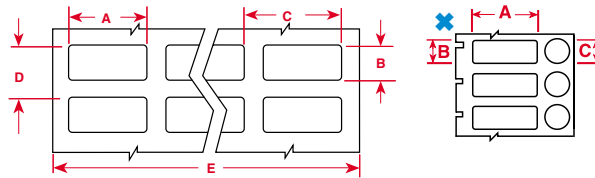

Part Number	Pieces Per Package	Material	Color	Labels Per Row	Label Width Inch (mm) A	Label Height Inch (mm) B	Horizontal Repeat Inch (mm) C	Vertical Repeat Inch (mm) D	Web Width Inch (mm) E	Recommended Ribbon
0.750" Label Width (Cont.)										
THT-1-477-10	10,000	Polyimide	White	4	0.750 (19.05)	0.250 (6.35)	0.800 (20.32)	0.350 (8.89)	3.350 (85.09)	R6002
THT-46-477-10	10,000	Polyimide	White	1	0.750 (19.05)	0.250 (6.35)	—	0.350 (8.89)	0.950 (24.13)	R6006
THT-1-478-10	10,000	Polyimide	White	4	0.750 (19.05)	0.250 (6.35)	0.800 (20.32)	0.350 (8.89)	3.350 (85.09)	R6002
THT-1-498-10	10,000	Vinyl Cloth	White	4	0.750 (19.05)	0.250 (6.35)	0.800 (20.32)	0.350 (8.89)	3.350 (85.09)	R4311
THT-46-478-10	10,000	Polyimide	White	1	0.750 (19.05)	0.250 (6.35)	—	0.350 (8.89)	0.950 (24.13)	R6006
THT-1-479-10	10,000	Polyimide	White	4	0.750 (19.05)	0.250 (6.35)	0.800 (20.32)	0.350 (8.89)	3.350 (85.09)	R6002
THT-46-479-10	10,000	Polyimide	White	1	0.750 (19.05)	0.250 (6.35)	—	0.350 (8.89)	0.950 (24.13)	R6006
THT-1-487-10	10,000	Polyimide	White	4	0.750 (19.05)	0.250 (6.35)	0.800 (20.32)	0.350 (8.89)	3.350 (85.09)	R6002
THT-46-487-10	10,000	Polyimide	White	1	0.750 (19.05)	0.250 (6.35)	—	0.350 (8.89)	0.950 (24.13)	R6006
THT-1-488-10	10,000	Polyester	White	4	0.750 (19.05)	0.250 (6.35)	0.800 (20.32)	0.350 (8.89)	3.350 (85.09)	R4300
THT-1-495-10	10,000	PEN	White	4	0.750 (19.05)	0.250 (6.35)	0.800 (20.32)	0.350 (8.89)	3.350 (85.09)	R6002
THT-46-495-10	10,000	PEN	White	1	0.750 (19.05)	0.250 (6.35)	—	0.350 (8.89)	0.950 (24.13)	R6006
THT-1-497-10	10,000	Polyimide	White	4	0.750 (19.05)	0.250 (6.35)	0.800 (20.32)	0.350 (8.89)	3.350 (85.09)	R6002
THT-46-497-10	10,000	Polyimide	White	1	0.750 (19.05)	0.250 (6.35)	—	0.350 (8.89)	0.950 (24.13)	R6006
XHT-1-8423-10	10,000	Polyester	White	4	0.750 (19.05)	0.250 (6.35)	0.800 (20.32)	0.350 (8.89)	3.350 (85.09)	R6202
THT-50-423-10	10,000	Polyester	White	4	0.750 (19.05)	0.750 (19.05)	0.800 (20.32)	0.875 (22.23)	3.350 (85.09)	R6002
THT-50-426-10	10,000	Polyimide	Amber	4	0.750 (19.05)	0.750 (19.05)	0.800 (20.32)	0.875 (22.23)	3.350 (85.09)	R4300
THT-91-498-5	5,000	Vinyl Cloth	White	4	0.750 (19.05)	0.937 (23.8)	0.875 (22.23)	1.062 (26.98)	3.500 (88.90)	R4300
0.800" Label Width										
THT-95-498-5	5,000	Vinyl Cloth	White	3	0.800 (20.32)	1.437 (36.50)	0.900 (22.86)	1.562 (39.68)	2.800 (71.12)	R4300
THT-69-499-3	3,000	Nylon Cloth	White	2	0.800 (20.32)	1.437 (36.50)	0.900 (22.86)	1.540 (39.12)	1.900 (48.26)	R4902
THT-162-499-10	10,000	Nylon Cloth	White	4	0.800 (20.32)	1.437 (36.50)	0.600 (15.24)	1.562 (39.67)	3.700 (93.98)	R4902
0.900" Label Width										
THT-2-423-10	10,000	Polyester	White	3	0.900 (22.86)	0.250 (6.35)	1.125 (28.58)	0.350 (8.89)	3.350 (85.09)	R6002
THT-49-423-10	10,000	Polyester	White	1	0.900 (22.86)	0.250 (6.35)	—	0.350 (8.89)	1.100 (27.94)	R6006
THT-2-426-10	10,000	Polyimide	Amber	3	0.900 (22.86)	0.250 (6.35)	1.125 (28.58)	0.350 (8.89)	3.350 (85.09)	R4300
THT-49-426-10	10,000	Polyimide	Amber	1	0.900 (22.86)	0.250 (6.35)	—	0.350 (8.89)	1.100 (27.94)	R4311
THT-2-437-10	10,000	Tedlar®	White	3	0.900 (22.86)	0.250 (6.35)	1.125 (28.58)	0.350 (8.89)	3.350 (85.09)	R4300
THT-2-457-10	10,000	Polyimide	White	3	0.900 (22.86)	0.250 (6.35)	1.125 (28.58)	0.350 (8.89)	3.350 (85.09)	R6002
THT-49-457-10	10,000	Polyimide	White	1	0.900 (22.86)	0.250 (6.35)	—	0.350 (8.89)	1.100 (27.94)	R6006
THT-2-473-10	10,000	Polyester	White	3	0.900 (22.86)	0.250 (6.35)	1.125 (28.58)	0.350 (8.89)	3.350 (85.09)	R6002
THT-49-473-10	10,000	Polyester	White	1	0.900 (22.86)	0.250 (6.35)	—	0.350 (8.89)	1.100 (27.94)	R6006
THT-2-478-10	10,000	Polyester	White	3	0.900 (22.86)	0.250 (6.35)	1.125 (28.58)	0.350 (8.89)	3.350 (85.09)	R6002
THT-49-478-10	10,000	Polyester	White	1	0.900 (22.86)	0.250 (6.35)	—	0.350 (8.89)	1.100 (27.94)	R6006
THT-2-479-10	10,000	Polyester	White	3	0.900 (22.86)	0.250 (6.35)	1.125 (28.58)	0.350 (8.89)	3.350 (85.09)	R6002
THT-49-479-10	10,000	Polyester	White	1	0.900 (22.86)	0.250 (6.35)	—	0.350 (8.89)	1.100 (27.94)	R6006
THT-2-488-10	10,000	Polyester	White	3	0.900 (22.86)	0.250 (6.35)	1.125 (28.58)	0.350 (8.89)	3.350 (85.09)	R4300
THT-2-495-10	10,000	PEN	White	3	0.900 (22.86)	0.250 (6.35)	1.125 (28.58)	0.350 (8.89)	3.350 (85.09)	R4300
THT-49-495-10	10,000	PEN	White	3	0.900 (22.86)	0.250 (6.35)	1.125 (28.58)	0.350 (8.89)	3.350 (85.09)	R4300
XHT-2-8423-10	10,000	Polyester	White	3	0.900 (22.86)	0.250 (6.35)	1.125 (28.58)	0.350 (8.89)	3.350 (85.09)	R6202
THT-125-499-3	3,000	Nylon Cloth	White	1	0.900 (22.86)	0.500 (12.70)	—	1.000 (25.40)	1.100 (27.94)	R4306
THT-126-499-3*	3,000	Nylon Cloth	White	2	0.900 (22.86)	0.500 (12.70) dia.	0.500 (12.70)	0.600 (15.24)	1.700 (43.18)	R4302
THT-140-488-3	3,000	Polyester	White	2	0.900 (22.86)	0.750 (19.05)	—	0.875 (22.23)	2.100 (53.34)	R4306
THT-141-488-3	3,000	Polyester	White	2	0.900 (22.86)	0.900 (22.86)	—	1.000 (25.40)	2.100 (53.34)	R4306
THT-164-488-1	1,000	Polyester	White	1	0.900 (22.86)	0.900 (22.86)	—	1.000 (25.40)	1.100 (27.94)	R4306
1.000" Label Width										
THT-42-354-10	10,000	Polyester/Paper	White	1	1.000 (25.40)	0.187 (4.75)	—	0.287 (7.29)	1.200 (30.48)	R6206
THT-41-423-10	10,000	Polyester	White	3	1.000 (25.40)	0.187 (4.75)	1.075 (27.31)	0.287 (7.29)	3.350 (85.09)	R6002
THT-42-423-10	10,000	Polyester	White	1	1.000 (25.40)	0.187 (4.75)	—	0.287 (7.29)	1.200 (30.48)	R6006
THT-41-426-10	10,000	Polyimide	Amber	3	1.000 (25.40)	0.187 (4.75)	1.075 (27.31)	0.287 (7.29)	3.350 (85.09)	R4300
THT-42-426-10	10,000	Polyimide	Amber	1	1.000 (25.40)	0.187 (4.75)	—	0.287 (7.29)	1.200 (30.48)	R4306
THT-42-457-10	10,000	Polyimide	White	1	1.000 (25.40)	0.187 (4.75)	—	0.287 (7.29)	1.200 (30.48)	R6006

Note: Labels in chart are sorted in order by width, height, 3 or 4 digit material number (within part number), then die number (within part number).
 Tedlar® is a registered trademark of DuPont.

Label Index by Size

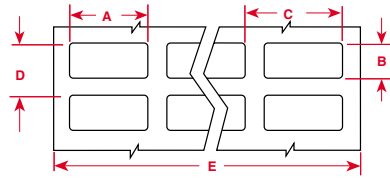

LABEL INDEX BY SIZE THERMAL TRANSFER LABELS

Part Number	Pieces Per Package	Material	Color	Labels Per Row	Label Width Inch (mm) A	Label Height Inch (mm) B	Horizontal Repeat Inch (mm) C	Vertical Repeat Inch (mm) D	Web Width Inch (mm) E	Recommended Ribbon
1.000" Label Width (Cont.)										
THT-42-477-10	10,000	Polyimide	White	1	1.000 (25.40)	0.187 (4.75)	—	0.287 (6.93)	1.200 (30.48)	R6006
THT-42-478-10	10,000	Polyimide	White	1	1.000 (25.40)	0.187 (4.75)	—	0.287 (6.93)	1.200 (30.48)	R6006
THT-42-479-10	10,000	Polyimide	White	1	1.000 (25.40)	0.187 (4.75)	—	0.287 (6.93)	1.200 (30.48)	R6006
THT-42-487-10	10,000	Polyimide	White	1	1.000 (25.40)	0.187 (4.75)	—	0.287 (6.93)	1.200 (30.48)	R6006
THT-42-495-10	10,000	PEN	White	1	1.000 (25.40)	0.187 (4.75)	—	0.287 (6.93)	1.200 (30.48)	R6006
THT-42-497-10	10,000	Polyimide	White	1	1.000 (25.40)	0.187 (4.75)	—	0.287 (6.93)	1.200 (30.48)	R6006
THT-51-423-10	10,000	Polyester	White	3	1.000 (25.40)	0.250 (6.35)	1.075 (27.31)	0.375 (9.53)	3.350 (85.09)	R6002
THT-103-423-10	10,000	Polyester	White	1	1.000 (25.40)	0.250 (6.35)	—	0.350 (8.89)	1.200 (30.48)	R6006
THT-51-426-10	10,000	Polyimide	Amber	3	1.000 (25.40)	0.250 (6.35)	1.075 (27.31)	0.375 (9.53)	3.350 (85.09)	R4300
THT-103-426-10	10,000	Polyimide	Amber	1	1.000 (25.40)	0.250 (6.35)	—	0.350 (8.89)	1.200 (30.48)	R4306
THT-103-457-10	10,000	Polyimide	White	1	1.000 (25.40)	0.250 (6.35)	—	0.350 (8.89)	1.200 (30.48)	R6006
THT-103-473-10	10,000	Polyester	White	1	1.000 (25.40)	0.250 (6.35)	—	0.350 (8.89)	1.200 (30.48)	R6006
THT-103-477-10	10,000	Polyimide	White	1	1.000 (25.40)	0.250 (6.35)	—	0.350 (8.89)	1.200 (30.48)	R6006
THT-103-495-10	10,000	PEN	White	1	1.000 (25.40)	0.250 (6.35)	—	0.350 (8.89)	1.200 (30.48)	R6006
THT-103-478-10	10,000	Polyimide	White	1	1.000 (25.40)	0.250 (6.35)	—	0.350 (8.89)	1.200 (30.48)	R6006
THT-103-479-10	10,000	Polyimide	White	1	1.000 (25.40)	0.250 (6.35)	—	0.350 (8.89)	1.200 (30.48)	R6006
THT-103-487-10	10,000	Polyimide	White	1	1.000 (25.40)	0.250 (6.35)	—	0.350 (8.89)	1.200 (30.48)	R6006
THT-103-497-10	10,000	Polyimide	White	1	1.000 (25.40)	0.250 (6.35)	—	0.350 (8.89)	1.200 (30.48)	R6006
THT-3-422-10	10,000	Polyester	White	3	1.000 (25.40)	0.375 (9.53)	1.075 (27.31)	0.475 (12.07)	3.350 (85.09)	R6002
THT-3-423-10	10,000	Polyester	White	3	1.000 (25.40)	0.375 (9.53)	1.075 (27.31)	0.475 (12.07)	3.350 (85.09)	R6002
THT-3-426-10	10,000	Polyimide	Amber	3	1.000 (25.40)	0.375 (9.53)	1.075 (27.31)	0.475 (12.07)	3.350 (85.09)	R4300
THT-3-428-10	10,000	Metallized Polyester	Silver	3	1.000 (25.40)	0.375 (9.53)	1.075 (27.31)	0.475 (12.07)	3.350 (85.09)	R4300
THT-3-430-10	10,000	Polyester	White	3	1.000 (25.40)	0.375 (9.53)	1.075 (27.31)	0.475 (12.07)	3.350 (85.09)	R6002
THT-58-457-10	10,000	Polyimide	White	1	1.000 (25.40)	0.375 (9.53)	—	0.475 (12.07)	1.200 (30.48)	R6006
THT-3-473-10	10,000	Polyester	White	3	1.000 (25.40)	0.375 (9.53)	1.075 (27.31)	0.475 (12.07)	3.350 (85.09)	R6002
THT-58-473-10	10,000	Polyester	White	1	1.000 (25.40)	0.375 (9.53)	—	0.475 (12.07)	1.200 (30.48)	R6006
THT-3-478-10	10,000	Polyimide	White	3	1.000 (25.40)	0.375 (9.53)	1.075 (27.31)	0.475 (12.07)	3.350 (85.09)	R6002
THT-58-478-10	10,000	Polyimide	White	1	1.000 (25.40)	0.375 (9.53)	—	0.475 (12.07)	1.200 (30.48)	R6006
THT-3-479-10	10,000	Polyimide	White	3	1.000 (25.40)	0.375 (9.53)	1.075 (27.31)	0.475 (12.07)	3.350 (85.09)	R6002
THT-58-479-10	10,000	Polyimide	White	1	1.000 (25.40)	0.375 (9.53)	—	0.475 (12.07)	1.200 (30.48)	R6006
THT-3-495-10	10,000	PEN	White	3	1.000 (25.40)	0.375 (9.53)	1.075 (27.31)	0.475 (12.07)	3.350 (85.09)	R6002
THT-58-495-10	10,000	PEN	White	1	1.000 (25.40)	0.375 (9.53)	—	0.475 (12.07)	1.200 (30.48)	R6006
THT-152-499-3	3,000	Nylon Cloth	White	2	1.000 (25.40)	0.375 (9.53)	1.075 (27.31)	0.475 (12.07)	2.300 (58.42)	R4306
THT-163-499-3	3,000	Nylon Cloth	White	1	1.000 (25.40)	0.375 (9.53) dia.	—	0.875 (22.22)	1.675 (42.55)	R4306
XHT-3-8423-10	10,000	Polyester	White	3	1.000 (25.40)	0.375 (9.53)	1.075 (27.31)	0.475 (12.07)	3.350 (85.09)	R6206
THT-5-351-10	10,000	Tamper-Resistant Vinyl	White	3	1.000 (25.40)	0.500 (12.70)	1.075 (27.31)	0.600 (15.24)	3.350 (85.09)	R6202
THT-59-351-10	10,000	Tamper-Resistant Vinyl	White	1	1.000 (25.40)	0.500 (12.70)	—	0.600 (15.24)	1.200 (30.48)	R6206
THT-5-352-10	10,000	Tamper-Resistant Vinyl	Silver	3	1.000 (25.40)	0.500 (12.70)	1.075 (27.31)	0.600 (15.24)	3.350 (85.09)	R6002
THT-59-352-10	10,000	Tamper-Resistant Vinyl	Silver	1	1.000 (25.40)	0.500 (12.70)	—	0.600 (15.24)	1.200 (30.48)	R6006
THT-59-354-10	10,000	Polyester/Paper	White	1	1.000 (25.40)	0.500 (12.70)	—	0.600 (15.24)	1.200 (30.48)	R6206
THT-39-358-10	10,000	Tamper-Resistant Acetate	Clear	3	1.000 (25.40)	0.500 (12.70)	1.075 (27.31)	0.625 (15.88)	3.350 (85.09)	R6202
THT-59-359-10	10,000	Tamper-Resistant Acetate	White	1	1.000 (25.40)	0.500 (12.70)	—	0.600 (15.24)	1.200 (30.48)	R6206
THT-5-422-10	10,000	Polyester	White	3	1.000 (25.40)	0.500 (12.70)	1.075 (27.31)	0.600 (15.24)	3.350 (85.09)	R6002
THT-5-423-10	10,000	Polyester	White	3	1.000 (25.40)	0.500 (12.70)	1.075 (27.31)	0.600 (15.24)	3.350 (85.09)	R6002
THT-59-423-10	10,000	Polyester	White	1	1.000 (25.40)	0.500 (12.70)	—	0.600 (15.24)	1.200 (30.48)	R6006
THT-5-426-10	10,000	Polyimide	Amber	3	1.000 (25.40)	0.500 (12.70)	1.075 (27.31)	0.600 (15.24)	3.350 (85.09)	R4300
THT-5-428-10	10,000	Metallized Polyester	Silver	3	1.000 (25.40)	0.500 (12.70)	1.075 (27.31)	0.600 (15.24)	3.350 (85.09)	R4300
THT-39-430-10	10,000	Polyester	Clear	3	1.000 (25.40)	0.500 (12.70)	1.075 (27.31)	0.625 (15.88)	3.350 (85.09)	R6002
THT-5-433-10	10,000	Removable Polyester	White	3	1.000 (25.40)	0.500 (12.70)	1.075 (27.31)	0.600 (15.24)	3.350 (85.09)	R6002
THT-5-434-10	10,000	Metallized Polyester	Silver	3	1.000 (25.40)	0.500 (12.70)	1.075 (27.31)	0.600 (15.24)	3.350 (85.09)	R6002
THT-5-435-10	10,000	Glossy Metallized Polyester	Silver	3	1.000 (25.40)	0.500 (12.70)	1.075 (27.31)	0.600 (15.24)	3.350 (85.09)	R6002
THT-5-437-10	10,000	Tedlar®	White	3	1.000 (25.40)	0.500 (12.70)	1.075 (27.31)	0.600 (15.24)	3.350 (85.09)	R4300
THT-5-437-10-YL	10,000	Tedlar	Yellow	3	1.000 (25.40)	0.500 (12.70)	1.075 (27.31)	0.600 (15.24)	3.350 (85.09)	R4300
THT-5-438-10	10,000	Tamper-Evident Polyester	Silver	3	1.000 (25.40)	0.500 (12.70)	1.075 (27.31)	0.600 (15.24)	3.350 (85.09)	R4300

Note: Labels in chart are sorted in order by width, height, 3 or 4 digit material number (within part number), then die number (within part number).

Tedlar® is a registered trademark of DuPont.

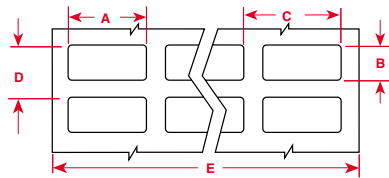

Part Number	Pieces Per Package	Material	Color	Labels Per Row	Label Width Inch (mm) A	Label Height Inch (mm) B	Horizontal Repeat Inch (mm) C	Vertical Repeat Inch (mm) D	Web Width Inch (mm) E	Recommended Ribbon
1.000" Label Width (Cont.)										
THT-59-438-10	10,000	Tamper-Evident Polyester	Silver	1	1.000 (25.40)	0.500 (12.70)	—	0.600 (15.24)	1.200 (30.48)	R4306
THT-5-449-10	10,000	Polypropylene	White	3	1.000 (25.40)	0.500 (12.70)	1.075 (27.31)	0.600 (15.24)	3.350 (85.09)	R6202
THT-59-457-10	10,000	Polyimide	White	1	1.000 (25.40)	0.500 (12.70)	—	0.600 (15.24)	1.200 (30.48)	R6006
THT-5-459-10	10,000	Polyester	White	3	1.000 (25.40)	0.500 (12.70)	1.075 (27.31)	0.600 (15.24)	3.350 (85.09)	R6002
THT-5-473-10	10,000	Polyester	White	3	1.000 (25.40)	0.500 (12.70)	1.075 (27.31)	0.600 (15.24)	3.350 (85.09)	R6002
THT-59-473-10	10,000	Polyester	White	1	1.000 (25.40)	0.500 (12.70)	—	0.600 (15.24)	1.200 (30.48)	R6006
THT-59-477-10	10,000	Polyimide	White	1	1.000 (25.40)	0.500 (12.70)	—	0.600 (15.24)	1.200 (30.48)	R6006
THT-5-478-10	10,000	Polyimide	White	3	1.000 (25.40)	0.500 (12.70)	1.075 (27.31)	0.600 (15.24)	3.350 (85.09)	R6002
THT-59-478-10	10,000	Polyimide	White	1	1.000 (25.40)	0.500 (12.70)	—	0.600 (15.24)	1.200 (30.48)	R6006
THT-5-479-10	10,000	Polyimide	White	3	1.000 (25.40)	0.500 (12.70)	1.075 (27.31)	0.600 (15.24)	3.350 (85.09)	R6002
THT-59-479-10	10,000	Polyimide	White	1	1.000 (25.40)	0.500 (12.70)	—	0.600 (15.24)	1.200 (30.48)	R6006
THT-5-483-10	10,000	Polyester	White	3	1.000 (25.40)	0.500 (12.70)	1.075 (27.31)	0.600 (15.24)	3.350 (85.09)	R6002
THT-59-483-10	10,000	Polyester	White	1	1.000 (25.40)	0.500 (12.70)	—	0.600 (15.24)	1.200 (30.48)	R6006
THT-5-486-10	10,000	Metallized Polyester	Silver	3	1.000 (25.40)	0.500 (12.70)	1.075 (27.31)	0.600 (15.24)	3.350 (85.09)	R4300
THT-59-486-5	5,000	Metallized Polyester	Silver	1	1.000 (25.40)	0.500 (12.70)	—	0.600 (15.24)	1.200 (30.48)	R4306
THT-59-487-10	10,000	Polyimide	White	1	1.000 (25.40)	0.500 (12.70)	—	0.600 (15.24)	1.200 (30.48)	R6006
THT-5-488-10	10,000	Polyester	White	3	1.000 (25.40)	0.500 (12.70)	1.075 (27.31)	0.600 (15.24)	3.350 (85.09)	R4300
THT-5-489-10	10,000	Polyester	White	3	1.000 (25.40)	0.500 (12.70)	1.075 (27.31)	0.600 (15.24)	3.350 (85.09)	R4300
THT-59-489-10	10,000	Polyester	White	1	1.000 (25.40)	0.500 (12.70)	—	0.600 (15.24)	1.200 (30.48)	R4306
THT-5-495-10	10,000	PEN	White	3	1.000 (25.40)	0.500 (12.70)	1.075 (27.31)	0.600 (15.24)	3.350 (85.09)	R6002
THT-59-495-10	10,000	PEN	White	1	1.000 (25.40)	0.500 (12.70)	—	0.600 (15.24)	1.200 (30.48)	R6006
THT-59-497-10	10,000	Polyimide	White	1	1.000 (25.40)	0.500 (12.70)	—	0.600 (15.24)	1.200 (30.48)	R6006
THT-5-498-10	10,000	Vinyl Cloth	White	3	1.000 (25.40)	0.500 (12.70)	1.075 (27.31)	0.600 (15.24)	3.350 (85.09)	R4300
THT-5-7546-10	10,000	Tamper-Evident Polyester	White	3	1.000 (25.40)	0.500 (12.70)	1.075 (27.31)	0.600 (15.24)	3.350 (85.09)	R6006
THT-59-7546-10	10,000	Tamper-Evident Polyester	White	1	1.000 (25.40)	0.500 (12.70)	1.075 (27.31)	0.600 (15.24)	3.350 (85.09)	R6006
THT-39-7566-10	10,000	Tamper-Evident Polyester	Clear	3	1.000 (25.40)	0.500 (12.70)	1.075 (27.31)	0.625 (15.88)	3.350 (85.09)	R6006
THT-5-7576-10	10,000	Tamper-Evident Polyester	Silver	3	1.000 (25.40)	0.500 (12.70)	—	0.600 (15.24)	1.200 (30.48)	R6006
THT-59-7576-10	10,000	Tamper-Evident Polyester	Silver	1	1.000 (25.40)	0.500 (12.70)	—	0.600 (15.24)	1.200 (30.48)	R6006
XTHT-5-8423-10	10,000	Polyester	White	3	1.000 (25.40)	0.500 (12.70)	1.075 (27.31)	0.600 (15.24)	3.350 (85.09)	R6202
XTHT-5-8425-10	10,000	Polyolefin	White	3	1.000 (25.40)	0.500 (12.70)	1.075 (27.31)	0.600 (15.24)	3.350 (85.09)	R6002
THT-88-498-5	5,000	Vinyl Cloth	White	2	1.000 (25.40)	0.750 (19.05)	1.100 (27.94)	0.875 (22.23)	2.300 (58.42)	R4300
THT-117-427-5	5,000	Vinyl	White	2	1.000 (25.40)	1.250 (31.75)	1.100 (27.94)	1.375 (34.93)	2.300 (58.42)	R4300
THT-89-498-5	5,000	Vinyl Cloth	White	3	1.000 (25.40)	1.440 (36.50)	1.100 (27.94)	1.562 (39.68)	3.400 (86.36)	R4300
1.100" Label Width										
THT-31-423-10	10,000	Polyester	White	2	1.100 (27.94)	0.380 (9.65)	1.200 (30.48)	0.500 (12.70)	2.500 (63.50)	R6002
1.181" Label Width										
DSTHT-30-390-2.5	2,500	Polypropylene	White	1	1.181 (30.00)	0.163 (4.14)	—	0.402 (10.21)	—	R6206
DSTHT-30-390-1	1,000	Polypropylene	White	1	1.181 (30.00)	0.163 (4.14)	—	0.402 (10.21)	—	R6206
1.250" Label Width										
THT-43-354-10	10,000	Polyester/Paper	White	1	1.250 (31.75)	0.250 (6.35)	—	0.350 (8.89)	1.450 (36.83)	R6006
THT-13-423-10	10,000	Polyester	White	2	1.250 (31.75)	0.250 (6.35)	1.300 (33.02)	0.375 (9.53)	2.750 (69.85)	R6002
THT-43-423-10	10,000	Polyester	White	1	1.250 (31.75)	0.250 (6.35)	—	0.350 (8.89)	1.450 (36.83)	R6006
THT-13-426-10	10,000	Polyimide	Amber	2	1.250 (31.75)	0.250 (6.35)	1.300 (33.02)	0.375 (9.53)	2.750 (69.85)	R4300
THT-43-426-10	10,000	Polyimide	Amber	1	1.250 (31.75)	0.250 (6.35)	—	0.350 (8.89)	1.450 (36.83)	R4306
THT-13-433-10	10,000	Removable Polyester	White	2	1.250 (31.75)	0.250 (6.35)	1.300 (33.02)	0.375 (9.53)	2.750 (69.85)	R6002
THT-13-449-10	10,000	Polypropylene	White	2	1.250 (31.75)	0.250 (6.35)	1.300 (33.02)	0.375 (9.53)	2.750 (69.85)	R6202
THT-13-457-10	10,000	Polyimide	White	2	1.250 (31.75)	0.250 (6.35)	1.300 (33.02)	0.375 (9.53)	2.750 (69.85)	R6002
THT-43-457-10	10,000	Polyimide	White	1	1.250 (31.75)	0.250 (6.35)	—	0.350 (8.89)	1.450 (36.83)	R6006
THT-13-473-10	10,000	Polyester	White	2	1.250 (31.75)	0.250 (6.35)	1.300 (33.02)	0.375 (9.53)	2.750 (69.85)	R6002
THT-43-473-10	10,000	Polyester	White	1	1.250 (31.75)	0.250 (6.35)	—	0.350 (8.89)	1.450 (36.83)	R6006
THT-43-477-10	10,000	Polyimide	White	1	1.250 (31.75)	0.250 (6.35)	—	0.350 (8.89)	1.450 (36.83)	R6006
THT-43-478-10	10,000	Polyimide	White	1	1.250 (31.75)	0.250 (6.35)	—	0.350 (8.89)	1.450 (36.83)	R6006
THT-43-479-10	10,000	Polyimide	White	1	1.250 (31.75)	0.250 (6.35)	—	0.350 (8.89)	1.450 (36.83)	R6006
THT-43-487-10	10,000	Polyimide	White	1	1.250 (31.75)	0.250 (6.35)	—	0.350 (8.89)	1.450 (36.83)	R6006

Note: Labels in chart are sorted in order by width, height, 3 or 4 digit material number (within part number), then die number (within part number).

Label Index by Size

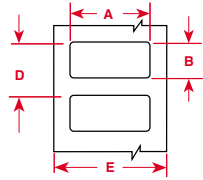

Part Number	Pieces Per Package	Material	Color	Labels Per Row	Label Width Inch (mm) A	Label Height Inch (mm) B	Horizontal Repeat Inch (mm) C	Vertical Repeat Inch (mm) D	Web Width Inch (mm) E	Recommended Ribbon
1.250" Label Width (Cont.)										
THT-43-495-10	10,000	PEN	White	1	1.250 (31.75)	0.250 (6.35)	—	0.350 (8.89)	1.450 (36.83)	R6006
THT-43-497-10	10,000	Polyimide	White	1	1.250 (31.75)	0.250 (6.35)	—	0.350 (8.89)	1.450 (36.83)	R6006
THT-29-423-10	10,000	Polyester	White	2	1.250 (31.75)	0.375 (9.53)	1.300 (33.02)	0.475 (12.07)	2.750 (69.85)	R6002
THT-29-426-10	10,000	Polyimide	Amber	2	1.250 (31.75)	0.375 (9.53)	1.300 (33.02)	0.475 (12.07)	2.750 (69.85)	R4300
THT-29-437-10	10,000	Tedlar®	White	2	1.250 (31.75)	0.375 (9.53)	1.300 (33.02)	0.475 (12.07)	2.750 (69.85)	R4300
THT-29-437-10-YL	10,000	Tedlar	Yellow	2	1.250 (31.75)	0.375 (9.53)	1.300 (33.02)	0.475 (12.07)	2.750 (69.85)	R4300
THT-29-478-10	10,000	Polyester	White	2	1.250 (31.75)	0.375 (9.53)	1.300 (33.02)	0.475 (12.07)	2.750 (69.85)	R6002
THT-29-479-10	10,000	Polyester	White	2	1.250 (31.75)	0.375 (9.53)	1.300 (33.02)	0.475 (12.07)	2.750 (69.85)	R6002
THT-154-490-3	3,000	Polyester	White	1	1.250 (31.75)	0.375 (9.53)	—	0.500 (12.07)	1.450 (36.83)	R4300
THT-29-495-10	10,000	PEN	White	2	1.250 (31.75)	0.375 (9.53)	1.300 (33.02)	0.475 (12.07)	2.750 (69.85)	R6002
1.375" Label Width										
THT-40-423-10	10,000	Polyester	White	2	1.375 (34.93)	0.250 (6.35)	1.475 (37.47)	0.375 (9.53)	3.050 (77.47)	R6002
THT-44-423-10	10,000	Polyester	White	1	1.375 (34.93)	0.250 (6.35)	—	0.350 (8.89)	1.600 (40.64)	R6006
THT-40-426-10	10,000	Polyimide	Amber	2	1.375 (34.93)	0.250 (6.35)	1.475 (37.47)	0.375 (9.53)	3.050 (77.47)	R4300
THT-44-426-10	10,000	Polyimide	Amber	1	1.375 (34.93)	0.250 (6.35)	—	0.350 (8.89)	1.600 (40.64)	R4306
THT-40-457-10	10,000	Polyimide	White	2	1.375 (34.93)	0.250 (6.35)	1.475 (37.47)	0.375 (9.53)	3.050 (77.47)	R6002
THT-44-457-10	10,000	Polyimide	White	1	1.375 (34.93)	0.250 (6.35)	—	0.350 (8.89)	1.600 (40.64)	R6006
THT-40-477-10	10,000	Polyimide	White	2	1.375 (34.93)	0.250 (6.35)	1.475 (37.47)	0.375 (9.53)	3.050 (77.47)	R6002
THT-44-477-10	10,000	Polyimide	White	1	1.375 (34.93)	0.250 (6.35)	—	0.350 (8.89)	1.600 (40.64)	R6006
THT-44-478-10	10,000	Polyimide	White	1	1.375 (34.93)	0.250 (6.35)	—	0.350 (8.89)	1.600 (40.64)	R6006
THT-44-479-10	10,000	Polyimide	White	1	1.375 (34.93)	0.250 (6.35)	—	0.350 (8.89)	1.600 (40.64)	R6006
THT-40-487-10	10,000	Polyimide	White	2	1.375 (34.93)	0.250 (6.35)	1.475 (37.47)	0.375 (9.53)	3.050 (77.47)	R6002
THT-44-487-10	10,000	Polyimide	White	1	1.375 (34.93)	0.250 (6.35)	—	0.350 (8.89)	1.600 (40.64)	R6006
THT-40-497-10	10,000	Polyimide	White	2	1.375 (34.93)	0.250 (6.35)	1.475 (37.47)	0.375 (9.53)	3.050 (77.47)	R6002
THT-44-495-10	10,000	PEN	White	1	1.375 (34.93)	0.250 (6.35)	—	0.350 (8.89)	1.600 (40.64)	R6006
THT-44-497-10	10,000	Polyimide	White	1	1.375 (34.93)	0.250 (6.35)	—	0.350 (8.89)	1.600 (40.64)	R6006
1.500" Label Width										
THT-28-423-10	10,000	Polyester	White	2	1.500 (38.10)	0.125 (3.18)	1.650 (41.91)	0.250 (6.35)	3.350 (85.09)	R6002
THT-28-426-10	10,000	Polyimide	Amber	2	1.500 (38.10)	0.125 (3.18)	1.650 (41.91)	0.250 (6.35)	3.350 (85.09)	R4300
THT-60-457-10	10,000	Polyimide	White	1	1.500 (38.10)	0.125 (3.18)	—	0.225 (5.72)	1.700 (43.18)	R6000
THT-60-477-10	10,000	Polyimide	White	1	1.500 (38.10)	0.125 (3.18)	—	0.225 (5.72)	1.700 (43.18)	R6000
THT-60-478-10	10,000	Polyimide	White	1	1.500 (38.10)	0.125 (3.18)	—	0.225 (5.72)	1.700 (43.18)	R6000
THT-60-479-10	10,000	Polyimide	White	1	1.500 (38.10)	0.125 (3.18)	—	0.225 (5.72)	1.700 (43.18)	R6000
THT-60-487-10	10,000	Polyimide	White	1	1.500 (38.10)	0.125 (3.18)	—	0.225 (5.72)	1.700 (43.18)	R6000
THT-60-495-10	10,000	PEN	White	1	1.500 (38.10)	0.125 (3.18)	—	0.225 (5.72)	1.700 (43.18)	R6000
THT-60-497-10	10,000	Polyimide	White	1	1.500 (38.10)	0.125 (3.18)	—	0.225 (5.72)	1.700 (43.18)	R6000
THT-4-351-10	10,000	Tamper-Resistant Vinyl	White	2	1.500 (38.10)	0.250 (6.35)	1.650 (41.91)	0.350 (8.89)	3.350 (85.09)	R6202
THT-4-423-10	10,000	Polyester	White	2	1.500 (38.10)	0.250 (6.35)	1.650 (41.91)	0.350 (8.89)	3.350 (85.09)	R6002
THT-45-423-10	10,000	Polyester	White	1	1.500 (38.10)	0.250 (6.35)	—	0.350 (8.89)	1.700 (43.18)	R6000
THT-4-426-10	10,000	Polyimide	Amber	2	1.500 (38.10)	0.250 (6.35)	1.650 (41.91)	0.350 (8.89)	3.350 (85.09)	R4300
THT-45-426-10	10,000	Polyimide	Amber	1	1.500 (38.10)	0.250 (6.35)	—	0.350 (8.89)	1.700 (43.18)	R4302
THT-4-457-10	10,000	Polyimide	White	2	1.500 (38.10)	0.250 (6.35)	1.650 (41.91)	0.350 (8.89)	3.350 (85.09)	R6002
THT-45-457-10	10,000	Polyimide	White	1	1.500 (38.10)	0.250 (6.35)	—	0.350 (8.89)	1.700 (43.18)	R6000
THT-4-473-10	10,000	Polyester	White	2	1.500 (38.10)	0.250 (6.35)	1.650 (41.91)	0.350 (8.89)	3.350 (85.09)	R6002
THT-45-473-10	10,000	Polyester	White	1	1.500 (38.10)	0.250 (6.35)	—	0.350 (8.89)	1.700 (43.18)	R6000
THT-45-477-10	10,000	Polyimide	White	1	1.500 (38.10)	0.250 (6.35)	—	0.350 (8.89)	1.700 (43.18)	R6000
THT-4-478-10	10,000	Polyester	White	2	1.500 (38.10)	0.250 (6.35)	1.650 (41.91)	0.350 (8.89)	3.350 (85.09)	R6002
THT-45-478-10	10,000	Polyimide	White	1	1.500 (38.10)	0.250 (6.35)	—	0.350 (8.89)	1.700 (43.18)	R6000
THT-4-479-10	10,000	Polyester	White	2	1.500 (38.10)	0.250 (6.35)	1.650 (41.91)	0.350 (8.89)	3.350 (85.09)	R6002
THT-45-479-10	10,000	Polyimide	White	1	1.500 (38.10)	0.250 (6.35)	—	0.350 (8.89)	1.700 (43.18)	R6000
THT-45-487-10	10,000	Polyimide	White	1	1.500 (38.10)	0.250 (6.35)	—	0.350 (8.89)	1.700 (43.18)	R6000
THT-4-495-10	10,000	PEN	White	2	1.500 (38.10)	0.250 (6.35)	1.650 (41.91)	0.350 (8.89)	3.350 (85.09)	R6002
THT-45-495-10	10,000	PEN	White	1	1.500 (38.10)	0.250 (6.35)	—	0.350 (8.89)	1.700 (43.18)	R6000
THT-45-497-10	10,000	Polyimide	White	1	1.500 (38.10)	0.250 (6.35)	—	0.350 (8.89)	1.700 (43.18)	R6000

Note: Labels in chart are sorted in order by width, height, 3 or 4 digit material number (within part number), then die number (within part number).
 Tedlar® is a registered trademark of DuPont.

LABEL INDEX BY SIZE THERMAL TRANSFER LABELS

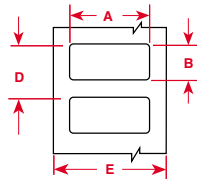

Part Number	Pieces Per Package	Material	Color	Labels Per Row	Label Width Inch (mm) A	Label Height Inch (mm) B	Horizontal Repeat Inch (mm) C	Vertical Repeat Inch (mm) D	Web Width Inch (mm) E	Recommended Ribbon
1.500" Label Width (Cont.)										
XHTT-4-8423-10	10,000	Polyester	White	2	1.500 (38.10)	0.250 (6.35)	1.605 (41.91)	0.350 (8.89)	3.350 (85.09)	R6202
THT-102-422-10	10,000	Polyester	White	1	1.500 (38.10)	0.370 (9.40)	—	0.500 (12.70)	1.700 (43.18)	R6000
THT-147-358-10	10,000	Tamper-Resistant Acetate	Clear	1	1.500 (38.10)	0.375 (9.53)	1.605 (41.91)	0.475 (12.06)	3.350 (85.09)	R6002
THT-147-359-10	10,000	Tamper-Resistant Acetate	White	2	1.500 (38.10)	0.375 (9.53)	1.605 (41.91)	0.475 (12.06)	3.350 (85.09)	R6002
THT-147-422-10	10,000	Polyester	White	2	1.500 (38.10)	0.375 (9.53)	1.605 (41.91)	0.475 (12.06)	3.350 (85.09)	R6002
THT-147-430-10	10,000	Polyester	Clear	2	1.500 (38.10)	0.375 (9.53)	1.605 (41.91)	0.500 (12.70)	3.350 (85.09)	R6002
THT-147-7566-10	10,000	Polyester	Clear	2	1.500 (38.10)	0.375 (9.53)	1.605 (41.91)	0.500 (12.70)	3.350 (85.09)	R6002
THT-37-351-10	10,000	Tamper-Resistant Vinyl	White	2	1.500 (38.10)	0.500 (12.70)	1.650 (41.91)	0.600 (15.24)	3.350 (85.09)	R6202
THT-37-352-10	10,000	Tamper-Resistant Vinyl	Silver	2	1.500 (38.10)	0.500 (12.70)	1.650 (41.91)	0.600 (15.24)	3.350 (85.09)	R6002
THT-37-422-10	10,000	Metallized Polyester	Silver	2	1.500 (38.10)	0.500 (12.70)	1.650 (41.91)	0.600 (15.24)	3.350 (85.09)	R6002
THT-37-423-10	10,000	Polyester	White	2	1.500 (38.10)	0.500 (12.70)	1.650 (41.91)	0.600 (15.24)	3.350 (85.09)	R6002
THT-37-428-10	10,000	Metallized Polyester	Silver	2	1.500 (38.10)	0.500 (12.70)	1.650 (41.91)	0.600 (15.24)	3.350 (85.09)	R4300
THT-37-430-10	10,000	Metallized Polyester	Silver	2	1.500 (38.10)	0.500 (12.70)	1.650 (41.91)	0.600 (15.24)	3.350 (85.09)	R6002
THT-37-434-10	10,000	Metallized Polyester	Silver	2	1.500 (38.10)	0.500 (12.70)	1.650 (41.91)	0.600 (15.24)	3.350 (85.09)	R6002
THT-37-438-10	10,000	Tamper-Evident Polyester	Silver	2	1.500 (38.10)	0.500 (12.70)	1.650 (41.91)	0.600 (15.24)	3.350 (85.09)	R4300
THT-37-483-10	10,000	Polyester	White	2	1.500 (38.10)	0.500 (12.70)	1.650 (41.91)	0.600 (15.24)	3.350 (85.09)	R6002
THT-37-486-10	10,000	Metallized Polyester	Silver	2	1.500 (38.10)	0.500 (12.70)	1.650 (41.91)	0.600 (15.24)	3.350 (85.09)	R4300
THT-37-489-10	10,000	Polyester	White	2	1.500 (38.10)	0.500 (12.70)	1.650 (41.91)	0.600 (15.24)	3.350 (85.09)	R4300
THT-37-7546-10	10,000	Tamper-Evident Polyester	White	2	1.500 (38.10)	0.500 (12.70)	1.650 (41.91)	0.600 (15.24)	3.350 (85.09)	R6002
THT-37-7576-10	10,000	Tamper-Evident Polyester	Silver	2	1.500 (38.10)	0.500 (12.70)	1.650 (41.91)	0.600 (15.24)	3.350 (85.09)	R6002
THT-6-351-10	10,000	Tamper-Resistant Vinyl	White	2	1.500 (38.10)	0.750 (19.05)	1.650 (41.91)	0.875 (22.23)	3.350 (85.09)	R6202
THT-6-352-10	10,000	Tamper-Resistant Vinyl	Silver	2	1.500 (38.10)	0.750 (19.05)	1.650 (41.91)	0.875 (22.23)	3.350 (85.09)	R6002
THT-6-354-10	10,000	Polyester/Paper	White	2	1.500 (38.10)	0.750 (19.05)	1.650 (41.91)	0.875 (22.23)	3.350 (85.09)	R6202
THT-6-423-10	10,000	Polyester	White	2	1.500 (38.10)	0.750 (19.05)	1.650 (41.91)	0.875 (22.23)	3.350 (85.09)	R6002
THT-135-427-AW-3*	3,000	Vinyl	White	1	1.500 (38.10)	0.750 (19.05)	—	0.875 (22.23)	1.700 (43.18)	R4302
THT-6-428-10	10,000	Metallized Polyester	Silver	2	1.500 (38.10)	0.750 (19.05)	1.650 (41.91)	0.875 (22.23)	3.350 (85.09)	R4300
THT-6-434-10	10,000	Metallized Polyester	Silver	2	1.500 (38.10)	0.750 (19.05)	1.650 (41.91)	0.875 (22.23)	3.350 (85.09)	R6002
THT-6-438-10	10,000	Tamper-Evident Polyester	Silver	2	1.500 (38.10)	0.750 (19.05)	1.650 (41.91)	0.875 (22.23)	3.350 (85.09)	R4300
THT-6-486-10	10,000	Metallized Polyester	Silver	2	1.500 (38.10)	0.750 (19.05)	1.650 (41.91)	0.875 (22.23)	3.350 (85.09)	R4300
THT-136-499-3	3,000	Nylon Cloth	White	1	1.500 (38.10)	0.750 (19.05)	—	0.875 (22.23)	1.700 (43.18)	R4302
THT-6-7546-10	10,000	Tamper-Evident Polyester	White	2	1.500 (38.10)	0.750 (19.05)	1.650 (41.91)	0.875 (22.23)	3.350 (85.09)	R6002
THT-6-7576-10	10,000	Tamper-Evident Polyester	Silver	2	1.500 (38.10)	0.750 (19.05)	1.650 (41.91)	0.875 (22.23)	3.350 (85.09)	R6002
THT-105-437	1	Tedlar®	White	1	1.500 (38.10)	300 ft (91.44 m)	—	300 ft (91.44 m)	1.750 (44.45)	R4302
THT-105-437-YL	1	Tedlar	Yellow	1	1.500 (38.10)	300 ft (91.44 m)	—	300 ft (91.44 m)	1.750 (44.45)	R4302
1.625" Label Width										
THT-155-490-3	3,000	Polyester	White	1	1.625 (41.28)	0.600 (15.24)	—	0.700 (17.78)	1.825 (46.36)	R4300
1.750" Label Width										
THT-72-457-10	10,000	Polyimide	White	1	1.750 (44.45)	0.250 (6.35)	—	0.350 (8.89)	1.950 (49.53)	R6000
THT-72-478-10	10,000	Polyimide	White	1	1.750 (44.45)	0.250 (6.35)	—	0.350 (8.89)	1.950 (49.53)	R6000
THT-72-479-10	10,000	Polyimide	White	1	1.750 (44.45)	0.250 (6.35)	—	0.350 (8.89)	1.950 (49.53)	R6000
THT-72-495-10	10,000	PEN	White	1	1.750 (44.45)	0.250 (6.35)	—	0.350 (8.89)	1.950 (49.53)	R6000
THT-72-497-10	10,000	Polyimide	White	1	1.750 (44.45)	0.250 (6.35)	—	0.350 (8.89)	1.950 (49.53)	R6000
1.900" Label Width										
THT-156-490-3	3,000	Polyester	White	1	1.900 (48.26)	1.000 (25.40)	—	1.100 (27.94)	2.100 (53.34)	R4300
1.938" Label Width										
THT-150-412-1	1,000	Polypropylene	White	1	1.938 (49.25)	0.375 (9.53)	—	0.375 (9.53)	2.200 (55.88)	R6200

Note: Labels in chart are sorted in order by width, height, 3 or 4 digit material number (within part number), then die number (within part number).

*The label is all white.

Tedlar® is a registered trademark of DuPont.

Label Index by Size

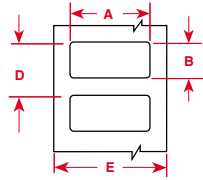

Part Number	Pieces Per Package	Material	Color	Labels Per Row	Label Width Inch (mm) A	Label Height Inch (mm) B	Horizontal Repeat Inch (mm) C	Vertical Repeat Inch (mm) D	Web Width Inch (mm) E	Recommended Ribbon
2.000" Label Width										
THT-15-351-2.5	2,500	Tamper-Resistant Vinyl	White	1	2.000 (50.80)	0.250 (6.35)	—	0.375 (9.53)	2.200 (55.88)	R6200
THT-15-423-2.5	2,500	Polyester	White	1	2.000 (50.80)	0.250 (6.35)	—	0.375 (9.53)	2.200 (55.88)	R6000
THT-48-423-10	10,000	Polyester	White	1	2.000 (50.80)	0.250 (6.35)	—	0.350 (8.89)	2.200 (55.88)	R6000
THT-15-426-2.5	2,500	Polyimide	Amber	1	2.000 (50.80)	0.250 (6.35)	—	0.375 (9.53)	2.200 (55.88)	R4302
THT-48-426-10	10,000	Polyimide	Amber	1	2.000 (50.80)	0.250 (6.35)	—	0.350 (8.89)	2.200 (55.88)	R4302
THT-15-457-2.5	2,500	Polyimide	White	1	2.000 (50.80)	0.250 (6.35)	—	0.375 (9.53)	2.200 (55.88)	R6000
THT-48-457-10	10,000	Polyimide	White	1	2.000 (50.80)	0.250 (6.35)	—	0.350 (8.89)	2.200 (55.88)	R6000
THT-15-473-2.5	2,500	Polyester	White	1	2.000 (50.80)	0.250 (6.35)	—	0.375 (9.53)	2.200 (55.88)	R6000
THT-48-473-10	10,000	Polyester	White	1	2.000 (50.80)	0.250 (6.35)	—	0.350 (8.89)	2.200 (55.88)	R6000
THT-15-477-2.5	2,500	Polyimide	White	1	2.000 (50.80)	0.250 (6.35)	—	0.375 (9.53)	2.200 (55.88)	R6000
THT-48-477-10	10,000	Polyimide	White	1	2.000 (50.80)	0.250 (6.35)	—	0.350 (8.89)	2.200 (55.88)	R6000
THT-48-478-10	10,000	Polyimide	White	1	2.000 (50.80)	0.250 (6.35)	—	0.350 (8.89)	2.200 (55.88)	R6000
THT-48-479-10	10,000	Polyimide	White	1	2.000 (50.80)	0.250 (6.35)	—	0.350 (8.89)	2.200 (55.88)	R6000
THT-15-487-2.5	2,500	Polyimide	White	1	2.000 (50.80)	0.250 (6.35)	—	0.375 (9.53)	2.200 (55.88)	R6000
THT-48-487-10	10,000	Polyimide	White	1	2.000 (50.80)	0.250 (6.35)	—	0.350 (8.89)	2.200 (55.88)	R6000
THT-15-488-2.5	2,500	Polyester	White	1	2.000 (50.80)	0.250 (6.35)	—	0.375 (9.53)	2.200 (55.88)	R4302
THT-48-495-10	10,000	PEN	White	1	2.000 (50.80)	0.250 (6.35)	—	0.350 (8.89)	2.200 (55.88)	R6000
THT-48-497-10	10,000	Polyimide	White	1	2.000 (50.80)	0.250 (6.35)	—	0.350 (8.89)	2.200 (55.88)	R6000
THT-15-497-2.5	2,500	Polyimide	White	1	2.000 (50.80)	0.250 (6.35)	—	0.375 (9.53)	2.200 (55.88)	R6000
THT-151-499-3	3,000	Nylon Cloth	White	1	2.000 (50.80)	0.250 (6.35)	—	0.350 (8.89)	2.200 (55.88)	R4302
THT-79-423-10	10,000	Polyester	White	1	2.000 (50.80)	0.400 (10.16)	—	0.500 (12.70)	2.200 (55.88)	R6000
THT-53-351-3	3,000	Tamper-Resistant Vinyl	White	1	2.000 (50.80)	0.500 (12.70)	—	0.600 (15.24)	2.200 (55.88)	R6200
THT-53-352-3	3,000	Tamper-Resistant Vinyl	Silver	1	2.000 (50.80)	0.500 (12.70)	—	0.600 (15.24)	2.200 (55.88)	R6000
THT-53-423-3	3,000	Polyester	White	1	2.000 (50.80)	0.500 (12.70)	—	0.600 (15.24)	2.200 (55.88)	R6000
THT-53-424-3	3,000	Paper	White	1	2.000 (50.80)	0.500 (12.70)	—	0.600 (15.24)	2.200 (55.88)	R4302
THT-53-428-3	3,000	Metallized Polyester	Silver	1	2.000 (50.80)	0.500 (12.70)	—	0.600 (15.24)	2.200 (55.88)	R4302
THT-53-438-3	3,000	Tamper-Evident Polyester	Silver	1	2.000 (50.80)	0.500 (12.70)	—	0.600 (15.24)	2.200 (55.88)	R4302
THT-53-486-3	3,000	Metallized Polyester	Silver	1	2.000 (50.80)	0.500 (12.70)	—	0.600 (15.24)	2.200 (55.88)	R4302
THT-53-7546-3	3,000	Tamper-Evident Polyester	White	1	2.000 (50.80)	0.500 (12.70)	—	0.600 (15.24)	2.200 (55.88)	R6000
THT-53-7576-3	3,000	Tamper-Evident Polyester	Silver	1	2.000 (50.80)	0.500 (12.70)	—	0.600 (15.24)	2.200 (55.88)	R6000
THT-17-351-3	3,000	Tamper-Resistant Vinyl	White	1	2.000 (50.80)	1.000 (25.40)	—	1.125 (28.58)	2.125 (53.98)	R6200
THT-17-352-3	3,000	Tamper-Resistant Vinyl	Silver	1	2.000 (50.80)	1.000 (25.40)	—	1.125 (28.58)	2.125 (53.98)	R6000
THT-17-354-3	3,000	Polyester/Paper	White	1	2.000 (50.80)	1.000 (25.40)	—	1.125 (28.58)	2.125 (53.98)	R6200
THT-17-358-3	3,000	Tamper-Resistant Acetate	Clear	1	2.000 (50.80)	1.000 (25.40)	—	1.125 (28.58)	2.125 (53.98)	R6200
THT-17-359-3	3,000	Tamper-Resistant Acetate	White	1	2.000 (50.80)	1.000 (25.40)	—	1.125 (28.58)	2.125 (53.98)	R6200
THT-17-7566-3	3,000	Tamper-Evident Polyester	Clear	1	2.000 (50.80)	1.000 (25.40)	—	1.125 (28.58)	2.125 (53.98)	R6200
XHT-17-8425-5	5,000	Polypropylene	White	1	2.000 (50.80)	1.000 (25.40)	—	1.125 (28.58)	2.125 (53.98)	R6000
THT-17-402-5.2	5,200	Paper	White	1	2.000 (50.80)	1.000 (25.40)	—	1.125 (28.58)	2.125 (53.98)	R6100
THT-17-408-3	3,000	Paper	White	1	2.000 (50.80)	1.000 (25.40)	—	1.125 (28.58)	2.200 (55.88)	R6100
THT-17-422-3	3,000	Polyester	White	1	2.000 (50.80)	1.000 (25.40)	—	1.125 (28.58)	2.200 (55.88)	R6000
THT-17-423-3	3,000	Polyester	White	1	2.000 (50.80)	1.000 (25.40)	—	1.125 (28.58)	2.200 (55.88)	R6000
THT-17-424-3	3,000	Paper	White	1	2.000 (50.80)	1.000 (25.40)	—	1.125 (28.58)	2.200 (55.88)	R4302
THT-137-427-AW-3*	3,000	Vinyl	White/ Transparent	1	2.000 (50.80)	1.000 (25.40)	—	1.125 (28.58)	2.200 (55.88)	R4302
THT-17-428-3	3,000	Metallized Polyester	Silver	1	2.000 (50.80)	1.000 (25.40)	—	1.125 (28.58)	2.200 (55.88)	R4302
THT-17-430-3	3,000	Polyester	Clear	1	2.000 (50.80)	1.000 (25.40)	—	1.125 (28.58)	2.200 (55.88)	R6000
THT-17-434-3	3,000	Metallized Polyester	Silver	1	2.000 (50.80)	1.000 (25.40)	—	1.125 (28.58)	2.200 (55.88)	R6000
THT-17-438-3	3,000	Tamper-Evident Polyester	Silver	1	2.000 (50.80)	1.000 (25.40)	—	1.125 (28.58)	2.200 (55.88)	R4302
THT-17-449-3	3,000	Polypropylene	White	1	2.000 (50.80)	1.000 (25.40)	—	1.125 (28.58)	2.200 (55.88)	R6200
THT-17-483-3	3,000	Polyester	White	1	2.000 (50.80)	1.000 (25.40)	—	1.125 (28.58)	2.200 (55.88)	R6000
THT-17-486-3	3,000	Metallized Polyester	Silver	1	2.000 (50.80)	1.000 (25.40)	—	1.125 (28.58)	2.200 (55.88)	R4302
THT-17-488-3	3,000	Polyester	White	1	2.000 (50.80)	1.000 (25.40)	—	1.125 (28.58)	2.200 (55.88)	R4302

Note: Labels in chart are sorted in order by width, height, 3 or 4 digit material number (within part number), then die number (within part number).

LABEL INDEX BY SIZE THERMAL TRANSFER LABELS

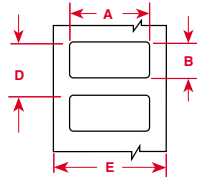

Part Number	Pieces Per Package	Material	Color	Labels Per Row	Label Width Inch (mm) A	Label Height Inch (mm) B	Horizontal Repeat Inch (mm) C	Vertical Repeat Inch (mm) D	Web Width Inch (mm) E	Recommended Ribbon
2.000" Label Width (Cont.)										
THT-17-489-3	3,000	Polyester	White	1	2.000 (50.80)	1.000 (25.40)	—	1.125 (28.58)	2.200 (55.88)	R4302
THT-137-499-3	3,000	Nylon Cloth	White	1	2.000 (50.80)	1.000 (25.40)	—	1.125 (28.58)	2.200 (55.88)	R4302
THT-17-7546-3	3,000	Tamper-Evident Polyester	White	1	2.000 (50.80)	1.000 (25.40)	—	1.125 (28.58)	2.200 (55.88)	R6000
THT-17-7576-3	3,000	Tamper-Evident Polyester	Silver	1	2.000 (50.80)	1.000 (25.40)	—	1.125 (28.58)	2.200 (55.88)	R6000
XHTT-17-8423-5	5,000	Polyester	White	1	2.000 (50.80)	1.000 (25.40)	—	1.125 (28.58)	2.200 (55.58)	R6200
XHTT-17-8425-5	5,000	Polyolefin	White	1	2.000 (50.80)	1.000 (25.40)	—	1.125 (28.58)	2.200 (55.58)	R6000
THT-106-423	1	Polyester	White	1	2.000 (50.80)	300 ft (9144 m)	—	300 ft (9144 m)	2.200 (55.88)	R6000
THT-106-428	1	Metallized Polyester	Silver	1	2.000 (50.80)	300 ft (9144 m)	—	300 ft (9144 m)	2.200 (55.88)	R4302
THT-106-439	1	Colored Vinyl	White	1	2.000 (50.80)	300 ft (9144 m)	—	300 ft (9144 m)	2.200 (55.88)	R6000
THT-106-483	1	Polyester	White	1	2.000 (50.80)	300 ft (9144 m)	—	300 ft (9144 m)	2.200 (55.88)	R6000
THT-106-486	1	Metallized Polyester	White	1	2.000 (50.80)	300 ft (9144 m)	—	300 ft (9144 m)	2.200 (55.88)	R4302
2.200" Label Width										
THT-157-490-3	3,000	Polyester	White	1	2.200 (55.88)	1.500 (38.10)	—	1.625 (42.28)	2.400 (60.96)	R4300
2.500" Label Width										
THT-142-423-2.5	2,500	Polyester	White	1	2.500 (63.50)	0.200 (5.08)	—	0.300 (7.62)	2.700 (68.58)	R6002
2.625" Label Width										
THT-131-461-3	3,000	Vinyl	White/ Transparent	1	2.625 (66.68)	1.000 (25.40)	—	1.125 (28.58)	2.825 (71.76)	R4300
2.750" Label Width										
THT-7-351-10	10,000	Tamper-Resistant Vinyl	White	1	2.750 (69.85)	1.250 (31.75)	—	1.375 (34.93)	2.950 (74.93)	R6202
THT-7-352-10	10,000	Tamper-Resistant Vinyl	Silver	1	2.750 (69.85)	1.250 (31.75)	—	1.375 (34.93)	2.950 (74.93)	R6002
THT-7-358-3	3,000	Tamper-Resistant Acetate	Clear	1	2.750 (69.85)	1.250 (31.75)	—	1.375 (34.93)	2.950 (74.93)	R6202
THT-7-359-3	3,000	Tamper-Resistant Acetate	White	1	2.750 (69.85)	1.250 (31.75)	—	1.375 (34.93)	2.950 (74.93)	R6202
THT-7-422-3	3,000	Polyester	White	1	2.750 (69.85)	1.250 (31.75)	—	1.375 (34.93)	2.950 (74.93)	R6002
THT-7-423-3	3,000	Polyester	White	1	2.750 (69.85)	1.250 (31.75)	—	1.375 (34.93)	2.950 (74.93)	R6002
THT-7-424-3	3,000	Paper	White	1	2.750 (69.85)	1.250 (31.75)	—	1.375 (34.93)	2.950 (74.93)	R4300
THT-7-428-3	3,000	Metallized Polyester	Silver	1	2.750 (69.85)	1.250 (31.75)	—	1.375 (34.93)	2.950 (74.93)	R4300
THT-7-438-3	3,000	Tamper-Evident Polyester	Silver	1	2.750 (69.85)	1.250 (31.75)	—	1.375 (34.93)	2.950 (74.93)	R4300
THT-7-483-3	3,000	Polyester	White	1	2.750 (69.85)	1.250 (31.75)	—	1.375 (34.93)	2.950 (74.93)	R6002
THT-7-486-3	3,000	Metallized Polyester	Silver	1	2.750 (69.85)	1.250 (31.75)	—	1.375 (34.93)	2.950 (74.93)	R4300
THT-7-489-3	3,000	Polyester	White	1	2.750 (69.85)	1.250 (31.75)	—	1.375 (34.93)	2.950 (74.93)	R4300
THT-7-7546-10	10,000	Tamper-Evident Polyester	White	1	2.750 (69.85)	1.250 (31.75)	—	1.375 (34.93)	2.950 (74.93)	R6002
THT-7-7566-3	3,000	Tamper-Evident Polyester	Clear	1	2.750 (69.85)	1.250 (31.75)	—	1.375 (34.93)	2.950 (74.93)	R6002
THT-7-7576-10	10,000	Tamper-Evident Polyester	Silver	1	2.750 (69.85)	1.250 (31.75)	—	1.375 (34.93)	2.950 (74.93)	R6002
XHTT-7-8425-3	3,000	Polypropylene	White	1	2.750 (69.85)	1.250 (31.75)	—	1.375 (34.93)	2.950 (74.93)	R6202
XHTT-7-8425-5	5,000	Polypropylene	White	1	2.750 (69.85)	1.250 (31.75)	—	1.375 (34.93)	2.950 (74.93)	R6202
2.875" Label Width										
THT-159-422-5	5,000	Polyester	White	1	2.875 (13.03)	0.375 (9.53)	—	1.375 (34.93)	2.950 (74.93)	R6202
3.000" Label Width										
THT-16-423-2.5	2,500	Polyester	White	1	3.000 (76.20)	0.250 (6.35)	—	0.375 (9.53)	3.200 (81.28)	R6002
THT-16-426-2.5	2,500	Polyimide	Amber	1	3.000 (76.20)	0.250 (6.35)	—	0.375 (9.53)	3.200 (81.28)	R4300
THT-16-478-2.5	2,500	Polyimide	White	1	3.000 (76.20)	0.250 (6.35)	—	0.375 (9.53)	3.200 (81.28)	R6002
THT-16-479-2.5	2,500	Polyimide	White	1	3.000 (76.20)	0.250 (6.35)	—	0.375 (9.53)	3.200 (81.28)	R6002
THT-16-495-2.5	2,500	PEN	White	1	3.000 (76.20)	0.250 (6.35)	—	0.375 (9.53)	3.200 (81.28)	R6002
THT-16-497-2.5	2,500	Polyimide	White	1	3.000 (76.20)	0.250 (6.35)	—	0.375 (9.53)	3.200 (81.28)	R6002
THT-18-351-3	3,000	Tamper-Resistant Vinyl	White	1	3.000 (76.20)	1.000 (25.40)	—	1.125 (28.58)	3.200 (81.28)	R6202
THT-18-352-3	3,000	Tamper-Resistant Vinyl	Silver	1	3.000 (76.20)	1.000 (25.40)	—	1.125 (28.58)	3.200 (81.28)	R6002
THT-18-358-3	3,000	Tamper-Resistant Acetate	Clear	1	3.000 (76.20)	1.000 (25.40)	—	1.125 (28.58)	3.200 (81.28)	R6202
THT-18-359-3	3,000	Tamper-Resistant Acetate	White	1	3.000 (76.20)	1.000 (25.40)	—	1.125 (28.58)	3.200 (81.28)	R6202
THT-18-402-5.2	5,200	Paper	White	1	3.000 (76.20)	1.000 (25.40)	—	1.125 (28.58)	3.200 (81.28)	R6102
THT-18-407-3	3,000	Polyolefin	Clear	1	3.000 (76.20)	1.000 (25.40)	—	1.125 (28.58)	3.200 (81.28)	R6202

Note: Labels in chart are sorted in order by width, height, 3 or 4 digit material number (within part number), then die number (within part number).

*For use with Hover-Davis vertical format label feeders.

Label Index by Size

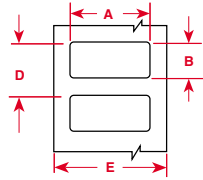

Part Number	Pieces Per Package	Material	Color	Labels Per Row	Label Width Inch (mm) A	Label Height Inch (mm) B	Horizontal Repeat Inch (mm) C	Vertical Repeat Inch (mm) D	Web Width Inch (mm) E	Recommended Ribbon
3.000" Label Width (Cont.)										
THT-18-408-3	3,000	Paper	White	1	3.000 (76.20)	1.000 (25.40)	—	1.125 (28.58)	3.200 (81.28)	R6102
THT-18-422-3	3,000	Polyester	White	1	3.000 (76.20)	1.000 (25.40)	—	1.125 (28.58)	3.200 (81.28)	R6002
THT-18-423-3	3,000	Polyester	White	1	3.000 (76.20)	1.000 (25.40)	—	1.125 (28.58)	3.200 (81.28)	R6002
THT-18-424-3	3,000	Paper	White	1	3.000 (76.20)	1.000 (25.40)	—	1.125 (28.58)	3.200 (81.28)	R4300
THT-18-428-3	3,000	Metallized Polyester	Silver	1	3.000 (76.20)	1.000 (25.40)	—	1.125 (28.58)	3.200 (81.28)	R4300
THT-18-430-3	3,000	Polyester	Clear	1	3.000 (76.20)	1.000 (25.40)	—	1.125 (28.58)	3.200 (81.28)	R6002
THT-18-433-3	3,000	Removable Polyester	White	1	3.000 (76.20)	1.000 (25.40)	—	1.125 (28.58)	3.200 (81.28)	R6002
THT-18-434-3	3,000	Metallized Polyester	Silver	1	3.000 (76.20)	1.000 (25.40)	—	1.125 (28.58)	3.200 (81.28)	R6002
THT-18-435-3	3,000	Glossy Metallized Polyester	Silver	1	3.000 (76.20)	1.000 (25.40)	—	1.125 (28.58)	3.200 (81.28)	R6002
THT-18-438-3	3,000	Tamper-Evident Polyester	Silver	1	3.000 (76.20)	1.000 (25.40)	—	1.125 (28.58)	3.200 (81.28)	R4300
THT-18-449-3	3,000	Polypropylene	White	1	3.000 (76.20)	1.000 (25.40)	—	1.125 (28.58)	3.200 (81.28)	R6202
THT-18-483-3	3,000	Polyester	White	1	3.000 (76.20)	1.000 (25.40)	—	1.125 (28.58)	3.200 (81.28)	R6002
THT-18-486-3	3,000	Metallized Polyester	Silver	1	3.000 (76.20)	1.000 (25.40)	—	1.125 (28.58)	3.200 (81.28)	R4300
THT-18-488-3	3,000	Polyester	White	1	3.000 (76.20)	1.000 (25.40)	—	1.125 (28.58)	3.200 (81.28)	R4300
THT-18-489-3	3,000	Polyester	White	1	3.000 (76.20)	1.000 (25.40)	—	1.125 (28.58)	3.200 (81.28)	R4300
THT-18-7546-3	3,000	Tamper-Evident Polyester	White	1	3.000 (76.20)	1.000 (25.40)	—	1.125 (28.58)	3.200 (81.28)	R6002
THT-18-7566-3	3,000	Tamper-Evident Polyester	Clear	1	3.000 (76.20)	1.000 (25.40)	—	1.125 (28.58)	3.200 (81.28)	R6002
THT-18-7576-3	3,000	Tamper-Evident Polyester	Silver	1	3.000 (76.20)	1.000 (25.40)	—	1.125 (28.58)	3.200 (81.28)	R6002
XHT-18-8423-5	5,000	Polyester	White	1	3.000 (76.20)	1.000 (25.40)	—	1.125 (28.58)	3.200 (81.28)	R6202
XHT-18-8425-5	5,000	Polyolefin	White	1	3.000 (76.20)	1.000 (25.40)	—	1.125 (28.58)	3.200 (81.28)	R6002
THT-19-351-1	1,000	Tamper-Resistant Vinyl	White	1	3.000 (76.20)	2.000 (50.80)	—	2.125 (53.98)	3.200 (81.28)	R6202
THT-19-352-1	1,000	Tamper-Resistant Vinyl	Silver	1	3.000 (76.20)	2.000 (50.80)	—	2.125 (53.98)	3.200 (81.28)	R6002
THT-19-358-1	1,000	Tamper-Resistant Acetate	Clear	1	3.000 (76.20)	2.000 (50.80)	—	2.125 (53.98)	3.200 (81.28)	R6202
THT-19-359-1	1,000	Tamper-Resistant Acetate	White	1	3.000 (76.20)	2.000 (50.80)	—	2.125 (53.98)	3.200 (81.28)	R6202
THT-19-402-3	3,000	Paper	White	1	3.000 (76.20)	2.000 (50.80)	—	2.125 (53.98)	3.200 (81.28)	R6102
THT-19-407-1	1,000	Polyolefin	Clear	1	3.000 (76.20)	2.000 (50.80)	—	2.125 (53.98)	3.200 (81.28)	R6202
THT-19-408-1	1,000	Paper	White	1	3.000 (76.20)	2.000 (50.80)	—	2.125 (53.98)	3.200 (81.28)	R6102
THT-19-422-1	1,000	Polyester	White	1	3.000 (76.20)	2.000 (50.80)	—	2.125 (53.98)	3.200 (81.28)	R6002
THT-19-423-1	1,000	Polyester	White	1	3.000 (76.20)	2.000 (50.80)	—	2.125 (53.98)	3.200 (81.28)	R6002
THT-19-424-1	1,000	Paper	White	1	3.000 (76.20)	2.000 (50.80)	—	2.125 (53.98)	3.200 (81.28)	R4300
THT-19-428-1	1,000	Metallized Polyester	Silver	1	3.000 (76.20)	2.000 (50.80)	—	2.125 (53.98)	3.200 (81.28)	R4300
THT-19-430-1	1,000	Polyester	Clear	1	3.000 (76.20)	2.000 (50.80)	—	2.125 (53.98)	3.200 (81.28)	R6002
THT-19-432-1	1,000	Polyester	Clear	1	3.000 (76.20)	2.000 (50.80)	—	2.125 (53.98)	3.200 (81.28)	R6002
THT-19-433-1	1,000	Removable Polyester	White	1	3.000 (76.20)	2.000 (50.80)	—	2.125 (53.98)	3.200 (81.28)	R6002
THT-19-434-1	1,000	Metallized Polyester	Silver	1	3.000 (76.20)	2.000 (50.80)	—	2.125 (53.98)	3.200 (81.28)	R6002
THT-19-435-1	1,000	Glossy Metallized Polyester	Silver	1	3.000 (76.20)	2.000 (50.80)	—	2.125 (53.98)	3.200 (81.28)	R6002
THT-19-438-1	1,000	Tamper-Evident Polyester	Silver	1	3.000 (76.20)	2.000 (50.80)	—	2.125 (53.98)	3.200 (81.28)	R4300
THT-19-449-1	1,000	Polypropylene	White	1	3.000 (76.20)	2.000 (50.80)	—	2.125 (53.98)	3.200 (81.28)	R6202
THT-19-459-1	1,000	Polyester	White	1	3.000 (76.20)	2.000 (50.80)	—	2.125 (53.98)	3.200 (81.28)	R6002
THT-19-483-1	1,000	Polyester	White	1	3.000 (76.20)	2.000 (50.80)	—	2.125 (53.98)	3.200 (81.28)	R6002
THT-19-486-1	1,000	Metallized Polyester	Silver	1	3.000 (76.20)	2.000 (50.80)	—	2.125 (53.98)	3.200 (81.28)	R4300
THT-19-488-1	1,000	Polyester	White	1	3.000 (76.20)	2.000 (50.80)	—	2.125 (53.98)	3.200 (81.28)	R4300
THT-19-489-1	1,000	Polyester	White	1	3.000 (76.20)	2.000 (50.80)	—	2.125 (53.98)	3.200 (81.28)	R4300
THT-19-7546-1	1,000	Tamper-Evident Polyester	White	1	3.000 (76.20)	2.000 (50.80)	—	2.125 (53.98)	3.200 (81.28)	R6002
THT-19-7576-1	1,000	Tamper-Evident Polyester	Silver	1	3.000 (76.20)	2.000 (50.80)	—	2.125 (53.98)	3.200 (81.28)	R6002
XHT-19-8423-3	3,000	Polyester	White	1	3.000 (76.20)	2.000 (50.80)	—	2.125 (53.98)	3.200 (81.28)	R6202
XHT-19-8425-3	3,000	Polyolefin	White	1	3.000 (76.20)	2.000 (50.80)	—	2.125 (53.98)	3.200 (81.28)	R6002
THT-20-402-11	1,100	Paper	White	1	3.000 (76.20)	5.000 (127.00)	—	5.125 (130.18)	3.200 (81.28)	R6102
THT-20-408-1	1,000	Paper	White	1	3.000 (76.20)	5.000 (127.00)	—	5.125 (130.18)	3.200 (81.28)	R6102
THT-20-424-1	1,000	Paper	White	1	3.000 (76.20)	5.000 (127.00)	—	5.125 (130.18)	3.200 (81.28)	R4300
XHT-20-8425-1	1,000	Polypropylene	White	1	3.000 (76.20)	5.000 (127.00)	—	5.125 (130.18)	3.200 (81.28)	R6202
THT-21-407	1	Polyolefin	Clear	1	3.000 (76.20)	300 ft (91.44 m)	—	300 ft (91.44 m)	3.200 (81.28)	R6202
THT-21-423	1	Polyester	White	1	3.000 (76.20)	300 ft (91.44 m)	—	300 ft (91.44 m)	3.200 (81.28)	R6002
THT-21-424	1	Paper	White	1	3.000 (76.20)	300 ft (91.44 m)	—	300 ft (91.44 m)	3.200 (81.28)	R4300
THT-21-428	1	Metallized Polyester	Silver	1	3.000 (76.20)	300 ft (91.44 m)	—	300 ft (91.44 m)	3.200 (81.28)	R4300
THT-21-430	1	Polyester	Clear	1	3.000 (76.20)	300 ft (91.44 m)	—	300 ft (91.44 m)	3.200 (81.28)	R6002

Note: Labels in chart are sorted in order by width, height, 3 or 4 digit material number (within part number), then die number (within part number).

LABEL INDEX BY SIZE THERMAL TRANSFER LABELS

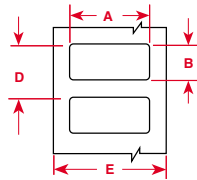

Part Number	Pieces Per Package	Material	Color	Labels Per Row	Label Width Inch (mm) A	Label Height Inch (mm) B	Horizontal Repeat Inch (mm) C	Vertical Repeat Inch (mm) D	Web Width Inch (mm) E	Recommended Ribbon
3.000" Label Width (Cont.)										
THT-21-434	1	Metallized Polyester	Silver	1	3.000 (76.20)	300 ft (91.44 m)	—	300 ft (91.44 m)	3.200 (81.28)	R6002
THT-21-437	1	Tedlar®	White	1	3.000 (76.20)	300 ft (91.44 m)	—	300 ft (91.44 m)	3.200 (81.28)	R4300
THT-21-437-YL	1	Tedlar	Yellow	1	3.000 (76.20)	300 ft (91.44 m)	—	300 ft (91.44 m)	3.200 (81.28)	R4300
THT-21-438	1	Tamper-Evident Polyester	Silver	1	3.000 (76.20)	300 ft (91.44 m)	—	300 ft (91.44 m)	3.200 (81.28)	R4300
THT-21-439	1	Colored Vinyl	White	1	3.000 (76.20)	300 ft (91.44 m)	—	300 ft (91.44 m)	3.200 (81.28)	R6002
THT-21-483	1	Polyester	White	1	3.000 (76.20)	300 ft (91.44 m)	—	300 ft (91.44 m)	3.200 (81.28)	R6002
THT-21-486	1	Metallized Polyester	Silver	1	3.000 (76.20)	300 ft (91.44 m)	—	300 ft (91.44 m)	3.200 (81.28)	R4300
THT-21-489	1	Polyester	White	1	3.000 (76.20)	300 ft (91.44 m)	—	300 ft (91.44 m)	3.200 (81.28)	R4300
3.600" Label Width										
THT-160-422-5	5,000	Polyester	White	1	3.600 (91.44)	0.375 (9.50)	—	0.475 (12.07)	3.800 (96.52)	R6007
3.750" Label Width										
THT-158-490-3	3,000	Polyester	White	1	3.750 (95.25)	1.500 (38.10)	—	1.625 (41.28)	3.950 (100.33)	R4300
4.000" Label Width										
THT-55-402-3	3,000	Paper	White	1	4.000 (101.60)	2.000 (50.80)	—	2.125 (53.98)	4.200 (106.68)	R6107
THT-55-408-1	1,000	Paper	White	1	4.000 (101.60)	2.000 (50.80)	—	2.125 (53.98)	4.200 (106.68)	R6107
THT-55-423-1	1,000	Polyester	White	1	4.000 (101.60)	2.000 (50.80)	—	2.125 (53.98)	4.200 (106.68)	R6007
THT-55-424-1	1,000	Paper	White	1	4.000 (101.60)	2.000 (50.80)	—	2.125 (53.98)	4.200 (106.68)	R4307
THT-55-428-1	1,000	Metallized Polyester	Silver	1	4.000 (101.60)	2.000 (50.80)	—	2.125 (53.98)	4.200 (106.68)	R4307
THT-55-434-1	1,000	Metallized Polyester	Silver	1	4.000 (101.60)	2.000 (50.80)	—	2.125 (53.98)	4.200 (106.68)	R6007
THT-55-435-1	1,000	Glossy Metallized Polyester	Silver	1	4.000 (101.60)	2.000 (50.80)	—	2.125 (53.98)	4.200 (106.68)	R6007
THT-55-449-1	1,000	Polypropylene	White	1	4.000 (101.60)	2.000 (50.80)	—	2.125 (53.98)	4.200 (106.68)	R6207
THT-55-483-1	1,000	Polyester	White	1	4.000 (101.60)	2.000 (50.80)	—	2.125 (53.98)	4.200 (106.68)	R6007
THT-55-488-1	1,000	Polyester	White	1	4.000 (101.60)	2.000 (50.80)	—	2.125 (53.98)	4.200 (106.68)	R4307
THT-55-489-1	1,000	Polyester	White	1	4.000 (101.60)	2.000 (50.80)	—	2.125 (53.98)	4.200 (106.68)	R4307
XTHT-55-8423-3	3,000	Polyester	White	1	4.000 (101.60)	2.000 (50.80)	—	2.125 (53.98)	4.200 (106.68)	R6207
XTHT-55-8425-3	3,000	Polyolefin	White	1	4.000 (101.60)	2.000 (50.80)	—	2.125 (53.98)	4.200 (106.68)	R6007
THT-76-422-1	1,000	Polyester	White	1	4.000 (101.60)	3.000 (76.20)	—	3.125 (79.38)	4.200 (106.68)	R6007
THT-76-449-1	1,000	Polypropylene	White	1	4.000 (101.60)	3.000 (76.20)	—	3.125 (79.38)	4.200 (106.68)	R6207
THT-76-483-1	1,000	Polyester	White	1	4.000 (101.60)	3.000 (76.20)	—	3.125 (79.38)	4.200 (106.68)	R6007
THT-76-489-1	1,000	Polyester	White	1	4.000 (101.60)	3.000 (76.20)	—	3.125 (79.38)	4.200 (106.68)	R4300
XTHT-76-8425-1	1,000	Polypropylene	White	1	4.000 (101.60)	3.000 (76.20)	—	3.125 (79.38)	4.200 (106.68)	R6207
THT-77-402-14	1,400	Paper	White	1	4.000 (101.60)	4.000 (101.60)	—	4.125 (104.78)	4.125 (104.78)	R6107
THT-161-423-1	1,000	Polyester	White	1	4.000 (101.60)	4.000 (101.60)	—	4.125 (104.78)	4.200 (106.68)	R6007
THT-161-483-1	1,000	Polyester	White	1	4.000 (101.60)	4.000 (101.60)	—	4.125 (104.78)	4.200 (106.68)	R6007
THT-161-486-1	1,000	Metallized Polyester	Silver	1	4.000 (101.60)	4.000 (101.60)	—	4.125 (104.78)	4.200 (106.68)	R4307
THT-25-402-1	1,000	Paper	White	1	4.000 (101.60)	6.000 (152.40)	—	6.125 (155.58)	4.200 (106.68)	R6107
THT-25-408-1	1,000	Paper	White	1	4.000 (101.60)	6.000 (152.40)	—	6.125 (155.58)	4.200 (106.68)	R6107
THT-25-424-1	1,000	Paper	White	1	4.000 (101.60)	6.000 (152.40)	—	6.125 (155.58)	4.200 (106.68)	R4307
THT-78-402-0.9	900	Paper	White	1	4.000 (101.60)	6.500 (165.10)	—	6.625 (168.28)	4.125 (104.78)	R6107
THT-78-408-1	1,000	Paper	White	1	4.000 (101.60)	6.500 (165.10)	—	6.625 (168.28)	4.200 (106.68)	R6107
THT-107-423	1	Polyester	White	1	4.000 (101.60)	300 ft (91.44 m)	—	300 ft (91.44 m)	4.200 (106.68)	R6007
THT-107-428	1	Metallized Polyester	Silver	1	4.000 (101.60)	300 ft (91.44 m)	—	300 ft (91.44 m)	4.200 (106.68)	R4307
THT-107-439	1	Colored Vinyl	White	1	4.000 (101.60)	300 ft (91.44 m)	—	300 ft (91.44 m)	4.200 (106.68)	R6007
THT-107-483	1	Polyester	White	1	4.000 (101.60)	300 ft (91.44 m)	—	300 ft (91.44 m)	4.200 (106.68)	R6007
THT-107-486	1	Metallized Polyester	Silver	1	4.000 (101.60)	300 ft (91.44 m)	—	300 ft (91.44 m)	4.200 (106.68)	R4307

Note: Labels in chart are sorted in order by width, height, 3 or 4 digit material number (within part number), then die number (within part number).

Tedlar® is a registered trademark of DuPont.

PermaShield™ Markers by Size

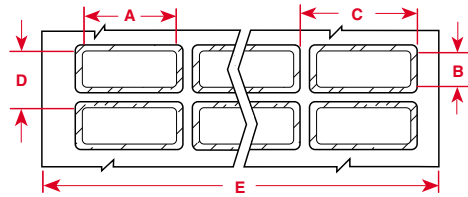

Clear polyester (B-966) overlaminate extends 0.125" outside of label on each side.

Part Number	Pieces Per Package	Material	Color	Labels Per Row	Label Width Inch (mm) A	Label Height Inch (mm) B	Horizontal Repeat Inch (mm) C	Vertical Repeat Inch (mm) D	Web Width Inch (mm) E	Recommended Ribbon
1.250" Label Width										
THT-22-423-2	2,000	Polyester	White	2	1.250 (31.75)	0.750 (19.05)	1.650 (41.91)	1.125 (28.58)	3.350 (85.09)	R6002
THT-22-428-2	2,000	Metallized Polyester	Silver	2	1.250 (31.75)	0.750 (19.05)	1.650 (41.91)	1.125 (28.58)	3.350 (85.09)	R4300
2.000" Label Width										
THT-23-423-2	2,000	Polyester	White	1	2.000 (50.80)	1.000 (25.40)	NA	1.375 (34.93)	2.450 (62.23)	R6000
THT-23-428-2	2,000	Metallized Polyester	Silver	1	2.000 (50.80)	1.000 (25.40)	NA	1.375 (34.93)	2.450 (62.23)	R4302
2.750" Label Width										
THT-24-423-1	1,000	Polyester	White	1	2.750 (69.85)	1.750 (44.45)	NA	2.125 (53.98)	3.200 (81.28)	R6002
THT-24-428-1	1,000	Metallized Polyester	Silver	1	2.750 (69.85)	1.750 (44.45)	NA	2.125 (53.98)	3.200 (81.28)	R4300

Note: Labels in chart are sorted in order by width, height, 3 or 4 digit material number (within part number), then die number (within part number).

* This product is sold in Japan under the Overlaminated Labels name and not under the PermaShield name.

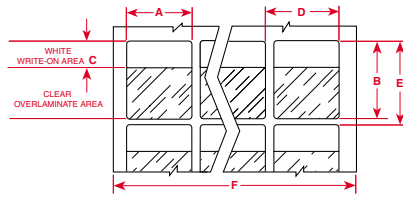

Part Number	Pieces Per Pkg.	Material	Color	Labels Per Row	Label Width Inch (mm) A	Label Height Inch (mm) B	Write-On Height Inch (mm) C	Horizontal Repeat Inch (mm) D	Vertical Repeat Inch (mm) E	Web Width Inch (mm) F	Recommended Ribbon
0.500" Label Width											
THT-80-427-5	5,000	Vinyl	White/Transparent	4	0.500 (12.70)	0.750 (19.05)	0.375 (9.53)	0.600 (15.24)	0.950 (24.13)	2.500 (63.50)	R4302
THT-113-427-5	5,000	Vinyl	White/Transparent	4	0.500 (12.70)	1.000 (25.90)	0.375 (9.53)	0.600 (15.24)	1.125 (28.58)	2.500 (63.50)	R4302
THT-114-427-5	5,000	Vinyl	White/Transparent	4	0.500 (12.70)	1.250 (31.75)	0.500 (12.70)	0.600 (15.24)	1.375 (34.93)	2.500 (63.50)	R4302
THT-8-427-10	10,000	Vinyl	White/Transparent	5	0.500 (12.70)	1.437 (36.50)	0.500 (12.70)	0.662 (16.81)	1.625 (41.28)	3.350 (85.09)	R4300
0.750" Label Width											
THT-56-427-10	10,000	Vinyl	White/Transparent	4	0.750 (19.05)	0.938 (23.81)	0.375 (9.52)	0.800 (20.32)	1.125 (28.58)	3.350 (85.09)	R4300
THT-73-427-10	10,000	Vinyl	White/Transparent	4	0.750 (19.05)	1.750 (44.45)	0.500 (12.70)	0.800 (20.32)	1.875 (47.63)	3.350 (85.09)	R4300
0.800" Label Width											
THT-74-427-10	10,000	Vinyl	White/Transparent	4	0.800 (20.32)	1.437 (36.50)	0.500 (12.70)	0.800 (20.32)	1.625 (41.28)	3.350 (85.09)	R4300
1.000" Label Width											
THT-115-427-5	5,000	Vinyl	White/Transparent	2	1.000 (25.40)	0.750 (19.05)	0.375 (9.53)	1.100 (27.94)	0.875 (22.23)	2.300 (58.42)	R4302
THT-116-427-5	5,000	Vinyl	White/Transparent	2	1.000 (25.40)	1.000 (25.40)	0.375 (9.53)	1.100 (27.94)	1.125 (28.58)	2.300 (58.42)	R4302
THT-9-427-10	10,000	Vinyl	White/Transparent	3	1.000 (25.40)	1.437 (36.50)	0.500 (12.70)	1.075 (27.30)	1.625 (41.28)	3.350 (85.09)	R4300
THT-75-427-3	3,000	Vinyl	White/Transparent	2	1.000 (25.40)	2.250 (57.15)	0.750 (19.05)	1.100 (27.94)	2.375 (60.33)	2.300 (58.42)	R4302
THT-10-427-3	3,000	Vinyl	White/Transparent	3	1.000 (25.40)	3.750 (95.25)	1.000 (25.40)	1.075 (27.30)	4.000 (101.60)	3.350 (85.09)	R4300
THT-139-461-2	2,000	Polyester	White/Transparent	1	1.000 (25.40)	5.250 (133.35)	1.500 (38.10)	N/A	5.325 (135.26)	1.200 (30.48)	R4306
THT-81-427-1	1,000	Vinyl	White/Transparent	2	1.000 (25.40)	6.000 (152.40)	1.500 (38.10)	1.100 (27.94)	6.187 (157.15)	2.200 (55.88)	R4302
1.500" Label Width											
THT-118-427-5	5,000	Vinyl	White/Transparent	1	1.500 (38.10)	1.000 (25.40)	0.375 (9.53)	N/A	1.125 (28.58)	1.700 (43.18)	R4302
THT-119-427-2.5	2,500	Vinyl	White/Transparent	1	1.500 (38.10)	1.500 (38.10)	0.500 (12.70)	N/A	1.625 (41.28)	1.700 (43.18)	R4302
1.750" Label Width											
THT-120-427-5	5,000	Vinyl	White/Transparent	1	1.750 (44.45)	1.000 (25.40)	0.375 (9.53)	N/A	1.125 (28.58)	1.950 (49.53)	R4302
THT-121-427-2.5	2,500	Vinyl	White/Transparent	1	1.750 (44.45)	1.500 (38.10)	0.500 (12.70)	N/A	1.625 (41.28)	1.950 (49.53)	R4302
2.000" Label Width											
THT-27-427-1	1,000	Vinyl	White/Transparent	1	2.000 (50.80)	3.750 (95.25)	1.000 (25.40)	N/A	4.000 (101.60)	2.200 (55.88)	R4302
THT-82-427-5	5,000	Vinyl	White/Transparent	1	2.000 (50.80)	6.000 (152.40)	1.500 (38.10)	N/A	6.250 (158.75)	2.200 (55.88)	R4302
THT-83-427-5	5,000	Vinyl	White/Transparent	1	2.000 (50.80)	7.000 (177.80)	1.500 (38.10)	N/A	7.187 (182.55)	2.200 (55.88)	R4302
2.500" Label Width											
THT-26-427-1	1,000	Vinyl	White/Transparent	1	2.500 (63.50)	2.250 (57.15)	0.750 (19.05)	N/A	2.438 (61.93)	2.700 (68.58)	R4300

Perforations exist between each row of self-laminating labels for easy tear off and fan folding.

Note: Labels in chart are sorted in order by width, height, 3 digit material number (within part number), then die number (within part number).

Self-Laminating Labels by Size

One-Across Rotated

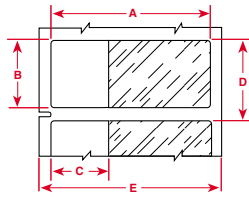

Part Number	Pieces Per Package	Material	Color	Labels Per Row	Label Width Inch (mm) A	Label Height Inch (mm) B	Write-On Height Inch (mm) C	Vertical Repeat Inch (mm) D	Web Width Inch (mm) E	Recommended Ribbon
0.500" Label Width										
THT-61-427-5	5,000	Vinyl	White/Transparent	1	0.500 (12.70)	1.437 (36.50)	0.500 (12.70)	0.687 (17.45)	1.637 (41.58)	R4306
0.750" Label Width										
THT-62-427-3.5	3,500	Vinyl	White/Transparent	1	0.750 (19.05)	1.750 (44.45)	0.500 (12.70)	0.937 (23.80)	1.950 (49.53)	R4302
0.800" Label Width										
THT-63-427-3.5	3,500	Vinyl	White/Transparent	1	0.800 (20.32)	1.437 (36.50)	0.500 (12.70)	0.987 (25.07)	1.637 (41.58)	R4306
1.000" Label Width										
THT-64-427-3	3,000	Vinyl	White/Transparent	1	1.000 (25.40)	2.250 (57.15)	0.750 (19.05)	1.187 (30.15)	2.450 (62.23)	R4302
THT-65-427-3	3,000	Vinyl	White/Transparent	1	1.000 (25.40)	3.750 (95.25)	1.000 (25.40)	1.187 (30.15)	3.950 (100.33)	R4307
THT-84-427-3	3,000	Vinyl	White/Transparent	1	1.000 (25.40)	6.000 (152.40)	1.500 (38.10)	1.20 (30.48)	6.200 (157.48)	R4308
1.625" Label Width										
THT-133-461-3	3,000	Polyester	White/Transparent	1	1.625 (41.28)	0.600 (15.24)	1.000 (25.40)	0.700 (17.78)	1.825 (46.35)	R4302
1.800" Label Width										
THT-123-461-3	3,000	Polyester	White/Transparent	1	1.800 (45.72)	0.375 (9.53)	0.750 (19.05)	0.475 (12.07)	2.000 (50.80)	R4302
THT-122-461-3	3,000	Polyester	White/Transparent	1	1.800 (45.72)	0.500 (12.70)	0.750 (19.05)	0.625 (15.88)	2.000 (50.80)	R4302
1.900" Label Width										
THT-66-427-1.5	1,500	Vinyl	White/Transparent	1	1.900 (48.26)	3.187 (80.95)	0.750 (19.05)	2.150 (54.61)	3.387 (86.03)	R4300
2.000" Label Width										
THT-67-427-1.5	1,500	Vinyl	White/Transparent	1	2.000 (50.80)	2.250 (57.15)	0.750 (19.05)	2.187 (55.55)	2.450 (62.23)	R4302
THT-85-427-2	2,000	Vinyl	White/Transparent	1	2.000 (50.80)	6.000 (152.40)	1.500 (38.10)	2.200 (55.88)	6.200 (157.48)	R4308
THT-86-427-2	2,000	Vinyl	White/Transparent	1	2.000 (50.80)	7.000 (177.80)	1.500 (38.10)	2.200 (55.88)	7.200 (182.88)	R4308
2.200" Label Width										
THT-127-427-3	3,000	Vinyl	White/Transparent	1	2.200 (55.88)	0.500 (12.70)	0.750 (19.05)	0.625 (15.88)	2.400 (60.96)	R4302
THT-127-461-3	3,000	Polyester	White/Transparent	1	2.200 (55.88)	0.500 (12.70)	0.750 (19.05)	0.625 (15.88)	2.400 (60.96)	R4302
2.625" Label Width										
THT-153-461-3	3,000	Polyester	White/Transparent	1	2.625 (66.68)	0.600 (15.24)	1.000 (25.40)	0.750 (19.05)	2.825 (71.76)	R4300
THT-131-427-3	3,000	Vinyl	White/Transparent	1	2.625 (66.68)	1.000 (25.40)	1.000 (25.40)	1.125 (28.58)	2.825 (71.76)	R4300
3.500" Label Width										
THT-134-461-3	3,000	Polyester	White/Transparent	1	3.500 (88.90)	1.500 (38.10)	1.250 (31.75)	1.625 (41.28)	3.700 (93.98)	R4307

Perforations exist between each row of self-laminating labels for easy tear off and fan folding.

Note: Labels in chart are sorted in order by width, height, 3 digit material number (within part number), then die number (within part number).

Tags by Size

One-Across

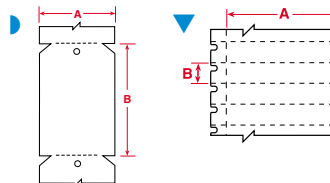

Diagram	Pieces Part Number	Per Package	Material	Color	Tag Width Inch (mm) A	Tag Height Inch (mm) B	Recommended Ribbon
1.938" Label Width							
▼	THT-150-412-1	1,000	Polyethylene Tag	White	1.938 (49.20)	0.375 (9.53)	R6200
3.000" Label Width							
▶	THT-33-109-0.5	500	Polyethylene Tag	White	3.000 (76.20)	6.000 (152.40)	R4300
▶	THT-33-411-1	2 rolls of 500	Polyolefin Tag	White	3.000 (76.20)	6.000 (152.40)	R4300
▶	THT-33-412-1	2 rolls of 500	Polypropylene Tag	White	3.000 (76.20)	6.000 (152.40)	R6202

Note: Labels in chart are sorted in order by width, height, 3 digit material number (within part number), then die number (within part number).

Circuit Board and Component Identification Labels



Brady polyimide materials are specially engineered to resist the harsh environments associated with the processing of printed circuit boards, including the high temperatures associated with lead-free processing. The B-473, B-477, B-478 and B-479 materials can also help reduce ESD by utilizing a static dissipative adhesive and liner.

THERMAL TRANSFER PRINTABLE PRODUCTS CIRCUIT BOARD PROCESS CHART

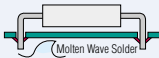
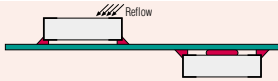
	 Through Hole Technology Top Bottom		 Surface Mount Technology (SMT) Top or Bottom		After Process
B-426, B-436, B-457, B-477, B-478, B-479, B-487, B-497	● Yes	● Yes	● Yes		● Yes
B-495	● Yes	✘ No	● Yes		● Yes
B-422, B-423, B-428, B-433, B-435, B-438, B-459, B-473, B-488, B-498	▲ Yes*	✘ No	✘ No		● Yes

* In extreme high temperatures, testing of these materials is recommended.

► POLYIMIDES

High-Temperature White Polyimides (B-457, B-487, B-497)
Static Dissipative Polyimide (B-477, B-478, B-479)
High-Temperature Amber Polyimide (B-426)
Removable Amber Polyimide (B-436)

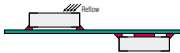
Part Number	Size Inch (mm)	Specifications on Page	 Through Hole Technology Top / Bottom	 SMT Top / Bottom	After Process
THT-1-426	0.750 x 0.250 (19.05 x 6.35)	88	●	●	●
THT-1-436	0.750 x 0.250 (19.05 x 6.35)	88	●	●	●
THT-1-457	0.750 x 0.250 (19.05 x 6.35)	88	●	●	●
THT-1-477	0.750 x 0.250 (19.05 x 6.35)	88	●	●	●
THT-1-478	0.750 x 0.250 (19.05 x 6.35)	89	●	●	●
THT-1-479	0.750 x 0.250 (19.05 x 6.35)	89	●	●	●
THT-1-487	0.750 x 0.250 (19.05 x 6.35)	89	●	●	●
THT-1-497	0.750 x 0.250 (19.05 x 6.35)	89	●	●	●
THT-2-426	0.900 x 0.250 (22.86 x 6.35)	89	●	●	●
THT-2-457	0.900 x 0.250 (22.86 x 6.35)	89	●	●	●
THT-2-478	0.900 x 0.250 (22.86 x 6.35)	89	●	●	●
THT-2-479	0.900 x 0.250 (22.86 x 6.35)	89	●	●	●
THT-3-426	1.000 x 0.375 (25.40 x 9.53)	90	●	●	●
THT-3-478	1.000 x 0.375 (25.40 x 9.53)	90	●	●	●
THT-3-479	1.000 x 0.375 (25.40 x 9.53)	90	●	●	●
THT-4-426	1.500 x 0.250 (38.10 x 6.35)	90	●	●	●
THT-4-457	1.500 x 0.250 (38.10 x 6.35)	90	●	●	●
THT-4-478	1.500 x 0.250 (38.10 x 6.35)	90	●	●	●
THT-4-479	1.500 x 0.250 (38.10 x 6.35)	90	●	●	●
THT-5-426	1.000 x 0.500 (25.40 x 12.70)	90	●	●	●
THT-5-478	1.000 x 0.500 (25.40 x 12.70)	91	●	●	●
THT-5-479	1.000 x 0.500 (25.40 x 12.70)	91	●	●	●
THT-11-426	0.250 x 0.250 (6.35 x 6.35)	85	●	●	●
THT-11-436	0.250 x 0.250 (6.35 x 6.35)	85	●	●	●
THT-11-457	0.250 x 0.250 (6.35 x 6.35)	85	●	●	●

● Yes, this material will work with this application.

✘ No, this material does not work with this application.

▲ In extreme high temperatures, testing of these materials is recommended.

Circuit Board and Component Identification Labels

► POLYIMIDES CONTINUED

High-Temperature White Polyimides (B-457, B-487, B-497)
Static Dissipative Polyimide (B-477, B-478, B-479)
High-Temperature Amber Polyimide (B-426)
Removable Amber Polyimide (B-436)

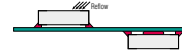
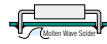

Part Number	Size Inch (mm)	Specifications on Page	Through Hole Technology Top / Bottom	SMT Top / Bottom	After Process
THT-12-426	0.500 x 0.437 (12.70 x 11.10)	87	●	●	●
THT-12-457	0.500 x 0.437 (12.70 x 11.10)	87	●	●	●
THT-12-477	0.500 x 0.437 (12.70 x 11.10)	87	●	●	●
THT-12-478	0.500 x 0.437 (12.70 x 11.10)	87	●	●	●
THT-12-479	0.500 x 0.437 (12.70 x 11.10)	87	●	●	●
THT-12-487	0.500 x 0.437 (12.70 x 11.10)	87	●	●	●
THT-12-497	0.500 x 0.437 (12.70 x 11.10)	87	●	●	●
THT-13-426	1.250 x 0.250 (31.75 x 6.35)	91	●	●	●
THT-13-457	1.250 x 0.250 (31.75 x 6.35)	91	●	●	●
THT-14-426	0.650 x 0.200 (16.51 x 5.08)	88	●	●	●
THT-14-436	0.650 x 0.200 (16.51 x 5.08)	88	●	●	●
THT-14-457	0.650 x 0.200 (16.51 x 5.08)	88	●	●	●
THT-14-477	0.650 x 0.200 (16.51 x 5.08)	88	●	●	●
THT-14-478	0.650 x 0.200 (16.51 x 5.08)	88	●	●	●
THT-14-479	0.650 x 0.200 (16.51 x 5.08)	88	●	●	●
THT-14-487	0.650 x 0.200 (16.51 x 5.08)	88	●	●	●
THT-14-497	0.650 x 0.200 (16.51 x 5.08)	88	●	●	●
THT-15-426	2.000 x 0.250 (50.80 x 6.35)	94	●	●	●
THT-15-457	2.000 x 0.250 (50.80 x 6.35)	94	●	●	●
THT-15-477	2.000 x 0.250 (50.80 x 6.35)	94	●	●	●
THT-15-487	2.000 x 0.250 (50.80 x 6.35)	94	●	●	●
THT-15-497	2.000 x 0.250 (50.80 x 6.35)	94	●	●	●
THT-16-426	3.000 x 0.250 (76.20 x 6.35)	95	●	●	●
THT-16-478	3.000 x 0.250 (76.20 x 6.35)	95	●	●	●
THT-16-479	3.000 x 0.250 (76.20 x 6.35)	95	●	●	●
THT-16-497	3.000 x 0.250 (76.20 x 6.35)	95	●	●	●
THT-28-426	1.500 x 0.125 (38.10 x 3.18)	92	●	●	●
THT-29-426	1.250 x 0.375 (31.75 x 9.53)	92	●	●	●
THT-29-478	1.250 x 0.375 (31.75 x 9.53)	92	●	●	●
THT-29-479	1.250 x 0.375 (31.75 x 9.53)	92	●	●	●
THT-38-426	0.375 x 0.375 (9.53 x 9.53)	86	●	●	●
THT-38-457	0.375 x 0.375 (9.53 x 9.53)	86	●	●	●
THT-38-477	0.375 x 0.375 (9.53 x 9.53)	86	●	●	●
THT-38-478	0.375 x 0.375 (9.53 x 9.53)	86	●	●	●
THT-38-479	0.375 x 0.375 (9.53 x 9.53)	86	●	●	●
THT-38-487	0.375 x 0.375 (9.53 x 9.53)	86	●	●	●
THT-38-497	0.375 x 0.375 (9.53 x 9.53)	86	●	●	●
THT-40-426	1.375 x 0.250 (34.93 x 6.35)	92	●	●	●
THT-40-457	1.375 x 0.250 (34.93 x 6.35)	92	●	●	●
THT-40-477	1.375 x 0.250 (34.93 x 6.35)	92	●	●	●
THT-40-487	1.375 x 0.250 (34.93 x 6.35)	92	●	●	●
THT-40-497	1.375 x 0.250 (34.93 x 6.35)	92	●	●	●
THT-41-426	1.000 x 0.187 (25.40 x 4.75)	89	●	●	●
THT-42-426	1.000 x 0.187 (25.40 x 4.75)	89	●	●	●
THTHD-42-426*	0.187 x 1.000 (4.75 x 25.40)	85	●	●	●
THT-42-457	1.000 x 0.187 (25.40 x 4.75)	89	●	●	●
THTHD-42-457*	0.187 x 1.000 (4.75 x 25.40)	85	●	●	●
THT-42-477	1.000 x 0.187 (25.40 x 4.75)	90	●	●	●
THTHD-42-477*	0.187 x 1.000 (4.75 x 25.40)	85	●	●	●
THT-42-478	1.000 x 0.187 (25.40 x 4.75)	90	●	●	●
THTHD-42-478*	0.187 x 1.000 (4.75 x 25.40)	85	●	●	●
THT-42-479	1.000 x 0.187 (25.40 x 4.75)	90	●	●	●
THT-42-487	1.000 x 0.187 (25.40 x 4.75)	90	●	●	●
THTHD-42-487*	0.187 x 1.000 (4.75 x 25.40)	85	●	●	●
THT-42-497	1.000 x 0.187 (25.40 x 4.75)	90	●	●	●
THT-43-426	1.250 x 0.250 (31.75 x 6.35)	91	●	●	●

* For use with Hover-Davis vertical format label feeders.

- Yes, this material will work with this application.
- ✘ No, this material does not work with this application.
- ▲ In extreme high temperatures, testing of these materials is recommended.

CIRCUIT BOARD AND COMPONENT IDENTIFICATION LABELS THERMAL TRANSFER LABELS

► POLYIMIDES CONTINUED

High-Temperature White Polyimides (B-457, B-487, B-497)
 Static Dissipative Polyimide (B-477, B-478, B-479)
 High-Temperature Amber Polyimide (B-426)
 Removable Amber Polyimide (B-436)

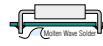

Part Number	Size Inch (mm)	Specifications on Page	Through Hole Technology Top / Bottom	SMT Top / Bottom	After Process
THTHD-43-426*	0.250 x 1.250 (6.35 x 31.75)	86	●	●	●
THT-43-457	1.250 x 0.250 (31.75 x 6.35)	91	●	●	●
THTHD-43-457*	0.250 x 1.250 (6.35 x 31.75)	86	●	●	●
THT-43-477	1.250 x 0.250 (31.75 x 6.35)	91	●	●	●
THTHD-43-477*	0.250 x 1.250 (6.35 x 31.75)	86	●	●	●
THT-43-478	1.250 x 0.250 (31.75 x 6.35)	91	●	●	●
THTHD-43-478*	0.250 x 1.250 (6.35 x 31.75)	86	●	●	●
THT-43-479	1.250 x 0.250 (31.75 x 6.35)	91	●	●	●
THT-43-487	1.250 x 0.250 (31.75 x 6.35)	91	●	●	●
THTHD-43-487*	0.250 x 1.250 (6.35 x 31.75)	86	●	●	●
THT-43-497	1.250 x 0.250 (31.75 x 6.35)	92	●	●	●
THT-44-426	1.375 x 0.250 (34.93 x 6.35)	92	●	●	●
THTHD-44-426*	0.250 x 1.375 (6.35 x 34.93)	86	●	●	●
THT-44-457	1.375 x 0.250 (34.93 x 6.35)	92	●	●	●
THTHD-44-457*	0.250 x 1.375 (6.35 x 34.93)	86	●	●	●
THT-44-477	1.375 x 0.250 (34.93 x 6.35)	92	●	●	●
THTHD-44-477*	0.250 x 1.375 (6.35 x 34.93)	86	●	●	●
THT-44-478	1.375 x 0.250 (34.93 x 6.35)	92	●	●	●
THTHD-44-478*	0.250 x 1.375 (6.35 x 34.93)	86	●	●	●
THT-44-479	1.375 x 0.250 (34.93 x 6.35)	92	●	●	●
THT-44-487	1.375 x 0.250 (34.93 x 6.35)	92	●	●	●
THTHD-44-487*	0.250 x 1.375 (6.35 x 34.93)	86	●	●	●
THT-44-497	1.375 x 0.250 (34.93 x 6.35)	92	●	●	●
THT-45-426	1.500 x 0.250 (38.10 x 6.35)	92	●	●	●
THTHD-45-426*	0.250 x 1.500 (6.35 x 38.10)	86	●	●	●
THT-45-457	1.500 x 0.250 (38.10 x 6.35)	92	●	●	●
THTHD-45-457*	0.250 x 1.500 (6.35 x 38.10)	86	●	●	●
THT-45-477	1.500 x 0.250 (38.10 x 6.35)	92	●	●	●
THTHD-45-477*	0.250 x 1.500 (6.35 x 38.10)	86	●	●	●
THT-45-478	1.500 x 0.250 (38.10 x 6.35)	92	●	●	●
THTHD-45-478*	0.250 x 1.500 (6.35 x 38.10)	86	●	●	●
THT-45-479	1.500 x 0.250 (38.10 x 6.35)	92	●	●	●
THT-45-487	1.500 x 0.250 (38.10 x 6.35)	92	●	●	●
THTHD-45-487*	0.250 x 1.500 (6.35 x 38.10)	86	●	●	●
THT-45-497	1.500 x 0.250 (38.10 x 6.35)	92	●	●	●
THT-46-426	0.750 x 0.250 (19.05 x 6.35)	88	●	●	●
THTHD-46-426*	0.250 x 0.750 (6.35 x 19.05)	85	●	●	●
THT-46-457	0.750 x 0.250 (19.05 x 6.35)	88	●	●	●
THTHD-46-457*	0.250 x 0.750 (6.35 x 19.05)	85	●	●	●
THT-46-477	0.750 x 0.250 (19.05 x 6.35)	89	●	●	●
THTHD-46-477*	0.250 x 0.750 (6.35 x 19.05)	85	●	●	●
THT-46-478	0.750 x 0.250 (19.05 x 6.35)	89	●	●	●
THTHD-46-478*	0.250 x 0.750 (6.35 x 19.05)	85	●	●	●
THT-46-479	0.750 x 0.250 (19.05 x 6.35)	89	●	●	●
THT-46-487	0.750 x 0.250 (19.05 x 6.35)	89	●	●	●
THTHD-46-487*	0.250 x 0.750 (6.35 x 19.05)	85	●	●	●
THT-46-497	0.750 x 0.250 (19.05 x 6.35)	89	●	●	●
THT-47-426	0.650 x 0.200 (16.51 x 5.08)	88	●	●	●
THTHD-47-426*	0.200 x 0.650 (5.08 x 16.51)	85	●	●	●
THT-47-457	0.650 x 0.200 (16.51 x 5.08)	88	●	●	●
THTHD-47-457*	0.200 x 0.650 (5.08 x 16.51)	85	●	●	●
THT-47-477	0.650 x 0.200 (16.51 x 5.08)	88	●	●	●
THTHD-47-477*	0.200 x 0.650 (5.08 x 16.51)	85	●	●	●
THT-47-478	0.650 x 0.200 (16.51 x 5.08)	88	●	●	●
THTHD-47-478*	0.200 x 0.650 (5.08 x 16.51)	85	●	●	●

* For use with Hover-Davis vertical format label feeders.

- Yes, this material will work with this application.
- ✘ No, this material does not work with this application.
- ▲ In extreme high temperatures, testing of these materials is recommended.

Circuit Board and Component Identification Labels

► POLYIMIDES CONTINUED

High-Temperature White Polyimides (B-457, B-487, B-497)
Static Dissipative Polyimide (B-477, B-478, B-479)
High-Temperature Amber Polyimide (B-426)
Removable Amber Polyimide (B-436)

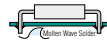

Part Number	Size Inch (mm)	Specifications on Page	Through Hole Technology Top / Bottom	SMT Top / Bottom	After Process
THT-47-479	0.650 x 0.200 (16.51 x 5.08)	88	●	●	●
THT-47-487	0.650 x 0.200 (16.51 x 5.08)	88	●	●	●
THTHD-47-487*	0.200 x 0.650 (5.08 x 16.51)	85	●	●	●
THT-47-497	0.650 x 0.200 (16.51 x 5.08)	88	●	●	●
THT-48-426	2.000 x 0.250 (50.80 x 6.35)	94	●	●	●
THT-48-457	2.000 x 0.250 (50.80 x 6.35)	94	●	●	●
THT-48-477	2.000 x 0.250 (50.80 x 6.35)	94	●	●	●
THT-48-478	2.000 x 0.250 (50.80 x 6.35)	94	●	●	●
THT-48-479	2.000 x 0.250 (50.80 x 6.35)	94	●	●	●
THT-48-487	2.000 x 0.250 (50.80 x 6.35)	94	●	●	●
THT-48-497	2.000 x 0.250 (50.80 x 6.35)	94	●	●	●
THT-49-426	0.900 x 0.250 (22.86 x 6.35)	89	●	●	●
THTHD-49-426*	0.250 x 0.900 (6.35 x 22.86)	85	●	●	●
THT-49-457	0.900 x 0.250 (22.86 x 6.35)	89	●	●	●
THTHD-49-457*	0.250 x 0.900 (6.35 x 22.86)	86	●	●	●
THTHD-49-477*	0.250 x 0.900 (6.35 x 22.86)	86	●	●	●
THT-49-478	0.900 x 0.250 (22.86 x 6.35)	89	●	●	●
THTHD-49-478*	0.250 x 0.900 (6.35 x 22.86)	86	●	●	●
THT-49-479	0.900 x 0.250 (22.86 x 6.35)	89	●	●	●
THTHD-49-487*	0.250 x 0.900 (6.35 x 22.86)	86	●	●	●
THT-50-426	0.750 x 0.750 (19.05 x 19.05)	89	●	●	●
THT-51-426	1.000 x 0.250 (25.40 x 6.35)	90	●	●	●
THT-57-426	0.700 x 0.375 (17.78 x 9.53)	88	●	●	●
THT-58-457	1.000 x 0.375 (25.40 x 9.53)	90	●	●	●
THT-58-478	1.000 x 0.375 (25.40 x 9.53)	90	●	●	●
THT-58-479	1.000 x 0.375 (25.40 x 9.53)	90	●	●	●
THT-59-457	1.000 x 0.500 (25.40 x 12.70)	91	●	●	●
THT-59-477	1.000 x 0.500 (25.40 x 12.70)	91	●	●	●
THT-59-478	1.000 x 0.500 (25.40 x 12.70)	91	●	●	●
THT-59-479	1.000 x 0.500 (25.40 x 12.70)	91	●	●	●
THT-59-487	1.000 x 0.500 (25.40 x 12.70)	91	●	●	●
THT-59-497	1.000 x 0.500 (25.40 x 12.70)	91	●	●	●
THT-60-457	1.500 x 0.125 (38.10 x 3.18)	92	●	●	●
THT-60-477	1.500 x 0.125 (38.10 x 3.18)	92	●	●	●
THT-60-478	1.500 x 0.125 (38.10 x 3.18)	92	●	●	●
THT-60-479	1.500 x 0.125 (38.10 x 3.18)	92	●	●	●
THT-60-487	1.500 x 0.125 (38.10 x 3.18)	92	●	●	●
THT-60-497	1.500 x 0.125 (38.10 x 3.18)	92	●	●	●
THTHD-70-426*	0.250 x 0.250 (6.35 x 6.35)	85	●	●	●
THT-70-457	0.250 x 0.250 (6.35 x 6.35)	85	●	●	●
THTHD-70-457*	0.250 x 0.250 (6.35 x 6.35)	85	●	●	●
THT-70-477	0.250 x 0.250 (6.35 x 6.35)	85	●	●	●
THTHD-70-477*	0.250 x 0.250 (6.35 x 6.35)	85	●	●	●
THT-70-478	0.250 x 0.250 (6.35 x 6.35)	85	●	●	●
THTHD-70-478*	0.250 x 0.250 (6.35 x 6.35)	85	●	●	●
THT-70-479	0.250 x 0.250 (6.35 x 6.35)	85	●	●	●
THT-70-487	0.250 x 0.250 (6.35 x 6.35)	85	●	●	●
THTHD-70-487*	0.250 x 0.250 (6.35 x 6.35)	85	●	●	●
THT-70-497	0.250 x 0.250 (6.35 x 6.35)	85	●	●	●
THT-71-457	0.315 x 0.315 (8.00 x 8.00)	86	●	●	●
THT-71-478	0.315 x 0.315 (8.00 x 8.00)	86	●	●	●
THT-71-479	0.315 x 0.315 (8.00 x 8.00)	86	●	●	●
THT-72-457	1.750 x 0.250 (44.45 x 6.35)	93	●	●	●
THT-72-478	1.750 x 0.250 (44.45 x 6.35)	93	●	●	●

* For use with Hover-Davis vertical format label feeders.

- Yes, this material will work with this application.
- ✘ No, this material does not work with this application.
- ▲ In extreme high temperatures, testing of these materials is recommended.

CIRCUIT BOARD AND COMPONENT IDENTIFICATION LABELS THERMAL TRANSFER LABELS

Circuit Board and Component Identification Labels

► POLYIMIDES CONTINUED

High-Temperature White Polyimides (B-457, B-487, B-497)
 Static Dissipative Polyimide (B-477, B-478, B-479)
 High-Temperature Amber Polyimide (B-426)
 Removable Amber Polyimide (B-436)

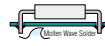

Part Number	Size Inch (mm)	Specifications on Page	Through Hole Technology Top / Bottom	SMT Top / Bottom	After Process
THT-72-479	1.750 x 0.250 (44.45 x 6.35)	93	●	●	●
THT-72-497	1.750 x 0.250 (44.45 x 6.35)	93	●	●	●
THT-96-477	0.500 x 0.275 (12.70 x 7.00)	87	●	●	●
THT-96-487	0.500 x 0.275 (12.70 x 7.00)	87	●	●	●
THT-96-497	0.500 x 0.275 (12.70 x 7.00)	87	●	●	●
THT-97-457	0.500 x 0.200 (12.70 x 5.08)	87	●	●	●
THT-97-477	0.500 x 0.200 (12.70 x 5.08)	87	●	●	●
THT-97-478	0.500 x 0.200 (12.70 x 5.08)	87	●	●	●
THT-97-479	0.500 x 0.200 (12.70 x 5.08)	87	●	●	●
THT-97-487	0.500 x 0.200 (12.70 x 5.08)	87	●	●	●
THT-97-497	0.500 x 0.200 (12.70 x 5.08)	87	●	●	●
THT-99-477	0.500 x 0.500 (12.70 x 12.70)	87	●	●	●
THT-99-478	0.500 x 0.500 (12.70 x 12.70)	87	●	●	●
THT-99-479	0.500 x 0.500 (12.70 x 12.70)	87	●	●	●
THT-99-487	0.500 x 0.500 (12.70 x 12.70)	87	●	●	●
THT-99-497	0.500 x 0.500 (12.70 x 12.70)	87	●	●	●
THT-103-426	1.000 x 0.250 (25.40 x 6.35)	90	●	●	●
THTHD-103-426*	0.250 x 1.000 (6.35 x 25.40)	86	●	●	●
THT-103-457	1.000 x 0.250 (25.40 x 6.35)	90	●	●	●
THTHD-103-457*	0.250 x 1.000 (6.35 x 25.40)	86	●	●	●
THT-103-477	1.000 x 0.250 (25.40 x 6.35)	90	●	●	●
THTHD-103-477*	0.250 x 1.000 (6.35 x 25.40)	86	●	●	●
THT-103-478	1.000 x 0.250 (25.40 x 6.35)	90	●	●	●
THTHD-103-478*	0.250 x 1.000 (6.35 x 25.40)	86	●	●	●
THT-103-479	1.000 x 0.250 (25.40 x 6.35)	90	●	●	●
THT-103-487	1.000 x 0.250 (25.40 x 6.35)	90	●	●	●
THTHD-103-487*	0.250 x 1.000 (6.35 x 25.40)	86	●	●	●
THT-103-497	1.000 x 0.250 (25.40 x 6.35)	90	●	●	●
THT-104-497	0.315 x 0.177 (8.00 x 4.50)	86	●	●	●
THTHD-108-426*	0.150 x 1.500 (3.81 x 38.10)	86	●	●	●
THTHD-108-457*	0.150 x 1.500 (3.81 x 38.10)	86	●	●	●
THTHD-108-477*	0.150 x 1.500 (3.81 x 38.10)	86	●	●	●
THTHD-108-478*	0.150 x 1.500 (3.81 x 38.10)	86	●	●	●
THTHD-108-487*	0.150 x 1.500 (3.81 x 38.10)	86	●	●	●

* For use with Hover-Davis vertical format label feeders.

- Yes, this material will work with this application.
- ✘ No, this material does not work with this application.
- ▲ In extreme high temperatures, testing of these materials is recommended.

Circuit Board and Component Identification Labels

► POLYETHYLENE NAPHTHALATE (PEN)

High Temperature White PEN (B-495)

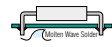

Part Number	Size Inch (mm)	Specifications on Page	Through Hole Technology		SMT Top / Bottom	After Process
			Top	Bottom		
THT-1-495	0.750 x 0.250 (19.05 x 6.35)	89	●	✘	●	●
THT-2-495	0.900 x 0.250 (22.86 x 6.35)	89	●	✘	●	●
THT-3-495	1.000 x 0.375 (25.40 x 9.53)	90	●	✘	●	●
THT-4-495	1.500 x 0.250 (38.10 x 6.35)	90	●	✘	●	●
THT-5-495	1.000 x 0.500 (25.40 x 12.70)	91	●	✘	●	●
THT-12-495	0.500 x 0.437 (12.70 x 11.10)	87	●	✘	●	●
THT-14-495	0.650 x 0.200 (16.51 x 5.08)	88	●	✘	●	●
THT-16-495	3.000 x 0.250 (76.20 x 6.35)	95	●	✘	●	●
THT-29-495	1.250 x 0.375 (31.75 x 9.53)	92	●	✘	●	●
THT-38-495	0.375 x 0.375 (9.53 x 9.53)	86	●	✘	●	●
THT-42-495	1.000 x 0.187 (25.40 x 4.75)	90	●	✘	●	●
THTHD-42-495*	0.187 x 1.000 (4.75 x 25.40)	85	●	✘	●	●
THT-43-495	1.250 x 0.250 (31.75 x 6.35)	92	●	✘	●	●
THTHD-43-495*	0.250 x 1.250 (6.35 x 31.75)	86	●	✘	●	●
THT-44-495	1.375 x 0.250 (35.05 x 6.35)	92	●	✘	●	●
THTHD-44-495*	0.250 x 1.375 (6.35 x 35.05)	86	●	✘	●	●
THT-45-495	1.500 x 0.250 (38.10 x 6.35)	92	●	✘	●	●
THTHD-45-495*	0.250 x 1.500 (6.35 x 38.10)	86	●	✘	●	●
THT-46-495	0.750 x 0.250 (19.05 x 6.35)	89	●	✘	●	●
THTHD-46-495*	0.250 x 0.750 (6.35 x 19.05)	85	●	✘	●	●
THT-47-495	0.650 x 0.200 (16.51 x 5.08)	88	●	✘	●	●
THTHD-47-495*	0.200 x 0.650 (5.08 x 16.51)	85	●	✘	●	●
THT-48-495	2.000 x 0.250 (50.80 x 6.35)	94	●	✘	●	●
THT-49-495	0.900 x 0.250 (22.86 x 6.35)	89	●	✘	●	●
THTHD-49-495*	0.250 x 0.900 (6.35 x 22.86)	86	●	✘	●	●
THT-58-495	1.000 x 0.375 (25.40 x 9.53)	90	●	✘	●	●
THT-59-495	1.000 x 0.500 (25.40 x 12.70)	91	●	✘	●	●
THT-60-495	1.500 x 0.125 (38.10 x 3.18)	92	●	✘	●	●
THT-70-495	0.250 x 0.250 (6.35 x 6.35)	85	●	✘	●	●
THTHD-70-495*	0.250 x 0.250 (6.35 x 6.35)	85	●	✘	●	●
THT-71-495	0.315 x 0.315 (8.00 x 8.00)	86	●	✘	●	●
THT-72-495	1.750 x 0.250 (44.45 x 6.35)	93	●	✘	●	●
THT-97-495	0.500 x 0.200 (12.70 x 5.08)	87	●	✘	●	●
THT-99-495	0.500 x 0.500 (12.70 x 12.70)	87	●	✘	●	●
THT-103-495	1.000 x 0.250 (25.40 x 6.35)	90	●	✘	●	●
THTHD-103-495*	0.250 x 1.000 (6.35 x 25.40)	86	●	✘	●	●
THTHD-108-495*	0.150 x 1.500 (3.81 x 38.10)	86s	●	✘	●	●

* For use with Hover-Davis vertical format label feeders.

- Yes, this material will work with this application.
- ✘ No, this material does not work with this application.
- ▲ In extreme high temperatures, testing of these materials is recommended.

CIRCUIT BOARD AND COMPONENT IDENTIFICATION LABELS THERMAL TRANSFER LABELS

Circuit Board and Component Identification Labels

► POLYESTERS

Permanent White Polyesters (B-422, B-423, B-459, B-488)
 Static Dissipative Polyester (B-473)
 Removable Polyester (B-433)

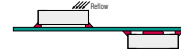
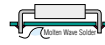

Part Number	Size Inch (mm)	Specifications on Page	Through Hole Technology		SMT Top / Bottom	After Process
			Top	Bottom		
THT-1-423	0.750 x 0.250 (19.05 x 6.35)	88	▲	✘	✘	●
THT-1-459	0.750 x 0.250 (19.05 x 6.35)	88	▲	✘	✘	●
THT-1-473	0.750 x 0.250 (19.05 x 6.35)	88	▲	✘	✘	●
THT-1-488	0.750 x 0.250 (19.05 x 6.35)	89	▲	✘	✘	●
THT-2-423	0.900 x 0.250 (22.86 x 6.35)	89	▲	✘	✘	●
THT-2-473	0.900 x 0.250 (22.86 x 6.35)	89	▲	✘	✘	●
THT-2-488	0.900 x 0.250 (22.86 x 6.35)	89	▲	✘	✘	●
THT-3-423	1.000 x 0.375 (25.40 x 9.53)	90	▲	✘	✘	●
THT-3-473	1.000 x 0.375 (25.40 x 9.53)	90	▲	✘	✘	●
THT-4-423	1.500 x 0.250 (38.10 x 6.35)	90	▲	✘	✘	●
THT-4-473	1.500 x 0.250 (38.10 x 6.35)	90	▲	✘	✘	●
THT-5-423	1.000 x 0.500 (25.40 x 12.70)	90	▲	✘	✘	●
THT-5-433	1.000 x 0.500 (25.40 x 12.70)	90	▲	✘	✘	●
THT-5-459	1.000 x 0.500 (25.40 x 12.70)	91	▲	✘	✘	●
THT-5-473	1.000 x 0.500 (25.40 x 12.70)	91	▲	✘	✘	●
THT-11-423	0.250 x 0.250 (6.35 x 6.35)	85	▲	✘	✘	●
THT-11-473	0.250 x 0.250 (6.35 x 6.35)	85	▲	✘	✘	●
THT-12-423	0.500 x 0.437 (12.70 x 11.10)	87	▲	✘	✘	●
THT-12-433	0.500 x 0.437 (12.70 x 11.10)	87	▲	✘	✘	●
THT-12-473	0.500 x 0.437 (12.70 x 11.10)	87	▲	✘	✘	●
THT-13-423	1.250 x 0.250 (31.75 x 6.35)	91	▲	✘	✘	●
THT-13-433	1.250 x 0.250 (31.75 x 6.35)	91	▲	✘	✘	●
THT-13-473	1.250 x 0.250 (31.75 x 6.35)	91	▲	✘	✘	●
THT-14-423	0.650 x 0.200 (16.51 x 5.08)	88	▲	✘	✘	●
THT-14-459	0.650 x 0.200 (16.51 x 5.08)	88	▲	✘	✘	●
THT-14-473	0.650 x 0.200 (16.51 x 5.08)	88	▲	✘	✘	●
THT-14-488	0.650 x 0.200 (16.51 x 5.08)	88	▲	✘	✘	●
THT-15-423	2.000 x 0.250 (50.80 x 6.35)	94	▲	✘	✘	●
THT-15-473	2.000 x 0.250 (50.80 x 6.35)	94	▲	✘	✘	●
THT-15-488	2.000 x 0.250 (50.80 x 6.35)	94	▲	✘	✘	●
THT-16-423	3.000 x 0.250 (76.20 x 6.35)	95	▲	✘	✘	●
THT-28-423	1.500 x 0.125 (38.10 x 3.18)	92	▲	✘	✘	●
THT-29-423	1.250 x 0.375 (31.75 x 9.53)	92	▲	✘	✘	●
THT-36-422	0.500 x 0.200 (12.70 x 5.08)	87	▲	✘	✘	●
THT-36-423	0.500 x 0.200 (12.70 x 5.08)	87	▲	✘	✘	●
THT-36-473	0.500 x 0.200 (12.70 x 5.08)	87	▲	✘	✘	●
THT-38-423	0.375 x 0.375 (9.53 x 9.53)	86	▲	✘	✘	●
THT-38-473	0.375 x 0.375 (9.53 x 9.53)	86	▲	✘	✘	●
THT-40-423	1.375 x 0.250 (34.93 x 6.35)	92	▲	✘	✘	●
THT-41-423	1.000 x 0.187 (25.40 x 4.75)	89	▲	✘	✘	●
THT-42-423	1.000 x 0.187 (25.40 x 4.75)	89	▲	✘	✘	●
THT-43-423	1.250 x 0.250 (31.75 x 6.35)	91	▲	✘	✘	●
THT-43-473	1.250 x 0.250 (31.75 x 6.35)	91	▲	✘	✘	●
THT-44-423	1.380 x 0.250 (35.05 x 6.35)	92	▲	✘	✘	●
THT-45-423	1.500 x 0.250 (38.10 x 6.35)	92	▲	✘	✘	●
THT-45-473	1.500 x 0.250 (38.10 x 6.35)	92	▲	✘	✘	●
THT-46-423	0.750 x 0.250 (19.05 x 6.35)	88	▲	✘	✘	●
THT-46-473	0.750 x 0.250 (19.05 x 6.35)	88	▲	✘	✘	●
THT-47-423	0.650 x 0.200 (16.51 x 5.08)	88	▲	✘	✘	●
THT-47-473	0.650 x 0.200 (16.51 x 5.08)	88	▲	✘	✘	●

- Yes, this material will work with this application.
- ✘ No, this material does not work with this application.
- ▲ In extreme high temperatures, testing of these materials is recommended.

Circuit Board and Component Identification Labels

► **POLYESTERS** CONTINUED

Permanent White Polyesters (B-422, B-423, B-459, B-488)
Static Dissipative Polyester (B-473)
Removable Polyester (B-433)

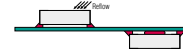

Part Number	Size Inch (mm)	Specifications on Page	Through Hole Technology		SMT Top / Bottom	After Process
			Top	Bottom		
THT-48-423	2.000 x 0.250 (50.80 x 6.35)	94	▲	✘	✘	●
THT-48-473	2.000 x 0.250 (50.80 x 6.35)	94	▲	✘	✘	●
THT-49-423	0.900 x 0.250 (22.86 x 6.35)	89	▲	✘	✘	●
THT-49-473	0.900 x 0.250 (22.86 x 6.35)	89	▲	✘	✘	●
THT-50-423	0.750 x 0.750 (19.05 x 19.05)	89	▲	✘	✘	●
THT-51-423	1.000 x 0.250 (25.40 x 6.35)	90	▲	✘	✘	●
THT-57-473	0.700 x 0.375 (17.78 x 9.53)	88	▲	✘	✘	●
THT-58-473	1.000 x 0.375 (25.40 x 9.53)	90	▲	✘	✘	●
THT-59-423	1.000 x 0.500 (25.40 x 12.70)	90	▲	✘	✘	●
THT-59-473	1.000 x 0.500 (25.40 x 12.70)	91	▲	✘	✘	●
THT-70-473	0.250 x 0.250 (6.35 x 6.35)	85	▲	✘	✘	●
THT-79-423	2.000 x 0.400 (50.80 x 10.16)	94	▲	✘	✘	●
THT-96-473	0.500 x 0.275 (12.70 x 6.99)	87	▲	✘	✘	●
THT-97-423	0.500 x 0.200 (12.70 x 5.08)	87	▲	✘	✘	●
THT-97-473	0.500 x 0.200 (12.70 x 5.08)	87	▲	✘	✘	●
THT-99-473	0.500 x 0.500 (12.70 x 12.70)	87	▲	✘	✘	●
THT-100-473	0.700 x 0.375 (17.78 x 9.53)	88	▲	✘	✘	●
THT-103-423	1.000 x 0.250 (25.40 x 6.35)	90	▲	✘	✘	●
THT-103-473	1.000 x 0.250 (25.40 x 6.35)	90	▲	✘	✘	●

► **METALLIZED POLYESTERS**

Permanent Metallized Polyester (B-428)
Rough Surface Metallized Polyester (B-434)
Glossy Metallized Polyester (B-435)

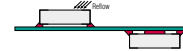
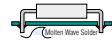

Part Number	Size Inch (mm)	Specifications on Page	Through Hole Technology		SMT Top / Bottom	After Process
			Top	Bottom		
THT-1-428	0.750 x 0.250 (19.05 x 6.35)	88	▲	✘	✘	●
THT-1-435	0.750 x 0.250 (19.05 x 6.35)	88	▲	✘	✘	●
THT-3-428	1.000 x 0.375 (25.40 x 9.53)	90	▲	✘	✘	●
THT-5-428	1.000 x 0.500 (25.40 x 12.70)	90	▲	✘	✘	●
THT-5-434	1.000 x 0.500 (25.40 x 12.70)	90	▲	✘	✘	●
THT-5-435	1.000 x 0.500 (25.40 x 12.70)	90	▲	✘	✘	●
THT-12-428	0.500 x 0.437 (12.70 x 11.10)	87	▲	✘	✘	●
THT-12-435	0.500 x 0.437 (12.70 x 11.10)	87	▲	✘	✘	●

- Yes, this material will work with this application.
- ✘ No, this material does not work with this application.
- ▲ In extreme high temperatures, testing of these materials is recommended.

Circuit Board and Component Identification Labels

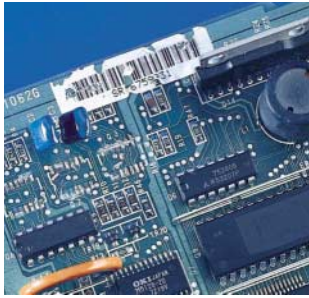

The B-351 tamper-resistant vinyl label destroys itself upon removal.

MISCELLANEOUS MATERIALS

Flame-Retardant White or Yellow Tedlar® (B-437)
White Vinyl Cloth Repositional Adhesive (B-498)

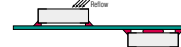
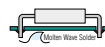

Part Number	Size Inch (mm)	Specifications on Page	Through Hole Technology Top	Through Hole Technology Bottom	SMT Top / Bottom	After Process
THT-1-437	0.750 x 0.25 (19.05 x 6.35)	88	▲	✘	✘	●
THT-1-498	0.750 x 0.25 (19.05 x 6.35)	89	▲	✘	✘	●
THT-2-437	0.900 x 0.25 (22.86 x 6.35)	89	▲	✘	✘	●
THT-5-437	1.000 x 0.50 (25.40 x 12.70)	90	▲	✘	✘	●
THT-5-437-YL	1.000 x 0.50 (25.40 x 12.70)	90	▲	✘	✘	●
THT-14-437	0.650 x 0.20 (16.51 x 5.08)	88	▲	✘	✘	●
THT-14-498	0.650 x 0.20 (16.51 x 5.08)	88	▲	✘	✘	●
THT-29-437	1.250 x 0.375 (31.75 x 9.53)	92	▲	✘	✘	●
THT-29-437-YL	1.250 x 0.375 (31.75 x 9.53)	92	▲	✘	✘	●

Tedlar® is a registered trademark of DuPont.

- Yes, this material will work with this application.
- ✘ No, this material does not work with this application.
- ▲ In extreme high temperatures, testing of these materials is recommended.

Wire and Cable Marking Labels

Self-Extinguishing White or Yellow Tedlar® Film For cable marking (B-437)

Part Number	Size Inch (mm)	Specifications on Page
THT-21-437	3.000 (76.20) x 100 LYD	97
THT-21-437-YL	3.000 (76.20) x 100 LYD	97
THT-105-437	1.500 (38.10) x 100 LYD	93
THT-105-437-YL	1.500 (38.10) x 100 LYD	93

Self-Laminating Vinyl (B-427) For flat ribbon cable marking.

Part Number	Size Inch (mm)	Specifications on Page
THT-10-427	1.000 x 3.750 (25.40 x 95.25)	99
THT-27-427	2.000 x 3.750 (50.80 x 95.25)	99

Self-Laminating Vinyl (B-427) For wire and cable identification.

Part Number	Size Inch (mm)	Specifications on Page
THT-8-427	0.500 x 1.437 (12.70 x 36.50)	99
THT-9-427	1.000 x 1.437 (25.40 x 36.50)	99
THT-10-427	1.000 x 3.750 (25.40 x 95.25)	99
THT-26-427	2.500 x 2.250 (63.50 x 57.15)	99
THT-27-427	2.000 x 3.750 (50.80 x 95.25)	99
THT-56-427	0.750 x 0.938 (19.05 x 23.81)	99
THT-61-427	0.500 x 1.437 (12.70 x 36.50)	100
THT-62-427	0.750 x 1.750 (19.05 x 44.45)	100
THT-63-427	0.800 x 1.437 (20.32 x 36.50)	100
THT-64-427	1.000 x 2.250 (25.40 x 57.15)	100
THT-65-427	1.000 x 3.750 (25.40 x 95.25)	100
THT-66-427	1.900 x 3.187 (48.26 x 80.95)	100
THT-67-427	2.000 x 2.250 (50.80 x 57.15)	100
THT-73-427	0.750 x 1.750 (19.05 x 44.45)	99
THT-74-427	0.800 x 1.437 (20.32 x 36.50)	99
THT-75-427	1.000 x 2.250 (25.40 x 57.15)	99
THT-80-427	0.500 x 0.750 (12.70 x 19.05)	99
THT-81-427	1.000 x 6.000 (25.40 x 152.40)	99
THT-82-427	2.000 x 6.000 (50.80 x 152.40)	99
THT-83-427	2.000 x 7.000 (50.80 x 177.80)	99
THT-84-427	1.000 x 6.000 (25.40 x 152.40)	100
THT-85-427	2.000 x 6.000 (50.80 x 152.40)	100
THT-86-427	2.000 x 7.000 (50.80 x 177.80)	100

Perforations exist between each row of labels for easy tear-off.

General Purpose Nylon Cloth (B-499) Permanent Adhesive

Part Number	Size Inch (mm)	Specifications on Page
THT-68-499	0.500 x 0.750 (12.70 x 19.05)	87
THT-69-499	0.800 x 1.437 (20.32 x 36.50)	89
THT-162-499	0.800 x 1.437 (20.32 x 36.50)	89

White Vinyl Cloth Repositionable Adhesive (B-498)

Part Number	Size Inch (mm)	Specifications on Page
THT-5-498	1.000 x 0.500 (25.40 x 12.70)	91
THT-68-498	0.500 x 0.750 (12.70 x 19.05)	87
THT-87-498	0.500 x 1.440 (12.70 x 36.50)	87
THT-88-498	1.000 x 0.750 (25.40 x 19.05)	91
THT-89-498	1.000 x 1.440 (25.40 x 36.50)	91
THT-90-498	0.250 x 1.437 (6.35 x 36.50)	86
THT-91-498	0.750 x 0.940 (19.05 x 23.80)	89
THT-95-498	0.800 x 1.440 (20.32 x 36.50)	89

Tedlar® is a registered trademark of DuPont.

Perforations exist between each row of labels for easy tear-off.

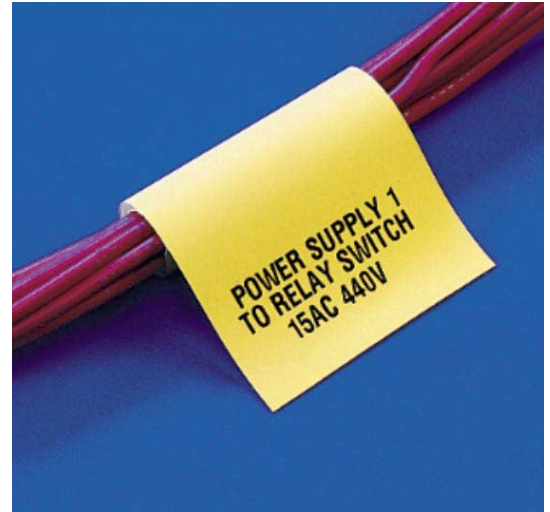

B-437 Yellow Tedlar in aerospace applications provides permanent identification of wire bundles.

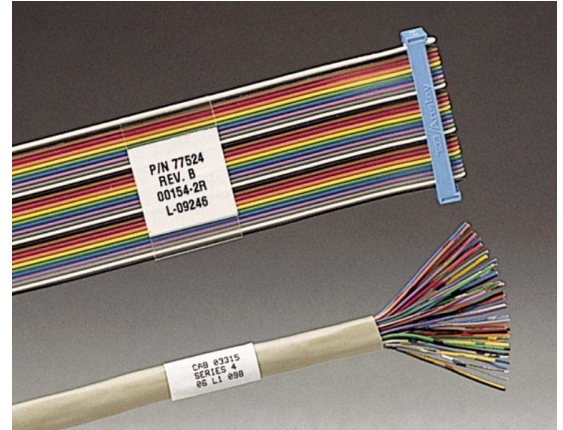

Identifying flat ribbon and multi-paired color cable is fast and easy with legends this sharp.

Sleeves for Wire and Cable Marking by Size

▶ 3-TO-1 SHRINK RATIO ONE-SIDED PRINTABLE PERMASLEEVE™ WIRE MARKERS

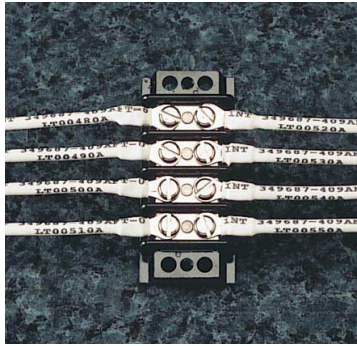

PermaSleeve markers fit snugly around wires for maximum insulation protection and permanent identification.

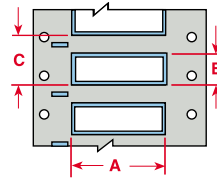

Brady PermaSleeve full-circle insulating wire markers meet the rigid insulating, material requirements and physical properties of MIL-DTL-23053/5 Class 1, MIL-M-81531, MIL-STD-202F, METHOD 215, and UL224. The heat-shrinkable irradiated polyolefin does not smudge or fade when printed. The unique flattened full-circle design provides fast, permanent wire marking. PermaSleeve markers may be printed on Brady's thermal transfer printers.

White Polyolefin (B-342) One-Sided Printable PermaSleeve Markers

Part Number	Markers Per Box	Range of Wire Dia. Inch (mm)		Approx. Wire Gauge**	Marker Width Inch (mm) A	Marker Height Inch (mm) B	Vertical Repeat Inch (mm) C	Recommended Ribbon
		Min.	Max.					
1.500" Marker Width								
PS-094-150-WT	2,500	0.023	(0.58)–(0.80) (2.03)	28-18	1.500 (38.10)	0.182 (4.60)	0.500 (12.70)	R4300
PS-094-150-WT-S	500	0.023	(0.58)–(0.80) (2.03)	28-18	1.500 (38.10)	0.182 (4.60)	0.500 (12.70)	R4300
PS-125-150-WT	2,500	0.046	(1.17)–(0.110) (2.79)	22-16	1.500 (38.10)	0.235 (6.00)	0.500 (12.70)	R4300
PS-125-150-WT-S	500	0.046	(1.17)–(0.110) (2.79)	22-16	1.500 (38.10)	0.235 (6.00)	0.500 (12.70)	R4300
PS-187-150-WT	2,500	0.062	(1.57)–(0.150) (3.81)	18-12	1.500 (38.10)	0.335 (8.50)	0.625 (15.88)	R4300
PS-187-150-WT-S	500	0.062	(1.57)–(0.150) (3.81)	18-12	1.500 (38.10)	0.335 (8.50)	0.625 (15.88)	R4300
PS-250-150-WT	2,500	0.094	(2.39)–(0.215) (5.46)	16-10	1.500 (38.10)	0.439 (11.15)	0.750 (19.05)	R4300
PS-250-150-WT-S	500	0.094	(2.39)–(0.215) (5.46)	16-10	1.500 (38.10)	0.439 (11.15)	0.750 (19.05)	R4300
PS-375-150-WT	1,000	0.125	(3.18)–(0.320) (8.13)	12-6	1.500 (38.10)	0.645 (16.40)	1.000 (25.40)	R4300
PS-375-150-WT-S	250	0.125	(3.18)–(0.320) (8.13)	12-6	1.500 (38.10)	0.645 (16.40)	1.000 (25.40)	R4300
PS-500-150-WT	500	0.187	(4.75)–(0.450) (11.43)	8-1	1.500 (38.10)	0.851 (21.60)	1.250 (31.75)	R4300
PS-500-150-WT-S	250	0.187	(4.75)–(0.450) (11.43)	8-1	1.500 (38.10)	0.851 (21.60)	1.250 (31.75)	R4300
2.000" Marker Width								
PS-094-2-WT	2,500	0.023	(0.58)–(0.80) (2.03)	28-18	2.000 (50.80)	0.182 (4.60)	0.500 (12.70)	R4300
PS-094-2-WT-S	500	0.023	(0.58)–(0.80) (2.03)	28-18	2.000 (50.80)	0.182 (4.60)	0.500 (12.70)	R4300
PS-125-2-WT	2,500	0.046	(1.17)–(0.110) (2.79)	22-16	2.000 (50.80)	0.235 (6.00)	0.500 (12.70)	R4300
PS-125-2-WT-S	500	0.046	(1.17)–(0.110) (2.79)	22-16	2.000 (50.80)	0.235 (6.00)	0.500 (12.70)	R4300
PS-187-2-WT	2,500	0.062	(1.57)–(0.150) (3.81)	18-12	2.000 (50.80)	0.335 (8.50)	0.625 (15.88)	R4300
PS-187-2-WT-S	500	0.062	(1.57)–(0.150) (3.81)	18-12	2.000 (50.80)	0.335 (8.50)	0.625 (15.88)	R4300
PS-250-2-WT	2,500	0.094	(2.39)–(0.215) (5.46)	16-10	2.000 (50.80)	0.439 (11.15)	0.750 (19.05)	R4300
PS-250-2-WT-S	500	0.094	(2.39)–(0.215) (5.46)	16-10	2.000 (50.80)	0.439 (11.15)	0.750 (19.05)	R4300
PS-375-2-WT	1,000	0.125	(3.18)–(0.320) (8.13)	12-6	2.000 (50.80)	0.645 (16.40)	1.000 (25.40)	R4300
PS-375-2-WT-S	250	0.125	(3.18)–(0.320) (8.13)	12-6	2.000 (50.80)	0.645 (16.40)	1.000 (25.40)	R4300
PS-500-2-WT	500	0.187	(4.75)–(0.450) (11.43)	8-1	2.000 (50.80)	0.851 (21.60)	1.250 (31.75)	R4300
PS-500-2-WT-S	250	0.187	(4.75)–(0.450) (11.43)	8-1	2.000 (50.80)	0.851 (21.60)	1.250 (31.75)	R4300

2-to-1 Shrink Ratio White Polyolefin (B-341) One-Sided Printable PermaSleeve Markers

Part Number	Markers Per Box	Range of Wire Dia. Inch (mm)		Approx. Wire Gauge**	Marker Width Inch (mm) A	Marker Height Inch (mm) B	Vertical Repeat Inch (mm) C	Recommended Ribbon
		Min.	Max.					
2.000" Marker Width								
PS-1000-2-WT	250	0.450	(11.43)–(0.950) (24.13)	1-500	2.000 (50.80)	1.660 (42.16)	2.000 (50.80)	R4300

**Based on National Electric Code insulation measurement of THHN wire.

Sleeves may be perforated at factory for shorter marker lengths. Depending on overall length, sleeves may be perforated in halves, thirds or fourths. Contact your Brady Identification Solutions Distributor or Customer Service Representative for ordering information.

Sleeves for Wire and Cable Marking by Size

▶ 3-TO-1 SHRINK RATIO TWO-SIDED PRINTABLE PERMASLEEVE™ MARKERS



Brady's PermaSleeve markers provide a complete wire marking solution that combines speed, ease of use, and permanence to create long-lasting, high quality identification.

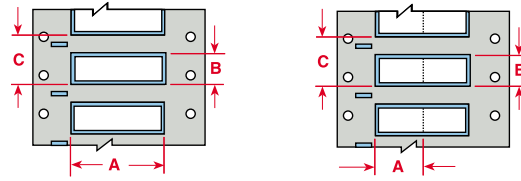

PermaSleeve full-circle markers are available in a 3-to-1 shrink ratio to cover a wider range of wire diameters per sleeve size.

White Polyolefin (B-342) Two-Sided Printable PermaSleeve Markers

Part Number	Markers Per Box	Range of Wire Dia. Inch (mm) Min. Max.	Approx. Wire Gauge**	Marker Width Inch (mm) A	Marker Height Inch (mm) B	Vertical Repeat Inch (mm) C	Recommended Ribbon
2.000" Marker Width							
3PS-094-2-WT	2,500	0.023 (0.58)–0.080 (2.03)	28-18	2.000 (50.80)	0.182 (4.60)	0.500 (12.70)	R4300
3PS-094-2-WT-S	500	0.023 (0.58)–0.080 (2.03)	28-18	2.000 (50.80)	0.182 (4.60)	0.500 (12.70)	R4300
3PS-125-2-WT	2,500	0.046 (1.17)–0.110 (2.79)	22-16	2.000 (50.80)	0.235 (6.00)	0.500 (12.70)	R4300
3PS-125-2-WT-S	500	0.046 (1.17)–0.110 (2.79)	22-16	2.000 (50.80)	0.235 (6.00)	0.500 (12.70)	R4300
3PS-187-2-WT	2,500	0.062 (1.57)–0.150 (3.81)	18-12	2.000 (50.80)	0.335 (8.50)	0.625 (16.00)	R4300
3PS-187-2-WT-S	500	0.062 (1.57)–0.150 (3.81)	18-12	2.000 (50.80)	0.335 (8.50)	0.625 (16.00)	R4300
3PS-250-2-WT	2,500	0.094 (2.39)–0.215 (5.46)	16-10	2.000 (50.80)	0.439 (11.15)	0.750 (19.05)	R4300
3PS-250-2-WT-S	500	0.094 (2.39)–0.215 (5.46)	16-10	2.000 (50.80)	0.439 (11.15)	0.750 (19.05)	R4300
3PS-375-2-WT	1,000	0.125 (3.18)–0.320 (8.13)	12-6	2.000 (50.80)	0.645 (16.40)	1.000 (25.40)	R4300
3PS-375-2-WT-S	250	0.125 (3.18)–0.320 (8.13)	12-6	2.000 (50.80)	0.645 (16.40)	1.000 (25.40)	R4300
3PS-500-2-WT	500	0.187 (4.75)–0.450 (11.43)	8-1	2.000 (50.80)	0.851 (21.60)	1.250 (31.75)	R4300
3PS-500-2-WT-S	250	0.187 (4.75)–0.450 (11.43)	8-1	2.000 (50.80)	0.851 (21.60)	1.250 (31.75)	R4300

**Based on National Electric Code insulation measurement of THHN wire.

Sleeves may be perforated at factory for shorter marker lengths. Depending on overall length, sleeves may be perforated in halves, thirds or fourths. Contact your Brady Identification Solutions Distributor or Customer Service Representative for ordering information.

Sleeves for Wire and Cable Marking by Size

▶ COLORED TWO-SIDED 3-TO-1 SHRINK RATIO PERMASLEEVE™ MARKERS

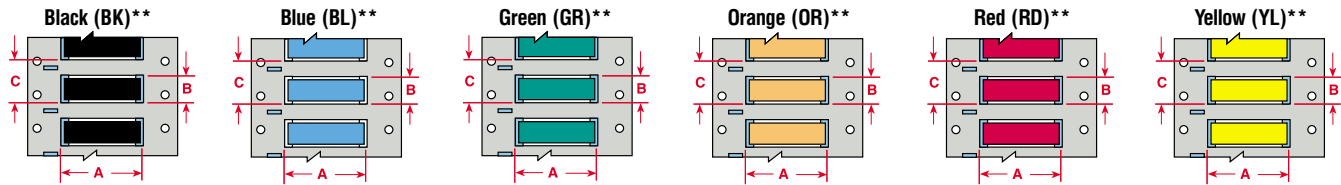

PermaSleeve full-circle markers are available in a 3-to-1 shrink ratio to cover a wider range of wire diameters per sleeve size.

3-to-1 Shrink Ratio Colored Polyolefin (B-342) Two-Sided Printable PermaSleeve Markers

Part Number	Markers Per Box	Range of Wire Dia. Inch (mm)		Approx. Wire Gauge***	Marker Width Inch (mm) A	Marker Height Inch (mm) B	Vertical Repeat Inch (mm) C	Recommended Ribbon
		Min.	Max.					
2.000" Marker Width								
3PS-094-2-YL	2,500	0.023	(0.58)–0.080 (2.03)	28-18	2.000 (50.80)	0.182 (4.60)	0.500 (12.70)	R4300
3PS-094-2**-S	500	0.023	(0.58)–0.080 (2.03)	28-18	2.000 (50.80)	0.182 (4.60)	0.500 (12.70)	R4300
3PS-125-2-YL	2,500	0.046	(1.17)–0.110 (2.79)	22-16	2.000 (50.80)	0.235 (6.00)	0.500 (12.70)	R4300
3PS-125-2**-S	500	0.046	(1.17)–0.110 (2.79)	22-16	2.000 (50.80)	0.235 (6.00)	0.500 (12.70)	R4300
3PS-187-2-YL	2,500	0.062	(1.57)–0.150 (3.81)	18-12	2.000 (50.80)	0.335 (8.50)	0.625 (15.88)	R4300
3PS-187-2**-S	500	0.062	(1.57)–0.150 (3.81)	18-12	2.000 (50.80)	0.335 (8.50)	0.625 (16.00)	R4300
3PS-250-2-YL	2,500	0.094	(2.39)–0.215 (5.46)	16-10	2.000 (50.80)	0.439 (11.15)	0.750 (19.05)	R4300
3PS-250-2**-S	500	0.094	(2.39)–0.215 (5.46)	16-10	2.000 (50.80)	0.439 (11.15)	0.750 (19.05)	R4300
3PS-375-2-YL	1,000	0.125	(3.18)–0.320 (8.13)	12-6	2.000 (50.80)	0.645 (16.40)	1.000 (25.40)	R4300
3PS-375-2**-S	250	0.125	(3.18)–0.320 (8.13)	12-6	2.000 (50.80)	0.645 (16.40)	1.000 (25.40)	R4300
3PS-500-2-YL	500	0.187	(4.75)–0.450 (11.43)	8-1	2.000 (50.80)	0.851 (21.60)	1.250 (31.75)	R4300
3PS-500-2**-S	250	0.187	(4.75)–0.450 (11.43)	8-1	2.000 (50.80)	0.851 (21.60)	1.250 (31.75)	R4300

Contact your Brady Identification Solutions Distributor or Customer Service Representative for ordering information.

**When ordering a color add YL (Yellow), RD (Red), BL (Blue), OR (Orange), GR (Green), BK (Black). Color is on both sides.

2-to-1 Shrink Ratio Colored Polyolefin (B-341) One-Sided Printable PermaSleeve Markers

Part Number	Markers Per Box	Range of Wire Dia. Inch (mm)		Approx. Wire Gauge***	Marker Width Inch (mm) A	Marker Height Inch (mm) B	Vertical Repeat Inch (mm) C	Recommended Ribbon
		Min.	Max.					
2.000" Marker Width								
PS-1000-2-YL	250	0.450	(11.43)–0.950 (24.13)	1-500	2.000 (50.80)	1.660 (42.16)	2.000 (50.80)	R4300
PS-1000-2-BK-S	100	0.450	(11.43)–0.950 (24.13)	1-500	2.000 (50.80)	1.660 (42.16)	2.000 (50.80)	R4300

*To choose a specific ribbon width for your particular label, please use the Ribbon/Width Cross Reference Guide on page 123.

***Based on National Electric Code insulation measurement of THHN wire.

Sleeves may be perforated at factory for shorter marker lengths. Depending on overall length, sleeves may be perforated in halves, thirds or fourths. Contact your Brady Identification Solutions Distributor or Customer Service Representative for ordering information.

Terminal Block Marking

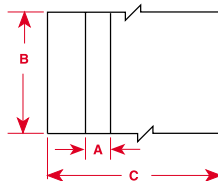

White Vinyl Cloth (B-498)

Part Number	Inches Per Package	Label Size Inch (mm)	Label Width A	Label Height B	Web Width C	Specifications On Page
THT-92-498-2	2,000	0.375 x 165 ft (9.53 x 50.80 m)	0.375 (9.53)	165 ft (50.80 m)	1.000 (25.40)	86
THT-93-498-2	2,000	0.318 x 165 ft (8.08 x 50.80 m)	0.318 (8.08)	165 ft (50.80 m)	1.000 (25.40)	86
THT-94-498-2	2,000	0.240 x 165 ft (6.10 x 50.80 m)	0.240 (6.10)	165 ft (50.80 m)	1.000 (25.40)	85

Data Communications Equipment and Cabling Labels and Tags

► WORKSTATION LABELS

Polypropylene (B-412), Permanent Glossy Polyester (B-422), Clear Polyester (B-430)

Part Number	Applications	Size Inch (mm)	Specifications on Page
THT-3-422	1-4 Outlet Faceplates	1.000 x 0.375 (25.40 x 9.53)	90
THT-3-430	1-4 Outlet Faceplates	1.000 x 0.375 (25.40 x 9.53)	90
THT-5-422	1-4 Outlet Faceplates	1.000 x 0.500 (25.40 x 12.70)	90
THT-37-422	1-2 Outlet Faceplates	1.500 x 0.500 (38.10 x 12.70)	93
THT-37-430	1-2 Outlet Faceplates	1.500 x 0.500 (38.10 x 12.70)	93
THT-39-430	1-4 Outlet Faceplates	1.000 x 0.500 (25.40 x 12.70)	90
THT-147-422	1-2 Outlet Faceplates	1.500 x 0.375 (38.10 x 9.53)	93
THT-147-430	1-2 Outlet Faceplates	1.500 x 0.375 (38.10 x 9.53)	93
THT-148-422	1-6 Outlet Faceplates	0.500 x 0.375 (12.70 x 9.53)	87
THT-148-430	1-6 Outlet Faceplates	0.500 x 0.375 (12.70 x 9.53)	87
THT-149-422	1-6 Outlet Faceplates	0.500 x 0.500 (12.70 x 12.70)	87
THT-149-430	1-6 Outlet Faceplates	0.500 x 0.500 (12.70 x 12.70)	87
THT-150-412	Faceplate Desi-Strip Inserts	1.938 x 0.375 (49.23 x 9.53)	93

► COMMUNICATIONS CABLING

Vinyl (B-427)

Part Number	Applications	Size Inch (mm)	Specifications on Page
THT-9-427	4 pair, UTP	1.000 x 1.437 (25.40 x 36.50)	99
THT-10-427	50 pair copper	1.000 x 3.759 (25.40 x 95.48)	99
THT-56-427	2 pair fiber, single/multi mode	0.750 x 0.938 (19.05 x 23.83)	99
THT-75-427	25 pair copper	1.000 x 2.250 (25.40 x 57.15)	99
THT-117-427	2 pair fiber, single/multi mode	1.000 x 1.250 (25.40 x 31.75)	91
THT-118-427	2 pair fiber, single/multi mode	1.500 x 1.000 (38.10 x 25.40)	99
THT-119-427	4 pair, UTP	1.500 x 1.500 (38.10 x 38.10)	99
THT-120-427	2 pair fiber, single/multi mode	1.750 x 1.000 (44.45 x 25.40)	99
THT-121-427	4 pair, UTP	1.750 x 1.500 (44.45 x 38.10)	99

► TELECOMMUNICATIONS SPACE

Permanent Glossy Polyester (B-422), Clear Polyester (B-430)







Part Number	Applications	Size Inch (mm)	Specifications on Page
THT-148-422	Patch Panel – (label each port)	0.500 x 0.375 (12.70 x 9.53)	87
THT-148-430	Patch Panel – (label each port)	0.500 x 0.375 (12.70 x 9.53)	87
THT-149-422	Patch Panel – (label each port)	0.500 x 0.500 (12.70 x 12.70)	87
THT-149-430	Patch Panel – (label each port)	0.500 x 0.500 (12.70 x 12.70)	87

► GENERAL COMMUNICATIONS IDENTIFICATION

Permanent Glossy Polyester (B-422), Clear Polyester (B-430)

Part Number	Applications	Size Inch (mm)	Specifications on Page
THT-17-422	General Identification	2.000 x 1.000 (50.80 x 25.40)	94
THT-17-430	General Identification	2.000 x 1.000 (50.80 x 25.40)	94
THT-18-422	General Identification	3.000 x 1.000 (76.20 x 25.40)	96
THT-18-430	General Identification	3.000 x 1.000 (76.20 x 25.40)	96
THT-19-422	General Identification	3.000 x 2.000 (76.20 x 50.80)	96
THT-19-430	General Identification	3.000 x 2.000 (76.20 x 50.80)	96

MATERIAL TO SURFACE CROSS REFERENCE GUIDE

Part Number	SMOOTH	TEXTURED/ROUGH	HIGHLY TEXTURED/ LOW SURFACE ENERGY
BRADYBONDZ™ <i>White</i> B-423, B-433, B-354, B-359, B-459, B-488, B-7546, B-8423, B-8425 <i>Metallized</i> B-428, B-438, B-7576 <i>Clear</i> B-358, B-430, B-7566	 YES (i.e. Steel, Aluminum, Plastic, Glass)	NO	NO
SUPER BRADYBONDZ™ <i>White</i> B-350, B-351, B-353, B-422, B-437, B-439, B-498 <i>Metallized</i> B-352, B-434, B-435 <i>Clear</i> B-432	 YES (i.e. Steel, Aluminum, Plastic, Glass)	 YES (i.e. Textured ABS, Painted Enamel Cast Metal, Polycarbonate)	NO
ULTRA BRADYBONDZ™ <i>White</i> B-483, B-484, B-489, B-499 <i>Metallized</i> B-486	 YES (i.e. Steel, Aluminum, Plastic, Glass)	 YES (i.e. Textured ABS, Painted Enamel Cast Metal, Polycarbonate)	 YES (i.e. Powder Coated, Polypropylene Highly Textured & Low Surface Energy ABS)

MATERIALS CHART

Material	Color	Finish	Adhesive	Max. Service Temp. (30 days)	Ribbon	Agency Approvals	Color Code	
B-350	Polyester/Paper	White	Gloss	Acrylic	194° F (90° C)	R6000	UL	●
B-351	Vinyl	White	Matte	Acrylic	176° F (80° C)	R6200		●
B-352	Vinyl	Silver	Matte	Acrylic	176° F (80° C)	R6000		●
B-353	Paper	White	Matte	Acrylic	194° F (90° C)	R4300		●
B-354	Polyester/Paper	White	Gloss	Acrylic	194° F (90° C)	R6200	UL**	◆
B-358	Acetate	Clear	Gloss	Acrylic	176° F (80° C)	R6200		◆
B-359	Acetate	White	Gloss	Acrylic	176° F (80° C)	R6200		◆
B-407	Polyolefin	Clear	Matte	Acrylic	194° F (90° C)	R6200		◆
B-422	Polyester	White	Glossy	Acrylic	248° F (120° C)	R6000	CS UL	●
B-423	Polyester	White	Glossy	Acrylic	248° F (120° C)	R6000	CS UL AGA	◆
B-428	Polyester	Silver	Matte	Acrylic	176° F (80° C)	R4300	CS UL AGA	◆
B-430	Polyester	Clear	Glossy	Acrylic	212° F (100° C)	R6000	CS UL	◆
B-432	Polyester	Clear	Glossy	Acrylic	212° F (100° C)	R6000	CS UL	●
B-433	Polyester	White	Glossy	Acrylic	212° F (100° C)	R4900	UL	◆
B-434	Polyester	Silver	Glossy	Acrylic	194° F (90° C)	R6000	CS UL	●
B-435	Polyester	Silver	Glossy	Acrylic	194° F (90° C)	R6000	CS UL AGA	●
B-437	Polyvinylflouride	White/Yellow	Matte	Acrylic	275° F (135° C)	R4300		●
B-438	Polyester	Silver	Matte	Acrylic	104° F (40° C)	R4300	UL	◆
B-439	Vinyl	*	Glossy	Acrylic	104° F (40° C)	R6000		●
B-459	Polyester	White	Matte	Acrylic	212° F (100° C)	R6000	CS UL	◆
B-483	Polyester	White	Glossy	Synth. Rubber	248° F (120° C)	R6000	CS UL	■
B-484	Polyester	White	Glossy	Synth. Rubber	248° F (120° C)	R6000	UL	■
B-486	Polyester	Silver	Matte	Synth. Rubber	248° F (120° C)	R4300	CS UL	■
B-488	Polyester	White	Matte	Acrylic	370° F (160° C)	R4300	CS UL AGA	◆
B-489	Polyester	White	Matte	Synth. Rubber	248° F (120° C)	R4300	CS UL	■
B-498	Cloth	White	Matte	Rubber	175° F (80° C)	R4300		●
B-499	Nylon Cloth	White	Matte	Acrylic	194° F (90° C)	R4900	CS UL	■
B-7546	Polyester	White	Gloss	Acrylic	175° F (80° C)	R6000	CS UL	◆
B-7566	Polyester	Clear	Gloss	Acrylic	175° F (80° C)	R6000		◆
B-7576	Polyester	Silver	Matte	Acrylic	212° F (100° C)	R6000	UL	◆
B-8423	Polyester	White	Glossy	Acrylic	248° F (120° C)	R6000	CS UL AGA	◆
B-8425	Polyolefin	White	Matte	Acrylic	194° F (90° C)	R6200	CS UL	◆

* B-439 is available in 10 colors (Black, Gold, Green, Light Blue, Orange, Purple, Red, Silver, White, Yellow).



*These materials are UL recognized.



*These materials are CSA approved.



*These materials are AGA approved.

*Refer to the full page charts on pages 280-281 for more information and complete listing of parts.

**Currently in testing.

Industrial Material Comparison Chart

SMOOTH	
Typical surface energy levels for this category are above 50 Dynes/cm.	
SURFACES	
Stainless Steel	Tin
Copper	Glass
Aluminum	Smooth Metal
Smooth Plastic	

TEXTURED/ROUGH	
Typical surface energy levels for this category are between 38 Dynes/cm and 50 Dynes/cm.	
SURFACES	
Cast Metal	Polyurethane
Nylon	ABS
Alkyd Enamel	Polycarbonate
Polyester	PVC
Epoxy Paint	Acrylic

HIGHLY TEXTURED/ LOW SURFACE ENERGY	
Typical surface energy levels for low surface energy products are below 38 Dynes/cm.	
SURFACES	
Polystyrene	Polypropylene
Acetal	Teflon
Polyethylene	Powder Coatings
Highly Textured	ABS

1 = LOWEST ADHESIVE BOND 10 = HIGHEST ADHESIVE BOND

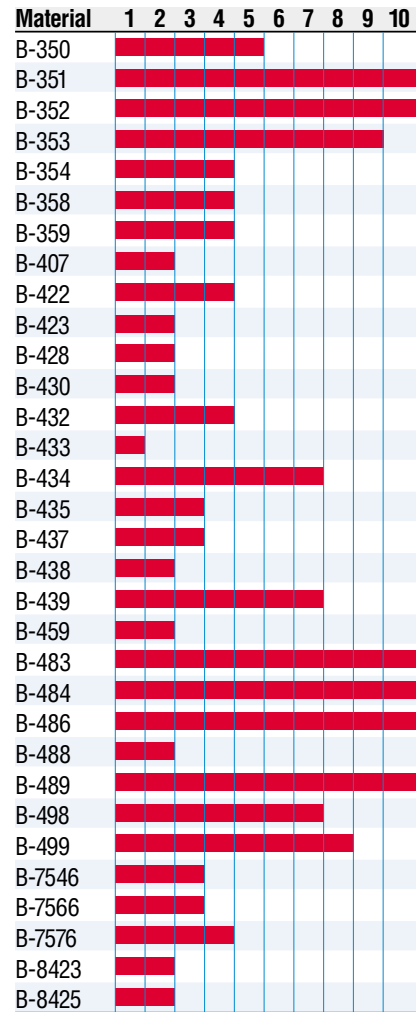
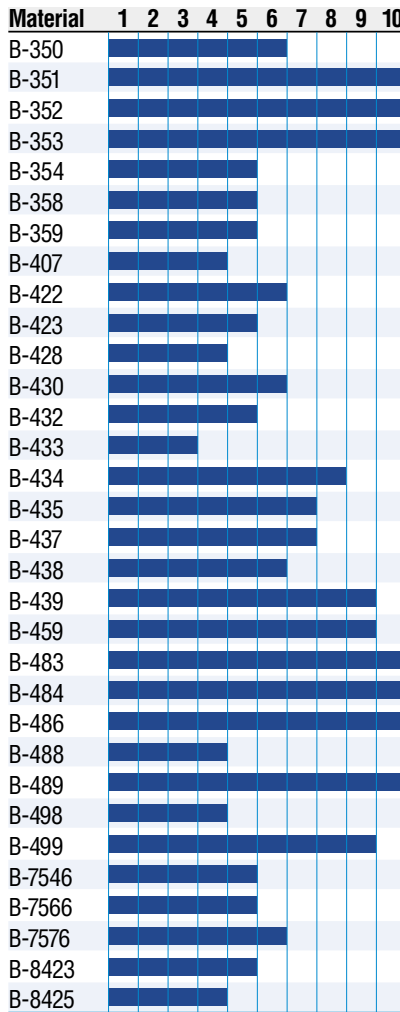
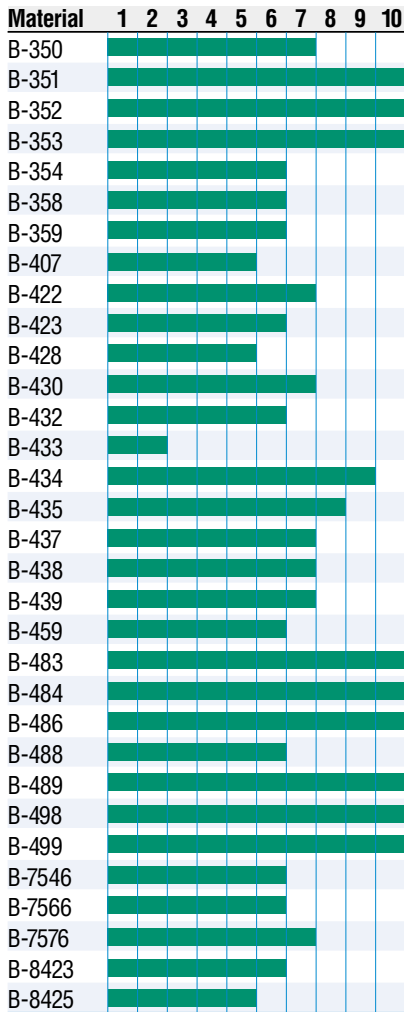

These charts are based on relative adhesion after 24 hour dwell within each given surface energy category.

Adhesion is the attraction between unlike materials. The strength of the adhesion is determined by the surface energy of the item being identified. The higher the surface energy, the greater the likelihood for the label to adhere. A lower surface energy product will be more difficult for a label to adhere.

For additional technical information on any Brady material, please visit the Brady website at www.bradyid.com.

► PAPER LABELS

Tamper Resistant White Paper (B-353)
General-Purpose White Paper (B-424, B-402)
Removable White Paper (B-408)

Part Number	Size Inch (mm)	Specifications on Page
THT-17-402	2.000 x 1.000 (50.80 x 25.40)	94
THT-17-408	2.000 x 1.000 (50.80 x 25.40)	94
THT-17-424	2.000 x 1.000 (50.80 x 25.40)	94
THT-18-402	3.000 x 1.000 (76.20 x 25.40)	95
THT-18-408	3.000 x 1.000 (76.20 x 25.40)	96
THT-18-424	3.000 x 1.000 (76.20 x 25.40)	96
THT-19-402	3.000 x 2.000 (76.20 x 50.80)	96
THT-19-408	3.000 x 2.000 (76.20 x 50.80)	96
THT-19-424	3.000 x 2.000 (76.20 x 50.80)	96
THT-20-402	3.000 x 5.000 (76.20 x 127.00)	96
THT-20-408	3.000 x 5.000 (76.20 x 127.00)	96
THT-25-402	4.000 x 6.000 (101.60 x 152.40)	97
THT-25-408	4.000 x 6.000 (101.60 x 152.40)	97
THT-53-424	2.000 x .5000 (50.80 x 12.70)	94
THT-55-402	4.000 x 2.000 (101.60 x 50.80)	97
THT-55-408	4.000 x 2.000 (101.60 x 50.80)	97
THT-55-424	4.000 x 2.000 (101.60 x 50.80)	97
THT-77-402	4.000 x 4.000 (101.60 x 101.60)	97
THT-78-402	4.000 x 6.500 (101.60 x 165.10)	97
THT-78-408	4.000 x 6.500 (101.60 x 165.10)	97



Brady's paper labels are ideal for shipping and general purpose labeling.

► RATING PLATES AND ASSET IDENTIFICATION

Permanent Metallized Polyester (B-428)
Rough Surface Metallized Polyester (B-434, B-486)
Glossy Metallized Polyester (B-435)

Part Number	Size Inch (mm)	Specifications on Page
THT-5-434	1.000 x 0.500 (25.40 x 12.70)	90
THT-5-438	1.000 x 0.500 (25.40 x 12.70)	90
THT-5-486	1.000 x 0.500 (25.40 x 12.70)	91
THT-6-428	1.500 x 0.750 (38.10 x 19.05)	93
THT-6-434	1.500 x 0.750 (38.10 x 19.05)	93
THT-6-486	1.500 x 0.750 (38.10 x 19.05)	93
THT-7-428	2.750 x 1.250 (69.85 x 31.75)	95
THT-7-486	2.750 x 1.250 (69.85 x 31.75)	95
THT-17-428	2.000 x 1.000 (50.80 x 25.40)	94
THT-17-434	2.000 x 1.000 (50.80 x 25.40)	94
THT-17-486	2.000 x 1.000 (50.80 x 25.40)	94
THT-18-428	3.000 x 1.000 (76.20 x 25.40)	96
THT-18-434	3.000 x 1.000 (76.20 x 25.40)	96
THT-18-435	3.000 x 1.000 (76.20 x 25.40)	96
THT-18-486	3.000 x 1.000 (76.20 x 25.40)	96
THT-19-428	3.000 x 2.000 (76.20 x 50.80)	96
THT-19-434	3.000 x 2.000 (76.20 x 50.80)	96
THT-19-435	3.000 x 2.000 (76.20 x 50.80)	96
THT-19-486	3.000 x 2.000 (76.20 x 50.80)	96
THT-37-428	1.500 x 0.500 (38.10 x 12.70)	93
THT-37-434	1.500 x 0.500 (38.10 x 12.70)	93
THT-37-486	1.500 x 0.500 (38.10 x 12.70)	93
THT-53-428	2.000 x 0.500 (50.80 x 12.70)	94
THT-53-486	2.000 x 0.500 (50.80 x 12.70)	94
THT-55-428	4.000 x 2.000 (101.60 x 50.80)	97
THT-55-434	4.000 x 2.000 (101.60 x 50.80)	97
THT-55-435	4.000 x 2.000 (101.60 x 50.80)	97
THT-59-486	1.000 x 0.500 (25.40 x 12.70)	91



Brady's metallized polyester material is perfect for on-demand printing of serialized rating plates. It eliminates the lead time needed for purchasing pre-printed labels, giving you better control over label design and cost.

General and Industrial Identification

▶ RATING PLATES AND ASSET IDENTIFICATION CONTINUED

Clear Polyolefin (B-407) - Clear Polyester (B-430) Rough Surface Clear Polyester (B-432)

Part Number	Size Inch (mm)	Specifications on Page
THT-17-407	2.000 x 1.000 (50.80 x 25.40)	94
THT-17-430	2.000 x 1.000 (50.80 x 25.40)	94
THT-18-407	3.000 x 1.000 (76.20 x 25.40)	95
THT-18-430	3.000 x 1.000 (76.20 x 25.40)	96
THT-19-407	3.000 x 2.000 (76.20 x 50.80)	96
THT-19-430	3.000 x 2.000 (76.20 x 50.80)	96
THT-19-432	3.000 x 2.000 (76.20 x 50.80)	96
THT-39-407	1.000 x 0.500 (25.40 x 12.70)	90

White Polyolefin (B-8425)

Part Number	Size Inch (mm)	Specifications on Page
XTHT-5-8425	1.000 x 0.500 (25.40 x 12.70)	91
XTHT-17-8425	2.000 x 1.000 (50.80 x 25.40)	95
XTHT-18-8425	3.000 x 1.000 (76.20 x 25.40)	96
XTHT-19-8425	3.000 x 2.000 (76.20 x 50.80)	96
XTHT-55-8425	4.000 x 2.000 (101.60 x 50.80)	97

Removable White Polypropylene (B-449)

Part Number	Size Inch (mm)	Specifications on Page
THT-5-449	1.000 x 0.500 (25.40 x 12.70)	91
THT-13-449	1.250 x 0.250 (31.75 x 6.35)	91
THT-17-449	2.000 x 1.000 (50.80 x 25.40)	94
THT-18-449	3.000 x 1.000 (76.20 x 25.40)	96
THT-19-449	3.000 x 2.000 (76.20 x 50.80)	96
THT-55-449	4.000 x 2.000 (101.60 x 50.80)	97
THT-76-449	4.000 x 3.000 (101.60 x 76.20)	97

PermaShield™* Labels (B-423/B-966) (B-428/B-966)

Part Number	Size Inch (mm)	Specifications on Page
THT-22-423	1.250 x 0.750 (31.75 x 19.05)	98
THT-22-428	1.250 x 0.750 (31.75 x 19.05)	98
THT-23-423	2.000 x 1.000 (50.80 x 25.40)	98
THT-23-428	2.000 x 1.000 (50.80 x 25.40)	98
THT-24-423	2.750 x 1.750 (69.85 x 44.45)	98
THT-24-428	2.750 x 1.750 (69.85 x 44.45)	98

* This product is sold in Japan under the Overlaminated Labels name and not under the PermaShield name.

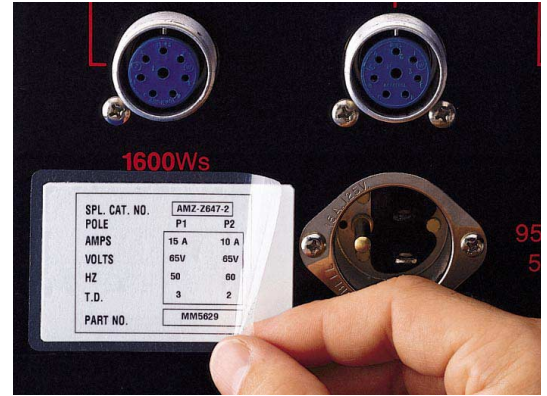

Application of PermaShield labels is easy. Print the label on a thermal transfer printer and put in place, covering with the clear overlaminate.

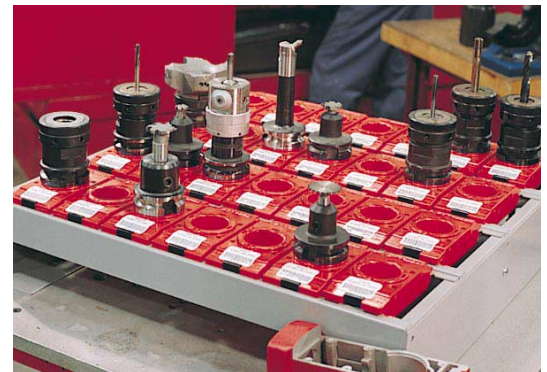

Brady's durable, easy-to-read labels help you keep track of assets. Ideal for bar coded inventory control.

► RATING PLATES AND ASSET IDENTIFICATION CONTINUED

Permanent White Polyesters (B-422, B-423, B-459, B-483, B-484, B-488, B-489 & B-8423)
Removable White Polyester (B-433)

Part Number	Size Inch (mm)	Specifications on Page
XTHT-1-8423	0.750 x 0.250 (19.05 x 6.35)	89
XTHT-2-8423	0.900 x 0.250 (22.86 x 6.35)	89
XTHT-3-8423	1.000 x 0.375 (25.40 x 9.53)	89
XTHT-4-8423	1.500 x 0.250 (38.10 x 6.35)	93
THT-5-422	1.000 x 0.500 (25.40 x 12.70)	90
THT-5-423	1.000 x 0.500 (25.40 x 12.70)	90
THT-5-433	1.000 x 0.500 (25.40 x 12.70)	90
THT-5-459	1.000 x 0.500 (25.40 x 12.70)	91
THT-5-483	1.000 x 0.500 (25.40 x 12.70)	91
THT-5-484	1.000 x 0.500 (25.40 x 12.70)	91
THT-5-488	1.000 x 0.500 (25.40 x 12.70)	91
THT-5-489	1.000 x 0.500 (25.40 x 12.70)	91
XTHT-5-8423	1.000 x 0.500 (25.40 x 12.70)	91
THT-6-423	1.500 x 0.750 (38.10 x 19.05)	93
THT-7-422	2.750 x 1.250 (69.85 x 31.75)	95
THT-7-423	2.750 x 1.250 (69.85 x 31.75)	95
THT-7-483	2.750 x 1.250 (69.85 x 31.75)	95
THT-7-489	2.750 x 1.250 (69.85 x 31.75)	95
THT-17-422	2.000 x 1.000 (50.80 x 25.40)	94
THT-17-423	2.000 x 1.000 (50.80 x 25.40)	94
THT-17-483	2.000 x 1.000 (50.80 x 25.40)	94
THT-17-484	2.000 x 1.000 (50.80 x 25.40)	94
THT-17-488	2.000 x 1.000 (50.80 x 25.40)	94
THT-17-489	2.000 x 1.000 (50.80 x 25.40)	95
XTHT-17-8423	2.000 x 1.000 (50.80 x 25.40)	95
THT-18-422	3.000 x 1.000 (76.20 x 25.40)	96
THT-18-423	3.000 x 1.000 (76.20 x 25.40)	96
THT-18-433	3.000 x 1.000 (76.20 x 25.40)	96
THT-18-483	3.000 x 1.000 (76.20 x 25.40)	96
THT-18-484	3.000 x 1.000 (76.20 x 25.40)	96
THT-18-488	3.000 x 1.000 (76.20 x 25.40)	96
THT-18-489	3.000 x 1.000 (76.20 x 25.40)	96
XTHT-18-8423	3.000 x 1.000 (76.20 x 25.40)	96
THT-19-422	3.000 x 2.000 (76.20 x 50.80)	96
THT-19-423	3.000 x 2.000 (76.20 x 50.80)	96
THT-19-433	3.000 x 2.000 (76.20 x 50.80)	96
THT-19-459	3.000 x 2.000 (76.20 x 50.80)	96
THT-19-483	3.000 x 2.000 (76.20 x 50.80)	96
THT-19-484	3.000 x 2.000 (76.20 x 50.80)	96
THT-19-488	3.000 x 2.000 (76.20 x 50.80)	96
THT-19-489	3.000 x 2.000 (76.20 x 50.80)	96
XTHT-19-8423	3.000 x 2.000 (76.20 x 50.80)	96
THT-31-423	1.100 x 0.380 (27.94 x 9.65)	91
THT-37-423	1.500 x 0.500 (38.10 x 12.70)	93
THT-37-483	1.500 x 0.500 (38.10 x 12.70)	93
THT-37-489	1.500 x 0.500 (38.10 x 12.70)	93
THT-53-423	2.000 x 0.500 (50.80 x 12.70)	94
THT-55-423	4.000 x 2.000 (101.60 x 50.80)	97
THT-55-483	4.000 x 2.000 (101.60 x 50.80)	97
THT-55-484	4.000 x 2.000 (101.60 x 50.80)	97
THT-55-488	4.000 x 2.000 (101.60 x 50.80)	97
THT-55-489	4.000 x 2.000 (101.60 x 50.80)	97
XTHT-55-8423	4.000 x 2.000 (101.60 x 50.80)	97
THT-59-483	1.000 x 0.500 (25.40 x 12.70)	91
THT-59-489	1.000 x 0.500 (25.40 x 12.70)	91
THT-76-422	4.000 x 3.000 (101.60 x 76.20)	97
THT-76-483	4.000 x 3.000 (101.60 x 76.20)	97
THT-76-489	4.000 x 3.000 (101.60 x 76.20)	97
THT-79-423	2.000 x 0.400 (50.80 x 10.16)	94
THT-102-422	1.500 x 0.370 (38.10 x 9.40)	93



B-8423 material is ideal for numerous applications such as rating plates for electronic equipment.

General and Industrial Identification

▶ CONTINUOUS LABEL ROLLS

- Clear Polyolefin (B-407)
- Permanent White Polyester (B-423, B-483 & B-489)
- General-Purpose White Paper (B-424)
- Metallized Polyester (B-428)
- Translucent Polyester (B-430)
- Rough Surface Metallized Polyester (B-434, B-486)
- Flame-Retardant White or Yellow Tedlar® Film (B-437)
- Tamper-Evident Metallized Polyester (B-438)
- Colored Vinyl (B-439)

Part Number	Size Inch (mm)	Specifications on Page
THT-21-407	3.000 (76.20) x 300 ft (91.44 m)	96
THT-21-423	3.000 (76.20) x 300 ft (91.44 m)	96
THT-21-424	3.000 (76.20) x 300 ft (91.44 m)	96
THT-21-428	3.000 (76.20) x 300 ft (91.44 m)	96
THT-21-430	3.000 (76.20) x 300 ft (91.44 m)	96
THT-21-434	3.000 (76.20) x 300 ft (91.44 m)	97
THT-21-437	3.000 (76.20) x 300 ft (91.44 m)	97
THT-21-437-YL	3.000 (76.20) x 300 ft (91.44 m)	97
THT-21-438	3.000 (76.20) x 300 ft (91.44 m)	97
THT-21-483	3.000 (76.20) x 300 ft (91.44 m)	97
THT-21-486	3.000 (76.20) x 300 ft (91.44 m)	97
THT-21-489	3.000 (76.20) x 300 ft (91.44 m)	97
THT-106-423	2.000 (50.80) x 300 ft (91.44 m)	95
THT-106-428	2.000 (50.80) x 300 ft (91.44 m)	95
THT-106-439	2.000 (50.80) x 300 ft (91.44 m)	95
THT-106-483	2.000 (50.80) x 300 ft (91.44 m)	95
THT-106-486	2.000 (50.80) x 300 ft (91.44 m)	95
THT-107-423	4.000 (101.60) x 300 ft (91.44 m)	97
THT-107-428	4.000 (101.60) x 300 ft (91.44 m)	97
THT-107-439	4.000 (101.60) x 300 ft (91.44 m)	97
THT-107-483	4.000 (101.60) x 300 ft (91.44 m)	97
THT-107-486	4.000 (101.60) x 300 ft (91.44 m)	97

Tedlar® is a registered trademark of DuPont.

▶ TAG IDENTIFICATION

- Polyethylene Tag (B-109)
- Polypropylene Tag (B-412)
- Polyolefin Tag (B-411)

Part Number	Size Inch (mm)	Specifications on Page
THT-33-109	3.000 x 6.000 (76.20 x 152.40)	100
THT-33-411	3.000 x 6.000 (76.20 x 152.40)	100
THT-33-412	3.000 x 6.000 (76.20 x 152.40)	100
THT-150-412	1.938 x 0.375 (49.20 x 9.53)	93

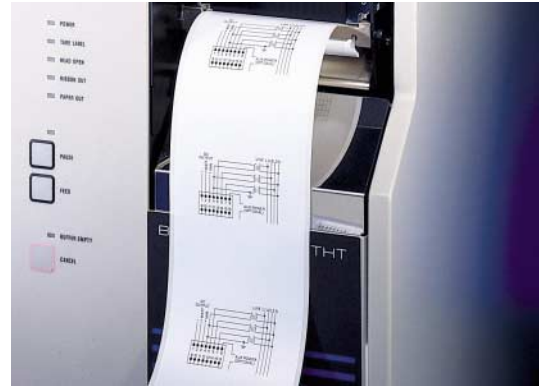

Continuous rolls are ideal for prototype labels and small quantity production runs.

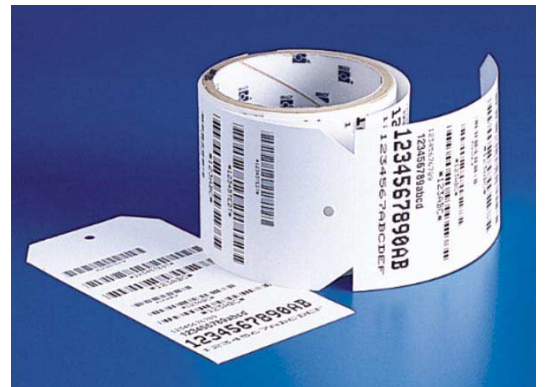

B-412 polypropylene tag material is designed for outdoor and harsh environmental applications.

► WATER INDICATING LABELS

Water Indicating Polyester/Paper (B-350, B-354)

Part Number	Size Inch (mm)	Specifications on Page
THT-6-354-10	1.500 x 0.750 (38.10 x 19.10)	93
THT-14-354-10	0.650 x 0.200 (16.50 x 5.10)	88
THT-17-354-3	2.000 x 1.000 (50.80 x 25.40)	94
THT-42-354-10	1.000 x 0.187 (25.40 x 4.80)	89
THT-43-354-10	1.250 x 0.250 (31.80 x 6.40)	91
THT-46-354-10	0.750 x 0.250 (19.10 x 6.40)	88
THT-59-354-10	1.000 x 0.500 (25.40 x 12.70)	90
THT-70-350-5	0.250 x 0.250 (6.35 x 6.35)	85
THT-70-350-20	0.250 x 0.250 (6.35 x 6.35)	85
THT-70-354-20	0.250 x 0.250 (6.35 x 6.35)	85
THT-96-354-10	0.500 x 0.275 (12.70 x 7.00)	87
THT-104-354-20	0.315 x 0.177 (8.00 x 4.50)	86
WIL-1-350-5*	0.160 diameter (4.10)	234
WIL-1-350-20*	0.160 diameter (4.10)	234
WIL-1-354-20*	0.160 diameter (4.10)	234

*The WIL parts are not provided in a format and size acceptable for thermal transfer printers. These parts are to be used only as water indicating labels.



Water indicating labels provide clear evidence of water intrusion for controlling invalid warranty claims, failure analysis, design assistance or repair troubleshooting.

► TAMPER-RESISTANT LABELS

- Tamper-Resistant White Vinyl (B-351)
- Tamper-Resistant Metallized Vinyl (B-352)
- Tamper-Resistant Clear Acetate (B-358)
- Tamper-Resistant White Acetate (B-359)

Part Number	Size Inch (mm)	Specifications on Page
THT-1-351	0.750 x 0.250 (19.05 x 6.35)	88
THT-4-351	1.500 x 0.250 (38.10 x 6.35)	90
THT-5-351	1.000 x 0.500 (25.40 x 12.70)	90
THT-5-352	1.000 x 0.500 (25.40 x 12.70)	90
THT-6-351	1.500 x 0.750 (38.10 x 19.05)	93
THT-6-352	1.500 x 0.750 (38.10 x 19.05)	93
THT-7-351	2.750 x 1.250 (69.85 x 31.75)	95
THT-7-352	2.750 x 1.250 (69.85 x 31.75)	95
THT-7-358	2.750 x 1.250 (69.85 x 31.75)	95
THT-7-359	2.750 x 1.250 (69.85 x 31.75)	95
THT-12-351	0.500 x 0.437 (12.70 x 11.10)	87
THT-14-351	0.650 x 0.200 (16.51 x 5.08)	88
THT-15-351	2.000 x 0.250 (50.80 x 6.35)	94
THT-17-351	2.000 x 1.000 (50.80 x 25.40)	94
THT-17-352	2.000 x 1.000 (50.80 x 25.40)	94
THT-17-358	2.000 x 1.000 (50.80 x 25.40)	94
THT-17-359	2.000 x 1.000 (50.80 x 25.40)	94
THT-18-351	3.000 x 1.000 (76.20 x 25.40)	95
THT-18-352	3.000 x 1.000 (76.20 x 25.40)	95



Brady offers several tamper-resistant label materials that are ideal for package seals. If desired, covert or overt security features can also be added to provide additional package protection.

Part Number	Size Inch (mm)	Specifications on Page
THT-18-358	3.000 x 1.000 (76.20 x 25.40)	95
THT-18-359	3.000 x 1.000 (76.20 x 25.40)	95
THT-19-351	3.000 x 2.000 (76.20 x 50.80)	96
THT-19-352	3.000 x 2.000 (76.20 x 50.80)	96
THT-19-358	3.000 x 2.000 (76.20 x 50.80)	96
THT-19-359	3.000 x 2.000 (76.20 x 50.80)	96
THT-37-351	1.500 x 0.500 (38.10 x 12.70)	93
THT-37-352	1.500 x 0.500 (38.10 x 12.70)	93
THT-39-358	1.000 x 0.500 (25.40 x 12.70)	90
THT-53-351	2.000 x 0.500 (50.80 x 12.70)	94
THT-53-352	2.000 x 0.500 (50.80 x 12.70)	94
THT-59-351	1.000 x 0.500 (25.40 x 12.70)	90
THT-59-352	1.000 x 0.500 (25.40 x 12.70)	90
THT-59-359	1.000 x 0.500 (25.40 x 12.70)	90
THT-99-359	0.500 x 0.500 (12.70 x 12.70)	87
THT-147-358	1.500 x 0.375 (38.10 x 9.50)	93
THT-147-359	1.500 x 0.375 (38.10 x 9.50)	93
THT-149-358	0.500 x 0.500 (12.70 x 12.70)	87s

Security Identification

► TAMPER-EVIDENT LABELS

Tamper-Evident Metallized Polyester (B-438)

Tamper-Evident White Polyester (B-7546)

Tamper-Evident Clear Polyester (B-7566)

Tamper-Evident Silver Polyester (B-7576)

Part Number	Size Inch (mm)	Specifications on Page
THT-1-438	0.750 x 0.250 (19.05 x 6.35)	88
THT-5-438	1.000 x 0.500 (25.40 x 12.70)	90
THT-5-7546	1.000 x 0.500 (25.40 x 12.70)	91
THT-5-7576	1.000 x 0.500 (25.40 x 12.70)	91
THT-6-438	1.500 x 0.750 (38.10 x 19.05)	93
THT-6-7546	1.500 x 0.750 (38.10 x 19.05)	93
THT-6-7576	1.500 x 0.750 (38.10 x 19.05)	93
THT-7-438	2.750 x 1.250 (69.85 x 31.75)	95
THT-7-7546	2.750 x 1.250 (69.85 x 31.75)	95
THT-7-7566	2.750 x 1.250 (69.85 x 31.75)	95
THT-7-7576	2.750 x 1.250 (69.85 x 31.75)	85
THT-12-438	0.500 x 0.437 (12.70 x 11.10)	87
THT-14-438	0.650 x 0.200 (16.51 x 5.08)	88
THT-17-438	2.000 x 1.000 (50.80 x 25.40)	94
THT-17-7546	2.000 x 1.000 (50.80 x 25.40)	95
THT-17-7566	2.000 x 1.000 (50.80 x 25.40)	95
THT-17-7576	2.000 x 1.000 (50.80 x 25.40)	95
THT-18-438	3.000 x 1.000 (76.20 x 25.40)	96
THT-18-7546	3.000 x 1.000 (76.20 x 25.40)	96
THT-18-7566	3.000 x 1.000 (76.20 x 25.40)	96
THT-18-7576	3.000 x 1.000 (76.20 x 25.40)	96
THT-19-438	3.000 x 2.000 (76.20 x 50.80)	96
THT-19-7546	3.000 x 2.000 (76.20 x 50.80)	96
THT-19-7576	3.000 x 2.000 (76.20 x 50.80)	96
THT-21-438	3.000 x 30 ft (76.20 x 9.10 m)	97
THT-37-438	1.500 x 0.500 (38.10 x 12.70)	93
THT-37-7546	1.500 x 0.500 (38.10 x 12.70)	93
THT-37-7576	1.500 x 0.500 (38.10 x 12.70)	93
THT-39-7566	1.000 x 0.500 (25.40 x 12.70)	91
THT-53-438	2.000 x 0.500 (50.80 x 12.70)	94
THT-53-7546	2.000 x 0.500 (50.80 x 12.70)	94
THT-53-7576	2.000 x 0.500 (50.80 x 12.70)	94
THT-59-438	1.000 x 0.500 (25.40 x 12.70)	91
THT-59-7546	1.000 x 0.500 (25.40 x 12.70)	91
THT-59-7576	1.000 x 0.500 (25.40 x 12.70)	91
THT-147-7566	1.500 x 0.375 (38.10 x 9.50)	93
THT-149-7566	0.500 x 0.500 (12.70 x 12.70)	87



Tamper-evident labels are ideal for warranty fraud protection. They're designed to leave a footprint when the label is removed. In addition, a pattern will appear on the top surface of the label in order to prevent it from being reused.

All Brady ribbons are developed to meet the performance requirements of the materials to be printed. The reason for this is that the bond between the ribbon and the label is critical to the success of the legend permanence. Brady offers a complete line of ribbons that are designed to cover all your label application requirements.

Please refer to Ribbon/Material Cross Reference Chart on the following page to determine the appropriate ribbon/material combination.

Ribbon Series	Formulation	Available Colors	Performance Characteristics
R4300	Wax/Resin	Black	Strong environmental resistance against smearing and chemicals. Also, reliable, sharp-edge print quality to maximize bar code readability.
R4400	Resin	Red, Blue, Green & White	High density, excellent solvent resistance, high heat resistance, super scratch resistance.
R4500	Wax/Resin	Red, Blue & Green	Strong environmental resistance against smearing and chemicals. Also, reliable, sharp-edge print quality to maximize bar code readability.
R4800	Resin	Black	Excellent solvent and scratch resistance. High heat resistance.
R4900	Resin	Black	Superb smear resistance at high temperatures. Superior solvent resistance.
R6000	Resin	Black	High density, excellent solvent resistance, high heat resistant, super scratch resistance.
R6100	Wax	Black	Outstanding durability for a general purpose ribbon. Reduced printhead energy requirements.
R6200	Resin	Black	Designed for harsh environment labeling applications. Superior abrasion, chemical, and heat resistance.
R6300	Resin	Black	Strong environmental resistance against chemicals and washes. Excellent heat resistance.

Ribbon / Width Cross-Reference Guide

	Widths	Series 4300	Series 4400* (colors)	Series 4500* (colors)	Series 4800	Series 4900	Series 6000	Series 6100	Series 6200	Series 6300
A	0.800" x 984'				R4811		R6011		R6211	
	1.000" x 984'	R4311								
	1.570" x 984'	R4306			R4806		R6006**		R6206	
	2.360" x 984'	R4302	R4400	R4500	R4800	R4902	R6000	R6100	R6200	
	3.270" x 984'	R4300	R4402	R4502	R4802	R4900	R6002**	R6102	R6202	R6302
	4.330" x 984'	R4307	R4407		R4807		R6007**	R6107	R6207	
	5.120" x 984'	R4304	R4404			R4904	R6004	R6104		
6.850" x 984'	R4308				R4908	R6008		R6208		
B	4.000" x 360'	R4301				R4901	R6001	R6101	R6201	
C	1.570" x 500'	R4303					R6003**	R6103		
	2.360" x 500'	R4305					R6005	R6105		
	4.330" x 500'	R4309					R6009**	R6109		

A- Ribbons for standard Brady printers, core ID 1.000", ink side out
 B- THT Model 1024, THT Model 1244 and THT Model 1344, core ID 0.500", ink side in
 C- Ribbons for THT Model 4042 and Intermec 3440 printers, core ID 1.000", ink side out

* The Series 4400 and 4500 ribbons are offered in the following colors: Red, Blue, Green, White (R4400 only) and Silver (R4500 only).

**The Series 6000 ribbons marked with double asterisks are available on fiber or plastic cores for clean room applications. (example: R6006 and R6006PC)

FYI

How to find out how many labels per THT ribbon:

Our THT ribbons are 984 feet long.

984 ft x 12 inches = 11,808 inches
 11,808 divided by label vertical repeat = labels per ribbon.

To find your vertical repeat, see Index starting on page 84. Use column D for your vertical repeat.

Ribbon / Material Cross-Reference Guide

RIBBON / MATERIAL CROSS-REFERENCE GUIDE THERMAL TRANSFER LABELS

B#'s	Material	Series 4300	Series 4400 (colors)	Series 4500 (colors)	Series 4800	Series 4900	Series 6000	Series 6100	Series 6200	Series 6300
109	Tag	●							△	
341	PermaSleeve™	●								
342	PermaSleeve	●								
350	Polyester/Paper		△			△	●			
351	Vinyl	△							●	
352	Vinyl						● UL			
402	Paper	△		△				●		
407	Polyolefin					△			●	
408	Paper	△		△				●		
411	Tag	●								
412	Tag	△							●	
422	Polyester		△			△ UL/CSA	● UL/CSA		△	
423	Polyester		△			△ UL/CSA	● UL/CSA/AGA		△	
424	Paper	●		△				△		
426	Polyimide	●								
427	Vinyl	● UL		△					△ UL	
428	Polyester	● UL/CSA/AGA		△					△ CSA	
430	Polyester		△			△ UL/CSA	● UL/CSA		△	
432	Polyester		△			△ UL/CSA	● UL/CSA		△	
433	Polyester		△			△ UL	●		△	
434	Polyester				△ UL/CSA	△ UL/CSA	● UL/CSA		△	
435	Polyester					△ UL	● UL/CSA/AGA		△	
436	Polyimide	●								
437	Tedlar	●							△	
438	Polyester	● UL		△						
439	Vinyl		△			△	●		△	
449	Polyolefin								●	
457	Polyimide						● UL			
459	Polyester		△ UL			△ UL/CSA	● UL/CSA			
461	Polyester	●		△					△	
464	Polyester						●			
473	Polyester					△ UL	● UL/CSA		△	
477	Polyimide						● UL			
478	Polyimide						● UL			
479	Polyimide				△ UL		● UL			
483	Polyester		△			△ UL	● UL/CSA		△	
484	Polyester		△			△ UL	● UL/CSA*			
486	Polyester	● UL/CSA		△					△ CSA	
487	Polyimide				△ UL		● UL			
488	Polyester	● UL/CSA/AGA							△ UL/CSA	
489	Polyester	● UL/CSA							△ UL/CSA	
495	PEN						● UL			
497	Polyimide				△ UL		● UL			
498	Vinyl Cloth	△			△ UL		● UL		● UL	
499	Nylon	△ UL		△		● UL	△		△	
520	Glass Cloth									●
7546	Polyester		△				● UL/CSA			
7576	Polyester		△				● UL			
8423	Polyester		△				△ UL*/CSA*		● UL*/CSA*	
8425	Polyolefin		△						●	

●	Recommended ribbon for use with respective material.
△	Acceptable ribbon for use with respective material.
*UL	These materials are now in UL testing.
UL	These materials are UL recognized with its respective ribbon.
*CSA	These materials are now in CSA testing.
CSA	These materials are CSA approved with its respective ribbon.
UL/CSA	These materials are UL & CSA approved with its respective ribbon.
AGA	These materials are AGA approved.

All Brady ribbons are developed to meet the performance requirements of the materials to be printed. The reason for this is the bond between the ribbon and the label is critical to the success of the legend permanence. Brady offers a complete line of ribbons that are designed to cover all your label application requirements.

Laser Labels

Laser Printable Materials Chart 126

Label Index by Part Number 127

Label Index by Size 128

Labels by Application

Circuit Board and
Component Identification 133

Wire and Cable Marking 136



Data Communications
Equipment and Cabling 137

General Identification 117

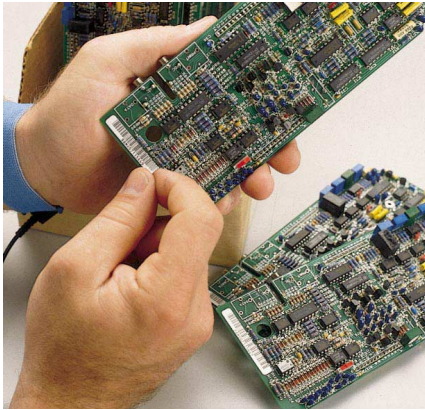
Laser Printable Materials Chart





The high resolution of laser printing makes it possible to generate readable, dense bar codes on labels small enough to fit into limited application space. (B-747 pictured)

Type	Max. Service Temp. °F (°C)	Color	Finish	Use	Special Properties
NYLON CLOTH					
B-799	293 (145)*	White	Matte	Aerospace and military cable marking	Repositionable
PAPER					
B-124	150 (66)	White/Colors	Matte	110 terminal block marking for telecommunications	Available in green, purple, yellow, blue, red, brown, white, orange and gray
B-759	193 (90)	White/Colors	Matte	Bar code and general labeling applications	Excellent toner adhesion
POLYOLEFIN FILM					
B-409	193 (90)	White	Matte	Bar code labels and general identification	Abrasion resistant
B-410	212 (100)	White	Matte	Tamper-evident label	Label destroys upon removal
POLYESTER					
B-361	230 (110)	White	Matte	Wire and cable marking, self-laminating	Low halogen and sulfur content
B-707	267 (130)	White	Matte	Electronic component labeling; general identification	Rough surface application; Stronger bond to low surface energy plastics 
B-709	158 (70)	White	Matte	Electronic component, bar code labels and general temporary identification	Removable
B-712	221 (105)	Clear	Matte	Electronic component labeling; general identification	Rough surface application; Stronger bond to low surface energy plastics
B-722	221 (105)	Clear	Matte	Rating plates, name plates, general-purpose printable overlaminates	Translucent
B-747	267 (130)	White/Yellow	Matte	Electronic PCB component, bar code labels and equipment labeling	Excellent solvent and smudge resistance; high-resolution printing; available in white only 
B-773	248 (120)	Silver	Matte	Rating plates and electronic component marking	Adheres to a variety of surfaces; metallized 
POLYIMIDE					
B-652	572 (300)*	Amber	Matte	Underside PC board and SMT component marking	Withstands extremely high temperatures
B-658	518 (270)*	Amber	Matte	SMT component marking	Label will remove cleanly after high temperature exposure
TEDLAR®					
B-737	266 (130)	White	Matte	Aerospace and military cable marking	Repositionable

Tedlar® is a registered trademark of DuPont.

* 5 minutes

 *These materials are UL recognized.
 *These materials are CSA approved.

*Refer to the full page charts on pages 280-281 for more information and complete listing of parts.

► LAT SERIES LASERTAB LASER-PRINTABLE LABELS

Part Number	Size Inch (mm)	Specifications on Page	Part Number	Size Inch (mm)	Specifications on Page	Part Number	Size Inch (mm)	Specifications on Page
LAT-1-652	0.300 x 0.250 (762 x 6.35)	128	LAT-13-722	1.875 x 0.833 (4763 x 2116)	130	LAT-40-799	0.500 x 0.750 (1270 x 19.05)	128
LAT-1-747	0.300 x 0.250 (762 x 6.35)	128	LAT-13-747	1.875 x 0.833 (4763 x 2116)	130	LAT-41-707	1.500 x 0.375 (3810 x 9.53)	129
LAT-2-652	0.375 x 0.3750 (9.53 x 9.53)	128	LAT-13-747-YL	1.875 x 0.833 (4763 x 2116)	130	LAT-41-712	1.500 x 0.375 (3810 x 9.53)	129
LAT-2-747	0.375 x 0.3750 (9.53 x 9.53)	128	LAT-13-759	1.875 x 0.833 (4763 x 2116)	130	LAT-42-707	0.560 x 0.560 (14.22 x 14.22)	128
LAT-3-410	0.650 x 0.250 (16.51 x 6.35)	128	LAT-14-747	1.875 x 1.330 (4763 x 33.78)	130	LAT-42-712	0.560 x 0.560 (14.22 x 14.22)	128
LAT-3-652	0.650 x 0.250 (16.51 x 6.35)	128	LAT-15-361	0.500 x 0.750 (12.70 x 19.05)	131	LAT-43-707	2.875 x 0.375 (73.02 x 9.53)	130
LAT-3-747	0.650 x 0.250 (16.51 x 6.35)	128	LAT-16-361	1.000 x 0.750 (25.40 x 19.05)	131	LAT-44-707	3.600 x 0.375 (91.44 x 9.53)	130
LAT-4-410	0.800 x 0.250 (20.32 x 6.35)	129	LAT-17-361	1.000 x 1.000 (25.40 x 25.40)	131	LAT-45-707	0.500 x 0.375 (12.70 x 9.53)	128
LAT-4-652	0.800 x 0.250 (20.32 x 6.35)	129	LAT-18-361	1.000 x 1.330 (25.40 x 33.78)	131	LAT-45-712	0.500 x 0.375 (12.70 x 9.53)	128
LAT-4-737	0.800 x 0.250 (20.32 x 6.35)	129	LAT-19-361	1.000 x 3.167 (25.40 x 80.44)	131	LAT-46-707	0.500 x 0.500 (12.70 x 12.70)	128
LAT-4-747	0.800 x 0.250 (20.32 x 6.35)	129	LAT-20-773	1.500 x 0.750 (38.10 x 19.05)	129	LAT-46-712	0.500 x 0.500 (12.70 x 12.70)	128
LAT-4-747-YL	0.800 x 0.250 (20.32 x 6.35)	129	LAT-21-707	2.500 x 1.000 (63.50 x 25.40)	130	LAT-47-707	1.500 x 0.500 (38.10 x 12.70)	129
LAT-5-652	0.800 x 0.500 (20.32 x 12.70)	129	LAT-21-712	2.500 x 1.000 (63.50 x 25.40)	130	LAT-47-712	1.500 x 0.500 (38.10 x 12.70)	129
LAT-5-747	0.800 x 0.500 (20.32 x 12.70)	129	LAT-21-747	2.500 x 1.000 (63.50 x 25.40)	130	LAT-48-361	0.500 x 1.000 (12.70 x 25.40)	131
LAT-5-747-YL	0.800 x 0.500 (20.32 x 12.70)	129	LAT-21-747-YL	2.500 x 1.000 (63.50 x 25.40)	130	LAT-49-361	0.500 x 1.250 (12.70 x 31.75)	131
LAT-5-759	0.800 x 0.500 (20.32 x 12.70)	129	LAT-21-773	2.500 x 1.000 (63.50 x 25.40)	130	LAT-50-361	0.750 x 1.000 (19.05 x 25.40)	131
LAT-6-652	1.000 x 0.250 (25.40 x 6.35)	129	LAT-22-361	0.500 x 1.500 (12.70 x 38.10)	131	LAT-51-361	0.750 x 1.500 (19.05 x 38.10)	131
LAT-6-747	1.000 x 0.250 (25.40 x 6.35)	129	LAT-23-747	1.000 x 0.500 (25.40 x 12.70)	131	LAT-52-361	1.500 x 1.000 (38.10 x 25.40)	131
LAT-7-410	1.000 x 0.500 (25.40 x 12.70)	129	LAT-23-773	1.000 x 0.500 (25.40 x 12.70)	131	LAT-53-361	1.500 x 1.500 (38.10 x 38.10)	131
LAT-7-652	1.000 x 0.500 (25.40 x 12.70)	129	LAT-24-747	1.750 x 1.000 (44.45 x 25.40)	131	LAT-54-361	1.750 x 1.000 (44.45 x 25.40)	131
LAT-7-707	1.000 x 0.500 (25.40 x 12.70)	129	LAT-24-773	1.750 x 1.000 (44.45 x 25.40)	131	LAT-55-361	1.750 x 1.500 (44.45 x 38.10)	131
LAT-7-709	1.000 x 0.500 (25.40 x 12.70)	129	LAT-25-652	0.500 x 0.437 (12.70 x 11.10)	128	LAT-56-361	0.600 x 1.625 (15.24 x 41.28)	131
LAT-7-712	1.000 x 0.500 (25.40 x 12.70)	129	LAT-25-709	0.500 x 0.437 (12.70 x 11.10)	128	LAT-57-361	0.375 x 1.800 (45.72 x 9.53)	131
LAT-7-722	1.000 x 0.500 (25.40 x 12.70)	129	LAT-25-747	0.500 x 0.437 (12.70 x 11.10)	128	LAT-58-361	1.000 x 2.625 (25.40 x 66.68)	131
LAT-7-737	1.000 x 0.500 (25.40 x 12.70)	129	LAT-26-652	0.250 x 0.250 (6.35 x 6.35)	128	LAT-59-361	0.600 x 2.625 (15.24 x 66.68)	131
LAT-7-737-YL	1.000 x 0.500 (25.40 x 12.70)	129	LAT-26-747	0.250 x 0.250 (6.35 x 6.35)	128	LAT-60-799	1.000 diameter (25.40)	128
LAT-7-747	1.000 x 0.500 (25.40 x 12.70)	129	LAT-27-361	1.875 x 3.167 (47.63 x 80.44)	131	LAT-61-799	0.500 diameter (12.70)	128
LAT-7-747-YL	1.000 x 0.500 (25.40 x 12.70)	129	LAT-28-409	8.500 x 11.000 (215.90 x 279.40)	132	LAT-175-124	3.062 x 0.500 (77.77 x 12.70)	130
LAT-7-773	1.000 x 0.500 (25.40 x 12.70)	129	LAT-28-722	8.500 x 11.000 (215.90 x 279.40)	132	LAT-175-124-BL	3.062 x 0.500 (77.77 x 12.70)	130
LAT-7-799	1.000 x 0.500 (25.40 x 12.70)	129	LAT-28-747	8.500 x 11.000 (215.90 x 279.40)	132	LAT-175-124-BR	3.062 x 0.500 (77.77 x 12.70)	130
LAT-8-409	1.000 x 0.375 (25.40 x 9.53)	129	LAT-28-747-YL	8.500 x 11.000 (215.90 x 279.40)	132	LAT-175-124-GR	3.062 x 0.500 (77.77 x 12.70)	130
LAT-8-652	1.000 x 0.375 (25.40 x 9.53)	129	LAT-28-773	8.500 x 11.000 (215.90 x 279.40)	132	LAT-175-124-GY	3.062 x 0.500 (77.77 x 12.70)	130
LAT-8-707	1.000 x 0.375 (25.40 x 9.53)	129	LAT-29-652	0.650 x 0.200 (16.51 x 5.08)	128	LAT-175-124-OR	3.062 x 0.500 (77.77 x 12.70)	130
LAT-8-712	1.000 x 0.375 (25.40 x 9.53)	129	LAT-29-737	0.650 x 0.200 (16.51 x 5.08)	128	LAT-175-124-PL	3.062 x 0.500 (77.77 x 12.70)	130
LAT-8-747	1.000 x 0.375 (25.40 x 9.53)	129	LAT-29-747	0.650 x 0.200 (16.51 x 5.08)	128	LAT-175-124-RD	3.062 x 0.500 (77.77 x 12.70)	130
LAT-8-747-YL	1.000 x 0.375 (25.40 x 9.53)	129	LAT-29-747-YL	0.650 x 0.200 (16.51 x 5.08)	128	LAT-175-124-YL	3.062 x 0.500 (77.77 x 12.70)	130
LAT-8-799	1.000 x 0.375 (25.40 x 38.10)	129	LAT-29-799	0.650 x 0.200 (15.51 x 5.08)	128	LAT-176-124	1.975 x 0.375 (50.17 x 9.53)	132
LAT-9-409	1.500 x 0.250 (38.10 x 6.35)	129	LAT-30-737	1.250 x 0.375 (31.75 x 9.53)	129	LAT-177-124	7.906 x 0.475 (200.81 x 12.07)	132
LAT-9-652	1.500 x 0.250 (38.10 x 6.35)	129	LAT-30-737-YL	1.250 x 0.375 (31.75 x 9.53)	129	LAT-177-124-BL	7.906 x 0.475 (200.81 x 12.07)	132
LAT-9-709	1.500 x 0.250 (38.10 x 6.35)	129	LAT-31-707	2.000 x 0.900 (50.80 x 22.86)	130	LAT-177-124-BR	7.906 x 0.475 (200.81 x 12.07)	132
LAT-9-747	1.500 x 0.250 (38.10 x 6.35)	129	LAT-31-747	2.000 x 0.900 (50.80 x 22.86)	130	LAT-177-124-GR	7.906 x 0.475 (200.81 x 12.07)	132
LAT-9-747-YL	1.500 x 0.250 (38.10 x 6.35)	129	LAT-31-759	2.000 x 0.900 (50.80 x 22.86)	130	LAT-177-124-GY	7.906 x 0.475 (200.81 x 12.07)	132
LAT-9-799	1.500 x 0.250 (38.10 x 6.35)	129	LAT-32-747	3.000 x 0.900 (76.20 x 22.86)	130	LAT-177-124-OR	7.906 x 0.475 (200.81 x 12.07)	132
LAT-10-652	1.875 x 0.250 (47.63 x 6.35)	130	LAT-32-759	3.000 x 0.900 (76.20 x 22.86)	130	LAT-177-124-PL	7.906 x 0.475 (200.81 x 12.07)	132
LAT-10-747	1.875 x 0.250 (47.63 x 6.35)	130	LAT-33-707	2.000 x 1.437 (50.80 x 36.50)	130	LAT-177-124-RD	7.906 x 0.475 (200.81 x 12.07)	132
LAT-11-409	1.875 x 0.375 (47.63 x 9.53)	130	LAT-33-747	2.000 x 1.437 (50.80 x 36.50)	130	LAT-177-124-YL	7.906 x 0.475 (200.81 x 12.07)	132
LAT-11-747	1.875 x 0.375 (47.63 x 9.53)	130	LAT-33-759	2.000 x 1.437 (50.80 x 36.50)	130	LAT-178-759	6.625 x 0.625 (168.28 x 15.86)	130
LAT-11-747-YL	1.875 x 0.375 (47.63 x 9.53)	130	LAT-34-707	3.000 x 1.437 (76.20 x 36.50)	130	LAT-178-759-BL	6.625 x 0.625 (168.28 x 15.86)	130
LAT-12-652	3.000 x 0.375 (76.20 x 9.53)	130	LAT-34-747	3.000 x 1.437 (76.20 x 36.50)	130	LAT-178-759-BR	6.625 x 0.625 (168.28 x 15.86)	130
LAT-12-709	3.000 x 0.375 (76.20 x 9.53)	130	LAT-34-759	3.000 x 1.437 (76.20 x 36.50)	130	LAT-178-759-GR	6.625 x 0.625 (168.28 x 15.86)	130
LAT-12-747	3.000 x 0.375 (76.20 x 9.53)	130	LAT-35-361	1.200 x 1.500 (30.48 x 38.10)	131	LAT-178-759-GY	6.625 x 0.625 (168.28 x 15.86)	130
LAT-12-747-YL	3.000 x 0.375 (76.20 x 9.53)	130	LAT-36-773	1.600 x 0.375 (40.64 x 9.62)	130	LAT-178-759-OR	6.625 x 0.625 (168.28 x 15.86)	130
LAT-13-409	1.875 x 0.833 (47.63 x 21.16)	130	LAT-37-799	0.800 x 1.437 (20.32 x 36.50)	129	LAT-178-759-PL	6.625 x 0.625 (168.28 x 15.86)	130
LAT-13-410	1.875 x 0.833 (47.63 x 21.16)	130	LAT-38-799	0.500 x 1.437 (12.70 x 36.50)	128	LAT-178-759-RD	6.625 x 0.625 (168.28 x 15.86)	130
LAT-13-707	1.875 x 0.833 (47.63 x 21.16)	130	LAT-39-361	1.000 x 1.437 (25.40 x 36.50)	131	LAT-178-759-YL	6.625 x 0.625 (168.28 x 15.86)	130
LAT-13-712	1.875 x 0.833 (47.63 x 21.16)	130	LAT-39-799	1.000 x 1.437 (25.40 x 36.50)	129			

Label Index by Size

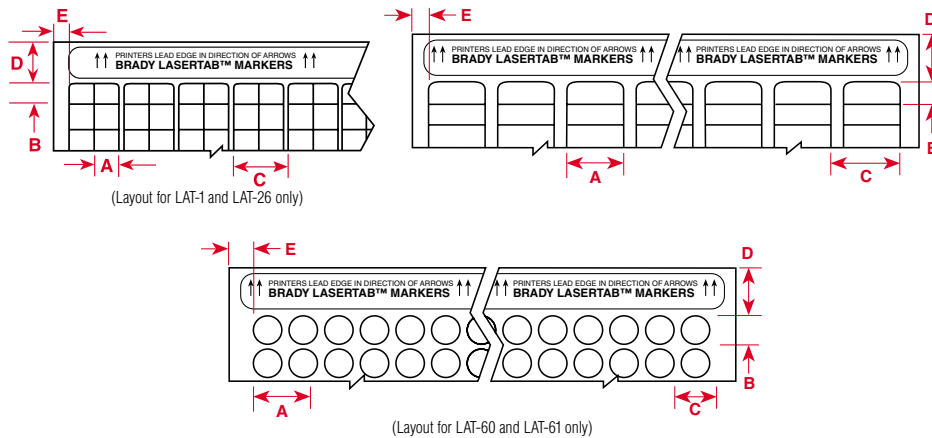

LAT-26-652-10

- Laser Printable Technology
- Die # 26, 0.250" x 0.250" Rating Plate
- Material B-652, Amber Polyimide
- Package Quantity, 10,000

PART NUMBER EXPLANATION:

Most Brady part numbers for computer printable labels follow the same four-part format: The first code indicates the technology, the second part is a number indicating the die size used (where applicable), the third part indicates the Brady material used (where applicable), and the final code indicates package quantity.

Part Number	Pieces Per Package	Material	Color	Labels Per Row	Label Width Inch (mm) A	Label Height Inch (mm) B	Horizontal Repeat Inch (mm) C	Top Margin Inch (mm) D	Left Margin Inch (mm) E	Labels Per Sheet
0.250" Label Width										
LAT-26-652-10	10,000	Polyimide	Amber	26	0.250 (6.35)	0.250 (6.35)	0.600 (15.24)	0.875 (22.23)	0.400 (10.16)	936
LAT-26-747-10	10,000	Polyester	White	26	0.250 (6.35)	0.250 (6.35)	0.600 (15.24)	0.875 (22.23)	0.400 (10.16)	936
0.300" Label Width										
LAT-1-652-10	10,000	Polyimide	Amber	22	0.300 (7.62)	0.250 (6.35)	0.700 (17.78)	0.875 (22.23)	0.450 (11.43)	836
LAT-1-747-10	10,000	Polyester	White	22	0.300 (7.62)	0.250 (6.35)	0.700 (17.78)	0.875 (22.23)	0.450 (11.43)	836
0.375" Label Width										
LAT-2-652-10	10,000	Polyimide	Amber	16	0.375 (9.53)	0.375 (9.53)	0.500 (12.70)	0.875 (22.23)	0.313 (7.95)	400
LAT-2-747-10	10,000	Polyester	White	16	0.375 (9.53)	0.375 (9.53)	0.500 (12.70)	0.875 (22.23)	0.313 (7.95)	400
LAT-60-799-2.5	2,500	Nylon Cloth	White	15	0.375 (9.53)	1.000 (25.40)	0.500 (12.70)	0.875 (22.23)	0.550 (13.97)	285
0.500" Label Width										
LAT-45-707-10	10,000	Polyester	White	13	0.500 (12.70)	0.375 (9.53)	0.600 (15.24)	0.875 (22.23)	0.400 (10.16)	325
LAT-45-712-10	10,000	Polyester	Clear	13	0.500 (12.70)	0.375 (9.53)	0.600 (15.24)	0.875 (22.23)	0.400 (10.16)	325
LAT-25-652-10	10,000	Polyimide	Amber	13	0.500 (12.70)	0.437 (11.10)	0.600 (15.24)	0.875 (22.23)	0.400 (10.16)	286
LAT-25-709-10	10,000	Removable Polyester	White	13	0.500 (12.70)	0.437 (11.10)	0.600 (15.24)	0.875 (22.23)	0.400 (10.16)	286
LAT-25-747-10	10,000	Polyester	White	13	0.500 (12.70)	0.437 (11.10)	0.600 (15.24)	0.875 (22.23)	0.400 (10.16)	286
LAT-46-707-10	10,000	Polyester	White	13	0.500 (12.70)	0.500 (12.70)	0.600 (15.24)	0.875 (22.23)	0.400 (10.16)	247
LAT-46-712-10	10,000	Polyester	Clear	13	0.500 (12.70)	0.500 (12.70)	0.600 (15.24)	0.875 (22.23)	0.400 (10.16)	247
LAT-61-799-2.5	2,500	Nylon Cloth	White	12	0.500 (12.70)	0.500 (12.70)	0.600 (15.24)	0.875 (22.23)	0.700 (17.78)	192
LAT-40-799-1,-5	1,000/5,000	Nylon Cloth	White	13	0.500 (12.70)	0.750 (19.05)	0.600 (15.24)	0.875 (22.23)	0.400 (10.16)	156
LAT-38-799-1,-2.5	1,000/2,500	Nylon Cloth	White	13	0.500 (12.70)	1.437 (36.50)	0.600 (15.24)	0.875 (22.23)	0.300 (7.62)	78
0.560" Label Width										
LAT-42-707-10	10,000	Polyester	Clear	17	0.560 (14.22)	0.560 (14.22)	0.700 (17.78)	0.875 (22.23)	0.470 (11.94)	187
LAT-42-712-10	10,000	Polyester	Clear	17	0.560 (14.22)	0.560 (14.22)	0.700 (17.78)	0.875 (22.23)	0.470 (11.94)	187
0.650" Label Width										
LAT-3-410-10	10,000	Polyolefin	White	10	0.650 (16.51)	0.250 (6.35)	0.800 (20.32)	0.875 (22.23)	0.325 (8.26)	380
LAT-3-652-10	10,000	Polyimide	Amber	10	0.650 (16.51)	0.250 (6.35)	0.800 (20.32)	0.875 (22.23)	0.325 (8.26)	380
LAT-3-747-10	10,000	Polyester	White	10	0.650 (16.51)	0.250 (6.35)	0.800 (20.32)	0.875 (22.23)	0.325 (8.26)	380
LAT-29-652-10	10,000	Polyimide	Amber	10	0.650 (16.51)	0.200 (5.08)	0.800 (20.32)	0.875 (22.23)	0.325 (8.26)	480
LAT-29-737-10	10,000	Tedlar®	White	10	0.650 (16.51)	0.200 (5.08)	0.800 (20.32)	0.875 (22.23)	0.325 (8.26)	480
LAT-29-747-10-YL	10,000	Polyester	Yellow	10	0.650 (16.51)	0.200 (5.08)	0.800 (20.32)	0.875 (22.23)	0.325 (8.26)	480
LAT-29-747-10	10,000	Polyester	White	10	0.650 (16.51)	0.200 (5.08)	0.800 (20.32)	0.875 (22.23)	0.325 (8.26)	480
LAT-29-799-10	10,000	Nylon Cloth	White	10	0.650 (16.51)	0.200 (5.08)	0.800 (20.32)	0.875 (22.23)	0.325 (8.26)	480

Tedlar® is a registered trademark of DuPont.

Note: Labels in chart are sorted in order by width, height, 3 digit material number (within part number), then die number (within part number).

LABEL INDEX BY SIZE LASER LABELS

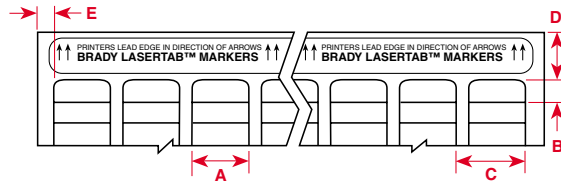

Part Number	Pieces Per Package	Material	Color	Labels Per Row	Label Width Inch (mm) A	Label Height Inch (mm) B	Horizontal Repeat Inch (mm) C	Top Margin Inch (mm) D	Left Margin Inch (mm) E	Labels Per Sheet
0.800" Label Width										
LAT-4-410-10	10,000	Polyolefin	White	8	0.800 (20.32)	0.250 (6.35)	1.000 (25.40)	0.875 (22.23)	0.350 (8.89)	304
LAT-4-652-10	10,000	Polyimide	Amber	8	0.800 (20.32)	0.250 (6.35)	1.000 (25.40)	0.875 (22.23)	0.350 (8.89)	304
LAT-4-737-10	10,000	Tedlar	White	8	0.800 (20.32)	0.250 (6.35)	1.000 (25.40)	0.875 (22.23)	0.350 (8.89)	304
LAT-4-747-10	10,000	Polyester	White	8	0.800 (20.32)	0.250 (6.35)	1.000 (25.40)	0.875 (22.23)	0.350 (8.89)	304
LAT-4-747-10-YL	10,000	Polyester	Yellow	8	0.800 (20.32)	0.250 (6.35)	1.000 (25.40)	0.875 (22.23)	0.350 (8.89)	304
LAT-5-652-10	10,000	Polyimide	Amber	8	0.800 (20.32)	0.500 (12.70)	1.000 (25.40)	0.875 (22.23)	0.350 (8.89)	152
LAT-5-747-10	10,000	Polyester	White	8	0.800 (20.32)	0.500 (12.70)	1.000 (25.40)	0.875 (22.23)	0.350 (8.89)	152
LAT-5-747-10-YL	10,000	Polyester	Yellow	8	0.800 (20.32)	0.500 (12.70)	1.000 (25.40)	0.875 (22.23)	0.350 (8.89)	152
LAT-5-759-10	10,000	Paper	White	8	0.800 (20.32)	0.500 (12.70)	1.000 (25.40)	0.875 (22.23)	0.350 (8.89)	152
LAT-37-799-1,-2,5	1,000/2,500	Nylon Cloth	White	9	0.800 (20.32)	1.437 (36.50)	0.900 (22.86)	0.875 (22.23)	0.300 (7.62)	54
1.000" Label Width										
LAT-6-652-10	10,000	Polyimide	Amber	7	1.000 (25.40)	0.250 (6.35)	1.100 (27.94)	0.875 (22.23)	0.450 (11.43)	266
LAT-6-747-10	10,000	Polyester	White	7	1.000 (25.40)	0.250 (6.35)	1.100 (27.94)	0.875 (22.23)	0.450 (11.43)	266
LAT-8-409-10	10,000	Polyolefin	White	7	1.000 (25.40)	0.375 (9.53)	1.100 (27.94)	0.875 (22.23)	0.450 (11.43)	175
LAT-8-652-10	10,000	Polyimide	Amber	7	1.000 (25.40)	0.375 (9.53)	1.100 (27.94)	0.875 (22.23)	0.450 (11.43)	175
LAT-8-707-10	10,000	Polyester	White	7	1.000 (25.40)	0.375 (9.53)	1.100 (27.94)	0.875 (22.23)	0.450 (11.43)	175
LAT-8-712-10	10,000	Polyester	Clear	7	1.000 (25.40)	0.375 (9.53)	1.100 (27.94)	0.875 (22.23)	0.450 (11.43)	175
LAT-8-747-10	10,000	Polyester	White	7	1.000 (25.40)	0.375 (9.53)	1.100 (27.94)	0.875 (22.23)	0.450 (11.43)	175
LAT-8-747-10-YL	10,000	Polyester	Yellow	7	1.000 (25.40)	0.375 (9.53)	1.100 (27.94)	0.875 (22.23)	0.450 (11.43)	175
LAT-8-799-10	10,000	Nylon Cloth	White	7	1.000 (25.40)	0.375 (9.53)	1.100 (27.94)	0.875 (22.23)	0.450 (11.43)	175
LAT-7-410-10	10,000	Polyolefin	White	7	1.000 (25.40)	0.500 (12.70)	1.100 (27.94)	0.875 (22.23)	0.450 (11.43)	133
LAT-7-652-10	10,000	Polyimide	Amber	7	1.000 (25.40)	0.500 (12.70)	1.100 (27.94)	0.875 (22.23)	0.450 (11.43)	133
LAT-7-707-10	10,000	Polyester	White	7	1.000 (25.40)	0.500 (12.70)	1.100 (27.94)	0.875 (22.23)	0.450 (11.43)	133
LAT-7-709-10	10,000	Removable Polyester	White	7	1.000 (25.40)	0.500 (12.70)	1.100 (27.94)	0.875 (22.23)	0.450 (11.43)	133
LAT-7-712-10	10,000	Polyester	Clear	7	1.000 (25.40)	0.500 (12.70)	1.100 (27.94)	0.875 (22.23)	0.450 (11.43)	133
LAT-7-722-10	10,000	Polyester	Clear	7	1.000 (25.40)	0.500 (12.70)	1.100 (27.94)	0.875 (22.23)	0.450 (11.43)	133
LAT-7-737-10	10,000	Tedlar®	White	7	1.000 (25.40)	0.500 (12.70)	1.100 (27.94)	0.875 (22.23)	0.450 (11.43)	133
LAT-7-737Y-10	10,000	Tedlar	Yellow	7	1.000 (25.40)	0.500 (12.70)	1.100 (27.94)	0.875 (22.23)	0.450 (11.43)	133
LAT-7-747-10	10,000	Polyester	White	7	1.000 (25.40)	0.500 (12.70)	1.100 (27.94)	0.875 (22.23)	0.450 (11.43)	133
LAT-7-747-10-YL	10,000	Polyester	Yellow	7	1.000 (25.40)	0.500 (12.70)	1.100 (27.94)	0.875 (22.23)	0.450 (11.43)	133
LAT-7-773-10	10,000	Metallized Polyester	Silver	7	1.000 (25.40)	0.500 (12.70)	1.100 (27.94)	0.875 (22.23)	0.450 (11.43)	133
LAT-7-799-10	10,000	Nylon Cloth	White	7	1.000 (25.40)	0.500 (12.70)	1.100 (27.94)	0.875 (22.23)	0.450 (11.43)	133
LAT-39-799-1,-2,5	1,000/2,500	Nylon Cloth	White	7	1.000 (25.40)	1.437 (36.50)	1.100 (27.94)	0.875 (22.23)	0.300 (7.62)	42
1.250" Label Width										
LAT-30-737-10-WT	10,000	Tedlar	White	5	1.250 (31.75)	0.375 (9.53)	1.600 (40.64)	0.875 (22.23)	0.450 (11.43)	125
LAT-30-737-10-YL	10,000	Tedlar	Yellow	5	1.250 (31.75)	0.375 (9.53)	1.600 (40.64)	0.875 (22.23)	0.450 (11.43)	125
1.500" Label Width										
LAT-9-409-10	10,000	Polyolefin	White	5	1.500 (38.10)	0.250 (6.35)	1.600 (40.64)	0.875 (22.23)	0.300 (7.62)	190
LAT-9-652-10	10,000	Polyimide	Amber	5	1.500 (38.10)	0.250 (6.35)	1.600 (40.64)	0.875 (22.23)	0.300 (7.62)	190
LAT-9-709-10	10,000	Removable Polyester	White	5	1.500 (38.10)	0.250 (6.35)	1.600 (40.64)	0.875 (22.23)	0.300 (7.62)	190
LAT-9-747-10	10,000	Polyester	White	5	1.500 (38.10)	0.250 (6.35)	1.600 (40.64)	0.875 (22.23)	0.300 (7.62)	190
LAT-9-747-10-YL	10,000	Polyester	Yellow	5	1.500 (38.10)	0.250 (6.35)	1.600 (40.64)	0.875 (22.23)	0.300 (7.62)	190
LAT-9-799-10	10,000	Nylon Cloth	White	5	1.500 (38.10)	0.250 (6.35)	1.600 (40.64)	0.875 (22.23)	0.300 (7.62)	190
LAT-41-707-10	10,000	Polyester	White	5	1.500 (38.10)	0.375 (9.525)	1.600 (40.64)	0.875 (22.23)	0.300 (7.62)	125
LAT-41-712-10	10,000	Polyester	Clear	5	1.500 (38.10)	0.375 (9.525)	1.600 (40.64)	0.875 (22.23)	0.300 (7.62)	125
LAT-47-707-10	10,000	Polyester	White	5	1.500 (38.10)	0.500 (12.70)	1.600 (40.64)	0.875 (22.23)	0.300 (7.62)	100
LAT-47-712-10	10,000	Polyester	Clear	5	1.500 (38.10)	0.500 (12.70)	1.600 (40.64)	0.875 (22.23)	0.300 (7.62)	100
LAT-20-773-2.5	2,500	Metallized Polyester	Silver	5	1.500 (38.10)	0.750 (19.05)	1.600 (40.64)	0.875 (22.23)	0.250 (6.35)	60

Tedlar® is a registered trademark of DuPont.

Note: Labels in chart are sorted in order by width, height, 3 digit material number (within part number), then die number (within part number).

Label Index by Size

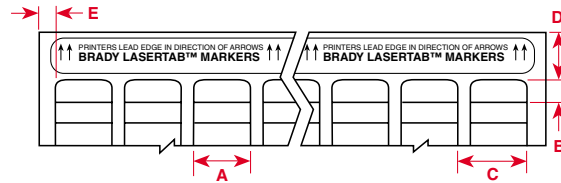

Part Number	Pieces Per Package	Material	Color	Labels Per Row	Label Width Inch (mm) A	Label Height Inch (mm) B	Horizontal Repeat Inch (mm) C	Top Margin Inch (mm) D	Left Margin Inch (mm) E	Labels Per Sheet
1.600" Label Width										
LAT-36-773-1	1,000	Metallized Polyester	Silver	4	1.600 (40.64)	0.375 (9.53)	1.920 (48.77)	0.875 (22.23)	0.620 (15.75)	100
1.875" Label Width										
LAT-10-652-10	10,000	Polyimide	Amber	4	1.875 (47.63)	0.250 (6.35)	2.000 (50.80)	0.875 (22.23)	0.314 (7.98)	156
LAT-10-747-10	10,000	Polyester	White	4	1.875 (47.63)	0.250 (6.35)	2.000 (50.80)	0.875 (22.23)	0.314 (7.98)	156
LAT-11-409-5	5,000	Polyolefin	White	4	1.875 (47.63)	0.375 (9.53)	2.000 (50.80)	0.875 (22.23)	0.310 (7.87)	100
LAT-11-747-5	5,000	Polyester	White	4	1.875 (47.63)	0.375 (9.53)	2.000 (50.80)	0.875 (22.23)	0.310 (7.87)	100
LAT-11-747-5-YL	5,000	Polyester	Yellow	4	1.875 (47.63)	0.375 (9.53)	2.000 (50.80)	0.875 (22.23)	0.310 (7.87)	100
LAT-13-409-2.5	2,500	Polyolefin	White	4	1.875 (47.63)	0.833 (21.16)	2.000 (50.80)	0.834 (21.18)	0.310 (7.87)	44
LAT-13-410-2.5	2,500	Polyolefin	White	4	1.875 (47.63)	0.833 (21.16)	2.000 (50.80)	0.834 (21.18)	0.310 (7.87)	44
LAT-13-707-2.5	2,500	Polyester	White	4	1.875 (47.63)	0.833 (21.16)	2.000 (50.80)	0.834 (21.18)	0.310 (7.87)	44
LAT-13-722-2.5	2,500	Polyester	Clear	4	1.875 (47.63)	0.833 (21.16)	2.000 (50.80)	0.834 (21.18)	0.310 (7.87)	44
LAT-13-747-2.5	2,500	Polyester	White	4	1.875 (47.63)	0.833 (21.16)	2.000 (50.80)	0.834 (21.18)	0.310 (7.87)	44
LAT-13-747-2.5-YL	2,500	Polyester	Yellow	4	1.875 (47.63)	0.833 (21.16)	2.000 (50.80)	0.834 (21.18)	0.310 (7.87)	44
LAT-13-759-2.5	2,500	Paper	White	4	1.875 (47.63)	0.833 (21.16)	2.000 (50.80)	0.834 (21.18)	0.310 (7.87)	44
LAT-13-712-2.5	2,500	Polyester	Clear	4	1.875 (47.63)	0.833 (21.16)	2.000 (50.80)	0.834 (21.18)	0.310 (7.87)	44
LAT-14-747-1.5	1,500	Polyester	White	4	1.875 (47.63)	1.330 (33.78)	2.000 (50.80)	0.834 (21.18)	0.315 (8.00)	28
2.000" Label Width										
LAT-31-707-1	1,000	Polyester	White	3	2.000 (50.80)	0.900 (22.86)	2.800 (71.12)	0.875 (22.23)	0.300 (7.62)	30
LAT-31-747-1	1,000	Polyester	White	3	2.000 (50.80)	0.900 (22.86)	2.800 (71.12)	0.875 (22.23)	0.300 (7.62)	30
LAT-31-759-1	1,000	Paper	White	3	2.000 (50.80)	0.900 (22.86)	2.800 (71.12)	0.875 (22.23)	0.300 (7.62)	30
LAT-33-707-1	1,000	Polyester	White	3	2.000 (50.80)	1.437 (36.50)	2.800 (71.12)	0.875 (22.23)	0.300 (7.62)	18
LAT-33-747-1	1,000	Polyester	White	3	2.000 (50.80)	1.437 (36.50)	2.800 (71.12)	0.875 (22.23)	0.300 (7.62)	18
LAT-33-759-1	1,000	Paper	White	3	2.000 (50.80)	1.437 (36.50)	2.800 (71.12)	0.875 (22.23)	0.300 (7.62)	18
2.500" Label Width										
LAT-21-707-1	1,000	Polyester	White	3	2.500 (63.50)	1.000 (25.40)	2.600 (66.04)	0.875 (22.23)	0.300 (7.62)	27
LAT-21-712-1	1,000	Polyester	Clear	3	2.500 (63.50)	1.000 (25.40)	2.600 (66.04)	0.875 (22.23)	0.300 (7.62)	27
LAT-21-747-1	1,000	Polyester	White	3	2.500 (63.50)	1.000 (25.40)	2.600 (66.04)	0.875 (22.23)	0.300 (7.62)	27
LAT-21-747-1-YL	1,000	Polyester	Yellow	3	2.500 (63.50)	1.000 (25.40)	2.600 (66.04)	0.875 (22.23)	0.300 (7.62)	27
LAT-21-773-1	1,000	Metallized Polyester	Silver	3	2.500 (63.50)	1.000 (25.40)	2.600 (66.04)	0.875 (22.23)	0.300 (7.62)	27
2.875" Label Width										
LAT-43-707-2.5	2,500	Polyester	White	20	2.875 (73.02)	0.375 (9.53)	—————	0.875 (22.23)	1.450 (36.83)	40
3.000" Label Width										
LAT-12-652-2.5	2,500	Polyimide	Amber	2	3.000 (76.20)	0.375 (9.53)	3.200 (81.28)	0.875 (22.23)	1.150 (29.21)	50
LAT-12-709-2.5	2,500	Removable Polyester	White	2	3.000 (76.20)	0.375 (9.53)	3.200 (81.28)	0.875 (22.23)	1.150 (29.21)	50
LAT-12-747-2.5	2,500	Polyester	White	2	3.000 (76.20)	0.375 (9.53)	3.200 (81.28)	0.875 (22.23)	1.150 (29.21)	50
LAT-12-747-2.5-YL	2,500	Polyester	Yellow	2	3.000 (76.20)	0.375 (9.53)	3.200 (81.28)	0.875 (22.23)	1.150 (29.21)	50
LAT-32-747-1	1,000	Polyester	White	2	3.000 (76.20)	0.900 (22.86)	3.200 (81.28)	0.875 (22.23)	1.150 (29.21)	20
LAT-32-759-1	1,000	Paper	White	2	3.000 (76.20)	0.900 (22.86)	3.200 (81.28)	0.875 (22.23)	1.150 (29.21)	20
LAT-34-707-1	1,000	Polyester	White	2	3.000 (76.20)	1.437 (36.50)	3.200 (81.28)	0.875 (22.23)	1.150 (29.21)	12
LAT-34-747-1	1,000	Polyester	White	2	3.000 (76.20)	1.437 (36.50)	3.200 (81.28)	0.875 (22.23)	1.150 (29.21)	18
LAT-34-759-1	1,000	Paper	White	2	3.000 (76.20)	1.437 (36.50)	3.200 (81.28)	0.875 (22.23)	1.150 (29.21)	18
3.062" Label Width										
LAT-175-124 **	380	Paper	White/Colors	2	3.062 (77.77)	0.500 (12.70)	0.500 (12.70)	0.938 (23.83)	1.118 (30.18)	38
3.600" Label Width										
LAT-44-707-2.5	2,500	Polyester	White	2	3.600 (91.44)	0.375 (9.53)	—————	0.875 (22.23)	0.650 (16.51)	40
6.625" Label Width										
LAT-178-759 **	165	Paper	White/Colors	1	6.625 (168.28)	0.625 (15.88)	—————	0.875 (22.23)	0.938 (23.83)	15

Note: Labels in chart are sorted in order by width, height, 3 digit material number (within part number), then die number (within part number).

**** Also available in: BL=blue, BR=brown, GR=green, GY=grey, OR=orange, PL=purple, RD=red, YL=yellow.**
To order a color, add a dash "-" after the material number, then add the color suffix.
Standard product: Contact your Brady Identification Solutions distributor or Customer Service representative for ordering information.

LABEL INDEX BY SIZE LASER LABELS

Self-Laminating Labels by Size

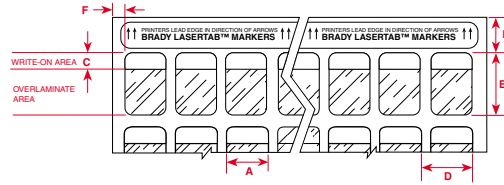

Part Number	Pieces Per Package	Material	Color	Labels Per Row	Label Width Inch (mm) A	Label Height Inch (mm) B	Write-on Height Inch (mm) C	Horizontal Repeat Inch (mm) D	Top Margin Inch (mm) E	Left Margin Inch (mm) F	Labels Per Sheet	
0.375" Label Width												
LAT-57-361-2.5	2,500	Self-laminating Polyester	Translucent	4	0.375 (9.53)	1.800 (45.72)	0.750 (19.05)	1.900 (48.26)	0.875 (22.23)	0.500 (12.70)	100	
0.500" Label Width												
LAT-15-361-1,-5	1,000/5,000	Polyester	White/Trans.	13	0.500 (12.70)	0.750 (19.05)	0.370 (9.40)	0.600 (15.24)	0.875 (22.23)	0.400 (10.16)	156	
LAT-48-361-1	1,000	Polyester	White	13	0.500 (12.70)	1.000 (25.40)	0.375 (9.53)	0.600 (15.24)	0.875 (22.23)	0.400 (10.16)	117	
LAT-49-361-1	1,000	Polyester	White	13	0.500 (12.70)	1.250 (31.75)	0.500 (12.70)	0.600 (15.24)	0.875 (22.23)	0.400 (10.16)	91	
LAT-22-361-5	5,000	Polyester	White/Trans.	13	0.500 (12.70)	1.500 (38.10)	0.500 (12.70)	0.600 (15.24)	0.875 (22.23)	0.400 (10.16)	78	
0.600" Label Width												
LAT-56-361-2.5	2,500	Self-laminating Polyester	Translucent	4	0.600 (15.24)	1.625 (41.28)	1.000 (25.40)	1.725 (43.82)	0.875 (22.23)	0.850 (21.59)	64	
LAT-59-361-2.5	2,500	Self-laminating Polyester	Translucent	3	0.600 (15.24)	2.625 (66.68)	1.000 (25.40)	2.725 (69.22)	0.875 (22.23)	0.213 (5.41)	45	
0.750" Label Width												
LAT-50-361-1	1,000	Polyester	White	9	0.750 (19.05)	1.000 (25.40)	0.375 (9.53)	0.850 (21.59)	0.875 (22.23)	0.475 (12.07)	81	
LAT-51-361-1	1,000	Polyester	White	9	0.750 (19.05)	1.500 (38.10)	0.500 (12.70)	0.850 (21.59)	0.875 (22.23)	0.475 (12.07)	54	
1.000" Label Width												
LAT-16-361-1,-5	1,000/5,000	Polyester	White/Trans.	7	1.000 (25.40)	0.750 (19.05)	0.340 (8.64)	1.100 (27.94)	0.875 (22.23)	0.450 (11.43)	84	
LAT-17-361-1,-2.5	1,000/2,500	Polyester	White/Trans.	7	1.000 (25.40)	1.000 (25.40)	0.340 (8.64)	1.100 (27.94)	0.875 (22.23)	0.450 (11.43)	63	
LAT-18-361-1,-2.5	1,000/2,500	Polyester	White/Trans.	7	1.000 (25.40)	1.330 (33.78)	0.500 (12.70)	1.100 (27.94)	0.834 (21.18)	0.450 (11.43)	49	
LAT-39-361-1	1,000	Polyester	White	7	1.000 (25.40)	1.437 (36.50)	0.500 (12.70)	1.100 (27.94)	0.875 (22.23)	0.300 (7.62)	42	
LAT-58-361-1	1,000	Self-laminating Polyester	Translucent	7	1.000 (25.40)	2.625 (66.68)	1.000 (25.40)	1.100 (27.94)	0.875 (22.23)	0.450 (11.43)	21	
LAT-19-361-1	1,000	Polyester	White/Trans.	7	1.000 (25.40)	3.167 (80.44)	0.970 (24.64)	1.100 (27.94)	0.834 (21.18)	0.450 (11.43)	21	
1.200" Label Width												
LAT-35-361-2.5	2,500	Polyester	White/Trans.	6	1.200 (30.48)	1.500 (38.10)	0.500 (12.70)	1.270 (32.23)	0.875 (22.23)	0.400 (10.16)	36	
1.500" Label Width												
LAT-52-361-1	1,000	Polyester	White	5	1.500 (38.10)	1.000 (25.40)	0.375 (9.53)	0.875 (22.23)	0.300 (7.62)	0.300 (7.62)	45	
LAT-53-361-1	1,000	Polyester	White	5	1.500 (38.10)	1.500 (38.10)	0.500 (12.70)	1.600 (40.64)	0.300 (7.62)	0.300 (7.62)	30	
1.750" Label Width												
LAT-54-361-1	1,000	Polyester	White	4	1.750 (44.45)	1.000 (25.40)	0.375 (9.53)	0.875 (22.23)	0.600 (15.24)	0.600 (15.24)	36	
LAT-55-361-1	1,000	Polyester	White	4	1.750 (44.45)	1.500 (38.10)	0.375 (9.53)	0.875 (22.23)	0.600 (15.24)	0.600 (15.24)	24	
1.875" Label Width												
LAT-27-361-1	1,000	Polyester	White/Trans.	4	1.875 (47.63)	3.167 (80.44)	0.968 (24.59)	2.000 (50.80)	0.875 (22.23)	0.215 (5.46)	12	

PermaShield™ Markers by Size

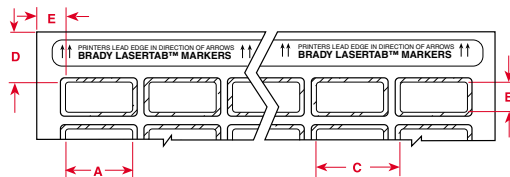

Clear polyester (B-966) overlaminate extends 0.126 outside of label on each side.

Part Number	Pieces Per Package	Material	Color	Labels Per Row	Label Width Inch (mm) A	Label Height Inch (mm) B	Horizontal Repeat Inch (mm) C	Top Margin Inch (mm) D	Left Margin Inch (mm) E	Labels Per Sheet
1.000" Label Width										
LAT-23-747-2.5	2,500	Polyester	White	6	1.000 (25.40)	0.500 (12.70)	1.350 (34.29)	1.000 (25.40)	0.275 (6.99)	60
LAT-23-773-2.5	2,500	Metallized Polyester	Silver	6	1.000 (25.40)	0.500 (12.70)	1.350 (34.29)	1.000 (25.40)	0.275 (6.99)	60
1.750" Label Width										
LAT-24-747-1	1,000	Polyester	White	3	1.750 (44.45)	1.000 (25.40)	2.200 (55.88)	1.000 (25.40)	1.175 (29.85)	21
LAT-24-773-1	1,000	Metallized Polyester	Silver	3	1.750 (44.45)	1.000 (25.40)	2.200 (55.88)	1.000 (25.40)	1.175 (29.85)	21

Note: Labels in chart are sorted in order by width, height, 3 digit material number (within part number), then die number (within part number).

* This product is sold in Japan under the Overlamine Labels name and not under the PermaShield name.

Faceplate Inserts by Size

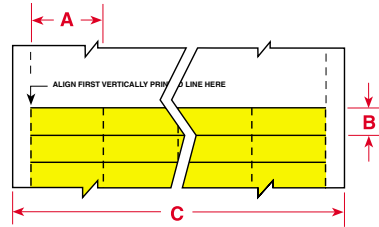

Part Number	Pieces Per Package	Material	Color	Strips Per Row	Strip Width Inch (mm) A	Strip Height Inch (mm) B	Web Width Inch (mm) C
1.975" Label Width							
LAT-176-124-WT	1,000	Paper	White	4	1.975 (50.17)	0.375 (9.53)	8.500 (215.90)

110 Block Markers by Size

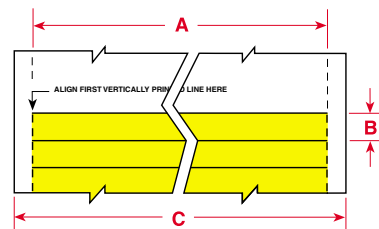

Part Number	Pieces Per Package	Material	Color	Strips Per Row	Strip Width Inch (mm) A	Strip Height Inch (mm) B	Web Width Inch (mm) C
7.900" Label Width							
LAT-177-124-BL	180	Paper	Blue	1	7.900 (200.66)	0.475 (12.07)	8.500 (215.90)
LAT-177-124-BR	180	Paper	Brown	1	7.900 (200.66)	0.475 (12.07)	8.500 (215.90)
LAT-177-124-GR	180	Paper	Green	1	7.900 (200.66)	0.475 (12.07)	8.500 (215.90)
LAT-177-124-GY	180	Paper	Gray	1	7.900 (200.66)	0.475 (12.07)	8.500 (215.90)
LAT-177-124-OR	180	Paper	Orange	1	7.900 (200.66)	0.475 (12.07)	8.500 (215.90)
LAT-177-124-PL	180	Paper	Purple	1	7.900 (200.66)	0.475 (12.07)	8.500 (215.90)
LAT-177-124-RD	180	Paper	Red	1	7.900 (200.66)	0.475 (12.07)	8.500 (215.90)
LAT-177-124-WT	180	Paper	White	1	7.900 (200.66)	0.475 (12.07)	8.500 (215.90)
LAT-177-124-YL	180	Paper	Yellow	1	7.900 (200.66)	0.475 (12.07)	8.500 (215.90)

Non Die-Cut Sheets

Part Number	Sheets Per Package	Material	Color	Label Width Inch (mm)	Label Height Inch (mm)	Labels Per Sheet
8.500" Label Width						
LAT-28-773-25-SH	25 Sheets	Metallized Polyester	Silver	8.500 (215.90)	11.000 (279.40)	1
LAT-28-747-25-SH	25 Sheets	Polyester	White	8.500 (215.90)	11.000 (279.40)	1
LAT-28-747-YL-25-SH	25 Sheets	Polyester	Yellow	8.500 (215.90)	11.000 (279.40)	1
LAT-28-722-25-SH	25 Sheets	Polyester	Clear	8.500 (215.90)	11.000 (279.40)	1
LAT-28-409-25-SH	25 Sheets	Polyolefin	White	8.500 (215.90)	11.000 (279.40)	1

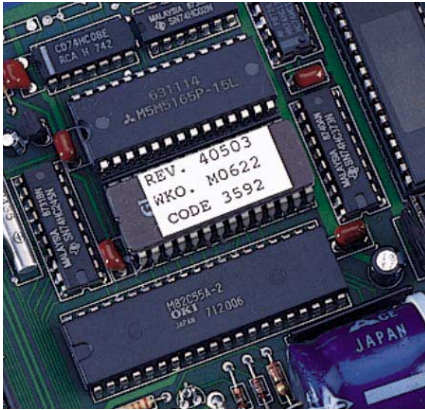

Brady label materials are specially engineered to resist the harsh environments associated with the processing of printed circuit boards.

LASER PRINTABLE PRODUCTS CIRCUIT BOARD PROCESS CHART

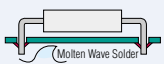
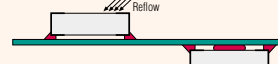
	 Through Hole Technology		 Surface Mount Technology (SMT)	After Process
	Top	Bottom	Top or Bottom	
B-652	● Yes	● Yes	● Yes	● Yes
B-409, B-709, B-747, B-773, B-799	▲ Yes*	✘ No	✘ No	● Yes

* In extreme high temperatures, testing of these materials is recommended.

► POLYIMIDES

High-Temperature Amber Polyimide Film (B-652)

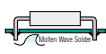
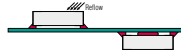
Part Number	Size Inch (mm)	Specifications on Page	 Through Hole Technology Top / Bottom	 SMT Top / Bottom	After Process
LAT-2-652	0.375 x 0.375 (9.53 x 9.53)	128	●	●	●
LAT-3-652	0.650 x 0.250 (16.51 x 6.35)	128	●	●	●
LAT-4-652	0.800 x 0.250 (20.32 x 6.35)	129	●	●	●
LAT-5-652	0.800 x 0.500 (20.32 x 12.70)	129	●	●	●
LAT-6-652	1.000 x 0.250 (25.40 x 6.35)	129	●	●	●
LAT-7-652	1.000 x 0.500 (25.40 x 12.70)	129	●	●	●
LAT-8-652	1.000 x 0.375 (25.40 x 9.53)	129	●	●	●
LAT-9-652	1.500 x 0.250 (38.10 x 6.35)	129	●	●	●
LAT-10-652	1.875 x 0.250 (47.63 x 6.35)	130	●	●	●
LAT-12-652	3.000 x 0.375 (76.20 x 9.53)	130	●	●	●
LAT-25-652	0.500 x 0.437 (12.70 x 11.10)	128	●	●	●
LAT-26-652	0.250 x 0.250 (6.35 x 6.35)	128	●	●	●
LAT-29-652	0.650 x 0.200 (16.51 x 5.08)	128	●	●	●

● Yes, this material will work with this application.

✘ No, this material does not work with this application.

▲ In extreme high temperatures, testing of these materials is recommended.

Circuit Board and Component Identification



Brady laser printable polyester labels are ideal for small volume production runs.

► POLYESTER

Removable White Polyester (B-709),
Permanent White or Yellow Polyester (B-747)

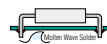

Part Number	Size Inch (mm)	Specifications on Page	Through Hole Technology Top	Through Hole Technology Bottom	SMT Top / Bottom	After Process
LAT-1-747	0.300 x 0.250 (7.62 x 6.35)	128	▲	✘	✘	●
LAT-2-747	0.375 x 0.375 (9.53 x 9.53)	128	▲	✘	✘	●
LAT-3-747	0.650 x 0.250 (16.51 x 6.35)	128	▲	✘	✘	●
LAT-4-747	0.800 x 0.250 (20.32 x 6.35)	129	▲	✘	✘	●
LAT-4-747-YL	0.800 x 0.250 (20.32 x 6.35)	129	▲	✘	✘	●
LAT-5-747	0.800 x 0.500 (20.32 x 12.70)	129	▲	✘	✘	●
LAT-5-747-YL	0.800 x 0.500 (20.32 x 12.70)	129	▲	✘	✘	●
LAT-6-747	1.000 x 0.250 (25.40 x 6.35)	129	▲	✘	✘	●
LAT-6-747-YL	1.000 x 0.250 (25.40 x 6.35)	129	▲	✘	✘	●
LAT-7-709	1.000 x 0.500 (25.40 x 12.70)	129	▲	✘	✘	●
LAT-7-747	1.000 x 0.500 (25.40 x 12.70)	129	▲	✘	✘	●
LAT-7-747-YL	1.000 x 0.500 (25.40 x 12.70)	129	▲	✘	✘	●
LAT-8-747	1.000 x 0.375 (25.40 x 9.53)	129	▲	✘	✘	●
LAT-8-747-YL	1.000 x 0.375 (25.40 x 9.53)	129	▲	✘	✘	●
LAT-9-709	1.500 x 0.250 (38.10 x 6.35)	129	▲	✘	✘	●
LAT-9-747	1.500 x 0.250 (38.10 x 6.35)	129	▲	✘	✘	●
LAT-9-747-YL	1.500 x 0.250 (38.10 x 6.35)	129	▲	✘	✘	●
LAT-10-747	1.875 x 0.250 (47.63 x 6.35)	130	▲	✘	✘	●
LAT-11-747	1.875 x 0.375 (47.63 x 9.53)	130	▲	✘	✘	●
LAT-11-747-YL	1.875 x 0.375 (47.63 x 9.53)	130	▲	✘	✘	●
LAT-12-709	3.000 x 0.375 (76.20 x 9.53)	130	▲	✘	✘	●
LAT-12-747	3.000 x 0.375 (76.20 x 9.53)	130	▲	✘	✘	●
LAT-12-747-YL	3.000 x 0.375 (76.20 x 9.53)	130	▲	✘	✘	●
LAT-25-709	0.500 x 0.437 (12.70 x 11.10)	128	▲	✘	✘	●
LAT-25-747	0.500 x 0.437 (12.70 x 11.10)	128	▲	✘	✘	●
LAT-26-747	0.250 x 0.250 (6.35 x 6.35)	128	▲	✘	✘	●
LAT-29-747	0.650 x 0.200 (16.51 x 5.08)	128	▲	✘	✘	●
LAT-29-747-YL	0.650 x 0.200 (16.51 x 5.08)	128	▲	✘	✘	●

- Yes, this material will work with this application.
- ✘ No, this material does not work with this application.
- ▲ In extreme high temperatures, testing of these materials is recommended.

Circuit Board and Component Identification

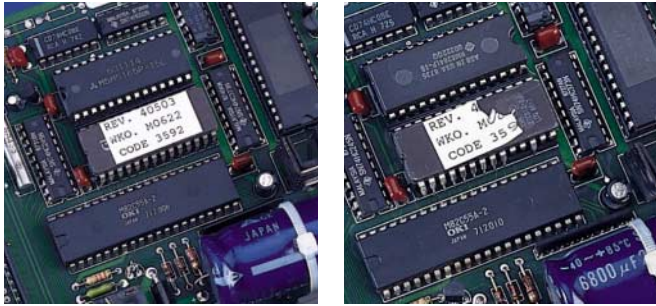

Tamper-evident polyolefin (B-410) irreversibly stretches and fractures upon removal.

▶ METALLIZED POLYESTER

Metallized Polyester (B-773)

Part Number	Size Inch (mm)	Specifications on Page	Through Hole Technology		SMT Top / Bottom	After Process
			Top	Bottom		
LAT-7-773	1.000 x 0.500 (25.40 x 12.70)	129	▲	✘	✘	●
LAT-36-773	1.600 x 0.375 (40.64 x 9.26)	130	▲	✘	✘	●

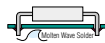

▶ MISC. MATERIALS

Abrasion-Resistant White Polyolefin Film (B-409)

Tamper-Evident White Polyolefin (B-410)

Flame-Retardant White or Yellow Tedlar® Film (B-737)

Permanent White Nylon Cloth (B-799)

Part Number	Size Inch (mm)	Specifications on Page	Through Hole Technology		SMT Top / Bottom	After Process
			Top	Bottom		
LAT-3-410	0.650 x 0.250 (16.51 x 6.35)	128	▲	✘	✘	●
LAT-4-410	0.800 x 0.250 (20.32 x 6.35)	129	▲	✘	✘	●
LAT-4-737	0.800 x 0.250 (20.32 x 6.35)	129	▲	✘	✘	●
LAT-7-410	1.000 x 0.500 (25.40 x 12.70)	129	▲	✘	✘	●
LAT-7-799	1.000 x 0.500 (25.40 x 12.70)	129	▲	✘	✘	●
LAT-8-409	1.000 x 0.375 (25.40 x 9.53)	129	▲	✘	✘	●
LAT-8-799	1.000 x 0.375 (25.40 x 38.10)	129	▲	✘	✘	●
LAT-9-409	1.500 x 0.250 (38.10 x 6.35)	129	▲	✘	✘	●
LAT-9-799	1.500 x 0.250 (38.10 x 6.35)	129	▲	✘	✘	●
LAT-11-409	1.875 x 0.375 (47.63 x 9.53)	130	▲	✘	✘	●
LAT-29-799	0.650 x 0.200 (15.51 x 5.08)	128	▲	✘	✘	●

Tedlar® is a registered trademark of DuPont.

● Yes, this material will work with this application.

✘ No, this material does not work with this application.

▲ In extreme high temperatures, testing of these materials is recommended.



Wire and Cable Marking

**Nylon Cloth (B-799), Self-Laminating Polyester (B-361),
Flame-Retardant White or Yellow Tedlar® Film (B-737)**

Part Number	Size Inch (mm)	Specifications on Page
LAT-7-737	1.000 x 0.500 (25.40 x 12.70)	129
LAT-7-737-YL	1.000 x 0.500 (25.40 x 12.70)	129
LAT-15-361	0.500 x 0.750 (12.70 x 19.05)	131
LAT-16-361	1.000 x 0.750 (25.40 x 19.05)	131
LAT-17-361	1.000 x 1.000 (25.40 x 25.40)	131
LAT-18-361	1.000 x 1.330 (25.40 x 33.78)	131
LAT-19-361	1.000 x 3.167 (25.40 x 80.44)	131
LAT-22-361	0.500 x 1.500 (12.70 x 38.10)	131
LAT-27-361	1.875 x 3.167 (47.63 x 80.44)	131
LAT-29-737	0.650 x 0.200 (16.51 x 5.08)	128
LAT-30-737	1.250 x 0.375 (31.75 x 9.53)	129
LAT-30-737-YL	1.250 x 0.375 (31.75 x 9.53)	129
LAT-35-361	1.200 x 1.500 (30.48 x 38.10)	131
LAT-37-799	0.800 x 1.437 (20.32 x 36.50)	129
LAT-38-799	0.500 x 1.437 (12.70 x 36.50)	128
LAT-39-799	1.000 x 1.437 (25.40 x 36.50)	129
LAT-39-361	1.000 x 1.437 (25.40 x 36.50)	131
LAT-40-799	0.500 x 0.750 (12.70 x 19.05)	128
LAT-48-361	0.500 x 1.000 (12.70 x 25.40)	131
LAT-49-361	0.500 x 1.250 (12.70 x 31.75)	131
LAT-50-361	0.750 x 1.000 (19.05 x 25.40)	131
LAT-51-361	0.750 x 1.500 (19.05 x 38.10)	131
LAT-52-361	1.500 x 1.000 (38.10 x 25.40)	131
LAT-53-361	1.500 x 1.500 (38.10 x 38.10)	131
LAT-54-361	1.500 x 1.500 (38.10 x 38.10)	131
LAT-55-361	1.750 x 1.500 (44.45 x 38.10)	131

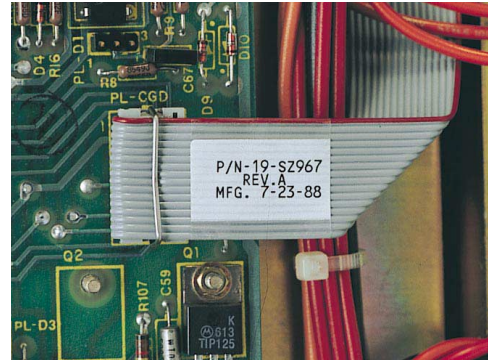

LaserTab™ markers adhere to ribbon cables without peeling when cables are flexed. Images remain clean and crisp, even after repeated handling.

▶ VOICE AND DATA CABLING LABELS

Part Number	Application	Size Inch (mm)	Specifications on Page
LAT-17-361	2-pair Fiber	1.000 x 1.000 (25.40 x 25.40)	131
LAT-18-361	Cat-5 4 Pair Copper UTP	1.000 x 1.330 (25.40 x 33.78)	131
LAT-19-361	25 Pair Copper	1.000 x 3.167 (25.40 x 80.44)	131
LAT-53-361	Cat-5 4 Pair Copper UTP	1.500 x 1.500 (38.10 x 38.10)	131

▶ WORKSTATION LABELS

Part Number	Application	Size Inch (mm)	Specifications on Page
LAT-7-707	White for 1-2 Outlet Faceplates	1.000 x 0.500 (25.40 x 12.70)	129
LAT-7-712	Clear for 1-2 Outlet Faceplates	1.000 x 0.500 (25.40 x 12.70)	129
LAT-8-707	White for 1-2 Outlet Faceplates	1.000 x 0.375 (25.40 x 9.53)	129
LAT-8-712	Clear for 1-2 Outlet Faceplates	1.000 x 0.375 (25.40 x 9.53)	129
LAT-41-707	White for 1-2 Outlet Faceplates	0.375 x 1.500 (9.53 x 38.10)	129
LAT-41-712	Clear for 1-2 Outlet Faceplates	0.375 x 1.500 (9.53 x 38.10)	129
LAT-45-707	White for 1-6 Outlet Faceplates	0.500 x 0.375 (12.70 x 9.53)	128
LAT-45-712	Clear for 1-6 Outlet Faceplates	0.500 x 0.375 (12.70 x 9.53)	128
LAT-46-707	White for 1-6 Outlet Faceplates	0.500 x 0.500 (12.70 x 12.70)	128
LAT-46-712	Clear for 1-6 Outlet Faceplates	0.500 x 0.500 (12.70 x 12.70)	128
LAT-47-707	Clear for 1-2 Outlet Faceplates	1.500 x 0.500 (38.10 x 12.70)	129
LAT-47-712	White for 1-2 Outlet Faceplates	1.500 x 0.500 (38.10 x 12.70)	129
LAT-176-124	Faceplate Desi-Strip Insert	1.975 x 0.375 (50.17 x 9.53)	132

▶ LASERTAB LANPAK

LAT-LANPAK - 10 sheets of 8 popular sizes as listed below:

Part Number	Application	Size Inch (mm)	Specifications on Page
LAT-8-707	Faceplate	1.000 x 0.375 (25.40 x 9.53)	129
LAT-18-361	CAT-5 Cable	1.000 x 1.330 (25.40 x 33.78)	131
LAT-44-707	Patch Panels	3.600 x 0.375 (91.44 x 9.53)	130
LAT-45-707	Faceplate/Patch Panels	0.500 x 0.375 (12.70 x 9.53)	128
LAT-47-707	Faceplate	1.500 x 0.500 (38.10 x 12.70)	129
LAT-176-124	Faceplate Desi-Strips	1.980 x 0.380 (50.29 x 9.65)	132
LAT-177-124-WT	110 Blocks	7.910 x 0.480 (200.91 x 12.19)	132
LAT-177-124-BL	110 Blocks	7.910 x 0.480 (200.91 x 12.19)	132

▶ FACEPLATE IDENTIFICATION

Part Number	Size Inch (mm)	Specifications on Page
LAT-176-124	1.975 x 0.375 (50.17 x 9.53)	132



Brady cable labels have a proprietary adhesive that helps them stay attached.



Brady LAT-176-124 is precut for desi-strip inserts in faceplates.

Data Communications Equipment and Cabling Labels

► PATCH PANEL AND 110 BLOCK IDENTIFICATION

Part Number	Color	Applications	Label Size Inch (mm)	Specifications on Page
LAT-46-707	White	Patch Panel - Label Each Port	0.560 x 0.560 (14.20 x 14.20)	128
LAT-43-707	White	Patch Panel - 4 Port	2.875 x 0.375 (73.02 x 9.525)	130
LAT-44-707	White	Patch Panel - 6 Port	3.600 x 0.375 (94.44 x 9.525)	130
LAT-175-124-BL	Blue	Patch Panel Inserts	3.060 x 0.500 (77.77 x 12.07)	130
LAT-175-124-BR	Brown	Patch Panel Inserts	3.060 x 0.500 (77.77 x 12.07)	130
LAT-175-124-GR	Green	Patch Panel Inserts	3.060 x 0.500 (77.77 x 12.07)	130
LAT-175-124-GY	Gray	Patch Panel Inserts	3.060 x 0.500 (77.77 x 12.07)	130
LAT-175-124-OR	Orange	Patch Panel Inserts	3.060 x 0.500 (77.77 x 12.07)	130
LAT-175-124-PL	Purple	Patch Panel Inserts	3.060 x 0.500 (77.77 x 12.07)	130
LAT-175-124-RD	Red	Patch Panel Inserts	3.060 x 0.500 (77.77 x 12.07)	130
LAT-175-124-WT	White	Patch Panel Inserts	3.060 x 0.500 (77.77 x 12.07)	130
LAT-175-124-YL	Yellow	Patch Panel Inserts	3.060 x 0.500 (77.77 x 12.07)	130
LAT-177-124-BL	Blue	110 Blocks	7.900 x 0.475 (200.66 x 12.07)	132
LAT-177-124-BR	Brown	110 Blocks	7.900 x 0.475 (200.66 x 12.07)	132
LAT-177-124-GR	Green	110 Blocks	7.900 x 0.475 (200.66 x 12.07)	132
LAT-177-124-GY	Gray	110 Blocks	7.900 x 0.475 (200.66 x 12.07)	132
LAT-177-124-OR	Orange	110 Blocks	7.900 x 0.475 (200.66 x 12.07)	132
LAT-177-124-PL	Purple	110 Blocks	7.900 x 0.475 (200.66 x 12.07)	132
LAT-177-124-RD	Red	110 Blocks	7.900 x 0.475 (200.66 x 12.07)	132
LAT-177-124-WT	White	110 Blocks	7.900 x 0.475 (200.66 x 12.07)	132
LAT-177-124-YL	Yellow	110 Blocks	7.900 x 0.475 (200.66 x 12.07)	132
LAT-178-759-BL	Blue	Bix Blocks	6.625 x 0.625 (168.28 x 15.88)	130
LAT-178-759-BR	Brown	Bix Blocks	6.625 x 0.625 (168.28 x 15.88)	130
LAT-178-759-GR	Green	Bix Blocks	6.625 x 0.625 (168.28 x 15.88)	130
LAT-178-759-GY	Gray	Bix Blocks	6.625 x 0.625 (168.28 x 15.88)	130
LAT-178-759-OR	Orange	Bix Blocks	6.625 x 0.625 (168.28 x 15.88)	130
LAT-178-759-PL	Purple	Bix Blocks	6.625 x 0.625 (168.28 x 15.88)	130
LAT-178-759-RD	Red	Bix Blocks	6.625 x 0.625 (168.28 x 15.88)	130
LAT-178-759-WT	White	Bix Blocks	6.625 x 0.625 (168.28 x 15.88)	130
LAT-178-759-YL	Yellow	Bix Blocks	6.625 x 0.625 (168.28 x 15.88)	130



LAT-43-707 and LAT-44-707 are designed for patch panel identification.

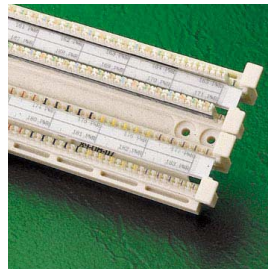

Brady's LabelMark™ software program includes LAT-177 labels preloaded with 3 pair, 4 pair, and 5 pair numbering schemes for identifying 110 terminal blocks.

► GENERAL COMMUNICATION IDENTIFICATION

Part Number	Application	Size Inch (mm)	Specifications on Page
LAT-13-747	Grounding, Splices, Pathway and General Identification in a Closet	1.875 x 0.833 (47.63 x 21.16)	130
LAT-14-747	Grounding, Splices, Pathway and General Identification in a Closet	1.875 x 0.833 (47.63 x 21.16)	130
LAT-24-747	Grounding, Splices, Pathway and General Identification in a Closet	1.750 x 1.000 (44.45 x 25.40)	131
LAT-24-773	Grounding, Splices, Pathway and General Identification in a Closet	1.750 x 1.000 (44.45 x 25.40)	131

► RATING PLATES AND ASSET IDENTIFICATION

- Rough Surface White Polyester (B-707)**
- Removable White Polyester (B-709)**
- Rough Surface Translucent Polyester (B-712)**
- Permanent White or Yellow Polyester (B-747)**
- General Purpose Paper (B-759)**

Part Number	Size Inch (mm)	Specifications on Page
LAT-5-759	0.800 x 0.500 (20.32 x 12.70)	129
LAT-7-707	1.000 x 0.500 (25.40 x 12.70)	129
LAT-7-709	1.000 x 0.500 (25.40 x 12.70)	129
LAT-7-712	1.000 x 0.500 (25.40 x 12.70)	129
LAT-7-747	1.000 x 0.500 (25.40 x 12.70)	129
LAT-7-747-YL	1.000 x 0.500 (25.40 x 12.70)	129
LAT-8-707	1.000 x 0.375 (25.40 x 9.53)	129
LAT-8-712	1.000 x 0.375 (25.40 x 9.53)	129
LAT-13-707	1.875 x 0.833 (47.63 x 21.16)	130
LAT-13-747	1.875 x 0.833 (47.63 x 21.16)	130
LAT-13-747-YL	1.875 x 0.833 (47.63 x 21.16)	130
LAT-13-759	1.875 x 0.833 (47.63 x 21.16)	130
LAT-14-747	1.875 x 1.330 (47.63 x 33.78)	130
LAT-21-707	2.500 x 1.000 (63.50 x 25.40)	130
LAT-21-747	2.500 x 1.000 (63.50 x 25.40)	130
LAT-21-747-YL	2.500 x 1.000 (63.50 x 25.40)	130
LAT-31-707	2.000 x 0.900 (50.80 x 22.86)	130
LAT-31-747	2.000 x 0.900 (50.80 x 22.86)	130
LAT-31-759	2.000 x 0.900 (50.80 x 22.86)	130
LAT-32-747	3.000 x 0.900 (76.20 x 22.86)	130
LAT-32-759	3.000 x 0.900 (76.20 x 22.86)	130
LAT-33-707	2.000 x 1.437 (50.80 x 36.50)	130
LAT-33-747	2.000 x 1.437 (50.80 x 36.50)	130
LAT-33-759	2.000 x 1.437 (50.80 x 36.50)	130
LAT-34-707	3.000 x 1.437 (76.20 x 36.50)	130
LAT-34-747	3.000 x 1.437 (76.20 x 36.50)	130
LAT-34-759	3.000 x 1.437 (76.20 x 36.50)	130
LAT-41-707	1.500 x 0.375 (38.10 x 9.53)	129
LAT-42-707	0.560 x 0.560 (14.22 x 14.22)	128
LAT-43-707	2.875 x 0.375 (73.02 x 9.53)	130
LAT-44-707	3.600 x 0.375 (91.44 x 9.53)	130
LAT-45-707	0.500 x 0.375 (12.70 x 9.53)	128
LAT-45-712	0.500 x 0.375 (12.70 x 9.53)	128
LAT-46-707	0.500 x 0.500 (12.70 x 12.70)	128
LAT-46-712	0.500 x 0.500 (12.70 x 12.70)	128
LAT-47-707	1.500 x 0.500 (38.10 x 12.70)	129
LAT-47-712	1.500 x 0.500 (38.10 x 12.70)	129

- Abrasion-Resistant White Polyolefin (B-409)**
- Tamper-Evident White Polyolefin (B-410)**

Part Number	Size Inch (mm)	Specifications on Page
LAT-7-410	1.000 x 0.500 (25.40 x 12.70)	129
LAT-13-409	1.875 x 0.833 (47.63 x 21.16)	130
LAT-13-410	1.875 x 0.833 (47.63 x 21.16)	130



Brady's polyester materials, B-747 and B-773, are perfect for on-demand printing of rating plates. They eliminate the hassle of purchasing pre-printed labels, and permit better control of labeling design and cost.

General Identification Labels

► RATING PLATES AND ASSET IDENTIFICATION

Rough Surface Translucent Polyester (B-712) **Translucent Polyester (B-722)**

Part Number	Size Inch (mm)	Specifications on Page
LAT-7-722	1.000 x 0.500 (25.40 x 12.70)	129
LAT-13-712	1.875 x 0.833 (47.63 x 21.16)	130
LAT-13-722	1.875 x 0.833 (47.63 x 21.16)	130
LAT-21-712	2.500 x 1.000 (63.50 x 25.40)	130
LAT-41-712	1.500 x 0.375 (38.10 x 9.525)	129
LAT-42-712	0.560 x 0.560 (14.22 x 14.22)	128

Permanent Metallized Polyester (B-773)

Part Number	Size Inch (mm)	Specifications on Page
LAT-7-773	1.000 x 0.500 (25.40 x 12.70)	129
LAT-20-773	1.500 x 0.750 (38.10 x 19.05)	129
LAT-21-773	2.500 x 1.000 (63.50 x 25.40)	130

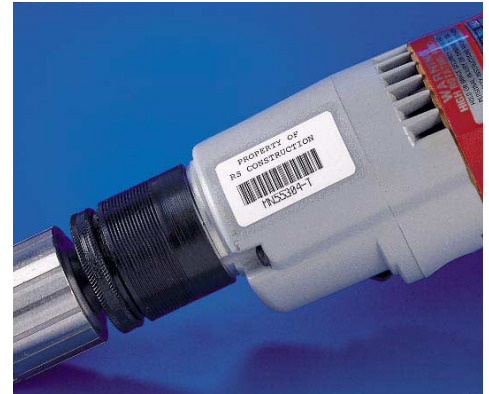

Brady's durable PermaShield™ labels are protected by a clear overlamine film, so they remain clear and easy-to-read, even in harsh environments.

► PERMASHIELD™* LABELS

White Polyester (B-747) **with Clear Polyester Overlamine (B-966)** **Metallized Polyester (B-773)** **with Clear Polyester Overlamine (B-966)**

Part Number	Size Inch (mm)	Specifications on Page
LAT-23-747	1.000 x 0.500 (25.40 x 12.70)	131
LAT-23-773	1.000 x 0.500 (25.40 x 12.70)	131
LAT-24-747	1.750 x 1.000 (44.45 x 25.40)	131
LAT-24-773	1.750 x 1.000 (44.45 x 25.40)	131

*This product is sold in Japan under the Overlamine Labels name and not under the PermaShield name.

► SHEET LABELS FOR PROTOTYPING

Abrasion-Resistant White Polyolefin Film (B-409) **Translucent Polyester (B-722)** **Permanent White or Yellow Polyester (B-747)** **Permanent Metallized Polyester (B-773)**

Part Number	Size Inch (mm)	Specifications on Page
LAT-28-409-25-SH	8.500 x 11.000 (215.90 x 279.40)	132
LAT-28-722-25-SH	8.500 x 11.000 (215.90 x 279.40)	132
LAT-28-747-25-SH	8.500 x 11.000 (215.90 x 279.40)	132
LAT-28-747Y-25-SH	8.500 x 11.000 (215.90 x 279.40)	132
LAT-28-773-25-SH	8.500 x 11.000 (215.90 x 279.40)	132



Available in 8.500" x 11.000" sheets for prototyping labels when you wish to cut your own sizes.

Ink Jet Labels

Ink Jet	
Materials Chart	142
Label Index by Part Number	143
Label Index by Size	144
Self-Laminating Wire and	
Cable Markers by Size	146
Labels by Application	
Circuit Board and	
Component Identification	147
Wire and Cable Marking	148
General and Industrial Identification	149



Ink Jet Printable Materials Chart

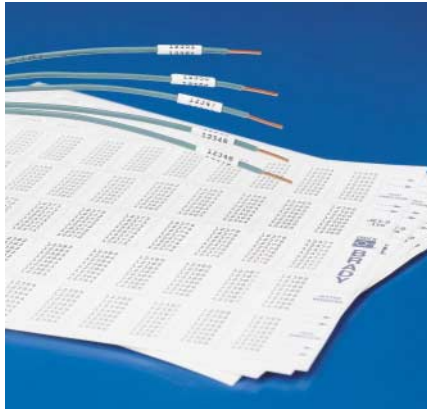

Brady's B-115 vinyl cloth wire markers are easy to print on your ink jet printer.

Type	Max. Service Temp. °F (°C)	Color	Finish	Use	Special Properties
PAPER					
B-113	194 (90)	White	Matte	Bar code and general labeling	High resolution for non-harsh applications
POLYESTER					
B-107	293 (145)	White	Matte	High-performance permanent labeling	Excellent solvent and abrasion resistance
B-966	248 (120)	Clear	Gloss	Overlamine for PermaShield™ labels	Transparent/durable
VINYL					
B-117	158 (70)	White	Matte	Self laminating wire and cable marking	Excellent abrasion and smudge resistance
VINYL CLOTH					
B-115	180 (82)	White	Matte	Primarily for wire and component marking	Repositionable/flexible

Label Index by Part Number

Part Number	Size Inch (mm)	Specifications on Page
JET-1-107	0.375 x 0.375 (9.53 x 9.53)	144
JET-2-107	0.750 x 0.500 (19.05 x 12.70)	145
JET-2-115	0.750 x 0.500 (19.05 x 12.70)	145
JET-3-107	1.437 x 0.500 (36.50 x 12.70)	145
JET-3-115	1.437 x 0.500 (36.50 x 12.70)	145
JET-4-107	0.200 x 0.650 (5.08 x 16.51)	144
JET-4-115	0.200 x 0.650 (5.08 x 16.51)	144
JET-5-107	0.250 x 0.650 (6.35 x 16.51)	144
JET-6-107	0.250 x 0.750 (6.35 x 19.05)	144
JET-7-107	0.250 x 0.800 (6.35 x 20.32)	144
JET-8-107	0.500 x 0.800 (12.70 x 20.32)	144
JET-8-113	0.500 x 0.800 (12.70 x 20.32)	144
JET-9-115	1.437 x 0.800 (36.50 x 20.32)	145
JET-10-107	0.250 x 0.900 (6.35 x 22.86)	144
JET-11-107	0.250 x 1.000 (6.35 x 25.40)	144
JET-11-113	0.250 x 1.000 (6.35 x 25.40)	144
JET-12-107	0.375 x 1.000 (9.53 x 25.40)	144
JET-12-115	0.375 x 1.000 (9.53 x 25.40)	144
JET-13-107	0.500 x 1.000 (12.70 x 25.40)	144
JET-13-113	0.500 x 1.000 (12.70 x 25.40)	144
JET-13-115	0.500 x 1.000 (12.70 x 25.40)	144
JET-14-107	0.750 x 1.000 (19.05 x 25.40)	145
JET-14-113	0.750 x 1.000 (19.05 x 25.40)	145
JET-14-115	0.750 x 1.000 (19.05 x 25.40)	145
JET-15-107	0.750 x 1.250 (19.05 x 31.75)	145
JET-15-115	0.750 x 1.250 (19.05 x 31.75)	145
JET-16-107	0.250 x 1.500 (6.35 x 38.10)	144
JET-16-115	0.250 x 1.500 (38.10 x 6.35)	144

Part Number	Size Inch (mm)	Specifications on Page
JET-17-107	0.500 x 1.500 (12.70 x 38.10)	144
JET-17-113	0.500 x 1.500 (12.70 x 38.10)	144
JET-18-107	0.750 x 1.500 (19.05 x 38.10)	145
JET-18-113	0.750 x 1.500 (19.05 x 38.10)	145
JET-18-115	0.750 x 1.500 (19.05 x 38.10)	145
JET-19-107	1.000 x 1.750 (25.40 x 44.45)	145
JET-19-113	1.000 x 1.750 (25.40 x 44.45)	145
JET-20-107	0.250 x 1.875 (6.35 x 47.63)	144
JET-21-107	0.375 x 1.875 (9.53 x 47.63)	144
JET-22-107	0.833 x 1.875 (21.08 x 21.16)	145
JET-22-113	0.833 x 1.875 (21.08 x 21.16)	145
JET-23-107	0.375 x 2.000 (9.53 x 50.80)	144
JET-23-115	0.375 x 2.000 (9.53 x 50.80)	144
JET-24-113	2.750 x 2.750 (69.85 x 69.85)	145
JET-25-107	0.375 x 3.000 (9.53 x 76.20)	144
JET-26-107-25-SH	8.500 x 11.000 (215.90 x 279.40)	145
JET-26-113-25-SH	8.500 x 11.000 (215.90 x 279.40)	145
JET-27-117	0.500 x 0.750 (12.70 x 19.05)	146
JET-28-117	0.950 x 0.750 (24.13 x 19.05)	146
JET-29-117	0.500 x 1.380 (12.70 x 35.05)	146
JET-30-117	0.950 x 1.380 (24.13 x 35.05)	146
JET-31-117	0.950 x 2.250 (24.13 x 57.15)	146
JET-32-117	1.800 x 2.250 (45.72 x 57.15)	146
JET-33-117	0.950 x 3.750 (24.13 x 95.25)	146
JET-34-117	1.800 x 3.750 (45.72 x 95.25)	146
PJET-1-107	0.500 x 1.000 (12.70 x 25.40)	144
PJET-2-107	1.000 x 1.750 (25.40 x 44.45)	145

Label Index by Size

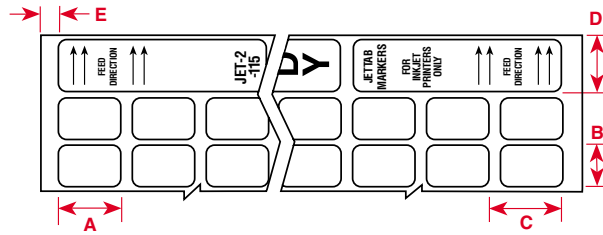

JET-4-107-10

Ink Jet Technology

Die # 4, 0.200" x 0.650" Rating Plate

Material B-107, White Polyester

Package Quantity, 10,000

PART NUMBER EXPLANATION:

Most Brady part numbers for computer printable labels follow the same four-part format: The first code indicates the technology, the second part is a number indicating the die size used (where applicable), the third part indicates the Brady material used (where applicable), and the final code indicates package quantity.

Part Number	Pieces Per Package	Material	Color	Labels Per Row	Label Width Inch (mm) A	Label Height Inch (mm) B	Horizontal Repeat Inch (mm) C	Top Margin Inch (mm) D	Left Margin Inch (mm) E	Labels Per Sheet
0.200" Label Width										
JET-4-107-10	10,000	Polyester	White	26	0.200 (5.08)	0.650 (16.51)	0.308 (7.82)	0.750 (19.05)	0.300 (7.62)	338
JET-4-115-10	10,000	Cloth	White	26	0.200 (5.08)	0.650 (16.51)	0.308 (7.82)	0.750 (19.05)	0.300 (7.62)	338
0.250" Label Width										
JET-5-107-10	10,000	Polyester	White	25	0.250 (6.35)	0.650 (16.51)	0.319 (8.10)	0.750 (19.05)	0.300 (7.62)	325
JET-6-107-10	10,000	Polyester	White	25	0.250 (6.35)	0.750 (19.05)	0.319 (8.10)	0.750 (19.05)	0.300 (7.62)	275
JET-7-107-10	10,000	Polyester	White	25	0.250 (6.35)	0.800 (20.32)	0.319 (8.10)	0.750 (19.05)	0.300 (7.62)	275
JET-10-107-10	10,000	Polyester	White	25	0.250 (6.35)	0.900 (22.86)	0.319 (8.10)	0.750 (19.05)	0.300 (7.62)	250
JET-11-107-10	10,000	Polyester	White	25	0.250 (6.35)	1.000 (25.40)	0.319 (8.10)	0.750 (19.05)	0.300 (7.62)	225
JET-11-113-10	10,000	Paper	White	25	0.250 (6.35)	1.000 (25.40)	0.319 (8.10)	0.750 (19.05)	0.300 (7.62)	225
JET-16-107-10	10,000	Polyester	White	25	0.250 (6.35)	1.500 (38.10)	0.319 (8.10)	0.750 (19.05)	0.300 (7.62)	150
JET-16-115-10	10,000	Cloth	White	25	0.250 (6.35)	1.500 (38.10)	0.319 (8.10)	0.750 (19.05)	0.300 (7.62)	150
JET-20-107-10	10,000	Polyester	White	25	0.250 (6.35)	1.875 (47.63)	0.319 (8.10)	0.750 (19.05)	0.300 (7.62)	125
0.375" Label Width										
JET-1-107-10	10,000	Polyester	White	17	0.375 (9.53)	0.375 (9.53)	0.470 (11.93)	0.750 (19.05)	0.300 (7.62)	357
JET-12-107-10	10,000	Polyester	White	17	0.375 (9.53)	1.000 (25.40)	0.470 (11.93)	0.750 (19.05)	0.300 (7.62)	153
JET-12-115-10	10,000	Cloth	White	17	0.375 (9.53)	1.000 (25.40)	0.470 (11.93)	0.750 (19.05)	0.300 (7.62)	153
JET-21-107-5	5,000	Polyester	White	25	0.375 (9.53)	1.875 (47.63)	0.470 (11.93)	0.750 (19.05)	0.300 (7.62)	85
JET-23-107-5	5,000	Polyester	White	17	0.375 (9.53)	2.000 (50.80)	0.470 (11.93)	0.750 (19.05)	0.300 (7.62)	68
JET-23-115-5	5,000	Cloth	White	17	0.375 (9.53)	2.000 (50.80)	0.470 (11.93)	0.750 (19.05)	0.300 (7.62)	68
JET-25-107-3	3,000	Polyester	White	17	0.375 (9.53)	3.000 (76.20)	0.470 (11.93)	0.750 (19.05)	0.300 (7.62)	51
0.500" Label Width										
JET-8-107-10	10,000	Polyester	White	14	0.500 (12.70)	0.800 (20.32)	0.569 (14.45)	0.750 (19.05)	0.300 (7.62)	154
JET-8-113-10	10,000	Paper	White	14	0.500 (12.70)	0.800 (20.32)	0.569 (14.45)	0.750 (19.05)	0.300 (7.62)	154
PJET-1-107-3	3,000	Polyester	White	9	0.500 (12.70)	1.000 (25.40)	0.925 (23.49)	1.000 (25.40)	0.300 (7.62)	63
JET-13-107-10	10,000	Polyester	White	14	0.500 (12.70)	1.000 (25.40)	0.569 (14.45)	0.750 (19.05)	0.300 (7.62)	126
JET-13-113-10	10,000	Paper	White	14	0.500 (12.70)	1.000 (25.40)	0.569 (14.45)	0.750 (19.05)	0.300 (7.62)	126
JET-13-115-10	10,000	Cloth	White	14	0.500 (12.70)	1.000 (25.40)	0.569 (14.45)	0.750 (19.05)	0.300 (7.62)	126
JET-17-107-5	5,000	Polyester	White	14	0.500 (12.70)	1.500 (38.10)	0.569 (14.45)	0.750 (19.05)	0.300 (7.62)	84
JET-17-113-5	5,000	Paper	White	14	0.500 (12.70)	1.500 (38.10)	0.569 (14.45)	0.750 (19.05)	0.300 (7.62)	84

Note: Labels in chart are sorted in order by width, height, 3 digit material number (within part number), then die number (within part number).

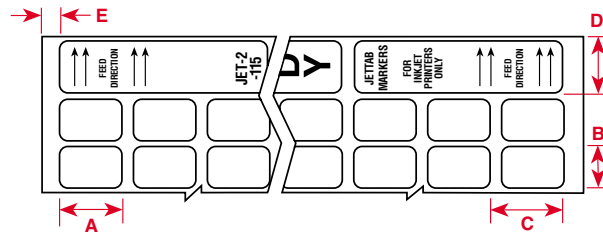

Part Number	Pieces Per Package	Material	Color	Labels Per Row	Label Width Inch (mm) A	Label Height Inch (mm) B	Horizontal Repeat Inch (mm) C	Top Margin Inch (mm) D	Left Margin Inch (mm) E	Labels Per Sheet
0.750" Label Width										
JET-2-107-10	10,000	Polyester	White	9	0.750 (19.05)	0.500 (12.70)	0.894 (22.70)	0.750 (19.05)	0.300 (7.62)	153
JET-2-115-10	10,000	Cloth	White	9	0.750 (19.05)	0.500 (12.70)	0.894 (22.70)	0.750 (19.05)	0.300 (7.62)	153
JET-14-107-5	5,000	Polyester	White	9	0.750 (19.05)	1.000 (25.40)	0.894 (22.70)	0.750 (19.05)	0.300 (7.62)	81
JET-14-113-5	5,000	Paper	White	9	0.750 (19.05)	1.000 (25.40)	0.894 (22.70)	0.750 (19.05)	0.300 (7.62)	81
JET-14-115-5	5,000	Cloth	White	9	0.750 (19.05)	1.000 (25.40)	0.894 (22.70)	0.750 (19.05)	0.300 (7.62)	81
JET-15-107-5	5,000	Polyester	White	9	0.750 (19.05)	1.250 (31.75)	0.894 (22.70)	0.750 (19.05)	0.300 (7.62)	63
JET-15-115-5	5,000	Cloth	White	9	0.750 (19.05)	1.250 (31.75)	0.894 (22.70)	0.750 (19.05)	0.300 (7.62)	63
JET-18-107-3	3,000	Polyester	White	9	0.750 (19.05)	1.500 (38.10)	0.894 (22.70)	0.750 (19.05)	0.300 (7.62)	54
JET-18-113-3	3,000	Paper	White	9	0.750 (19.05)	1.500 (38.10)	0.894 (22.70)	0.750 (19.05)	0.300 (7.62)	54
JET-18-115-3	3,000	Cloth	White	9	0.750 (19.05)	1.500 (38.10)	0.894 (22.70)	0.750 (19.05)	0.300 (7.62)	54
0.833" Label Width										
JET-22-107-3	3,000	Polyester	White	25	0.833 (21.16)	1.875 (47.63)	1.010 (25.65)	0.750 (19.05)	0.300 (7.62)	40
JET-22-113-3	3,000	Paper	White	8	0.833 (21.16)	1.875 (47.63)	1.010 (25.65)	0.750 (19.05)	0.300 (7.62)	40
1.000" Label Width										
PJET-2-107-1.5	1,500	Polyester	White	6	1.000 (25.40)	1.750 (44.45)	0.894 (22.70)	0.750 (19.05)	0.300 (7.62)	24
JET-19-107-3	3,000	Polyester	White	7	1.000 (25.40)	1.750 (44.45)	1.150 (29.21)	0.750 (19.05)	0.300 (7.62)	35
JET-19-113-3	3,000	Paper	White	7	1.000 (25.40)	1.750 (44.45)	1.150 (29.21)	0.750 (19.05)	0.300 (7.62)	35
1.437" Label Width										
JET-3-107-5	5,000	Polyester	White	5	1.437 (36.50)	0.500 (12.70)	1.615 (41.02)	0.750 (19.05)	0.300 (7.62)	85
JET-3-115-5	5,000	Cloth	White	5	1.437 (36.50)	0.500 (12.70)	1.615 (41.02)	0.750 (19.05)	0.300 (7.62)	59
JET-9-115-3	3,000	Cloth	White	5	1.437 (36.50)	0.800 (20.32)	1.615 (41.02)	0.750 (19.05)	0.300 (7.62)	55
2.750" Label Width										
JET-24-113-0.5	500	Paper	White	3	2.750 (69.85)	2.750 (69.85)	2.750 (8.10)	0.750 (19.05)	0.130 (3.30)	9
8.500" Label Width										
JET-26-107-25-SH	25	Polyester	White	1	8.500 (215.90)	11.000 (279.40)	_____	_____	_____	1
JET-26-113-25-SH	25	Paper	White	1	8.500 (215.90)	11.000 (279.40)	_____	_____	_____	1

Note: Labels in chart are sorted in order by width, height, 3 digit material number (within part number), then die number (within part number).

Self-Laminating Wire and Cable Markers by Size

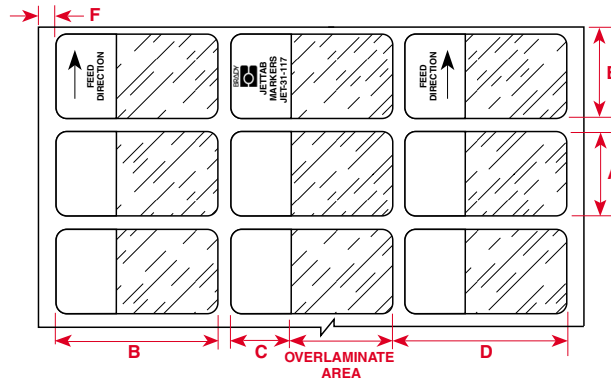

Part Number	Pieces Per Package	Material	Color	Labels Per Row	Width Inch (mm) A	Label Height Inch (mm) B	Label Height Inch (mm) C	Write-On Repeat Inch (mm) D	Horizontal Margin Inch (mm) E	Top Margin Inch (mm) F	Left Labels Per Sheet
0.500" Label Width											
JET-27-117-5	5,000	Vinyl	White/Transparent	8	0.500 (12.70)	0.750 (19.05)	0.380 (9.65)	1.000 (25.40)	0.750 (19.05)	0.425 (10.79)	128
JET-29-117-3	3,000	Vinyl	White/Transparent	5	0.500 (12.70)	1.380 (35.05)	0.500 (12.70)	1.600 (40.64)	0.750 (19.05)	0.425 (10.79)	80
0.950" Label Width											
JET-28-117-3	3,000	Vinyl	White/Transparent	8	0.950 (24.13)	0.750 (19.05)	0.380 (9.65)	0.250 (6.35)	0.750 (19.05)	0.425 (10.79)	72
JET-30-117-2	2,000	Vinyl	White/Transparent	5	0.950 (24.13)	1.380 (35.05)	0.500 (12.70)	1.600 (40.64)	0.750 (19.05)	0.425 (10.79)	45
JET-31-117-1	1,000	Vinyl	White/Transparent	3	0.950 (24.13)	2.250 (57.15)	0.750 (19.05)	2.625 (66.67)	0.750 (19.05)	0.425 (10.79)	27
JET-33-117-1	1,000	Vinyl	White/Transparent	3	0.950 (24.13)	3.750 (95.25)	1.000 (25.40)	4.000 (101.60)	0.750 (19.05)	0.425 (10.79)	18
1.800" Label Width											
JET-32-117-0.5	500	Vinyl	White/Transparent	3	1.800 (45.72)	2.250 (57.15)	0.750 (19.05)	0.375 (9.52)	0.750 (19.05)	0.425 (10.79)	15
JET-34-117-0.5	500	Vinyl	White/Transparent	2	1.800 (45.72)	3.750 (95.25)	1.000 (25.40)	4.000 (101.60)	0.750 (19.05)	0.425 (10.79)	10

Note: Labels in chart are sorted in order by width, height, 3 digit material number (within part number), then die number (within part number).

SELF-LAMINATING WIRE AND CABLE MARKERS BY SIZE INK JET LABELS

Circuit Board and Component Identification

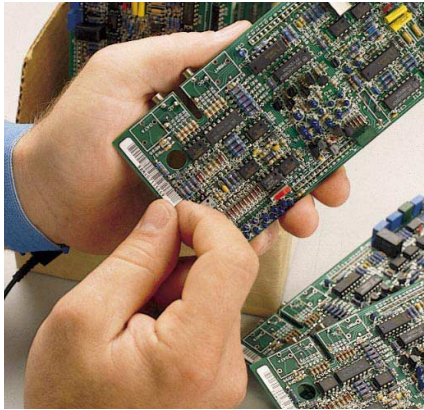

Brady ink jet printable labels are ideal for small volume production runs.

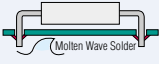
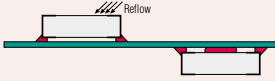

INK JET PRINTABLE CIRCUIT BOARD PROCESS CHART

	 Through Hole Technology Top Bottom	 Surface Mount Technology (SMT) Top or Bottom	After Process
B-107 B-115 B-137	▲ Yes* ✖ No	✖ No	● Yes

* In extreme high temperatures, testing of these materials is recommended.

► POLYESTER

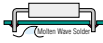
Permanent White Polyester (B-107)

Part Number	Size Inch (mm)	Specifications on Page	 Through Hole Technology Top Bottom	 SMT Top / Bottom	After Process
JET-1-107-10	0.375 x 0.375 (9.53 x 9.53)	144	▲	✖	●
JET-4-107-10	0.200 x 0.650 (5.08 x 16.51)	144	▲	✖	●
JET-5-107-10	0.250 x 0.650 (6.35 x 16.51)	144	▲	✖	●
JET-6-107-10	0.250 x 0.750 (6.35 x 19.05)	144	▲	✖	●
JET-7-107-10	0.250 x 0.800 (6.35 x 20.32)	144	▲	✖	●
JET-8-107-10	0.500 x 0.800 (12.70 x 20.32)	144	▲	✖	●
JET-10-107-10	0.250 x 0.900 (6.35 x 22.86)	144	▲	✖	●
JET-11-107-10	0.250 x 1.000 (6.35 x 25.40)	144	▲	✖	●
JET-12-107-10	0.375 x 1.000 (9.53 x 25.40)	144	▲	✖	●
JET-13-107-10	0.500 x 1.000 (12.70 x 25.40)	144	▲	✖	●
JET-16-107-10	0.250 x 1.500 (6.35 x 38.10)	144	▲	✖	●
JET-20-107-10	0.250 x 1.875 (6.35 x 47.63)	144	▲	✖	●
JET-21-107-5	0.375 x 1.875 (9.53 x 47.63)	144	▲	✖	●
JET-23-107-5	0.375 x 2.000 (9.53 x 50.80)	144	▲	✖	●
JET-25-107-3	0.375 x 3.000 (9.53 x 76.20)	144	▲	✖	●

● Yes, this material will work with this application.

✖ No, this material does not work with this application.

▲ In extreme high temperatures, testing of these materials is recommended.

Circuit Board and Component Identification

MISCELLANEOUS MATERIALS

White Repositionable Vinyl Cloth Tape (B-115)

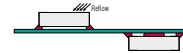
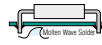

Part Number	Size Inch (mm)	Specifications on Page	Through Hole Technology Top	Through Hole Technology Bottom	SMT Top / Bottom	After Process
JET-4-115	0.200 x 0.650 (5.08 x 16.51)	144	▲	✘	✘	●
JET-12-115	0.375 x 1.000 (9.53 x 25.40)	144	▲	✘	✘	●
JET-13-115	0.500 x 1.000 (12.70 x 25.40)	144	▲	✘	✘	●
JET-23-115	0.375 x 2.000 (9.53 x 50.80)	144	▲	✘	✘	●

- Yes, this material will work with this application.
- ✘ No, this material does not work with this application.
- ▲ In extreme high temperatures, testing of these materials is recommended.

Wire and Cable Marking

White Repositionable Vinyl Cloth Tape (B-115)

Self-Laminating Vinyl (B-117)

Part Number	Size Inch (mm)	Specifications on Page
JET-2-115	0.750 x 0.500 (19.05 x 12.70)	145
JET-3-115	1.437 x 0.500 (36.50 x 12.70)	145
JET-9-115	1.437 x 0.800 (36.50 x 20.32)	145
JET-14-115	0.750 x 1.000 (19.05 x 25.40)	145
JET-27-117	0.750 x 0.500 (19.05 x 12.70)	145
JET-28-117	0.950 x 0.750 (24.13 x 19.05)	146
JET-29-117	0.500 x 1.380 (12.70 x 35.05)	146
JET-30-117	0.950 x 1.380 (24.13 x 35.05)	146
JET-31-117	0.950 x 2.250 (24.13 x 57.15)	146
JET-32-117	1.800 x 2.250 (45.72 x 57.15)	146
JET-33-117	0.950 x 3.750 (24.13 x 95.25)	146
JET-34-117	1.800 x 3.750 (45.72 x 95.25)	146

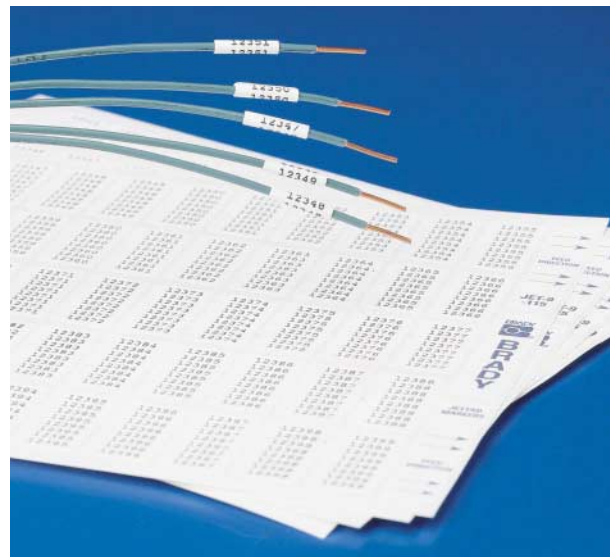

Brady's B-115 vinyl cloth wire markers are easy to print on your ink jet printer.

► RATING PLATES AND ASSET IDENTIFICATION

Permanent White Polyester (B-107)

Part Number	Size Inch (mm)	Specifications on Page
JET-15-107	0.750 x 1.250 (19.05 x 31.75)	145
JET-18-107	0.750 x 1.500 (19.05 x 38.10)	145

Permanent White Polyester (B-107)

Part Number	Size Inch (mm)	Specifications on Page
JET-2-107	0.750 x 0.500 (19.05 x 12.70)	145
JET-3-107	1.437 x 0.500 (36.50 x 12.70)	145
JET-8-107	0.500 x 0.800 (12.70 x 20.32)	144
JET-13-107	0.500 x 1.000 (12.70 x 25.40)	144
JET-14-107	0.750 x 1.000 (19.05 x 25.40)	145
JET-15-107	0.750 x 1.250 (19.05 x 31.75)	145
JET-17-107	0.500 x 1.500 (12.70 x 38.10)	144
JET-18-107	0.750 x 1.500 (19.05 x 38.10)	145
JET-19-107	1.000 x 1.750 (25.40 x 44.45)	145
JET-22-107	0.833 x 1.875 (21.16 x 47.63)	145

White Paper (B-113)

Part Number	Size Inch (mm)	Specifications on Page
JET-8-113	0.500 x 0.800 (12.70 x 20.32)	144
JET-11-113	0.250 x 1.000 (6.35 x 25.40)	144
JET-13-113	0.500 x 1.000 (12.70 x 25.40)	144
JET-14-113	0.750 x 1.000 (19.05 x 25.40)	145
JET-17-113	0.500 x 1.500 (12.70 x 38.10)	144
JET-18-113	0.750 x 1.500 (19.05 x 38.10)	145
JET-19-113	1.000 x 1.750 (25.40 x 44.45)	145
JET-22-113	0.833 x 1.875 (21.16 x 47.63)	145
JET-24-113	0.275 x 0.275 (6.99 x 6.99)	144
JET-26-113-SH	8.500 x 11.000 (215.90 x 279.40)	145

► PERMASHIELD™* LABELS

**Permanent White Polyester (B-107)
Clear Polyester Overlaminates (B-966)**

Part Number	Size Inch (mm)	Specifications on Page
PJET-1-107	0.500 x 1.000 (12.70 x 25.40)	144
PJET-2-107	1.000 x 1.750 (25.40 x 44.45)	145

* This product is sold in Japan under the Overlaminates Labels name and not under the PermaShield name.

► FULL SHEET LABELS FOR PROTOTYPING

**Permanent White Polyester (B-107)
White Paper (B-113)**

Part Number	Size Inch (mm)	Specifications on Page
JET-26-107-SH	8.500 x 11.000 (215.90 x 279.40)	145
JET-26-113-SH	8.500 x 11.000 (215.90 x 279.40)	145



Where abrasion resistance is required, Brady's B-107 polyolefin answers the call.













Brady's B-113 inkjet printable paper is suitable for indoor environments where high performance is not required.





Brady's durable PermaShield labels are protected by a clear overlaminates film so they remain clear and easy-to-read, even in harsh environments.

Dot Matrix Labels

Dot Matrix Materials Chart	151
Sleeve and Datab® Printer	152
Ribbons and Accessories	153
SLV-DAT-PRO Printer	154
Label Index by Part Number	155
Label Index by Size	158
Labels by Application	
Circuit Board and Component Identification	177
Wire and Cable Marking	181
Terminal Block Marking	187
General and Industrial Identification	189
Sleeves for Wire and Cable Identification	191
DuraSleeve™ Wire Marking System	198

Type	Max. Service Temp. °F (°C)	Color	Finish	Use	Special Properties
ALUMINUM FOIL					
B-184	266 (130)	Silver	Matte	Wire marking, general labeling	Conformable; adheres well to rough surfaces
B-917	266 (130)	Silver	Matte	Rating plates, general labeling	Full hard aluminum
BRADYTAG® MATERIALS					
B-109 Polyethylene	120 (49)	White	Matte	Multi-purpose tagging	Tear- and chemical- resistant
B-503 Cloth	194 (90)	White	Matte	Wire and cable marking	Meets UL94VTM-0 for self-extinguishing 
B-508 Nomex®	180 (82)	White/Yellow	Matte	High-performance wire bundle and cable identification tag	Computer-printable tag stock; material is self-extinguishing
B-620 Polyester	311 (155)	White	Matte	All-purpose marking	Resistant to harsh industrial solvents
CLEAR OVERLAMINATES					
B-621 Polyester	248 (120)	Clear	Matte	Computer-printable overlaminate	Translucent
NYLON CLOTH					
B-499	194 (90)	White	Matte	Wire and electronic component marking	Permanent adhesive
PAPER					
B-110	212 (100)	White	Matte	Wire and electronic component marking	Excellent conformability
B-121	158 (70)	White	Matte	General labeling	Removable adhesive
B-122	193 (90)	White	Matte	General labeling	Label destroys upon removal
B-124	150 (66)	White/Colors	Matte	110 terminal block marking	Available in green, purple, yellow, blue, red, brown, white, orange and gray
B-609	158 (70)	White	Matte	Tamper-resistant label	Label destroys upon removal
POLYESTER					
B-164	267 (130)	Silver	Matte	Electronic component marking	Withstands vapor phase and wave soldering operations; silver
B-505	266 (130)	White	Matte	Designed to be used as a connector pull tab	Self-extinguishing white polyester with a zone coated, permanent pressure sensitive acrylic adhesive Passes the requirements of UL94 VTM-0 
B-619	293 (145)	White	Matte	Electronic component, bar code label	Circuit board ID  
B-621	248 (120)	Clear	Matte	Printable overlaminate	Translucent
B-624	248 (120)	White	Matte	Bar code labels	Adheres well to rough surfaces
B-627	248 (120)	White	Matte	High-quality labels, emblems and rating plates	High heat resistance; dimensional stability. Treated for better ink receptivity 
B-673	293 (145)	Silver	Matte	Electronic component ID (EPROM)	UV-light opaque; removable; metallized
B-693	248 (120)	Silver	Matte	Rating plates	Low-cost metallized material
B-969	293 (145)	Silver	Matte	Rating plates, electronic component marking	Metallized  
POLYIMIDE					
B-652	572 (300)	Amber	Matte	Top- or bottom-side board application for SMT or Through hole	Withstands extremely high temperatures
B-658	518 (270)	Amber	Matte	Printed circuit board and component marking	Label will remove cleanly after high temperature exposure
POLYPROPYLENE					
B-389	212 (100)	White	Matte	Wire marking	Printable rigid inserts designed to be printed and affixed to a wire using carriers
SLEEVE MATERIALS					
B-319 Polyolefin	221 (105)	White	Matte	Wire marking	Non-shrink sleeve
B-321 Polyolefin	221 (105)	White/Yellow	Matte	Wire marking	Heat-shrinkable sleeve
B-322 Polyolefin	221 (105)	White/Yellow	Matte	Aerospace and military wire marking	Self-extinguishing; meets MIL-S-85848
B-330 Polyolefin	248 (120)	White	Matte	Identification of wire bundles, large conduits and installed cables	Heat-shrinkable film with a computer-printable topcoat and a heat-activating adhesive
B-341 Polyolefin	275 (135)	White	Matte	Wire marking	2-to-1 shrink ratio self-extinguishing sleeve; meets MIL-I-23053/5 Class 1; MIL-M-81531; MIL-STD-202F; METHOD 215 and UL 224 
B-342 Polyolefin	275 (135)	White/Yellow	Matte	Wire marking	3-to-1 shrink ratio self-extinguishing sleeve; meets MIL-I-23053/5 Class 1; MIL-M-81531; MIL-STD-202F; METHOD 215 and UL 224 
TEDLAR®					
B-632	266 (130)	White	Matte	Wire marking	Self-extinguishing
B-637	266 (130)	White/Yellow	Matte	Aerospace and military cable marking	Self-extinguishing; meets MIL-M-87958, available in white or yellow
B-642	266 (130)	White	Matte	Self-laminating, wire and cable marking	Excellent abrasion and smudge resistance
VINYL CLOTH					
B-502	180 (82)	White	Matte	Wire and electronic component marking	Repositionable adhesive
VINYL FILM					
B-292	150 (66)	White	Matte	Self-laminating, wire and cable marking	Excellent abrasion and smudge resistance
B-607	158 (70)	White	Matte	Tamper-resistant label	Label destroys upon removal  

Tedlar® is a registered trademark of DuPont.

 *These materials are UL recognized.
 *These materials are CSA approved.

*Refer to the full page charts on pages 280-281 for more information and complete listing of parts.

Sleeve and Datab® Printer

The SLV-DAT-PTR 24 pin printer is designed to print on all Brady pin-fed products. Using your computer and LabelMark™ software, you can utilize BradySleeve™, PermaSleeve™, DuraSleeve® and Datab® materials.

▶ PRODUCT GUIDE

Specification/ Characteristic	Detail
Model	Lexmark 2390 Plus (Modified)
Technology	Dot Matrix
Speed at 10 cpi	233 cps (fast draft) 210 cps (draft) 70 cps (near letter quality)
Speed at 12 cpi	252 cps (fast draft) 252 cps (draft) 84 cps (near letter quality)
Memory	32KB
Network Support	Lexmark external print servers
Compatibility	IBM PPS II 2390/91; Proprinter 24P, 24E, XL24E; Execjet, Epson, LQ-850; LQ-1050; IBM PS/1 printer
Print Quality	Letter quality Near letter quality 360 x 360 dpi graphics
Font Selection	8 resident 7 resident bar codes
Maximum Print Width	8.000" (203.20 mm)
Paper Handling	Virtually straight paper path; friction feed; movable push/pull tractors; four bottom/front paper feeds; auto-load assist
Usability Features	One-touch control panel; panel-selectable forms macros; easy front loading; quiet mode; variable forms-length settings
Environmental Features	Complies with the EPA's Energy Star program for low power consumption
Size/Weight	7.500" H x 19.600" W x 11.300" D; 14.8 lbs.
Acoustics	55 decibels running 53.3 decibels in quiet mode (51 decibels with acoustic option)
Supplies	Provided with a series R5000 ribbon (R5390) re-inking ribbon. Also available is a series R2000 ribbon (R2080) non-re-inking ribbon (recommended for B-619 and B-969 materials)
Duty Cycle	25% average usage: 500,000 char/month

Part Number	Description
SLV-DAT-PTR	Sleeve and Datab Printer



The SLV-DAT-PTR is ideal for printing on all pin-fed materials.

► **RIBBONS FOR PERMASLEEVE™
WIRE MARKERS**

Recommended for the best performance when printing PermaSleeve markers – before and after shrinkage. Legends on your PermaSleeve markers are resistant to smudging, fading, a variety of chemicals and other harsh environments. Meets the rigid marking requirements of: MIL-I-23053/5 Class 1, MIL-M-81531, MIL-STD-202F, METHOD 215 and UL224.

Part Number	Description
R5072	BLW-3-PS BradyWriter™-III PermaSleeve Printer
R5050	PS-PTR PermaSleeve Printer
R5100	BMXC-PS-PTR BradyMarker™ PermaSleeve Printer
R5300	ID PRO PermaSleeve Printer
R5380	PS-PTR-II PermaSleeve Printer
R5390	SLV-DAT-PTR Printer PermaSleeve and Datab® Printer

► **SERIES 2000™ RIBBONS FOR
DOT MATRIX PRINTERS**

For legend performance you can't get with an ordinary ribbon, Brady offers the remarkable Series 2000 Ribbon. This fabric ribbon is impregnated with a high-performance indelible ink that dries quickly, won't smear and won't bleed, fade or run when exposed to UV light, weathering or solvents such as 1,1,1-trichloroethane, isopropyl alcohol, Skydrol® 500B and Super Agitene®.

Series 2000 Ribbons come in stock cartridge sizes to fit many IBM, Printronix, Centronix, DEC, Okidata and Epson printers. They are also available as a custom product for use in many other printer cartridges. Regular cleaning of your printer is recommended when using the high-performance Series 2000 Ribbons. See next page for the dot matrix printer cleaning kit.

Skydrol® is a registered trademark of the Monsanto Company. Super Agitene® is a registered trademark of Graymills Corporation.



Ribbon List Series 2000™

Part Number	Description
R2001	C-Itch CI-300 • DEC 6904 • IBM P300, P600, 6408 • Printronix 300P 600, 3000, 6000, 6080, 9000, L150, L600, L9012 • MPV150, MZP3122, P300, P300 BM1717, P300XQ, P6240, P9012 • Series 60 Z-ICOH C1800 • STD Diagnostic P300 Wallace 300 LPM • Weber Legitronic 50/55/60
R2005	C-Itch 5800 • DEC LA30-36, LA36 • IBM 1443, 2203, 2560, 2780 • ITT 700795-001, Courier 9315 • Texas Instruments 810, 810 in spools • T.I. OMNI 800, 810 • Univac 0798
R2008	DEC LA120, LA180, LA78 • DIGITAL 120/180 • Digital DECWriter III Genecom 1795 • Texas Instruments 820 • Teleprinter 1000 • T.I. OMNI 800, 810, 820 RO
R2012	Centronics 101
R2020	Adler SE 1000C • Facit 1850, 1860, 80, 85, 850, 4248 • IBM 82C, TEK 3, Selectric Typewriter, Selectric II 82, 85, 95 • Macintosh Imagewriter • Olympia 6010, 6020, 6510, 6610 • Royal SE 1000C, 6000, 5000C • Triumph Adler
R2021	IBM 5211-1-2-A-B, IBM System 34 Model 1-2, IBM System 38-5211
R2022	IBM Silver Dollar 3715
R2023	IBM 3262, 5262, IBM 38-4331/5261, IBM 34-3262
R2024	IBM Silver Dollar 3287, IBM 38-1-2-3, IBM 5320-A, IBM 535
R2025	IBM 4207, Proprietary 4201, 4201-001, 4207, 6328829, II • MT4201-002, X-24 4201, X-24 4207
R2050	BradyPrinter™ PS • Citizen HSP-500, MSP-10, MSP-20, MSP-50 • Epson Action Printer 2000, 2500, T1000, 3210, 810, 8750F, Apex 80 • FX26E, FX80, FX800, FX85, FX850, FX86, FX86E, FX870, GX80 • LX 300, LX400, LX800, LX810, LX850, MX7080, MX80, MX800 • RX80, SX80, T1000 • Hewlett Packard 82905A, 92156A • Honeywell 4/20 • IBM 5125, M1724, Proprietary 5152 • NCR 7052, 7053, 8750

Part Number	Description
R2051	Alps 2000, P2000G • Citizen MSP-15, MSP-15E, MSP-45, MSP-55 • DM2015 • Epson 286E, FX100, FX100+, FX105, FX1050, FX185, FX286 • FX286E, FX 1000, FX 1170, LX1000, MX100, MX1000, MX1003, PX100 • RX100, RX1000, SX1050, Action Printer T-750 • Honeywell Italia 4/21, 4/23 • Olympia MP-136, NP36
R2052	Epson 4000, 510, L1000, LQ400, LQ500, LQ510, LQ550 • LQ800, LQ850, LQ570, LQ870, Action Printer 3000, 4000, 5000, LQ800 • Genicom 20/GP20
R2053	Citizen 224 • Epson Action Printer 4500,5500,5550,1750 • LQ1000, LQ1010, LQ1050, LQ1070, LQ1070+, LQ 1170, LX1050
R2060	Apple Imagewriter I, II • AT & T 471, 473, 474, 476, 580 • C-Itch 1550, 1550C, 1550SP 7500, 8500, 8510, 9500, C310, C315, M1550 • Data Products 9030 • DEC 1150, LA50, LA75, LA-75P • IBM 4971, 5533 • Macintosh II • NEC 8023, 8023A, 8025A, LA50 • NCR 6411, 572, 8510 • Telex 281 B/C/D • Toshiba Imagewriter I
R2065	Okidata 120, 80, 80-82, 82, 8283, 82A, 83, 90, 92, 921, 93 • 93+, U83, U92, U93, UAB-3, Star Delta 10, LV1210, LV1215 • SG10, Gemini 10X • Micronics SG-1015
R2070	BradyWriter™ I
R2071	BradyWriter II (24-pin) • Alps 224E, ALQ-224 • Tandy DMT-2100P • Toshiba 1340, 351, P1340, P1350, P1351, P321, P341, P351
R2072	BradyWriter II, III • Okidata 292 • Siemens 9011-18, 9011-28
R2080	IBM 2380, 2381, 2390, 2391, PS-PTR-II, SLV-DAT-PTR
R2081	Okidata 182,192,193,320,321
R2082	Okidata 520, 521
R2083	Panasonic KXP 1150/KXP 1695
R2100	BMCX-Plus

Ribbons and Accessories

► SERIES 5000™ RIBBONS FOR DOT MATRIX PRINTERS

The series 5000 indelible re-inking ribbon has been designed to provide a permanent image that will not smear, fade or smudge when exposed to UV light, chemicals, and gases.

Brady offers the series 5000 in-stock cartridges to fit many Panasonic and Okidata printers.

Ribbon List Series 5000™

Part Number	Description
R5007	Panasonic KX-P Printers 1524, 1540, 1624, 155, 130, 140 • Rolland DGPR-2450
R5009	Panasonic KX-P Printers 1080, 1082, 1083, 1090, 1091, 1092, 1123, 1124, 1180, 1592, 1595, 1695, 110 • Rolland DGPR 1012, 1212, 1215, 1250, 9101
R5074	Okidata Microline Printers 172, 180, 182, 183, 192, 193, 320, 321, 194, 195

► PRINTER CLEANING KIT

The Brady Printer Cleaning Kit is ideal for keeping BradyWriter and BradyMarker™ XC printers, LS2000, SLV-DAT or any other dot matrix printer in peak operating condition.



The kit includes an ozone-safe precision duster, ink removal pads, printer cleaning solution, cloth wipes and pin-feed print element cleaning sheets. Also included is a complete set of cleaning instructions in five different languages.

Part Number	Description
PCK-1	BMXC, LS2000, SLV-DAT Printer Cleaning Kit

SLV-DAT-PRO Printer



Part Number	Description
SLV-DAT-PRO	SLV-DAT-PRO Printer
R5490	Ribbon for the SLV-DAT-PRO

► SPECIFICATIONS

Model	3300 - Single tractor V-throat
Speed	DP Mode - 333 cps Draft Mode - 250 cps DLQ Mode - 75 cps
Pitches (cpi)	DP/Draft - 10, 12, 13.2, 15, 16, 16.5, 17.6, 18, 20
Print head	9-wire with 300m character life
Print width	8.8" - 88 columns at 10 cpi
Graphics	Horizontal - 60, 72, 8, 090, 120, 240 dpi Vertical - 72, 216 dpi

For the industrial Dot Matrix solution, Brady offers the SLV-DAT-PRO printer. This printer gives a well-rounded offering to Dot Matrix applications, and is designed for those who have a heavy amount of pin-fed Brady materials to print using Dot Matrix technology. The SLV-DAT-PRO is an upgrade to the SLV-DAT printer. This Brady benchtop was developed specifically with BradySleeve, PermaSleeve and Datab materials in mind; the SLV-DAT-PRO finally gives a true industrial Dot Matrix solution.

Additional offerings such as ease of use, and outstanding performance add to the SLV-DAT-PRO's benefits.

► FEATURES

- Automatic calibration – adjusts to the label thickness and selection of first print line without any user interaction
- Ability to fit heavy printing demands
- Ability to store the feature settings for commonly used applications
- Designed to print all Brady pin feed materials in mass quantities

► BENEFITS

- Durability allows for extensive amounts of printing
- Cost savings; 7-10-million character average per cartridge ribbon minimizes ribbon changes
- Documents-on-demand with a 0" tear off form ideal for packing slips and invoices
- A high-powered print head assures legibility on every copy
- Easy-to-use operation panel; quick access menus

► DAT SERIES

Datab® Labels

Part Number	Size Inch (mm)	Specifications on Page	Part Number	Size Inch (mm)	Specifications on Page
DAT-1-637*	0.900 x 0.250 (22.86 x 6.35)	160	DAT-38-292-YL	2.000 x 2.250 (50.80 x 57.15)	173
DAT-2-637*	1.250 x 0.375 (31.75 x 9.53)	161	DAT-39-292	1.000 x 3.750 (25.40 x 95.25)	173
DAT-3-637	1.500 x 0.750 (38.10 x 19.05)	164	DAT-39-292-BL	1.000 x 3.750 (25.40 x 95.25)	173
DAT-4-637	1.500 x 0.750 (38.10 x 19.05)	164	DAT-39-292-BR	1.000 x 3.750 (25.40 x 95.25)	173
DAT-5-499	0.800 x 1.437 (20.32 x 36.50)	160	DAT-39-292-GR	1.000 x 3.750 (25.40 x 95.25)	173
DAT-5-502	0.800 x 1.437 (20.32 x 36.50)	160	DAT-39-292-GY	1.000 x 3.750 (25.40 x 95.25)	173
DAT-6-632	0.800 x 1.437 (20.32 x 36.50)	160	DAT-39-292-OR	1.000 x 3.750 (25.40 x 95.25)	173
DAT-7-292	0.800 x 1.437 (20.32 x 36.50)	170	DAT-39-292-PL	1.000 x 3.750 (25.40 x 95.25)	173
DAT-8-292*	1.900 x 3.187 (48.26 x 80.95)	170	DAT-39-292-RD	1.000 x 3.750 (25.40 x 95.25)	173
DAT-9-292*	2.000 x 5.937 (50.80 x 150.80)	171	DAT-39-292-YL	1.000 x 3.750 (25.40 x 95.25)	173
DAT-10-637*	1.250 x 0.375 (31.75 x 9.53)	161	DAT-40-292	2.000 x 3.750 (50.80 x 95.25)	173
DAT-11-499	1.000 x 0.375 (25.40 x 9.53)	161	DAT-40-292-BL	2.000 x 3.750 (50.80 x 95.25)	173
DAT-11-502	1.000 x 0.375 (25.40 x 9.53)	161	DAT-40-292-BR	2.000 x 3.750 (50.80 x 95.25)	173
DAT-12-502*	2.000 x 0.375 (50.80 x 9.53)	161	DAT-40-292-GR	2.000 x 3.750 (50.80 x 95.25)	173
DAT-13-502	3.000 x 0.375 (76.20 x 9.53)	162	DAT-40-292-GY	2.000 x 3.750 (50.80 x 95.25)	173
DAT-14-292*	2.000 x 1.437 (50.80 x 188.90)	171	DAT-40-292-OR	2.000 x 3.750 (50.80 x 95.25)	173
DAT-15-502	0.650 x 0.200 (16.51 x 5.08)	159	DAT-40-292-PL	2.000 x 3.750 (50.80 x 95.25)	173
DAT-16-607	0.650 x 0.200 (16.51 x 5.08)	159	DAT-40-292-RD	2.000 x 3.750 (50.80 x 95.25)	173
DAT-17-619	0.650 x 0.200 (16.51 x 5.08)	159	DAT-40-292-YL	2.000 x 3.750 (50.80 x 95.25)	173
DAT-18-499	1.000 x 0.500 (25.40 x 12.70)	160	DAT-41-292*	1.000 x 5.937 (25.40 x 150.80)	170
DAT-18-502	1.000 x 0.500 (25.40 x 12.70)	160	DAT-42-292*	1.000 x 7.437 (25.40 x 188.50)	170
DAT-19-607	1.000 x 0.500 (25.40 x 12.70)	160	DAT-43-502	0.500 x 0.437 (12.70 x 11.10)	159
DAT-20-619	1.000 x 0.500 (25.40 x 12.70)	160	DAT-44-607	0.500 x 0.437 (12.70 x 11.10)	159
DAT-21-110	0.500 x 1.437 (12.70 x 36.50)	159	DAT-45-619	0.500 x 0.437 (12.70 x 11.10)	159
DAT-23-637*	1.250 x 0.375 (31.75 x 9.53)	161	DAT-46-693	0.500 x 0.437 (12.70 x 11.10)	159
DAT-24-502	0.500 x 1.437 (12.70 x 36.50)	159	DAT-46-969	0.500 x 0.437 (12.70 x 11.10)	159
DAT-25-502	0.750 x 0.250 (19.05 x 6.35)	159	DAT-47-693	1.000 x 0.500 (25.40 x 12.70)	160
DAT-26-607	0.750 x 0.250 (19.05 x 6.35)	159	DAT-47-969	1.000 x 0.500 (25.40 x 12.70)	160
DAT-27-619	0.750 x 0.250 (19.05 x 6.35)	159	DAT-48-693	1.500 x 0.750 (38.10 x 19.05)	164
DAT-28-121	1.500 x 0.250 (38.10 x 6.35)	164	DAT-48-969	1.500 x 0.750 (38.10 x 19.05)	164
DAT-29-502	1.500 x 0.250 (38.10 x 6.35)	164	DAT-49-637	0.900 x 0.250 (22.86 x 6.35)	160
DAT-30-292*	0.500 x 0.750 (12.70 x 19.05)	170	DAT-50-652	0.900 x 0.250 (22.86 x 6.35)	160
DAT-31-502*	0.500 x 0.750 (12.70 x 19.05)	159	DAT-51-619	1.000 x 0.375 (25.40 x 9.53)	161
DAT-32-632*	0.500 x 0.750 (12.70 x 19.05)	159	DAT-52-642	0.800 x 1.437 (20.32 x 36.50)	170
DAT-33-292	0.500 x 1.437 (12.70 x 36.50)	172	DAT-53-642	0.500 x 1.437 (12.70 x 36.50)	172
DAT-34-292	1.000 x 1.437 (25.40 x 36.50)	172	DAT-54-642	1.000 x 1.437 (25.40 x 36.50)	172
DAT-34-292-BL	1.000 x 1.437 (25.40 x 36.50)	172	DAT-55-642*	0.500 x 0.750 (12.70 x 19.05)	170
DAT-34-292-BR	1.000 x 1.437 (25.40 x 36.50)	172	DAT-56-637	0.650 x 0.200 (16.51 x 5.08)	159
DAT-34-292-GR	1.000 x 1.437 (25.40 x 36.50)	172	DAT-57-637	1.000 x 0.500 (25.40 x 12.70)	160
DAT-34-292-GY	1.000 x 1.437 (25.40 x 36.50)	172	DAT-58-652	0.650 x 0.200 (16.51 x 5.08)	159
DAT-34-292-OR	1.000 x 1.437 (25.40 x 36.50)	172	DAT-59-652	1.000 x 0.500 (25.40 x 12.70)	160
DAT-34-292-PL	1.000 x 1.437 (25.40 x 36.50)	172	DAT-60-619	0.900 x 0.250 (22.86 x 6.35)	160
DAT-34-292-RD	1.000 x 1.437 (25.40 x 36.50)	172	DAT-63-292	1.900 x 3.187 (48.26 x 80.95)	170
DAT-34-292-YL	1.000 x 1.437 (25.40 x 36.50)	172	DAT-64-502	2.000 x 0.375 (50.80 x 9.53)	161
DAT-35-292	2.000 x 1.437 (50.80 x 36.50)	173	DAT-65-292	2.000 x 7.437 (50.80 x 188.90)	171
DAT-36-292	0.750 x 1.750 (19.05 x 44.45)	170	DAT-66-292	0.500 x 0.750 (12.70 x 19.05)	170
DAT-37-292	1.000 x 2.250 (25.40 x 57.15)	172	DAT-67-499	0.500 x 0.750 (12.70 x 19.05)	159
DAT-37-292-BL	1.000 x 2.250 (25.40 x 57.15)	172	DAT-67-502	0.500 x 0.750 (12.70 x 19.05)	159
DAT-37-292-BR	1.000 x 2.250 (25.40 x 57.15)	172	DAT-68-632	0.500 x 0.750 (12.70 x 19.05)	159
DAT-37-292-GR	1.000 x 2.250 (25.40 x 57.15)	172	DAT-69-292	1.000 x 5.937 (25.40 x 150.80)	170
DAT-37-292-GY	1.000 x 2.250 (25.40 x 57.15)	172	DAT-69-292-BL	1.000 x 5.937 (25.40 x 150.80)	170
DAT-37-292-OR	1.000 x 2.250 (25.40 x 57.15)	172	DAT-69-292-BR	1.000 x 5.937 (25.40 x 150.80)	170
DAT-37-292-PL	1.000 x 2.250 (25.40 x 57.15)	172	DAT-69-292-GR	1.000 x 5.937 (25.40 x 150.80)	170
DAT-37-292-RD	1.000 x 2.250 (25.40 x 57.15)	172	DAT-69-292-GY	1.000 x 5.937 (25.40 x 150.80)	170
DAT-37-292-YL	1.000 x 2.250 (25.40 x 57.15)	172	DAT-69-292-OR	1.000 x 5.937 (25.40 x 150.80)	170
DAT-38-292	2.000 x 2.250 (50.80 x 57.15)	173	DAT-69-292-PL	1.000 x 5.937 (25.40 x 150.80)	170
DAT-38-292-BL	2.000 x 2.250 (50.80 x 57.15)	173	DAT-69-292-RD	1.000 x 5.937 (25.40 x 150.80)	170
DAT-38-292-BR	2.000 x 2.250 (50.80 x 57.15)	173	DAT-69-292-YL	1.000 x 5.937 (25.40 x 150.80)	170
DAT-38-292-GR	2.000 x 2.250 (50.80 x 57.15)	173	DAT-70-292	1.000 x 7.437 (25.40 x 188.90)	170
DAT-38-292-GY	2.000 x 2.250 (50.80 x 57.15)	173	DAT-71-642	0.500 x 0.750 (12.70 x 19.05)	170
DAT-38-292-OR	2.000 x 2.250 (50.80 x 57.15)	173	DAT-72-637	1.250 x 0.375 (31.75 x 9.53)	161
DAT-38-292-PL	2.000 x 2.250 (50.80 x 57.15)	173	DAT-73-637	1.250 x 0.375 (31.75 x 9.53)	161
DAT-38-292-RD	2.000 x 2.250 (50.80 x 57.15)	173	DAT-74-637	1.250 x 0.375 (31.75 x 9.53)	161

* Wide Web. Will not fit narrow carriage (80-column printers).
See page 158 for identical narrow carriage labels.

Label Index by Part Number

► DAT SERIES

Datab® Labels

Part Number	Size Inch (mm)	Specifications on Page	Part Number	Size Inch (mm)	Specifications on Page
DAT-75-292	2.000 x 5.937 (50.80 x 150.80)	171	DAT-140-502	0.300 x 0.937 (7.62 x 23.80)	158
DAT-77-969	2.000 x 0.900 (50.80 x 22.86)	161	DAT-141-632	0.300 x 0.937 (7.62 x 23.80)	158
DAT-78-969	3.000 x 0.900 (76.20 x 22.86)	162	DAT-142-292	0.300 x 0.937 (7.62 x 23.80)	172
DAT-79-969	2.000 x 1.437 (50.80 x 36.50)	161	DAT-143-502	0.500 x 0.937 (12.70 x 23.80)	159
DAT-80-969	3.000 x 1.437 (76.20 x 36.50)	162	DAT-144-632	0.500 x 0.937 (12.70 x 23.80)	159
DAT-81-969	3.900 x 1.437 (99.06 x 36.50)	162	DAT-145-292	0.500 x 0.937 (12.70 x 23.80)	172
DAT-82-969	3.000 x 1.900 (76.20 x 48.26)	162	DAT-146-502	0.800 x 0.937 (20.32 x 23.80)	160
DAT-83-502	1.000 x 0.750 (25.40 x 19.05)	161	DAT-147-632	0.800 x 0.937 (20.32 x 23.80)	160
DAT-84-632	1.000 x 0.750 (25.40 x 19.05)	161	DAT-148-292	0.800 x 0.937 (20.32 x 23.80)	172
DAT-85-292	1.000 x 0.750 (25.40 x 19.05)	172	DAT-149-502	1.000 x 0.937 (25.40 x 23.80)	161
DAT-87-632	1.000 x 1.437 (25.40 x 36.50)	165	DAT-150-632	1.000 x 0.937 (25.40 x 23.80)	161
DAT-88-693	0.650 x 0.200 (16.51 x 5.08)	159	DAT-151-292	1.000 x 0.937 (25.40 x 23.80)	172
DAT-88-969	0.650 x 0.200 (16.51 x 5.08)	159	DAT-157-502	0.312 (7.92) strips	168
DAT-89-969	0.750 x 0.250 (19.05 x 6.35)	159	DAT-158-502	0.375 (9.53) strips	168
DAT-90-619	0.650 x 0.200 (16.51 x 5.08)	165	DAT-159-292	2.000 x 8.437 (50.80 x 214.30)	171
DAT-91-652	0.650 x 0.200 (16.51 x 5.08)	165	DAT-159-292-BL	2.000 x 8.437 (50.80 x 214.30)	171
DAT-92-619	0.750 x 0.250 (19.05 x 6.35)	165	DAT-159-292-BR	2.000 x 8.437 (50.80 x 214.30)	171
DAT-93-652	0.750 x 0.250 (19.05 x 6.35)	165	DAT-159-292-GR	2.000 x 8.437 (50.80 x 214.30)	171
DAT-94-652	0.900 x 0.250 (22.86 x 6.35)	165	DAT-159-292-GY	2.000 x 8.437 (50.80 x 214.30)	171
DAT-95-619	0.900 x 0.250 (22.86 x 6.35)	165	DAT-159-292-OR	2.000 x 8.437 (50.80 x 214.30)	171
DAT-96-652	0.750 x 0.250 (19.05 x 6.35)	159	DAT-159-292-PL	2.000 x 8.437 (50.80 x 214.30)	171
DAT-97-673	1.000 x 0.500 (25.40 x 12.70)	160	DAT-159-292-RD	2.000 x 8.437 (50.80 x 214.30)	171
DAT-98-673	0.500 x 0.437 (12.70 x 11.10)	159	DAT-159-292-YL	2.000 x 8.437 (50.80 x 214.30)	171
DAT-99-637	1.000 x 0.500 (25.40 x 12.70)	160	DAT-160-502	1.125 x 0.530 (28.58 x 13.46)	161
DAT-100-502	0.375 x 165 ft (9.53 x 50.30 m)	168	DAT-161-637	0.750 x 0.250 (19.05 x 6.35)	159
DAT-101-652	0.800 x 0.200 (20.32 x 5.08)	163	DAT-162-292	8.500 x 2.000 (215.90 x 50.80)	174
DAT-102-619	0.800 x 0.200 (20.32 x 5.08)	163	DAT-163-621	1.000 x 0.500 (25.40 x 12.70)	160
DAT-103-652	0.800 x 0.500 (20.32 x 12.70)	163	DAT-164-969	1.000 x 0.500 (25.40 x 12.70)	166
DAT-104-619	0.800 x 0.500 (20.32 x 12.70)	163	DAT-168-619	0.375 (9.53) strips	168
DAT-105-110	0.800 x 0.500 (20.32 x 12.70)	163	DAT-169-621	7.500 x 0.500 (190.50 x 12.70)	169
DAT-106-652	0.300 x 0.300 (7.62 x 7.62)	163	DAT-170-969	1.600 x 0.3750 (40.64 x 9.53)	161
DAT-107-658	0.300 x 0.300 (7.62 x 7.62)	163	DAT-171-652	0.500 x 0.4370 (12.70 x 11.10)	159
DAT-108-619	0.300 x 0.300 (7.62 x 7.62)	163	DAT-172-652	0.250 x 0.250 (6.35 x 6.35) 142	163
DAT-109-658	0.650 x 0.200 (16.51 x 5.08)	159	DAT-173-619	0.250 x 0.250 (6.35 x 6.35) 149	163
DAT-110-658	0.750 x 0.250 (19.05 x 6.35)	159	DAT-177-124	7.900 x 0.474 (200.66 x 12.04)	169
DAT-111-164	0.650 x 0.200 (16.51 x 5.08)	159	DAT-177-124-BL	7.900 x 0.474 (200.66 x 12.04)	169
DAT-112-164	0.750 x 0.250 (19.05 x 6.35)	159	DAT-177-124-BR	7.900 x 0.474 (200.66 x 12.04)	169
DAT-113-164	0.375 x 0.375 (9.53 x 9.53)	158	DAT-177-124-GR	7.900 x 0.474 (200.66 x 12.04)	169
DAT-114-673	0.375 x 0.375 (9.53 x 9.53)	158	DAT-177-124-GY	7.900 x 0.474 (200.66 x 12.04)	169
DAT-115-652	0.375 x 0.375 (9.53 x 9.53)	158	DAT-177-124-OR	7.900 x 0.474 (200.66 x 12.04)	169
DAT-116-658	0.375 x 0.375 (9.53 x 9.53)	158	DAT-177-124-PL	7.900 x 0.474 (200.66 x 12.04)	169
DAT-117-607	0.375 x 0.375 (9.53 x 9.53)	158	DAT-177-124-RD	7.900 x 0.474 (200.66 x 12.04)	169
DAT-118-619	0.375 x 0.375 (9.53 x 9.53)	158	DAT-177-124-YL	7.900 x 0.474 (200.66 x 12.04)	169
DAT-119-502	0.375 x 0.375 (9.53 x 9.53)	158	DAT-179-619	0.400 x 0.200 (10.16 x 5.08)	159
DAT-120-164	0.900 x 0.250 (22.86 x 6.35)	160	DAT-179-652	0.400 x 0.200 (10.16 x 5.08)	159
DAT-124-502	0.750 x 0.250 (19.05 x 6.35)	160	DAT-181-619	1.000 x 0.250 (25.40 x 6.35)	160
DAT-125-607	0.750 x 0.250 (19.05 x 6.35)	160	DAT-185-292	1.000 x 2.500 (25.40 x 63.50)	170
DAT-126-619	0.750 x 0.250 (19.05 x 6.35)	160	DAT-186-292	1.500 x 2.500 (38.10 x 63.50)	170
DAT-127-969	0.750 x 0.250 (19.05 x 6.35)	160	DAT-187-292	1.000 x 4.000 (25.40 x 101.60)	170
DAT-128-652	0.750 x 0.250 (19.05 x 6.35)	160	DAT-188-292	1.500 x 4.000 (38.10 x 101.60)	170
DAT-129-658	0.750 x 0.250 (19.05 x 6.35)	160	RCM-330-2.0-WT	2.000 x 100 ft (50.80 x 30,480)	174
DAT-130-164	0.750 x 0.250 (19.05 x 6.35)	160	RCM-330-2.0-YL	2.000 x 100 ft (50.80 x 30,480)	174
DAT-132-637	0.900 x 0.250 (22.86 x 6.35)	160	RCM-637-1.0-WT	1.000 x 100 ft (25.40 x 30,480)	174
DAT-133-652	0.900 x 0.250 (22.86 x 6.35)	160	RCM-637-1.0-YL	1.000 x 100 ft (25.40 x 30,480)	174
DAT-134-619	0.900 x 0.250 (22.86 x 6.35)	160	RCM-637-1.5-WT	1.500 x 100 ft (38.10 x 30,480)	174
DAT-135-164	0.900 x 0.250 (22.86 x 6.35)	160	RCM-637-1.5-YL	1.500 x 100 ft (38.10 x 30,480)	174
DAT-137-502	0.300 x 0.750 (7.62 x 19.05)	158	RCM-637-2.0-WT	2.000 x 100 ft (50.80 x 30,480)	174
DAT-138-632	0.300 x 0.750 (7.62 x 19.05)	158	RCM-637-2.0-YL	2.000 x 100 ft (50.80 x 30,480)	174
DAT-139-292	0.300 x 0.750 (7.62 x 19.05)	172			

LABEL INDEX BY PART NUMBER DOT MATRIX LABELS

▶ **3PS, PS SERIES**

PermaSleeve™ Wire Markers

Part Number	Label Size Inch (mm) Width x Height	Specifications On Page
PS-094-150-WT	0.094 dia. x 1.500 (2.39 dia. x 38.10)	195
PS-125-150-WT	0.125 dia. x 1.500 (3.18 dia. x 38.10)	195
PS-187-150-WT	0.187 dia. x 1.500 (4.75 dia. x 38.10)	195
PS-250-150-WT	0.250 dia. x 1.500 (6.35 dia. x 38.10)	195
PS-375-150-WT	0.375 dia. x 1.500 (9.53 dia. x 38.10)	195
PS-500-150-WT	0.500 dia. x 1.500 (12.70 dia. x 38.10)	195
PS-094-2-WT	0.094 dia. x 2.000 (2.39 dia. x 50.80)	195
PS-125-2-WT	0.125 dia. x 2.000 (3.18 dia. x 50.80)	195
PS-187-2-WT	0.187 dia. x 2.000 (4.75 dia. x 50.80)	195
PS-250-2-WT	0.250 dia. x 2.000 (6.35 dia. x 50.80)	195
PS-375-2-WT	0.375 dia. x 2.000 (9.53 dia. x 50.80)	195
PS-500-2-WT	0.500 dia. x 2.000 (12.70 dia. x 50.80)	195
PS-1000-2-WT	1.000 dia. x 2.000 (25.40 dia. x 50.80)	195
3PS-094-2-WT	0.094 dia. x 2.000 (2.39 dia. x 50.80)	196
3PS-125-2-WT	0.125 dia. x 2.000 (3.18 dia. x 50.80)	196
3PS-187-2-WT	0.187 dia. x 2.000 (4.75 dia. x 50.80)	196
3PS-250-2-WT	0.250 dia. x 2.000 (6.35 dia. x 50.80)	196
3PS-375-2-WT	0.375 dia. x 2.000 (9.53 dia. x 50.80)	196
3PS-500-2-WT	0.500 dia. x 2.000 (12.70 dia. x 50.80)	196

▶ **BCDAT SERIES**

Bar Code Datab Labels

Part Number	Label Size Inch (mm) Width x Height	Specifications On Page
BCDAT-1-609	2.000 x 0.900 (50.80 x 22.86)	161
BCDAT-1-619	2.000 x 0.900 (50.80 x 22.86)	161
BCDAT-2-609	3.000 x 0.900 (76.20 x 22.86)	162
BCDAT-2-619	3.000 x 0.900 (76.20 x 22.86)	162
BCDAT-3-609	2.000 x 1.437 (50.80 x 36.50)	161
BCDAT-3-619	2.000 x 1.437 (50.80 x 36.50)	161
BCDAT-4-609	3.000 x 1.437 (76.20 x 36.50)	162
BCDAT-4-619	3.000 x 1.437 (76.20 x 36.50)	162
BCDAT-5-609	3.900 x 1.437 (99.06 x 36.50)	162
BCDAT-5-619	3.900 x 1.437 (99.06 x 36.50)	162
BCDAT-6-609	3.000 x 1.900 (76.20 x 48.26)	162
BCDAT-6-619	3.000 x 1.900 (76.20 x 48.26)	162
BCDAT-7-609	6.000 x 3.937 (152.40 x 100)	167
BCDAT-8-619	1.500 x 0.250 (38.10 x 6.35)	161
BCDAT-8-652	1.500 x 0.250 (38.10 x 6.35)	161
BCDAT-9-619	2.000 x 0.250 (50.80 x 6.35)	161
BCDAT-9-652	2.000 x 0.250 (50.80 x 6.35)	161
BCDAT-10-619	2.000 x 0.375 (50.80 x 9.53)	161
BCDAT-10-652	2.000 x 0.375 (50.80 x 9.53)	161
BCDAT-11-619	3.000 x 0.375 (76.20 x 9.53)	162
BCDAT-11-652	3.000 x 0.375 (76.20 x 9.53)	162
BCDAT-12-619	1.500 x 0.750 (38.10 x 19.05)	164

▶ **BT SERIES**

BradyTag® Tags

Part Number	Label Size Inch (mm) Width x Height	Specifications On Page
BT-0530	3.000 x 0.500 (76.20 x 12.70)	176
BT-1030	3.000 x 1.000 (76.20 x 25.40)	176
BT-1530	3.000 x 1.500 (76.20 x 38.10)	176
BT-2030	3.000 x 2.000 (76.20 x 50.80)	176
BT-2535	3.500 x 2.500 (88.90 x 63.50)	176
BT-109-WT-2037	3.750 x 2.000 (95.25 x 50.80)	176
BT-109-WT-2547	4.750 x 2.500 (120.65 x 63.50)	176
BT-109-WT-3060-1	3.000 x 6.000 (76.20 x 152.40)	176
BT-109-WT-3060-2	3.000 x 6.000 (76.20 x 152.40)	176
BT-508-WT-2050	2.000 x 0.500 (50.80 x 12.70)	176
BT-508-YL-2050	2.000 x 0.500 (50.80 x 12.70)	176
BT-508-WT-2075	2.000 x 0.750 (50.80 x 19.05)	176
BT-508-YL-2075	2.000 x 0.750 (50.80 x 19.05)	176

▶ **CPT SERIES**

Connector Pull-Tab Printable Markers

Part Number	Label Size Inch (mm) Width x Height	Specifications On Page
CPT-0.5	3.000 x 0.500 (76.20 x 12.70)	175
CPT-1.0	3.000 x 1.000 (76.20 x 25.40)	175
CPT-1.5	3.000 x 1.500 (76.20 x 38.10)	175
CPT-2.0	3.000 x 2.000 (76.20 x 50.80)	175
CPT-2.5	3.000 x 2.500 (76.20 x 63.50)	175
CPT-3.25	3.000 x 3.250 (76.20 x 82.55)	175

▶ **CT SERIES**

BradyTag® Cloth Identification Tags

Part Number	Label Size Inch (mm) Width x Height	Specifications On Page
CT-1	4.500 x 1.000 (114.30 x 25.40)	175

▶ **PSL SERIES**

PermaShield™* Markers

Part Number	Label Size Inch (mm) Width x Height	Specifications On Page
PSL-1-609	1.000 x 0.500 (25.40 x 12.70)	167
PSL-1-619	1.000 x 0.500 (25.40 x 12.70)	167
PSL-1-969	1.000 x 0.500 (25.40 x 12.70)	167
PSL-2-609	1.500 x 0.750 (38.10 x 19.05)	167
PSL-2-619	1.500 x 0.750 (38.10 x 19.05)	167
PSL-2-969	1.500 x 0.750 (38.10 x 19.05)	167
PSL-3-619	2.000 x 1.000 (50.80 x 25.40)	167
PSL-3-969	2.000 x 1.000 (50.80 x 25.40)	167

* This product is sold in Japan under the Overlaminated Labels name and not under the PermaShield name.

▶ **RCM SERIES**

Roll-Form Cable Markers

Part Number	Label Size Inch (mm) Width x Height	Specifications On Page
RCM-330-2.0-WT	2.000 x 100 ft (50.80 x 30.48 m)	174
RCM-330-2.0-YL	2.000 x 100 ft (50.80 x 30.48 m)	174
RCM-637-1.0-WT	1.000 x 100 ft (25.40 x 30.48 m)	174
RCM-637-1.0-YL	1.000 x 100 ft (25.40 x 30.48 m)	174
RCM-637-1.5-WT	1.500 x 100 ft (38.10 x 30.48 m)	174
RCM-637-1.5-YL	1.500 x 100 ft (38.10 x 30.48 m)	174
RCM-637-2.0-WT	2.000 x 100 ft (50.80 x 30.48 m)	174
RCM-637-2.0-YL	2.000 x 100 ft (50.80 x 30.48 m)	174

▶ **SLDAT SERIES**

Static Awareness Datab Markers

Part Number	Label Size Inch (mm) Width x Height	Specifications On Page
SLDAT-1-502	1.000 x 0.500 (25.40 x 12.70)	166
SLDAT-1-619	1.000 x 0.500 (25.40 x 12.70)	166

▶ **SLSH SERIES**

Self-Laminating Datab Label

Part Number	Label Size Inch (mm) Width x Height	Specifications On Page
SLSH-0515	0.500 x 1.437 (12.70 x 36.50)	172
SLSH-1015	1.000 x 1.437 (25.40 x 36.50)	172
SLSH-2015	2.000 x 1.437 (50.80 x 36.50)	173
SLSH-10225	1.000 x 2.250 (25.40 x 57.15)	172
SLSH-10375	1.000 x 3.750 (25.40 x 95.25)	173
SLSH-20225	2.000 x 2.250 (50.80 x 57.15)	173
SLSH-20375	2.000 x 3.750 (50.80 x 95.25)	173

Narrow Carriage Printer Cross-Reference

These wide carriage labels will not fit narrow carriage (80-column) printers. Identical labels on narrow carriage liners are listed below.

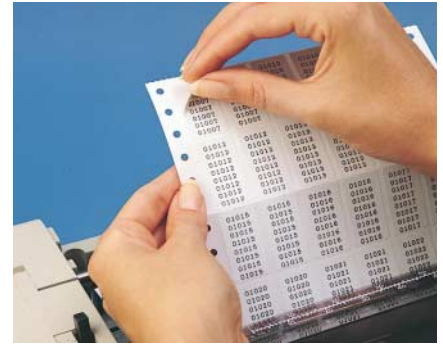

Print your own wire markers in-house as you need them. (Product shown: DAT-5-502)

WIDE CARRIAGE MODELS		NARROW CARRIAGE EQUIVALENTS	
Part Number	Specifications On Page	Part Number	Specifications On Page
DAT-1-637	160	DAT-49-637	160
DAT-2-637	161	DAT-72-637	161
DAT-8-292	170	DAT-63-292	170
DAT-9-292	171	DAT-75-292	171
DAT-10-637	161	DAT-73-637	161
DAT-12-502	161	DAT-64-502	161
DAT-14-292	171	DAT-65-292	171
DAT-23-637	161	DAT-74-637	161
DAT-30-292	170	DAT-66-292	170
DAT-31-502	159	DAT-67-502	159
DAT-32-632	159	DAT-68-632	159
DAT-41-292	170	DAT-69-292	170
DAT-42-292	170	DAT-70-292	170
DAT-55-642	170	DAT-71-642	170

Label Index by Size

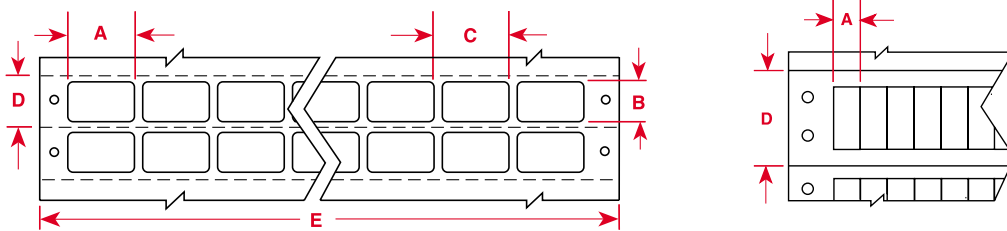

DAT-137-502-10

Dot Matrix Technology	Die # 137, 0.300" x 0.750" Rating Plate	Package Quantity, 10,000
	Material 8-502, White Vinyl Cloth	

PART NUMBER EXPLANATION:

Most Brady part numbers for computer printable labels follow the same four-part format:

The first code indicates the technology, the second part is a number indicating the die size used (where applicable), the third part indicates the Brady material used (where applicable), and the final code indicates package quantity.

Part Number	Pieces Per Package	Material	Color	Labels Per Row	Label Width Inch (mm) A	Label Height Inch (mm) B	Horizontal Repeat Inch (mm) C	Vertical Repeat Inch (mm) D	Web Width Inch (mm) E
0.300" Label Width — 6 or 8 lines per inch — Square Corners									
DAT-137-502-10	10,000	Vinyl Cloth	White	16	0.300 (7.62)	0.750 (19.05)	0.300 (7.62)	1.000 (25.40)	5.800 (147.32)
DAT-138-632-10	10,000	Polyvinylfluoride	White	16	0.300 (7.62)	0.750 (19.05)	0.300 (7.62)	1.000 (25.40)	5.800 (147.32)
DAT-140-502-10	10,000	Vinyl Cloth	White	16	0.300 (7.62)	0.937 (23.80)	0.300 (7.62)	1.000 (25.40)	5.800 (147.32)
DAT-141-632-10	10,000	Polyvinylfluoride	White	16	0.300 (7.62)	0.937 (23.80)	0.300 (7.62)	1.000 (25.40)	5.800 (147.32)
0.375" Label Width — 6 or 8 lines per inch									
DAT-113-164-10	10,000	Polyester	Silver	16	0.375 (9.53)	0.375 (9.53)	0.500 (12.70)	0.500 (12.70)	8.900 (226.06)
DAT-114-673-10	10,000	Polyester	White	16	0.375 (9.53)	0.375 (9.53)	0.500 (12.70)	0.500 (12.70)	8.900 (226.06)
DAT-115-652-10	10,000	Polyimide	Amber	16	0.375 (9.53)	0.375 (9.53)	0.500 (12.70)	0.500 (12.70)	8.900 (226.06)
DAT-116-658-10	10,000	Polyimide	Amber	16	0.375 (9.53)	0.375 (9.53)	0.500 (12.70)	0.500 (12.70)	8.900 (226.06)
DAT-117-607-10	10,000	Tamper-Resistant Vinyl	White	16	0.375 (9.53)	0.375 (9.53)	0.500 (12.70)	0.500 (12.70)	8.900 (226.06)
DAT-118-619-10	10,000	Polyester	White	16	0.375 (9.53)	0.375 (9.53)	0.500 (12.70)	0.500 (12.70)	8.900 (226.06)
DAT-119-502-10	10,000	Vinyl Cloth	White	16	0.375 (9.53)	0.375 (9.53)	0.500 (12.70)	0.500 (12.70)	8.900 (226.06)

Note: Labels in chart are sorted in order by width, height, 3 digit material number (within part number), then die number (within part number).

LABEL INDEX BY SIZE DOT MATRIX LABELS

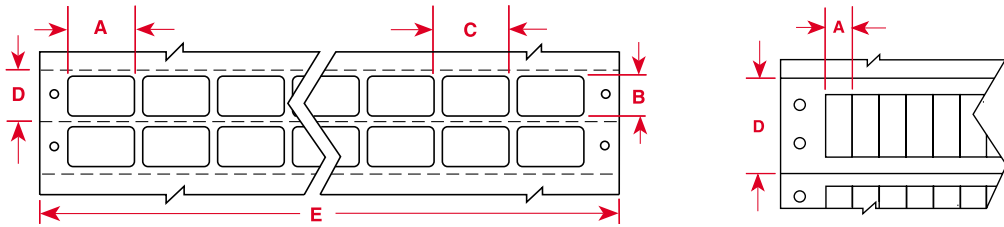

Part Number	Pieces Per Package	Material	Color	Labels Per Row	Label Width Inch (mm) A	Label Height Inch (mm) B	Horizontal Repeat Inch (mm) C	Vertical Repeat Inch (mm) D	Web Width Inch (mm) E
0.400" Label Width — 6 or 8 lines per inch									
DAT-179-619-10	10,000	Polyester	White	16	0.400 (10.16)	0.200 (5.08)	0.500 (12.70)	0.250 (6.35)	8.900 (226.06)
DAT-179-652-10	10,000	Polyimide	Amber	16	0.400 (10.16)	0.200 (5.08)	0.500 (12.70)	0.250 (6.35)	8.900 (226.06)
0.500" Label Width — 6 or 8 lines per inch									
DAT-67-499-10	10,000	Nylon Cloth	White	12	0.500 (12.70)	0.750 (19.05)	0.600 (15.24)	1.000 (25.40)	8.100 (205.74)
DAT-67-502-10	10,000	Vinyl Cloth	White	12	0.500 (12.70)	0.750 (19.05)	0.600 (15.24)	1.000 (25.40)	8.100 (205.74)
DAT-68-632-10	10,000	Polyvinylfluoride	White	12	0.500 (12.70)	0.750 (19.05)	0.600 (15.24)	1.000 (25.40)	8.100 (205.74)
DAT-31-502*-10	10,000	Vinyl Cloth	White	14	0.500 (12.70)	0.750 (19.05)	0.600 (15.24)	1.000 (25.40)	9.300 (236.22)
DAT-32-632*-10	10,000	Polyvinylfluoride	White	14	0.500 (12.70)	0.750 (19.05)	0.600 (15.24)	1.000 (25.40)	9.300 (236.22)
DAT-21-110-10	10,000	Saturated Paper	White	12	0.500 (12.70)	1.437 (36.50)	0.600 (15.24)	1.500 (38.10)	8.100 (205.74)
DAT-24-502-10	10,000	Vinyl Cloth	White	12	0.500 (12.70)	1.437 (36.50)	0.600 (15.24)	1.500 (38.10)	8.100 (205.74)
0.500" Label Width — 6 or 8 lines per inch — Square Corners									
DAT-43-502-10	10,000	Vinyl Cloth	White	16	0.500 (12.70)	0.437 (11.10)	0.500 (12.70)	0.500 (12.70)	9.000 (228.60)
DAT-44-607-10	10,000	Tamper-Resistant Vinyl	White	16	0.500 (12.70)	0.437 (11.10)	0.500 (12.70)	0.500 (12.70)	9.000 (228.60)
DAT-45-619-10	10,000	Polyester	White	16	0.500 (12.70)	0.437 (11.10)	0.500 (12.70)	0.500 (12.70)	9.000 (228.60)
DAT-46-693-10	10,000	Metallized Polyester	Silver	16	0.500 (12.70)	0.437 (11.10)	0.500 (12.70)	0.500 (12.70)	9.000 (228.60)
DAT-46-969-10	10,000	Metallized Polyester	Silver	16	0.500 (12.70)	0.437 (11.10)	0.500 (12.70)	0.500 (12.70)	9.000 (228.60)
DAT-98-673-10	10,000	Polyester	Silver	16	0.500 (12.70)	0.437 (11.10)	0.500 (12.70)	0.500 (12.70)	9.000 (228.60)
DAT-143-502-10	10,000	Vinyl Cloth	White	16	0.500 (12.70)	0.937 (23.80)	0.500 (12.70)	1.000 (25.40)	9.000 (228.60)
DAT-144-632-10	10,000	Polyvinylfluoride	White	16	0.500 (12.70)	0.937 (23.80)	0.500 (12.70)	1.000 (25.40)	9.000 (228.60)
DAT-171-652-10	10,000	Polyimide	Amber	16	0.500 (12.70)	0.437 (11.10)	0.500 (12.70)	0.500 (12.70)	9.000 (228.60)
0.650" Label Width — 6 or 8 lines per inch									
DAT-15-502-1-10	10,000	Vinyl Cloth	White	10	0.650 (16.51)	0.200 (5.08)	0.800 (20.32)	0.250 (6.35)	8.850 (224.79)
DAT-16-607-10	10,000	Tamper-Resistant Vinyl	White	10	0.650 (16.51)	0.200 (5.08)	0.800 (20.32)	0.250 (6.35)	8.850 (224.79)
DAT-17-619-10	10,000	Polyester	White	10	0.650 (16.51)	0.200 (5.08)	0.800 (20.32)	0.250 (6.35)	8.850 (224.79)
DAT-56-637-10	10,000	Tedlar®	White	10	0.650 (16.51)	0.200 (5.08)	0.800 (20.32)	0.250 (6.35)	8.850 (224.79)
DAT-58-652-10	10,000	Polyimide	Amber	10	0.650 (16.51)	0.200 (5.08)	0.800 (20.32)	0.250 (6.35)	8.850 (224.79)
DAT-88-693-10	10,000	Polyester	Silver	10	0.650 (16.51)	0.200 (5.08)	0.800 (20.32)	0.250 (6.35)	8.850 (224.79)
DAT-88-969-10	10,000	Polyester	Silver	10	0.650 (16.51)	0.200 (5.08)	0.800 (20.32)	0.250 (6.35)	8.850 (224.79)
DAT-109-658-10	10,000	Polyimide	Amber	10	0.650 (16.51)	0.200 (5.08)	0.800 (20.32)	0.250 (6.35)	8.850 (224.79)
DAT-111-164-10	10,000	Polyester	Silver	10	0.650 (16.51)	0.200 (5.08)	0.800 (20.32)	0.250 (6.35)	8.850 (224.79)
0.750" Label Width — 6 lines per inch									
DAT-25-502-10	10,000	Vinyl Cloth	White	9	0.750 (19.05)	0.250 (6.35)	0.900 (22.86)	0.330 (8.46)	9.000 (228.60)
DAT-26-607-10	10,000	Tamper-Resistant Vinyl	White	9	0.750 (19.05)	0.250 (6.35)	0.900 (22.86)	0.330 (8.46)	9.000 (228.60)
DAT-27-619-10	10,000	Polyester	White	9	0.750 (19.05)	0.250 (6.35)	0.900 (22.86)	0.330 (8.46)	9.000 (228.60)
DAT-89-969-10	10,000	Polyester	Silver	9	0.750 (19.05)	0.250 (6.35)	0.900 (22.86)	0.330 (8.46)	9.000 (228.60)
DAT-96-652-10	10,000	Polyimide	Amber	9	0.750 (19.05)	0.250 (6.35)	0.900 (22.86)	0.330 (8.46)	9.000 (228.60)
DAT-110-658-10	10,000	Polyimide	Amber	9	0.750 (19.05)	0.250 (6.35)	0.900 (22.86)	0.330 (8.46)	9.000 (228.60)
DAT-112-164-10	10,000	Polyester	Silver	9	0.750 (19.05)	0.250 (6.35)	0.900 (22.86)	0.330 (8.46)	9.000 (228.60)
DAT-161-637-10	10,000	Polyvinylfluoride	White	9	0.750 (19.05)	0.250 (6.35)	0.900 (22.86)	0.330 (8.46)	9.000 (228.60)

Tedlar® is a registered trademark of DuPont.

* Size does not fit narrow carriage (80-column) printers. See p. 158 for identical narrow carriage labels.

Note: Labels in chart are sorted in order by width, height, 3 digit material number (within part number), then die number (within part number).

Label Index by Size

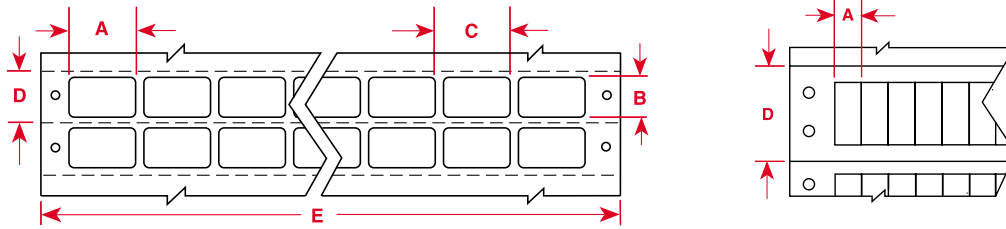

Part Number	Pieces Per Package	Material	Color	Labels Per Row	Label Width Inch (mm) A	Label Height Inch (mm) B	Horizontal Repeat Inch (mm) C	Vertical Repeat Inch (mm) D	Web Width Inch (mm) E	
0.750" Label Width — 8 lines per inch										
DAT-124-502-10	10,000	Vinyl Cloth	White	9	0.750 (19.05)	0.250 (6.35)	0.900 (22.86)	0.375 (9.53)	9.000 (228.60)	
DAT-125-607-10	10,000	Tamper-Resistant Vinyl	White	9	0.750 (19.05)	0.250 (6.35)	0.900 (22.86)	0.375 (9.53)	9.000 (228.60)	
DAT-126-619-10	10,000	Polyester	White	9	0.750 (19.05)	0.250 (6.35)	0.900 (22.86)	0.375 (9.53)	9.000 (228.60)	
DAT-127-969-10	10,000	Polyester	Silver	9	0.750 (19.05)	0.250 (6.35)	0.900 (22.86)	0.375 (9.53)	9.000 (228.60)	
DAT-128-652-10	10,000	Polyimide	Amber	9	0.750 (19.05)	0.250 (6.35)	0.900 (22.86)	0.375 (9.53)	9.000 (228.60)	
DAT-129-658-10	10,000	Polyimide	Amber	9	0.750 (19.05)	0.250 (6.35)	0.900 (22.86)	0.375 (9.53)	9.000 (228.60)	
DAT-130-164-10	10,000	Polyester	Silver	9	0.750 (19.05)	0.250 (6.35)	0.900 (22.86)	0.375 (9.53)	9.000 (228.60)	
0.800" Label Width — 6 or 8 lines per inch										
DAT-5-499-10	10,000	Nylon Cloth	White	6	0.800 (20.32)	1.437 (36.50)	0.900 (22.86)	1.500 (38.10)	6.300 (160.02)	
DAT-5-502-10	10,000	Vinyl Cloth	White	6	0.800 (20.32)	1.437 (36.50)	0.900 (22.86)	1.500 (38.10)	6.300 (160.02)	
DAT-6-632-10	10,000	Polyvinylfluoride	White	6	0.800 (20.32)	1.437 (36.50)	0.900 (22.86)	1.500 (38.10)	6.300 (160.02)	
0.800" Label Width — 6 or 8 lines per inch — Square Corners										
DAT-146-502-10	10,000	Vinyl Cloth	White	10	0.800 (20.32)	0.937 (23.80)	0.800 (20.32)	1.000 (25.40)	9.000 (228.60)	
DAT-147-632-10	10,000	Polyvinylfluoride	White	10	0.800 (20.32)	0.937 (23.80)	0.800 (20.32)	1.000 (25.40)	9.000 (228.60)	
0.900" Label Width — 6 lines per inch										
DAT-1-637-10*	10,000	Polyvinylfluoride	White	10	0.900 (22.86)	0.250 (6.35)	1.000 (25.40)	0.330 (8.46)	10.900 (276.86)	
DAT-49-637-10	10,000	Polyvinylfluoride	White	8	0.900 (22.86)	0.250 (6.35)	1.000 (25.40)	0.330 (8.46)	8.900 (226.06)	
DAT-50-652-10	10,000	Polyimide	Amber	8	0.900 (22.86)	0.250 (6.35)	1.000 (25.40)	0.330 (8.46)	8.900 (226.06)	
DAT-60-619-10	10,000	Polyester	White	8	0.900 (22.86)	0.250 (6.35)	1.000 (25.40)	0.330 (8.46)	8.900 (226.06)	
DAT-120-164-10	10,000	Polyester	Silver	8	0.900 (22.86)	0.250 (6.35)	1.000 (25.40)	0.330 (8.46)	8.900 (226.06)	
0.900" Label Width — 8 lines per inch										
DAT-132-637-10	10,000	Polyvinylfluoride	White	8	0.900 (22.86)	0.250 (6.35)	1.000 (25.40)	0.375 (9.53)	8.900 (226.06)	
DAT-133-652-10	10,000	Polyimide	Amber	8	0.900 (22.86)	0.250 (6.35)	1.000 (25.40)	0.375 (9.53)	8.900 (226.06)	
DAT-134-619-10	10,000	Polyester	White	8	0.900 (22.86)	0.250 (6.35)	1.000 (25.40)	0.375 (9.53)	8.900 (226.06)	
DAT-135-164-10	10,000	Polyester	Silver	8	0.900 (22.86)	0.250 (6.35)	1.000 (25.40)	0.375 (9.53)	8.900 (226.06)	
1.000" Label Width — 6 lines per inch										
DAT-18-499-10	10,000	Nylon Cloth	White	7	1.000 (25.40)	0.500 (12.70)	1.100 (27.94)	0.667 (16.94)	8.600 (218.44)	
DAT-18-502-10	10,000	Vinyl Cloth	White	7	1.000 (25.40)	0.500 (12.70)	1.100 (27.94)	0.667 (16.94)	8.600 (218.44)	
DAT-19-607-10	10,000	Tamper-Resistant Vinyl	White	7	1.000 (25.40)	0.500 (12.70)	1.100 (27.94)	0.667 (16.94)	8.600 (218.44)	
DAT-20-619-10	10,000	Polyester	White	7	1.000 (25.40)	0.500 (12.70)	1.100 (27.94)	0.667 (16.94)	8.600 (218.44)	
DAT-47-693-10	10,000	Metallized Polyester	Silver	7	1.000 (25.40)	0.500 (12.70)	1.100 (27.94)	0.667 (16.94)	8.600 (218.44)	
DAT-47-969-10	10,000	Metallized Polyester	Silver	7	1.000 (25.40)	0.500 (12.70)	1.100 (27.94)	0.667 (16.94)	8.600 (218.44)	
DAT-57-637-10	10,000	Polyvinylfluoride	White	7	1.000 (25.40)	0.500 (12.70)	1.100 (27.94)	0.667 (16.94)	8.600 (218.44)	
DAT-59-652-10	10,000	Polyimide	Amber	7	1.000 (25.40)	0.500 (12.70)	1.100 (27.94)	0.667 (16.94)	8.600 (218.44)	
DAT-97-673-10	10,000	Polyester	White	7	1.000 (25.40)	0.500 (12.70)	1.100 (27.94)	0.667 (16.94)	8.600 (218.44)	
DAT-99-637-10	10,000	Polyvinylfluoride	Yellow	7	1.000 (25.40)	0.500 (12.70)	1.100 (27.94)	0.667 (16.94)	8.600 (218.44)	
DAT-163-621-10	10,000	Polyester	Clear	7	1.000 (25.40)	0.500 (12.70)	1.100 (27.94)	0.667 (16.90)	8.600 (218.44)	
DAT-181-619-10	10,000	Polyester	White	7	1.000 (25.40)	0.250 (6.35)	1.100 (27.94)	0.333 (8.46)	8.600 (218.44)	

*Size does not fit narrow carriage (80-column) printers. See p. 158 for identical narrow carriage labels.

Note: Labels in chart are sorted in order by width, height, 3 digit material number (within part number), then die number (within part number).

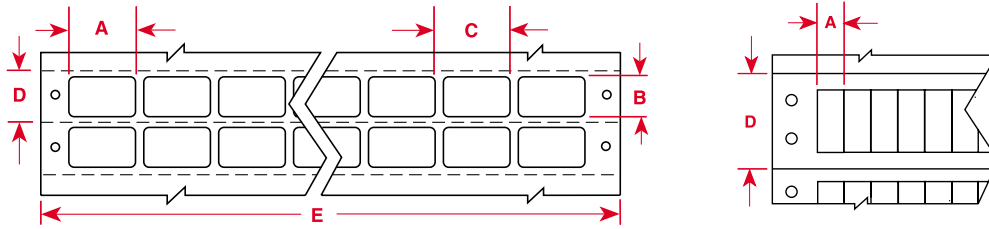

Part Number	Pieces Per Package	Material	Color	Labels Per Row	Label Width Inch (mm) A	Label Height Inch (mm) B	Horizontal Repeat Inch (mm) C	Vertical Repeat Inch (mm) D	Web Width Inch (mm) E
1.000" Label Width — 6 or 8 lines per inch									
DAT-11-499-10	10,000	Nylon Cloth	White	7	1.000 (25.40)	0.375 (9.53)	1.100 (27.94)	0.500 (12.70)	8.600 (218.44)
DAT-11-502-10	10,000	Vinyl Cloth	White	7	1.000 (25.40)	0.375 (9.53)	1.100 (27.94)	0.500 (12.70)	8.600 (218.44)
DAT-51-619-10	10,000	Polyester	White	7	1.000 (25.40)	0.375 (9.53)	1.100 (27.94)	0.500 (12.70)	8.600 (218.44)
DAT-83-502-10	10,000	Vinyl Cloth	White	7	1.000 (25.40)	0.750 (19.05)	1.100 (27.94)	1.000 (25.40)	8.600 (218.44)
DAT-84-632-10	10,000	Polyvinylfluoride	White	7	1.000 (25.40)	0.750 (19.05)	1.100 (27.94)	1.000 (25.40)	8.600 (218.44)
1.000" Label Width — 6 or 8 lines per inch — Square Corners									
DAT-149-502-10	10,000	Vinyl Cloth	White	8	1.000 (25.40)	0.937 (23.80)	1.000 (25.40)	1.000 (25.40)	9.000 (228.60)
DAT-150-632-10	10,000	Polyvinylfluoride	White	8	1.000 (25.40)	0.937 (23.80)	1.000 (25.40)	1.000 (25.40)	9.000 (228.60)
1.125" Label Width — 8 lines per inch									
DAT-160-502-10	10,000	Vinyl Cloth	White	4	1.125 (28.58)	0.530 (13.46)	1.600 (40.64)	0.625 (15.88)	7.300 (185.42)
1.250" Label Width — 6 or 8 lines per inch									
DAT-2-637-10*	10,000	Polyvinylfluoride	Yellow	7	1.250 (31.75)	0.375 (9.53)	1.400 (35.56)	0.500 (12.70)	10.750 (273.05)
DAT-72-637-10	10,000	Polyvinylfluoride	Yellow	5	1.250 (31.75)	0.375 (9.53)	1.400 (35.56)	0.500 (12.70)	7.950 (201.93)
DAT-73-637-10	10,000	Polyvinylfluoride	White	5	1.250 (31.75)	0.375 (9.53)	1.400 (35.56)	0.500 (12.70)	7.950 (201.93)
DAT-74-637-10	10,000	Polyvinylfluoride	Gray	5	1.250 (31.75)	0.375 (9.53)	1.400 (35.56)	0.500 (12.70)	7.950 (201.93)
DAT-10-637*-10	10,000	Polyvinylfluoride	White	7	1.250 (31.75)	0.375 (9.53)	1.400 (35.56)	0.500 (12.70)	10.750 (273.05)
DAT-23-637*-10	10,000	Polyvinylfluoride	Gray	7	1.250 (31.75)	0.375 (9.53)	1.400 (35.56)	0.500 (12.70)	10.750 (273.05)
1.500" Label Width — 8 lines per inch									
BCDAT-8-619-5	5,000	Polyester	White	4	1.500 (38.10)	0.250 (6.35)	1.600 (40.64)	0.375 (9.53)	7.300 (185.42)
BCDAT-8-652-5	5,000	Polyimide	Amber	4	1.500 (38.10)	0.250 (6.35)	1.600 (40.64)	0.375 (9.53)	7.300 (185.42)
1.600" Label Width — 8 lines per inch									
DAT-170-969-10	10,000	Polyester	Silver	4	1.600 (40.64)	0.375 (9.53)	1.700 (43.18)	0.500 (12.70)	7.700 (195.58)
2.000" Label Width — 6 or 8 lines per inch									
BCDAT-10-619-10	10,000	Polyester	White	3	2.000 (50.80)	0.375 (9.53)	2.100 (53.34)	0.500 (12.70)	7.200 (182.88)
BCDAT-10-652-10	10,000	Polyimide	Amber	3	2.000 (50.80)	0.375 (9.53)	2.100 (53.34)	0.500 (12.70)	7.200 (182.88)
DAT-64-502-10	10,000	Vinyl Cloth	White	3	2.000 (50.80)	0.375 (9.53)	2.100 (53.34)	0.500 (12.70)	7.200 (182.88)
DAT-12-502*-10	10,000	Vinyl Cloth	White	4	2.000 (50.80)	0.375 (9.53)	2.100 (53.34)	0.500 (12.70)	9.300 (236.22)
BCDAT-1-609-5	5,000	Paper	White	3	2.000 (50.80)	0.900 (22.86)	2.100 (53.34)	1.000 (25.40)	7.200 (182.88)
BCDAT-1-619-5	5,000	Polyester	White	3	2.000 (50.80)	0.900 (22.86)	2.100 (53.34)	1.000 (25.40)	7.200 (182.88)
DAT-77-969-5	5,000	Metallized Polyester	Silver	3	2.000 (50.80)	0.900 (22.86)	2.100 (53.34)	1.000 (25.40)	7.200 (182.88)
BCDAT-3-609-5	5,000	Paper	White	3	2.000 (50.80)	1.437 (36.50)	2.100 (53.34)	1.500 (38.10)	7.200 (182.88)
BCDAT-3-619-5	5,000	Polyester	White	3	2.000 (50.80)	1.437 (36.50)	2.100 (53.34)	1.500 (38.10)	7.200 (182.88)
DAT-79-969-5	5,000	Metallized Polyester	Silver	3	2.000 (50.80)	1.437 (36.50)	2.100 (53.34)	1.500 (38.10)	7.200 (182.88)
2.000" Label Width — 8 lines per inch									
BCDAT-9-619-5	5,000	Polyester	White	3	2.000 (50.80)	0.250 (6.35)	2.100 (53.34)	0.375 (9.53)	7.200 (182.88)
BCDAT-9-652-5	5,000	Polyimide	Amber	3	2.000 (50.80)	0.250 (6.35)	2.100 (53.34)	0.375 (9.53)	7.200 (182.88)

*Size does not fit narrow carriage (80-column) printers. See p. 158 for identical narrow carriage labels.

Note: Labels in chart are sorted in order by width, height, 3 digit material number (within part number), then die number (within part number).

Label Index by Size

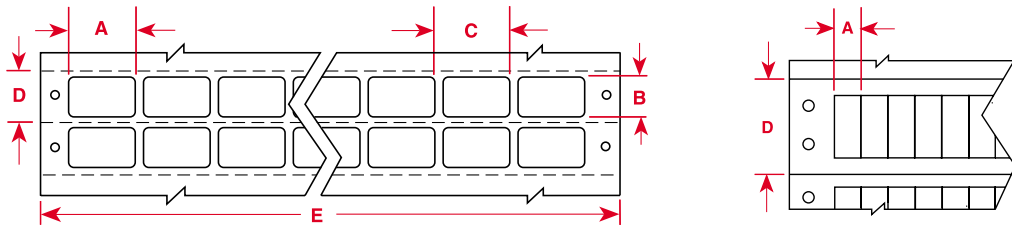

Part Number	Pieces Per Package	Material	Color	Labels Per Row	Label Width Inch (mm) A	Label Height Inch (mm) B	Horizontal Repeat Inch (mm) C	Vertical Repeat Inch (mm) D	Web Width Inch (mm) E
3.000" Label Width — 6 or 8 lines per inch									
BCDAT-11-619-10	10,000	Polyester	White	2	3.000 (76.20)	0.375 (9.53)	3.100 (78.74)	0.500 (12.70)	7.100 (180.34)
BCDAT-11-652-10	10,000	Polyimide	Amber	2	3.000 (76.20)	0.375 (9.53)	3.100 (78.74)	0.500 (12.70)	7.100 (180.34)
DAT-13-502-10	10,000	Vinyl Cloth	White	2	3.000 (76.20)	0.375 (9.53)	3.100 (78.74)	0.500 (12.70)	7.100 (180.34)
BCDAT-2-609-5	5,000	Paper	White	2	3.000 (76.20)	0.900 (22.86)	3.100 (78.74)	1.000 (25.40)	7.100 (180.34)
BCDAT-2-619-5	5,000	Polyester	White	2	3.000 (76.20)	0.900 (22.86)	3.100 (78.74)	1.000 (25.40)	7.100 (180.34)
DAT-78-969-5	5,000	Metallized Polyester	Silver	2	3.000 (76.20)	0.900 (22.86)	3.100 (78.74)	1.000 (25.40)	7.100 (180.34)
BCDAT-4-609-5	5,000	Paper	White	2	3.000 (76.20)	1.437 (36.50)	3.100 (78.74)	1.500 (38.10)	7.100 (180.34)
BCDAT-4-619-5	5,000	Polyester	White	2	3.000 (76.20)	1.437 (36.50)	3.100 (78.74)	1.500 (38.10)	7.100 (180.34)
DAT-80-969-5	5,000	Metallized Polyester	Silver	2	3.000 (76.20)	1.437 (36.50)	3.100 (78.74)	1.500 (38.10)	7.100 (180.34)
BCDAT-6-609-5	5,000	Paper	White	2	3.000 (76.20)	1.900 (48.26)	3.100 (78.74)	2.000 (50.80)	7.100 (180.34)
BCDAT-6-619-5	5,000	Polyester	White	2	3.000 (76.20)	1.900 (48.26)	3.100 (78.74)	2.000 (50.80)	7.100 (180.34)
DAT-82-969-5	5,000	Metallized Polyester	Silver	2	3.000 (76.20)	1.900 (48.26)	3.100 (78.74)	2.000 (50.80)	7.100 (180.34)
3.900" Label Width — 6 or 8 lines per inch									
BCDAT-5-609-5	5,000	Paper	White	2	3.900 (99.06)	1.437 (36.50)	4.000 (101.60)	1.500 (38.10)	8.900 (226.06)
BCDAT-5-619-5	5,000	Polyester	White	2	3.900 (99.06)	1.437 (36.50)	4.000 (101.60)	1.500 (38.10)	8.900 (226.06)
DAT-81-969-5	5,000	Metallized Polyester	Silver	2	3.900 (99.06)	1.437 (36.50)	4.000 (101.60)	1.500 (38.10)	8.900 (226.06)

Note: Labels in chart are sorted in order by width, height, 3 digit material number (within part number), then die number (within part number).

► BUTT-CUT WITH PERFORATIONS

Square Corners

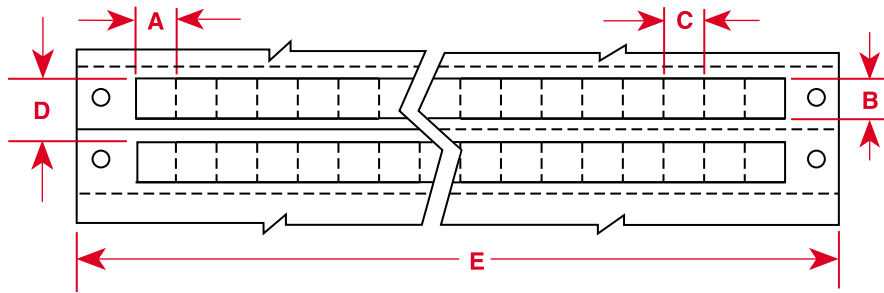

Part Number	Pieces Per Package	Material	Color	Labels Per Row	Label Width Inch (mm) A	Label Height Inch (mm) B	Horizontal Repeat Inch (mm) C	Vertical Repeat Inch (mm) D	Web Width Inch (mm) E
0.300" Label Width — 6 or 8 lines per inch									
DAT-106-652-10	10,000	Polyimide	Amber	16	0.300 (7.62)	0.300 (7.62)	0.300 (7.62)	0.500 (12.70)	5.800 (147.32)
DAT-107-658-10	10,000	Polyimide	Amber	16	0.300 (7.62)	0.300 (7.62)	0.300 (7.62)	0.500 (12.70)	5.800 (147.32)
DAT-108-619-10	10,000	Polyester	White	16	0.300 (7.62)	0.300 (7.62)	0.300 (7.62)	0.500 (12.70)	5.800 (147.32)
0.800" Label Width — 6 lines per inch									
DAT-101-652-10	10,000	Polyimide	Amber	10	0.800 (20.32)	0.200 (5.08)	0.800 (20.32)	0.330 (8.46)	9.000 (228.60)
DAT-102-619-10	10,000	Polyester	White	10	0.800 (20.32)	0.200 (5.08)	0.800 (20.32)	0.330 (8.46)	9.000 (228.60)

Note: Labels in chart are sorted in order by width, height, 3 digit material number (within part number), then die number (within part number).

► BUTT-CUT WITH PERFORATIONS

Rounded Corners

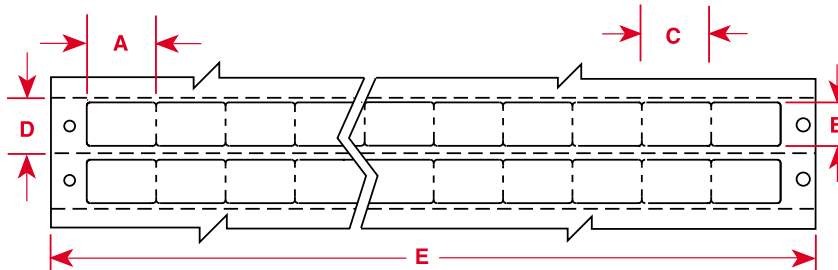

Part Number	Pieces Per Package	Material	Color	Labels Per Row	Label Width Inch (mm) A	Label Height Inch (mm) B	Horizontal Repeat Inch (mm) C	Vertical Repeat Inch (mm) D	Web Width Inch (mm) E
0.250" Label Width — 8 lines per inch									
DAT-172-652-10	10,000	Polyimide	Amber	20	0.250 (6.35)	0.250 (6.35)	0.250 (6.35)	0.500 (12.70)	6.000 (152.40)
DAT-173-619-10	10,000	Polyester	White	20	0.250 (6.35)	0.250 (6.35)	0.250 (6.35)	0.500 (12.70)	6.000 (152.40)
0.800" Label Width — 8 lines per inch									
DAT-103-652-10	10,000	Polyimide	Amber	10	0.800 (20.32)	0.500 (12.70)	0.800 (20.32)	0.625 (15.88)	9.000 (228.60)
DAT-104-619-10	10,000	Polyester	White	10	0.800 (20.32)	0.500 (12.70)	0.800 (20.32)	0.625 (15.88)	9.000 (228.60)
DAT-105-110-10	10,000	Paper	White	10	0.800 (20.32)	0.500 (12.70)	0.800 (20.32)	0.625 (15.88)	9.000 (228.60)

Note: Labels in chart are sorted in order by width, height, 3 digit material number (within part number), then die number (within part number).

Label Index by Size

► **SLIT LINER**
for easy removal

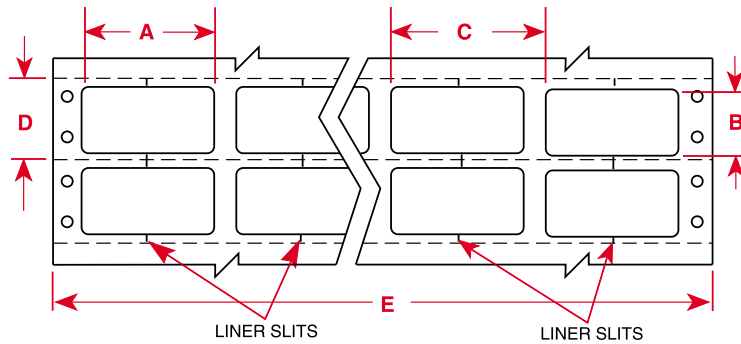

Part Number	Pieces Per Package	Material	Color	Labels Per Row	Label Width Inch (mm) A	Label Height Inch (mm) B	Horizontal Repeat Inch (mm) C	Vertical Repeat Inch (mm) D	Web Width Inch (mm) E
1.500" Label Width — 6 or 8 lines per inch									
BCDAT-12-619-10	10,000	Polyester	White	4	1.500 (38.10)	0.750 (19.05)	1.700 (43.18)	1.000 (25.40)	7.600 (193.04)
DAT-3-637-10	10,000	Polyvinylfluoride	White	4	1.500 (38.10)	0.750 (19.05)	1.700 (43.18)	1.000 (25.40)	7.600 (193.04)
DAT-4-637-10	10,000	Polyvinylfluoride	Yellow	4	1.500 (38.10)	0.750 (19.05)	1.700 (43.18)	1.000 (25.40)	7.600 (193.04)
DAT-48-693-10	10,000	Metallized Polyester	Silver	4	1.500 (38.10)	0.750 (19.05)	1.700 (43.18)	1.000 (25.40)	7.600 (193.04)
DAT-48-969-10	10,000	Metallized Polyester	Silver	4	1.500 (38.10)	0.750 (19.05)	1.700 (43.18)	1.000 (25.40)	7.600 (193.04)

Note: Labels in chart are sorted in order by width, height, 3 digit material number (within part number), then die number (within part number).

► **CENTER PERFORATION (VERTICAL)**

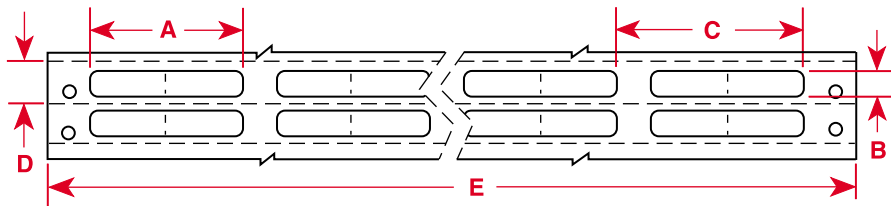

Part Number	Pieces Per Package	Material	Color	Labels Per Row	Label Width Inch (mm) A	Label Height Inch (mm) B	Horizontal Repeat Inch (mm) C	Vertical Repeat Inch (mm) D	Web Width Inch (mm) E
1.500" Label Width — 6 lines per inch									
DAT-28-121-10	10,000	Paper	White	4	1.500 (38.10)	0.250 (6.35)	1.800 (45.72)	0.330 (8.46)	7.900 (200.66)
DAT-29-502-10	10,000	Vinyl Cloth	White	4	1.500 (38.10)	0.250 (6.35)	1.800 (45.72)	0.330 (8.46)	7.900 (200.66)

Note: Labels in chart are sorted in order by width, height, 3 digit material number (within part number), then die number (within part number).

► CENTER PERFORATIONS (HORIZONTAL)

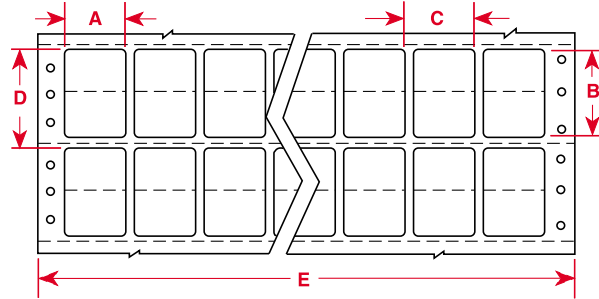

Part Number	Pieces Per Package	Material	Color	Labels Per Row	Label Width Inch (mm) A	Label Height Inch (mm) B	Horizontal Repeat Inch (mm) C	Vertical Repeat Inch (mm) D	Web Width Inch (mm) E
1.000" Label Width — 6 or 8 lines per inch									
DAT-87-632-10	10,000	Polyvinylfluoride	White	7	1.000 (25.40)	1.437 (36.50)	1.100 (27.94)	1.500 (38.10)	8.600 (218.44)

Note: Labels in chart are sorted in order by width, height, 3 digit material number (within part number), then die number (within part number).

► TAMPER-RESISTANT SLITS

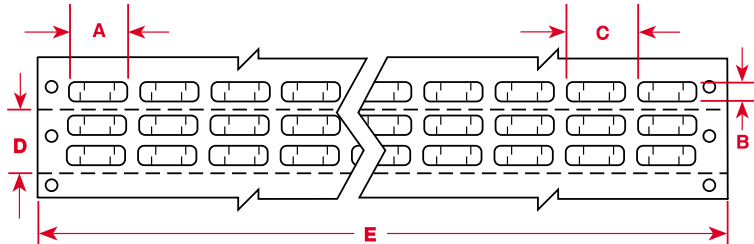

Part Number	Pieces Per Package	Material	Color	Labels Per Row	Label Width Inch (mm) A	Label Height Inch (mm) B	Horizontal Repeat Inch (mm) C	Vertical Repeat Inch (mm) D	Web Width Inch (mm) E
0.650" Label Width — 8 lines per inch									
DAT-90-619-10	10,000	Polyester	White	10	0.650 (16.51)	0.200 (5.08)	0.800 (20.32)	0.250 (6.35)	8.850 (224.80)
DAT-91-652-10	10,000	Polyimide	Amber	10	0.650 (16.51)	0.200 (5.08)	0.800 (20.32)	0.250 (6.35)	8.850 (224.80)
0.750" Label Width — 6 lines per inch									
DAT-92-619-10	10,000	Polyester	White	9	0.750 (19.05)	0.250 (6.35)	0.900 (22.86)	0.330 (8.46)	9.000 (228.60)
DAT-93-652-10	10,000	Polyimide	Amber	9	0.750 (19.05)	0.250 (6.35)	0.900 (22.86)	0.330 (8.46)	9.000 (228.60)
0.900" Label Width — 6 lines per inch									
DAT-94-652-10	10,000	Polyimide	Amber	8	0.900 (22.86)	0.250 (6.35)	1.000 (25.40)	0.330 (8.46)	8.900 (226.06)
DAT-95-619-10	10,000	Polyester	White	8	0.900 (22.86)	0.250 (6.35)	1.000 (25.40)	0.330 (8.46)	8.900 (226.06)

Note: Labels in chart are sorted in order by width, height, 3 digit material number (within part number), then die number (within part number).

Label Index by Size

► 0.062" BLACK BORDER

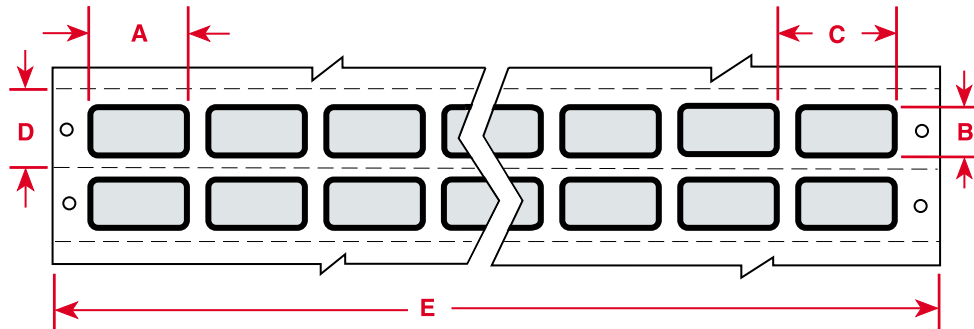

Part Number	Pieces Per Package	Material	Color	Labels Per Row	Label Width Inch (mm) A	Label Height Inch (mm) B	Horizontal Repeat Inch (mm) C	Vertical Repeat Inch (mm) D	Web Width Inch (mm) E
1.000" Label Width — 6 lines per inch									
DAT-164-969-10	10,000	Polyester	Silver	7	1.000 (25.40)	0.500 (12.70)	1.100 (27.94)	0.670 (17.02)	8.600 (218.44)

Note: Labels in chart are sorted in order by width, height, 3 digit material number (within part number), then die number (within part number).

► STATIC AWARENESS LABELS for EPROM marking

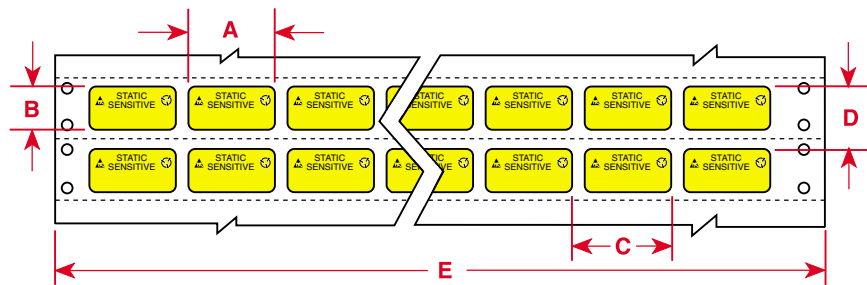

Part Number	Pieces Per Package	Material	Color	Printable Area Inch (mm)	Label Width Inch (mm) A	Label Height Inch (mm) B	Horizontal Repeat Inch (mm) C	Vertical Repeat Inch (mm) D	Web Width Inch (mm) E
1.000" Label Width — 6 or 8 lines per inch									
SLDAT-1-502-10	10,000	Vinyl Cloth	Black on Yellow	1.000 x 0.312 (25.40 x 7.92)	1.00 (25.40)	0.500 (12.70)	1.100 (27.94)	0.670 (17.02)	8.600 (218.44)
SLDAT-1-619-10	10,000	Polyester	Black on Yellow/White	1.000 x 0.312 (25.40 x 7.92)	1.00 (25.40)	0.500 (12.70)	1.100 (27.94)	0.670 (17.02)	8.600 (218.44)

Note: Labels in chart are sorted in order by width, height, 3 digit material number (within part number), then die number (within part number).

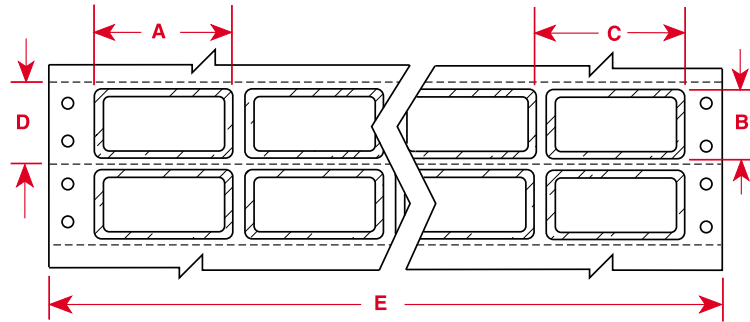

Clear polyester (B-966) overlamine extends 0.125" outside of label on each side.

Part Number	Pieces Per Package	Material	Color	Labels Per Row	Label Width Inch (mm) A	Label Height Inch (mm) B	Horizontal Repeat Inch (mm) C	Vertical Repeat Inch (mm) D	Web Width Inch (mm) E
1.000" Label Width — 6 or 8 lines per inch									
PSL-1-609-5	5,000	Paper	White	6	1.000 (25.40)	0.500 (12.70)	1.400 (35.56)	1.000 (25.40)	9.250 (234.95)
PSL-1-619-5	5,000	Polyester	White	6	1.000 (25.40)	0.500 (12.70)	1.400 (35.56)	1.000 (25.40)	9.250 (234.95)
PSL-1-969-5	5,000	Metallized Polyester	Silver	6	1.000 (25.40)	0.500 (12.70)	1.400 (35.56)	1.000 (25.40)	9.250 (234.95)
1.500" Label Width — 6 or 8 lines per inch									
PSL-2-609-5	5,000	Paper	White	4	1.500 (38.10)	0.750 (19.05)	1.900 (48.26)	1.500 (38.10)	8.450 (214.63)
PSL-2-619-5	5,000	Polyester	White	4	1.500 (38.10)	0.750 (19.05)	1.900 (48.26)	1.500 (38.10)	8.450 (214.63)
PSL-2-969-5	5,000	Metallized Polyester	Silver	4	1.500 (38.10)	0.750 (19.05)	1.900 (48.26)	1.500 (38.10)	8.450 (214.63)
2.000" Label Width — 6 or 8 lines per inch									
PSL-3-619-5	5,000	Polyester	White	3	2.000 (50.80)	1.000 (25.40)	2.400 (60.96)	1.500 (38.10)	8.050 (204.47)
PSL-3-969-5	5,000	Metallized Polyester	Silver	3	2.000 (50.80)	1.000 (25.40)	2.400 (60.96)	1.500 (38.10)	8.050 (204.47)

Note: Labels in chart are sorted in order by width, height, 3 digit material number (within part number), then die number (within part number).

*This product is sold in Japan under the Overlamine Labels name and not under the PermaShield name.

Terminal Block Markers by Size

▶ ONE-ACROSS

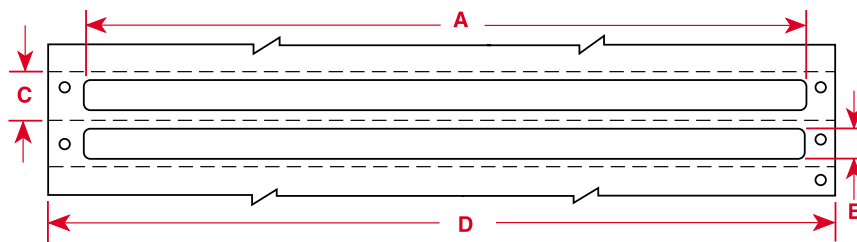

Part Number	Pieces Per Package	Material	Color	Labels Per Row	Label Width Inch (mm) A	Label Height Inch (mm) B	Vertical Repeat Inch (mm) C	Web Width Inch (mm) D
6.00" Label Width — 6 or 8 lines per inch								
BCDAT-7-609-2.5	2,500	Paper	White	1	6.000 (152.40)	3.937 (100.00)	4.000 (101.60)	7.000 (177.80)

Note: Labels in chart are sorted in order by width, height, 3 digit material number (within part number), then die number (within part number).

Terminal Block Markers by Size

▶ CONTINUOUS STRIP / ONE-ACROSS

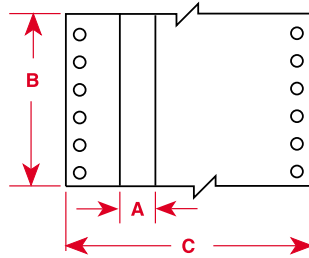

Part Number	Inches Per Package	Material	Color	Strips Per Row	Label Width Inch (mm) A	Label Height Inch (mm) B	Web Width Inch (mm) C
0.312" Label Width — 6 or 8 lines per inch							
DAT-157-502-2	2,000"	Vinyl Cloth	White	1	0.312 (7.92)	Continuous	3.500 (88.90)
0.375" Label Width — 6 or 8 lines per inch							
DAT-158-502-2	2,000"	Vinyl Cloth	White	1	0.375 (9.53)	Continuous	3.500 (88.90)

Note: Labels in chart are sorted in order by width, height, 3 digit material number (within part number), then die number (within part number).

▶ CONTINUOUS STRIP / MULTIPLE ACROSS

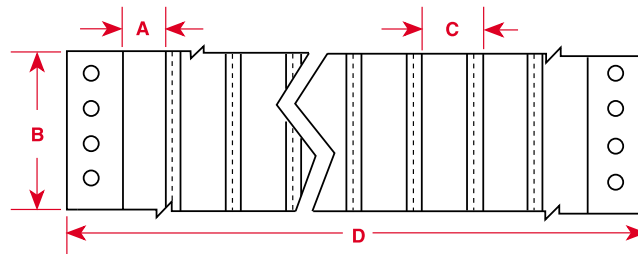

Part Number	Inches Per Package	Material	Color	Labels Per Row	Label Width Inch (mm) A	Label Height Feet (m) B	Horizontal Repeat Inch (mm) C	Web Width Inch (mm) D
0.375" Label Width — 6 or 8 lines per inch								
DAT-100-502-7	7,000"	Vinyl Cloth	White	8	0.375 (9.53)	165 ft (50.30 m)	0.500 (12.70)	5.000 (127.00)

Note: Labels in chart are sorted in order by width, height, 3 digit material number (within part number), then die number (within part number).

▶ CONTINUOUS STRIP / PERFORATED

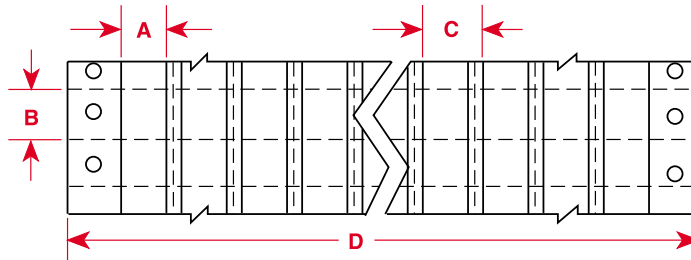

Part Number	Inches Per Package	Material	Color	Labels Per Row	Label Width Inch (mm) A	Label Height Feet (m) B	Horizontal Repeat Inch (mm) C	Web Width Inch (mm) D
0.375" Label Width — 8 lines per inch								
DAT-168-619-2	2,000"	Polyester	White	1	0.375 (9.53)	0.200 (5.08)	NA	3.500 (88.90)

Note: Labels in chart are sorted in order by width, height, 3 digit material number (within part number), then die number (within part number).

► BUTT-CUT TRANSLUCENT

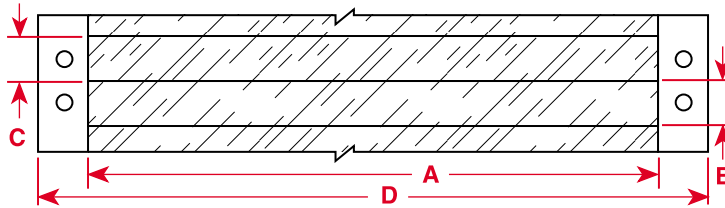

Part Number	Pieces Per Package	Material	Color	Labels Per Row	Label Width Inch (mm) A	Label Height Inch (mm) B	Vertical Repeat Inch (mm) C	Web Width Inch (mm) D
7.500" Label Width — 6 or 8 lines per inch								
DAT-169-621-2.5	2,500	Polyester	Clear	1	7.500 (190.50)	0.500 (12.70)	0.500 (12.70)	8.620 (218.95)

Note: Labels in chart are sorted in order by width, height, 3 digit material number (within part number), then die number (within part number).

► PREPRINTED / PERFORATED

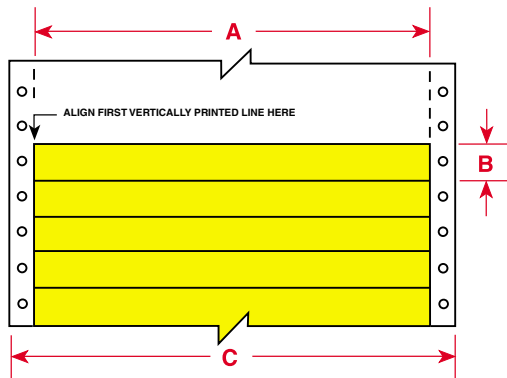

Part Number	Pieces Per Package	Material	Color	Strips Per Row	Strip Width Inch (mm) A	Strip Height Inch (mm) B	Web Width Inch (mm) C
7.900" Label Width — 6 or 8 lines per inch							
DAT-177-124	150	Paper	White	1	7.900 (200.66)	0.475 (12.07)	8.875 (225.43)
DAT-177-124-BL	150	Paper	Blue	1	7.900 (200.66)	0.475 (12.07)	8.875 (225.43)
DAT-177-124-BR	150	Paper	Brown	1	7.900 (200.66)	0.475 (12.07)	8.875 (225.43)
DAT-177-124-GR	150	Paper	Green	1	7.900 (200.66)	0.475 (12.07)	8.875 (225.43)
DAT-177-124-GY	150	Paper	Gray	1	7.900 (200.66)	0.475 (12.07)	8.875 (225.43)
DAT-177-124-OR	150	Paper	Orange	1	7.900 (200.66)	0.475 (12.07)	8.875 (225.43)
DAT-177-124-PL	150	Paper	Purple	1	7.900 (200.66)	0.475 (12.07)	8.875 (225.43)
DAT-177-124-RD	150	Paper	Red	1	7.900 (200.66)	0.475 (12.07)	8.875 (225.43)
DAT-177-124-YL	150	Paper	Yellow	1	7.900 (200.66)	0.475 (12.07)	8.875 (225.43)

Note: Labels in chart are sorted in order by width, height, 3 digit material number (within part number), then die number (within part number).

Self-Laminating Wire and Cable Markers by Size

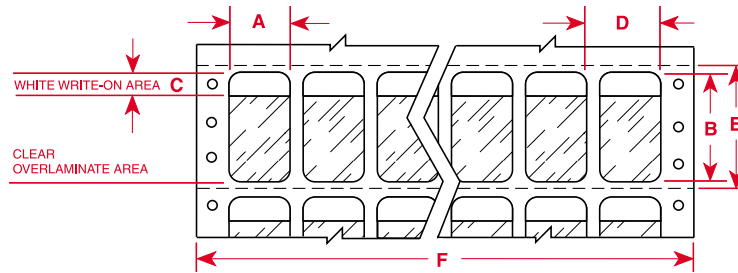

Part Number	Pieces Per Package	Material	Labels Per Row	Label Width Inch (mm) A	Label Height Inch (mm) B	Write-On Height Inch (mm) C	Horizontal Repeat Inch (mm) D	Vertical Repeat Inch (mm) E	Web Width Inch (mm) F
0.500" Label Width — 6 or 8 lines per inch									
DAT-30-292*-1,-10	1,000/10,000	Vinyl	14	0.500 (12.70)	0.750 (19.05)	0.375 (9.53)	0.600 (15.24)	1.000 (25.40)	9.300 (236.22)
DAT-66-292-1,-10	1,000/10,000	Vinyl	12	0.500 (12.70)	0.750 (19.05)	0.375 (9.53)	0.600 (15.24)	1.000 (25.40)	8.100 (205.74)
DAT-71-642-10	10,000	Polyvinylfluoride	12	0.500 (12.70)	0.750 (19.05)	0.375 (9.53)	0.600 (15.24)	1.000 (25.40)	8.100 (205.74)
DAT-55-642*-10	10,000	Polyvinylfluoride	14	0.500 (12.70)	0.750 (19.05)	0.375 (9.53)	0.600 (15.24)	1.000 (25.40)	9.300 (236.22)
0.750" Label Width — 6 or 8 lines per inch									
DAT-36-292-1,-10	1,000/10,000	Vinyl	9	0.750 (19.05)	1.750 (44.45)	0.500 (12.70)	0.900 (22.86)	2.000 (50.80)	9.000 (228.60)
0.800" Label Width — 6 or 8 lines per inch									
DAT-7-292-1,-10	1,000/10,000	Vinyl	6	0.800 (20.32)	1.437 (36.50)	0.500 (12.70)	0.900 (22.86)	1.500 (38.10)	6.300 (160.00)
DAT-52-642-10	10,000	Polyvinylfluoride	6	0.800 (20.32)	1.437 (36.50)	0.500 (12.70)	0.900 (22.86)	1.500 (38.10)	6.300 (160.00)
1.000" Label Width — 6 or 8 lines per inch									
DAT-185-292-1,-2.5	1,000/2,500	Vinyl	7	1.000 (25.40)	2.500 (63.50)	0.750 (19.05)	1.100 (27.94)	3.000 (76.20)	8.600 (218.44)
DAT-187-292-1,-2.5	1,000/2,500	Vinyl	7	1.000 (25.40)	4.000 (101.60)	1.000 (25.40)	1.100 (27.94)	4.500 (114.30)	8.600 (218.44)
DAT-41-292*-1,-2.5	1,000/2,500	Vinyl	8	1.000 (25.40)	5.937 (150.80)	1.500 (38.10)	1.100 (27.94)	6.000 (152.40)	9.500 (241.30)
DAT-69-292-1,-2.5	1,000/2,500	Vinyl	7	1.000 (25.40)	5.937 (150.80)	1.500 (38.10)	1.100 (27.94)	6.000 (152.40)	8.400 (213.36)
DAT-69-292-BL**	2,500	Vinyl	7	1.000 (25.40)	5.937 (150.80)	1.500 (38.10)	1.100 (27.94)	6.000 (152.40)	8.400 (213.36)
DAT-69-292-BR**	2,500	Vinyl	7	1.000 (25.40)	5.937 (150.80)	1.500 (38.10)	1.100 (27.94)	6.000 (152.40)	8.400 (213.36)
DAT-69-292-GR**	2,500	Vinyl	7	1.000 (25.40)	5.937 (150.80)	1.500 (38.10)	1.100 (27.94)	6.000 (152.40)	8.400 (213.36)
DAT-69-292-GY**	2,500	Vinyl	7	1.000 (25.40)	5.937 (150.80)	1.500 (38.10)	1.100 (27.94)	6.000 (152.40)	8.400 (213.36)
DAT-69-292-OR**	2,500	Vinyl	7	1.000 (25.40)	5.937 (150.80)	1.500 (38.10)	1.100 (27.94)	6.000 (152.40)	8.400 (213.36)
DAT-69-292-PL**	2,500	Vinyl	7	1.000 (25.40)	5.937 (150.80)	1.500 (38.10)	1.100 (27.94)	6.000 (152.40)	8.400 (213.36)
DAT-69-292-RD**	2,500	Vinyl	7	1.000 (25.40)	5.937 (150.80)	1.500 (38.10)	1.100 (27.94)	6.000 (152.40)	8.400 (213.36)
DAT-69-292-YL**	2,500	Vinyl	7	1.000 (25.40)	5.937 (150.80)	1.500 (38.10)	1.100 (27.94)	6.000 (152.40)	8.400 (213.36)
DAT-42-292*-1,-2.5	1,000/2,500	Vinyl	8	1.000 (25.40)	7.437 (188.90)	1.500 (38.10)	1.100 (27.94)	7.500 (190.50)	9.500 (241.30)
DAT-70-292-1,-2.5	1,000/2,500	Vinyl	7	1.000 (25.40)	7.437 (188.90)	1.500 (38.10)	1.100 (27.94)	7.500 (190.50)	8.400 (213.36)
1.500" Label Width — 6 or 8 lines per inch									
DAT-186-292-1,-2.5	1,000/2,500	Vinyl	4	1.500 (38.10)	2.500 (63.50)	0.750 (19.05)	1.600 (40.64)	3.000 (76.20)	7.300 (185.42)
DAT-188-292-1,-2.5	1,000/2,500	Vinyl	4	1.500 (38.10)	4.000 (101.60)	1.000 (25.40)	1.600 (40.64)	4.500 (114.30)	7.300 (185.42)
1.900" Label Width — 6 or 8 lines per inch									
DAT-8-292*-1,-2.5	1,000/2,500	Vinyl	4	1.900 (48.26)	3.187 (80.95)	0.750 (19.05)	2.000 (50.80)	3.500 (88.90)	9.500 (241.30)
DAT-63-292-1,-2.5	1,000/2,500	Vinyl	3	1.900 (48.26)	3.187 (80.95)	0.750 (19.05)	2.000 (50.80)	3.500 (88.90)	7.500 (190.50)

*Size does not fit narrow carriage (80-column) printers. See p. 158 for identical narrow carriage labels.

**BL=blue, BR=brown, GR=green, GY=grey, OR=orange, PL=purple, RD=red, YL=yellow.
Standard product lead time of 10 working days.

Note: Labels in chart are sorted in order by width, height, 3 digit material number (within part number), then die number (within part number).

Self-Laminating Wire and Cable Markers by Size

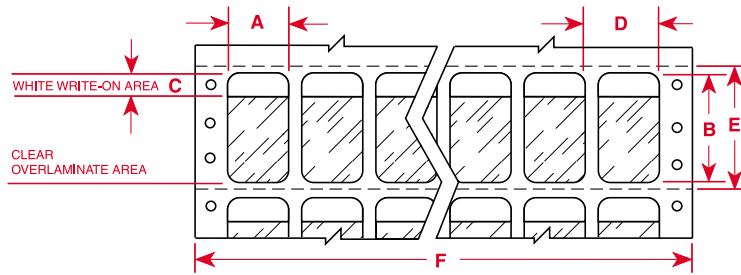

Part Number	Pieces Per Package	Material	Labels Per Row	Label Width Inch (mm) A	Label Height Inch (mm) B	Write-On Height Inch (mm) C	Horizontal Repeat Inch (mm) D	Vertical Repeat Inch (mm) E	Web Width Inch (mm) F
2.000" Label Width — 6 or 8 lines per inch									
DAT-9-292*-1,-2.5	1,000/2,500	Vinyl	6	2.000 (50.80)	5.937 (150.80)	1.500 (38.10)	2.100 (53.34)	6.000 (152.40)	13.500 (342.90)
DAT-75-292-1,-2.5	1,000/2,500	Vinyl	3	2.000 (50.80)	5.937 (150.80)	1.500 (38.10)	2.100 (53.34)	6.000 (152.40)	7.000 (177.80)
DAT-75-292-BL**	2,500	Vinyl	3	2.000 (50.80)	5.937 (150.80)	1.500 (38.10)	2.100 (53.34)	6.000 (152.40)	7.000 (177.80)
DAT-75-292-BR**	2,500	Vinyl	3	2.000 (50.80)	5.937 (150.80)	1.500 (38.10)	2.100 (53.34)	6.000 (152.40)	7.000 (177.80)
DAT-75-292-GR**	2,500	Vinyl	3	2.000 (50.80)	5.937 (150.80)	1.500 (38.10)	2.100 (53.34)	6.000 (152.40)	7.000 (177.80)
DAT-75-292-GY**	2,500	Vinyl	3	2.000 (50.80)	5.937 (150.80)	1.500 (38.10)	2.100 (53.34)	6.000 (152.40)	7.000 (177.80)
DAT-75-292-OR**	2,500	Vinyl	3	2.000 (50.80)	5.937 (150.80)	1.500 (38.10)	2.100 (53.34)	6.000 (152.40)	7.000 (177.80)
DAT-75-292-PL**	2,500	Vinyl	3	2.000 (50.80)	5.937 (150.80)	1.500 (38.10)	2.100 (53.34)	6.000 (152.40)	7.000 (177.80)
DAT-75-292-RD**	2,500	Vinyl	3	2.000 (50.80)	5.937 (150.80)	1.500 (38.10)	2.100 (53.34)	6.000 (152.40)	7.000 (177.80)
DAT-75-292-YL**	2,500	Vinyl	3	2.000 (50.80)	5.937 (150.80)	1.500 (38.10)	2.100 (53.34)	6.000 (152.40)	7.000 (177.80)
DAT-14-292*-1,-2.5	1,000/2,500	Vinyl	4	2.000 (50.80)	7.437 (188.90)	1.500 (38.10)	2.200 (55.88)	7.500 (190.50)	9.400 (238.76)
DAT-65-292-1,-2.5	1,000/2,500	Vinyl	3	2.000 (50.80)	7.437 (188.90)	1.500 (38.10)	2.100 (53.34)	7.500 (190.50)	7.200 (182.88)
DAT-159-292-1,-2.5	1,000/2,500	Vinyl	3	2.000 (50.80)	8.437 (214.30)	1.500 (38.10)	2.100 (53.34)	8.500 (215.90)	7.200 (182.88)
DAT-159-292-BL**	2,500	Vinyl	3	2.000 (50.80)	8.437 (214.30)	1.500 (38.10)	2.100 (53.34)	8.500 (215.90)	7.200 (182.88)
DAT-159-292-BR**	2,500	Vinyl	3	2.000 (50.80)	8.437 (214.30)	1.500 (38.10)	2.100 (53.34)	8.500 (215.90)	7.200 (182.88)
DAT-159-292-GR**	2,500	Vinyl	3	2.000 (50.80)	8.437 (214.30)	1.500 (38.10)	2.100 (53.34)	8.500 (215.90)	7.200 (182.88)
DAT-159-292-GY**	2,500	Vinyl	3	2.000 (50.80)	8.437 (214.30)	1.500 (38.10)	2.100 (53.34)	8.500 (215.90)	7.200 (182.88)
DAT-159-292-OR**	2,500	Vinyl	3	2.000 (50.80)	8.437 (214.30)	1.500 (38.10)	2.100 (53.34)	8.500 (215.90)	7.200 (182.88)
DAT-159-292-PL**	2,500	Vinyl	3	2.000 (50.80)	8.437 (214.30)	1.500 (38.10)	2.100 (53.34)	8.500 (215.90)	7.200 (182.88)
DAT-159-292-RD**	2,500	Vinyl	3	2.000 (50.80)	8.437 (214.30)	1.500 (38.10)	2.100 (53.34)	8.500 (215.90)	7.200 (182.88)
DAT-159-292-YL**	2,500	Vinyl	3	2.000 (50.80)	8.437 (214.30)	1.500 (38.10)	2.100 (53.34)	8.500 (215.90)	7.200 (182.88)

*Size does not fit narrow carriage (80-column) printers. See p. 158 for identical narrow carriage labels.

**BL=blue, BR=brown, GR=green, GY=grey, OR=orange, PL=purple, RD=red, YL=yellow.
Standard product lead time of 10 working days.

Note: Labels in chart are sorted in order by width, height, 3 digit material number (within part number), then die number (within part number).

Self-Laminating Wire and Cable Markers by Size

► BUTT-CUT

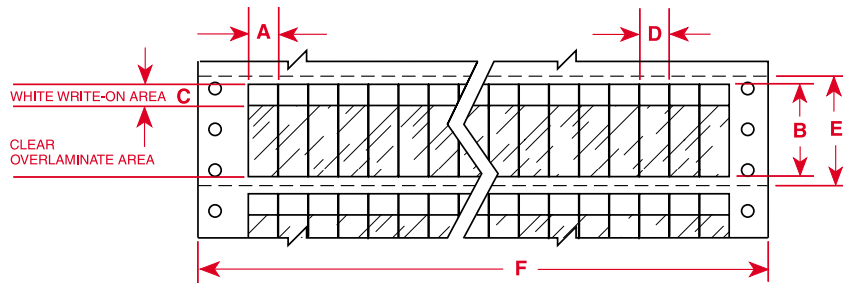

Part Number	Pieces Per Package	Material	Labels Per Row	Label Width Inch (mm) A	Label Height Inch (mm) B	Write-On Height Inch (mm) C	Horizontal Repeat Inch (mm) D	Vertical Repeat Inch (mm) E	Web Width Inch (mm) F
0.300" Label Width — 6 or 8 lines per inch									
DAT-139-292-1,-10	1,000/10,000	Vinyl	16	0.300 (7.62)	0.75 (19.05)	0.375 (9.53)	0.300 (7.62)	1.000 (25.40)	5.800 (147.32)
DAT-142-292-1,-10	1,000/10,000	Vinyl	16	0.300 (7.62)	0.937 (23.80)	0.375 (9.53)	0.300 (7.62)	1.000 (25.40)	5.800 (147.32)
0.500" Label Width — 6 or 8 lines per inch									
DAT-145-292-1,-10	1,000/10,000	Vinyl	16	0.500 (12.70)	0.937 (23.80)	0.375 (9.53)	0.500 (12.70)	1.000 (25.40)	9.000 (228.60)
DAT-33-292-1,-10	1,000/10,000	Vinyl	16	0.500 (12.70)	1.437 (36.50)	0.500 (12.70)	0.500 (12.70)	1.500 (38.10)	9.000 (228.60)
DAT-53-642-1,-10	1,000/10,000	Polyvinylfluoride	16	0.500 (12.70)	1.437 (36.50)	0.500 (12.70)	0.500 (12.70)	1.500 (38.10)	9.000 (228.60)
SLSH-0515	1,664	Vinyl	16	0.500 (12.70)	1.437 (36.50)	0.500 (12.70)	0.500 (12.70)	1.500 (38.10)	9.000 (228.60)
0.800" Label Width — 6 or 8 lines per inch									
DAT-148-292-1,-10	1,000/10,000	Vinyl	10	0.800 (20.32)	0.937 (23.80)	0.375 (9.53)	0.800 (20.32)	1.000 (25.40)	9.000 (228.60)
1.000" Label Width — 6 or 8 lines per inch									
DAT-85-292-1,-10	1,000/10,000	Vinyl	8	1.000 (25.40)	0.750 (19.05)	0.375 (9.53)	1.000 (25.40)	1.000 (25.40)	9.000 (228.60)
DAT-85-292-BL**	2,500	Vinyl	8	1.000 (25.40)	0.750 (19.05)	0.375 (9.53)	1.000 (25.40)	1.000 (25.40)	9.000 (228.60)
DAT-85-292-BR**	2,500	Vinyl	8	1.000 (25.40)	0.750 (19.05)	0.375 (9.53)	1.000 (25.40)	1.000 (25.40)	9.000 (228.60)
DAT-85-292-GR**	2,500	Vinyl	8	1.000 (25.40)	0.750 (19.05)	0.375 (9.53)	1.000 (25.40)	1.000 (25.40)	9.000 (228.60)
DAT-85-292-GY**	2,500	Vinyl	8	1.000 (25.40)	0.750 (19.05)	0.375 (9.53)	1.000 (25.40)	1.000 (25.40)	9.000 (228.60)
DAT-85-292-OR**	2,500	Vinyl	8	1.000 (25.40)	0.750 (19.05)	0.375 (9.53)	1.000 (25.40)	1.000 (25.40)	9.000 (228.60)
DAT-85-292-PL**	2,500	Vinyl	8	1.000 (25.40)	0.750 (19.05)	0.375 (9.53)	1.000 (25.40)	1.000 (25.40)	9.000 (228.60)
DAT-85-292-RD**	2,500	Vinyl	8	1.000 (25.40)	0.750 (19.05)	0.375 (9.53)	1.000 (25.40)	1.000 (25.40)	9.000 (228.60)
DAT-85-292-YL**	2,500	Vinyl	8	1.000 (25.40)	0.750 (19.05)	0.375 (9.53)	1.000 (25.40)	1.000 (25.40)	9.000 (228.60)
DAT-151-292-1,-10	1,000/10,000	Vinyl	8	1.000 (25.40)	0.937 (23.80)	0.375 (9.53)	1.000 (25.40)	1.000 (25.40)	9.000 (228.60)
DAT-34-292-1,-10	1,000/10,000	Vinyl	8	1.000 (25.40)	1.437 (36.50)	0.500 (12.70)	1.000 (25.40)	1.500 (38.10)	9.000 (228.60)
DAT-34-292-BL**	2,500	Vinyl	8	1.000 (25.40)	1.437 (36.50)	0.500 (12.70)	1.000 (25.40)	1.500 (38.10)	9.000 (228.60)
DAT-34-292-BR**	2,500	Vinyl	8	1.000 (25.40)	1.437 (36.50)	0.500 (12.70)	1.000 (25.40)	1.500 (38.10)	9.000 (228.60)
DAT-34-292-GR**	2,500	Vinyl	8	1.000 (25.40)	1.437 (36.50)	0.500 (12.70)	1.000 (25.40)	1.500 (38.10)	9.000 (228.60)
DAT-34-292-GY**	2,500	Vinyl	8	1.000 (25.40)	1.437 (36.50)	0.500 (12.70)	1.000 (25.40)	1.500 (38.10)	9.000 (228.60)
DAT-34-292-OR**	2,500	Vinyl	8	1.000 (25.40)	1.437 (36.50)	0.500 (12.70)	1.000 (25.40)	1.500 (38.10)	9.000 (228.60)
DAT-34-292-PL**	2,500	Vinyl	8	1.000 (25.40)	1.437 (36.50)	0.500 (12.70)	1.000 (25.40)	1.500 (38.10)	9.000 (228.60)
DAT-34-292-RD**	2,500	Vinyl	8	1.000 (25.40)	1.437 (36.50)	0.500 (12.70)	1.000 (25.40)	1.500 (38.10)	9.000 (228.60)
DAT-34-292-YL**	2,500	Vinyl	8	1.000 (25.40)	1.437 (36.50)	0.500 (12.70)	1.000 (25.40)	1.500 (38.10)	9.000 (228.60)
DAT-54-642-10	10,000	Polyvinylfluoride	8	1.000 (25.40)	1.437 (36.50)	0.500 (12.70)	1.000 (25.40)	1.500 (38.10)	9.000 (228.60)
SLSH-1015	832	Vinyl	8	1.000 (25.40)	1.437 (36.50)	0.500 (12.70)	1.000 (25.40)	1.500 (38.10)	9.000 (228.60)
DAT-37-292-1,-10	1,000/10,000	Vinyl	8	1.000 (25.40)	2.250 (57.15)	0.750 (19.05)	1.000 (25.40)	2.500 (63.50)	9.000 (228.60)
DAT-37-292-BL**	2,500	Vinyl	8	1.000 (25.40)	2.250 (57.15)	0.750 (19.05)	1.000 (25.40)	2.500 (63.50)	9.000 (228.60)
DAT-37-292-BR**	2,500	Vinyl	8	1.000 (25.40)	2.250 (57.15)	0.750 (19.05)	1.000 (25.40)	2.500 (63.50)	9.000 (228.60)
DAT-37-292-GR**	2,500	Vinyl	8	1.000 (25.40)	2.250 (57.15)	0.750 (19.05)	1.000 (25.40)	2.500 (63.50)	9.000 (228.60)
DAT-37-292-GY**	2,500	Vinyl	8	1.000 (25.40)	2.250 (57.15)	0.750 (19.05)	1.000 (25.40)	2.500 (63.50)	9.000 (228.60)
DAT-37-292-OR**	2,500	Vinyl	8	1.000 (25.40)	2.250 (57.15)	0.750 (19.05)	1.000 (25.40)	2.500 (63.50)	9.000 (228.60)
DAT-37-292-PL**	2,500	Vinyl	8	1.000 (25.40)	2.250 (57.15)	0.750 (19.05)	1.000 (25.40)	2.500 (63.50)	9.000 (228.60)
DAT-37-292-RD**	2,500	Vinyl	8	1.000 (25.40)	2.250 (57.15)	0.750 (19.05)	1.000 (25.40)	2.500 (63.50)	9.000 (228.60)
DAT-37-292-YL**	2,500	Vinyl	8	1.000 (25.40)	2.250 (57.15)	0.750 (19.05)	1.000 (25.40)	2.500 (63.50)	9.000 (228.60)
SLSH-10225	608	Vinyl	8	1.000 (25.40)	2.250 (57.15)	0.750 (19.05)	1.000 (25.40)	2.500 (63.50)	9.000 (228.60)

**BL=blue, BR=brown, GR=green, GY=grey, OR=orange, PL=purple, RD=red, YL=yellow.
Standard product lead time of 10 working days.

Note: Labels in chart are sorted in order by width, height, 3 digit material number (within part number), then die number (within part number).

MARKERS INDEX BY SIZE DOT MATRIX LABELS

Self-Laminating Wire and Cable Markers by Size

► BUTT-CUT

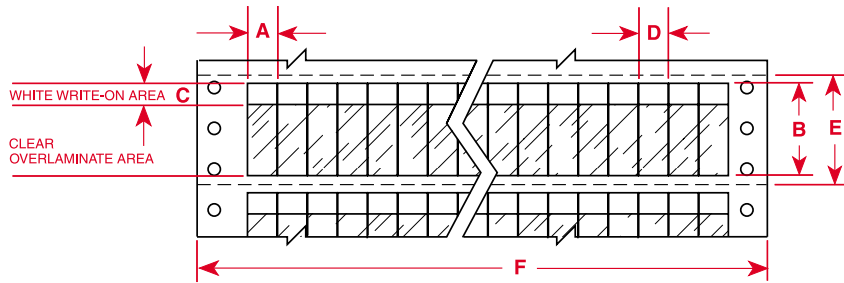

Part Number	Pieces Per Package	Material	Labels Per Row	Label Width Inch (mm) A	Label Height Inch (mm) B	Write-On Height Inch (mm) C	Horizontal Repeat Inch (mm) D	Vertical Repeat Inch (mm) E	Web Width Inch (mm) F
1.000" Label Width — 6 or 8 lines per inch (Cont.)									
DAT-39-292-1,-2.5	1,000/2,500	Vinyl	8	1.000 (25.40)	3.750 (95.25)	1.000 (25.40)	1.000 (25.40)	4.000 (101.60)	9.000 (228.60)
DAT-39-292-BL**	2,500	Vinyl	8	1.000 (25.40)	3.750 (95.25)	1.000 (25.40)	1.000 (25.40)	4.000 (101.60)	9.000 (228.60)
DAT-39-292-BR**	2,500	Vinyl	8	1.000 (25.40)	3.750 (95.25)	1.000 (25.40)	1.000 (25.40)	4.000 (101.60)	9.000 (228.60)
DAT-39-292-GR**	2,500	Vinyl	8	1.000 (25.40)	3.750 (95.25)	1.000 (25.40)	1.000 (25.40)	4.000 (101.60)	9.000 (228.60)
DAT-39-292-GY**	2,500	Vinyl	8	1.000 (25.40)	3.750 (95.25)	1.000 (25.40)	1.000 (25.40)	4.000 (101.60)	9.000 (228.60)
DAT-39-292-OR**	2,500	Vinyl	8	1.000 (25.40)	3.750 (95.25)	1.000 (25.40)	1.000 (25.40)	4.000 (101.60)	9.000 (228.60)
DAT-39-292-PL**	2,500	Vinyl	8	1.000 (25.40)	3.750 (95.25)	1.000 (25.40)	1.000 (25.40)	4.000 (101.60)	9.000 (228.60)
DAT-39-292-RD**	2,500	Vinyl	8	1.000 (25.40)	3.750 (95.25)	1.000 (25.40)	1.000 (25.40)	4.000 (101.60)	9.000 (228.60)
DAT-39-292-YL**	2,500	Vinyl	8	1.000 (25.40)	3.750 (95.25)	1.000 (25.40)	1.000 (25.40)	4.000 (101.60)	9.000 (228.60)
SLSH-10375	408	Vinyl	8	1.000 (25.40)	3.750 (95.25)	1.000 (25.40)	1.000 (25.40)	4.000 (101.60)	9.000 (228.60)
2.000" Label Width — 6 or 8 lines per inch									
DAT-35-292-1,-10	1,000/10,000	Vinyl	4	2.000 (50.80)	1.437 (36.50)	0.500 (12.70)	2.000 (50.80)	1.500 (38.10)	9.000 (228.60)
SLSH-2015	416	Vinyl	4	2.000 (50.80)	1.437 (36.50)	0.500 (12.70)	2.000 (50.80)	1.500 (38.10)	9.000 (228.60)
DAT-38-292-1,-2.5	1,000/2,500	Vinyl	4	2.000 (50.80)	2.250 (57.15)	0.750 (19.05)	2.000 (50.80)	2.500 (63.50)	9.000 (228.60)
DAT-38-292-BL**	2,500	Vinyl	4	2.000 (50.80)	2.250 (57.15)	0.750 (19.05)	2.000 (50.80)	2.500 (63.50)	9.000 (228.60)
DAT-38-292-BR**	2,500	Vinyl	4	2.000 (50.80)	2.250 (57.15)	0.750 (19.05)	2.000 (50.80)	2.500 (63.50)	9.000 (228.60)
DAT-38-292-GR**	2,500	Vinyl	4	2.000 (50.80)	2.250 (57.15)	0.750 (19.05)	2.000 (50.80)	2.500 (63.50)	9.000 (228.60)
DAT-38-292-GY**	2,500	Vinyl	4	2.000 (50.80)	2.250 (57.15)	0.750 (19.05)	2.000 (50.80)	2.500 (63.50)	9.000 (228.60)
DAT-38-292-OR**	2,500	Vinyl	4	2.000 (50.80)	2.250 (57.15)	0.750 (19.05)	2.000 (50.80)	2.500 (63.50)	9.000 (228.60)
DAT-38-292-PL**	2,500	Vinyl	4	2.000 (50.80)	2.250 (57.15)	0.750 (19.05)	2.000 (50.80)	2.500 (63.50)	9.000 (228.60)
DAT-38-292-RD**	2,500	Vinyl	4	2.000 (50.80)	2.250 (57.15)	0.750 (19.05)	2.000 (50.80)	2.500 (63.50)	9.000 (228.60)
DAT-38-292-YL**	2,500	Vinyl	4	2.000 (50.80)	2.250 (57.15)	0.750 (19.05)	2.000 (50.80)	2.500 (63.50)	9.000 (228.60)
SLSH-20225	304	Vinyl	4	2.000 (50.80)	2.250 (57.15)	0.750 (19.05)	2.000 (50.80)	2.500 (63.50)	9.000 (228.60)
DAT-40-292-1,-2.5	1,000/2,500	Vinyl	4	2.000 (50.80)	3.750 (95.25)	1.000 (25.40)	2.000 (50.80)	4.000 (101.60)	9.000 (228.60)
DAT-40-292-BL**	2,500	Vinyl	4	2.000 (50.80)	3.750 (95.25)	1.000 (25.40)	2.000 (50.80)	4.000 (101.60)	9.000 (228.60)
DAT-40-292-BR**	2,500	Vinyl	4	2.000 (50.80)	3.750 (95.25)	1.000 (25.40)	2.000 (50.80)	4.000 (101.60)	9.000 (228.60)
DAT-40-292-GR**	2,500	Vinyl	4	2.000 (50.80)	3.750 (95.25)	1.000 (25.40)	2.000 (50.80)	4.000 (101.60)	9.000 (228.60)
DAT-40-292-GY**	2,500	Vinyl	4	2.000 (50.80)	3.750 (95.25)	1.000 (25.40)	2.000 (50.80)	4.000 (101.60)	9.000 (228.60)
DAT-40-292-OR**	2,500	Vinyl	4	2.000 (50.80)	3.750 (95.25)	1.000 (25.40)	2.000 (50.80)	4.000 (101.60)	9.000 (228.60)
DAT-40-292-PL**	2,500	Vinyl	4	2.000 (50.80)	3.750 (95.25)	1.000 (25.40)	2.000 (50.80)	4.000 (101.60)	9.000 (228.60)
DAT-40-292-RD**	2,500	Vinyl	4	2.000 (50.80)	3.750 (95.25)	1.000 (25.40)	2.000 (50.80)	4.000 (101.60)	9.000 (228.60)
DAT-40-292-YL**	2,500	Vinyl	4	2.000 (50.80)	3.750 (95.25)	1.000 (25.40)	2.000 (50.80)	4.000 (101.60)	9.000 (228.60)
SLSH-20375	204	Vinyl	4	2.000 (50.80)	3.750 (95.25)	1.000 (25.40)	2.000 (50.80)	4.000 (101.60)	9.000 (228.60)

**BL=blue, BR=brown, GR=green, GY=grey, OR=orange, PL=purple, RD=red, YL=yellow.
Standard product lead time of 10 working days.

Note: Labels in chart are sorted in order by width, height, 3 digit material number (within part number), then die number (within part number).

Self-Laminating Wire and Cable Markers by Size

► CABLE MARKERS

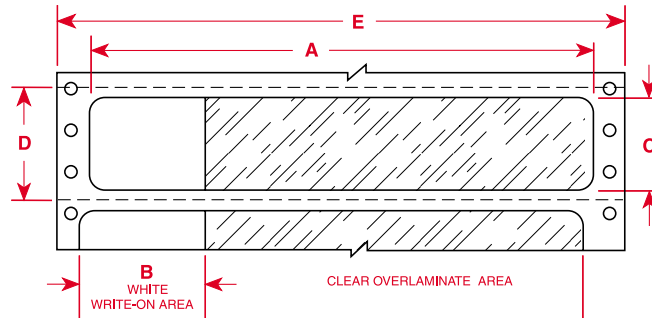

Part Number	Pieces Per Package	Material	Labels Per Row	Label Height Inch (mm) A	Write-On Height Inch (mm) B	Label Width Inch (mm) C	Vertical Repeat Inch (mm) D	Web Width Inch (mm) E
8.500" Label Width — 6 or 8 lines per inch								
DAT-162-292-1,-2.5	1,000/2,500	Vinyl	1	8.500 (215.90)	1.500 (38.10)	2.000 (50.80)	2.500 (63.50)	9.500 (241.30)

Note: Labels in chart are sorted in order by width, height, 3 digit material number (within part number), then die number (within part number).

Cable Markers by Size

► BRADYWRAP™

Continuous strip/cut-to-length

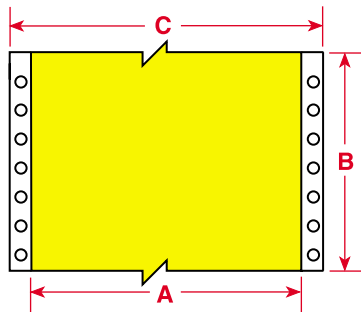

Part Number	Roll Length Ft (m)	Material	Color	Label Width Inch (mm) A	Label Height Ft (m) B	Web Width Inch (mm) C	Maximum Characters Across		
							5 CPI	10 CPI	17 CPI
1.000" Label Width — 6 or 8 lines per inch									
RCM-637-1.0-WT	100 (30.48)	Tedlar®	White	1.000 (25.40)	100 (30.48 m)	3.600 (91.44)	4	9	15
RCM-637-1.0-YL	100 (30.48)	Tedlar	Yellow	1.000 (25.40)	100 (30.48 m)	3.600 (91.44)	4	9	15
1.500" Label Width — 6 or 8 lines per inch									
RCM-637-1.5-WT	100 (30.48)	Tedlar	White	1.500 (38.10)	100 (30.48 m)	3.600 (91.44)	7	14	23
RCM-637-1.5-YL	100 (30.48)	Tedlar	Yellow	1.500 (38.10)	100 (30.48 m)	3.600 (91.44)	7	14	23
2.000" Label Width — 6 or 8 lines per inch									
RCM-330-2.0-WT	100 (30.48)	Polyolefin	White	2.000 (50.80)	100 (30.48 m)	3.600 (91.44)	9	19	32
RCM-330-2.0-YL	100 (30.48)	Polyolefin	Yellow	2.000 (50.80)	100 (30.48 m)	3.600 (91.44)	9	19	32
RCM-637-2.0-WT	100 (30.48)	Tedlar	White	2.000 (50.80)	100 (30.48 m)	3.600 (91.44)	9	19	32
RCM-637-2.0-YL	100 (30.48)	Tedlar	Yellow	2.000 (50.80)	100 (30.48 m)	3.600 (91.44)	9	19	32

Tedlar® is a registered trademark of DuPont.

Note: Labels in chart are sorted in order by width, height, 3 digit material number (within part number), then die number (within part number).

► CONNECTOR PULL-TABS

Flat cable markers

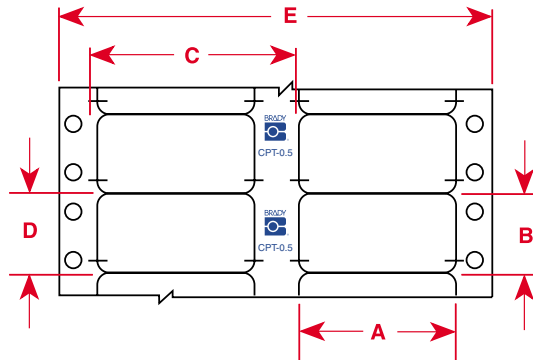

Part Number	Labels Per Roll	Material	Color	Labels Per Row	Label Width Inch (mm) A	Label Height Inch (mm) B	Horizontal Repeat Inch (mm) C	Vertical Repeat Inch (mm) D	Web Width Inch (mm) E
3.000" Label Width — 6 or 8 lines per inch									
CPT-0.5	500	B-505 Flame-Resistant Polyester	White	2	3.000 (76.20)	0.500 (12.70)	3.500 (88.90)	0.500 (12.70)	7.500 (190.50)
CPT-1.0	500	B-505 Flame-Resistant Polyester	White	2	3.000 (76.20)	1.000 (25.40)	3.500 (88.90)	1.000 (25.40)	7.500 (190.50)
CPT-1.5	500	B-505 Flame-Resistant Polyester	White	2	3.000 (76.20)	1.500 (38.10)	3.500 (88.90)	1.500 (38.10)	7.500 (190.50)
CPT-2.0	500	B-505 Flame-Resistant Polyester	White	2	3.000 (76.20)	2.000 (50.80)	3.500 (88.90)	2.000 (50.80)	7.500 (190.50)
CPT-2.5	500	B-505 Flame-Resistant Polyester	White	2	3.000 (76.20)	2.500 (63.50)	3.500 (88.90)	2.500 (63.50)	7.500 (190.50)
CPT-3.25	500	B-505 Flame-Resistant Polyester	White	2	3.000 (76.20)	3.250 (82.55)	3.500 (88.90)	3.250 (82.55)	7.500 (190.50)

Note: Labels in chart are sorted in order by width, height, 3 digit material number (within part number), then die number (within part number).

► CLOTH TAGS

Cable and wire harness markers

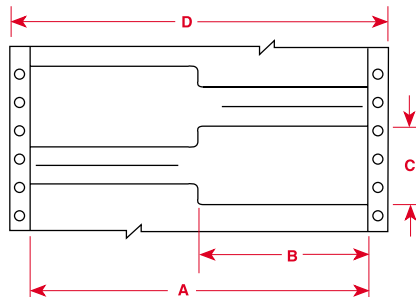

Part Number	Pieces Per Package	Material	Color	Labels Per Row	Label Width Inch (mm) A	Width of Write-On Area Inch (mm) B	Label Height Inch (mm) C	Web Width Inch (mm) D
4.500" Label Width (2.250" tab area) — 6 or 8 lines per inch								
CT-1	1,800	B-503 (Self-Extinguishing Cloth)	White	2	4.500 (114.30)	2.250 (57.15)	1.000 (25.40)	5.500 (139.70)

Note: Labels in chart are sorted in order by width, height, 3 digit material number (within part number), then die number (within part number).

BradyTag® Labels Index by Size

► COMPUTER-PRINTABLE TAGS (NON-ADHESIVE)

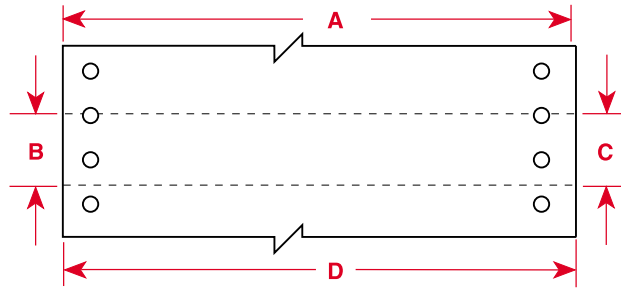

Part Number	Pieces Per Package	Material	Color	Labels Per Row	Label Width Inch (mm) A	Label Height Inch (mm) B	Vertical Repeat Inch (mm) C	Web Width Inch (mm) D
3.000" Label Width — 6 or 8 lines per inch								
BT-0530	500	B-841 Matte Polyester	White	1	3.000 (76.20)	0.500 (12.70)	0.500 (12.70)	3.000 (76.20)
BT-1030	500	B-841 Matte Polyester	White	1	3.000 (76.20)	1.000 (25.40)	1.000 (25.40)	3.000 (76.20)
BT-109-WT-3060-1	100	B-109 Polyethylene - 1 Across	White	1	3.000 (76.20)	6.000 (152.40)	6.000 (152.40)	4.000 (101.60)
BT-109-WT-3060-2	100	B-109 Polyethylene - 2 Across	White	2	3.000 (76.20)	6.000 (152.40)	6.000 (152.40)	4.000 (101.60)
BT-1530	500	B-841 Matte Polyester	White	1	3.000 (76.20)	1.500 (38.10)	1.500 (38.10)	3.000 (76.20)
BT-2030	500	B-841 Matte Polyester	White	1	3.000 (76.20)	2.000 (50.80)	2.000 (50.80)	3.000 (76.20)
3.500" Label Width — 6 or 8 lines per inch								
BT-2535	500	B-841 Matte Polyester	White	1	3.500 (88.90)	2.500 (63.50)	2.500 (63.50)	3.500 (88.90)
3.750" Label Width — 6 or 8 lines per inch								
BT-109-WT-2037	100	B-109 Polyethylene	White	1	3.750 (95.25)	2.000 (50.80)	2.000 (50.80)	4.750 (120.65)
4.750" Label Width — 6 or 8 lines per inch								
BT-109-WT-2547	100	B-109 Polyethylene	White	1	4.750 (120.65)	2.500 (63.50)	2.500 (63.50)	5.750 (146.05)

Note: Labels in chart are sorted in order by width, height, 3 digit material number (within part number), then die number (within part number).

► NOMEX® CABLE AND HARNESS MARKING (NON-ADHESIVE)

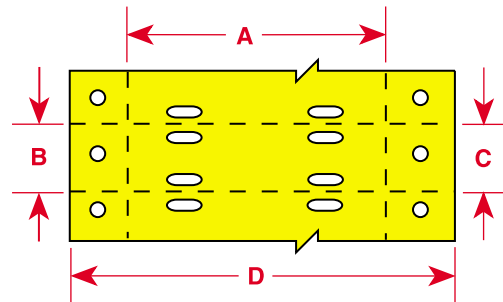

Part Number	Pieces Per Package	Material	Color	Labels Per Row	Holes Per Tag	Label Width Inch (mm) A	Label Height Inch (mm) B	Vertical Repeat Inch (mm) C	Web Width Inch (mm) D
2.000" Label Width — 6 or 8 lines per inch									
BT-508-WT-2050	2,500	B-508 Nomex®	White	1	4	2.000 (50.80)	0.500 (12.70)	0.500 (12.70)	3.000 (76.2)
BT-508-YL-2050	2,500	B-508 Nomex	Yellow	1	4	2.000 (50.80)	0.500 (12.70)	0.500 (12.70)	3.000 (76.2)
BT-508-WT-2075	2,500	B-508 Nomex	White	1	6	2.000 (50.80)	0.750 (19.05)	0.750 (19.05)	3.000 (76.2)
BT-508-YL-2075	2,500	B-508 Nomex	Yellow	1	6	2.000 (50.80)	0.750 (19.05)	0.750 (19.05)	3.000 (76.2)

Nomex® is a registered trademark of DuPont.

Note: Labels in chart are sorted in order by width, height, 3 digit material number (within part number), then die number (within part number).

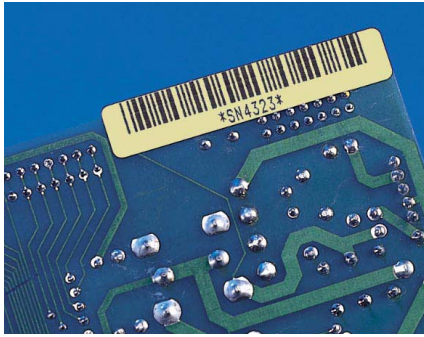

B-652 polyimide withstands extremely high temperatures. Ideal for marking the underside of printed circuit boards and for surface-mount applications. Remains legible after contact with solder, flux and cleaning solvents.

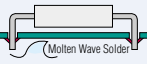
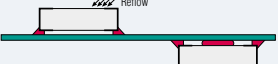

DOT MATRIX CIRCUIT BOARD PROCESS CHART

	 Molten Wave Solder		 Reflow		
	Through Hole Technology Top	Through Hole Technology Bottom	Surface Mount Technnology (SMT) Top or Bottom	Surface Mount Technnology (SMT) Top or Bottom	After Process
B-652, B-658	● Yes	● Yes	● Yes	● Yes	● Yes
B-164	● Yes	✘ No	● Yes	● Yes	● Yes
B-110, B-499, B-502, B-607, B-619, B-637, B-673, B-693, B-969	▲ Yes*	✘ No	✘ No	✘ No	● Yes

* In extreme high temperatures, testing of these materials is recommended.

► POLYIMIDES

High-Temperature Amber Polyimides (B-652)
Removable Amber Polyimide Film (B-658)

Part Number	Size Inch (mm)	Specifications on Page	 Through Hole Technology Top / Bottom	 SMT Top / Bottom	After Process
DAT-50-652	0.900 x 0.250 (22.86 x 6.35)	160	●	●	●
DAT-58-652	0.650 x 0.200 (16.51 x 5.08)	159	●	●	●
DAT-59-652	1.000 x 0.500 (25.40 x 12.70)	160	●	●	●
DAT-91-652	0.650 x 0.200 (16.51 x 5.08)	165	●	●	●
DAT-93-652	0.750 x 0.250 (19.05 x 6.35)	165	●	●	●
DAT-94-652	0.900 x 0.250 (22.86 x 6.35)	165	●	●	●
DAT-96-652	0.750 x 0.250 (19.05 x 6.35)	159	●	●	●
DAT-101-652	0.800 x 0.200 (20.32 x 5.08)	163	●	●	●
DAT-103-652	0.800 x 0.500 (20.32 x 12.70)	163	●	●	●
DAT-106-652	0.300 x 0.300 (7.62 x 7.62)	163	●	●	●
DAT-107-658	0.300 x 0.300 (7.62 x 7.62)	163	●	●	●
DAT-109-658	0.650 x 0.200 (16.51 x 5.08)	159	●	●	●
DAT-110-658	0.750 x 0.250 (19.05 x 6.35)	159	●	●	●
DAT-115-652	0.375 x 0.375 (9.53 x 9.53)	158	●	●	●
DAT-116-658	0.375 x 0.375 (9.53 x 9.53)	158	●	●	●
DAT-128-652	0.750 x 0.250 (19.05 x 6.35)	160	●	●	●
DAT-129-658	0.750 x 0.250 (19.05 x 6.35)	160	●	●	●
DAT-133-652	0.900 x 0.250 (22.86 x 6.35)	160	●	●	●
DAT-179-652	0.400 x 0.200 (10.16 x 5.08)	159	●	●	●

● Yes, this material will work with this application.

✘ No, this material does not work with this application.

▲ In extreme high temperatures, testing of these materials is recommended.

Circuit Board and Component Identification



Brady's materials are specially designed for printed circuit boards, EPROMs, SMDs and other integrated circuits.

► POLYESTER

Modified Polyester (B-164)
Permanent White Polyester (B-619)



Part Number	Size Inch (mm)	Specifications on Page	Through Hole Technology Top	Through Hole Technology Bottom	SMT Top / Bottom	After Process
DAT-17-619	0.650 x 0.200 (16.51 x 5.08)	159	▲	✘	✘	●
DAT-20-619	1.000 x 0.500 (25.40 x 12.70)	160	▲	✘	✘	●
DAT-27-619	0.750 x 0.250 (19.05 x 6.35)	159	▲	✘	✘	●
DAT-45-619	0.500 x 0.437 (12.70 x 11.10)	159	▲	✘	✘	●
DAT-51-619	1.000 x 0.375 (25.40 x 9.53)	161	▲	✘	✘	●
DAT-60-619	0.900 x 0.250 (22.86 x 6.35)	160	▲	✘	✘	●
DAT-90-619	0.650 x 0.200 (16.51 x 5.08)	165	▲	✘	✘	●
DAT-92-619	0.750 x 0.250 (19.05 x 6.35)	165	▲	✘	✘	●
DAT-95-619	0.900 x 0.250 (22.86 x 6.35)	165	▲	✘	✘	●
DAT-102-619	0.800 x 0.200 (20.32 x 5.08)	163	▲	✘	✘	●
DAT-104-619	0.800 x 0.500 (20.32 x 12.70)	163	▲	✘	✘	●
DAT-108-619	0.300 x 0.300 (7.62 x 7.62)	163	▲	✘	✘	●
DAT-111-164	0.650 x 0.200 (16.51 x 5.08)	159	●	✘	●	●
DAT-112-164	0.750 x 0.250 (19.05 x 6.35)	159	●	✘	●	●
DAT-113-164	0.375 x 0.375 (9.53 x 9.53)	159	●	✘	●	●
DAT-118-619	0.375 x 0.375 (9.53 x 9.53)	158	▲	✘	✘	●
DAT-120-164	0.900 x 0.250 (22.86 x 6.35)	160	●	✘	●	●
DAT-126-619	0.750 x 0.250 (19.05 x 6.35)	160	▲	✘	✘	●
DAT-130-164	0.750 x 0.250 (19.05 x 6.35)	160	●	✘	●	●
DAT-134-619	0.900 x 0.250 (22.86 x 6.35)	160	▲	✘	✘	●
DAT-135-164	0.900 x 0.250 (22.86 x 6.35)	160	●	✘	●	●
DAT-179-619	0.400 x 0.200 (10.16 x 5.08)	159	▲	✘	✘	●
DAT-181-619	1.000 x 0.250 (25.40 x 6.35)	160	▲	✘	✘	●

► METALLIZED POLYESTER

Removable Polyester (B-673)
Low Cost Metallized Polyester (B-693)
Metallized Polyester (B-969)



Part Number	Size Inch (mm)	Specifications on Page	Through Hole Technology Top	Through Hole Technology Bottom	SMT Top / Bottom	After Process
DAT-46-693	0.500 x 0.437 (12.70 x 11.10)	159	▲	✘	✘	●
DAT-46-969	0.500 x 0.437 (12.70 x 11.10)	159	▲	✘	✘	●
DAT-47-693	1.000 x 0.500 (25.40 x 12.70)	160	▲	✘	✘	●
DAT-47-969	1.000 x 0.500 (25.40 x 12.70)	160	▲	✘	✘	●
DAT-88-693	0.650 x 0.200 (16.51 x 5.08)	159	▲	✘	✘	●
DAT-88-969	0.650 x 0.200 (16.51 x 5.08)	159	▲	✘	✘	●
DAT-89-969	0.750 x 0.250 (19.05 x 6.35)	159	▲	✘	✘	●
DAT-97-673	1.000 x 0.500 (25.40 x 12.70)	160	▲	✘	✘	●
DAT-98-673	0.500 x 0.437 (12.70 x 11.10)	159	▲	✘	✘	●
DAT-114-673	0.375 x 0.375 (9.53 x 9.53)	158	▲	✘	✘	●
DAT-127-969	0.750 x 0.250 (19.05 x 6.35)	160	▲	✘	✘	●
DAT-170-969	1.600 x 0.375 (40.64 x 9.53)	161	▲	✘	✘	●

- Yes, this material will work with this application.
- ✘ No, this material does not work with this application.
- ▲ In extreme high temperatures, testing of these materials is recommended.

MISCELLANEOUS MATERIALS

- Removable White Paper (B-110)
- Static Dissipative Paper (B-129)
- Permanent White Nylon Cloth (B-499)
- Removable White Vinyl Cloth (B-502)
- Tamper-Resistant White Vinyl (B-607)
- Permanent Tedlar® (B-637)

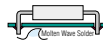

Part Number	Size Inch (mm)	Specifications on Page	Through Hole Technology Top	Technology Bottom	SMT Top / Bottom	After Process
DAT-1-637*	0.900 x 0.250 (22.86 x 6.35)	160	▲	✘	✘	●
DAT-2-637*	1.250 x 0.375 (31.75 x 9.53)	161	▲	✘	✘	●
DAT-10-637*	1.250 x 0.375 (31.75 x 9.53)	161	▲	✘	✘	●
DAT-11-499	1.000 x 0.375 (25.40 x 9.53)	161	▲	✘	✘	●
DAT-11-502	1.000 x 0.375 (25.40 x 9.53)	161	▲	✘	✘	●
DAT-12-502*	2.000 x 0.375 (50.80 x 9.53)	161	▲	✘	✘	●
DAT-13-502	3.000 x 0.375 (76.20 x 9.53)	162	▲	✘	✘	●
DAT-15-502	0.650 x 0.200 (16.51 x 5.08)	159	▲	✘	✘	●
DAT-16-607	0.650 x 0.200 (16.51 x 5.08)	159	▲	✘	✘	●
DAT-18-499	1.000 x 0.500 (25.40 x 12.70)	160	▲	✘	✘	●
DAT-18-502	1.000 x 0.500 (25.40 x 12.70)	160	▲	✘	✘	●
DAT-19-607	1.000 x 0.500 (25.40 x 12.70)	160	▲	✘	✘	●
DAT-23-637*	1.250 x 0.375 (31.75 x 9.53)	161	▲	✘	✘	●
DAT-25-502	0.750 x 0.250 (19.05 x 6.35)	159	▲	✘	✘	●
DAT-26-607	0.750 x 0.250 (19.05 x 6.35)	159	▲	✘	✘	●
DAT-43-502	0.500 x 0.437 (12.70 x 11.10)	159	▲	✘	✘	●
DAT-44-607	0.500 x 0.437 (12.70 x 11.10)	159	▲	✘	✘	●
DAT-49-637	0.900 x 0.250 (22.86 x 6.35)	160	▲	✘	✘	●
DAT-56-637	0.650 x 0.200 (16.51 x 5.08)	159	▲	✘	✘	●
DAT-57-637	1.000 x 0.500 (25.40 x 12.70)	160	▲	✘	✘	●
DAT-72-637	1.250 x 0.375 (31.75 x 9.53)	161	▲	✘	✘	●
DAT-73-637	1.250 x 0.375 (31.75 x 9.53)	161	▲	✘	✘	●
DAT-74-637	1.250 x 0.375 (31.75 x 9.53)	161	▲	✘	✘	●
DAT-99-637	1.000 x 0.500 (25.40 x 12.70)	160	▲	✘	✘	●
DAT-105-110	0.800 x 0.500 (20.32 x 12.70)	163	▲	✘	✘	●
DAT-117-607	0.375 x 0.375 (9.53 x 9.53)	158	▲	✘	✘	●
DAT-119-502	0.375 x 0.375 (9.53 x 9.53)	158	▲	✘	✘	●
DAT-124-502	0.750 x 0.250 (19.05 x 6.35)	160	▲	✘	✘	●
DAT-125-607	0.750 x 0.250 (19.05 x 6.35)	160	▲	✘	✘	●
DAT-132-637	0.900 x 0.250 (22.86 x 6.35)	160	▲	✘	✘	●
DAT-160-502	1.125 x 0.530 (28.58 x 13.46)	161	▲	✘	✘	●

Tedlar® is a registered trademark of DuPont.

*Size does not fit narrow carriage (80-column) printers. See p. 158 for identical narrow carriage labels.

- Yes, this material will work with this application.
- ✘ No, this material does not work with this application.
- ▲ In extreme high temperatures, testing of these materials is recommended.

Circuit Board and Component Identification

▶ STATIC AWARENESS LABELS

Removable Vinyl Cloth (B-502)
Permanent Polyester (B-619)
Static Awareness Labels

For use on electronic devices/components.

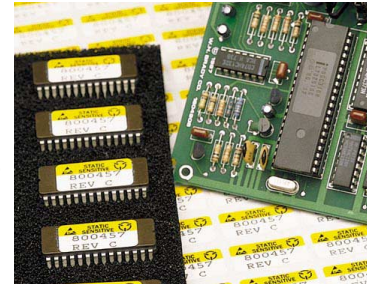

Part Number	Size Inch (mm)	Specifications on Page	Through Hole Technology Top	Through Hole Technology Bottom	SMT Top / Bottom	After Process
SLDAT-1-502	1.000 x 0.500 (25.40 x 12.70)	166	▲	✘	✘	●
SLDAT-1-619	1.000 x 0.500 (25.40 x 12.70)	166	▲	✘	✘	●

- Yes, this material will work with this application.
- ✘ No, this material does not work with this application.
- ▲ In extreme high temperatures, testing of these materials is recommended.

Brady perf-cut Datab® labels make marking large quantities of EPROMs, SMDs, logic arrays and other components easier than ever before. An entire row of labels can be removed as one strip. Components are quickly identified by positioning the end label on the component and tearing away the rest of the strip. Ideal for use while gang-programming. (Product shown: DAT-104-619)

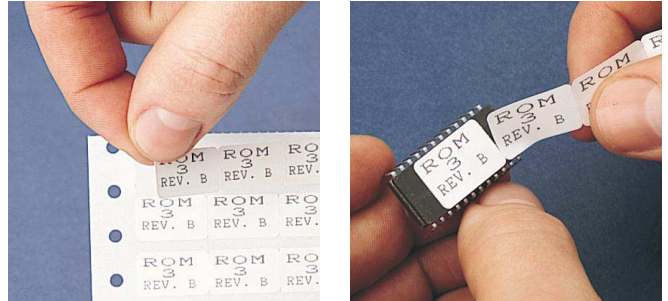

Self-Laminating Vinyl
Durable, highly conformable wire markers
with over-wrap legend protection. (B-292)

Part Number	Package Quantity	Label Size Inch (mm)	Specifications on Page
DAT-7-292	1,000/10,000	0.800 x 1.437 (20.00 x 36.50)	170
DAT-30-292*	1,000/10,000	0.500 x 0.750 (12.70 x 19.05)	170
DAT-33-292	1,000/10,000	0.500 x 1.437 (12.70 x 36.50)	172
DAT-34-292	1,000/10,000	1.000 x 1.437 (25.40 x 36.50)	172
DAT-35-292	1,000/10,000	2.000 x 1.437 (50.80 x 36.50)	173
DAT-37-292	1,000/10,000	1.000 x 2.250 (25.40 x 57.15)	172
DAT-37-292-BL**	2,500	1.000 x 2.250 (25.40 x 57.15)	172
DAT-37-292-BR**	2,500	1.000 x 2.250 (25.40 x 57.15)	172
DAT-37-292-GR**	2,500	1.000 x 2.250 (25.40 x 57.15)	172
DAT-37-292-GY**	2,500	1.000 x 2.250 (25.40 x 57.15)	172
DAT-37-292-OR**	2,500	1.000 x 2.250 (25.40 x 57.15)	172
DAT-37-292-PL**	2,500	1.000 x 2.250 (25.40 x 57.15)	172
DAT-37-292-RD**	2,500	1.000 x 2.250 (25.40 x 57.15)	172
DAT-37-292-YL**	2,500	1.000 x 2.250 (25.40 x 57.15)	172
DAT-38-292	1,000/2,500	2.000 x 2.250 (50.80 x 57.15)	173
DAT-38-292-BL**	2,500	2.000 x 2.250 (50.80 x 57.15)	173
DAT-38-292-BR**	2,500	2.000 x 2.250 (50.80 x 57.15)	173
DAT-38-292-GR**	2,500	2.000 x 2.250 (50.80 x 57.15)	173
DAT-38-292-GY**	2,500	2.000 x 2.250 (50.80 x 57.15)	173
DAT-38-292-OR**	2,500	2.000 x 2.250 (50.80 x 57.15)	173
DAT-38-292-PL**	2,500	2.000 x 2.250 (50.80 x 57.15)	173
DAT-38-292-RD**	2,500	2.000 x 2.250 (50.80 x 57.15)	173
DAT-38-292-YL**	2,500	2.000 x 2.250 (50.80 x 57.15)	173
DAT-39-292	1,000/2,500	1.000 x 3.750 (25.40 x 95.25)	173
DAT-39-292-BL**	2,500	1.000 x 3.750 (25.40 x 95.25)	173
DAT-39-292-BR**	2,500	1.000 x 3.750 (25.40 x 95.25)	173
DAT-39-292-GR**	2,500	1.000 x 3.750 (25.40 x 95.25)	173
DAT-39-292-GY**	2,500	1.000 x 3.750 (25.40 x 95.25)	173
DAT-39-292-OR**	2,500	1.000 x 3.750 (25.40 x 95.25)	173
DAT-39-292-PL**	2,500	1.000 x 3.750 (25.40 x 95.25)	173
DAT-39-292-RD**	2,500	1.000 x 3.750 (25.40 x 95.25)	173
DAT-39-292-YL**	2,500	1.000 x 3.750 (25.40 x 95.25)	173
DAT-63-292	1,000/2,500	1.900 x 3.187 (48.26 x 80.95)	170
DAT-66-292	1,000/10,000	0.500 x 0.750 (12.70 x 19.05)	170
DAT-85-292	1,000/10,000	1.000 x 0.750 (25.40 x 19.05)	172
DAT-85-292-BL**	2,500	1.000 x 0.750 (25.40 x 19.05)	172
DAT-85-292-BR**	2,500	1.000 x 0.750 (25.40 x 19.05)	172
DAT-85-292-GR**	2,500	1.000 x 0.750 (25.40 x 19.05)	172
DAT-85-292-GY**	2,500	1.000 x 0.750 (25.40 x 19.05)	172
DAT-85-292-OR**	2,500	1.000 x 0.750 (25.40 x 19.05)	172
DAT-85-292-PL**	2,500	1.000 x 0.750 (25.40 x 19.05)	172
DAT-85-292-RD**	2,500	1.000 x 0.750 (25.40 x 19.05)	172
DAT-85-292-YL**	2,500	1.000 x 0.750 (25.40 x 19.05)	172
DAT-139-292	1,000/10,000	0.300 x 0.750 (7.62 x 19.05)	172
DAT-142-292	1,000/10,000	0.300 x 0.937 (7.62 x 23.80)	172
DAT-145-292	1,000/10,000	0.500 x 0.937 (12.70 x 23.80)	172
DAT-148-292	1,000/10,000	0.800 x 0.937 (20.32 x 23.80)	172
DAT-151-292	1,000/10,000	1.000 x 0.937 (25.40 x 23.80)	172
SLSH-0515	1,664	0.500 x 1.437 (12.70 x 36.50)	172
SLSH-1015	832	1.000 x 1.437 (25.40 x 36.50)	172
SLSH-2015	416	2.000 x 1.437 (50.80 x 36.50)	173
SLSH-10225	608	1.000 x 2.250 (25.40 x 57.15)	172
SLSH-10375	408	1.000 x 3.750 (25.40 x 95.25)	173
SLSH-20225	304	2.000 x 2.250 (50.80 x 57.15)	173
SLSH-20375	204	2.000 x 3.750 (50.80 x 95.25)	173

*Size does not fit narrow carriage (80-column) printers. See p. 158 for identical narrow carriage labels.

**BL=blue, BR=brown, GR=green, GY=grey, OR=orange, PL=purple, RD=red, YL=yellow. Standard product lead time of 10 working days.

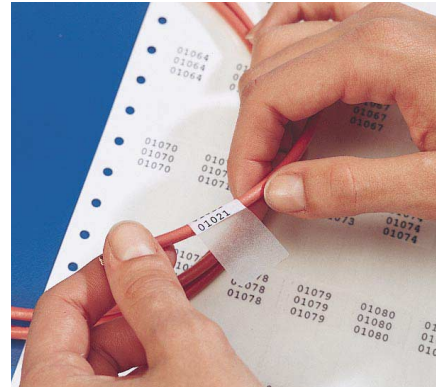

Self-laminating wire markers provide long-lasting protection for custom-printed identification.

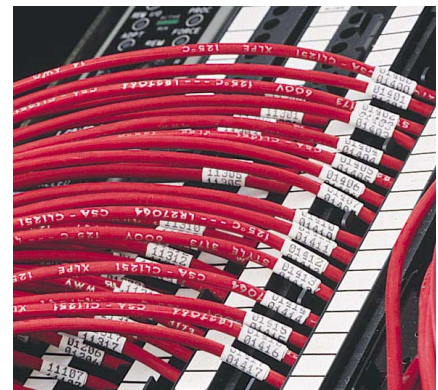

Ideal for wire identification, Datab® computer-printable markers accommodate multiple character legends. (Product shown: DAT-67-502)

Wire and Cable Marking

Self-Laminating Tedlar®

Self-Extinguishing markers offer excellent solvent resistance and high-temperature performance. (B-642)

Part Number	Package Quantity	Label Size - Inch (mm)	Specifications On Page
DAT-52-642	10,000	0.800 x 1.437 (20.32 x 36.50)	170
DAT-53-642	10,000	0.500 x 1.437 (12.70 x 36.50)	172
DAT-54-642	10,000	1.000 x 1.437 (25.40 x 36.50)	172
DAT-55-642*	10,000	0.500 x 0.750 (12.70 x 19.05)	170
DAT-71-642	10,000	0.500 x 0.750 (12.70 x 19.05)	170

*Size does not fit narrow carriage (80-column) printers. See page 158 for identical narrow carriage labels.

General-Purpose White Vinyl Cloth Repositionable adhesive. (B-502)

Part Number	Package Quantity	Label Size - Inch (mm)	Specifications On Page
DAT-5-502	10,000	0.800 x 1.437 (20.32 x 36.50)	160
DAT-24-502	10,000	0.500 x 1.437 (12.70 x 36.50)	159
DAT-31-502*	10,000	0.500 x 0.750 (12.70 x 19.05)	159
DAT-67-502	10,000	0.500 x 0.750 (12.70 x 19.05)	159
DAT-83-502	10,000	1.000 x 0.750 (25.40 x 19.05)	161
DAT-137-502	10,000	0.300 x 0.750 (7.62 x 19.05)	158
DAT-140-502	10,000	0.300 x 0.937 (7.62 x 23.80)	158
DAT-143-502	10,000	0.500 x 0.937 (12.70 x 23.80)	159
DAT-146-502	10,000	0.800 x 0.937 (20.32 x 23.80)	160
DAT-149-502	10,000	1.000 x 0.937 (25.40 x 23.80)	161

*Size does not fit narrow carriage (80-column) printers. See page 158 for identical narrow carriage labels.

General-Purpose Nylon Cloth Permanent adhesive. (B-499)

Part Number	Package Quantity	Label Size - Inch (mm)	Specifications On Page
DAT-5-499	10,000	0.800 x 1.437 (20.32 x 36.50)	160
DAT-67-499	10,000	0.500 x 0.750 (12.70 x 19.05)	159

Self-Extinguishing White Tedlar®

Thin, conformable markers resist solvents and provide high-temperature performance, even on small-gauge wires. (B-632)

Part Number	Package Quantity	Label Size - Inch (mm)	Specifications On Page
DAT-6-632	10,000	0.800 x 1.437 (20.32 x 36.50)	160
DAT-32-632*	10,000	0.500 x 0.750 (12.70 x 19.05)	159
DAT-68-632	10,000	0.500 x 0.750 (12.70 x 19.05)	159
DAT-84-632	10,000	1.000 x 0.750 (25.40 x 19.05)	161
DAT-87-632	10,000	1.000 x 1.437 (25.40 x 36.50)	165
DAT-138-632	10,000	0.300 x 0.750 (7.62 x 19.05)	158
DAT-141-632	10,000	0.300 x 0.937 (7.62 x 23.80)	158
DAT-144-632	10,000	0.500 x 0.937 (12.70 x 23.80)	159
DAT-147-632	10,000	0.800 x 0.937 (20.32 x 23.80)	160
DAT-150-632	10,000	1.000 x 0.937 (25.40 x 23.80)	161

Tedlar® is a registered trademark of DuPont.

*Size does not fit narrow carriage (80-column) printers. See page 158 for identical narrow carriage labels.

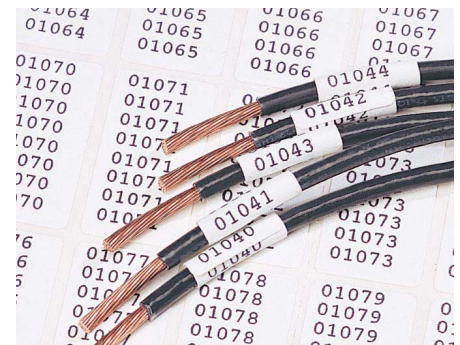

Brady's B-502 Vinyl Cloth labels can be repositioned prior to wire termination due to a specially formulated rubber-based adhesive. (Product shown: DAT-5-502)

White Paper Markers

Removable wire flag markers. (B-121)

Part Number	Package Quantity	Label Size - Inch (mm)	Specifications On Page
DAT-28-121	10,000	1.500 x 0.250 (38.10 x 6.35)	164

White Vinyl Cloth

Removable wire flag markers. (B-502)

Part Number	Package Quantity	Label Size - Inch (mm)	Specifications On Page
DAT-25-502	10,000	0.750 x 0.250 (19.05 x 6.35)	159
DAT-29-502	10,000	1.500 x 0.250 (38.10 x 6.35)	164
DAT-124-502	10,000	0.750 x 0.250 (19.05 x 6.35)	160

Self-Extinguishing White Tedlar®
Wire flag markers. (B-632)

Part Number	Package Quantity	Label Size - Inch (mm)	Specifications On Page
DAT-87-632	10,000	1.000 x 1.437 (25.40 x 36.50)	165

Tedlar® is a registered trademark of DuPont.

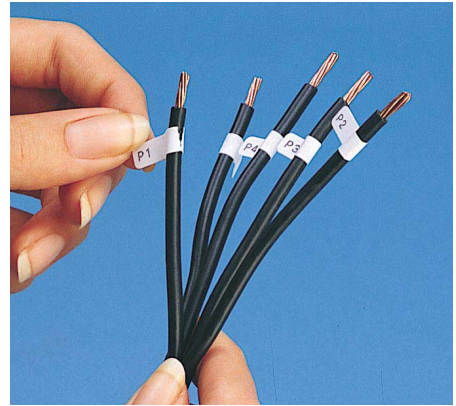

A wide variety of materials permits markers to be used for temporary identification in wire harness assembly. (Product shown: DAT-28-121)

► **FOR IDENTIFICATION OF WIRE BUNDLES,
LARGE CONDUITS AND INSTALLED CABLES**

Self-Extinguishing White or Yellow Tedlar®
Adhesive Wrap-Around Cable Markers. (B-637)

Part Number	Label Width Inch (mm) Continuous	Roll Length Ft. (m)	Specifications On Page
RCM-637-1.0-WT	1.000 (25.40)	100 (30.48)	174
RCM-637-1.0-YL	1.000 (25.40)	100 (30.48)	174
RCM-637-1.5-WT	1.500 (38.10)	100 (30.48)	174
RCM-637-1.5-YL	1.500 (38.10)	100 (30.48)	174
RCM-637-2.0-WT	2.000 (50.80)	100 (30.48)	174
RCM-637-2.0-YL	2.000 (50.80)	100 (30.48)	174

Tedlar® is a registered trademark of DuPont.

Heat-Sealable White or Yellow Polyolefin
Wrap-around cable markers. (B-330)

Part Number	Label Width Inch (mm) Continuous	Roll Length Ft. (m)	Specifications On Page
RCM-330-2.0-WT	2.00 (50.80)	100 (30.48)	174
RCM-330-2.0-YL	2.00 (50.80)	100 (30.48)	174



Made from heat-shrinkable B-330 polyolefin, these durable markers bond to your cable to provide the ultimate in permanent identification.

Wire and Cable Marking

► BRADYTAG® COMPUTER-PRINTABLE TAGS

White or Yellow Nomex® (B-508)

Part Number	Pieces Per Roll	Dimensions Inch (mm)	Specifications On Page	Color
BT-508-WT-2050	2,500	2.000 x 0.500 (50.80 x 12.70)	157	White
BT-508-YL-2050	2,500	2.000 x 0.500 (50.80 x 12.70)	157	Yellow
BT-508-WT-2075	2,500	2.000 x 0.750 (50.80 x 19.05)	157	White
BT-508-YL-2075	2,500	2.000 x 0.750 (50.80 x 19.05)	157	Yellow

Nomex® is a registered trademark of DuPont.

White Cloth Tag (B-503)

Part Number	Pieces Per Roll	Dimensions Inch (mm)	Specifications On Page	Color
CT-1	1,800	4.500 x 1.000 (114.30 x 25.40)	175	White

White Polyethylene Tag (B-109)

Part Number	Pieces Per Roll	Dimensions Inch (mm)	Specifications On Page	Color
BT-109-WT-2037	1 Across, 100 tags	3.750 x 2.000 (95.25 x 50.80)	176	White
BT-109-WT-2547	1 Across, 100 tags	4.750 x 2.500 (120.65 x 63.50)	176	White
BT-109-WT-3060-1	1 Across, 100 tags	3.000 x 6.000 (76.20 x 152.40)	176	White
BT-109-WT-3060-2	2 Across, 100 tags	3.000 x 6.000 (76.20 x 152.40)	176	White

Matte White Polyester (B-841) General-Purpose Tags

Part Number	Pieces Per Package	Dimensions Inch (mm)	Specifications On Page
BT-0530	500	3.000 x 0.500 (76.20 x 12.70)	176
BT-1030	500	3.000 x 1.000 (76.20 x 25.40)	176
BT-1530	500	3.000 x 1.500 (76.20 x 38.10)	176
BT-2030	500	3.000 x 2.000 (76.20 x 50.80)	176
BT-2535	500	3.500 x 2.500 (88.90 x 63.50)	176

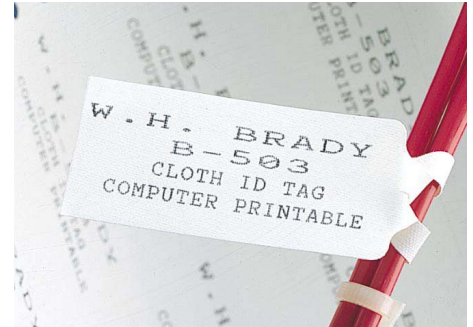

Tags are ideal for identifying wire bundles in harsh environments. (Product shown: CT-1)

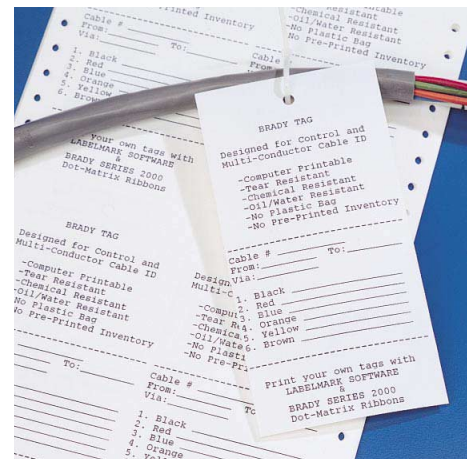

Tear-resistant B-109 has a printable topcoat which accepts computer-printed, hand-written and typewritten legends. (Product shown: BT-109-WT-3060-2)

► SELF-LAMINATING FLAT RIBBON CABLE MARKERS

Self-Laminating Vinyl
Flexible over-wrap for legend protection. (B-292)



Self-laminating flat ribbon markers provide over-wrap protection and permanent identification. (Product shown: DAT-40-292)

Part Number	Package Quantity	Label Size Inch (mm)	Specifications On Page	Maximum Conductor Size
DAT-8-292*	1,000/2,500	1.900 x 3.187 (48.26 x 80.95)	170	20
DAT-9-292*	1,000/2,500	2.000 x 5.937 (50.80 x 150.80)	171	40
DAT-14-292*	1,000/2,500	2.000 x 7.437 (50.80 x 188.90)	171	50
DAT-39-292	1,000/2,500	1.000 x 3.750 (25.40 x 95.25)	173	26
DAT-39-292-BL**	2,500	1.000 x 3.750 (25.40 x 95.25)	173	26
DAT-39-292-BR**	2,500	1.000 x 3.750 (25.40 x 95.25)	173	26
DAT-39-292-GR**	2,500	1.000 x 3.750 (25.40 x 95.25)	173	26
DAT-39-292-GY**	2,500	1.000 x 3.750 (25.40 x 95.25)	173	26
DAT-39-292-OR**	2,500	1.000 x 3.750 (25.40 x 95.25)	173	26
DAT-39-292-PL**	2,500	1.000 x 3.750 (25.40 x 95.25)	173	26
DAT-39-292-RD**	2,500	1.000 x 3.750 (25.40 x 95.25)	173	26
DAT-39-292-YL**	2,500	1.000 x 3.750 (25.40 x 95.25)	173	26
DAT-40-292	1,000/2,500	2.000 x 3.750 (50.80 x 95.25)	173	26
DAT-40-292-BL**	2,500	2.000 x 3.750 (50.80 x 95.25)	173	26
DAT-40-292-BR**	2,500	2.000 x 3.750 (50.80 x 95.25)	173	26
DAT-40-292-GR**	2,500	2.000 x 3.750 (50.80 x 95.25)	173	26
DAT-40-292-GY**	2,500	2.000 x 3.750 (50.80 x 95.25)	173	26
DAT-40-292-OR**	2,500	2.000 x 3.750 (50.80 x 95.25)	173	26
DAT-40-292-PL**	2,500	2.000 x 3.750 (50.80 x 95.25)	173	26
DAT-40-292-RD**	2,500	2.000 x 3.750 (50.80 x 95.25)	173	26
DAT-40-292-YL**	2,500	2.000 x 3.750 (50.80 x 95.25)	173	26
DAT-41-292*	1,000/2,500	1.000 x 5.937 (25.40 x 150.80)	170	40
DAT-42-292*	1,000/2,500	1.000 x 7.437 (25.40 x 188.90)	170	50
DAT-63-292	1,000/2,500	1.900 x 3.187 (48.26 x 80.95)	170	20
DAT-65-292	1,000/2,500	2.000 x 7.437 (50.80 x 188.90)	171	50
DAT-69-292	1,000/2,500	1.000 x 5.937 (25.40 x 150.80)	170	40
DAT-69-292-BL**	1,000/2,500	1.000 x 5.937 (25.40 x 150.80)	170	40
DAT-69-292-BR**	1,000/2,500	1.000 x 5.937 (25.40 x 150.80)	170	40
DAT-69-292-GR**	1,000/2,500	1.000 x 5.937 (25.40 x 150.80)	170	40
DAT-69-292-GY**	1,000/2,500	1.000 x 5.937 (25.40 x 150.80)	170	40
DAT-69-292-OR**	1,000/2,500	1.000 x 5.937 (25.40 x 150.80)	170	40
DAT-69-292-PL**	1,000/2,500	1.000 x 5.937 (25.40 x 150.80)	170	40
DAT-69-292-RD**	1,000/2,500	1.000 x 5.937 (25.40 x 150.80)	170	40
DAT-69-292-YL**	1,000/2,500	1.000 x 5.937 (25.40 x 150.80)	170	40
DAT-70-292	1,000/2,500	1.000 x 7.437 (25.40 x 188.90)	170	50
DAT-75-292	1,000/2,500	2.000 x 5.937 (50.80 x 150.80)	171	40
DAT-75-292-BL**	1,000/2,500	2.000 x 5.937 (50.80 x 150.80)	171	40
DAT-75-292-BR**	1,000/2,500	2.000 x 5.937 (50.80 x 150.80)	171	40
DAT-75-292-GR**	1,000/2,500	2.000 x 5.937 (50.80 x 150.80)	171	40
DAT-75-292-GY**	1,000/2,500	2.000 x 5.937 (50.80 x 150.80)	171	40
DAT-75-292-OR**	1,000/2,500	2.000 x 5.937 (50.80 x 150.80)	171	40
DAT-75-292-PL**	1,000/2,500	2.000 x 5.937 (50.80 x 150.80)	171	40
DAT-75-292*-RD**	1,000/2,500	2.000 x 5.937 (50.80 x 150.80)	171	40
DAT-75-292-YL**	1,000/2,500	2.000 x 5.937 (50.80 x 150.80)	171	40
DAT-159-292	1,000/2,500	2.000 x 8.437 (50.80 x 214.30)	171	64
DAT-159-292-BL**	2,500	2.000 x 8.437 (50.80 x 214.30)	171	64
DAT-159-292-BR**	2,500	2.000 x 8.437 (50.80 x 214.30)	171	64
DAT-159-292-GR**	2,500	2.000 x 8.437 (50.80 x 214.30)	171	64
DAT-159-292-GY**	2,500	2.000 x 8.437 (50.80 x 214.30)	171	64
DAT-159-292-OR**	2,500	2.000 x 8.437 (50.80 x 214.30)	171	64
DAT-159-292-PL**	2,500	2.000 x 8.437 (50.80 x 214.30)	171	64
DAT-159-292-RD**	2,500	2.000 x 8.437 (50.80 x 214.30)	171	64
DAT-159-292-YL**	2,500	2.000 x 8.437 (50.80 x 214.30)	171	64
DAT-162-292	1,000/2,500	8.500 x 2.000 (215.90 x 50.80)	174	64

*Size does not fit narrow carriage (80-column) printers. See page 158 for identical narrow carriage labels.

**BL=blue, BR=brown, GR=green, GY=grey, OR=orange, PL=purple, RD=red, YL=yellow.
Standard product lead time of 10 working days.

Wire and Cable Marking

► BRADY CONNECTOR PULL-TABS

Flame-Resistant White Polyester
For connector strain relief assemblies. (B-505)

Part Number	Labels Per Roll	Width Inch (mm)	Height Inch (mm)	Specifications On Page
CPT-0.5	500	3.000 (76.20)	0.500 (12.70)	175
CPT-1.0	500	3.000 (76.20)	1.000 (25.40)	175
CPT-1.5	500	3.000 (76.20)	1.500 (38.10)	175
CPT-2.0	500	3.000 (76.20)	2.000 (50.80)	175
CPT-2.5	500	3.000 (76.20)	2.500 (63.50)	175
CPT-3.25	500	3.000 (76.20)	3.250 (82.55)	175

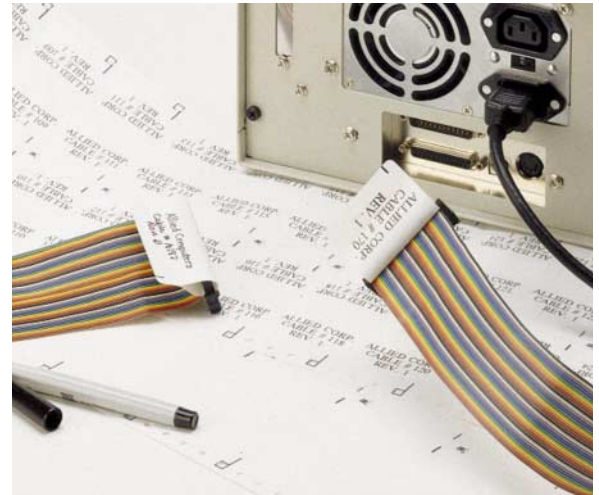

Provides easy access to connectors and is a practical option in cable assembly identification.

White Vinyl Cloth Markers

Available in cut-to-length, perforated, or pre-cut strips to fit vertically mounted terminal blocks. (B-502)

Part Number	Package Quantity	Label Size Inch (mm)	Roll Length Ft (m)	Specifications On Page
DAT-100-502	1	0.375 (9.53)	165 (50.30)	168
DAT-157-502	1	0.312 (7.92) - 1 across	165 (50.30)	168
DAT-158-502	1	0.375 (9.53) - 1 across	165 (50.30)	168

White Polyester

Vertical strips for 66 communication blocks. (B-619)

Part Number	Roll Length	Label Size Inch (mm)	Specifications On Page
DAT-168-619	2,000'	0.375 x 0.200 (9.53 x 5.08)	168

Clear Computer-Printable Polyester

Horizontal strips for 110 communication blocks. (B-621)

Part Number	Package Quantity	Label Size Inch (mm)	Specifications On Page
DAT-169-621	2,500	7.500 x 0.500 (190.50 x 12.70)	169

Non-Adhesive Paper

Horizontal strips for communication blocks. (B-124)

Part Number	Package Quantity	Color	Label Size Inch (mm)	Specifications On Page
DAT-177-124-BL	150	Blue	7.900 x 0.475 (200.66 x 12.07)	169
DAT-177-124-BR	150	Brown	7.900 x 0.475 (200.66 x 12.07)	169
DAT-177-124-GR	150	Green	7.900 x 0.475 (200.66 x 12.07)	169
DAT-177-124-GY	150	Gray	7.900 x 0.475 (200.66 x 12.07)	169
DAT-177-124-OR	150	Orange	7.900 x 0.475 (200.66 x 12.07)	169
DAT-177-124-PL	150	Purple	7.900 x 0.475 (200.66 x 12.07)	169
DAT-177-124-RD	150	Red	7.900 x 0.475 (200.66 x 12.07)	169
DAT-177-124-WT	150	White	7.900 x 0.475 (200.66 x 12.07)	169
DAT-177-124-YL	150	Yellow	7.900 x 0.475 (200.66 x 12.07)	169

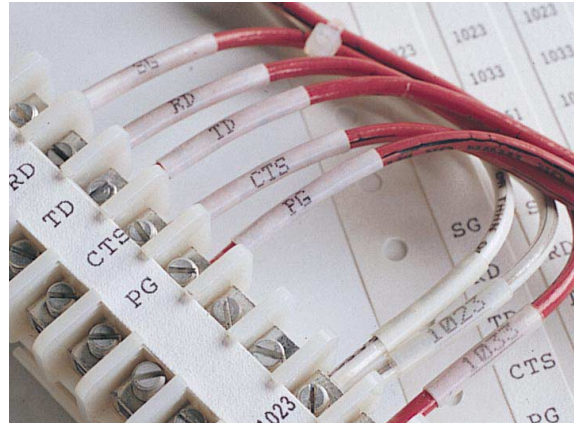

Continuous-strip terminal block markers are available perforated on 1/4", 3/8" and 1/2" centers to fit many sizes of Buchanan, Allen-Bradley and similar terminal blocks. Markers are also available in continuous strips. (Product shown: DAT-152-502)

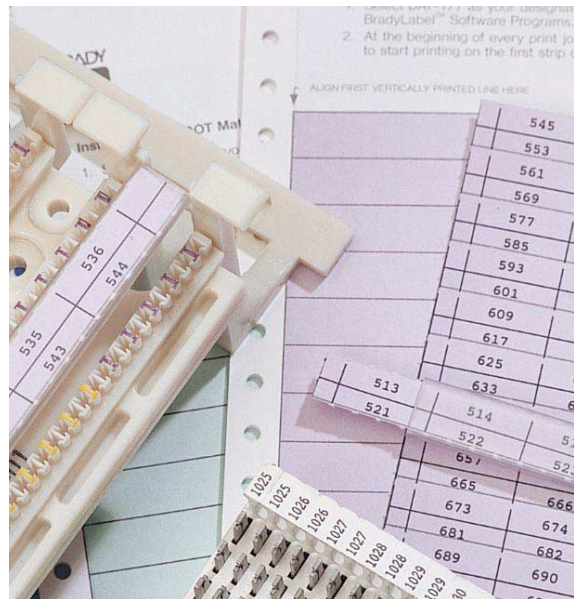

For telecommunications termination hardware, labels are available for both 66 and 110 terminal block identification.

General and Industrial Identification

► RATING PLATES AND ASSET IDENTIFICATION

White Paper (B-609)

White Polyester (B-619)

Low Cost Metallized Polyester (B-693)

Metallized Polyester (B-969)

Part Number	Package Quantity	Label Size Inch (mm)	Specifications on Page
BCDAT-1-609	5,000	2.000 x 0.900 (50.80 x 22.86)	161
BCDAT-1-619	5,000	2.000 x 0.900 (50.80 x 22.86)	161
BCDAT-2-609	5,000	3.000 x 0.900 (76.20 x 22.86)	162
BCDAT-2-619	5,000	3.000 x 0.900 (76.20 x 22.86)	162
BCDAT-3-609	5,000	2.000 x 1.437 (50.80 x 36.50)	161
BCDAT-3-619	5,000	2.000 x 1.437 (50.80 x 36.50)	161
BCDAT-4-609	5,000	3.000 x 1.437 (76.20 x 36.50)	162
BCDAT-4-619	5,000	3.000 x 1.437 (76.20 x 36.50)	162
BCDAT-5-609	5,000	3.900 x 1.437 (99.06 x 36.50)	162
BCDAT-5-619	5,000	3.900 x 1.437 (99.06 x 36.50)	162
BCDAT-6-609	5,000	3.000 x 1.900 (76.20 x 48.26)	162
BCDAT-6-619	5,000	3.000 x 1.900 (76.20 x 48.26)	162
BCDAT-12-619	10,000	1.500 x 0.750 (38.10 x 19.05)	164
DAT-20-619	10,000	1.000 x 0.500 (25.40 x 12.70)	160
DAT-47-693	10,000	1.000 x 0.500 (25.40 x 12.70)	160
DAT-47-969	10,000	1.000 x 0.500 (25.40 x 12.70)	160
DAT-48-693	10,000	1.500 x 0.750 (38.10 x 19.05)	164
DAT-48-969	10,000	1.500 x 0.750 (38.10 x 19.05)	164
DAT-77-969	5,000	2.000 x 0.900 (50.80 x 22.86)	161
DAT-78-969	5,000	3.000 x 0.900 (76.20 x 22.86)	162
DAT-79-969	5,000	2.000 x 1.437 (50.80 x 36.50)	161
DAT-80-969	5,000	3.000 x 1.437 (76.20 x 36.50)	162
DAT-81-969	5,000	3.900 x 1.437 (99.06 x 36.50)	162
DAT-82-969	5,000	3.000 x 1.900 (76.20 x 48.26)	162
DAT-88-693	10,000	0.650 x 0.200 (16.51 x 5.08)	159
DAT-88-969	10,000	0.650 x 0.200 (16.51 x 5.08)	159



Work-in-process is clearly identified with computer-printable Datab® labels.

Translucent Computer-Printable Polyester (B-621)

Metallized Polyester Panel Markers (B-969)

Part Number	Package Quantity	Label Size Inch (mm)	Specifications On Page	Comments
DAT-163-621-10	10,000	1.000 x 0.500 (25.40 x 12.70)	160	Clear polyester
DAT-164-969-10	10,000	1.000 x 0.500 (25.40 x 12.70)	166	Silver color with 0.062" black border

► **PERMASHIELD™* LABELS**

For harsh environments requiring a protective overlamine.

**White Paper (B-609) with Clear Polyester (B-966)
Overlamine rating plate labels.**

Part Number	Labels Per Package	Label Size Inch (mm)	Overlamine Size Inch (mm)	Specifications On Page
PSL-1-609	5,000	1.000 x 0.500 (25.40 x 12.70)	1.250 x 0.750 (31.75 x 19.05)	167
PSL-2-609	5,000	1.500 x 0.750 (38.10 x 19.05)	1.750 x 1.000 (44.45 x 25.40)	167

**White Polyester (B-619) with Clear Polyester (B-966)
Overlamine rating plate labels.**

Part Number	Labels Per Package	Label Size Inch (mm)	Overlamine Size Inch (mm)	Specifications On Page
PSL-1-619	5,000	1.000 x 0.500 (25.40 x 12.70)	1.250 x 0.750 (31.75 x 19.05)	167
PSL-2-619	5,000	1.500 x 0.750 (38.10 x 19.05)	1.750 x 1.000 (44.45 x 25.40)	167
PSL-3-619	5,000	2.000 x 1.000 (50.80 x 25.40)	2.250 x 1.250 (57.15 x 31.75)	167

**Metallized Polyester (B-969) with Clear Polyester (B-966)
Overlamine rating plate labels.**

Part Number	Labels Per Package	Label Size Inch (mm)	Overlamine Size Inch (mm)	Specifications On Page
PSL-1-969	5,000	1.000 x 0.500 (25.40 x 12.70)	1.250 x 0.750 (31.75 x 19.05)	167
PSL-2-969	5,000	1.500 x 0.750 (38.10 x 19.05)	1.750 x 1.000 (44.45 x 25.40)	167
PSL-3-969	5,000	2.000 x 1.000 (50.80 x 25.40)	2.250 x 1.250 (57.15 x 31.75)	167

* This product is sold in Japan under the Overlamine Labels name and not under the PermaShield name.



PermaShield application is easy. Print the label on a computer printer, typewriter or with a pen. Put the label in place and cover with clear polyester (B-966) overlamine.

General and Industrial Identification

► BAR CODE LABELING

The materials used in these labels are conformable and resist oils, weathering, abrasion and solvents. Special topcoats on all Brady bar code materials assure long-term legibility.

White Paper (B-609) Pin-fed Labels

Part Number	Package Quantity	Label Size Inch (mm)	Specifications On Page
BCDAT-1-609	5,000	2.000 x 0.900 (50.80 x 22.86)	161
BCDAT-2-609	5,000	3.000 x 0.900 (76.20 x 22.86)	162
BCDAT-3-609	5,000	2.000 x 1.437 (50.80 x 36.50)	161
BCDAT-4-609	5,000	3.000 x 1.437 (76.20 x 36.50)	162
BCDAT-5-609	5,000	3.900 x 1.437 (99.06 x 36.50)	162
BCDAT-6-609	5,000	3.000 x 1.900 (76.20 x 48.26)	162
BCDAT-7-609	2,500	6.000 x 3.937 (152.40 x 100.00)	167

White Polyester (B-619) Pin-fed Labels

Part Number	Package Quantity	Label Size Inch (mm)	Specifications On Page
BCDAT-1-619	5,000	2.000 x 0.900 (50.80 x 22.86)	161
BCDAT-2-619	5,000	3.000 x 0.900 (76.20 x 22.86)	162
BCDAT-3-619	5,000	2.000 x 1.437 (50.80 x 36.50)	161
BCDAT-4-619	5,000	3.000 x 1.437 (76.20 x 36.50)	162
BCDAT-5-619	5,000	3.900 x 1.437 (99.06 x 36.50)	162
BCDAT-6-619	5,000	3.000 x 1.900 (76.20 x 48.26)	162
BCDAT-8-619	5,000	1.500 x 0.250 (38.10 x 6.35)	161
BCDAT-9-619	5,000	2.000 x 0.250 (50.80 x 6.35)	161
BCDAT-10-619	10,000	2.000 x 0.375 (50.80 x 9.53)	161
BCDAT-11-619	10,000	3.000 x 0.375 (76.20 x 9.53)	162
BCDAT-12-619	10,000	1.500 x 0.750 (38.10 x 19.05)	164

Amber Polyimide (B-652) Pin-fed Labels

Part Number	Package Quantity	Label Size Inch (mm)	Specifications On Page
BCDAT-8-652	5,000	1.500 x 0.250 (38.10 x 6.35)	161
BCDAT-9-652	5,000	2.000 x 0.250 (50.80 x 6.35)	161
BCDAT-10-652	10,000	2.000 x 0.375 (50.80 x 9.53)	161
BCDAT-11-652	10,000	3.000 x 0.375 (76.20 x 9.53)	162



Datab® labels printed with Series 2000™ or 5000™ ink provide long-lasting identification of assets and property.

► **BRADYSLEEVE™ COMPUTER-PRINTABLE WIRE MARKERS**

Select from 3 durable materials:

B-319 Non-Shrink Polyolefin

- ▶ Provides low-cost method for wire identification
- ▶ Outstanding legend performance and smudge resistance
- ▶ Temperature range: -40°F to 221°F (-40°C to 105°C)

B-321 Heat-Shrink Polyolefin

- ▶ Heat-shrinkable material provides a skin-tight bond; marker will not slip off wire
- ▶ Excellent resistance to oils and solvents
- ▶ Temperature range: -65°F to 221°F (-54°C to 105°C)

B-322 Self-Extinguishing Heat-Shrink Polyolefin

- ▶ Ideal for applications requiring self-extinguishing properties
- ▶ Meets flammability requirements of MIL-I-23053C
- ▶ Temperature range: -40°F to 221°F (-40°C to 105°C)

Brady Heat Gun

The Brady Heat Gun provides fast, even shrinkage of BradySleeve and PermaSleeve™ markers or heat-shrinkable tubing. Deflector shield evenly distributes forced air heat (minimum temperature 500°F (260°C)) around sleeves of up to 3/4" diameter for uniform shrinkage. Sturdy base with rubber pad allows hands-off operation.

Part Number	Description
PMS-HG-1	Brady Heat Gun

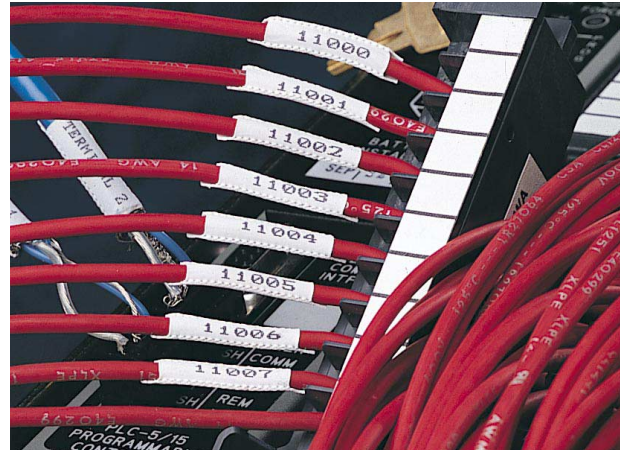

Durable BradySleeve markers stand up to tough conditions, assuring long life and a permanent legend. The exclusive topcoat "soaks up" ink and retains it permanently, without additional curing. BradySleeve markers can be imprinted using a wide variety of systems.



BradySleeve and PermaSleeve heat-shrinkable markers conform tightly to the wire when heat is applied for a few seconds. The Brady Heat Gun facilitates BradySleeve and PermaSleeve wire marker applications.



The specially designed starter edge on BradySleeve markers makes wire insertion fast and easy. The marker hugs the wire and stays in place for shrinking.

Sleeves for Wire and Cable Identification

► BRADYSLEEVE™ COMPUTER-PRINTABLE WIRE MARKERS

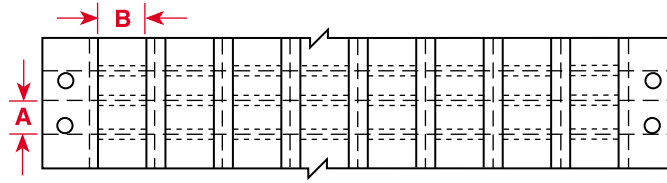

0.400" Sleeve Width

Part Number	Quantity Per Box	Sleeve Height Inch (mm) A	Sleeve Width Inch (mm) B	Range of Wire Dia. Inch (mm)	Approximate Wire Gauge*	Print Lines/Inch	Sleeves Per Row
B-319 Non-Shrink White Polyolefin							
CPS-04-2508-WT	10,000	0.250 (6.35)	0.400 (10.16)	0.030-0.100 (0.76-2.54)	16-22	8	8
CPS-04-3336-WT	10,000	0.333 (8.46)	0.400 (10.16)	0.090-0.150 (2.28-3.81)	12-16	6	8
CPS-04-3758-WT	10,000	0.375 (9.53)	0.400 (10.16)	0.125-0.175 (3.18-4.45)	10-12	8	8
CPS-04-5008-WT	10,000	0.500 (12.70)	0.400 (10.16)	0.160-0.250 (4.06-6.35)	8-10	6 or 8	8

Small Quantity Packages: 0.400" sizes are available in 1,000 piece packages. The part number changes from CPS to SCPS (CPS-04-2508-WT would be SCPS-04-2508-WT). The "S" indicates small package quantities.

B-321 Heat-Shrink White Polyolefin							
HCPS-04-2508-WT	10,000	0.250 (6.35)	0.400 (10.16)	0.035-0.075 (0.89-1.90)	16-22	8	8
HCPS-04-3336-WT	10,000	0.333 (8.46)	0.400 (10.16)	0.075-0.130 (1.90-3.30)	12-16	6	8
HCPS-04-3758-WT	10,000	0.375 (9.53)	0.400 (10.16)	0.130-0.160 (3.30-4.06)	10-12	8	8
HCPS-04-5008-WT	10,000	0.500 (12.70)	0.400 (10.16)	0.160-0.235 (4.06-5.97)	8-10	6 or 8	8

Small Quantity Packages: 0.400" sizes are available in 1,000 piece packages. The part number changes from HCPS to HSCPS (HCPS-04-2508-WT would be HSCPS-04-2508-WT). The "S" indicates small package quantities.

B-322 Self-Extinguishing Heat-Shrink White Polyolefin							
SEHCPS-04-2508-W	10,000	0.250 (6.35)	0.400 (10.16)	0.035-0.075 (0.89-1.90)	16-22	8	8
SEHCPS-04-3336-W	10,000	0.333 (8.46)	0.400 (10.16)	0.075-0.130 (1.90-3.30)	12-16	6	8
SEHCPS-04-3758-W	10,000	0.375 (9.53)	0.400 (10.16)	0.130-0.160 (3.30-4.06)	10-12	8	8
SEHCPS-04-5008-W	10,000	0.500 (12.70)	0.400 (10.16)	0.160-0.235 (4.06-5.97)	8-10	6 or 8	8

Small Quantity Packages: 0.400" sizes are available in 1,000 piece packages. The part number changes from SEHCPS to SEHSCPS (SEHCPS-04-2508-W would be SEHSCPS-04-2508-W). The "S" indicates small package quantities.

► BRADYSLEEVE™ COMPUTER-PRINTABLE WIRE MARKERS

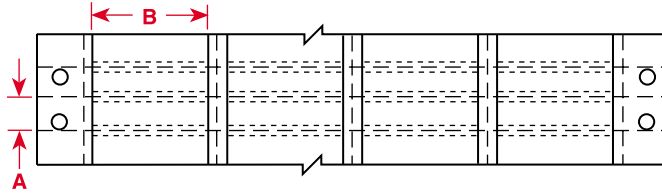

0.900" Sleeve Width

Part Number	Quantity Per Box	Sleeve Height Inch (mm) A	Sleeve Width Inch (mm) B	Range of Wire Dia. Inch (mm)	Approximate Wire Gauge*	Print Lines/Inch	Sleeves Per Row
B-319 Non-Shrink White Polyolefin							
CPS-0.9-2508-WT	5,000	0.250 (6.35)	0.900 (22.86)	0.030-0.100 (0.76-2.54)	16-22	8	4
CPS-0.9-3336-WT	5,000	0.333 (8.46)	0.900 (22.86)	0.090-0.150 (2.28-3.81)	12-16	6	4
CPS-0.9-3758-WT	5,000	0.375 (9.53)	0.900 (22.86)	0.125-0.175 (3.18-4.45)	10-12	8	4
CPS-0.9-5008-WT	5,000	0.500 (12.70)	0.900 (22.86)	0.160-0.250 (4.06-6.35)	8-10	6 or 8	4

Small Quantity Packages: 0.900" sizes are available in 500 piece packages. The part number changes from CPS to SCPS (CPS-0.9-2508-WT would be SCPS-0.9-2508-WT). The "S" indicates small package quantities.

B-321 Heat-Shrink White Polyolefin							
HCPS-0.9-1008-WT	3,000	1.000 (25.40)	0.900 (22.86)	0.375-0.540 (9.53-13.72)	00-1	6 or 8	4
HCPS-0.9-2508-WT	5,000	0.250 (6.35)	0.900 (22.86)	0.035-0.075 (0.89-1.90)	16-22	8	4
HCPS-0.9-3336-WT	5,000	0.333 (8.46)	0.900 (22.86)	0.075-0.130 (1.90-3.30)	12-16	6	4
HCPS-0.9-3758-WT	5,000	0.375 (9.53)	0.900 (22.86)	0.130-0.160 (3.30-4.06)	10-12	8	4
HCPS-0.9-5008-WT	5,000	0.500 (12.70)	0.900 (22.86)	0.160-0.235 (4.06-5.97)	8-10	6 or 8	4
HCPS-0.9-6258-WT	5,000	0.625 (15.87)	0.900 (22.86)	0.235-0.290 (5.97-7.36)	6-8	8	4
HCPS-0.9-6676-WT	5,000	0.667 (16.94)	0.900 (22.86)	0.290-0.335 (7.36-8.51)	4-6	6	4
HCPS-0.9-7508-WT	3,000	0.750 (19.05)	0.900 (22.86)	0.335-0.390 (8.51-9.91)	2-4	8	4
HCPS-0.9-8336-WT	3,000	0.833 (21.15)	0.900 (22.86)	0.390-0.440 (9.91-11.17)	1-2	6	4

Small Quantity Packages: 0.900" sizes are available in 500 piece packages. The part number changes from HCPS to HSCPS (HCPS-0.9-2508-WT would be HSCPS-0.9-2508-WT). The "S" indicates small package quantities.

B-322 Self-Extinguishing Heat-Shrink White Polyolefin							
SEHCPS-0.9-1008-W**	3,000	1.000 (25.40)	0.900 (22.86)	0.375-0.540 (9.53-13.72)	00-1	6 or 8	4
SEHCPS-0.9-2508-W**	5,000	0.250 (6.35)	0.900 (22.86)	0.035-0.075 (0.89-1.90)	16-22	8	4
SEHCPS-0.9-3336-W**	5,000	0.333 (8.38)	0.900 (22.86)	0.075-0.130 (1.90-3.30)	12-16	6	4
SEHCPS-0.9-3758-W**	5,000	0.375 (9.53)	0.900 (22.86)	0.130-0.160 (3.30-4.06)	10-12	8	4
SEHCPS-0.9-5008-W**	5,000	0.500 (12.70)	0.900 (22.86)	0.160-0.235 (4.06-5.97)	8-10	6 or 8	4
SEHCPS-0.9-7508-W**	3,000	0.750 (19.05)	0.900 (22.86)	0.235-0.375 (5.97-9.53)	2-4	8	4

Small Quantity Packages: 0.900" sizes are available in 500 piece packages. The part number changes from SEHCPS to SEHSCPS (SEHCPS-0.9-2508-W would be SEHSCPS-0.9-2508-W). The "S" indicates small package quantities.

*Approximate wire gauges are for guidelines only; exact sizes depend on insulation thickness.

**B-322 yellow is available in stock quantities. To order, change the "W" in the part number to "Y" (SEHCPS-0.9-7508-W to SEHCPS-0.9-7508-Y).

Sleeves for Wire and Cable Identification

► BRADYSLEEVE™ COMPUTER-PRINTABLE WIRE MARKERS

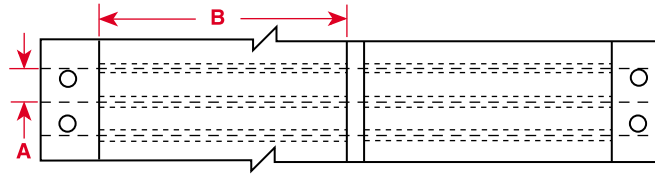

1.900" Sleeve Width

Part Number	Quantity Per Box	Sleeve Height Inch (mm) A	Sleeve Width Inch (mm) B	Range of Wire Dia. Inch (mm)	Approximate Wire Gauge*	Print Lines/Inch	Sleeves Per Row
B-319 Non-Shrink White Polyolefin							
CPS-1.9-2508-WT	2,500	0.250 (6.35)	1.900 (48.26)	0.030-0.100 (0.76-2.54)	16-22	8	2
CPS-1.9-3336-WT	2,500	0.333 (8.38)	1.900 (48.26)	0.090-0.150 (2.28-3.81)	12-16	6	2
CPS-1.9-3758-WT	2,500	0.375 (9.53)	1.900 (48.26)	0.125-0.175 (3.18-4.45)	10-12	8	2
CPS-1.9-5008-WT	2,500	0.500 (12.70)	1.900 (48.26)	0.160-0.250 (4.06-6.35)	8-10	6 or 8	2

Small Quantity Packages: 1.900" sizes are available in 250 piece packages. The part number changes from CPS to SCPS (CPS-1.9-2508-WT would be SCPS-1.9-2508-WT). The "S" indicates small package quantities.

B-321 Heat-Shrink White Polyolefin							
HCPS-1.9-1008-WT	1,500	1.000 (25.40)	1.900 (48.26)	0.375-0.540 (9.53-13.72)	00-1	6 or 8	2
HCPS-1.9-2508-WT	2,500	0.250 (6.35)	1.900 (48.26)	0.035-0.075 (0.89-1.90)	16-22	8	2
HCPS-1.9-3336-WT	2,500	0.333 (8.38)	1.900 (48.26)	0.075-0.130 (1.90-3.30)	12-16	6	2
HCPS-1.9-3758-WT	2,500	0.375 (9.53)	1.900 (48.26)	0.130-0.160 (3.30-4.06)	10-12	8	2
HCPS-1.9-5008-WT	2,500	0.500 (12.70)	1.900 (48.26)	0.160-0.235 (4.06-5.97)	8-10	6 or 8	2
HCPS-1.9-6258-WT	2,500	0.625 (15.87)	1.900 (48.26)	0.235-0.290 (5.97-7.36)	6-8	8	2
HCPS-1.9-6676-WT	2,500	0.667 (16.94)	1.900 (48.26)	0.290-0.335 (7.36-8.51)	4-6	6	2
HCPS-1.9-7508-WT	1,500	0.750 (19.05)	1.900 (48.26)	0.335-0.390 (8.51-9.91)	2-4	8	2
HCPS-1.9-8336-WT	1,500	0.833 (21.15)	1.900 (48.26)	0.390-0.440 (9.91-11.17)	1-2	6	2

Small Quantity Packages: 1.900" sizes are available in 250 piece packages. The part number changes from HCPS to HSCPS (HCPS-1.9-2508-WT would be HSCPS-1.9-2508-WT). The "S" indicates small package quantities.

B-322 Self-Extinguishing Heat-Shrink White Polyolefin							
SEHCPS-1.9-1008-W**	1,500	1.000 (25.40)	1.900 (48.26)	0.375-0.540 (9.53-13.72)	00-1	6 or 8	2
SEHCPS-1.9-2508-W**	2,500	0.250 (6.35)	1.900 (48.26)	0.035-0.075 (0.89-1.90)	16-22	8	2
SEHCPS-1.9-3336-W**	2,500	0.333 (8.38)	1.900 (48.26)	0.075-0.130 (1.90-3.30)	12-16	6	2
SEHCPS-1.9-3758-W**	2,500	0.375 (9.53)	1.900 (48.26)	0.130-0.160 (3.30-4.06)	10-12	8	2
SEHCPS-1.9-5008-W**	2,500	0.500 (12.70)	1.900 (48.26)	0.160-0.235 (4.06-5.97)	8-10	6 or 8	2
SEHCPS-1.9-7508-W**	1,500	0.750 (19.05)	1.900 (48.26)	0.235-0.375 (5.97-9.53)	2-4	8	2

Small Quantity Packages: 1.900" sizes are available in 250 piece packages. The part number changes from SEHCPS to SEHSCPS (SEHCPS-1.9-2508-W would be SEHSCPS-1.9-2508-W). The "S" indicates small package quantities.

**B-322 yellow is available in large quantity packages only. To order, change the "W" in the part number to "Y" (SEHCPS-1.9-7508-W would be SEHCPS-1.9-7508-Y).

*Approximate wire gauges are for guidelines only; exact sizes depend on insulation thickness.

► **3-TO-1 SHRINK RATIO ONE-SIDED PRINTABLE PERMASLEEVE™ WIRE MARKERS**

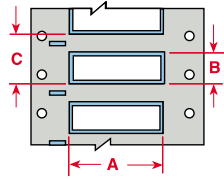

PermaSleeve markers fit snugly around wires for maximum insulation protection and permanent identification.



Brady PermaSleeve full-circle insulating wire markers meet the rigid insulating, material requirements and physical properties of MIL-DTL-23053/5 Class 1, MIL-M-81531, MIL-STD-202F, METHOD 215, and UL224. The heat-shrinkable irradiated polyolefin does not smudge or fade when printed, while the unique flattened full-circle design provides fast, permanent wire marking. PermaSleeve markers may be printed on Brady's thermal transfer printers or Brady's SLV-DAT-PTR dot matrix printer.

White Polyolefin (B-342) One-Sided Printable PermaSleeve Markers

Part Number	Markers Per Box	Range of Wire Dia. Inch (mm)		Approx. Wire Gauge*	Marker Width Inch (mm) A	Marker Height Inch (mm) B	Vertical Repeat Inch (mm) C	Maximum Lines of Print	Maximum Characters Across			
		Min.	Max.						5 CPI	10 CPI	17.1 CPI	
1.500" Marker Width												
PS-094-150-WT	2,500	0.023	(0.58)–(0.080) (2.03)	28-18	1.500 (38.10)	0.182 (4.60)	0.500 (12.70)	1	7	15	25	
PS-094-150-WT-S	500	0.023	(0.58)–(0.080) (2.03)	28-18	1.500 (38.10)	0.182 (4.60)	0.500 (12.70)	1	7	15	25	
PS-125-150-WT	2,500	0.046	(1.17)–(0.110) (2.79)	22-16	1.500 (38.10)	0.235 (6.00)	0.500 (12.70)	1	7	15	25	
PS-125-150-WT-S	500	0.046	(1.17)–(0.110) (2.79)	22-16	1.500 (38.10)	0.235 (6.00)	0.500 (12.70)	1	7	15	25	
PS-187-150-WT	2,500	0.062	(1.57)–(0.150) (3.81)	18-12	1.500 (38.10)	0.335 (8.50)	0.625 (15.88)	2	7	15	25	
PS-187-150-WT-S	500	0.062	(1.57)–(0.150) (3.81)	18-12	1.500 (38.10)	0.335 (8.50)	0.625 (15.88)	2	7	15	25	
PS-250-150-WT	2,500	0.094	(2.39)–(0.215) (5.46)	16-10	1.500 (38.10)	0.439 (11.15)	0.750 (19.05)	2	7	15	25	
PS-250-150-WT-S	500	0.094	(2.39)–(0.215) (5.46)	16-10	1.500 (38.10)	0.439 (11.15)	0.750 (19.05)	2	7	15	25	
PS-375-150-WT	1,000	0.125	(3.18)–(0.320) (8.13)	12-6	1.500 (38.10)	0.645 (16.40)	1.000 (25.40)	4	7	15	25	
PS-375-150-WT-S	250	0.125	(3.18)–(0.320) (8.13)	12-6	1.500 (38.10)	0.645 (16.40)	1.000 (25.40)	4	7	15	25	
PS-500-150-WT	500	0.187	(4.75)–(0.450) (11.43)	8-1	1.500 (38.10)	0.851 (21.60)	1.250 (31.75)	5	7	15	25	
PS-500-150-WT-S	250	0.187	(4.75)–(0.450) (11.43)	8-1	1.500 (38.10)	0.851 (21.60)	1.250 (31.75)	5	7	15	25	
2.000" Marker Width												
PS-094-2-WT	2,500	0.023	(0.58)–(0.080) (2.03)	28-18	2.000 (50.80)	0.182 (4.60)	0.500 (12.70)	1	9	18	30	
PS-094-2-WT-S	500	0.023	(0.58)–(0.080) (2.03)	28-18	2.000 (50.80)	0.182 (4.60)	0.500 (12.70)	1	9	18	30	
PS-125-2-WT	2,500	0.046	(1.17)–(0.110) (2.79)	22-16	2.000 (50.80)	0.235 (6.00)	0.500 (12.70)	1	9	18	30	
PS-125-2-WT-S	500	0.046	(1.17)–(0.110) (2.79)	22-16	2.000 (50.80)	0.235 (6.00)	0.500 (12.70)	1	9	18	30	
PS-187-2-WT	2,500	0.062	(1.57)–(0.150) (3.81)	18-12	2.000 (50.80)	0.335 (8.50)	0.625 (15.88)	2	9	18	30	
PS-187-2-WT-S	500	0.062	(1.57)–(0.150) (3.81)	18-12	2.000 (50.80)	0.335 (8.50)	0.625 (15.88)	2	9	18	30	
PS-250-2-WT	2,500	0.094	(2.39)–(0.215) (5.46)	16-10	2.000 (50.80)	0.439 (11.15)	0.750 (19.05)	2	9	18	30	
PS-250-2-WT-S	500	0.094	(2.39)–(0.215) (5.46)	16-10	2.000 (50.80)	0.439 (11.15)	0.750 (19.05)	2	9	18	30	
PS-375-2-WT	1,000	0.125	(3.18)–(0.320) (8.13)	12-6	2.000 (50.80)	0.645 (16.40)	1.000 (25.40)	4	9	18	30	
PS-375-2-WT-S	250	0.125	(3.18)–(0.320) (8.13)	12-6	2.000 (50.80)	0.645 (16.40)	1.000 (25.40)	4	9	18	30	
PS-500-2-WT	500	0.187	(4.75)–(0.450) (11.43)	8-1	2.000 (50.80)	0.851 (21.60)	1.250 (31.75)	5	9	18	30	
PS-500-2-WT-S	250	0.187	(4.75)–(0.450) (11.43)	8-1	2.000 (50.80)	0.851 (21.60)	1.250 (31.75)	5	9	18	30	

2-to-1 Shrink Ratio White Polyolefin (B-341) One-Sided Printable PermaSleeve Markers

Part Number	Markers Per Box	Range of Wire Dia. Inch (mm)		Approx. Wire Gauge*	Marker Width Inch (mm) A	Marker Height Inch (mm) B	Vertical Repeat Inch (mm) C	Maximum Lines of Print	Maximum Characters Across			
		Min.	Max.						5 CPI	10 CPI	17.1 CPI	
2.000" Marker Width												
PS-1000-2-WT	250	0.450	(11.43)–(0.950) (24.13)	1-500	2.000 (50.80)	1.660 (42.16)	2.000 (50.80)	11	9	18	30	

*Based on National Electric Code insulation measurement of THHN wire.

Sleeves may be perforated at factory for shorter marker lengths. Depending on overall length, sleeves may be perforated in halves, thirds or fourths. Contact your Brady Identification Solutions Distributor or Customer Service Representative for ordering information.

Sleeves for Wire and Cable Identification

▶ 3-TO-1 SHRINK RATIO TWO-SIDED PRINTABLE PERMASLEEVE™ WIRE MARKERS

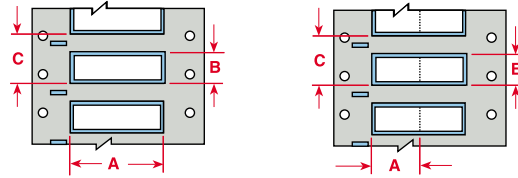

PermaSleeve full-circle markers are available in a 3-to-1 shrink ratio to cover a wider range of wire diameters per sleeve size.

White Polyolefin (B-342) Two-Sided Printable PermaSleeve Markers

Part Number	Markers Per Box	Range of Wire Dia. Inch (mm)		Approx. Wire Gauge*	Marker Width Inch (mm) A	Marker Height Inch (mm) B	Vertical Repeat Inch (mm) C		Maximum Lines of Print	Maximum Characters Across			
		Min.	Max.							5 CPI	10 CPI	17.1 CPI	
2.000" Marker Width													
3PS-094-2-WT	2,500	0.023	(0.58)–(0.080 (2.03)	28-18	2.000 (50.80)	0.182 (4.60)	0.500 (12.70)	1	9	18	30		
3PS-094-2-WT-S	500	0.023	(0.58)–(0.080 (2.03)	28-18	2.000 (50.80)	0.182 (4.60)	0.500 (12.70)	1	9	18	30		
3PS-125-2-WT	2,500	0.046	(1.17)–(0.110 (2.79)	22-16	2.000 (50.80)	0.235 (6.00)	0.500 (12.70)	1	9	18	30		
3PS-125-2-WT-S	500	0.046	(1.17)–(0.110 (2.79)	22-16	2.000 (50.80)	0.235 (6.00)	0.500 (12.70)	1	9	18	30		
3PS-187-2-WT	2,500	0.062	(1.57)–(0.150 (3.81)	18-12	2.000 (50.80)	0.335 (8.50)	0.625 (16.00)	2	9	18	30		
3PS-187-2-WT-S	500	0.062	(1.57)–(0.150 (3.81)	18-12	2.000 (50.80)	0.335 (8.50)	0.625 (16.00)	2	9	18	30		
3PS-250-2-WT	2,500	0.094	(2.39)–(0.215 (5.46)	16-10	2.000 (50.80)	0.439 (11.15)	0.750 (19.05)	2	9	18	30		
3PS-250-2-WT-S	500	0.094	(2.39)–(0.215 (5.46)	16-10	2.000 (50.80)	0.439 (11.15)	0.750 (19.05)	2	9	18	30		
3PS-375-2-WT	1,000	0.125	(3.18)–(0.320 (8.13)	12-6	2.000 (50.80)	0.645 (16.40)	1.000 (25.40)	4	9	18	30		
3PS-375-2-WT-S	250	0.125	(3.18)–(0.320 (8.13)	12-6	2.000 (50.80)	0.645 (16.40)	1.000 (25.40)	4	9	18	30		
3PS-500-2-WT	500	0.187	(4.75)–(0.450 (11.43)	8-1	2.000 (50.80)	0.851 (21.60)	1.250 (31.75)	5	9	18	30		
3PS-500-2-WT-S	250	0.187	(4.75)–(0.450 (11.43)	8-1	2.000 (50.80)	0.851 (21.60)	1.250 (31.75)	5	9	18	30		

*Based on National Electric Code insulation measurement of THHN wire.

Sleeves may be perforated at factory for shorter marker lengths. Depending on overall length, sleeves may be perforated in halves, thirds or fourths. Contact your Brady Identification Solutions Distributor or Customer Service Representative for ordering information.

Sleeves for Wire and Cable Identification

▶ COLORED TWO-SIDED 3-TO-1 SHRINK RATIO PERMASLEEVE™ MARKERS

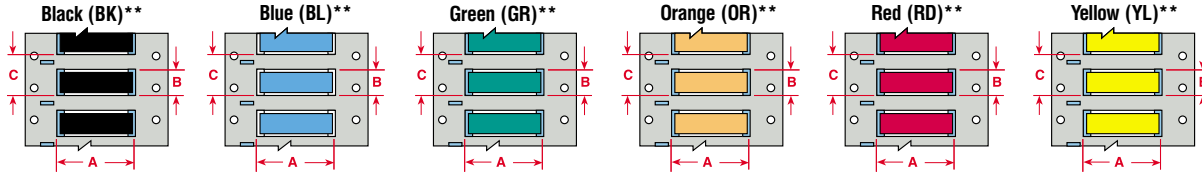

PermaSleeve full-circle markers are available in a 3-to-1 shrink ratio to cover a wider range of wire diameters per sleeve size.

3-to-1 Shrink Ratio Colored Polyolefin (B-342) Two-Sided Printable PermaSleeve Markers

Part Number	Markers Per Box	Range of Wire Dia. Inch (mm)		Approx. Wire Gauge*	Marker Width Inch (mm) A	Marker Height Inch (mm) B	Vertical Repeat Inch (mm) C	Maximum Lines of Print	Maximum Characters Across			
		Min.	Max.						5 CPI	10 CPI	17.1 CPI	
2.000" Marker Width												
3PS-094-2-YL	2,500	0.023	(0.58)–(0.080) (2.03)	28-18	2.000 (50.80)	0.182 (4.60)	0.500 (12.70)	1	9	18	30	
3PS-094-2**-S	500	0.023	(0.58)–(0.080) (2.03)	28-18	2.000 (50.80)	0.182 (4.60)	0.500 (12.70)	1	9	18	30	
3PS-125-2-YL	2,500	0.046	(1.17)–(0.110) (2.79)	22-16	2.000 (50.80)	0.235 (6.00)	0.500 (12.70)	1	9	18	30	
3PS-125-2**-S	500	0.046	(1.17)–(0.110) (2.79)	22-16	2.000 (50.80)	0.235 (6.00)	0.500 (12.70)	1	9	18	30	
3PS-187-2-YL	2,500	0.062	(1.57)–(0.150) (3.81)	18-12	2.000 (50.80)	0.335 (8.50)	0.625 (15.88)	2	9	18	30	
3PS-187-2**-S	500	0.062	(1.57)–(0.150) (3.81)	18-12	2.000 (50.80)	0.335 (8.50)	0.625 (16.00)	2	9	18	30	
3PS-250-2-YL	2,500	0.094	(2.39)–(0.215) (5.46)	16-10	2.000 (50.80)	0.439 (11.15)	0.750 (19.05)	2	9	18	30	
3PS-250-2**-S	500	0.094	(2.39)–(0.215) (5.46)	16-10	2.000 (50.80)	0.439 (11.15)	0.750 (19.05)	2	9	18	30	
3PS-375-2-YL	1,000	0.125	(3.18)–(0.320) (8.13)	12-6	2.000 (50.80)	0.645 (16.40)	1.000 (25.40)	4	9	18	30	
3PS-375-2**-S	250	0.125	(3.18)–(0.320) (8.13)	12-6	2.000 (50.80)	0.645 (16.40)	1.000 (25.40)	4	9	18	30	
3PS-500-2-YL	500	0.187	(4.75)–(0.450) (11.43)	8-1	2.000 (50.80)	0.851 (21.60)	1.250 (31.75)	5	9	18	30	
3PS-500-2**-S	250	0.187	(4.75)–(0.450) (11.43)	8-1	2.000 (50.80)	0.851 (21.60)	1.250 (31.75)	5	9	18	30	

Contact your Brady Identification Solutions Distributor or Customer Service Representative for ordering information.

**When ordering a color add BL (Blue), BK (Black), GR (Green), OR (Orange), RD (Red), YL (Yellow).

2-to-1 Shrink Ratio Colored Polyolefin (B-341) One-Sided Printable PermaSleeve Markers

Part Number	Markers Per Box	Range of Wire Dia. Inch (mm)		Approx. Wire Gauge*	Marker Width Inch (mm) A	Marker Height Inch (mm) B	Vertical Repeat Inch (mm) C	Maximum Lines of Print	Maximum Characters Across			
		Min.	Max.						5 CPI	10 CPI	17.1 CPI	
2.000" Marker Width												
PS-1000-2-YL	250	0.450	(11.43)–(0.950) (24.13)	1-500	2.000 (50.80)	1.660 (42.16)	2.000 (50.80)	11	9	18	30	
PS-1000-2-BK-S	100	0.450	(11.43)–(0.950) (24.13)	1-500	2.000 (50.80)	1.660 (42.16)	2.000 (50.80)	11	9	18	30	

*Based on National Electric Code insulation measurement of THHN wire.

Sleeves may be perforated at factory for shorter marker lengths. Depending on overall length, sleeves may be perforated in halves, thirds or fourths. Contact your Brady Identification Solutions Distributor or Customer Service Representative for ordering information.

DuraSleeve® Wire Marking System

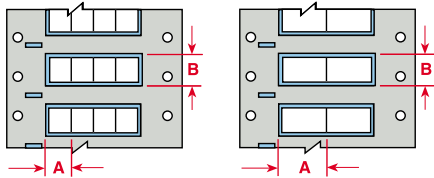

Brady DuraSleeve Markers Create a Durable Legend

Combining speed, power and flexibility, the DuraSleeve wire marking system provides printable inserts that can easily be inserted into a clean carrier. The DuraSleeve wire marking system does everything your current wire marking system does, and then provides advantages you can't find anywhere else:

- ▶ The legend can be easily changed before or after termination.
- ▶ DuraSleeve wire marking system meets current engineering specifications.
- ▶ DuraSleeve wire marking system reduces inventory by providing markers "just-in-time."
- ▶ DuraSleeve wire marking system saves time by printing legends on-demand.
- ▶ DuraSleeve wire marking system portability brings labeling on site: SLV-DAT-PTR, ID PRO PLUS and LS2000.
- ▶ DuraSleeve wire marking system increases efficiency by allowing importation of data from computer applications.
- ▶ DuraSleeve wire marking system performance meets or exceeds any materials you are currently using.

Polypropylene Inserts (B-389)

Part Number	Printing System	No. Inserts Across	Inserts Per Roll	Insert Dim. Inch (mm) A	Insert Height Inch (mm) B	Max Lines of Print	Maximum Characters Across		
							10 CPI	17.1 CPI	20 CPI
0.500" (12.70 mm) insert width									
DMPF-4105-389	SLV-DAT-PTR	4	5000	0.500 (12.70)	0.155 (3.93)	1	4	6	8
DMPF-4105-389-YL*	SLV-DAT-PTR	4	5000	0.500 (12.70)	0.155 (3.93)	1	4	6	8
1.000" (25.40 mm) insert width									
DMPF-2111-389	SLV-DAT-PTR	2	2500	1.000 (25.40)	0.155 (3.93)	1	9	15	19
DMPF-2111-389-YL*	SLV-DAT-PTR	2	2500	1.000 (25.40)	0.155 (3.93)	1	9	15	19

*Yellow product is designated with a "YL" at the end of the part number.



DuraSleeve wire marker inserts fit into clear carriers.

▶ DURASLEEVE® WIRE MARKING CARRIERS

Part Number	Carrier Width Inch (mm)	Wire O.D. Inch (mm)	Type THHN Approximate Wire Gauge	Carriers per Box
DMC-1.3/3-15	0.590 (15.00)	0.051 (1.30) – 0.118 (3.00)	20 – 12	1000
DMC-1.3/3-30	1.180 (30.00)			500
DMC-2.5/5-15	0.590 (15.00)	0.098 (2.50) – 0.197 (5.00)	16 – 10	1000
DMC-2.5/5-30	1.180 (30.00)			500
DMC-4/10-15	0.590 (15.00)	0.157 (4.00) – 0.393 (10.00)	10 – 4	500
DMC-4/10-30	1.180 (30.00)			200
DMC-8/16-15	0.590 (15.00)	0.315 (8.00) – 0.630 (16.00)	6 – 250	500
DMC-8/16-30	1.180 (30.00)			200

Software, Services and Data Collection

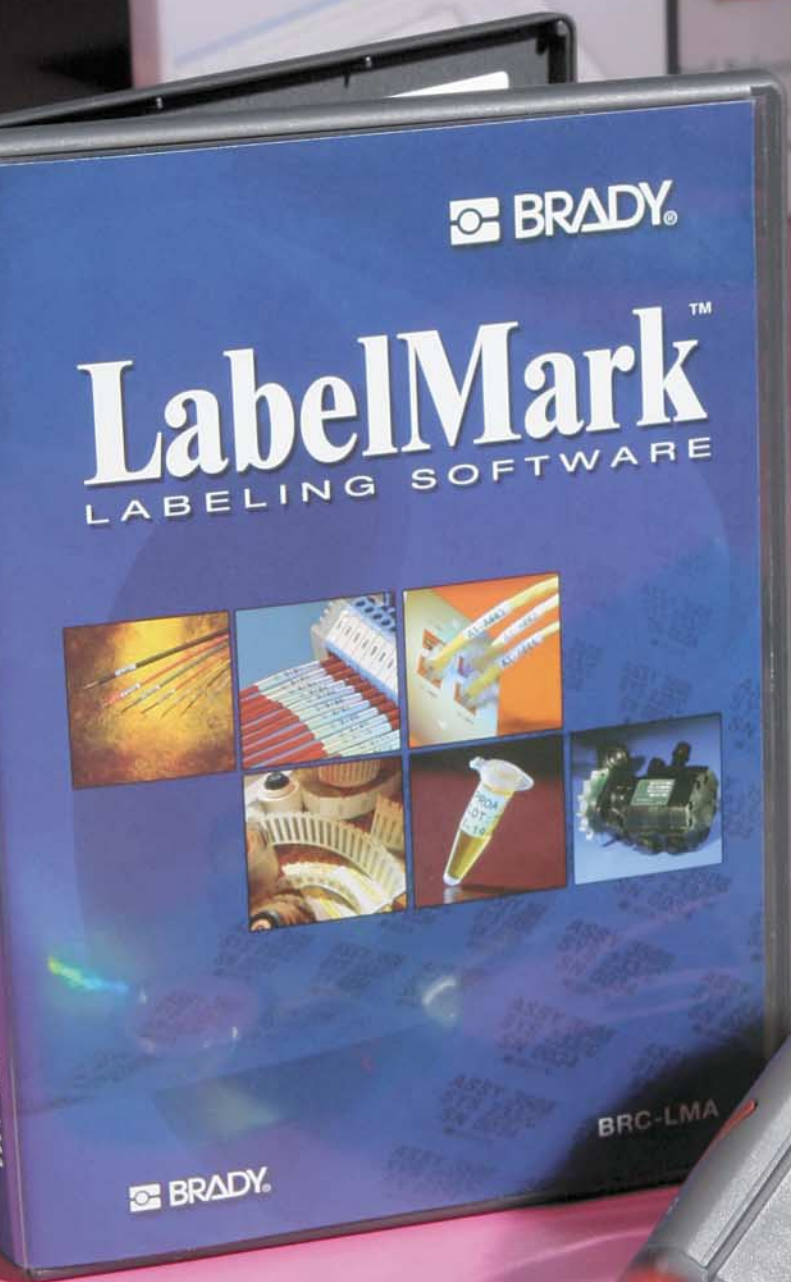

Selecting Your Labeling / Identification Software	200
BradySoft™ 8 Label Design Software	202
MarkWare™ Facility Identification Software	204
ChemLabel™ Hazardous Material Labeling Software	205
LabelMark™ V3 Labeling Software	206
IdentiLab™ Laboratory Labeling Software	208
Surf on Signs™ Signs and Labels Database Software	209
Lockout PRO™ Graphical Procedure Writing Software	210
Lockout PRO™ Enterprise	211
Selecting Your Tracking Software	212
FacilityManager	214
MEDI-MIZER™	214
Fireproof™ XT	214
Inspection Manager FLX	214
Asset Track	215
Inventory Track	215
Tool Track	215
NetDoc™ Network Documentation and Cable Management Software	216
Selecting Your Tracking / Automation Hardware	218
Bar Code Laser (BCL)	219
Powerscan™	219
Code Reader 1.0	219
Code Reader 2.0	220



Selecting Your Labeling / Identification Software

 <p>Bradysoft™</p> <p>Bar code technology has been behind the scenes in industries like Automotive and Manufacturing for decades, and Bradysoft bar code labeling and integration software has been leading the way with a full complement of advanced features that offer an enhanced level of data connectivity, security and interoperability. Best used for bar coding, rating plate, complex and graphic intensive labeling.</p> <p style="text-align: center;">Page 202</p>	 <p>MarkWare™</p> <p>MarkWare is a powerful and versatile software for facility identification. Meet all of your requirements easily using the built-in library of 800+ symbols and pictograms, 2000 chemical database for RTK labels, built-in templates and much more. Easily create your important messages in a clearly understood manner. Depending on your Brady printer MarkWare can deliver single, multiple color, and die-cut output.</p> <p style="text-align: center;">Page 204</p>	 <p>LabelMark™</p> <p>This versatile label design software is written specifically for identification applications in the telecomm, electrical and general industrial markets. LabelMark V3 is the logical solution for label design, editing and printing.</p> <p style="text-align: center;">Page 206</p>
--	--	--

GENERAL	Bradysoft™	MarkWare™	LabelMark™
Versions Available	3	1	2
Site License			X
Network Versions	X	X	
Pre-programmed Formats	Die-cut, Continuous, Tags	Pre-printed Sheet-fed Blanks, Cont.	Die-cut, Continuous, Tags
Pre-programmed ANSI/OSHA/GENERAL Facility ID Templates		X	
Right-To-Know Templates		X	
Advanced Security (User Manager)	Enterprise only		
Basic Security (Password Protect)	X	X	
Multiple Label Display			X
Application Specific Template Wizard		X	
Multi-Language Capability	21	11	7
Simple Fixed Line Entry Mode			X
Wiremarker Mode			X
Multiple Print Zones			
COMMON APPLICATIONS			
Rating Plate Creation	X		
Wire Marking			X
Component Labeling			X
Asset ID	X		X
Terminal Block ID			X
Patch Panel ID			X
Face Plate ID			X
Industrial Labeling	X	X	
Bin Shelf Labeling	X	X	X
Facility Identification (Signs, PipeMarkers)		X	
Tag Creation		X	
Hazardous Communications (Right to Know, WHIMS)		X	
Energy Source Labeling		X	
Lockout Procedures			
Work In Process Labeling	X		
Product Appeal Labeling	X	X	
General Bar Code Labeling	X		X
Slide and Vial Identification			
Compliance Labeling	X		
Shipping Applications	X		
Logistics	X	X	X
PRINTERS AND PRINTING			
Internal Thermal Printer Support (650+ Printers)	X		
Output Capability	Color, Grayscale	Color, Grayscale	Black/White
Batch Printing	Enterprise only	X	
Terminal Block Printing			X
Two-sided sleeve printing			X
110 Block Printing Templates			X
TLS 2200® Periphial Printing (page 16)			X
Standard Windows® Print Drivers	X		X
GlobalMark™ Periphial Printing (page 75)		X	
PowerMark® Periphial Printing		X	
HandiMark® Periphial Printing (page 50)		X	
Labelizer® Plus / VersaPrinter™		X	
LABXPRT™ Periphial Printing			
TLS PC Link™ Periphial Printing (page 16)	X		X

SOFTWARE, SERVICES AND DATA COLLECTION

Selecting Your Labeling / Identification Software

 <p>ChemLabel™</p> <p>Poorly and inaccurately labeled chemicals and other dangerous materials represent potentially serious safety problems. Brady's new ChemLabel Hazardous Material Labeling Software will make it easy to create and print labels for hazardous substances. Wizard interface makes choosing and creating the correct identification simple and easy.</p> <p>Page 205</p>	 <p>IdentiLab™</p> <p>Designed specifically for laboratory users, IdentiLab is loaded with capabilities to provide you with an all-in-one solution to meet your labeling needs.</p> <p>Page 208</p>	 <p>Surf on Signs™</p> <p>Thousands of pre-made signs and labels; simply search for what you need and print it. You can also translate the message into a different language or edit the message prior to printing.</p> <p>Page 209</p>	 <p>Lock Out PRO™</p> <p>Regulatory software designed to make Brady Lockout PRO Graphical Procedure Writing Software provides all the tools you need to create an effective, compliant energy control program with standardized procedures that are easy to follow. Lockout tags and labels can be printed for each energy source and are cross-referenced to the procedure, making lockout activities virtually foolproof.</p> <p>Page 210</p>
1	1	1	2
X	X		X
Die-Cut, Continuous	Die-Cut, Continuous	Signage, Continuous	Signage, Continuous
		X	X
X			
X			X
X	X	X	X
1	7	1	4
	X		
	2		
		X	
X		X	
X			
			X
			X
	X		
Color, Grayscale	Black/White	Color, Grayscale	Color, Grayscale
X	X	X	X
X	X	X	X
X		X	
X		X	X
X		X	
	X		
	X		

SOFTWARE, SERVICES AND DATA COLLECTION / IDENTIFICATION SOFTWARE

BradySoft™ 8 Label Design Software



Advanced labeling made simple.

With BradySoft 8 Label Design Software, you can create labels that help your organization manage assets and resources, control distribution channels and stock levels, track documents, or manage data records – all with one powerful labeling program.

Create fast labels for safety, tracking, brand identification, and more. Increase safety and ensure code compliance with rating plates, Arc Flash labels, and other safety labels. With the BradySoft 8 bar coding features, you'll be able to track inventory, data or lab samples. You'll also be able to create name plates, push button labels, and more for your entire organization.

▶ THE TOOLS YOU NEED, WHERE YOU NEED THEM

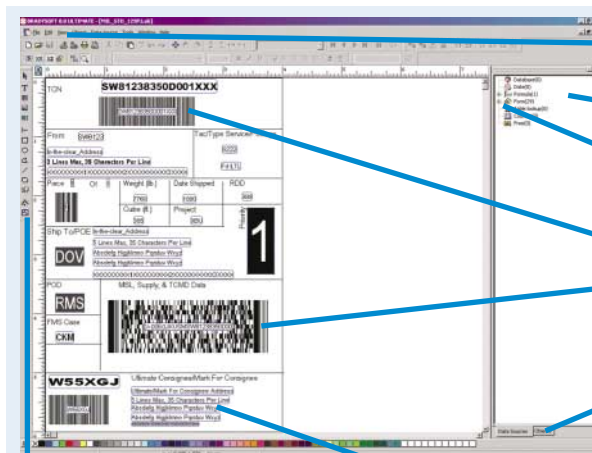

1 Enhance Objects

Sharpen text or create chemical formulas

2 OLE DB/ODBC Connectivity

Access all database formats (Access, Oracle, SQL Server); multiple database connections allowed

7 Easy-to-Use Tools

Manage security, print and connect serial devices

6 Document Browser

Lists every object for quick access

5 Drop & Drag

Easily select objects and place into label space

4 Bar Codes

Linear bar code symbologies and 2D bar coding capability

3 Data Source

Share fields between labels; use formulas for standardized labels

▶ DESIGN TOOLS FOR FAST LABEL DESIGN

No special training required with these intuitive, easy-to-use features:

- ▶ Define colors and patterns for text and image objects
- ▶ Create or add Rich Text File (RTF) objects
- ▶ Organize data from external data sources
- ▶ Import data from multiple database connections
- ▶ Switch from TrueType fonts to printer resident fonts
- ▶ Change printer default margins for trouble-free printing

▶ DON'T RETYPE – IMPORT FOR FASTER, MORE ACCURATE LABELS

Easily import information from spreadsheets and data tables right onto your labels with fewer errors.

- ▶ Database Connection Wizard
- ▶ Label Design Wizard that's intuitive and easy-to-use
- ▶ Database tables can be easily created, modified, or deleted

- ▶ Custom Query Designer for selective record printing
- ▶ Database Manager Tool lets you print directly from the database
- ▶ Label preview

▶ NO-HASSLE, AUTOMATED LABEL PRINTING

BradySoft 8 Label Design Software makes label printing faster and easier with these flexible options:

- ▶ Analyze labels to locate elements that are not print optimized
- ▶ Create and print faster with business-specific print formulas
- ▶ Streamline the process with control variables for batch printing
- ▶ Simplify printing with five different print dialog options
- ▶ Customize parameters for exporting data
- ▶ Print directly from "Find Record" results
- ▶ Encode complicated labels for trouble-free printing

BradySoft™ 8 Label Design Software

BradySoft 8 Version Features	STANDARD	ULTIMATE RFID	NETWORK VERSIONS (3, 5, 10, 25, 50)
GENERAL			
Manage multiple users			•
Print only version		•	•
UNICODE	•	•	•
Printer code converter	•	•	•
Multi-level undo	-40	-40	-40
Auto Save document	•	•	•
Password (one level)	•	•	•
Hidden (unprintable) objects	•	•	•
Graphic formats import		•	•
Color support		•	•
Color graphic reduction	•	•	•
Graphic bar codes	ALL	ALL	ALL
Native printer bar codes	•	•	•
Circular bar codes		•	•
TextArt	•	•	•
Rich Text Fields (RTF)		•	•
Listfield		•	•
Object positioning	•	•	•
Command line options		•	•
Label preview		•	•
Multi-Level password protection		•	•
Full justify	•	•	•
Preview graphics/labels	•	•	•
Multilingual support	•	•	•
Export label as a graphic		•	•
Import from FTP		•	•
Word hyphenation option		•	•
Long file names		•	•
TCP/IP Printing	•	•	•
OLE objects	•	•	•
Fit to frame option		•	•
Grid view/print		•	•
RF Tag management		•	•
Lock/Unlock objects		•	•

► **SERVER REQUIREMENTS**

Hardware Requirements

- IBM compatible PC (486 or higher)
- 64 MB RAM for Windows® 2000 or Windows® XP users (128 MB recommended)
- 256 MB RAM for Windows® Server 2003 users (512 MB recommended)
- SVGA monitor or better
- Hard Drive with 150 MB free space or greater
- CD ROM drive

Operating System and System Files:

- Microsoft® Windows® 2000, Windows® XP or Windows® Server 2003
- Microsoft® Data Access Components 2.8 (MDAC) or greater
- Microsoft® .Net Framework 1.1

Application Requirements

- Microsoft® Internet Explorer 6.0 or greater
- Adobe Acrobat Reader 6.0 or greater

► **BRADYSOFT 8 ULTIMATE RFID**

Description	Part Number
BradySoft 8 Ultimate RFID	BS80ULTM

BradySoft Ultimate offers the most text editing and bar code features, and incorporates security features. This is the best choice for advanced database importation and integration with third-party programs.

► **BRADYSOFT 8 STANDARD**

Description	Part Number
BradySoft 8 Standard	BS80STD

BradySoft Standard gives you the tools you need to design and print labels with ease, including text, bar codes, graphics, and fixed or variable data, using user-defined or database-driven information.

► **BRADYSOFT 8 RUNTIME**

Description	Part Number
BradySoft 8 RunTime	BS80RUNS

BradySoft RunTime is a print-only version that allows users to quickly and easily print labels, but not manipulate them.

► **BRADYSOFT 8 NETWORK**

Description	Part Number
BradySoft 8 Network 3	BS80N03S

BradySoft Network gives you all the features of BradySoft Standard, but in a networked configuration. Available in versions for 5 to 50 users.

► **COMPATIBLE BRADY SYSTEMS WITH BRADYSOFT™ 8 LABEL DESIGN SOFTWARE**



MVP Series



Wraptor™



1244/1344 Series



TLS PC Link™ Thermal Labeling System



X-Plus Series



PAM 3000



Tagus Series

MarkWare™ Facility Identification Software

MARKWARE FACILITY IDENTIFICATION SOFTWARE SOFTWARE, SERVICES AND DATA COLLECTION



Part Number	Description
20700	MarkWare Software Kit
20711	Software and Laminating Kit

INDUSTRIAL SAFETY SYMBOLS LIBRARY

MarkWare's built-in library gives you ready access to over 1000!! high-quality, scalable safety symbols and industrial pictograms



COMPATIBLE BRADY SYSTEMS WITH MARKWARE™ FACILITY ID SOFTWARE



**Machines no longer available.*

MarkWare Software covers all your safety and facility identification needs in one powerful package.

- ▶ Use your PC to quickly design professional looking signs and labels
- ▶ Print directly to a Brady labeling system or most Windows® inkjet/laser printers
- ▶ Use preformatted templates provided for quick and easy label creation
- ▶ Or freely customize label layouts to your own specifications
- ▶ **2,000 chemical database** for creating OSHA Right-to-Know labels
- ▶ Import logos, photos and other graphics in **9** different file formats
- ▶ Create bar codes using **15** different symbologies
- ▶ Complete drawing toolkit (hot shapes, fill patterns, freeform lines, etc.)
- ▶ Link label contents to information stored in spreadsheets and databases
- ▶ Use any font on your PC (special pipemarkers font also included)
- ▶ User interface can be displayed in 12 languages, including Spanish

MARKWARE SYSTEM REQUIREMENTS

- ▶ PC running Windows® 98 SE, NT 4.0 SP6, 2000 or XP
- ▶ 486 DX / 33 MHz or better processor
- ▶ 32 MB RAM (128 MB recommended)
- ▶ 90 MB available hard disk space
- ▶ 256-color, 640 x 480 pixel or better display
- ▶ CD-ROM drive (for installing software)

PREFORMATTED SIGN AND LABEL TEMPLATES

MarkWare software provides templates for a broad range of industrial sign and label applications, including OSHA/ANSI safety signs, equipment labels, maintenance and quality control tags, pipemarkers, asset ID labels, DOT shipping placards, RTK chemical labels, and more!

1. Pick a template
2. Type in the legend
3. Select a sign header
4. You are ready to print



RIGHT-TO-KNOW CHEMICAL LABELING APPLICATION

MarkWare software contains a database covering 2,000 commonly used chemicals as a reference for creating OSHA RTK-compliant labels

1. Select a chemical
2. Review label information
3. Insert into NFPA format
4. Or Brady color bar format



RIGHT-TO-KNOW CHEMICAL LABELING APPLICATION

Pipe marker application makes creating ANSI/ASME-compliant pipe markers a snap

1. Select type of pipe marker
2. Select size and format
3. Enter text and arrows
4. Pipe marker is done



ChemLabel™ Hazardous Material Labeling Software



Brady's ChemLabel™ Software helps keep employees safe by ensuring properly labeled chemicals.

Poorly and inaccurately labeled chemicals and other dangerous materials represent potentially serious safety problems. Brady's new ChemLabel Hazardous Material Labeling Software will make it easy to create and print labels for hazardous substances.

Use anywhere chemicals are labeled!

ChemLabel Hazardous Material Labeling Software is an extremely useful tool for factories, hospitals, laboratories, or anywhere chemicals and other hazardous materials are used and stored.

▶ FEATURES

- ▶ On-screen wizards to guide you through the process of linking data from a chemical database to a label layout, ensuring that the chemical labels you need contain the right information
- ▶ The option to use the Genium Companion Database, containing over 2,000 commonly used chemicals, or your own chemical database
- ▶ A complete stock of pre-designed templates and a full range of editing/drawing tools, making it easy to print chemical labels in the exact layout desired
- ▶ A connection to Brady industrial printers and supplies, ensuring accuracy and durability
- ▶ An extensive online help system providing detailed information and instructions
- ▶ Patent No. 5823689

▶ SYSTEM REQUIREMENTS

- ▶ Pentium® processor
- ▶ Windows® 98 with Internet Explorer 5.01
- ▶ Windows® 2000 with Service Pack 6a
- ▶ Windows® XP
- ▶ 64 MB RAM
- ▶ 175 MB available hard disk space
- ▶ 16-bit or greater video card
- ▶ 800 x 600 pixel or better display
- ▶ CD-ROM drive (for installing software)

Part Number	Description
50987	ChemLabel Software



▶ COMPATIBLE BRADY SYSTEMS WITH CHEMLABEL™ HAZARDOUS MATERIAL LABELING SOFTWARE



GlobalMark™
Industrial Label Maker



PowerMark®
Sign and Label Maker



HandiMark®
Portable Label Maker



Labelizer® PLUS*
Industrial Labeling System



Versa Printer™*
Label and Sign Maker

**Machines no longer available.*

LabelMark™ V3 Labeling Software

LABELMARK V3 LABELING SOFTWARE SOFTWARE, SERVICES AND DATA COLLECTION



Part Number	Description
LM3	Full Version CD-ROM
LM3-UP	Upgrade Version CD-ROM
LM3-SITE	Site license

COMPATIBLE BRADY SYSTEMS WITH LABELMARK™ V3 LABELING SOFTWARE



MVP Series



Wraprotor™



1244/1344 Series



TLS PC Link™
Thermal Labeling System



X-Plus Series



PAM 3000



TLS 2200®
Thermal Labeling System



Tagus Series



NetDoc™
Network Documentation
and Cable Management
Software

Easy, efficient, cost-effective labeling!

This versatile label design software is written specifically for identification applications in the telecomm, electrical, laboratory and general industrial markets. LabelMark V3 is the logical solution for label design, editing and printing.

LabelMark V3 is **two** programs in one package, *LabelMark* is the standard application for "fixed-line" text-only labels, while *LabelMark Plus* includes all *LabelMark* features, as well as allowing you to add graphic images, bar codes, rectangles and lines anywhere on your labels.

STANDARD LABELMARK FEATURES

- ▶ Multi-label view for true WYSIWYG representation of label formats
- ▶ Simple text entry, formatting and editing
- ▶ Versatile serialization creation from simple to advanced
- ▶ Automatic legend repeat for quick wire marker label creation
- ▶ Data Import support including ASCII, ODBC and OLE DB
- ▶ Accommodates all Brady stock and custom formats
- ▶ Supports most WINDOWS® printer drivers and is compatible with Brady's TLS2200®, TLS PC Link™ portable printers and Wraprotor™ wire ID printer applicator
- ▶ Includes an image library of common electrical, datacomm and safety symbols
- ▶ Several common bar code symbologies available

NEW LABELMARK V3 FEATURES

- ▶ A date/time feature for easy insertion of date and/or time fields into the labels
- ▶ Improved and simplified serialization feature with a wizard that guides users through advanced serialization
- ▶ Simplified data importing for spreadsheets and ASCII text files. A wizard guides the user through the data import functions
- ▶ New label formatting and editing features for easier label creation
- ▶ Easy creation and editing of label templates
- ▶ Redesigned toolbars and menus for easy access to all program features
- ▶ Find and Replace feature for easy search and replacement of text in label files
- ▶ Pre-installed common industrial symbols and label part templates

► PRIMARY APPLICATIONS

- Wire and cable marking
- Terminal block marking
- Control panel and component marking
- Rating plate Identification
- Quality assurance labeling
- Voice and data equipment labeling
- Asset Identification
- 110 block marking
- Patch panel identification
- Conduit and voltage marking
- Cable tray identification
- Warehouse bin and shelf labeling
- Inventory control

► SYSTEM REQUIREMENTS

- Intel Pentium processor (minimum 66 MHz 486DX2)
- Windows® 98/2000/NT/XP
- Microsoft Internet Explorer 5.01
- 64 MB of RAM (minimum 16 MB)
- Hard Drive with at least 100 MB of free disk space
- CD-ROM Drive
- 16-bit or greater video display card
- 800 x 600 or greater monitor resolution

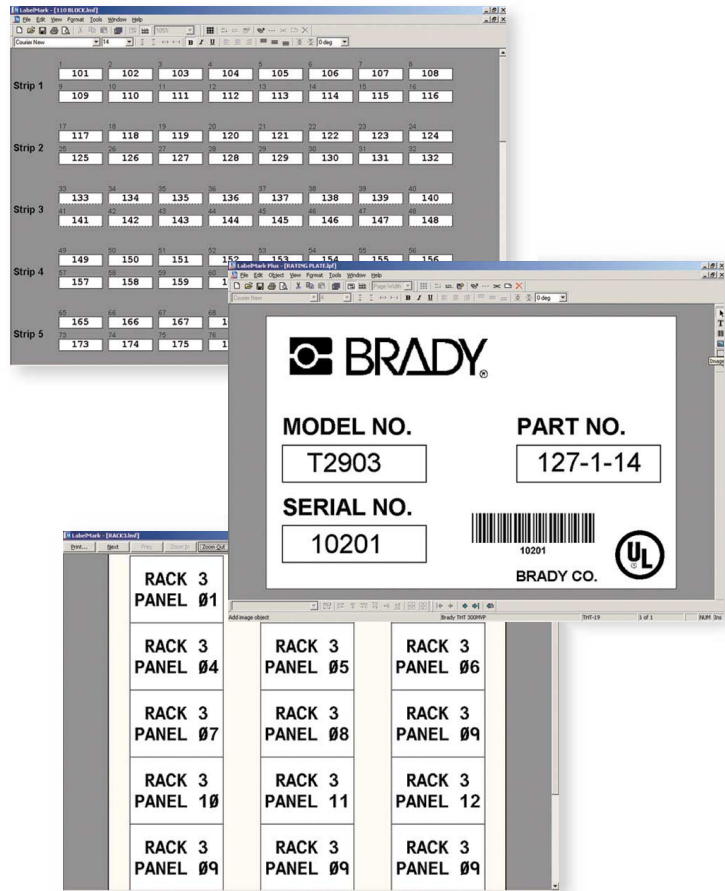

LabelMark™ Feature

LabelMark™ Feature	LabelMark™	LabelMark™ plus!
Simple Fixed Line Entry Mode	●	
Free-form label design		●
Multi-Label Display	●	●
Multi-Label Editing	●	●
Auto legend repeat (Wire marker Mode)	●	●
Serialization	●	●
Date/Time Stamp	●	●
ASCII, ODBC and OLE DB Import	●	●
Text block creation		●
Bar codes		●
Graphic Images		●
Lines and rectangles		●
Symbol Library		●

BOTH design applications included in every installation!

IdentiLab™ Laboratory Labeling Software



Part Number	Description
IDL	IdentiLab Version 1.0

► **COMPATIBLE BRADY SYSTEMS WITH IDENTILAB™ LABORATORY LABELING SOFTWARE**



MVP Series



X-Plus Series



1244/1344 Series



TLS PC Link™
Thermal Labeling System



TLS 2200®
Thermal Labeling System



IDXPERT™
Handheld Labeler

IMAGINE Legible, Professional Labels for Your Lab Samples in Just Minutes!

Create files, templates and more with the easy-to-use wizards in Brady's IdentiLab Laboratory Labeling Software.

The streamlined interface and hundreds of parts and graphics categorized by common lab applications makes creating legible, durable and accurate labels quick and easy.

- Easy-to-use wizards to create new files and templates
- Superscript and subscript characters
- Database import capabilities with refresh feature to ensure data integrity
- Automatic text formatting
- 2-D bar code support
- Multi-label data entry view
- Die cut and continuous label supplies
- Compatibility with a variety of Brady printers including LABXPERT™ Laboratory Labeling System, TLS 2200® Thermal Labeling System, TLS PC Link™ Thermal Labeling System, all Bradyprinter™ models, and all Windows-based printers.

► **SYSTEM REQUIREMENTS**

- Intel Pentium® processor
- Operating System
Windows® 98
Windows® 2000 with Service Pack 1
Windows® NT with Service Pack 6a
Windows® XP
- Microsoft Internet Explorer 5.01
- 64 MB of RAM (minimum 16 MB of RAM)
- 100 MB of available hard-disk space
- 16-bit or greater video display card
- 800 x 600 or greater monitor resolution
- CD-ROM Drive

► **PRINT YOUR LABELS IN THREE SIMPLE STEPS**

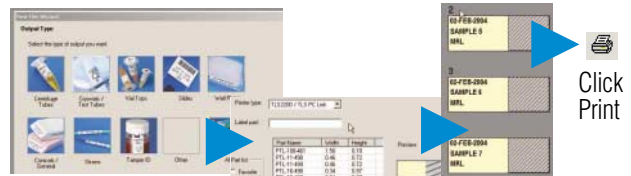

Step 1: Choose a category of label type to fit your Lab Application.

Step 2: Select your printer and the label part you have installed.

Step 3: Type your label text onto label preview to see your whole print job on screen!

IDENTILAB LABORATORY LABELING SOFTWARE SOFTWARE, SERVICES AND DATA COLLECTION

Surf on Signs™ Signs and Labels Database



Part Number	Description
98200	Surf on Signs CD

▶ CUSTOMIZE A TEMPLATE TO FIT YOUR EXACT NEEDS

- ▶ Simply print error-free signs, labels, pipe markers and tags using Surf on Signs
- ▶ Edit feature allows you to personalize and save the customized legend and have it available for future use
- ▶ Translate feature allows you to print messages in English, French, Spanish or bi-lingual formats

▶ COMPATIBLE BRADY SYSTEMS WITH SURF ON SIGNS™ SIGNS AND LABELS DATABASE



GlobalMark™
Industrial Label Maker



PowerMark®
Sign and Label Maker



HandiMark®
Portable Label Maker



Labelizer® PLUS*
Industrial Labeling System



Versa Printer™**
Label and Sign Maker

**Machines no longer available.*

With Surf on Signs CD, thousands of pre-made signs and labels are just a click away!

Need custom? No problem.

- ▶ Surf on Signs legends can be edited by you
- ▶ Custom legends you can create can be saved
- ▶ Follow the step-by-step directions
- ▶ Click and print

¿Habla español? ¡Si! ¡Si!

- ▶ All legends ready-to-print in Spanish*
- ▶ Also available in bi-lingual format

Parlez-vous Français? Oui! Oui!

- ▶ All legends ready-to-print in French*
- ▶ Also available in bi-lingual format

** Please note that the Surf-on-Signs CD does not feature translation software and will not translate custom legends; all French and Spanish legends are provided by Brady.*

Fast. Accurate. Amazing!

- ▶ Signs, labels, tags, pipe markers
- ▶ Thousands of stock legends
- ▶ High-speed search gives you instant access
- ▶ Ready-to-print format is error-free, hassle-free
- ▶ Just click and print

Step-by-Step Simplicity

- ▶ Connect your computer with your Brady printer
- ▶ Pop Surf-on-Signs CD into your computer drive
- ▶ Follow the step-by-step directions
- ▶ Just click and print

All in the format you need

- ▶ OSHA and ANSI format signs and tags
- ▶ ANSI-ASME pipe markers
- ▶ And more—all ready to print

▶ SYSTEM REQUIREMENTS

- ▶ Pentium Processor
- ▶ Windows® 98 with Internet Explorer 5.01
- ▶ Windows® 2000 with Service Pack 1
- ▶ Windows® NT with Service Pack 6a
- ▶ Windows® XP
- ▶ 64 MB RAM
- ▶ 50 MB available hard disk space
- ▶ 16-bit or greater video card
- ▶ 800 x 600 or greater monitor resolution
- ▶ CD-ROM drive

Lockout PRO™ Graphical Procedure Writing Software

LOCKOUT PRO SOFTWARE SOFTWARE, SERVICES AND DATA COLLECTION



- ▶ The use of easy-to-follow procedures helps to prevent mistakes and makes lockout tasks more efficient, reducing downtime
- ▶ Lockout PRO's intuitive user interface speeds you through the process of creating OSHA-compliant lockout procedures, tags and energy source labels
- ▶ Allows you to insert digital photos so employees can locate the correct control points quickly
- ▶ Standardized formats promote easy understanding and consistent use of prescribed safe work practices
- ▶ Also includes complete user-editable energy control policy and employee training tools

▶ ADDITIONAL FEATURES

- ▶ Display the user interface and create procedures in English, Spanish, French or Portugese
- ▶ Export procedures for use with CMMS and ERP systems
- ▶ Includes employee training tools and editable corporate LO/TO policy
- ▶ Automatically generate tags and labels for each energy source

▶ HIGHLIGHTED FEATURES

- A** Customize text fields to fit your needs
- B** Input digital photos and identify control points
- C** Customize icons and colors as desired
- D** Use predefined instructions or type in your own text

Part Number	Description
65918	Lockout PRO software
58981	Lockout PRO, BLS850 laminator ¹
90843	Lockout PRO, D-560 digital camera ²
58982	Lockout PRO, laminator and camera
58977	Lockout PRO Viewer ³
58978	Lockout PRO for Pocket PC

¹ Small, lightweight laminator works without electricity, heat or messy chemicals. Accommodates single or double-sided lamination of documents up to 8 inches wide.
² Compact Olympus® digital camera featuring a 3.2-megapixel CCD and 3x optical/10x seamless digital zoom lens.
³ Allows users to view and print Lockout Pro procedures, tags and labels, but not create or edit the procedures.
⁴ Data collection utility that allows procedures to be created on a handheld device running Microsoft's Pocket PC operating system. Used in conjunction with Lockout PRO or Lockout PRO Enterprise.

▶ SYSTEM REQUIREMENTS

- ▶ Windows NT4.0, 98se, ME, 2000 and XP operating systems
- ▶ Microsoft Internet Explorer 5.01 or higher
- ▶ Processor: 486 / 66 MHz (Pentium recommended)
- ▶ Disk space: 90 MB
- ▶ Screen resolution: 800 x 600 minimum (1024 x 768 preferred)

Lockout-Tagout Posted Procedure

LOCKOUT PRO™
Graphical Procedure Writing Software

ID#: CMA-2 430266	Facility: Camden Road	Location: Cell 135140
Created: 7/23/2003 12:19:45	Description: OSE 400-000 BTU Oven, Serial #56000	
Revised: 8/28/2003 4:51:17 PM		



2

Lockout Points

Note: This is an example of a Lockout Pro "Long Form". The long form lets you freely develop steps in the procedure and position photos next to the relevant instructions.

Lockout Application Process

1. Notify affected personnel. 2. Properly shut down machine. 3. Isolate all energy sources. 4. Apply lockout devices, locks, & tags. 5. Verify total de-energization of all sources.

Lockout Steps		
Step #	Action	Info
1.	This machine generates extremely high temperatures. Leave door open for at least one hour to allow for proper cooling.	The door is located on the West side of the machine.
2.	<p>The E-1 Disconnect is located on the Front side of the machine. Using a Lock, turn Disconnect to the off position and lock out at E-1.</p> <div style="text-align: center; font-size: 2em; font-weight: bold; border: 2px solid blue; border-radius: 50%; width: 40px; height: 40px; margin: 0 auto; display: flex; align-items: center; justify-content: center;">D</div>	<p>Main Control Panel</p> 
3.	<p>The G-1 Valve is located on the Top side of the machine. Using a Ball valve (1.25 - 3 inch) lockout device, turn Valve to the off position and lock out at G-1.</p> <div style="text-align: center; font-size: 2em; font-weight: bold; border: 2px solid blue; border-radius: 50%; width: 40px; height: 40px; margin: 0 auto; display: flex; align-items: center; justify-content: center;">C</div>	<p>Natural Gas Valve</p> 
4.	Confirm that energy has been isolated by attempting to restart at the main control panel.	Main control panel is located on the west side of the machine.

Lockout Removal Process

1. Ensure all tools and items have been removed. 2. Confirm that all employees are safely located. 3. Verify that controls are in neutral. 4. Remove lockout devices and reenergize machine. 5. Notify affected employees that servicing is completed.

Brady Lockout PRO™ Graphical Lockout Procedure Writing Software

Lockout PRO™ Graphical Procedure Writing Software

▶ LOCKOUT PRO OUTPUT OPTIONS

- ▶ Print procedures to plain paper using conventional inkjet/laser printers.
- ▶ For greater durability, print procedures, tags and energy source labels using Brady's GlobalMark™ Industrial Labeling System. Energy source labels can also be printed to Brady's HandiMark® Portable Label Maker.



Lockout PRO™ Enterprise

- ▶ Lockout PRO™ software for use on a server-based network
- ▶ Supports multi-user collaborative procedure management
- ▶ Allows employees to view and print procedures from a web browser
- ▶ Has built-in lockout activity tracking feature
- ▶ Provides online training and tracks trainees' results
- ▶ Allows users to save and access lockout procedures created in other programs
- ▶ Procedures can be created offline for automatic uploading when connected to the network

▶ ENTERPRISE LICENSE OPTIONS

- ▶ **Basic license:** Installs on a single server. Limited to 3 administrators who can create and edit procedures. Anyone with access to the server can view and print procedures.
- ▶ **Server license:** Installs on a single server. Unlimited administrators. Anyone with access to the server can view and print procedures.
- ▶ **Corporate license:** Installs on multiple servers. Unlimited administrators. Anyone with access to the server can view and print procedures.

Part Number	Description
58975	Basic License
58979	Additional administrator (adds 1 administrator to Basic License)
65919	Server License
58976	Corporate License

▶ COMPATIBLE BRADY SYSTEMS WITH LOCKOUT PRO™ GRAPHICAL PROCEDURE WRITING SOFTWARE







Selecting Your Tracking Software

SELECTING YOUR TRACKING SOFTWARE SOFTWARE, SERVICES AND DATA COLLECTION

	FacilityManager	Fireproof XT	Inspection Manager FLX
	 <p>FacilityManager is a paperless computerized maintenance management system (CMMS) software application that controls maintenance management operations. FacilityManager schedules routine inspections, schedules detailed work orders for preventive maintenance tasks, and performs unscheduled maintenance in the field.</p>	 <p>FireProof is a software management tool that tracks the inspection and maintenance activities for fire extinguishers, fire hoses, ladders, SCBAs, sprinkler systems, eyewash stations and showers, emergency exits, safety signs and more. FireProof streamlines equipment tracking by eliminating log sheets and manual data entry.</p>	 <p>Inspection Manager FLX was created specifically for Fire Departments that are overwhelmed by the data entry and record management associated with mandatory building inspections. The system streamlines time management and offers a simplified solution for helping fire houses fulfill their overall critical goal of fire prevention.</p>
	Page 214	Page 214	Page 214

GENERAL	FacilityManager	Fireproof XT	Inspection Manager FLX
Schedules, Tracks, and Documents Inspection and Maintenance Activities	X	X	
Documents Building and Fire Code Inspections	X		
Generates Work Orders on the PC	X	X	
Generates Work Orders / Tasks / Violations on the Handheld	X		X
Documents Violations			X
Track Horizontal, Backbone Cabling, Termination Hardware, Fire Stopping, Pathways, and Cable Splices			
Track Assets			
Customizable Fields	X	X	X
General Security (Password Protection)			X
Advanced Security (User Level Security)	X		
Type of Solution	Enterprise	Enterprise	Enterprise
Web-Enabled User Interface			
COMMON APPLICATIONS	FacilityManager	Fireproof XT	Inspection Manager FLX
PM Inspections, Including HVAC Equipment, Boilers, Chillers, Ovens	X		
Regulatory Inspections Including Fire Extinguishers and Life Safety Equipment (Eye Wash Stations, Hoses, Sprinklers, etc.)	X	X	
Manage Cabling, Network, Telephony, and Legacy Connections			
Manage High Dollar Assets, Locations of those Assets, and Cost			
Regulatory Medical Equipment Inspections Including Heart Monitors, Blood Warmers, etc.			
Manage Both Consumable Items and Rotating Stocks of Tools and Equipment			
Regulatory inspections on building on fire codes	X		X
Easily Manage a Stockroom of Consumable Items, Automatically Generate Stocking Reports, Cycle Count Product, etc..			
Petrochemical Inspections Including Valve Pressure Readings, pH Equipment, Calibrations	X		
General Inspections	X		
PRINTERS AND PRINTING	FacilityManager	Fireproof XT	Inspection Manager FLX
Internal Print Engine	X	X	X
Internal Label Creation Engine			
Internal Report Creation Engine	X	X	X
Support for Integration to LabelMark™			
TLS 2200® Periphial Printing (page 16)			
Standard Windows Print Drivers (Including BRADY Benchtop THT's)	X	X	X
GlobalMark™ Periphial Printing (page 75)			
PowerMark® Periphial Printing			
HandiMark® Periphial Printing (page 50)			
TLS PC Link™ Periphial Printing (page 16)			

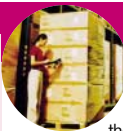
Selecting Your Tracking Software

 MEDI-MIZER MEDI-MIZER is a biomedical software management tool that provides a systematic, managerial approach to quality control and risk management. It effectively tracks Biomedical departments in hospitals worldwide, ranging in size from small community facilities to large universities and multi-health systems. Page 214	 Asset Track Asset Track is designed to track and manage assets such as computers, machinery, furniture, equipment, vehicles and more. Asset Track traces the receiving, storing and transfer of any type item. The system provides information on asset quantities and location of the asset within the building. Page 215	 Inventory Track Inventory Track is designed to record the movement of any type of inventory in a warehouse or stockroom. The system is used to track the receiving, storing and transferring of inventory items. Inventory Track provides information on inventory levels and the exact location of the inventory. Page 215	 Tool Track Tool Crib Managers use Tool Track to record movement of any type of tools or supplies in and out of a tool room. The system tracks the receiving, transfer, location and check-in/check-out of tools. Tool Track increases the accuracy of tool and supply inventory, eliminating the expense of replacing missing tools. Page 215	 NetDoc™ NetDoc is a network documentation and cable management software package that provides you with tools to manage, document and label your physical network. NetDoc allows you to document horizontal and backbone cables, assets, termination hardware, contacts, pathways, locations and more. Page 216
---	---	--	---	---

X				
X				
X				
				X
	X			X
X	X	X	X	X
X	X	X	X	X
Departmental	Departmental	Departmental	Departmental	Enterprise
				X
				X
X	X			
			X	
		X		
X	X	X	X	X
X	X	X	X	X
				X
X	X	X	X	X
				X

FacilityManager



FacilityManager is a paperless computerized maintenance management system designed to generate work orders and streamline preventive maintenance inspections using Palm Pilots® or Pocket PCs. FacilityManager plans, schedules and tracks maintenance management activities, ultimately reducing equipment down time and maximizing productivity. The system generates scheduled and unscheduled work orders from the field and generates routine preventive maintenance inspection routes. FacilityManager assists in proving compliance with OSHA, NFPA, JCAHO and other regulatory agencies.

Part Number	Description
98870	FacilityManager standard software
65164	SPT1800 palm hand-held device
65165	Single-slot device cradle with line cord and power supply

Part Number	Description
65172	Form-fitted holster
65174	SPT1800 spare battery

MEDI-MIZER™



MEDI-MIZER is a hand-held, mobile software solution that automates the tracking and inspecting of biomedical equipment. The system allows biomedical technicians to effectively and accurately monitor safety, performance, and preventative maintenance inspections. MEDI-MIZER combines the most innovative application tools with the latest in Palm Pilot® technology to offer an immense range of capabilities including outside service modules, field set-up options, extended reporting features and additional inspection functions. The system also assists in proving compliance with JCAHO and other internal or external regulatory agencies.

Part Number	Description
59586	MEDI-MIZER single-user software
59592	MobileTech for MEDI-MIZER device package, including SPT1550 palm hand-held device and cradle

FireProof™ XT



Using software and hand-held computers, FireProof XT streamlines the tracking and inspections of fire extinguishers, sprinkler systems, HVAC equipment, eye wash stations, SCBAs, back-up generators and more. Items requiring inspection are electronically transferred from a PC to the hand-held computer. The hand-held computer directs the inspector only to the equipment in need of inspection and prompts him through the tasks required to complete the inspection. FireProof XT ensures that no piece of equipment will ever be missed or forgotten. At the end of the shift, the collected data is transferred from the hand-held device to the PC, automatically updating records and creating historical files. The system ensures compliance with OSHA, NFPA, JCAHO and other internal or external regulatory agencies.

Part Number	Description
65477	FireProof XT standard software
65164	SPT1800 palm hand-held device
65165	Single-slot device cradle with line cord and power supply

Part Number	Description
65172	Form-fitted holster
65174	SPT1800 spare battery

Inspection Manager FLX



Spend less time manually recording NFPA violations and inputting data and more time completing building inspections. Inspection Manager FLX combines powerful software with the latest in Palm computing to completely automate annual building inspections. The system allows users to record violations electronically with a PDA, eliminating handwritten paperwork and time-consuming data entry. Inspection Manager FLX quickly and easily documents all building inspection activities, increasing productivity and efficiency in the field.

Part Number	Description
62960	Inspection Manager Standard - 1 user

Asset Track



Part Number	Description
59974	Asset Track software package includes: single-user software license, hand-held computer and transmitter, 50 pre-printed bar code labels, 1 year of hardware and software support and 2 hours of web-based training

Asset Track is a computerized system designed to track and manage assets. Software, hand-held computers and bar codes are used to track the receiving, storing, and transfer of any type of items. Asset Track provides information on asset quantities and location of the assets within the building. Asset Track eliminates manual paper tracking processes, while improving accuracy and productivity.

▶ ASSET TRACK MANAGES

- ▶ Computers and Related Equipment
- ▶ Machinery
- ▶ Furniture
- ▶ Equipment
- ▶ Vehicles
- ▶ And More!

▶ FEATURES

- ▶ Tracks last maintenance performed on assets
- ▶ Tracks all assets in stock for ease in reordering
- ▶ Provides instant information on asset location
- ▶ Provides a variety of reports listing all information about individual asset transactions
- ▶ Provides a user-friendly application making it easy to add and search for records
- ▶ Provides Security passwords allowing only authorized access to the database
- ▶ Provides the ability to sort data by key fields

Inventory Track



Part Number	Description
59975	Inventory Track software package includes: single-user software license, hand-held computer and transmitter, 50 pre-printed bar code labels, 1 year of hardware and software support and 2 hours of web-based training

Inventory Track is a computerized system used to record the movement of any type of inventory in a warehouse or stockroom. Software, hand-held computers and bar codes are used to track the issuing, restocking, and moving of inventory items. Inventory Track provides information on inventory levels and the location of the inventory. Inventory Track eliminates manual paper tracking processes, while improving accuracy and productivity.

▶ INVENTORY TRACK MANAGES

- ▶ Parts
- ▶ Supplies
- ▶ Consumables
- ▶ Raw Materials
- ▶ And More!

▶ FEATURES

- ▶ Tracks all inventory in stock for ease in reordering
- ▶ Provides a report listing all information about individual inventory transactions
- ▶ Provides audit trails tracking the complete activity history of an item
- ▶ Provides a user-friendly application making it easy to add and search for records
- ▶ Provides Security passwords allowing only authorized access to the database
- ▶ Provides the ability to sort data by key fields

Tool Track



Part Number	Description
59995	Tool Track software package includes: single-user software license, hand-held computer and transmitter, 50 pre-printed bar code labels, 1 year of hardware and software support and 2 hours of web-based training

Tool Track is a computerized system used to record the movement of any type of tools or supplies in and out of a tool room. Tool Crib Managers use software, hand-held computers and bar codes to track the receiving, movement, location and check-in/check-out tools. Tool Track improves accuracy in managing tool inventory and eliminates the expense of replacing lost tools.

▶ TOOL TRACK

- ▶ Time and date stamps each transaction
- ▶ Identifies the individual using the tool
- ▶ Tracks supply quantities

▶ FEATURES

- ▶ Tracks last maintenance performed on tools
- ▶ Tracks all tools and supplies in stock for ease in reordering
- ▶ Provides a variety of reports listing all information about individual tool transactions
- ▶ Provides a user-friendly application making it easy to add, log and search for records
- ▶ Provides Security passwords allowing only authorized access to the database
- ▶ Provides the ability to sort data by key fields

NetDoc™ Network Documentation and Cable Management Software

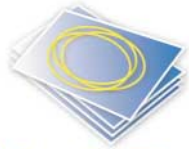

NetDoc™
network documentation

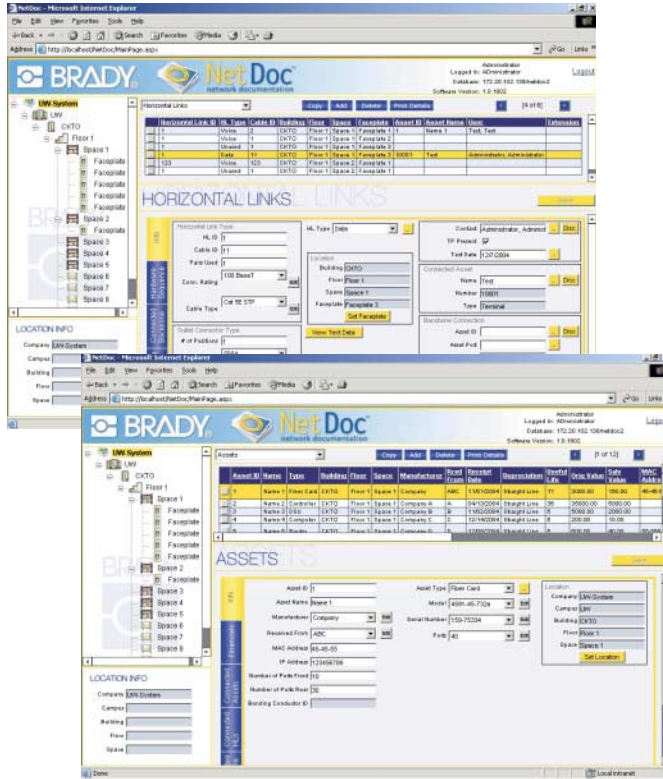

Managing your physical network just got easier.

NetDoc is a network documentation and cable management software package that provides you with tools to manage, document and label your physical network. NetDoc allows you to document horizontal and backbone cables, assets, termination hardware, contacts, pathways, locations, and more.

NetDoc is a web-enabled solution that provides complete ANSI/TIA/EIA606-A documentation and labeling compliance. NetDoc's seamless integration with Brady's Labelmark label design software gives you a complete documentation and labeling solution to help increase productivity, reduce costs, and improve user services.

► BENEFITS

- Save time locating and correcting network issues
- Reduce network downtime and provide better internal support
- More efficient use of internal and external resources
- Better planning for new projects, future growth, changes, and additions
- Save time spent on physical audits
- Simplify the management of the physical network
- Seamless integration with Labelmark eliminates the need to manually reenter data to generate labels.
- Save time building your CMS database by using NetDoc's Excel import tool, wizards, and copy features
- Generate detailed reports

NETDOC SOFTWARE SOFTWARE, SERVICES AND DATA COLLECTION

Part Number	Description
ND-1User	NetDoc Single User License Package
ND-5User	NetDoc 5 User License Package

NetDoc™ Network Documentation and Cable Management Software



► APPLICATION FEATURES

- Web-enabled solution
- Log-in security
- Full ANSI/TIA/EAI 606A compliance
- Documentation wizards
- Seamless link with LabelMark™ software
- Spreadsheet import tool
- Multi-view and multi-task capability
- Import data from testers
- User and date stamping on all notes
- Customize fields
- Attachment capabilities
- Track horizontal and backbone cabling, termination hardware, assets, contacts, fire stopping, pathways, cable splices, and more

► DETAIL VIEWS

BACKBONE CABLES

Cable ID	Panel/Module	Source Termination	Source Port / Strand	Destination Termination	Destination Port / Strand	Color 1	Color 2	Status	Notes
Cable 1	1	D-CORPFI1A	1	D-CORPFI1A	1			Used	
Cable 2	2	D-CORPFI2A	2	D-CORPFI2A	2			Used	
Cable 3	3	D-CORPFI3A	3	D-CORPFI3A	3			Used	
Cable 4	4	D-CORPFI4A	4	D-CORPFI4A	4			Used	
Cable 5	5	D-CORPFI5A	5	D-CORPFI5A	5			Used	
Cable 6	6	D-CORPFI6A	6	D-CORPFI6A	6			Used	
Cable 7	7	D-CORPFI7A	7	D-CORPFI7A	7			Used	
Cable 8	8	D-CORPFI8A	8	D-CORPFI8A	8			Used	
Cable 9	9	D-CORPFI9A	9	D-CORPFI9A	9			Used	

View source and destination for each strand of your backbone cable.

TERMINATION HARDWARE

Panel/Module	Cable Type	Cable ID	Backbone Pairs/Strands	Status	Notes
1	Horizontal Link	AD1	1	Used	
2	Horizontal Link	AD2	1	Used	
3	Horizontal Link	AD3	1	Used	
4	Horizontal Link	AD4	1	Used	
5	Horizontal Link	AD5	1	Used	
6	Horizontal Link	AD6	1	Used	
7	Horizontal Link	AD7	1	Used	
8	Horizontal Link	AD8	1	Used	
9	Horizontal Link	AD9	1	Used	
10	Horizontal Link	FDU2B1	1	Used	

View the ports and connections to all your termination hardware.



LabelMark™ V3 Labeling Software is included in NetDoc.





NetDoc features wizards that assist in creating multiple copies of items containing the same default information. Create thousands of assets, horizontal and backbone cables, and hardware at the same time.

Transfer identifier information seamlessly to Labelmark Label Design Software to generate your labels.

SOFTWARE, SERVICES AND DATA COLLECTION NETDOC SOFTWARE

Selecting Your Tracking / Automation Hardware

SELECTING YOUR TRACKING / AUTOMATION HARDWARE SOFTWARE, SERVICES AND DATA COLLECTION

	BCL	Powerscan	Code Reader 1	Code Reader 2
	<p>The Bar Code Laser (BCL) scanner offers great performance at a very affordable price. With a high first pass read rate and the best speed-to-read of any scanner in its class, the BCL Scanner speeds data entry and it's 33 cm / 13" depth-of-field with standard UPC labels extends the user's working range.</p>			
	<p>The PowerScan family of handheld laser bar code scanners has been specifically designed from the ground up to meet the demands of the industrial user. In this tough environment, the right tool makes all the difference. With cabled and cordless options available; the PowerScan has the ability to meet the most demanding applications.</p>			
	<p>In many industries, size is an extremely important commodity. In these problem situations, Code Reader 1 holds the answer. Built specifically for 2D applications; the compact design is ideal for cluttered lab benches, desks, and testing areas.</p>			
	<p>CR2 is a revolutionary new, bar code reader. Developed to be the first universal reader, no other single device performs as many functions. With batch, cabled and cordless options available coupled with the ability to update the unit as standards and applications evolve.. the Code Reader 2 is the perfect solution for enterprise wide installations.</p>			
	Page 219	Page 219	Page 219	Page 220

FEATURES	BCL	Powerscan	Code Reader 1	Code Reader 2
Standard Linear Bar Code Support (Code 39, Code 128, etc.)	X	X		X
2D Bar Code Support 9 (Datamatrix, PDF417, QR CODE, etc..)			X	X
Min. Bar Code Size (Mill Width)	5 Mil	7 Mil / *3 Mil	7 Mil	3 Mil Linear 5 Mil 2D
OS Compatibility	Windows® / Mac	Windows / Mac	Windows	Windows
PDA Support (Pocket PC Devices)				Bluetooth enabled PDA's ONLY
Resistance to Windblown Rain and Dust (Certified to IP54 standards)		X		
External Triggering (I.e: Trigger from PLC or Industrial PC)				X
Support for Basic Data Control (Adding CR, LF, TAB, before or after scan)	X	X	X	X
Support for Advanced Data Control (Data Parsing, Logic Equations, etc.)				X
Bar Code Grading Capability				1 - 100 Readability Grade
Field Upgradeable				X
Cordless Options		X		X
Interface Options	PS/2 Wedge (Default) USB	PS/2 Wedge (Default) USB Serial	PS/2 Wedge (Default) Serial	USB (default) PS/2 Serial
Common Accessories	Stand	Battery (for cordless)	None	Stand, Battery (for cordless)
Applications / Special Properties	Entry level scanner best used for basic data entry, inventory, commercial applications	Industrial class scanner best used for shipping, receiving and WIP applications in harsh environments	Electronics, lab, small identification applications, very small, lightweight reader, not meant for harsh environments	Developed to fit into almost any application, electronics, lab, WIP, shipping, receiving, UID initiatives, basic data entry, etc.

* high density unit only



► **BAR CODE LASER (BCL)**

Part Number	Description
BCL-STARTER-KIT	Scanner and keyboard (PS/2) wedge cable
BCL-SCANNER-STAND	Accessory; hands free stand
BCL-USB-CABLE	Accessory; USB cable

- Easy to use
- Quick and easy install
- High first pass read rate and the best speed-to-read of any scanner in its class
- Reads bar codes up to 2 feet away
- Works with existing software (BradySoft™, LabelMark™, MarkWare™, etc.)
- Lightweight and ergonomic for maximum comfort and productivity
- Built to stand up to abuse
- Use the laser in hands-free mode to automate your process (accessory stand required)



► **POWERSCAN™ RF (CORDLESS)**

Part Number	Description
PSCRF-SD-SCANNER	Scanner, PS-2 wedge capable, battery
PSCRF-HD-SCANNER	Scanner, PS-2 wedge capable, battery
PSCRF-232-PS2-BASE	PS-2 / RS-232 capable base station
PSCRF-BATTERY	Battery pack only
PSCRF-BASE-PS2-CBL	PS-2 wedge cable

► **POWERSCAN™**

Part Number	Description
PWSC-SD-PS2-KIT	Standard range, PS/2 keyboard wedge
PWSC-SD-USB-KIT	Standard range, USB keyboard wedge
PWSC-HD-USB-KIT	High density, USB keyboard wedge

- Industrial class rugged scanner
- Cordless scanner option for ease of use
- Works with existing software (BradySoft™, LabelMark™, MarkWare™, etc.)
- Base station able to support multiple scanners
- 150 foot range
- High density, long range and extra long range units available
- Sealed to IP54 standards, able to withstand windblown rain and dust
- Built to stand up to abuse



► **CODE READER 1**

Part Number	Description
CRHD300-PS2	High Density Scanner w/ integrated wedge cable
CRHD300-RS232	High Density Scanner w/ integrated RS-232 cable
CRHD300-PCMCIA	High Density Scanner w/ integrated PCMCIA Card

- Lightweight and compact
- Perfect for Electronics and Lab Markets, or anywhere that compact size is critical
- Works with existing software (BradySoft™, LabelMark™, MarkWare™, etc.)
- Able to read ultra high density 2D bar codes
- All in one design, no possibility for losing parts
- Unique, ergonomic design

Code Reader 2.0 (CR2) Scanner



With its unique dual path optical system, 1.3 million pixel CMOS sensor –the same optical power used in digital cameras – and the industry's most powerful 400MHz processor by AMD, the Code Reader 2.0 platform offers a system that supports:

- ▶ The ability to read both low density/large and high density/small linear and 2D bar code
- ▶ An open system platform to easily add the latest bar code standard or symbology electronically, avoiding the need to upgrade or replace hardware
- ▶ High-speed, multi-directional decoding to capture data from virtually any angle or position
- ▶ One platform with multiple configurations including Cabled, Batch or Cordless
- ▶ An investment that will meet growth and changing needs through a variety of accessories to allow for application-specific configuration changes

Installing the Code Reader is as easy. Simply insert the plug-and-play interface into any Windows based PC and it's ready to capture data. The data will populate fields in any active application. Products of this type will easily work in conjunction with existing peripherals (such as keyboard and mouse). Code Reader is compatible with the following BRADY software: BradySoft, LabelMark, TISCOR Asset Tracking, SAP and more.

Part Number	Description
CR2-USB-HAND-KIT	Basic unit in hand format with USB cable
CR2-PS2-HAND-KIT	Basic unit in hand format with PS2 cable
CR2-USB-GUN-KIT	Basic unit in gun format with USB cable
CR2-PS2-GUN-KIT	Basic unit in gun format with PS2 cable
CR2-STORE-GUN-KIT	Basic unit in gun format with battery and USB cable
CR2-CORDLESS-KIT1	Cordless bundle - cordless unit in gun format with Bluetooth PS/2 wedge receiver



Hand Format



Gun Format

▶ ACCESSORIES

Part Number	Description
CR2-BATCHRGE-US	Charger
CR2-BATTERY1	Spare battery
CR2-RS232-PWR-KIT	RS-232 cable
CR2-BTMODEM-PS2KIT	Bluetooth receiver
CR2-GUN-HANDLE	Detachable handle



Code Reader 2.0 in Hand Format

Code Reader 2.0 (CR2) Scanner

▶ AVAILABLE CONFIGURATIONS

Code Reader 2.0 comes in three different configurations, giving you more choices and options to meet your scanning needs.

Cabled (Basic)

Plug-and-play interface. Available with USB (standard), PS2 or RS232 interfaces. All cables use rugged automatic locking adapters that allow users to change cables while preventing inadvertent disconnections.

Batch (Basic + Battery)

Cabled and Store and Forward capability in one unit. Simply detach scanner from computer, capture data remotely and reconnect to computer. When reconnected, the scanner will automatically download data to the active application. Features 1300 milliamp lithium-ion battery with 4000-scan lifespan, plus 8 hours of standby time. When connected via the included USB cable, the unit operates as a standard keyboard wedge.

Cordless (Basic + Internal Radio)

Cabled, Batch and Cordless capability configured in this unit. Incorporates class 1 Bluetooth radio with 300' operating range to communicate seamlessly with desktop PCs, laptops, printers and PDAs. When operating in a cordless configuration, the battery life reduces to a 3000-scan lifespan. Coupled with our Bluetooth Wedge Modem, the Code Reader will send live data back to an active application.

▶ COMMON APPLICATIONS

Ensure compliance by randomly checking that your bar codes read after application to the finished product. The Batch configuration is typically recommended for this type of application.

Verify the quality of a printed bar code to score/grade the image.

The Code Reader is able to score and bar code to determine readability from 1/worst to 10/best, with the score identified following the data.

Automate an existing process such as WIP, MRP, ERP, LIMS, Inventory Management or Label Creation.

For a general automation project, the Cabled or Cordless configuration is recommended based on preference.

▶ THE CODE READER 2.0 ADVANTAGE

- ▶ Three different configurations to choose from
- ▶ Unique dual-path optical system
- ▶ High resolution imager
- ▶ Field upgradeable

▶ HARDWARE CHARACTERISTICS

Interface Type	USB (standard), RS-232, PS2, Bluetooth Class 1 Radio
Rotational Tolerance	180°
Target Beam	Class 2 Visible Laser Diode at 630nm
Ambient Light	Total darkness to 96,800 lux (full strength)
Shock	Withstands multiple drops of 6.56 feet (2 meters) to concrete
Decode Capabilities	MaxiCode, PDF417, Datamatrix, QR Code, MicroPDF417, GoCode, UCC Composite, Aztec Code, Code 39, Code 128, UPC/EAN/JAN, I2of5, Codabar, Code 93, UCC RSS, POSTNET, PLANET, Japanese Post, Australia Post, Royal Mail RM4SCC, KIX code
Field of View	Near: 21.5° horizontal by 16.2° vertical Far: 22.9° horizontal by 11.6° vertical
Focal Point	Near: 21.5° horizontal by 16.2° vertical Far: 22.9° horizontal by 11.6° vertical
Optical resolution	Near: 1024 x 640 Far: 1024 x 640
Additional Capabilities	Vibration on Good Read
Read Range	Min: 5 Mil Datamatrix / 3 Mil UPC Max: 20 Mil Datamatrix / 12 Mil UPC

Intelligently scan one bar code out of many on a heavily populated form or label.

All versions of the Code Reader include advanced capabilities to easily discriminate by bar code type or data within a specific bar code.

Manipulate data prior to passing to host application, including truncate, append, add tabs and returns, etc.

With the Code Reader, common control characters can be added by scanning a few simple codes. Advanced scripting language may be needed for complex data manipulation.

Custom and Specialty Labels

Brady Custom Labels	223
Order Information / Form	227
Write-On Labels	228
Labeling Pens	232
Equipment Labels	232
Conduit and Voltage Markers	233
Tamperseal™	234
Water Indicating Labels	234
Static Awareness Labels	235
Inspection Arrows	237
QuikDots™ Markers	238
Circuit Board Solder Masks	238
Circuit Board Labels	239
Die-Cut Overlaminates	240
Circular Masks	240
Hot Stampers Consumables	241
Bulk Tubing	242
Brady Heat Gun	243
Custom Printed Sleeves	243
Precision Die-Cut Solutions	245
Brand Protection Solutions	247

In addition to over 5000 stock labels, Brady also offers custom labels designed to meet your specific needs. These labels are designed to your exact specifications -- color matches, materials, dimensions, and regulatory requirements -- for your specialized applications.

► INSTRUCTIONAL LABELING



Instructional labels, such as safety or warning statements, help prevent product misuse and reduce liability. Brady has labeling solutions for the most challenging environments -- outdoor environments, high temperatures, and tough to adhere to surfaces. With a wide assortment of labeling materials and printing processes, Brady has the answer for your instructional labeling needs.

► PRODUCT IDENTIFICATION



Brand identity is critical. Aesthetically appealing product identification labels are an important part of your product's image. Many times, product identification labels are printed by Brady with the common/static information (such as logos) as well as areas designed to allow you to print variable information (such as serial numbers, date codes or model numbers) on demand using a Brady thermal transfer printer. Brady provides custom product identification labels in a wide choice of labeling materials and printing processes that reflect the high quality image of your products.

Brady Custom Labels

► REGULATORY LABELING



Several safety organizations test and certify products to meet specific testing standards. Once a product is certified, the label on the product needs to represent the certification. In many cases, the label material will also be tested and certified. The testing assures the printed label is made from durable materials and will survive under typical use.

If a label needs specific certification, Brady makes the process faster, easier and less expensive. Brady has an extensive listing of label materials to meet various regulatory requirements.

Types of Certifications:

- **Underwriters Laboratories (UL)** - Recognized Components to UL969 Marking and Labeling Systems standard. Listing information can be found online at ul.com.
- **Canadian Standard Association (CSA)** - Accepted to C22.2 No. 015 Adhesive Labels standard and IAS US Requirement 4-88 Marking Systems (Gas) standard (formerly AGA). Listing information can be found online at directories.csa-international.org.
- **CE mark** - The CE mark is a European Union marking to indicate conformity with essential health and safety requirements. A label material by itself does not get CE approval, rather a complete piece of equipment receives the CE approval.

► MICRO-MINIATURE LABELING

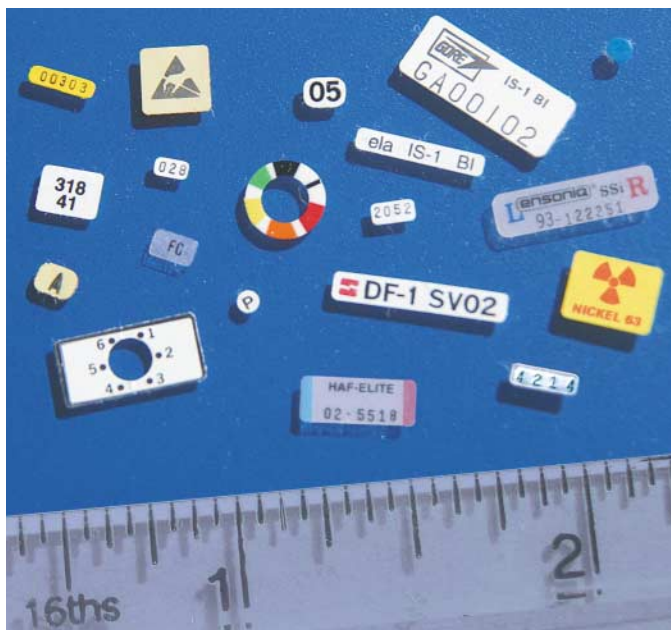

Brady's micro-miniature product line is ideal for labeling tiny parts and components. Brady provides micro-miniature labels for common applications such as small electronic items, heart pacemakers and hearing aids.

Micro-miniature label sizes can be ordered as small as 0.125" x 0.062" (3.20 mm x 1.57 mm) or even 0.062" (1.57 mm) diameter circle. These custom labels are offered in a variety of sizes and materials with multiple print colors and/or a clear over-lamination.

Brady provides common/static printed information such as logos and part numbers. Additionally, Brady offers variable printed information such as serialized identification numbers and letters.

► MULTI-LABEL SETS



Multi-label sets are common when various related products need an identification label. This label "kitting" approach saves excess time and expenses when compared to printing unique individual labels.

► BRADY BAR CODE PRINTING SERVICES



The expense for printers and other resources devoted to producing bar code labels are not necessary when you let Brady do the job for you. Brady offers:

- ▶ Compliance with EIA, AIAG, TCIF and UCC
- ▶ All popular linear and 2D bar code symbologies
- ▶ Full range of specialized labeling materials
- ▶ Printers matched to Brady's labeling materials
- ▶ Trained operators in bar code design
- ▶ In-process verification of all bar codes

Brady Custom Labels

▶ PRINT AND PROTECT — ON-DEMAND LAMINATION

PermaShield™* Labels for print on-demand

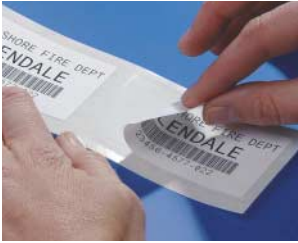

1. Standard label is printed with customized information. Laminate label remains on liner, under standard label.



2. Standard label is applied to surface. Laminate is removed from liner.



3. Laminate is applied over standard label.



4. Laminate label is ideal for applications where extra protection is needed.

* This product is sold in Japan under the Overlamine Labels name and not under the PermaShield name.

Tabbed Laminate Labels for hand printing



1. Tabbed laminate design is available in a variety of sizes and shapes.



2. Variable information is hand-written on label.



3. Liner is removed from tab and laminate is applied to label.

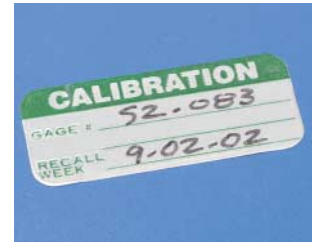

4. Final label is protected with laminate. Laminated label is ideal for applications where extra protection is needed.

Brady production runs 24 hours, so quick delivery and fast turnarounds are business as usual. If you have used this form before, simply photocopy it, fill in the form and **fax to: 1-800-292-2289.**

For more information on how to use the form and how Brady can customize a label to exactly fit your needs, **call: 1-888-272-3946** between 7:00 am and 6:00 pm CST.

CUSTOM QUOTE REQUEST

Please fill out ONE item per page



DISTRIBUTOR/CUSTOMER

Attention: _____
 Company Name: _____
 Address: _____

 City: _____ State _____ Zip _____
 Telephone: _____ - _____ - _____
 Fax No.: _____ - _____ - _____
 Reference: _____

PART INFORMATION

Quantity Requested: _____
 Annual Usage: _____
 Requirements: UL CSA Auto Dispense
 Corners: Square Radius Size _____
 Serialized: Yes No
 Yes No

PRINTED

Print Colors:
 1 _____ Positive Reverse
 2 _____ Positive Reverse
 3 _____ Positive Reverse
 4 _____ Positive Reverse
 Example of POSITIVE copy: **EXAMPLE**
 Example of REVERSE copy: **EXAMPLE**
 Background Color: _____

6555 W. Good Hope Road • P.O. Box 2131
 Milwaukee, Wisconsin 53201 U.S.A.

Reply Via: Phone Mail Fax

MATERIAL _____ overlaminate _____

SIZE _____ x _____
Left to Right Top to Bottom

Size of Write-on Area
 for Self Lamination Labels: _____ x _____
Left to Right Top to Bottom

PRINTER APPLICATION LABELS PUT-UP INFORMATION (CHECK 1)

THERMAL TRANSFER

Printer/Make/Model: _____
 Min. Web Width: _____ Max. Web Width: _____
 Max. Roll Dia.: _____ No. Across: _____
 Horz. Repeat: _____ Vert. Repeat: _____

LASER (LAT) **OTHER: INKJET (JET)**

Sheet Size: _____ x _____
 Labels per Sheet: _____

LS2000 **I.D. PRO** **TLS2200** **TLS PC Link**

BMXC **1/8" MACHINE** **1/16" MACHINE**

DOT MATRIX (PINFEED)

Web Width: _____ No Across: _____
 Spacing: 6 LPI 8 LPI 6 & 8 LPI
 Fanfold Roll Form
 Liner Perfed Horizontal Liner Perfed Vertical
 Type of Printer: _____

OTHER APPLICATION LABELS PUT-UP INFORMATION (CHECK 1)

LINER MOUNTED

Roll Form Individual Pieces Fan Fold

CARD MOUNTED

Card Size: _____ x _____
 Labels per Card: _____

MICRO MINI LABELS **SLEEVES HSA/PVC**

No. of Characters: _____

CUSTOM AND SPECIALTY PRODUCTS CUSTOM QUOTE FORM

Write-On Labels

- B-500 Vinyl Cloth (WO, WOS)**
- B-619 Polyester (WOX)**
- B-184 Aluminum Foil (WOAF)**

Ordering Information: When ordering, remember that stock number (WO-, WOS-, WOX-, or WOAF-) indicates material type. When ordering, please specify the total number of cards, not number of labels. To determine quantity of cards, divide the label total by the number of labels per card. Note: All WOAF aluminum foil labels have an aluminum, not a white background.

► QUALITY CONTROL

Label Dimensions	Labels Per Card	Card Dimensions
1.500" x 0.625" (38.10 mm x 15.88 mm)	14 labels	2.000" x 9.000" (50.80 mm x 228.60 mm)

REJECTED	DATE _____
REASON _____	
	BY _____

WO-1; WOX-1; WOAF-1
Red on White label

RETURN TO VENDOR	DATE _____
BY _____	
REASON: _____	

WO-4
Orange on White label

EXPERIMENT	
NO. _____	
DATE _____	BY _____

WO-22
Green on White label

CERTIFICATION
BY _____ DATE _____
DUE _____

WO-42
Black on White label

ACCEPTED
BY _____ DATE _____

WO-2; WOX-2; WOAF-2
Green on White label

RE-WORK	DATE _____
BY: _____	
REASON: _____	

WO-5; WOX-5
Black on Yellow label

SCRAPPED
DATE _____
INITIALS _____

WO-33
Orange on White label

INSPECTED BY:
DATE _____

WO-52
Black on White label

HOLD
FOR _____
UNTIL _____

WO-3
Black on Light Red label

HOLD FOR INSPECTION
BY _____ DATE _____
REASON: _____

WO-6
Blue on White label

TESTED
DATE _____
INITIALS _____

WO-38; WOX-38; WOAF-38
Green on White label

► BILINGUAL

Label Dimensions	Labels Per Card	Card Dimensions
1.500" x 0.625" (38.10 mm x 15.88 mm)	14 labels	2.000" x 9.000" (50.80 mm x 228.60 mm)

REJECTED	RECHAZADO
BY _____ DATE _____	POR _____ FECHA _____
REASON _____	RAZON _____

WOS-1
Red on White label

ACCEPTED	ACEPTADO
BY _____ DATE _____	POR _____ FECHA _____

WOS-2
Green on White label

CALIBRATION	CALIBRACION
BY _____ DATE _____	POR _____ FECHA _____
DUE _____	DEBIDO _____

WOS-10
Green on White label

TESTED	PROBADO
DATE _____	FECHA _____
INITIALS _____	INICIALES _____

WOS-38
Green on White label

CALIBRATED	CALIBRADO
BY _____ DATE _____	POR _____ FECHA _____
DUE _____	DEBIDO _____

WOS-41
Black on White label

► INVENTORY

Label Dimensions	Labels Per Card	Card Dimensions
1.500" x 0.625" (38.10 mm x 15.88 mm)	14 labels	2.000" x 9.000" (50.80 mm x 228.60 mm)

BATCH NO.	DATE

WO-7
Blue on White label

TOOL NO.	DEPT.

WO-39
Blue on White label

Label Dimensions	Labels Per Card	Card Dimensions
2.250" x 1.000" (57.15 mm x 25.40 mm)	9 labels	2.750" x 9.000" (69.85 mm x 228.60 mm)

INVENTORIED		DATE
STOCK NO.	_____	
COUNT	_____	
BY _____	CHECKED	_____

WO-26
Black on White label

Label Dimensions	Labels Per Card	Card Dimensions
1.500" x 0.500" (38.10 mm x 12.70 mm)	18 labels	2.000" x 9.000" (50.80 mm x 228.60 mm)

PROPERTY TAG
ASSET NO.

WOAF-29
Black on Aluminum label

STOCK NO.

WO-37
Green on White label

Label Dimensions	Labels Per Card	Card Dimensions
1.500" x 1.000" (38.10 mm x 25.40 mm)	9 labels	2.000" x 9.000" (50.80 mm x 228.60 mm)

INVENTORY	
NO	DATE
COUNT	BY

WO-27
Black on White label

SERIAL NO.

WO-34; WOAF-34
Black on White label

TOOL NO.	DEPT.

WOAF-39
Blue on Aluminum label

Write-On Labels

► MAINTENANCE

Label Dimensions	Labels Per Card	Card Dimensions
1.500" x 0.625" (38.10 mm x 15.80 mm)	14 labels	2.000" x 9.000" (50.80 mm x 228.60 mm)



WO-11
Black on Yellow label



WO-20; WOAF-20
Orange on White label



WO-13
Black on Yellow label



WO-23; WOX-23
Red on White label



WO-14; WOAF-14
Orange on White label



WO-31; WOX-31
Orange on White label



WO-17; WOAF-17
Black on White label



WO-43
Black on White label



WO-18; WOX-18; WOAF-18
Red on White label

Label Dimensions	Labels Per Card	Card Dimensions
2.250" x 1.500" (57.15 mm x 38.10 mm)	9 labels	2.750" x 9.000" (69.85 mm x 228.60 mm)

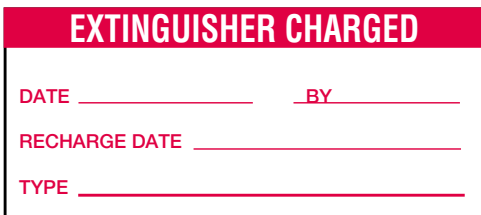

WO-25
Red on White label

Label Dimensions	Labels Per Card	Card Dimensions
2.250" x 1.500" (57.15 mm x 38.10 mm)	6 labels	2.750" x 9.000" (69.85 mm x 228.60 mm)

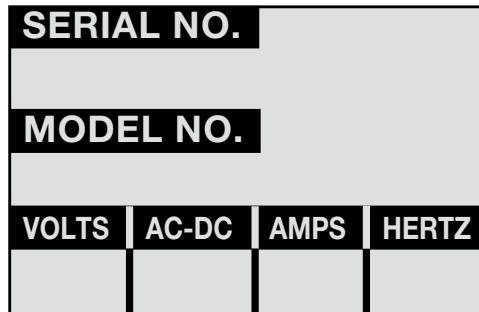

WOAF-36
Black on Aluminum label

► CALIBRATION

Label Dimensions	Labels Per Card	Card Dimensions
1.500" x 0.625" (38.10 mm x 15.80 mm)	14 labels	2.000" x 9.000" (50.50 mm x 228.60 mm)

CALIBRATION

BY _____ DATE _____

DUE _____

WO-10; WOX-10; WOAF-10
Green on White label

DO NOT USE
Until Tested & Calibrated

WO-51
Black on Yellow label

Label Dimensions	Labels Per Card	Card Dimensions
2.250" x 1.000" (57.15 mm x 25.40 mm)	9 labels	2.750" x 9.000" (69.85 mm x 228.60 mm)

CALIBRATION DATE _____

BY _____

DUE _____

WO-9; WOX-9
Green on White label
WOAF-9
Green on Aluminum label

CALIBRATED

BY _____ DATE _____

DUE _____

WO-41
Black on White label

CALIBRATION _____ DATE _____

BY _____ DUE _____

INST. I.D. _____

WO-64
Black on White label

Label Dimensions	Labels Per Card	Card Dimensions
1.500" x 0.500" (38.10 mm x 12.70 mm)	18 labels	2.000" x 9.000" (50.80 mm x 228.60 mm)

CALIBRATION
NOT REQUIRED

WO-53; WOAF-53
Red on White label

Label Dimensions	Labels Per Card	Card Dimensions
1.500" x 1.500" (38.10 mm x 12.70 mm)	6 labels	2.000" x 9.000" (50.80 mm x 228.60 mm)

CALIBRATED

EXPIRES _____

IDENT. NO. _____

ACCURACY _____

DATE CAL. _____

BY _____

DEPT. NO. _____

WO-63
Black on White label

Pre-Printed Five Packs
Five identical cards per package.

Aluminum Foil (B-184)
Vinyl Cloth (B-500)

B-500 Vinyl Cloth	B-184 Aluminum Foil	Labels Per Card	Pre-Printed Legend	Print Color	Label Size Inch (mm)	Card Size Inch (mm)
WO-10-VP		14	CALIBRATION	Green	1.500 x 0.625 (38.10 x 15.88)	2.000 x 9.000 (50.80 x 228.60)
WO-52-VP		14	INSPECTED BY	Black	1.500 x 0.625 (38.10 x 15.88)	2.000 x 9.000 (50.80 x 228.60)
	WOAF-29-VP	18	PROPERTY TAG	Black	1.500 x 0.500 (38.10 x 12.70)	2.000 x 9.000 (50.80 x 228.60)
	WOAF-34-VP	18	SERIAL NO.	Black	1.500 x 0.500 (38.10 x 12.70)	2.000 x 9.000 (50.80 x 228.60)
	WOAF-36-VP	6	SERIAL NO., MODEL NO. VOLTS AC-DC AMPS HERTZ	Black	2.250 x 1.500 (57.15 x 38.10)	2.750 x 9.000 (69.85 x 228.60)

CALIBRATION

BY _____ DATE _____

DUE _____

WO-10-VP
Green on White label

INSPECTED BY:

DATE _____

WO-52-VP
Black on White label

PROPERTY TAG

ASSET NO. _____

WOAF-29-VP
Black on Aluminum label

SERIAL NO.

WOAF-34-VP
Black on Aluminum label

SERIAL NO.

MODEL NO.

VOLTS	AC-DC	AMPS	HERTZ
_____	_____	_____	_____

WOAF-36-VP
Black on Aluminum label

Write-On Labels

▶ BLANK WRITE-ON CALIBRATION LABELS

Aluminum Foil (B-184)

Vinyl Cloth (B-500)

Polyester (B-619)

B-500 Vinyl Cloth	B-619 Polyester	B-184 Aluminum Foil	Labels Per Card	Label Size Inch (mm)	Card Size Inch (mm)
WO-16		WOAF-16	6	1.500 x 1.500 (38.10 x 38.10)	2.00 x 9.00 (50.80 x 228.60)
WO-19		WOAF-19	9	1.500 x 1.000 (38.10 x 25.40)	2.00 x 9.00 (50.80 x 228.60)
WO-24	WOX-24	WOAF-24	14	1.500 x 0.625 (38.10 x 15.88)	2.00 x 9.00 (50.80 x 228.60)
WO-30		WOAF-30	20	1.500 x 0.437 (38.10 x 11.10)	2.00 x 9.00 (50.80 x 228.60)
WO-35		WOAF-35	25	1.500 x 0.343 (38.10 x 8.71)	2.00 x 9.00 (50.80 x 228.60)
WO-46	WOX-46	WOAF-46	36	1.500 x 0.250 (38.10 x 6.35)	2.00 x 9.00 (50.80 x 228.60)
WO-47	WOX-47		72	0.750 x 0.250 (19.05 x 6.35)	2.00 x 9.00 (50.80 x 228.60)
WO-48			54	0.500 x 0.500 (12.70 x 12.70)	2.00 x 9.00 (50.80 x 228.60)
WO-49	WOX-49		18	1.500 x 0.500 (38.10 x 12.70)	2.00 x 9.00 (50.80 x 228.60)
WO-50			36	0.500 x 0.750 (12.70 x 19.05)	2.00 x 9.00 (50.80 x 228.60)
WO-54		WOAF-54	4	2.250 x 2.250 (57.15 x 57.15)	2.75 x 9.00 (69.85 x 228.60)
WO-55			5	2.250 x 1.750 (57.15 x 44.45)	2.75 x 9.00 (69.85 x 228.60)
WO-56		WOAF-56	6	2.250 x 1.500 (57.15 x 38.10)	2.75 x 9.00 (69.85 x 228.60)
WO-59		WOAF-59	9	2.250 x 1.000 (57.15 x 25.40)	2.75 x 9.00 (69.85 x 228.60)
WO-62		WOAF-62	12	2.250 x 0.750 (57.15 x 19.05)	2.75 x 9.00 (69.85 x 228.60)
WO-68		WOAF-68	18	2.250 x 0.500 (57.15 x 12.70)	2.75 x 9.00 (69.85 x 228.60)

Blank Five Packs

Five cards per package.

B-500 Vinyl Cloth	B-184 Aluminum Foil	Labels Per Card	Label Size Inch (mm)	Card Size Inch (mm)
WO-16-VP		6	1.500 x 1.500 (38.10 x 38.10)	2.000 x 9.000 (50.80 x 228.60)
WO-19-VP		9	1.500 x 1.000 (38.10 x 25.40)	2.000 x 9.000 (50.80 x 228.60)
WO-30-VP		20	1.500 x 0.437 (38.10 x 11.10)	2.000 x 9.000 (50.80 x 228.60)
WO-46-VP		36	1.500 x 0.250 (38.10 x 6.35)	2.000 x 9.000 (50.80 x 228.60)
WO-48-VP		54	0.500 x 0.500 (12.70 x 12.70)	2.000 x 9.000 (50.80 x 228.60)
WO-62-VP	WOAF-62-VP	12	2.250 x 0.750 (57.15 x 19.05)	2.000 x 9.000 (50.80 x 228.60)

Labeling Pens



Part Number	Quantity	Ink Color	Point Size
MP-1	12 per pkg. or single pens	Black	Fine Point
MP-2	12 per pkg. or single pens	Black	Ultra Fine Point

Brady's labeling pens use a quick drying, permanent ink. The ink is specially formulated to resist oil, solvents, abrasion and fading.

Equipment Labels





Brady equipment labels provide compliance to Article 110.16 of the 2002 National Electric Code.

Surface Printed White Polyester with Clear Polyester Overlaminat (B-302)

Part Number	Labels Per Package	Size Inch (mm)	Description
EL-1	5	3.500 x 5.000 (88.90 x 127.00)	Arc Flash Warning
EL-2	5	5.000 x 7.000 (127.00 x 177.80)	Arc Flash Warning
EL-3	5	5.000 x 7.000 (127.00 x 177.80)	Arc Flash Danger
EL-4	5	4.000 x 6.000 (101.60 x 152.40)	Arc Flash Orange
EL-5	5	3.500 x 5.000 (88.90 x 127.00)	Arc Flash Warning (write-on)

Color: Black on Orange
Standard Package: 25 Identical Cards

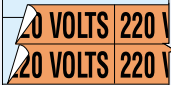
Vinyl Cloth (B-500)

Label Size Inch (mm)	Character Height Inch (mm)	
2.250 x 9.000 (57.15 x 228.60)	1.875 (47.63)	STYLE A (1 per Card) 
1.125 x 4.500 (28.58 x 114.30)	0.875 (22.23)	STYLE B (4 per Card) 
2.250 x 0.500 (57.15 x 12.70)	0.312 (7.92)	STYLE C (18 per Card) 

These bold, highly visible markers are designed specifically for identification on conduit, busways, circuit breakers, switches, fuse boxes and other electrical equipment. Markers have black characters printed on "Alert" orange background and are mounted on Brady Zip-Strip™ cards.

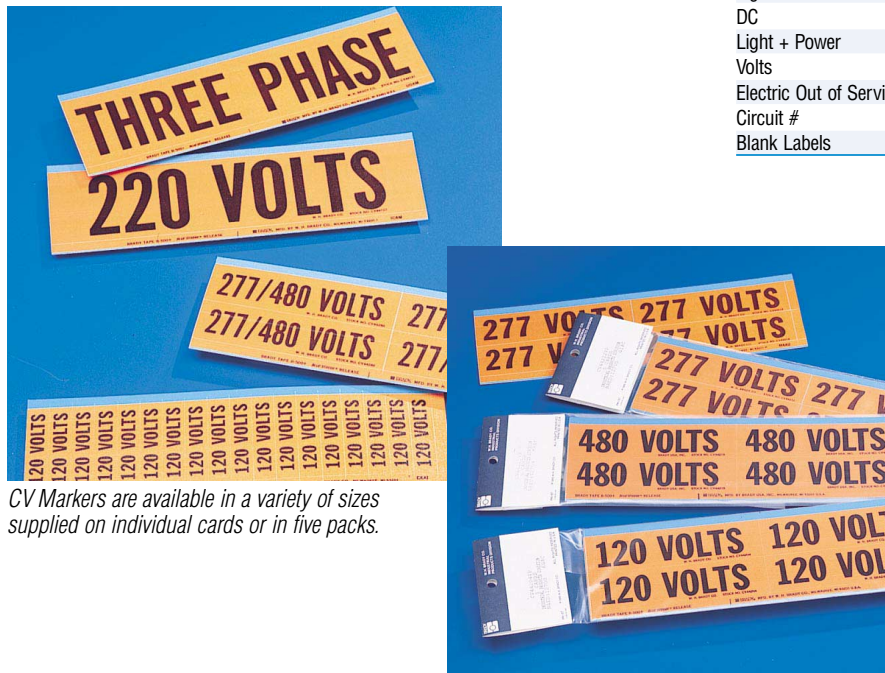

CV Markers are available in a variety of sizes supplied on individual cards or in five packs.

LEGEND	Part Number: STYLE A 1 Marker per Card	STYLE B 4 Markers per Card	STYLE C 18 Markers per Card
110 Volts	CV44101	CV44201	CV44301
115 Volts		CV44202	CV44302
120 Volts	CV44104	CV44204	CV44304
120/208 Volts	CV44159	CV44259	CV44359
208 Volts	CV44106	CV44206	CV44306
220 Volts	CV44107	CV44207	CV44307
230 Volts	CV44108	CV44208	CV44308
240 Volts	CV44110	CV44210	CV44310
250 Volts		CV44211	CV44311
277 Volt	CV44112	CV44212	
277/480 Volts	CV44160	CV44260	CV44360
440 Volts	CV44113	CV44213	CV44313
460 Volts	CV44114	CV44214	CV44314
480 Volts	CV44115	CV44215	CV44315
550 Volts		CV44216	
600 Volts	CV44118	CV44218	
2300 Volts	CV44134	CV44234	
2400 Volts	CV44121	CV44221	
4160 Volts	CV44122	CV44222	
4800 Volts	CV44124		
13,200 Volts	CV44151		
AC	CV44127	CV44227	CV44327
Emerg. Service			CV44328
Single Phase	CV44129	CV44229	CV44329
Three Phase	CV44131	CV44231	CV44331
Power	CV44132	CV44232	CV44332
On/Off		CV44256	
Lights	CV44133	CV44233	CV44333
DC	CV44138	CV44238	CV44338
Light + Power		CV44242	
Volts	CV44149		
Electric Out of Service	CV44250		
Circuit #		CV44255	
Blank Labels	CV44099	CV44100	

► FIVE PACKS

Each pack contains 5 identical cards.

LEGEND	Part Number: STYLE B 4 Markers per Card
120 Volts	CV44204VP
208 Volts	CV44206VP
220 Volts	CV44207VP
240 Volts	CV44210VP
277 Volts	CV44212VP
480 Volts	CV44215VP

Tamperseal™



Brady tamperseals come in 20-page pocket size books. Protect your warranty exposure by sealing access points with tamperseals.

- ▶ Designed for sealing access points, protecting adjustments and sealing enclosures
- ▶ Available in two shapes with three different legends
- ▶ Custom sizes, colors and shapes available

Vinyl Film (B-351)

Part Number	Labels Per Book	Label Size Inch (mm)	Legend
TL-PK-1	300	0.800 (20.32) Diameter	WARRANTY VOID IF SEAL IS BROKEN
TL-PK-2	300	0.800 (20.32) Diameter	CALIBRATION VOID IF SEAL IS BROKEN
TL-PK-3	300	0.800 (20.32) Diameter	VOID IF SEAL IS BROKEN
TL-PK-11	480	0.750 x 0.375 (19.05 x 9.53)	WARRANTY VOID IF SEAL IS BROKEN
TL-PK-12	480	0.750 x 0.375 (19.05 x 9.53)	CALIBRATION VOID IF SEAL IS BROKEN
TL-PK-13	480	0.750 x 0.375 (19.05 x 9.53)	VOID IF SEAL IS BROKEN



TL-PK-1, 2 and 3 are 0.800" (20.32 mm) diameter circles

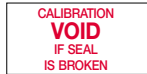

TL-PK-11, 12 and 13 are 0.750" x 0.375" (19.05 mm x 9.53 mm) rectangles

Water Indicating Labels



Before



After

- ▶ Provides clear evidence of water contact – turns from white to blue or red
- ▶ Color change becomes permanent, even after prolonged submersion in water
- ▶ Withstands heat and humidity aging without false indication
- ▶ Custom sizes and shapes available

Water Indicating Polyester / Paper (B-350, B-354)

Part Number	Pieces Per Roll	Label Size Inch (mm)	Web Width Inch (mm)	Color Change
THT-6-354-10*	10,000	1.500 x 0.750 (38.10 x 19.05)	3.350 (85.09)	Blue
THT-14-354-10*	10,000	0.600 x 0.200 (16.50 x 5.10)	2.950 (74.93)	Blue
THT-17-354-3*	3,000	2.000 x 1.000 (50.80 x 25.40)	2.125 (53.98)	Blue
THT-42-354-10*	10,000	1.000 x 0.187 (25.40 x 4.80)	1.200 (30.48)	Blue
THT-43-354-10*	10,000	1.250 x 0.250 (31.80 x 6.40)	1.450 (36.83)	Blue
THT-46-354-10*	10,000	0.750 x 0.250 (19.10 x 6.40)	0.950 (24.13)	Blue
THT-59-354-10*	10,000	1.000 x 0.500 (25.40 x 12.70)	1.200 (30.48)	Blue
THT-70-350-5*	5,000	0.250 x 0.250 (6.35 x 6.35)	2.370 (60.20)	Red
THT-70-350-20*	20,000	0.250 x 0.250 (6.35 x 6.35)	2.370 (60.20)	Red
THT-70-354-20*	20,000	0.250 x 0.250 (6.40 x 6.40)	2.370 (60.20)	Blue
THT-96-354-10*	10,000	0.500 x 0.275 (12.70 x 7.00)	2.500 (63.50)	Blue
THT-104-354-20*	20,000	0.315 x 0.177 (8.00 x 4.50)	2.390 (60.71)	Blue
WIL-1-350-5	5,000	0.160 Dia. (4.10)	2.000 (50.80)	Red
WIL-1-350-20	20,000	0.160 Dia. (4.10)	2.000 (50.80)	Red
WIL-1-354-20	20,000	0.160 Dia. (4.10)	2.000 (50.80)	Blue

* The THT parts are provided in a format and size acceptable for thermal transfer printing. See Thermal Transfer Labels section for more details.

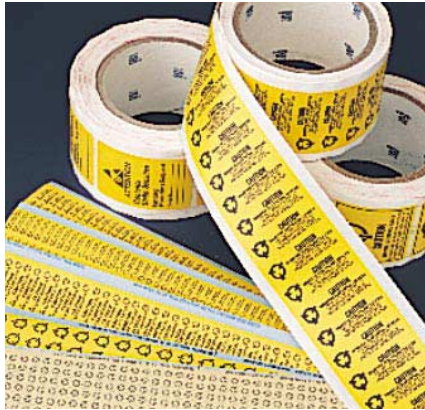

These roll-form and card-mounted black-on-yellow or black-on-orange labels alert handlers and users of electronic devices to the possibility of electrostatic damage. Symbols used conform to Military Standard 129J and EIA (Electronics Industries Association) Standard 471.

Labels designed for package marking are available in B-121 reusable paper, B-122 tamper-evident paper and B-500 reusable vinyl cloth. Labels designed for use directly on electronic devices are available in B-500 reusable vinyl cloth, B-619 polyester, and B-652 high-temperature polyimide.



SL-1



SL-2

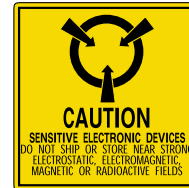

SL-3, SL-4, SL-5, SL-6



SL-7, SL-8

Roll-Form Labels:

For use on static shielding bags, other packaging and work-in-process totes.

Part Number	Material	Color	Labels Per Roll	Size Inch (mm)	Comments
SL-1	B-121	Black on Orange	500	1.812 x 2.500 (46.00 x 63.50)	For use on static shielding bags, WIP totes, etc; reusable; EIA Standard 471 symbol
SL-2	B-122	Black on Yellow	500	1.812 x 2.500 (49.20 x 63.50)	For use on static shielding bags, WIP totes, etc; not removable; EIA Standard 471 symbol
SL-3	B-121	Black on Yellow	500	2.000 x 2.000 (50.80 x 50.80)	For use on intermediate packaging; reusable; MIL Standard 129J symbol
SL-4	B-122	Black on Yellow	500	2.000 x 2.000 (50.80 x 50.80)	For use on intermediate packaging; not removable; MIL Standard 129J symbol
SL-5	B-121	Black on Yellow	250	4.000 x 4.000 (101.60 x 101.60)	For use on exterior packaging; reusable; MIL Standard 129J symbol
SL-6	B-122	Black on Yellow	250	4.000 x 4.000 (101.60 x 101.60)	For use on exterior packaging; not removable; MIL Standard 129J symbol
SL-7	B-121	Black on Yellow	1,000	2.000 x 0.625 (50.80 x 15.90)	For use on unit packages; reusable; MIL Standard 129J symbol
SL-8	B-122	Black on Yellow	1,000	2.000 x 0.625 (50.80 x 15.90)	For use on unit packages; not removable; MIL Standard 129J symbol



SL-9



SL-10



SL-11



SL-12



SL-13

Card-Mounted Labels:

For use on small packages and directly on electronic devices/components.

Part Number	Material	Color	Labels Per Roll	Size Inch (mm)	Comments
SL-9	B-500	Black on Yellow	90	0.650 x 0.200 (16.50 x 5.10)	For use on components and small packages; EIA 471 symbol; reusable
SL-10	B-500	Black on Yellow	90	0.650 x 0.200 (16.50 x 5.10)	For use on components and small packages; EIA 471 symbol; reusable
SL-11	B-652	Black on Amber	216	0.250 x 0.250 (6.35 x 6.35)	For bottom-side of PC boards or surface-mount applications; will withstand high temperatures and cleaning solvents; EIA 471 symbol
SL-12	B-619	Black on Yellow	36	1.250 x 0.250 (31.75 x 6.35)	For topside of PC boards; will withstand wave solder temperatures and cleaning solvents; MIL 129J and EIA 471 symbols
SL-13	B-500	Black on Yellow	54	0.500 x 0.500 (12.70 x 12.70)	For small packages; EIA 471 symbol; reusable

Static Awareness Labels



Fanfold SLDAT static awareness labels feature space for computer-printed or typewritten variable copy. Black-on-yellow labels are pre-printed with MIL 129J and EIA 471 static awareness symbols. Available in B-502 removable vinyl cloth and B-619 permanent polyester.

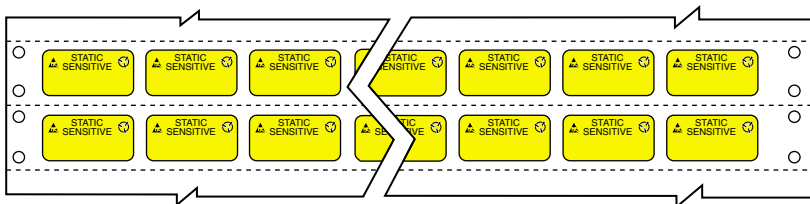

B-502

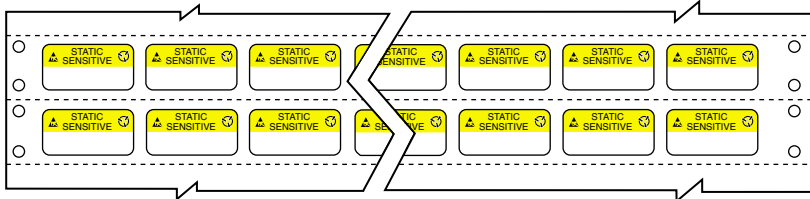

B-619

STATIC AWARENESS LABELS CUSTOM AND SPECIALTY PRODUCTS

Computer-Printable Labels:

For use on small packages and directly on electronic devices/components.

Part Number	Material	Package Color	Size Quantity	Printable Area Inch (mm)	Inch (mm)	Comments
SLDAT-1-502-10	B-502	Black on Yellow	10,000	1,000 x 0,500 (25,40 x 12,70)	1,000 x 0,270 (25,40 x 6,86)	Computer-printable; Removable, EPROM marking
SLDAT-1-619-10	B-619	Black on Yellow/White	10,000	1,000 x 0,500 (25,40 x 12,70)	1,000 x 0,270 (25,40 x 6,86)	Computer-printable; Permanent, PC board and component marking

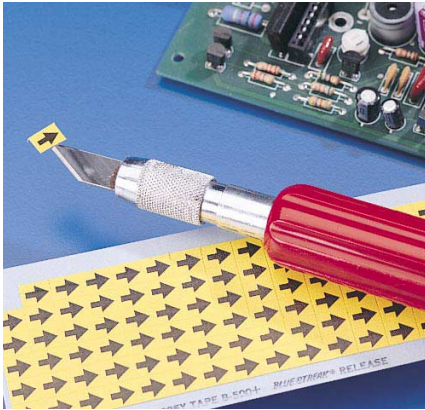

- ▶ Pin-point rework areas on printed circuit boards
- ▶ Select from five sizes in three different colors — Red, White and Yellow
- ▶ B-500 vinyl cloth material provides a tight bond, yet may be easily removed without leaving an adhesive residue

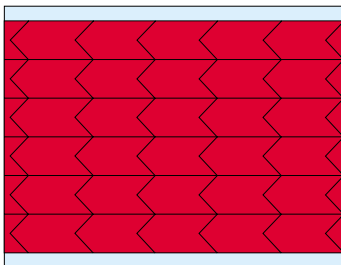

DIA - Die-Cut Inspection Arrow

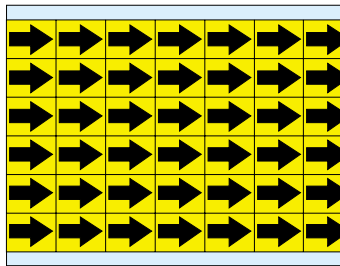

EIA - Electronic Inspection Arrow

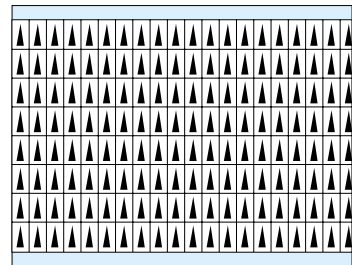

BIA - Board Inspection Arrow

Die-Cut Inspection Arrow

Part Number	Markers Per Card	Color	Size Inch (mm)
DIA-250-RD	564	Red	0.250 x 0.125 (6.35 x 3.18)
DIA-250-WT	564	White	0.250 x 0.125 (6.35 x 3.18)
DIA-250-YL	564	Yellow	0.250 x 0.125 (6.35 x 3.18)
DIA-375-RD	280	Red	0.375 x 0.187 (9.53 x 4.75)
DIA-375-WT	280	White	0.375 x 0.187 (9.53 x 4.75)
DIA-375-YL	280	Yellow	0.375 x 0.187 (9.53 x 4.75)
DIA-500-RD	138	Red	0.500 x 0.25 (12.70 x 6.35)
DIA-500-WT	138	White	0.500 x 0.25 (12.70 x 6.35)
DIA-500-YL	138	Yellow	0.500 x 0.25 (12.70 x 6.35)

Electronic Inspection Arrow

Part Number	Markers Per Card	Color	Size Inch (mm)
EIA-3025-RD	180	Red	0.300 x 0.250 (7.62 x 6.35)
EIA-3025-WT	180	White	0.300 x 0.250 (7.62 x 6.35)
EIA-3025-YL	180	Yellow	0.300 x 0.250 (7.62 x 6.35)

Board Inspection Arrow

Part Number	Markers Per Card	Color	Size Inch (mm)
BIA-RD	576	Red	0.125 x 0.190 (3.18 x 4.83)
BIA-WT	576	White	0.125 x 0.190 (3.18 x 4.83)
BIA-YL	576	Yellow	0.125 x 0.190 (3.18 x 4.83)

Quick-Dots™ Markers



- ▶ These 0.250" (6.35 mm) diameter adhesive dots come furnished on dispenser cards
- ▶ Available in 9 stock colors
- ▶ Custom sizes and shapes are available. Please consult factory for ordering information: **1-888-272-3946**

Vinyl (B-725)

Part Number	Color	Pieces Per Card
QD-25-BK	Black	144
QD-25-BL	Blue	144
QD-25-BR	Brown	144
QD-25-DG	Dark Green	144
QD-25-LG	Light Green	144
QD-25-OR	Orange	144
QD-25-RD	Red	144
QD-25-WT	White	144
QD-25-YL	Yellow	144

Circuit Board Solder Masks

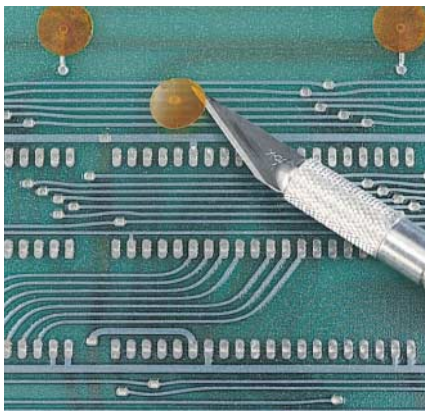

- ▶ Designed to withstand high-temperature applications where clean removal is necessary
- ▶ 1 mil polyimide film does not leave any adhesive residue

High-Temperature Removable Polyimide (B-654)

Part Number	Markers Per Card	Diameter of Circle Inch (mm)
CMKC-187	144	0.187 (4.75)
CMKC-250	144	0.235 (5.97)
CMKC-375	72	0.375 (9.53)
CMKC-500	54	0.500 (12.70)

CMKC-187 and CMKC-250 do not have zip strips.

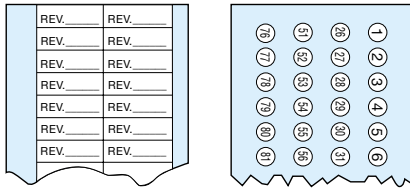

Write-On Revision Label Serialized Label

- ▶ Quickly identify revision levels on printed circuit boards
- ▶ Polyester materials withstand the high temperatures of flow solder, aqueous and washes
- ▶ Card-mounted carrier for fast, easy use

White Polyester (B-953)

Printable White Polyester (B-619)

Part Number	Labels Per Card	Cards Per Pkg.	Material	Size Inch (mm)	Legend	Color	Comments
WOX-57	72	25	B-619	0.250 x 0.750 (6.35 x 19.05)	REV	White	Write-on revision level labels
SER620A-1-100	100	25	B-953	0.156 Dia. (3.96)	1-100	White	Serialized labels for PC boards, components quality assurance, environmental testing
SER620A-101-200	100	25	B-953	0.156 Dia. (3.96)	101-200	White	Serialized labels for PC boards, components quality assurance, environmental testing
SER620A-201-300	100	25	B-953	0.156 Dia. (3.96)	201-300	White	Serialized labels for PC boards, components quality assurance, environmental testing
SER620A-301-400	100	25	B-953	0.156 Dia. (3.96)	301-400	White	Serialized labels for PC boards, components quality assurance, environmental testing
SER620A-401-500	100	25	B-953	0.156 Dia. (3.96)	401-500	White	Serialized labels for PC boards, components quality assurance, environmental testing
SER620A-501-600	100	25	B-953	0.156 Dia. (3.96)	501-600	White	Serialized labels for PC boards, components quality assurance, environmental testing
SER620A-601-700	100	25	B-953	0.156 Dia. (3.96)	601-700	White	Serialized labels for PC boards, components quality assurance, environmental testing
SER620A-701-800	100	25	B-953	0.156 Dia. (3.96)	701-800	White	Serialized labels for PC boards, components quality assurance, environmental testing
SER620A-801-900	100	25	B-953	0.156 Dia. (3.96)	801-900	White	Serialized labels for PC boards, components quality assurance, environmental testing
SER620A-901-999	100	25	B-953	0.156 Dia. (3.96)	901-999	White	Serialized labels for PC boards, components quality assurance, environmental testing
SER SERIALIZED LABELS - COMBINATION PACKS. 3 cards each, 1-500; 2 cards each, 501-999							
SER-620A-C-1-999	100	25	B-953	0.156 Dia. (3.96)	1-999	White	

Die-Cut Overlaminates

Die-cut overlaminate labels are sized to fit popular dot matrix, thermal transfer and laser label sizes. Liners are backslit for easy overlaminate removal.

Die-cut overlaminates are produced in B-103 clear polyester, a good general-purpose and PC board overlaminate that withstands high temperatures, dirt, oil and cleaning solvents while displaying excellent clarity. Packaged in rolls of 5,000 or 2,000 depending on label size.

General-Purpose Clear Polyester (B-103)

B-103 Clear Polyester	Pieces Per Roll	Label Size Inch (mm)	Label Repeat Inch (mm)
LAM-1-103	5,000	0.650 x 0.200 (16.51 x 5.08)	0.262 (6.65)
LAM-2-103	5,000	1.000 x 0.250 (25.40 x 6.35)	0.312 (7.92)
LAM-3-103	5,000	1.500 x 0.250 (38.10 x 6.35)	0.312 (7.92)
LAM-5-103	2,000	1.000 x 0.500 (25.40 x 12.70)	0.562 (14.27)
LAM-6-103	2,000	1.500 x 0.750 (38.10 x 19.05)	0.812 (20.62)
LAM-7-103	2,000	2.000 x 1.000 (50.80 x 25.40)	1.062 (26.97)



Overlaminates protect bar codes from dirt, oil and abrasion without affecting readability.

Circular Masks

► ROLL-FORM MASKS

Beige Creped Masking Tape (B-540)

Part Number	Masks Per Package	Diameter of Circle Inch (mm)
LMC-1000	1,000	1.000 (25.40)
LMC-1125	1,000	1.125 (28.58)
LMC-1250	1,000	1.250 (31.75)
LMC-1375	1,000	1.375 (34.93)
LMC-1500	1,000	1.500 (38.10)
LMC-2000	500	2.000 (50.80)
LMC-3000	500	3.000 (76.20)



Designed for production line applications, the masks are produced in roll form for convenient use.

► CARD-MOUNTED MASKS

Beige Creped Masking Tape (B-540)

Part Number	Masks Per Card	Diameter of Circle Inch (mm)
CMC-1250*	180	0.125 (3.18)
CMC-1875*	144	0.187 (4.75)
CMC-2500*	144	0.250 (6.35)
CMC-3125*	112	0.312 (7.92)
CMC-3750*	72	0.375 (9.53)
CMC-4375*	60	0.437 (11.10)
CMC-5000*	54	0.500 (12.70)
CMC-5625*	32	0.562 (14.27)
CMC-6250*	28	0.625 (15.88)
CMC-6875*	24	0.687 (17.45)
CMC-7500*	24	0.750 (19.05)
CMC-8125**	20	0.812 (20.62)
CMC-8750**	20	0.875 (22.23)
CMC-9375**	16	0.937 (23.80)
CMC-1000**	16	1.000 (25.40)

* CMC-1250 - CMC-7500 furnished on 2.000" x 9.000" (5.08 cm x 22.90 cm) dispenser cards.

**CMC-8125 - CMC-1000 furnished on 2.750" x 9.000" (6.99 cm x 22.90 cm) dispenser cards.

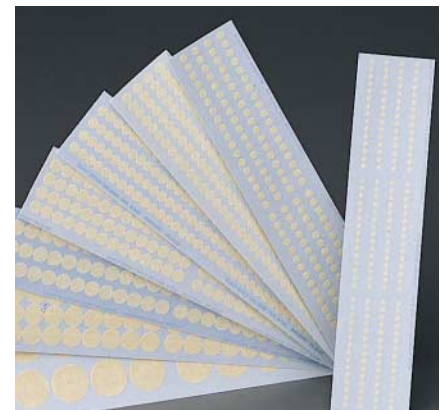

Mounted on Blue Streak dispenser cards for easy handling and quick application.

► MARKING FOILS



Marking foil is available in black, white and red to match a wide range of marking needs. Foil provides a highly legible, permanent legend on PVC insulations and sleeves, polyolefin heat-shrink sleeves, nylon (including THHN-THWN) and many Teflon® applications. Foil can be imprinted with low heat requirements. Feed advance is easily regulated to match wire diameter or material to be marked.

Foils for BradyMark™ Hot Stampers

Part Number	Applicable Model	Color	For Marking On	Size: Length	Width
BHMF-111-10 BHMF-121-10 BHMF-112-10	T5000	Black White Black	PVC Tubing Heat-Shrink Tubing	656 ft (200.00 m) 393 ft (120.00 m)	0.391 in (9.93 mm)
BHMF-111-30 BHMF-121-30 BHMF-131-30 BHMF-112-30 BHMF-122-30 BHMF-132-30	All models with 7 character wheels: H401-7 H402-7 H402A-7	Black White Red Black White Red	PVC Wire/ PVC Tubing THHN/THWN Wire Heat-Shrink Tubing	164 ft (50.80 m)	1.181 in (30.00 mm)
BHMF-111-50 BHMF-121-50 BHMF-131-50 BHMF-112-50 BHMF-122-50 BHMF-132-50	All models with 12 character wheels: H402-12 H402A-12	Black White Red Black White Red	PVC Wire/ PVC Tubing THHN/THWN Wire Heat-Shrink Tubing	164 ft (50.80 m)	1.986 in (50.44 mm)
BHMF-111-60 BHMF-121-60 BHMF-131-60 BHMF-112-60 BHMF-122-60 BHMF-132-60	All models with 18 character wheels: H402-18 H402A-18	Black White Red Black White Red	PVC Wire/ PVC Tubing THHN/THWN Wire Heat-Shrink Tubing	164 ft (50.80 m)	2.362 in (59.99 mm)

Teflon® is a registered trademark of DuPont.

► FOILS



Foil provides a highly legible, permanent legend on PVC insulations and sleeves, polyolefin heat-shrink sleeves, nylon (including THHN-THWN) and many Teflon® applications. Foil can be imprinted with low heat requirements. Feed advance is easily regulated to match wire diameter or material to be marked.

Foils for Porta-Mark™ Hot Stamper

Part Number	Color	Roll Length
PMF-1	Black	164 ft (50.80 m)
PMF-2	White	164 ft (50.80 m)
PMF-3	Red	164 ft (50.80 m)

Teflon® is a registered trademark of DuPont.

Bulk Tubing

► HEAT-SHRINK TUBING



Make your own custom sleeves with the BradyMark™ bench hot stamper. HSA and HSB tubing (see below) are available in stock sizes ranging from a minimum inside diameter (before shrinking) of 0.046 in to a maximum I.D. (before shrinking) of 1.000 in.

HSA Tubing. General purpose heat-shrinkable sleeving made of flexible, irradiated and flame-retardant polyolefin. Available in black or white.

HSB Tubing. Transparent sleeve recommended for encapsulating.

HSA and HSB Tubing

Part Number	Color	Part Number	Color	Package Feet (m)	ID, Before Shrinkage Minimum Inch (mm)	ID, After Shrinkage Minimum Inch (mm)
HSA-12	White or Black	HSB-12	Clear	100.00 (30.48)	0.046 (1.17)	0.023 (0.58)
HSA-16	White or Black	HSB-16	Clear	100.00 (30.48)	0.063 (1.60)	0.031 (0.80)
HSA-24	White or Black	HSB-24	Clear	100.00 (30.48)	0.093 (2.36)	0.046 (1.17)
HSA-32	White or Black	HSB-32	Clear	100.00 (30.48)	0.125 (3.18)	0.062 (1.60)
HSA-48	White or Black	HSB-48	Clear	100.00 (30.48)	0.187 (4.75)	0.093 (2.40)
HSA-64	White or Black	HSB-64	Clear	100.00 (30.48)	0.250 (6.35)	0.125 (3.18)
HSA-95	White or Black	HSB-95	Clear	100.00 (30.48)	0.375 (9.53)	0.187 (4.75)
HSA-127	White or Black	HSB-127	Clear	100.00 (30.48)	0.500 (12.70)	0.250 (6.35)
HSA-190	White or Black	HSB-190	Clear	100.00 (30.48)	0.750 (19.05)	0.375 (9.53)
HSA-254	White or Black	HSB-254	Clear	100.00 (30.48)	1.000 (25.40)	0.500 (12.70)
HSA-381	White only	HSB-381	Clear	100.00 (30.48)	1.500 (38.10)	0.750 (19.05)
HSA-508	White only	HSB-508	Clear	100.00 (30.48)	2.000 (50.80)	1.000 (25.40)

[†]For HSA tubing, add -WT or -BK to part number to specify color.

► PVC TUBING

Part Number	Package Feet (m)	Approx. Wire Gauge*	Minimum Inside Diameter Inch (mm)	Maximum Inside Diameter Inch (mm)	Part Number	Package Feet (m)	Approx. Wire Gauge*	Minimum Inside Diameter Inch (mm)	Maximum Inside Diameter Inch (mm)
PVC-24	100 (30.48)	34	0.020 (0.50)	0.027 (0.69)	PVC-4	100 (30.48)	10	0.204 (5.20)	0.224 (5.70)
PVC-16	100 (30.48)	22	0.051 (1.30)	0.061 (1.60)	PVC-3	100 (30.48)	8	0.229 (5.80)	0.249 (6.30)
PVC-15	100 (30.48)	22, 20	0.057 (1.40)	0.067 (1.70)	PVC-2	100 (30.48)	8	0.258 (6.60)	0.278 (7.10)
PVC-14	100 (30.48)	22, 20	0.064 (1.60)	0.072 (1.80)	PVC-1	100 (30.48)	8	0.289 (7.30)	0.311 (7.90)
PVC-13	100 (30.48)	20, 18	0.072 (1.80)	0.080 (2.00)	PVC-0	100 (30.48)	6	0.325 (8.30)	0.347 (8.80)
PVC-12	100 (30.48)	18, 16	0.081 (2.10)	0.089 (2.30)	PVC-312	100 (30.48)	6	0.310 (7.90)	0.332 (8.40)
PVC-11	100 (30.48)	18, 16	0.091 (2.30)	0.101 (2.60)	PVC-375	100 (30.48)	4, 6	0.375 (9.50)	0.399 (10.10)
PVC-10	100 (30.48) 500 (152.40)**	18, 16	0.102 (2.60)	0.112 (2.80)	PVC-437	100 (30.48)	2	0.438 (11.10)	0.462 (11.70)
PVC-9	100 (30.48) 500 (152.40)**	18, 16	0.114 (2.90)	0.124 (3.10)	PVC-500	100 (30.48)	1	0.500 (12.70)	0.524 (13.30)
PVC-8	100 (30.48) 500 (152.40)**	14, 16	0.129 (3.30)	0.141 (3.60)	PVC-562	100 (30.48)	0	0.562 (14.30)	0.592 (15.00)
PVC-7	100 (30.48) 500 (152.40)**	14	0.144 (3.70)	0.158 (4.00)	PVC-625	100 (30.48)	000	0.625 (15.90)	0.655 (16.60)
PVC-6	100 (30.48) 500 (152.40)**	12	0.162 (4.10)	0.178 (4.50)	PVC-750	100 (30.48)	0000	0.750 (19.00)	0.786 (20.00)
PVC-5	100 (30.48) 500 (152.40)**	10	0.182 (4.60)	0.198 (5.00)					

**PVC-5-10 may be ordered in 500 ft spools by adding -500 to the end of the part number (ie. PVC-5-500).

*Wires of the same conductor gauge may have different outside diameters depending on the insulation material used.



The Brady Heat Gun provides fast, even shrinkage of BradySleeve™ and PermaSleeve™ markers or heat-shrinkable tubing. Deflector shield evenly distributes forced air heat (minimum temperature 500°F/260°C) around sleeves of up to 0.750 in diameter for uniform shrinkage. Sturdy base with rubber pad allows hands-off operation.

Part Number	Description
PMS-HG-1	Brady Heat Gun

BradySleeve heat-shrinkable markers conform tightly to the wire when heat is applied for a few seconds. The Brady Heat Gun facilitates BradySleeve wire marker application.

Custom Printed Sleeves

PVC POLYVINYLCHLORIDE SLEEVES



- ▶ Fast and easy to use... just slide them on. Fits over a wide range of wire sizes — from 0.020 in to 0.750 in.
- ▶ Excellent dielectric and tensile strength; highly resistant to adverse conditions

Size	Approx. Wire Gauge*	Minimum Inside Diameter Inch (mm)	Maximum Inside Diameter Inch (mm)	Wall Thickness Inch (mm)
PVC-14	22,20	0.064 (1.60)	0.072 (1.80)	0.016 ± 0.003 (0.410 ± 0.080)
PVC-13	20,18	0.072 (1.80)	0.080 (2.00)	0.016 ± 0.003 (0.410 ± 0.080)
PVC-12	18,16	0.081 (2.10)	0.089 (2.30)	0.016 ± 0.003 (0.410 ± 0.080)
PVC-11	18,16	0.091 (2.30)	0.101 (2.60)	0.016 ± 0.003 (0.410 ± 0.080)
PVC-10	18,16	0.102 (2.60)	0.112 (2.80)	0.016 ± 0.003 (0.410 ± 0.080)
PVC-9	18,16	0.114 (2.90)	0.124 (3.10)	0.020 ± 0.003 (0.500 ± 0.080)
PVC-8	14,16	0.129 (3.30)	0.141 (3.60)	0.020 ± 0.003 (0.500 ± 0.080)
PVC-7	14	0.144 (3.70)	0.158 (4.00)	0.020 ± 0.003 (0.500 ± 0.080)
PVC-6	12	0.162 (4.10)	0.178 (4.50)	0.020 ± 0.003 (0.500 ± 0.080)
PVC-5	10	0.182 (4.60)	0.198 (5.00)	0.020 ± 0.003 (0.500 ± 0.080)
PVC-4	10	0.204 (5.20)	0.224 (5.70)	0.020 ± 0.003 (0.500 ± 0.080)
PVC-3	8	0.229 (5.80)	0.249 (6.30)	0.020 ± 0.003 (0.500 ± 0.080)
PVC-2	8	0.258 (6.60)	0.278 (7.10)	0.020 ± 0.003 (0.500 ± 0.080)
PVC-1	8	0.289 (7.30)	0.311 (7.90)	0.020 ± 0.003 (0.500 ± 0.080)
PVC-0	6	0.325 (8.30)	0.347 (8.80)	0.020 ± 0.003 (0.500 ± 0.080)
PVC-312	6	0.310 (7.90)	0.332 (8.40)	0.025 ± 0.003 (0.640 ± 0.080)
PVC-375	4, 6	0.375 (9.50)	0.399 (10.10)	0.025 ± 0.003 (0.640 ± 0.080)
PVC-437	2	0.438 (11.10)	0.462 (11.70)	0.025 ± 0.003 (0.640 ± 0.080)
PVC-500	1	0.500 (12.70)	0.524 (13.30)	0.025 ± 0.003 (0.640 ± 0.080)
PVC-562	0	0.562 (14.30)	0.592 (15.00)	0.030 ± 0.003 (0.760 ± 0.080)
PVC-625	000	0.625 (15.90)	0.655 (16.60)	0.030 ± 0.003 (0.760 ± 0.080)
PVC-750	0000	0.750 (19.00)	0.786 (20.00)	0.035 ± 0.005 (0.890 ± 0.130)

*Based on National Electric Code insulation measurement of THHN wire.

Use this table for sizing. Consult factory for pricing and ordering information
 Custom - 5,000 piece minimum, 100 per legend

Custom Printed Sleeves

► HEAT-SHRINKABLE POLYOLEFIN SLEEVES

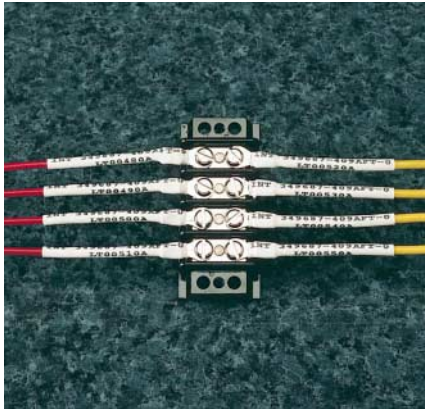

HSA: White or Black Polyolefin

HSB: Clear Polyolefin

Size:		Inside Diameter Before Shrinkage Minimum Inch (mm)	Inside Diameter After Shrinkage Minimum Inch (mm)	Wall Thickness After Shrinkage Normal Inch (mm)
HSA*	HSB			
HSA-16	HSB-16	0.063 (1.60)	0.031 (0.80)	0.020 (.508)
HSA-24	HSB-24	0.093 (2.40)	0.046 (1.20)	0.020 (.508)
HSA-32	HSB-32	0.125 (3.20)	0.062 (1.60)	0.020 (.508)
HSA-48	HSB-48	0.187 (4.80)	0.093 (2.40)	0.020 (.508)
HSA-64	HSB-64	0.250 (6.40)	0.125 (3.20)	0.025 (.635)
HSA-95	HSB-95	0.375 (9.50)	0.187 (4.80)	0.025 (.635)
HSA-127	HSB-127	0.500 (12.70)	0.250 (6.40)	0.025 (.635)
HSA-190	HSB-190	0.750 (19.00)	0.375 (9.00)	0.030 (.762)
HSA-254	HSB-254	1.000 (25.40)	0.500 (12.80)	0.035 (.889)
HSA-381	HSB-381	1.500 (38.10)	0.750 (19.00)	0.040 (1.016)
HSA-508	HSB-508	2.000 (50.80)	1.000 (25.40)	0.045 (1.143)
HSA-762	HSB-762	3.000 (76.20)	1.500 (38.20)	0.050 (1.27)
HSA-1016	HSB-1016	4.000 (101.60)	2.000 (50.80)	0.055 (1.397)

**Add -WT or -BK to the stock number for choice of tubing color.*

Use this table for sizing. Consult factory for pricing and ordering information

Custom - 2,500 piece minimum, 100 per legend

- Slip custom-printed sleeve over the wire and apply heat for a few seconds... a tight bond results
- Ideal as wire marker, insulator or splice – conforms to irregular shapes
- Type HSA is a general purpose heat-shrinkable sleeving made of flexible, irradiated, flame-retardant polyolefin. Available in White or Black
- Type HSB is a transparent version of the above. It is recommended for encapsulating, with Black or Red printing

Brady is the leading global manufacturer of high performance materials, precision die-cut components and automated assembly solutions, serving the electronics, telecommunications and automotive markets. We are proud to have **ID Technologies Pte. Ltd** of Singapore, **Brandon International** and **Balkhausen GmbH** as members of our team.

► CUSTOM ADHESIVES



Custom adhesives that hold mechanical parts in place (i.e. cell phone windows to phone housing).

► FOAM GASKETS



Foam gaskets seal an area off from outside contaminants – often used around LCD displays to prevent dust from entering between the LCD and display.

► FOAM PADS

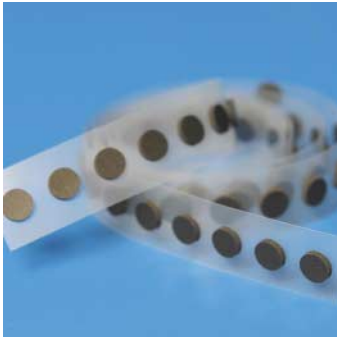

Pads used inside electronics to protect sensitive components from drop and vibration.

► EMI SHIELDS

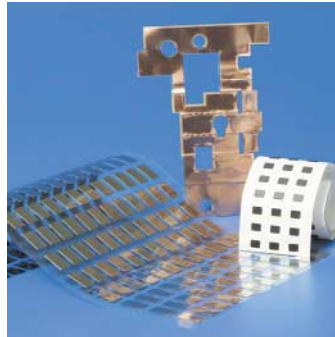

Prevents interference from either leakage coming from electrical signals inside of the product, or external signals interfering with the performance of the product.

► MESHES/FELTS



Usually used in conjunction with speakers or receivers used for voice transmission – keeps water, dust, and contamination from getting inside while still allowing for good sound quality for speakers and microphones

► LENS PROTECTS

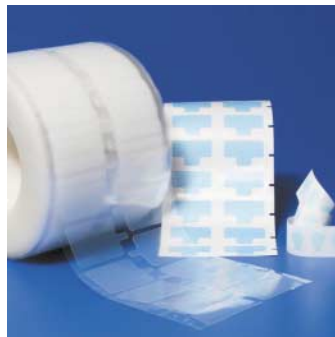

Clear films used to protect display windows from scratches during assembly and shipment. Protects can be printed with logos and/or product features.

Precision Die-Cut Solutions

▶ NAMEPLATES



After the electronics assembly has been integrated with your product housing, there is a very important process of brand identity and consumer awareness and safety labeling. Brady can provide a complete range of informative and decorative labels and nameplates. These products are tailored to meet the specific requirements for regulatory labeling or brand identity. Because of the highly visible nature of these products, Brady will go through extreme measures to ensure the highest print quality and registration. Our solutions include a wide variety of options including:

- ▶ Preprinted nameplates and labels
- ▶ Embossed and dome labels
- ▶ Rating plates
- ▶ Printed overlays
- ▶ In mold decorating inlays

▶ THERMAL INTERFACE MATERIALS AND ELECTRICAL INSULATORS

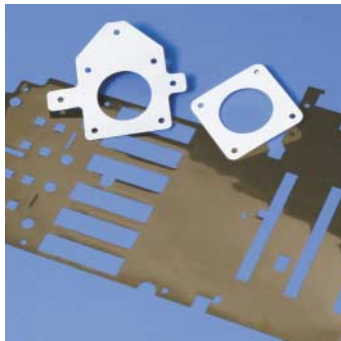

Insulators are used to prevent electrical short circuits in electronics. Thermal interface materials help you conduct heat away from heat generating electronic components such as transistors and microprocessors. Thermal interface materials include:

- ▶ Phase change
- ▶ Gap filler
- ▶ Thermal adhesives
- ▶ Thermal pads
- ▶ Non-silicone thermal pads
- ▶ Thermal insulators

▶ SEALS



Brady can work with you to develop products to work with your selected materials and applications. If you have a unique application, Brady scientists will go to work developing tapes, liners and adhesives to your exact specifications.

▶ AUTOMATED ASSEMBLY SOLUTIONS

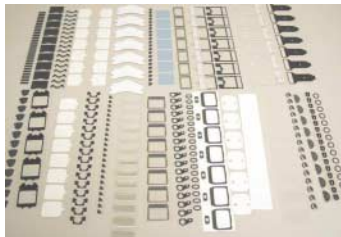

Die cuts engineered, manufactured, inspected and packaged by a die cut manufacturer that understands AccuPlace automation requirements.

- ▶ AP1515, AP3065, RM3065 and APAC™ machines at Brady facility
- ▶ Value add assembly capable of utilizing AccuPlace automation
- ▶ Automation engineering/support on-staff at Brady
- ▶ One point of contact for solution

**For detailed information and quotes call Customer Service
Phone: 1-800-356-9951 (M-F 7:00am - 5:00pm CST)
or visit us on the web at www.bradydiecut.com**

Brand Protection Solutions



The Brand Protection Solutions group provides products and systems to help owners of famous brands fight brand erosion from counterfeiting, product diversion, piracy, and tampering. This focused, dedicated team within Brady brings together all of Brady's many company resources and products to design solutions that meet the security needs of brand owners.



Brady's custom-engineered brand protection solutions result in one-of-a-kind products that are designed with the brand owner for their unique situation and may include varieties of technologies "layered together". These products are manufactured in secure locations and are managed using controlled Chain-of-Custody procedures to ensure strict controls of these secure materials.



Brady is listed in Business Ethics magazine's "Top 100 Best Corporate Citizens" for the last FIVE CONSECUTIVE YEARS. Brady's Brand Protection Solutions group was also among the first North American companies to be certified as a Class II security provider by NASPO - the North American Security Products Organization. A focus on integrity in our business, coupled with a strong security focus and our global presence, makes a strong partner for owners of global brands.

For more information, visit us at www.bradyid.com/brandprotection

Pre-Printed Wire Markers

Pre-Printed Wire Markers	
Materials Chart	249
Wire Marker Cards	250
Porta-Pack®	
Wire Marker Books	262
BradyPack® Wire Markers	266
Clip Sleeve™ Wire Markers	267
Omni-Grip™ Sleeve Markers	268

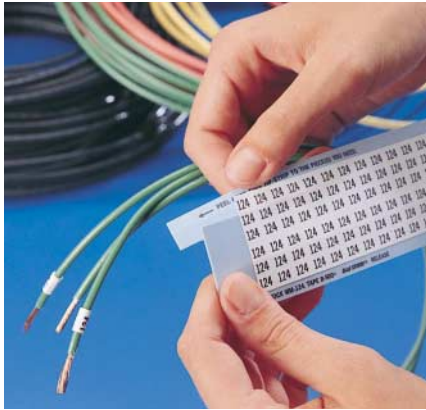

Brady's exclusive ZipStrip® release card lets you easily remove the markers you need, when you need them.

Type	Max. Service Temp. °F (°C)	Color	Finish	Use	Special Properties
ACETATE CLOTH					
B-12	221 (105)	White	Matte	Wire marker for varnish dip or baking cycles	Oil and heat resistant
ALUMINUM FOIL					
B-184	266 (130)	Silver	Matte	Permanent debossed marking	Heat, oil, solvent and abrasion resistant
OVERLAMINATED TEDLAR®					
B-605	260 (127)	White	Gloss	Machine tools; hostile environments	Heat, oil, solvent and abrasion resistant
POLYESTER					
B-11	266 (130)	White	Gloss	Roll-form wire marking; hostile environments	Heat, oil and solvent resistant
B-702	221 (105)	White	Gloss	Vinyl coated; machine tool labeling	Oil and mild solvent resistant; high adhesion
POLYOLEFIN					
B-319	221 (105)	White	Matte	Computer printable sleeve markers	Permanent; not heat shrinkable
B-321	221 (105)	White/Yellow	Matte	Computer printable sleeve markers	Permanent; heat shrinkable
VINYL					
B-292	150 (66)	White	Matte	Machine tool, flat ribbon, and wire marking	Conformable, durable; oil, water and mild solvent resistant
B-708	150 (66)	White	Gloss	Indoor/outdoor cable marking	Conformable, durable; oil, water and mild solvent resistant; self laminating
VINYL CLOTH					
B-500	180 (82)	White/Yellow	Matte	All-purpose marker	Moderate heat, oil and dirt resistance; high adhesion

Tedlar® is a registered trademark of DuPont.

Wire Marker Cards



PART NUMBER EXPLANATION:

Most Brady part numbers in this section follow the same two-part format:

The first code indicates the Brady product being referenced, the second code indicates the marker legend.

Numbers

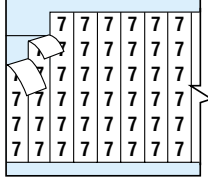

Higher Numbers

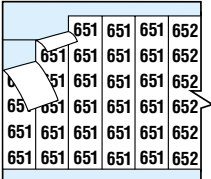

Mounted in groups of five identical groups per card.

LEGEND		B-500 Vinyl Cloth	B-702 Vinyl Film	B-605 Over-Laminated	B-184 Aluminum Foil	B-12 Acetate Cloth	Markers per Card	
							1.500" (38.10 mm)	0.750" (19.05 mm)
	0	WM-0	TWM-0	OLWM-0	AF-0	HH-0	36	72
	1	WM-1	TWM-1	OLWM-1	AF-1	HH-1	36	72
	2	WM-2	TWM-2	OLWM-2	AF-2	HH-2	36	72
	and so on thru	and so on thru	and so on thru	and so on thru	and so on thru	and so on thru		
	25	WM-25	TWM-25	OLWM-25	AF-25	HH-25	36	72
	26	WM-26	TWM-26	OLWM-26	AF-26		36	72
	and so on thru	and so on thru	and so on thru	and so on thru	and so on thru		36	72
	WM-99	TWM-99	OLWM-99	AF-50			25	50
	601 - 605	WM-601-605					25	50
	606 - 610	WM-606-610					25	50
	611 - 615	WM-611-615					25	50
	and so on thru	and so on thru						
	921 - 925	WM-921-925						

Consecutive Numbers

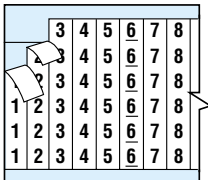

LEGEND		B-500 Vinyl Cloth	B-702 Vinyl Film	B-605 Over-Laminated	B-184 Aluminum Foil	B-12 Acetate Cloth	Quantity Each		Markers per Card	
							Number Per Card	1.500" (38.10 mm)	0.750" (19.05 mm)	1.500" (38.10 mm)
	1-33	WM-1-33	TWM-1-33	OLWM-1-33	AF-1-33	HH-1-33	1	2	33	66
	34-66	WM-34-66	TWM-34-66	OLWM-34-66	AF-34-66	HH-34-66	1	2	33	66
	67-99	WM-67-99	TWM-67-99	OLWM-67-99	AF-67-99	HH-67-99	1	2	33	66
	100-124	WM-100-124	TWM-100-124	OLWM-100-124	AF-100-124		1	2	25	50
	125-149	WM-125-149	TWM-125-149	OLWM-125-149	AF-125-149		1	2	25	50
	and so on thru	and so on thru	and so on thru	and so on thru	and so on thru					
	WM-1775-1799	TWM-375-399	OLWM-250-274	AF-250-274			1	2	25	50

Consecutive Numbers Repeated

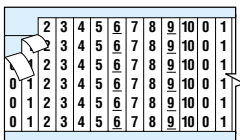

LEGEND		B-500 Vinyl Cloth	B-702 Vinyl Film	B-605 Over-Laminated	B-184 Aluminum Foil	Sequences per Card		Markers per Card	
						1.500" (38.10 mm)	0.750" (19.05 mm)	1.500" (38.10 mm)	0.750" (19.05 mm)
	1-3	WM-1-3	TWM-1-3		AF-1-3	12	24	36	72
	1-4	WM-1-4			AF-1-4	9	18	36	72
	1-5	WM-1-5				7	14	35	70
	1-6	WM-1-6				6	12	36	72
	1-8	WM-1-8				4	8	32	64
	1-9	WM-1-9			AF-1-9	4	8	36	72
	0-9	WM-0-9	TWM-0-9			3	6	30	60
	0-10	WM-0-10				3	6	33	66
	1-10	WM-1-10	TWM-1-10	OLWM-1-10	AF-1-10	3	6	30	60
	1-12	WM-1-12	TWM-1-12	OLWM-1-12	AF-1-12	3	6	36	72
	1-16	WM-1-16	TWM-1-16	OLWM-1-16	AF-1-16	2	4	32	64
	1-18	WM-1-18	TWM-1-18	OLWM-1-18	AF-1-18	2	4	36	64
	19-36	WM-19-36	TWM-19-36			2	4	36	72

Letters — Upper Case

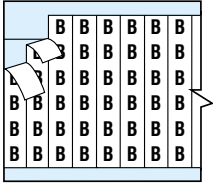

Lower Case

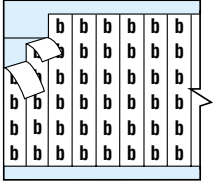

Consecutive Letters

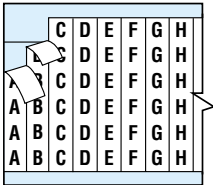

Consecutive Letters Repeated

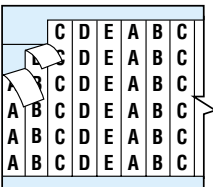

Terminal Markers

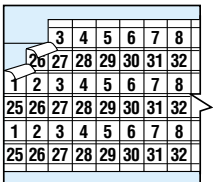

LEGEND	B-500 Vinyl Cloth	B-702 Vinyl Film	B-605 Over-Laminated	B-184 Aluminum Foil	B-12 Acetate Cloth	Markers per Card	
						1.500" (38.10 mm)	0.750" (19.05 mm)
A	WM-A	TWM-A	OLWM-A	AF-A	HH-A	36	72
B	WM-B	TWM-B	OLWM-B	AF-B	HH-B	36	72
C	WM-C	TWM-C	OLWM-C	AF-C	HH-C	36	72
and so on thru	and so on thru	and so on thru	and so on thru	and so on thru	and so on thru		
Z	WM-Z	TWM-Z	OLWM-Z	AF-Z	HH-Z	36	72
a	WM-A-SML					36	72
b	WM-B-SML					36	72
c	WM-C-SML					36	72
and so on thru	and so on thru						
z	WM-Z-SML					36	72
A-Z	WM-A-Z	TWM-A-Z	OLWM-A-Z	AF-A-Z		26	52
A-Z plus A-J	WM-A-Z, AJ					36	72
a-z	WM-A-Z-SML	TWM-A-Z-SML				26	52

LEGEND	B-500 Vinyl Cloth	B-702 Vinyl Film	Sequences Per Card		Markers per Card	
			1.500" (38.10 mm)	0.750" (19.05 mm)	1.500" (38.10 mm)	0.750" (19.05 mm)
A - E	WM-A-E	TWM-A-E	7	14	35	70
F - J	WM-F-J	TWM-F-J	7	14	35	70
K - O	WM-K-O	TWM-K-O	7	14	35	70
P - T	WM-P-T	TWM-P-T	7	14	35	70
U - Z	WM-U-Z	TWM-U-Z	7	14	35	70

LEGEND	Vinyl Cloth (B-500)		Markers per Card
	Part Number		0.312" x 0.187" (8.00 mm x 5.00 mm)
1 - 48	WM-1-48-TM		144
49 - 96	WM-49-96-TM		144
A - Z*	WM-A-Z-TM		144

*Terminal Markers have no "I" or "O"

Wire Marker Cards

Letters and Numbers

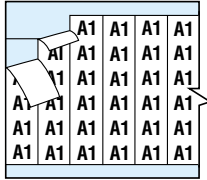

	B-500 Vinyl Cloth	B-702 Vinyl Film	B-605 Over- Laminated	B-184 Aluminum Foil	Markers per Card	
					1.500" (38.10 mm)	0.750" (19.05 mm)
A1	WM-A1	TWM-A1	OLWM-A1	AF-A1	36	72
A2	WM-A2	TWM-A2	OLWM-A2	AF-A2	36	72
A3	WM-A3				36	72
A4	WM-A4				36	72
A5	WM-A5				36	72
B1	WM-B1		OLWM-B1		36	72
B2	WM-B2		OLWM-B2		36	72
B3	WM-B3				36	72
B4	WM-B4				36	72
B5	WM-B5				36	72
C1	WM-C1		OLWM-C1		36	72
C2	WM-C2		OLWM-C2		36	72
C3	WM-C3				36	72
C4	WM-C4				36	72
C5	WM-C5				36	72
D1	WM-D1				36	72
D2	WM-D2				36	72
E1	WM-E1				36	72
E2	WM-E2				36	72
E3	WM-E3				36	72
E4	WM-E4				36	72
E5	WM-E5				36	72
F1	WM-F1	TWM-F1	OLWM-F1	AF-F1	36	72
F2	WM-F2	TWM-F2	OLWM-F2	AF-F2	36	72
F3	WM-F3				36	72
F4	WM-F4				36	72
G1	WM-G1				36	72
G2	WM-G2				36	72
G3	WM-G3				36	72
H1	WM-H1	TWM-H1	OLWM-H1	AF-H1	36	72
H2	WM-H2	TWM-H2	OLWM-H2	AF-H2	36	72
H3	WM-H3		OLWM-H3	AF-H3	36	72
H4	WM-H4		OLWM-H4	AF-H4	36	72
H5	WM-H5				36	72
J1	WM-J1				36	72
J2	WM-J2				36	72
J3	WM-J3				36	72
K1	WM-K1				36	72
K2	WM-K2				36	72
K3	WM-K3				36	72
L1	WM-L1	TWM-L1		AF-L1	36	72
L2	WM-L2	TWM-L2		AF-L2	36	72
L3	WM-L3	TWM-L3		AF-L3	36	72
L4	WM-L4				36	72
L5	WM-L5				36	72
M1	WM-M1	TWM-M1			33	66
M2	WM-M2	TWM-M2			33	66
M3	WM-M3				33	66
P1	WM-P1			AF-P1	36	72
P2	WM-P2			AF-P2	36	72
P3	WM-P3				36	72
P4	WM-P4				36	72
R1	WM-R1	TWM-R1			36	72
R2	WM-R2	TWM-R2			36	72
R3	WM-R3				36	72
R4	WM-R4				36	72
S1	WM-S1			AF-S1	36	72
S2	WM-S2			AF-S2	36	72
S3	WM-S3				36	72
S4	WM-S4				36	72
S5	WM-S5				36	72
T0				AF-T0	36	72
T1	WM-T1	TWM-T1	OLWM-T1	AF-T1	36	72
T2	WM-T2	TWM-T2	OLWM-T2	AF-T2	36	72
T3	WM-T3	TWM-T3	OLWM-T3	AF-T3	36	72
T4	WM-T4	TWM-T4	OLWM-T4	AF-T4	36	72
T5	WM-T5	TWM-T5		AF-T5	36	72
T6	WM-T6	TWM-T6		AF-T6	36	72
T7	WM-T7	TWM-T7			36	72
T8	WM-T8	TWM-T8			36	72
T9	WM-T9	TWM-T9			36	72
T10	WM-T10	TWM-T10			36	72
X1	WM-X1	TWM-X1	OLWM-X1	AF-X1	36	72
X2	WM-X2	TWM-X2	OLWM-X2	AF-X2	36	72
X3	WM-X3	TWM-X3	OLWM-X3	AF-X3	36	72
X4	WM-X4	TWM-X4	OLWM-X4	AF-X4	36	72
Y1	WM-Y1				36	72
Y2	WM-Y2				36	72
Y3	WM-Y3				36	72
Z1	WM-Z1				36	72
Z2	WM-Z2				36	72
Z3	WM-Z3				36	72

LETTERS AND NUMBERS PRE-PRINTED WIRE MARKERS

Consecutive Paired Numbers

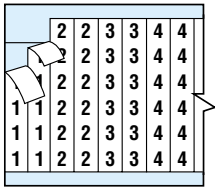

Vinyl Cloth (B-500)

LEGEND	Part Number	Pairs of Markers Per Card		Markers per Card	
		1.500" (38.10 mm)	0.750" (19.05 mm)	1.500" (38.10 mm)	0.750" (19.05 mm)
1-16	WM-1-16-DC	16	32	32	64
17-32	WM-17-32-DC	16	32	32	64
33-48	WM-33-48-DC	16	32	32	64
49-64	WM-49-64-DC	16	32	32	64
65-80	WM-65-80-DC	16	32	32	64
81-96	WM-81-96-DC	16	32	32	64

Consecutive Letters and Numbers Repeated

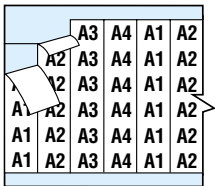

Vinyl Cloth (B-500)

LEGEND	Part Number	Sequences Per Card		Markers per Card	
		1.500" (38.10 mm)	0.750" (19.05 mm)	1.500" (38.10 mm)	0.750" (19.05 mm)
A1 - A4	WM-A1-A4	9	18	36	72
F1 - F4	WM-F1-F4	9	18	36	72
H1 - H4	WM-H1-H4	9	18	36	72
H1 - H9	WM-H1-H9	9	18	36	72
L1 - L4	WM-L1-L4	9	18	36	72
T1 - T4	WM-T1-T4	9	18	36	72
W1 - W4	WM-W1-W4	9	18	36	72
X1 - X4	WM-X1-X4	9	18	36	72

Suffix Numbers

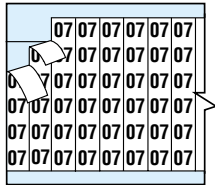

Vinyl Cloth (B-500)

LEGEND	Part Number	Markers per Card	
		1.500" (38.10 mm)	0.750" (19.05 mm)
00	WM-00-S	36	72
01	WM-01-S	36	72
and so on thru	and so on thru		
09	WM-09-S	36	72
00 - 09	WM-00-09-S	30	60

Note: Stock No. WM-00-09-S is a card of markers in 00 to 09 sequence with three sequences on a card.

Wire Marker Cards

Solid Symbols — Miscellaneous

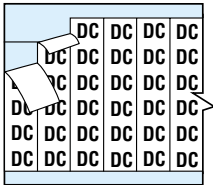
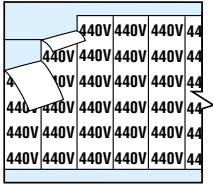

	B-500 Vinyl Cloth	B-702 Vinyl Film	B-605 Over- Laminated	Markers per Card	
				1.500" (38.10 mm)	0.750" (19.05 mm)
12V	WM-12V			25	50
24V	WM-24V			25	50
110V	WM-110V			20	40
115V	WM-115V			20	40
120V	WM-120V			20	40
220V	WM-220V			20	40
230V	WM-230V			20	40
240V	WM-240V			20	40
277V	WM-277V			20	40
440V	WM-440V			20	40
460V	WM-460V			20	40
480V	WM-480V			20	40
AC	WM-AC	TWM-AC		36	72
B +	WM-B-PLS			33	66
B -	WM-B-MNS			33	66
BAT	WM-BAT			25	50
COM	WM-COM			25	50
CT	WM-CT			36	72
DC	WM-DC	TWM-DC		36	72
GND	WM-GND	TWM-GND	OLWM-GND	25	50
GRD	WM-GRD			25	50
HOT	WM-HOT			25	50
IGN	WM-IGN			25	50
IN	WM-IN			36	72
LINE	WM-LIN			20	40
NEG	WM-NEG	TWM-NEG	OLWM-NEG	25	50
NEUT	WM-NEUT			20	40
OUT	WM-OUT			25	50
Phase C	WM-CPH			18	36
POS	WM-POS	TWM-POS	OLWM-POS	25	50
SEC	WM-SEC			25	50
SIG	WM-SIG			25	50
Spare	WM-SPR	TWM-SPR		20	40
TB	WM-TB			36	72
+	WM-PLS	TWM-PLS	OLWM-PLS	36	72
-	WM-MIN	TWM-MIN	OLWM-MIN	36	72
~	WM-CYS			36	72
⊕	WM-GRS			36	72
⚡	WM-HR-A			36	72
⚡	WM-IND-A			36	72
↻	WM-R-ROT	TWM-R-ROT	OLWM-R-ROT	36	72
↻	WM-L-ROT	TWM-L-ROT	OLWM-L-ROT	36	72

LEGEND

SOLID SYMBOLS PRE-PRINTED WIRE MARKERS

Solid Machine Tool Symbols

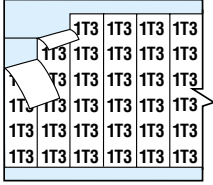

	B-500 Vinyl Cloth	B-702 Vinyl Film	Markers per Card	
			1.500" (38.10 mm)	0.750" (19.05 mm)
1L1	WM-1L1	TWM-1L1	25	50
1L2	WM-1L2	TWM-1L2	25	50
1L3	WM-1L3	TWM-1L3	25	50
2L1		TWM-2L1	25	50
2L2		TWM-2L2	25	50
2L3		TWM-2L3	25	50
3L1		TWM-3L1	25	50
3L2		TWM-3L2	25	50
3L3		TWM-3L3	25	50
4L1		TWM-4L1	25	50
4L2		TWM-4L2	25	50
4L3		TWM-4L3	25	50
5L1		TWM-5L1	25	50
5L2		TWM-5L2	25	50
5L3		TWM-5L3	25	50
6L1		TWM-6L1	25	50
6L2		TWM-6L2	25	50
6L3		TWM-6L3	25	50
1T1	WM-1T1	TWM-1T1	25	50
1T2	WM-1T2	TWM-1T2	25	50
1T3	WM-1T3	TWM-1T3	25	50
2T1	WM-2T1	TWM-2T1	25	50
2T2	WM-2T2	TWM-2T2	25	50
2T3	WM-2T3	TWM-2T3	25	50
3T1	WM-3T1	TWM-3T1	25	50
3T2	WM-3T2	TWM-3T2	25	50
3T3	WM-3T3	TWM-3T3	25	50
4T1	WM-4T1	TWM-4T1	25	50
4T2	WM-4T2	TWM-4T2	25	50
4T3	WM-4T3	TWM-4T3	25	50
5T1	WM-5T1	TWM-5T1	25	50
5T2	WM-5T2	TWM-5T2	25	50
5T3	WM-5T3	TWM-5T3	25	50
6T1	WM-6T1	TWM-6T1	25	50
6T2	WM-6T2	TWM-6T2	25	50
6T3	WM-6T3	TWM-6T3	25	50
7T1	WM-7T1	TWM-7T1	25	50
7T2	WM-7T2	TWM-7T2	25	50
7T3	WM-7T3	TWM-7T3	25	50
8T1		TWM-8T1	25	50
8T2		TWM-8T2	25	50
8T3		TWM-8T3	25	50
9T1		TWM-9T1	25	50
9T2		TWM-9T2	25	50
9T3		TWM-9T3	25	50
10T1		TWM-10T1	20	40
10T2		TWM-10T2	20	40
10T3		TWM-10T3	20	40
11T1		TWM-11T1	20	40
11T2		TWM-11T2	20	40
11T3		TWM-11T3	20	40

Consecutive Machine Tool Symbols Repeated

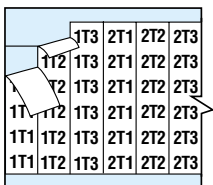

	B-500 Vinyl Cloth	B-702 Vinyl Film	Sequences Per Card		Markers per Card	
			1.500" (38.10 mm)	0.750" (19.05 mm)	1.500" (38.10 mm)	0.750" (19.05 mm)
1T1, 1T2, 1T3 2T1, 2T2, 2T3 3T1, 3T2, 3T3	WM-1T1-3T3		3	6	27	54
4T1, 4T2, 4T3 5T1, 5T2, 5T3 6T1, 6T2, 6T3	WM-4T1-6T3		3	6	27	54
7T1, 7T2, 7T3 8T1, 8T2, 8T3 9T1, 9T2, 9T3	WM-7T1-9T3	TWM-7T1-9T3	3	6	27	54
A1, A2, F1 F2, S1, S2	WM-AFS		6	12	36	72

Wire Marker Cards

Numbers on Colored Background

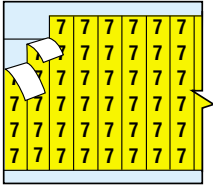

Vinyl Cloth (B-500)

LEGEND	BACKGROUND COLORS:					Markers per Card	
	Red	Yellow	Orange	Blue	Green	1.500" (38.10 mm)	0.750" (19.05 mm)
0	WM-0-RD	WM-0-YL	WM-0-OR	WM-0-BL	WM-0-GR	36	72
1	WM-1-RD	WM-1-YL	WM-1-OR	WM-1-BL	WM-1-GR	36	72
2	WM-2-RD	WM-2-YL	WM-2-OR	WM-2-BL	WM-2-GR	36	72
and so on thru	and so on thru	and so on thru	and so on thru	and so on thru	and so on thru		
9	WM-9-RD	WM-30-YL	WM-9-OR	WM-9-BL	WM-9-GR	36	72

Consecutive Numbers on Colored Background

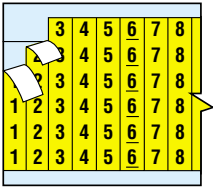

Vinyl Cloth (B-500)

LEGEND	BACKGROUND COLORS:							Quantity Each Number per Card		Markers per Card	
	Red	Yellow	Orange	Blue	Green	Brown	Black	1.500" (38.10 mm)	0.750" (19.05 mm)	1.500" (38.10 mm)	0.750" (19.05 mm)
1-33	WM-1-33-RD	WM-1-33-YL	WM-1-33-OR	WM-1-33-BL	WM-1-33-GR	WM-1-33-BR	WM-1-33-BK	1	2	33	66
34-66	WM-34-66-RD	WM-34-66-YL	WM-34-66-OR	WM-34-66-BL	WM-34-66-GR	WM-34-66-BR	WM-34-66-BK	1	2	33	66
67-99	WM-67-99-RD	WM-67-99-YL	WM-67-99-OR	WM-67-99-BL	WM-67-99-GR	WM-67-99-BR	WM-67-99-BK	1	2	33	66
100-124	WM-100-124-RD	WM-100-124-YL	WM-100-124-OR	WM-100-124-BL	WM-100-124-GR	WM-100-124-BR	WM-100-124-BK	1	2	25	50

Note: White legend on red, green, brown and black backgrounds. All other colors have black legends.

Consecutive Letters On Colored Background

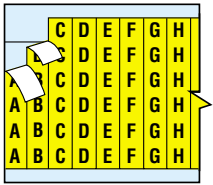

Vinyl Cloth (B-500)

LEGEND	Background Color	Part Number	Quantity Each Letter per Card		Markers per Card	
			1.500" (38.10 mm)	0.750" (19.05 mm)	1.500" (38.10 mm)	0.750" (19.05 mm)
A-Z	BLACK	WM-A-Z-BK	1	2	26	52
A-Z	BLUE	WM-A-Z-BL	1	2	26	52
A-Z	BROWN	WM-A-Z-BR	1	2	26	52
A-Z	GREEN	WM-A-Z-GR	1	2	26	52
A-Z	ORANGE	WM-A-Z-OR	1	2	26	52
A-Z	RED	WM-A-Z-RD	1	2	26	52
A-Z	YELLOW	WM-A-Z-YL	1	2	26	52

Solid NEMA Colors

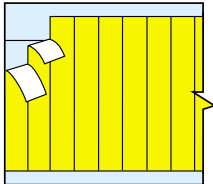

BACKGROUND COLOR	B-500 Vinyl Cloth	B-702 Vinyl Film	B-605 Over-Laminated	Markers per Card	
				1.500" (38.10 mm)	0.750" (19.05 mm)
BLACK	WM-COL-BK	TWM-COL-BK	OLWM-COL-BK	36	72
BROWN	WM-COL-BR	TWM-COL-BR		36	72
DARK BLUE	WM-COL-DB	TWM-COL-DB	OLWM-COL-DB	36	72
DARK GREEN	WM-COL-DG	TWM-COL-DG		36	72
GRAY	WM-COL-GY	TWM-COL-GY		36	72
LIGHT BLUE	WM-COL-LB	TWM-COL-LB	OLWM-COL-LB	36	72
LIGHT GREEN	WM-COL-LG	TWM-COL-LG	OLWM-COL-LG	36	72
MAROON	WM-COL-MR	TWM-COL-MR		36	72
OLIVE	WM-COL-OL	TWM-COL-OL		36	72
ORANGE	WM-COL-OR	TWM-COL-OR	OLWM-COL-OR	36	72
PINK	WM-COL-PK	TWM-COL-PK		36	72
PURPLE	WM-COL-PL	TWM-COL-PL		36	72
RED	WM-COL-RD	TWM-COL-RD	OLWM-COL-RD	36	72
TAN	WM-COL-TN	TWM-COL-TN		36	72
WHITE	WM-COL-WT	TWM-COL-WT	OLWM-COL-WT	36	72
YELLOW	WM-COL-YL	TWM-COL-YL	OLWM-COL-YL	36	72

NUMBERS / LETTERS ON COLOR PRE-PRINTED WIRE MARKERS

Self Laminating Letters — Upper Case

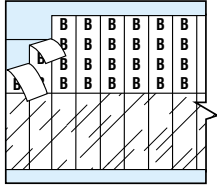

Vinyl Cloth (B-292)

LEGEND	Part Number	Markers per Card	
		1.500" (38.10 mm)	0.750" (19.05 mm)
A	SLF-A	36	72
B	SLF-B	36	72
C	SLF-C	36	72
and so on thru	and so on thru		
Z	SLF-Z	36	72

Self-Laminating Numbers

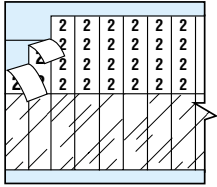

Vinyl Cloth (B-292)

LEGEND	Part Number	Markers per Card	
		1.500" (38.10 mm)	0.750" (19.05 mm)
0	SLF-0	36	72
1	SLF-1	36	72
2	SLF-2	36	72
and so on thru	and so on thru		
25	SLF-25	36	72
26	SLF-26	36	72
and so on thru	and so on thru	36*	72
	SLF-100	25	50

*36/card until "100", "100" is 25/card

Self-Laminating Consecutive Numbers

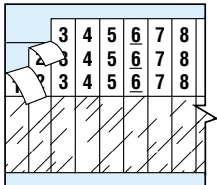

Vinyl Cloth (B-292)

LEGEND	Part Number	Quantity Each		Markers per Card	
		1.500" (38.10 mm)	0.750" (19.05 mm)	1.500" (38.10 mm)	0.750" (19.05 mm)
1-33	SLF-1-33	1	2	33	66
34-66	SLF-34-66	1	2	33	66
67-99	SLF-67-99	1	2	33	66

Self-Laminating Write-On Wire Markers

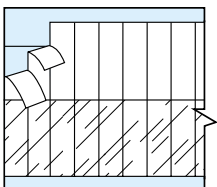

Vinyl Cloth (B-292)

Part Number	Write-on Area (Width x Height) Inch (mm)	Markers per Card	
		1.500" (38.10 mm) Long	0.750" (19.05 mm) Long
SLFW-250	0.250 x 0.750 (6.40 x 19.05)	36	
SLFW-344	0.344 x 0.750 (8.70 x 19.05)	26	
SLFW-500	0.500 x 0.750 (12.50 x 19.05)	18	
SLFW-750	0.750 x 0.750 (19.05 x 19.05)	12	
SLFW-100	1.000 x 0.750 (25.40 x 19.05)	9	
SLFW-150	1.500 x 0.750 (38.10 x 19.05)	6	
SLHW-188	0.187 x 0.375 (4.80 x 9.50)		96
SLHW-250	0.250 x 0.375 (6.40 x 9.50)		72
SLHW-344	0.344 x 0.375 (8.70 x 9.50)		52
SLHW-500	0.500 x 0.375 (12.50 x 9.50)		36
SLHW-750	0.750 x 0.375 (19.05 x 9.50)		24
SLHW-100	1.000 x 0.375 (25.40 x 9.50)		18
SLHW-150	1.500 x 0.375 (38.10 x 9.50)		12

Wire Marker Cards

COMBINATION PACKS

Combination Packs



Each pack contains one card each of 25 numbers or 26 letters (A-Z) with all legends identical on each individual card.

	B-500 Vinyl Cloth	B-702 Vinyl Film	B-605 Over- Laminated
1 - 25	CPCWM-1-25	CPTWM-1-25	CPOLWM-1-25
26 - 50	CPCWM-26-50	CPTWM-26-50	CPOLWM-26-50
51 - 75	CPCWM-51-75	CPTWM-51-75	CPOLWM-51-75
76 - 100	CPCWM-76-100	CPTWM-76-100	CPOLWM-76-100
101 - 125	CPCWM-101-125	CPTWM-101-125	
126 - 150	CPCWM-126-150	CPTWM-126-150	
151 - 175	CPCWM-151-175	CPTWM-151-175	
176 - 200	CPCWM-176-200	CPTWM-176-200	
and so on thru	and so on thru	and so on thru	
301 - 325	CPCWM-301-325	CPTWM-301-325	
and so on thru	and so on thru	and so on thru	
576 - 600	CPCWM-576-600		
A - Z	CPCWM-A-Z	CPTWM-A-Z	CPOLWM-A-Z-GAP

Five Packs



Vinyl Cloth (B-500)

LEGEND	Part Number	Sequences per Card	
		1.500" (38.10 mm)	0.750" (19.05 mm)
0	WM-0-VP		
1	WM-1-VP		
2	WM-2-VP		
and so on thru	and so on thru		
9	WM-9-VP		
1 - 33	WM-1-33-VP	1	2
34 - 66	WM-34-66-VP	1	2
A - Z	WM-A-Z-VP	1	2

Standard Solid Motor Numbers

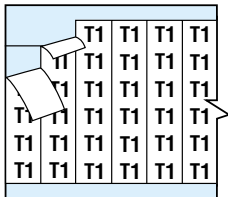

Acetate Cloth (B-12)

LEGEND	Part Number	Markers per Card	
		1.500" (38.10 mm)	0.750" (19.05 mm)
T1	HH-T1	36	72
T2	HH-T2	36	72
T3	HH-T3	36	72
and so on thru	and so on thru		
T6	HH-T6	36	72

Motor Hook-Up Diagrams

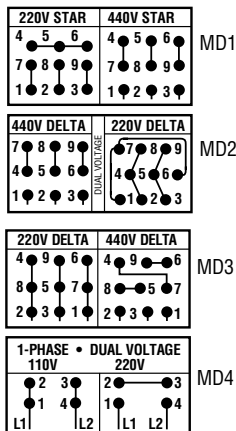

Acetate Cloth (B-12)

STYLE	Part Number	Marker Size
		Inch (mm)
A	MD-1	1.500 x 0.750 (38.10 x 19.05)
B	MD-2	1.500 x 0.750 (38.10 x 19.05)
C	MD-3	1.500 x 0.750 (38.10 x 19.05)
D	MD-4	1.500 x 0.705 (38.10 x 19.05)

CABLE MARKERS



Standard 4" x 9" (101.6 mm x 228.6 mm) cards provide markers for cables, multi-wire circuits, even conductors and tubing in hydraulic systems. Markers may be slit for smaller diameter cable. Markers are 3.50" (89 mm) long; to order half markers, write 1.75" (44 mm) after stock number.

Solid Numbers

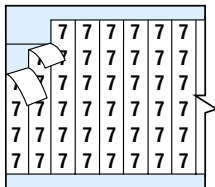

Vinyl (B-708)

LEGEND	Part Number	Markers per Card
0	CAB-0	18
1	CAB-1	18
2	CAB-2	18
3	CAB-3	18
4	CAB-4	18
5	CAB-5	18
6	CAB-6	18
7	CAB-7	18
8	CAB-8	18
9	CAB-9	18

Consecutive Numbers or Letters

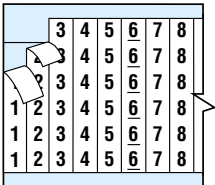

Vinyl (B-708)

LEGEND	Part Number	Markers per Card
01 - 09	CAB-01-09*	18
1 - 9	CAB-1-9*	18
1 - 18	CAB-1-18	18
19 - 36	CAB-19-36	18
37 - 54	CAB-37-54	18
55 - 72	CAB-55-72	18
73 - 90	CAB-73-90	18
91 - 99	CAB-91-99	18
A - I	CAB-A-I*	18
J - R	CAB-J-R*	18
S - Z	CAB-S-Z*	18

*Two sets of legends per card.

Solid Letters

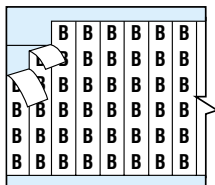

Vinyl (B-708)

LEGEND	Part Number	Markers per Card
A	CAB-A	18
B	CAB-B	18
C	CAB-C	18
D	CAB-D	18
E	CAB-E	18
F	CAB-F	18
N	CAB-N	18

Wire Marker Cards

▶ MINIATURE WIRE MARKERS

Solid Numbers

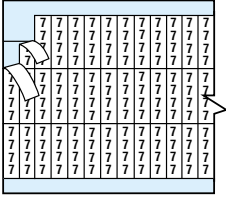

Solid Letters

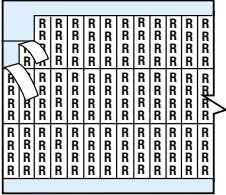

Solid Nema Colors

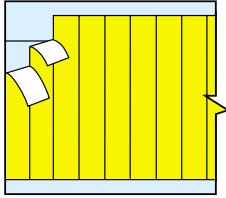

Consecutive Numbers

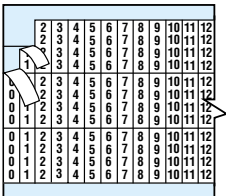

Vinyl Film (B-702)

		Markers per Card 1,500" (38.10 mm)
LEGEND	Part Number	
	0	150
	1	150
	2	150
	3	150
	and so on thru	
	99	150
	100	99
	101	99
	and so on thru	
	125	99
	A	150
	B	150
	C	150
	and so on thru	
	Z	150

Vinyl Film (B-702)

		Markers per Card 1,500" (38.10 mm)
BACKGROUND COLOR	Part Number	
	BLACK	108
	BROWN	108
	DARK BLUE	108
	DARK GREEN	108
	GRAY	108
	LIGHT BLUE	108
	LIGHT GREEN	108
	MAROON	108
	OLIVE	108
	ORANGE	108
	PINK	108
	PURPLE	108
	RED	108
	TAN	108
	WHITE	108
	YELLOW	108

Vinyl Film (B-702)

		Quantity of Each Number per Card	Markers per Card 1,500" (38.10 mm)
LEGEND	Part Number		
	0 - 49	3	150
	50 - 99	3	150
	100 - 132	3	99
	133 - 165	3	99
	166 - 198	3	99
	199 - 231	3	99
	232 - 264	3	99
	265 - 297	3	99
	298 - 330	3	99
	331 - 363	3	99
	364 - 396	3	99
	397 - 429	3	99
	430 - 462	3	99
	463 - 495	3	99

MINIATURE WIRE MARKERS PRE-PRINTED WIRE MARKERS

▶ MICRO MARKERS

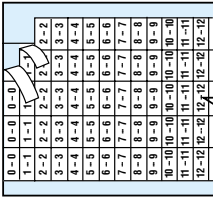

For identification of fine wire (#28 and smaller); resists continuous heat to 250°F (121°C). Only 2 mils thick. Two numbers on each marker, 250 markers on zip-strip dispenser card. Application tool included in each package of 25 cards. Marker size: 0.312" x 0.093" (7.92 mm x 2.36 mm).

Vinyl Film (B-702)

Part Number		Markers per Card	
LEGEND	NUMBERS		
	0	TMXM-0	250
	1	TMXM-1	250
	2	TMXM-2	250
	and so on thru	and so on thru	
17	TMXM-17	250	

Part Number		Sequences on Each Card	
LEGEND	CONSECUTIVE NUMBERS REPEATED		
	0 - 49	TMXM-0-49	5
	50 - 99	TMXM-50-99	5
	1 - 5	TMXM-1-5	50
	1 - 10	TMXM-1-10	25
1 - 25	TMXM-1-25	10	

▶ WIRE MARKER CARD ACCESSORIES

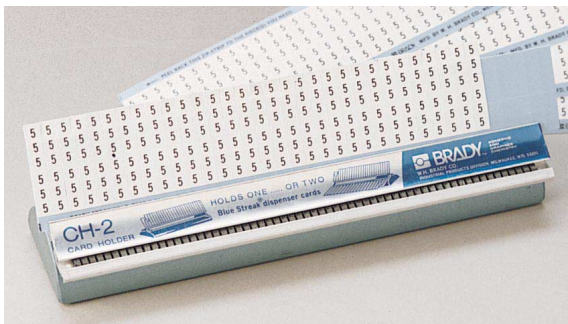

Wire Marker Card Dispenser

- ▶ Holds cards in position... ready for fast application of markers.
- ▶ Allows both hands to be free for production line work, increasing productivity

Part No.	Description	Wt. Each
CH-2	Card Holder for 2.000" x 9.000" (50.80 mm x 228.60 mm) Cards	4 lbs (1.80 kg)

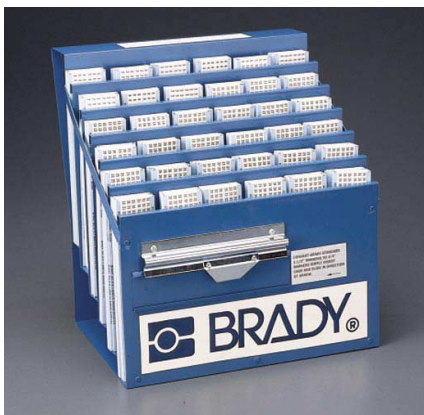

Storenizer Work Center

- ▶ 36 individual compartments hold cards in view, within easy reach.
- ▶ Comes with a card holder and slitter to speed handling and application.
- ▶ Dimensions: width 13.500", depth 8.500", height 14.500".

Part No.	Description	Wt. Each
BLS-1	36 Compartment Wire Marker Unit, Card Holder and Slitter Attachment	11 lbs 2 oz (5.00 kg)

Porta-Pack® Wire Marker Books

▶ PORTA-PACK BOOKS

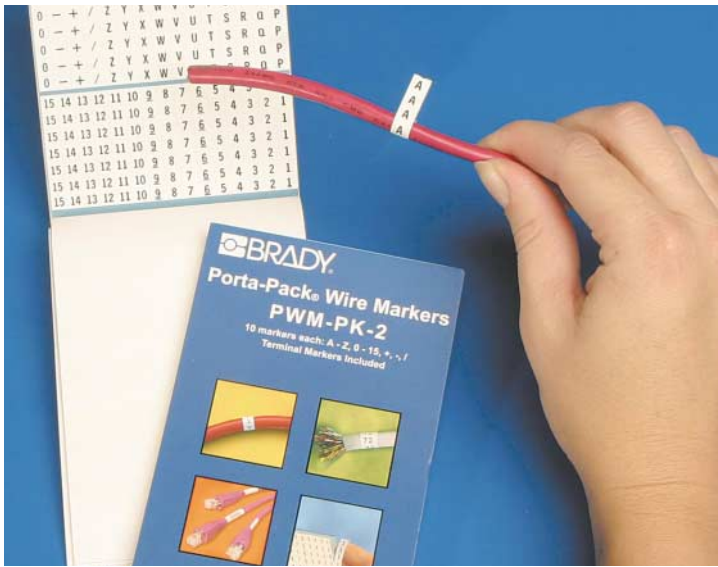

- ▶ Ten pages per book
- ▶ Slim, lightweight, pocket-sized book is easy to carry and easy to use
- ▶ Large selections of legends available; 15 different books and 250 different refill packs
- ▶ Numbers... letters... special symbols... NEMA colors
- ▶ Includes terminal marker with each wire marker

Vinyl Cloth (B-500)

Part Number	LEGEND	Markers each Legend
PWM-PK-1	0 - 9	45
PWM-PK-2	A - Z, 0 - 15, +, -, /	10
PWM-PK-3	1 - 45	10
PWM-PK-4	1, 2, 3	150
PWM-PK-5	A, B, C	150
PWM-PK-6	T1, T2, T3	150
PWM-PK-7	L1, L2, L3	150
PWM-PK-8	1 - 15 16 - 90 A - Z, +, -, /, 0	6 4 2
PWM-PK-9	1, 2, 3, A, B, C T1, T2, T3, L1, L2, L3	45 30
PWM-PK-10	10 different NEMA colors	45
PWM-PK-11	1 - 30	15
PWM-PK-12	A - Z Write-On Labels (Blank) + -	15 18 8 7
PWM-PK-13	+ , - , AC, DC POS, NEG, GND, NEUT Spare Blank Write-On Labels	45 33 21 21
PWM-PK-14	46 - 90	10
PWM-PK-15	1 - 45 46 - 90	5 5

▶ PORTA-PACK BOOKS WITH TELECOMMUNICATION LEGENDS

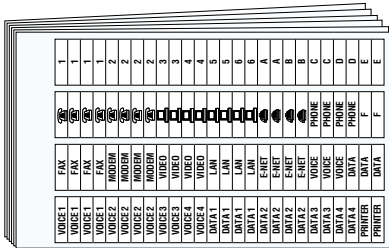

- ▶ Ten pages per book.
- ▶ Customized for telecommunication applications.

Part Number	Material	Size Inch (mm)	Markers Each Legend
TCOM-PK-1	B-621 Polyester Film	0.625 x 0.187 (15.88 x 4.75)	20 (min)
TCOM-PK-2	B-969 Metallized Polyester	0.625 x 0.187 (15.88 x 4.75)	20 (min)

▶ LOAD CENTER AND RESIDENTIAL WIRE MARKERS

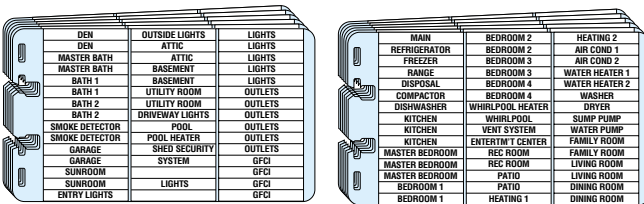

- ▶ Fits right on switch or circuit breaker.
- ▶ Comes in ten page pocket-sized book for convenient use (five cards each of two legends).

Vinyl Cloth (B-500)

Part Number	Size Inch (mm)	Markers Each Legend
PWM-LC-3	1.550 x 0.200 (39.37 x 5.08)	5

PORTA-PACK WIRE MARKER BOOKS PRE-PRINTED WIRE MARKERS

▶ TEN PACK REFILLS

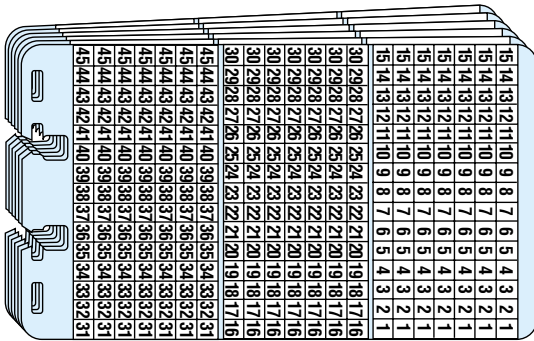

- ▶ Ten pages per refill pack
- ▶ Over 250 different refill packs

Vinyl Cloth (B-500)

Part Number	LEGEND	Markers each Legend
PWM-0	0	450
PWM-1	1	450
and so on thru	and so on thru	
PWM-99	99	450
PWM-100	100	330
and so on thru	and so on thru	
PWM-125	125	330
PWM-0-9	0 - 9	45
PWM-10-19	10 - 19	45
PWM-20-29	20 - 29	45
and so on thru	and so on thru	
PWM-90-99	90 - 99	45
PWM-100-109	100 - 109	33
and so on thru	and so on thru	
PWM-190-199	190 - 199	33
PWM-1-45	1 - 45	10
PWM-46-90	46 - 90	10
PWM-1-3	1 - 3	150
PWM-4-6	4 - 6	150
PWM-7-9	7 - 9	150
PWM-10-12	10 - 12	150
PWM-13-15	13 - 15	150
PWM-16-18	16 - 18	150
PWM-19-21	19 - 21	150
PWM-22-24	22 - 24	150
PWM-25-27	25 - 27	150
PWM-28-30	28 - 30	150
PWM-A	A	450
PWM-B	B	450
PWM-C	C	450
and so on thru	and so on thru	
PWM-Z	Z	450
PWM-A-Z, 0-15,	A - Z 0 - 15, +, -, /	10
PWM-A-C	A, B, C	150
PWM-AC	AC	450
PWM-D-F	D, E, F	150
PWM-DC	DC	450
PWM-G-I	G, H, I	150
PWM-GND	GND	330
PWM-J-L	J, K, L	150
PWM-L1-L3	L1, L2, L3	150
PWM-M-O	M, N, O	150
PWM-MIN	-	450
PWM-NEG	NEG	330
PWM-NEUT	NEUT	210
PWM-P-R	P, Q, R	150
PWM-POS	POS	450
PWM-PLS	+	450
PWM-S-U	S, T, U	150
PWM-SPR	SPARE	210
PWM-T1-T3	T1, T2, T3	150
PWM-V-X	V, W, X	150
PWM-W/O	Write-On 1.370" x 0.500" Labels	180
PWM-YZ + -	Y, Z, +, -	150

Part Number	NEMA Color Markers	Markers each Legend
PWMC-BK	BLACK	450
PWMC-BR	BROWN	450
PWMC-DG	DARK GREEN	450
PWMC-GY	GRAY	450
PWMC-LB	LIGHT BLUE	450
PWMC-LG	LIGHT GREEN	450
PWMC-OR	ORANGE	450
PWMC-RD	RED	450
PWMC-WT	WHITE	450
PWMC-YL	YELLOW	450

Porta-Pack® Wire Marker Books

▶ WRITE-ON SELF-LAMINATING WIRE AND CABLE MARKERS

- ▶ Use Brady's labeling pens or other markers to write on legend
- ▶ Transparent part over-wraps provide snug fitting, self-laminating shield that resists oil, water and solvents
- ▶ For applications above or below ground

Vinyl (B-292)

Part Number	LEGEND	Markers Size Inch (mm)	Markers Per Book	Size of Write-on Area Inch (mm)
PWC-PK-1	Blank/Write-on	0.750 x 1.750 (19.00 x 44.40)	120	0.750 x 0.500 (19.00 x 12.70)
PWC-PK-3	Blank/Write-on	1.000 x 3.000 (25.40 x 76.20)	60	1.000 x 0.750 (25.40 x 19.00)
PWC-PK-6	Blank/Write-on	1.000 x 6.000 (25.40 x 152.40)	30	1.000 x 1.000 (25.40 x 25.40)
PWC-PK-36	Blank/Write-on	1.000 x 3.000 (25.40 x 76.20)	30	1.000 x 0.750 (25.40 x 19.00)
		1.000 x 6.000 (25.40 x 152.40)	15	1.000 x 1.000 (25.40 x 25.40)

▶ SELF-LAMINATING WIRE MARKERS

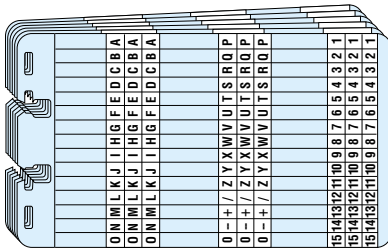

- ▶ Ten pages per book
- ▶ Same as above but with printed legends

Vinyl (B-292)

Part Number	LEGEND	Markers Each Legend
PWS-PK-1	0 - 9	45
PWS-PK-2	A - Z	10
	0 - 15	10
	+	10
	-	10
	/	10
PWS-PK-3	1 - 45	10

Part Number	LEGEND	Markers Size Inch (mm)	Markers Per Book	Size of Write-on Area Inch (mm)
PWS-PK-14	Blank/Write-on	0.500 x 1.500 (12.70 x 38.00)	180	0.500 x 0.750 (12.70 x 19.00)

PORTA-PACK WIRE MARKER BOOKS PRE-PRINTED WIRE MARKERS

► BRADYSLEEVE™ PORTA-PACK BOOKS

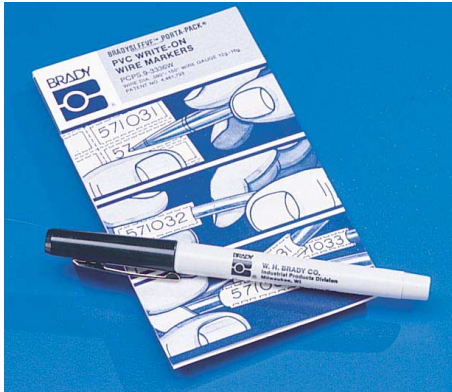

- Our most popular sleeve marker is now in book form. BradySleeve markers provide the electrical with the most permanent, efficient ways to mark wires in the field
- Full-circle sleeve marker permits multiple-digit legend. For best results, use Brady marking pen or a ball point pen
- **Includes indelible marking pen**
- Patent number 4461,793.

► PORTA-PACK ACCESSORIES

Quik-File® Wire Marking System

- Quick access to Porta-Pack cards... saves time handling individual cards
- Legends can be categorized with regular index cards
- Provides simple inventory control and orderly storage
- Choose 150 or 300 card capacity file.

Part No.	Description
QF-150	Single Row "V" Type, 150 Card Capacity File

Porta-Pack Holster



All leather – holds complete Porta-Pack wire and terminal marking kit on belt. Ready for use anytime, anywhere.

**Non-Shrink Polyolefin (B-319)
Heat-Shrink Polyolefin (B-321)**

Part Number	Range of Wire Diameter Inch (mm)	*Approximate Wire Gauge	Markers Per Book
B-319 NON-SHRINK POLYOLEFIN			
PCPS-04-2508-WT	0.030 - 0.100 (0.76 - 2.54)	16 - 20	630
PCPS-04-3336-WT	0.090 - 0.150 (2.28 - 3.81)	12 - 16	420
PCPS-04-3758-WT	0.125 - 0.175 (3.18 - 4.45)	10, 12	390
PCPS-04-5008-WT	0.160 - 0.250 (4.06 - 6.35)	8, 10	300
PCPS-09-2508-WT	0.030 - 0.100 (0.76 - 2.54)	16 - 20	315
PCPS-09-3336-WT	0.090 - 0.150 (2.28 - 3.81)	12 - 16	225
PCPS-09-3758-WT	0.125 - 0.175 (3.18 - 4.45)	10, 12	210
PCPS-09-5008-WT	0.160 - 0.250 (4.06 - 6.35)	8, 10	165
B-321 HEAT-SHRINK POLYOLEFIN			
PHCPS-04-2508-WT	0.035 - 0.075 (0.89 - 1.91)	16 - 20	630
PHCPS-04-3336-WT	0.075 - 0.130 (1.91 - 3.30)	12 - 16	420
PHCPS-04-3758-WT	0.130 - 0.160 (3.30 - 4.06)	10, 12	390
PHCPS-04-5008-WT	0.160 - 0.235 (4.06 - 5.97)	8, 10	300
PHCPS-09-2508-WT	0.035 - 0.075 (0.89 - 1.91)	16 - 20	315
PHCPS-09-3336-WT	0.075 - 0.130 (1.91 - 3.30)	12 - 16	225
PHCPS-09-3758-WT	0.130 - 0.160 (3.30 - 4.06)	10, 12	210
PHCPS-09-5008-WT	0.160 - 0.235 (4.06 - 5.97)	8, 10	165

*Based on National Electric Code insulation measurement of THHN wire

Vinyl Cloth (B-500)

Part Number	LEGEND	No. of Cards	Total No. of Cards
QFK-150	1 - 10	10 cards each	100 cards
	A - Z, 0 - 15	10 cards each	10 cards
	T1 - T3	10 cards each	10 cards
	L1 - L3	10 cards each	10 cards
	+	10 cards each	10 cards
	-	10 cards each	10 cards

TOTAL OF 15 TEN-PACKS EQUALS 150 CARDS

QFK-300	1 - 20	10 cards each	200 cards
	A - Z, 0 - 15	20 cards each	20 cards
	T1 - T3	10 cards each	10 cards
	L1 - L3	10 cards each	10 cards
	+	10 cards each	10 cards
	-	10 cards each	10 cards
	AC	10 cards each	10 cards
	DC	10 cards each	10 cards
1 - 45	10 cards each	10 cards	
46 - 90	10 cards each	10 cards	

TOTAL OF 30 TEN-PACKS EQUALS 300 CARDS

Part Number	Standard Package	Description
PPH-1	1 unit	Holster with belt loop

Porta-Pack® Wire Marker Books

► PORTA-PACK ACCESSORIES CONTINUED

Labeling Pen



Brady's labeling pens use a quick drying, permanent ink. The ink is specially formulated to resist oil, solvents, abrasion and fading.

Part Number	Ink Color	Quantity
MP-1	Black Fine Point*	12 per package
MP-2	Black Ultra Fine Point*	12 per package

*Single pens are available.

BradyPack™ Wire Markers

► DISPENSER



- Wire marking is simple, clean and fast... just pull tape out, tear and wrap. Compact size fits in your pocket or hangs from work belt
- Unique design allows easy access to all legends during use or when refilling
- Lifetime guarantee on BradyPack dispenser

Part No.	Description
BPE	Empty Dispenser
BPL	Loaded Dispenser with Legends 0 - 9
BPL-COL	Loaded Dispenser with 10 NEMA colors

► REFILLS

Vinyl (B-292)

Part Number	LEGEND	Label Color	Rolls per Legend
BPR-0	0	WHITE	10
BPR-1	1	WHITE	10
BPR-2	2	WHITE	10
Thru BPR-9	9	WHITE	10
BPR-0-9	0-9	WHITE	1
BPR-10-19	10-19	WHITE	1
Thru 90-99	90-99	WHITE	1
BPR-A	A	WHITE	10
Thru BPR-Z	Z	WHITE	10
BPR-A-J	A-J	WHITE	1
BPR-I-R	I-R	WHITE	1
BPR-Q-Z	Q-Z	WHITE	1
BPR-H1	H1	WHITE	10
BPR-H2	H2	WHITE	10
BPR-H3	H3	WHITE	10
BPR-H4	H4	WHITE	10
BPR-L1	L1	WHITE	10
BPR-L1	L1	WHITE	10
BPR-L2	L2	WHITE	10

Part Number	LEGEND	Label Color	Rolls per Legend
BPR-L3	L3	WHITE	10
BPR-T1	T1	WHITE	10
BPR-T2	T2	WHITE	10
BPR-T3	T3	WHITE	10
BPR-CYS	~	WHITE	10
BPR-GRS	≡	WHITE	10
BPR-PLS	+	WHITE	10
BPR-MIN	(blank)	WHITE	10
BPR-COL-BK	(blank)	BLACK	10
BPR-COL-BL	(blank)	BLUE	10
BPR-COL-BR	(blank)	BROWN	10
BPR-COL-GR	(blank)	GREEN	10
BPR-COL-GY	(blank)	GRAY	10
BPR-COL-OR	(blank)	ORANGE	10
BPR-COL-PL	(blank)	PURPLE	10
BPR-COL-RD	(blank)	RED	10
BPR-COL-WT	(blank)	WHITE	10
BPR-COL-YL	(blank)	YELLOW	10

BRADYPACK WIRE MARKERS PRE-PRINTED WIRE MARKERS

► NYLON

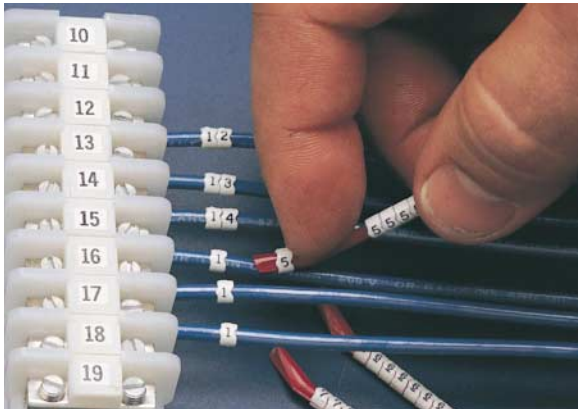

- Markers apply quickly with a special Quik-Wand™ applicator
- Place the flared “shoe” end of the wand against the wire and push sleeve onto the wire
- Split sleeve with “chevron” locking design snaps on the wire, won't slip or slide.

Sizes 03 through 18 are supplied on wands with 30 sleeves per wand, 10 wands to a package. Sizes 23 and larger are packed 50 individual pieces per package.

Combination Packs: PREFIX SCNC Contains 10 wands, one wand each of 0 through 9.

Alpha Packs Contains 13 wands, one wand each of A through M or N through Z. (e.g. SCN07-A-M).

Color Coding Aids Users Brady Clip-Sleeve applicator wands are color coded for easy identification of sleeve sizes.

Size 03	Maroon	Size 10	Red
Size 05	Gray	Size 13	Dark Blue
Size 07	Light Blue	Size 15	Brown
Size 09	Green	Size 18	Yellow

For Wire Sizes Inch (mm)	SIZE 03* 0.037-0.051 (0.94-1.30)	SIZE 05* 0.053-0.073 (1.35-1.85)	SIZE 07 0.075-0.087 (1.901-2.21)	SIZE 09 0.098-0.110 (2.49-2.79)	SIZE 10 0.110-0.134 (2.79-3.40)	SIZE 13 0.134-0.181 (3.40-4.60)
Approx. Wire Gauge	26, 24	22, 20	18	18	16, 14	14
	Part Number	Part Number	Part Number	Part Number	Part Number	Part Number
0 and so on thru 9	SCN03-0 and so on thru SCN03-9	SCN05-0 and so on thru SCN05-9	SCN07-0 and so on thru SCN07-9	SCN09-0 and so on thru SCN09-9	SCN10-0 and so on thru SCN10-9	SCN13-0 and so on thru SCN13-9
0 - 9	SCNC-03	SCNC-05	SCNC-07	SCNC-09	SCNC-10	SCNC-13
A and so on thru Z	SCN03-A and so on thru SCN03-Z	SCN05-A and so on thru SCN05-Z	SCN07-A and so on thru SCN07-Z	SCN09-A and so on thru SCN09-Z	SCN10-A and so on thru SCN10-Z	SCN13-A and so on thru SCN13-Z
A - M			SCN07-A-M	SCN09-A-M	SCN10-A-M	SCN13-A-M
N - Z			SCN07-N-Z	SCN09-N-Z	SCN10-N-Z	SCN13-N-Z
+	SCN03-PLUS	SCN05-PLUS	SCN07-PLUS	SCN09-PLUS	SCN10-PLUS	SCN13-PLUS
-	SCN03-MINUS	SCN05-MINUS	SCN07-MINUS	SCN09-MINUS	SCN10-MINUS	SCN13-MINUS
BLANK		SCN05-BLANK	SCN07-BLANK	SCN09-BLANK	SCN10-BLANK	SCN13-BLANK
Parts per package	300	300	300	300	300	300

For Wire Sizes Inch (mm)	SIZE 15 0.154-0.177 (3.90-4.50)	SIZE 18 0.181-0.232 (4.60-5.89)	SIZE 23* 0.236-0.299 (5.99-7.59)	SIZE 36* 0.362-0.413 (9.19-10.49)	SIZE 45* 0.453-0.512 (11.51-13.00)	SIZE 61* 0.610-0.670 (15.49-17.02)
Approx. Wire Gauge	14, 12	10, 8	8, 4	4, 2	2, 1, 0, 00	00, 000
	Part Number	Part Number	Part Number	Part Number	Part Number	Part Number
0 and so on thru 9	SCN15-0 and so on thru SCN15-9	SCN18-0 and so on thru SCN18-9	SCN23-0 and so on thru SCN23-9	SCN36-0 and so on thru SCN36-9	SCN45-0 and so on thru SCN45-9	SCN61-0 and so on thru SCN61-9
0 - 9	SCNC-15	SCNC-18				
A and so on thru Z	SCN15-A and so on thru SCN15-Z	SCN18-A and so on thru SCN18-Z	SCN23-A and so on thru SCN23-Z	SCN36-A and so on thru SCN36-Z	SCN45-A and so on thru SCN45-Z	SCN61-A and so on thru SCN61-Z
A - M	SCN15-A-M	SCN18-A-M				
N - Z	SCN15-N-Z	SCN18-N-Z				
+	SCN15-PLUS	SCN18-PLUS	SCN23-PLUS	SCN36-PLUS	SCN45-PLUS	SCN61-PLUS
-	SCN15-MINUS	SCN18-MINUS	SCN23-MINUS	SCN36-MINUS	SCN45-MINUS	SCN61-MINUS
Blank	SCN15-BLANK	SCN18-BLANK				
Parts per package	300	300	50	50	50	50

*Consult factory for delivery of half alphabet wands (A-M, N-Z) in sizes 03, 05, 23, 36, 45 and 61.

Omni-Grip® Sleeve Markers

► PVC POLYVINYLCHLORIDE



- Applies fast and easy — special patented design locks and holds marker on wire
- Stock, pre-printed sleeves permit any combination of numbers and letters
- Legends are heat-stamped in black and yellow PVC material for better visibility and legibility
- Patent Numbers: 4,234,090; 4,415,006



Cross-section view Omni-Grip design provides a tight grip — sleeve changes internal shape to lock on the wire permanently.

For Wire Sizes Inch (mm)	SIZE 2 0.250-0.340 (6.35-8.64)	SIZE 3 0.170-0.280 (4.32-7.11)	SIZE 4 0.120-0.210 (3.05-5.33)	SIZE 5 0.090-0.155 (2.29-3.94)	SIZE 6 0.060-0.100 (1.52-2.54)
Approx. Wire Gauge	8, 6, 4	10, 8, 6	14, 12, 10	18, 16, 14	22, 20, 18
	Part Number	Part Number	Part Number	Part Number	Part Number
0	OG2Y-0*	OG3Y-0*	OG4Y-0*	OG5Y-0*	OG6Y-0*
and so on thru	and so on thru	and so on thru	and so on thru	and so on thru	and so on thru
9	OG2Y-9*	OG3Y-9*	OG4Y-9*	OG5Y-9*	OG6Y-9*
0 - 9	OG2Y-0-9*†	OG3Y-0-9*†	OG4Y-0-9*†	OG5Y-0-9*†	OG6Y-0-9*†
A	OG2Y-A	OG3Y-A	OG4Y-A	OG5Y-A	OG6Y-A
and so on thru	and so on thru	and so on thru	and so on thru	and so on thru	and so on thru
Blank	OG2Y-BLANK	OG3Y-BLANK	OG4Y-BLANK	OG5Y-BLANK	OG6Y-BLANK
⊕	OG2Y-GND	OG3Y-GND	OG4Y-GND	OG5Y-GND	OG6Y-GND
+	OG2Y-PLUS	OG3Y-PLUS	OG4Y-PLUS	OG5Y-PLUS	OG6Y-PLUS
-	OG2Y-MIN	OG3Y-MIN	OG4Y-MIN	OG5Y-MIN	OG6Y-MIN
/	OG2Y-SL	OG3Y-SL	OG4Y-SL	OG5Y-SL	OG6Y-SL
Z	OG2Y-Z	OG3Y-Z	OG4Y-Z	OG5Y-Z	OG6Y-Z
Parts per package	100	100	100	100	100

†OG2Y-0-9 through OG6Y-0-9, etc., contain 4 strips of 25 sleeves, each printed 0 - 9, 0 - 9, 0 - 4 in sequence.

***BULK PACKAGING — PREFIX OGB**

Omni-Grip sleeve markers, legends 0 through 9, are available in bulk packages for large-volume users. Handy dispenser boxes allow easy access and keep work areas neat.

- To order: add the letter "B" to the Stock Number, for example OGB2Y-0 instead of OG2Y-0
- Packaging: Size 2 is packaged in boxes of 500 (20 strips of 25 markers)
- Sizes 3 thru 6 are packaged in boxes of 1000 (40 strips of 25 markers)

► **OMNI-GRIP DISPENSER HOLDER**



- Designed to hold sleeves for fast and easy marking
- Holds up to 18 Omni-Grip strips with 25 sleeves per strip
- Arrange legends and sizes to fit your marking requirements

Stock No.	Description
OGH-1	Omni-Grip Dispenser Holder

OMNI-GRIP SLEEVE MARKERS PRE-PRINTED WIRE MARKERS

Brady Material #	Material	Color	Temp. Range	Print Technology	Properties & Applications
B-11	Polyester	White & Various	-40°F to 266°F (-40°C to 130°C)	Pre-Printed	Resistant to heat, oil, solvents. Roll-form wire markers. Environments containing heat, oil, or solvents.
B-12	Acetate Cloth	Beige	-20°F to 221°F (-29°C to 105°C)	Pre-Printed	Resistant to oil and heat. Wire marker for varnish dip or baking cycles.
B-103	Polyester	Clear	94°F to 266°F (-70°F to 130°C)	N.A.	1-mil low profile over-laminating film with a permanent acrylic adhesive designed to adhere to printable films. Withstands solder flux and cleaning/degreasing solvents. Supplied self-wound for in-line over laminating operations, or on a liner.
B-104	Polyimide	Clear/Amber	Up to 320°F (160°C)	N.A.	1-mil low profile over-laminating film with a permanent acrylic adhesive designed to adhere to printable films. Withstands solder flux and cleaning/degreasing solvents used in the manufacture of printed circuit boards, and has a very high temperature range. Supplied self-wound for in-line over-laminating operations, or on a liner.
B-107	Polyester	White	-40°F to 293°F (-40°C to 145°C)	Ink Jet	Resistant to solvents; smudge-resistant. High resolution; high-temperature performance. Applications requiring bar code printing, solvent or high temperature resistance. Recommended for use on topside of circuit boards and IC(s).
B-109	Polyethylene	White	-40°F to 120°F (-40°C to 49°C)	Dot Matrix Thermal Transfer TLS2200®	General-purpose tagging material with excellent tear- and chemical- resistance. Exhibits good weatherability, humidity resistance, and egibility after solvent exposure.
B-110	Saturated Paper	White	-40°F to 212°F (-40°C to 100°C)	Dot Matrix	Excellent conformability; resistant to water and humidity. Environments containing water, humidity. Ideal for temporary identification.
B-111	Polyester	Clear	-94°F to 230°F (-70°C to 110°C)	N.A.	Overlaminating film with acrylic adhesive designed to adhere to printable films. This self-wound overlaminate is available in single or 2 ply. The 2-ply is ideal for paint masking where the topside overlaminate is removed. Good temperature, chemical and abrasion resistance.
B-112	Polyester	Clear	-94°F to 212°F (-70°C to 100°C)	N.A.	Silicone free self-wound overlaminate with acrylic adhesive designed to adhere to printable films. Available in single or 2-ply. The 2-ply is ideal for paint masking where the topside overlaminate is removed. Excellent clarity, good temperature, chemical and abrasion resistance.
B-113	Paper	White	-40°F to 194°F (-40°C to 90°C)	Ink Jet	Permanent adhesive; smudge resistant; ink jet-printable. Applications requiring economical, general purpose label. Bar code-printable.
B-115	Vinyl Cloth	White	-40°F to 180°F (-40°C to 82°C)	Ink Jet	Resistant to oil, water, humidity. Excellent printability; ink jet-receptive coating. Applications requiring general-purpose permanent or temporary labeling, wire marking or marking with printable or write-on properties. Leaves no adhesive residue when removed - good EPROM label.
B-117	Vinyl	Clear/White	-40°F to 158°F (-40°C to 70°C)	Ink Jet	Self laminating wire and cable marking. Excellent abrasion and smudge resistance.
B-121	Paper	White	-40°F to 158°F (-40°C to 70°C)	Dot Matrix	Removable adhesive; smudge-resistant. Applications requiring inexpensive, removable labels such as inventory or maintenance labels.
B-122	Paper	White	-40°F to 193°F (-40°C to 90°C)	Dot Matrix Pre-Printed	Low internal strength; printable. Applications requiring a label that cannot be removed intact.
B-124	Paper	Blue, Brown, Gray, Green, Orange, Purple, Red, White, Yellow	150°F (66°C) Maximum	Dot Matrix Laser	Designed for 110 terminal block marking.
B-139	Polyvinyl Fluoride (PVF)	Clear	-94°F to 230°F (-70°C to 110°C)	N.A.	Self-wound overlaminate with acrylic adhesive designed to adhere to printable films. This single layer laminate is specially developed for applications where resistance to UV light and outdoor weathering is required.
B-145	Polyethelene	Gray	N.A.	Thermal Transfer	Tear-resistant 2-sided printable tag
B-164	Metallized Polyester	Silver	-40°F to 267°F (-40°C to 130°C)	Dot Matrix	Modified metallized polyester resists shrinking at high temperatures. Resistant to flux and solvents used in the manufacture of printed circuit boards. Withstands 3 minutes in solder flux, or 2 minutes in 425°F flourinert. Ideal for identifying circuit boards and surface-mounted components.



Master Materials Chart

Brady Material #	Material	Color	Temp. Range	Print Technology	Properties & Applications
B-184	Aluminum Foil	Silver	-40°F to 266°F (-40°C to 130°C)	Pre-Printed	Dead soft aluminum foil with good conformability. Permanent debossing when marked. Resistant to heat, oil and solvents. Abrasion-resistant. Environments containing heat, oil or solvents; abrasive environments. Excellent for motor vehicles and outdoor wiring.
B-292	Vinyl	Clear/White	-40°F to 150°F (-40°C to 66°C)	Dot Matrix ID PRO® Plus LS2000	Good conformability, durability. Self-extinguishing; write-on surface. Resistant to oil, water, solvents. Environments containing oil, water or solvents. On-the-job marking. Excellent for machine tool and underground wiring. Outstanding flat ribbon cable marker. 
B-302	Polyester	White	-40°F to 230°F (-40°C to 110°C)	Pre-Printed	Surface printed white polyester with clear polyester overlamine.
B-319	Polyolefin	White	-40°F to 221°F (-40°C to 105°C)	Dot Matrix ID PRO Plus LS2000	Good legend permanence and smudge resistance. Applications requiring sleeve markers, computer-printable. Non heat-shrinkable.
B-321	Polyolefin	White	-65°F to 221°F (-54°C to 105°C)	Dot Matrix ID PRO Plus LS2000	Heat-shrinkable; excellent resistance to oil and solvents. Ink-receptive coating provides permanent legibility. Applications requiring sleeve markers, computer-printable.
B-322	Polyolefin	White or Yellow	-40°F to 221°F (-40°C to 105°C)	Dot Matrix ID PRO Plus LS2000	Heat-shrinkable; self-extinguishing, permanent legibility. Applications requiring self-extinguishing sleeve markers, computer-printable. Aerospace and military wire marking. Meets MIL-S-85848.
B-325	PVC Polyvinylchloride	Yellow	-40°F to 212°F (-40°C to 100°C)	Pre-Printed Omni-Grip®	Pre-printed full circle polyvinylchloride sleeves.
B-330	Polyolefin	White or Yellow	-40°F to 248°F (-40°C to 120°C)	Dot Matrix	Heat-shrinkable polyolefin film with a computer-printable topcoat and a heat-activating adhesive. Identification of wire bundles, large conduits and installed cables.
B-341	Polyolefin	White or Yellow	-67°F to 275°F (-55°C to 135°C)	Dot Matrix Thermal Transfer	2-to-1 shrink ratio self-extinguishing; meets the material and physical property requirements of MIL-DTL-23053/5C (Class 1); MIL-M-81531; MIL-STD-202F; method 215 and UL224.
B-342	Polyolefin	White	-67°F to 275°F (-55°C to 135°C)	Dot Matrix Thermal Transfer ID PRO Plus LS2000, TLS2200®	3-to-1 shrink ratio self-extinguishing; meets the material and physical property requirements of MIL-DTL-23053/5C (class 1); MIL-M-81531; MIL-STD-202F; method 215 and UL 224
B-350	Polyester/Paper Laminate	White	-94°F to 194°F (-70°C to 90°C)	Pre-Printed Thermal Transfer	Provides clear evidence of exposure to water for controlling invalid warranty claims, failure analysis or troubleshooting (service and repair).
B-351	Vinyl	White	-40°F to 212°F (-40°C to 100°C)	Thermal Transfer	Tamper-resistant film with a permanent acrylic adhesive. Good resistance to solvents and humidity. Designed to fracture easily to prevent one-piece removal.
B-352	Metallized Vinyl	Silver	-40°F to 212°F (-40°C to 100°C)	Thermal Transfer	Tamper-resistant metallized film. Good resistance to solvents and humidity. Designed to fracture easily to prevent one-piece removal. 
B-354	Water-Indicating Polyester/Paper Laminate	Gloss White	-94°F to 194°F (-70°C to 90°C)	Thermal Transfer	Provides clear evidence of exposure to water for controlling invalid warranty claims, failure analysis or troubleshooting (service and repair). Standard color change is white to blue. For special high volume applications, available in custom indicating colors and/or designs 
B-358	Acetate	Gloss Clear	-40°F to 175°F (-40°C to 80°C)	Thermal Transfer	Tamper resistant film with a permanent acrylic adhesive. Designed to fracture easily when removal is attempted. For use as package seals / closures.
B-359	Acetate	Gloss White	-40°F to 175°F (-40°C to 80°C)	Thermal Transfer	Tamper resistant film with a permanent acrylic adhesive. Designed to fracture easily when removal is attempted. For use as package seals / closures.
B-361	Polyester	Clear/White	-94°F to 230°F (-70°C to 110°C)	Laser	Flexible, clear and conformable. Permanent adhesion within 24 hours. Self-laminating wire, cable and vial markers used in power plants and laboratories. Low halogen and sulfur content.
B-389	Polypropylene	White	-40°F to 221°F (-40°C to 100°C)	Dot Matrix	Printable rigid inserts designed to be affixed to a wire.

 *These materials are UL recognized.

*Refer to the full page charts on pages 280-281 for more information and complete listing of parts.



Brady Material #	Material	Color	Temp. Range	Print Technology	Properties & Applications
B-402	Paper	White	-40°F to 158°F (-40°C to 70°C)	Thermal Transfer	Thermal transfer-printable paper with permanent adhesive. Applications in general labeling and bar code labeling. Aggressive adhesive for bonding to corrugated, films, plastic and steel surfaces.
B-408	Paper	White	25°F to 158°F (4°C to 70°C)	Thermal Transfer	Bar code and general labeling. Repositionable adhesive.
B-409	Polyolefin	White	-94°F to 193°F (-70°C to 90°C)	Laser	Excellent write-on and laser-printability. Applications requiring durable write-on bar code-printable or computer-printable labels. Abrasion resistant.
B-410	Polyolefin	White	-90°F to 212°F (-70°C to 100°C)	Laser	Tamper-resistant. Applications requiring non-removable identification.
B-411	Polyolefin tag stock	White	-40°F to 122°F (-40°C to 50°C)	Thermal Transfer	Designed printing in harsh environments. Resistant to water and chemicals. Not recommended for outdoor applications. Tag material designed for general purpose marking.
B-412	Polypropylene tag stock	White	-40°F to 212°F (-40°C to 100°C)	Thermal Transfer	Highly durable labels designed for thermal transfer printing in outdoor and harsh environmental applications. Ideal for wire and cable identification or product inventory identification, where legibility and tensile strength are needed.
B-422	Polyester	White	-40°F to 212°F (-40°C to 100°C)	Thermal Transfer TLS2200®	Gloss white film with permanent acrylic-based adhesive. Designed for rough surfaces and applications where increased adhesion is required. Electronic PCB and component; bar code label and rating plates. 2 mil adhesive, recommended for application on textured surfaces.  
B-423	Polyester	White	-40°F to 248°F (-40°C to 120°C)	Thermal Transfer TLS2200	Thermal transfer-printable with a permanent acrylic adhesive. Electronic PCB and component; bar code label and rating plates.   
B-424	Paper	White	-40°F to 122°F (-40°C to 50°C)	Thermal Transfer TLS2200	Top-coated, thermal transfer-printable with a permanent latex adhesive. Designed for use in labeling applications requiring a low-cost, general-purpose labeling material.
B-426	Polyimide	Amber	-94°F to 662°F (-70°C to 350°C) 80 seconds at 662°F (350°C)	Thermal Transfer TLS2200	Polyimide film with a permanent acrylic adhesive, designed to withstand the various processes, fluxes and cleaning solvents encountered in the manufacture of printed circuit boards. Can be used for top- or bottom-side component or board identification. Withstands extremely high temperatures.
B-427	Vinyl	Clear/White	-94°F to 158°F (-70°C to 70°C)	Thermal Transfer TLS2200	Permanent acrylic adhesive and a topcoat specifically formulated for thermal transfer printing. Excellent water, oil and solvent resistance with clarity and conformability. Self-laminating wire and cable identification. 
B-428	Metallized Polyester	Silver	-40°F to 176°F (-40°C to 80°C)	Thermal Transfer TLS2200®	Metallized polyester with a permanent acrylic adhesive. Thermal transfer printable. Designed for rating or serial plates, product information, warranty labels and inventory control labels.   
B-430	Polyester	Clear	-40°F to 212°F (-40°C to 100°C)	Thermal Transfer TLS2200	Thermal transfer-printable polyester with permanent acrylic-based adhesive. Designed for rating and serial plates using alphanumerics, bar codes, graphic symbols, and logos that require name plate quality. Withstands numerous solvents and can be applied to variable surfaces.  
B-432	Polyester	Clear	-40°F to 212°F (-40°C to 100°C)	Thermal Transfer	Gloss clear thermal transfer-printable film with permanent acrylic-based adhesive. Designed for rough surfaces and applications where increased adhesion is required. 2 mil adhesive recommended for application on textured surfaces. UL recognized/CSA approved for rating plate applications.  
B-433	Polyester	White	-40°F to 212°F (-40°C to 100°C)	Thermal Transfer	Designed for electronic component marking and general purpose applications requiring good solvent, heat resistance and a label that can be easily removed. Removable acrylic-based adhesive. 
B-434	Metallized Polyester	Silver	-40°F to 194°F (-40°C to 90°C)	Thermal Transfer	Glossy metallized polyester with permanent acrylic-based adhesive. Designed for rough surfaces and applications where increased adhesion is required. 2 mil adhesive recommended for application on textured surfaces. UL recognized/CSA approved for rating plate applications.  
B-435	Metallized Polyester	Silver	-40°F to 194°F (-40°C to 90°C)	Thermal Transfer	High-performance material designed for thermal transfer printing. Withstands numerous solvents while maintaining excellent image quality. Ideal for rating plate applications and general purpose labeling.   

	*These materials are UL recognized.
	*These materials are CSA approved.
	*These materials are AGA approved.

*Refer to the full page charts on pages 280-281 for more information and complete listing of parts.



Master Materials Chart

Brady Material #	Material	Color	Temp. Range	Print Technology	Properties & Applications
B-436	Polyimide	Amber	-40°F to 518°F (-40°C to 270°C) 5 minutes at 518°F (270°C)	Thermal Transfer	Polyimide film with a removable silicone pressure sensitive adhesive designed to remove completely after high-temperature exposure. Can be used for top- or bottom-side component or board identification. Withstands extremely high temperatures.
B-437	Tedlar®	White or Yellow	-85°F to 275°F (-65°C to 135°C)	Thermal Transfer TLS2200	Polyvinylfluoride film with a permanent acrylic adhesive. Designed for cable and wire bundle identification, aerospace and military cable marking and applications where self-extinguishing properties are required. Available in white and yellow.
B-438	Metallized Polyester	Silver	-40°F to 104°F (-40°C to 40°C)	Thermal Transfer	Matte metallized polyester with a permanent adhesive. Designed for rating and serial plates requiring both high-performance and protection against removal. Designed to leave a checkerboard footprint if removed.
B-439	Colored Vinyl	Silver, Gold, Red, Purple, Yellow, Orange, Green, Black, Light Blue, White	-40°F to 104°F (-40°C to 40°C)	Thermal Transfer	Designed for use with thermal transfer printers in ambient conditions with limited solvent exposure. Ideal for applications requiring various colors - such as rating plates or finished product and general purpose identification. 
B-449	Polyolefin	White	-40°F to 194°F (-40°C to 90°C)	Thermal Transfer	Designed for use in temporary labeling applications requiring solvent resistance and print performance coupled with clean removability.
B-457	Polyimide	White	-94°F to 662°F (-70°C to 350°C) 80 seconds at 662°F (350°C)	Thermal Transfer TLS2200®	Polyimide film with a permanent acrylic adhesive, designed to withstand the various processes, fluxes and cleaning solvents encountered in the manufacture of printed circuit boards. Can be used for top- or bottom-side component or board identification. Glossy topcoat provides excellent contrast and smear resistance. 
B-459	Polyester	White	-40°F to 212°F (-40°C to 100°C)	Thermal Transfer TLS2200	Matte white with a permanent acrylic-based adhesive. Designed for electronic component marking and general purpose applications requiring good solvent and heat resistance.  
B-461	Polyester	Clear	-320°F to 230°F (-196°C to 130°C) 3 cycles of 4 hours in liquid nitrogen, at -320°F (-196°C)	Thermal Transfer	Clear film that can be offered with matte white printable zone in a self-laminating format. Provides excellent print smudge resistance and solvent resistance. Performs well in common laboratory environments such as liquid nitrogen, autoclave, freezer and hot water bath applications when laminated around itself.
B-464	Retro-reflective Polyester	Silver	-40°F to 176°F (-40°C to 80°C)	Thermal Transfer	Retroreflective polyester with permanent acrylic-based adhesive. Designed for long range bar code scanning in warehouse/bin locator applications. Recommended for indoor use only.
B-473	Polyester	White	-40°F to 248°F (-40°C to 120°C)	Thermal Transfer TLS2200	Static dissipative acrylic adhesive and static dissipative release liner. Ideal for bar code, printed circuit board and component identification.   
B-477	Polyimide	White	-94°F to 662°F (-70°C to 350°C) 80 seconds at 662°F (350°C)	Thermal Transfer TLS2200	Polyimide film with a permanent acrylic static dissipative adhesive and static dissipative release liner, designed to withstand the various processes, fluxes and cleaning solvents encountered in the manufacture of printed circuit boards. Can be used for top- or bottom-side component or board identification. Glossy topcoat provides excellent contrast and smear resistance.  
B-478	Polyimide	White	-94°F to 662°F (-70°C to 350°C) 80 seconds at 662°F (350°C)	Thermal Transfer TLS2200	1-mil low profile polyimide film with a permanent static dissipative adhesive and static dissipative release liner; designed to withstand the various processes, fluxes and cleaning solvents encountered in the manufacture of printed circuit boards. Glossy topcoat provides excellent contrast and smear resistance. Can be used for top- or bottom-side component or board identification.  
B-479	Polyimide	White	-94°F to 662°F (-70°C to 350°C) 80 seconds at 662°F (350°C)	Thermal Transfer TLS2200	1-mil low profile polyimide film with a permanent static dissipative adhesive and static dissipative release liner; designed to withstand the various processes, fluxes and cleaning solvents encountered in the manufacture of printed circuit boards. Matte topcoat provides excellent resistance to solder balling. Can be used for top- or bottom-side component or board identification.  
B-483	Polyester	White	-40°F to 248°F (-40°C to 120°C)	Thermal Transfer	General purpose labeling. Highest adhesion product for thermal transfer printing, designed for powder coated surfaces.  

	These materials have static dissipative adhesives.
	*These materials are UL recognized.
	*These materials are CSA approved.

*Refer to the full page charts on pages 280-281 for more information and complete listing of parts.



Brady Material #	Material	Color	Temp. Range	Print Technology	Properties & Applications
B-484	Polyester	White	-40°F to 248°F (-40°C to 120°C)	Thermal Transfer	1 mil white polyester with a permanent, ultra-aggressive adhesive. Designed for powder-coated surfaces and curved/angled surfaces.
B-486	Metallized Polyester	Silver	-40°F to 248°F (-40°C to 120°C)	Thermal Transfer	Matte metallized polyester with a permanent, ultra aggressive adhesive. Designed for applications like rating and serial plates that require high adhesion to textured metals, low surface energy plastics, or powder coated surfaces.  
B-487	Polyimide	White	-94°F to 662°F (-70°C to 350°C) 80 seconds at 662°F (350°C)	Thermal Transfer	Polyimide film with a permanent acrylic adhesive, designed to withstand the various processes, fluxes and cleaning solvents encountered in the manufacture of printed circuit boards. Matte topcoat provides excellent resistance to solder balling. Can be used for top- or bottom-side component or board identification. 
B-488	Polyester	White	-40°F to 320°F (-40°C to 160°C)	Thermal Transfer	Electronic PCB and component; bar code label and rating plates. High performance matte white.   
B-489	Polyester	White	-40°F to 248°F (-40°C to 120°C)	Thermal Transfer	Matte polyester with ultra aggressive, permanent adhesive. Designed for high adhesion to textured metals, low surface energy plastics, or powder coated surfaces.  
B-490	Polyester	White	—	Thermal Transfer	This material offers the unique ability to apply identification to a frost covered/cryogenically frozen surface.
B-495	Polyethylene Naphthalate (PEN)	White	-94°F to 464°F (-70°C to 240°C)	Thermal Transfer	High temperature PEN film with a permanent acrylic adhesive, designed to withstand most processes, fluxes and cleaning solvents encountered in the manufacture of printed circuit boards. Glossy topcoat provides excellent contrast and smear resistance. Can be used for top- or bottom-side component or board identification, except bottom-side Through Hole applications. 
B-497	Polyimide	White	-94°F to 662°F (-70°C to 350°C) 80 seconds at 662°F (350°C)	Thermal Transfer	1-mil low profile polyimide film with a permanent acrylic adhesive, designed to withstand the various processes, fluxes and cleaning solvents encountered in the manufacture of printed circuit boards. Matte topcoat provides excellent resistance to solder balling. Can be used for top- or bottom-side component or board identification. 
B-498	Vinyl Cloth	White	-40°F to 175°F (-40°C to 70°C)	Thermal Transfer TLS2200®	Wire, cable and component marking. Repositionable, removes cleanly. Suitable for general identification.
B-499	Nylon Cloth	White	-94°F to 194°F (-70°C to 90°C)	Thermal Transfer Dot Matrix ID PRO Plus LS2000, TLS2200	Wire and electronic component marking. Permanent adhesive. High adhesion makes all purpose wire marking ideal for environments where heat, cold, oil and dirt are present. Also ideal for laboratory vial identification. 
B-500	Vinyl Cloth	White and Colors	-40°F to 180°F (-40°C to 82°C)	Pre-Printed	Moderately resistant to heat, oil and dirt. Environments containing heat, oil or dirt. Wire and cable marker. Repositionable.
B-502	Vinyl Cloth	White	-40°F to 180°F (-40°C to 82°C)	Dot Matrix ID PRO Plus LS2000	Resistant to oil, water, humidity. Excellent printability; ink-receptive coating. Applications requiring general-purpose permanent or temporary labeling or marking with printable or write-on properties. Leaves no adhesive residue when removed - good EPROM label. Cable and wire markers. Repositionable.
B-503	Cloth	White	-40°F to 194°F (-40°C to 90°C)	Dot Matrix	Highly conformable. Self-extinguishing, printable tag. Designed for wire and cable identification. Meets UL94VTM-0 for flame retardancy.
B-505	Polyester	White	-40°F to 266°F (-40°C to 130°C)	Dot Matrix	Self-extinguishing, white polyester with a zone coated, permanent pressure sensitive acrylic adhesive. Designed to be used as a connector pull tab and passes the requirements of UL94 VTM-0.
B-508	Nomex® Tag	White or Yellow	-40°F to 180°F (-40°C to 82°C)	Dot Matrix	Computer-printable Nomex tag stock. Designed as a high-performance wire bundle and cable identification tag for use in harsh environments.
B-520	Glass Cloth	White	-85°F to 932°F (-65°C to 500°C)	Thermal Transfer Custom No Stock Parts	Woven glass cloth. Adheres strongly to glass and a variety of metal surfaces. Designed to withstand harsh temperatures, acidic and alkaline environments. Label is pressure sensitive at room temperature and becomes permanently affixed at temperatures above 400°C.
B-521	Glass Cloth	White, Green, Red, Purple, Yellow	-85°F to 932°F (-65°C to 500°C)	Custom No Stock Parts	Non-printable woven glass cloth. Adheres strongly to glass and a variety of metal surfaces. Designed to withstand harsh temperatures, acidic and alkaline environments. Label is pressure sensitive at room temperature and becomes permanently affixed at temperatures above 400°C.

-  *These materials are UL recognized.
-  *These materials are CSA approved.
-  *These materials are AGA approved.

*Refer to the full page charts on pages 280-281 for more information and complete listing of parts.



Master Materials Chart

Brady Material #	Material	Color	Temp. Range	Print Technology	Properties & Applications
B-540	Saturated Crepe Paper	Beige	-40°F to 122°F (-40°C to 50°C)	N.A.	Good conformability; resistant to heat and moisture. Strips cleanly when removed. Temporary protective covers such as paint masking. Good for small sized masks.
B-605	Tedlar®	White	-40°F to 260°F (-40°C to 127°C)	Pre-Printed	Overlaminated of polyester. Resistant to oil, solvents, dirt. Abrasion-resistant. Environments containing oil, solvents or dirt. Abrasive environments. Excellent for wire marking.
B-607	Vinyl	White	-40°F to 158°F (-40°C to 70°C)	Dot Matrix ID PRO® Plus LS2000	Tamper-evident film with a permanent acrylic adhesive. Designed to fracture easily to prevent one-piece removal. 
B-609	Paper	White	-40°F to 158°F (-40°C to 70°C)	Dot Matrix	Permanent adhesive; smudge resistant; write-on coating; low internal strength. Applications requiring economical, general-purpose label.
B-614	Polyester	White	-40°F to 200°F (-40°C to 93°C)	Dot Matrix ID PRO Plus LS2000	High resolution. Resistant to solvents, smudging, high-temperature. Applications requiring solvent resistance and high-temperature performance. Bar code printable.
B-619	Polyester	White	-94°F to 293°F (-70°C to 145°C)	Dot Matrix ID PRO Plus LS2000	Resistant to solvents; smudge-resistant. High resolution; high-temperature performance. Applications requiring bar code printing, electronic component, solvent or high temperature resistance and circuit board ID. 
B-621	Polyester	Clear	-93°F to 248°F (-70°C to 120°C)	Dot Matrix ID PRO Plus LS2000	Excellent write-on coating. Computer-printable overlaminate. Translucent.
B-624	Polyester	White	-40°F to 248°F (-40°C to 120°C)	Dot Matrix ID PRO Plus LS2000	Excellent write-on and computer-printability. Applications requiring durable write-on bar code printable or computer-printable labels. Suitable for indoors or outdoors. Adheres well to rough surfaces.
B-627	Polyester	Gold	-40°F to 248°F (-40°C to 120°C)	Custom No Stock Parts	High heat resistance; dimensional stability. Treated for better ink receptivity. Ideal for high-quality labels, emblems and rating plates. 
B-632	Tedlar	White	-94°F to 266°F (-70°C to 130°C)	Dot Matrix ID PRO Plus LS2000	Smear-resistant; computer-printable. Good flexibility. Applications requiring write-on and self-extinguishing properties. Excellent computer-printable wire marker material.
B-637	Tedlar	White & Yellow	-40°F to 266°F (-40°C to 130°C)	Dot Matrix ID PRO Plus LS2000	Good computer-printability; self-extinguishing. MIL-M-87958. Applications requiring self-extinguishing, easily printed cable or wire identification. Aerospace and military cable marking.
B-639	Tedlar	Clear	-94°F to 248°F (-70°C to 120°C)	Custom No Stock Parts	Resistant to UV light and weathering; not printable. Overlaminated for labels where resistance to UV light and weathering is necessary.
B-642	Tedlar®	Clear/ White	-94°F to 266°F (-70°C to 130°C)	Dot Matrix Thermal Transfer	Applications requiring self-extinguishing identification. Self-laminating, wire, cable and laboratory vial marking. Excellent abrasion and smudge resistance.
B-652	Polyimide	Amber	-94°F to 572°F (-70°C to 300°C) 5 minutes at 572°F (300°C)	Dot Matrix ID PRO® Plus LS2000 Laser	Polyimide film with a permanent acrylic adhesive, designed to withstand the various processes, fluxes and cleaning solvents encountered in the manufacture of printed circuit boards. Can be used for top- or bottom-side component or board identification. Withstands extremely high temperatures.
B-654	Polyimide	Clear	Up to 320°F (160°C)	N.A.	1-mil clear polyimide film with a removable silicone adhesive. Ideal for use as a high temperature mask in printed circuit board applications. Removes cleanly after processing through vapor phase or wave solder cycle.
B-658	Polyimide	Amber	-40°F to 518°F (-40°C to 270°C) 5 minutes at 518°F (270°C)	Dot Matrix Laser	Polyimide film with a removable silicone pressure sensitive adhesive designed to remove completely after high temperature exposure. Can be used for top- or bottom-side component or board identification. Withstands extremely high temperatures.
B-673	Metallized Polyester	Silver	-40°F to 293°F (-40°C to 145°C)	Dot Matrix	Metallized polyester film with a removable silicone adhesive, designed for EPROM applications where opacity and removability are important. UV opaque, high temperature and good chemical and solvent resistance.
B-691	Polypropylene	Clear	-40°F to 212°F (-40°C to 100°C)	Custom No Stock Parts	Biaxially oriented film. Excellent clarity and flexibility; not printable. Clear protective overlaminates for most labels.

 *These materials are UL recognized.
 *These materials are CSA approved.

*Refer to the full page charts on pages 280-281 for more information and complete listing of parts.

Brady Material #	Material	Color	Temp. Range	Print Technology	Properties & Applications
B-693	Metallized Polyester	Silver	-40°F to 248°F (-40°C to 120°C)	Dot Matrix	Low-cost metallized identification or rating plate material. It exhibits good smudge, solvent, and heat resistance.
B-702	Vinyl-Coated Polyester	White	-40°F to 221°F (-40°C to 105°C)	Pre-Printed Thermal Transfer	High adhesion; good conformability; low profile; resistant to oil and mild solvents. Environments containing oil or mild solvents. Ideal for wire marking.
B-707	Polyester	White	-40°F to 267°F (-40°C to 130°C)	Laser	Electronic component labeling; general identification. Rough surface application; Stronger bond to low surface energy plastics.  
B-708	Vinyl	White	-40°F to 150°F (-40°C to 66°C)	Pre-Printed	Good strength and conformability. Resistant to oil, mild solvents and water. Environments containing oil, mild solvents or water. Indoor or outdoor use. Excellent for cable identification.
B-709	Polyester	White	-40°F to 158°F (-40°C to 70°C)	Laser	Applications requiring general purpose permanent and temporary labeling or marking with printable or write-on properties. Leaves no adhesive residue when removed from PC board.
B-712	Polyester	Clear	-40°F to 221°F (-40°C to 105°C)	Laser	Electronic component labeling; general identification. Rough surface application. Stronger bond to low surface energy plastics.
B-722	Polyester	Clear	-40°F to 221°F (-40°C to 105°C)	Laser	Permanent acrylic-based adhesive. Design for rating and serial plates using alphanumeric, bar codes, graphic symbols, and logos that require name plate quality. Withstands numerous solvents and can be applied to variable surfaces.
B-725	Vinyl	White	Up to 176°F (Up to 80°C)	Custom Quick Dot Markers	Good conformability; dielectric strength. Electrical-grade cable markers.
B-737	Tedlar	White or Yellow	-40°F to 266°F (-40°C to 130°C)	Laser	Self-extinguishing. Meets MIL-M-87958. Applications requiring self-extinguishing, easily printed cable or wire identification. Aerospace and military cable marking. Repositionable.
B-747	Polyester	White or Yellow	-40°F to 267°F (-40°C to 130°C)	Laser	Electronic PCB component, bar code labels. Excellent solvent and smudge resistant; and equipment labeling has high-resolution and high temperature performance; available in white only.  
B-759	Paper	White	-94°F to 193°F (-70°C to 90°C)	Laser	Permanent adhesive; smudge resistant. Applications requiring economical, general purpose label. Bar code-printable. Excellent toner adhesion.
B-773	Polyester	Silver	-85°F to 248°F (-65°C to 120°C)	Laser	Permanent acrylic adhesive. Designed for rating and serial plate that utilize alphanumeric, graphic symbols and logos. Electronic component marking. Designed to withstand numerous solvents and variable temperatures. Adheres to a variety of surfaces.  
B-799	Nylon Cloth	White	-40°F to 193°F (-40°C to 90°C)	Laser	Recommended for applications requiring permanent wire marking or general labeling.
B-841	Polyester	White	-40°F to 311°F (-40°C to 155°C)	Dot Matrix LS2000	Print-receptive coating. Resistant to tearing, weathering, abrasion, heat, cold, solvents and oil. Tag for outdoor or harsh environments where legibility and tear-resistance are important.
B-917	Aluminum Foil	Silver	-40°F to 266°F (-40°C to 130°C)	Dot Matrix	Printable; resistant to solvents, high temperatures. Identification and serialized labels, rating plates, general labeling. Full hard aluminum.  
B-953	Polyester	White	-40°F to 266°F (-40°C to 130°C)	Pre-Printed	1-mil low profile polyester film with an acrylic adhesive, designed to identify small electrical or electronic components. Excellent resistance to high temperatures and solvents. Capable of accepting extremely small print.
B-966	Polyester	Clear	-94°F to 248°F (-70°C to 120°C)	N/A	Release-coated surface. Not printable. Overlaminates for PermaShield™ labels. Clear/durable.
B-969	Metallized Polyester	Silver	-94°F to 293°F (-70°C to 145°C)	Dot Matrix ID PRO Plus LS2000	Print-receptive topcoat. Rating or serial plate, product information property identification, warranty labels and inventory control labels, electronic component marking. Suitable for printing.  
B-999	Polyester	Clear	-40°F to 320°F (-40°C to 160°C)	Custom No Stock Parts	Printable. Aircraft tubing identification. Ideal for use as fluid wire tape.
B-7546	Polyester	White	-40°F to 175°F (-40°C to 80°C)	Thermal Transfer	Tamper evident; leaves "void" footprint when removed.  

 *These materials are UL recognized.
 *These materials are CSA approved.

*Refer to the full page charts on pages 280-281 for more information and complete listing of parts.

Master Materials Chart

Brady Material #	Material	Color	Temp. Range	Print Technology	Properties & Applications
B-7566	Polyester	Gloss Clear	-40°F to 175°F (-40°C to 80°C)	Thermal Transfer	Tamper Evident; leaves "void" footprint when removed.
B-7576	Metallized Polyester	Silver	-40°F to 212°F (-40°C to 100°C)	Thermal Transfer	Tamper evident; leaves "void" footprint when removed. 
B-8423	Polyester	White	-94°F to 248°F (-70°C to 120°C)	Thermal Transfer	Thermal Transfer with a permanent acrylic adhesive. Semi-gloss finish; excellent for bar code labels.
B-8425	Polypropylene	White	-40°F to 194°F (-40°C to 90°C)	Thermal Transfer	General purpose labeling, asset identification and warning/instructional labeling.

 *These materials are UL recognized.

**Refer to the full page charts on pages 280-281 for more information and complete listing of parts.*

Print Technology / Materials Cross-Reference Chart

Acetate Labels

	Thermal Transfer	Laser	Dot Matrix	Ink Jet
Tamper Evident	B-358 Clear Tamper Resistant Acetate B-359 Matte White Tamper Resistant Acetate			

Self-Laminating Labels

	Thermal Transfer	Laser	Dot Matrix	Ink Jet
Vinyl Film	B-427 Self-Laminating Vinyl		B-292 Self-Laminating Vinyl	B-117 Self-Laminating Vinyl
Polyester Film	B-461 Self-Laminating Polyester	B-361 Self-Laminating Polyester	B-361 Self-Laminating Polyester	
Polyvinyl Fluoride Film (Tedlar®)	B-642 Self-Laminating Tedlar®		B-642 Self-Laminating Tedlar	

Paper Labels

	Thermal Transfer	Laser	Dot Matrix	Ink Jet
Permanent Adhesive	B-424 Matte White Permanent Paper B-402 Matte White Permanent Low Cost Paper	B-759 Matte White Permanent Paper	B-122 Matte White Tamper-Evident Paper B-609 Matte White Permanent Paper	B-113 Matte White Permanent Paper
Removable Adhesive	B-408 Matte White Repositional Paper		B-121 Matte White Smudge Resistant Removable Paper B-110 Matte White Moisture Resistant Removable Paper	

Cloth Labels

	Thermal Transfer	Laser	Dot Matrix	Ink Jet
Vinyl Cloth	B-498 Matte White Repositional Vinyl Cloth		B-502 Matte White Repositional Vinyl Cloth	B-115 Matte White Repositional Vinyl Cloth
Nylon Cloth	B-499 Matte White Nylon Cloth	B-799 Matte White Nylon Cloth	B-499 Matte White Nylon Cloth	

Vinyl Labels

	Thermal Transfer	Laser	Dot Matrix	Ink Jet
Tamper Evident	B-351 Matte White Tamper Resistant Vinyl B-352 Matte Silver Tamper Resistant Vinyl		B-607 Matte White Tamper Evident Vinyl	
Permanent, Non-Tamper Evident	B-439 Glossy White Permanent Vinyl			

Polyolefin Labels

	Thermal Transfer	Laser	Dot Matrix	Ink Jet
Permanent Products	B-407 Matte Super Clear Polyolefin B-8425 Matte White Permanent Polypropylene	B-409 Matte White Permanent Polyolefin	B-409 Matte White Permanent Polyolefin	
Removable Products	B-449 Matte White Removable Polyolefin			
Tamper Evident Products		B-410 Matte White Tamper Evident Polyolefin		

Tedlar® is a registered trademark of DuPont.

Print Technology / Materials Cross-Reference Chart

White Polyester Labels

	Thermal Transfer	Laser	Dot Matrix	Ink Jet
Permanent Acrylic Adhesive	B-423 Glossy White Permanent Polyester B-473 Glossy White Static Dissipative Polyester B-422 Glossy White Super Permanent Polyester B-459 Matte White Permanent Polyester B-488 High Performance Matte White Permanent Polyester B-8423 Satin White Permanent Polyester	B-747 Matte White Permanent Polyester B-707 Rough Surface Matte White Permanent Polyester	B-619 Matte White Permanent Polyester	B-107 Matte White Permanent Polyester
Tamper Evident	B-350 Glossy White Water Indicating Paper/Polyester B-354 Glossy White Indicating Paper/Polyester B-7546 Glossy White Tamper Evident Polyester			
Permanent Rubber Adhesive	B-483 Ultra Aggressive Permanent Glossy White Polyester B-484 Ultra Aggressive Permanent 1 mil Glossy White Polyester B-489 Ultra Aggressive Permanent Matte White Polyester		B-624 Rough Surface Matte White Permanent Polyester	
Removable Adhesives	B-433 Glossy White Removable Polyester	B-709 Matte White Removable Polyester		

Clear Polyester Labels

	Thermal Transfer	Laser	Dot Matrix	Ink Jet
Permanent Acrylic Adhesive	B-430 Glossy Clear Permanent Polyester B-432 Rough Surface Glossy Clear Permanent Polyester	B-722 Translucent Permanent Polyester B-712 Rough Surface Translucent Permanent Polyester	B-621 Matte Clear Permanent Polyester with 0.062" Black Border	
Tamper Evident	B-7566 Glossy Clear Tamper Evident Polyester			

Metallized Polyester Labels

	Thermal Transfer	Laser	Dot Matrix	Ink Jet
Permanent Acrylic Adhesive	B-428 Matte Metallized Polyester with 0.062" Black Border B-435 Glossy Metallized Permanent Polyester B-434 Rough Surface Glossy Metallized Permanent Polyester B-464 Retroreflective Silver Polyester	B-773 Matte Metallized Permanent Polyester	B-969 Matte Metallized Permanent Polyester B-693 Low Cost Matte Metallized Polyester B-164 High Temperature Matte Metallized Permanent Polyester	
Permanent Rubber Adhesive	B-486 Ultra Aggressive Matte Metallized Polyester			
Tamper Evident Labels	B-438 Matte Metallized Tamper Evident Polyester B-7576 Tamper Evident Metallized Polyester			
Removable Adhesives			B-673 Matte Metallized Removable Polyester	

Polyethylene Napthalate (PEN) Labels

	Thermal Transfer	Laser	Dot Matrix	Ink Jet
Permanent Acrylic Adhesive	B-495 Glossy White High Temperature PEN			

Print Technology / Materials Cross-Reference Chart

Polyvinyl Fluoride (Tedlar®) Labels

	Thermal Transfer	Laser	Dot Matrix	Ink Jet
Permanent Acrylic Adhesive	B-437 Flame Retardant Tedlar	B-737 Flame Retardant Tedlar	B-637 Self Extinguishing Tedlar B-632 Low Profile Flame Retardant Tedlar	

Polyimide Labels

	Thermal Transfer	Laser	Dot Matrix	Ink Jet
White Topcoat	B-457 High Temperature Glossy White Polyimide B-477 Glossy White Static Dissipative Polyimide B-478 Glossy White Low Profile Static Dissipative Polyimide B-479 Matte White Low Profile Static Dissipative Polyimide B-487 High Temperature Matte White Polyimide B-497 Matte White Low Profile Polyimide			
Amber Topcoat	B-426 High Temperature Amber Polyimide B-436 Matte Amber Removable Polyimide	B-652 High Temperature Amber Polyimide B-658 Matte Amber Removable Polyimide	B-652 High Temperature Amber Polyimide B-658 Matte Amber Removable Polyimide	

Tag Materials

	Thermal Transfer	Laser	Dot Matrix	Ink Jet
Cloth Products			B-503 Matte White Flame Retardant Vinyl	
Polyolefin Products	B-109 Matte White Polyethylene Tag B-411 Matte White Polyolefin Tag B-412 Matte White Polypropylene Tag/Insert		B-109 Matte White Polyethylene Tag	
Polyester Film Products			B-841 Matte White Polyester	
Polyaramid Paper Products			B-508 Nomex® Tag	

Nomex® and Tedlar® are registered trademarks of DuPont.

CSA Accepted Materials



Printing Systems Category (Class 7923-01)

The Printing Systems Category lists label materials, ribbons or toners and printers which can be used to generate CSA accepted labels by an end user.

Adhesive Label Category (Class 7921-04)

The Adhesive Label Category lists pre-printed label materials produced with approved printing processes.

Brady Material Number	Printing Systems Category (Class 7923-01)			Adhesive Label Category (Class 7921-04)			
	Accepted	With Ribbon Series/Toner	Printers	Accepted	Accepted Pre-Printed Methods	Additional Printing (by end user)	Printers
B-422	●	R6000	All Brady, Zebra, Datamax and TLS 2200™	● ▲	R6000, UV screen ink all colors	R6000	All Brady, Zebra and Datamax
B-423	●	R6000	All Brady, Zebra, Datamax and TLS 2200	● ▲	R6000, UV screen ink all colors	R6000	All Brady, Zebra and Datamax
B-425	●	R6200	All Brady, Zebra, Datamax and Intermec	✘	_____	_____	_____
B-428	●	R4300 (only on TLS 2200), R6200	All Brady, Zebra, Datamax and TLS 2200	●	R4300, UV screen and solvent screen ink all colors	R6200, R4300	All Brady, Zebra, and Datamax
B-430	●	R6000	All Brady, Zebra, Datamax and TLS 2200	●	R6000, UV screen ink all colors	R6000	All Brady, Zebra, and Datamax
B-432	●	R6000	All Brady, Zebra, Datamax and TLS 2200	●	R6000, UV screen ink all colors	R6000	All Brady, Zebra, and Datamax
B-434	●	R6000, R4900	All Brady, Zebra and Datamax	●	R6000, UV screen and solvent screen ink all colors	R6000	All Brady, Zebra, and Datamax
B-435	●	R6000	All Brady, Zebra and Datamax	●	R6000, UV screen and solvent screen ink all colors or flexographic black ink	R6000	All Brady, Zebra, Datamax and Intermec
B-438	✘	_____	_____	●	_____	R4300	All Brady and Zebra
B-459	●	R6000, R4900	All Brady, Zebra, Datamax and TLS 2200	✘	_____	_____	_____
B-473	●	R6000	All Brady, Zebra, Datamax and Intermec	● ▲	R6000, UV screen ink all colors	R6000	All Brady, Zebra, Datamax and Intermec
B-483	●	R6000	All Brady, Zebra, Datamax and Intermec	● ▲	R6000, UV screen ink all colors	R6000	All Brady, Zebra, Datamax and Intermec
B-486	●	R4300, R6200	All Brady, Zebra and Datamax	●	R4300, UV screen and solvent screen ink all colors	R4300 R6200	All Brady, Zebra and Datamax
B-488	●	R4300, R6200	All Brady, Zebra, Datamax and Intermec	●	UV screen ink all colors	R4300, R6200	All Brady, Zebra and Datamax
B-489	●	R4300, R6200	All Brady, Zebra, Datamax and Intermec	●	UV screen ink all colors	R4300, R6200	All Brady, Zebra, Datamax and Intermec
B-499	●	R4300	TLS 2200	✘	_____	_____	_____
B-607	✘	_____	_____	●	Solvent screen all colors, UV screen all colors, letterpress black only	R2000, R5000	_____
B-619	✘	_____	_____	●	Solvent screen all colors, UV screen all colors, letterpress black only	R2000, R5000	_____
B-627	✘	_____	_____	●	Solvent screen all colors, UV screen all colors, flexographic black only, letterpress black only	R2000, R5000	_____
B-707	●	refer to file	refer to file	✘	_____	_____	_____
B-747	●	refer to file	refer to file	✘	_____	_____	_____
B-773	●	refer to file	refer to file	✘	_____	_____	_____
B-917	✘	_____	_____	●	UV screen all colors	_____	_____
B-969	✘	_____	_____	●	Solvent screen all colors, UV screen all colors	R2000, R5000	_____
B-7546	●	R6000	All Brady, Zebra, Datamax and TLS 2200	✘	_____	_____	_____
B-8423	●	R6000, R6200	All Brady, Zebra and Datamax	●	UV flexo, black only outdoor, indoor no limitations for CSA acceptance, additional printing by end-user	R6000, R6200	All Brady, Zebra and Datamax
B-8424	✘	_____	_____	●	UV flexo (no color limits as this only has indoor approval), additional printing by end-user	R6000	All Brady, Zebra and Datamax
B-8457	✘	_____	_____	●	_____	R6000, R6000 HV	All Brady and Zebra
B-8477	✘	_____	_____	●	_____	R6000, R6000 HV	All Brady and Zebra

Refer to bradyid.com, Support/Knowledge Base document number JM173350 (titled CSA Accepted Materials) for the latest up to date information and more details. Brady's Acceptance Record with CSA is LS41833.

- ▲ These materials are also suitable for flood coating with a background ink (solvent screen) and additional thermal transfer printing with the R6000 series ribbon.
- Yes
- ✘ No

UL Recognized Materials (UL969) Marking and Labeling Systems



Printing Materials Category (PGJ12)

Brady's file number in category PGJ12 is MH 17154. This category lists label materials and ribbons or toners which can be used to generate UL recognized labels by an end user. This category also includes labels pre-printed with printing inks (at Brady) in which end users can then add print (thermal transfer or laser).

Marking and Labeling Systems Category (PGDQ2)

Brady's file number in category PGDQ2 is MH 10939. This category lists pre-printed labels produced with approved printing processes and inks. Thermal transfer printed labels in this category can be sold as pre-printed labels using thermal transfer print methods (Brady Bureau of Identification). Where applicable, additional printing can be added to labels by end users with the listed dot matrix ribbons.

Brady Material Number	Printing Materials Category (PGJ12)			Marking and Labeling Systems Category (PGDQ2)		
	Recognized	With Ribbon Series/Toner	Printing Ink	Recognized	Approved Pre-Printed Methods	Additional Printing (by end user) via dot matrix ribbons
B-292	✘	—	—	●	—	R2000, R5000, R7300
B-422	● ▲	R4900, R6000, R6000 HV	UV screen ink all colors, solvent screen	● ▲	R6000, R4900, UV screen ink all colors, solvent screen	—
B-423	● ▲	R4900, R6000, R6000 HV	UV screen ink all colors, solvent screen	● ▲	R6000, R4900, UV screen ink all colors, solvent screen	—
B-425	●	R6200	—	✘	—	—
B-427	●	R4300, R6200	—	✘	—	—
B-428	●	R4300	UV screen ink or solvent screen ink all colors	●	R4300, UV screen ink or solvent screen all colors	—
B-430	●	R4900, R6000	UV screen ink all colors	●	R6000, R4900, UV screen ink all colors	—
B-432	●	R4900, R6000	UV screen ink all colors	●	R6000, R4900, UV screen ink all colors	—
B-433	●	R4900, R6000, R6200	—	✘	—	—
B-434	●	R4800, R4900, R6000 all colors	UV screen ink or solvent screen ink	✘	—	—
B-435	●	R4900, R6000	Solvent screen in all colors, flexographic black, UV screen	✘	—	—
B-438	●	R4300	—	✘	—	—
B-457	●	R6000	—	●	R6000	—
B-459	●	R4400, R4900, R6000	—	✘	—	—
B-473	● ▲	R4900, R6000	UV screen ink all colors, solvent screen	▲	R6000, R4900, UV screen ink all colors	—
B-477	●	R6000	—	●	R6000	—
B-478	●	R6000	—	●	Not listed in this file	—
B-479	●	R4800, R6000	—	✘	—	—
B-483	● ▲	R4900, R6000	UV screen ink all colors, solvent screen	● ▲	R4900, R6000, R6000 HV, UV screen ink all colors	—
B-484	●	R4900, R6000, R6000 HV	Solvent screen, UV screen	● ▲	R4900, R6000, R6000 HV, UV screen ink all colors	—
B-486	●	R4300	UV screen ink or solvent screen ink all colors	●	R4300, UV screen ink or solvent screen all colors	—
B-487	●	R4800, R6000	—	● ▲	R4800, R6000, R6000 HV	—
B-488	●	R4300, R6200	UV screen ink all colors	✘	—	—
B-489	●	R4300, R6200	UV screen ink all colors	●	R4300, R6200, UV screen ink all colors	—
B-495	●	R6000	—	✘	R6000	—
B-497	●	R4800, R6000	—	✘	—	—
B-499	●	R4300, R4900 (R2000, R5000 dot matrix)	—	✘	—	—
B-607	✘	—	—	●	Solvent screen all colors, UV screen all colors, UV rotary letterpress black only	R2000, R5000
B-619	✘	—	—	●	Solvent screen all colors, UV screen all colors, flexographic black or blue only, letterpress black only	R2000, R5000
B-707 & B-707/ B-966B (PSL)	●	R4300	—	✘	—	—
B-747 & B-747/ B-966B (PSL)	●	R4300	—	✘	—	—
B-773 & B-773/ B-966B (PSL)	●	refer to file	—	✘	—	—
B-917	✘	—	—	●	Solvent screen all colors, UV screen all colors, flexographic all colors, letterpress black only	—
B-969	✘	—	—	●	Solvent screen all colors, UV screen all colors, flexographic black only, letterpress black only	R2000, R5000
B-7546	●	R6000	—	✘	—	—
B-7576	●	R4900, R6000	—	✘	—	—
B-8423	●	R6000, R6200	UV flexo, yellow, blue, black, outdoor no color, limitations indoor	✘	R6000, R6200, UV flexo, yellow, blue, black, outdoor no color, indoor limitations	—
B-8425	●	R6000, R6000 HV	UV flexo	✘	R6000, R6000, UV flexo	—

Refer to bradyid.com, Support/Knowledge Base document number JM134823 (titled UL Recognized Components) for the latest up to date information and more details.

- ▲ These materials are also suitable for flood coating with a background ink (solvent screen) and additional thermal transfer printing with the R6000 series ribbon.
- Yes
- ✘ No

Wire Conductor Dimension Guide

Size AWG. *	Type THW Wire O.D. Inch (mm)	Circumference	Type THHN Wire O.D. Inch (mm)	Circumference	Type Teflon® Wire O.D. Inch (mm)	Circumference	Type PVC Wire O.D. Inch (mm)	Circumference
22	-	-	-	-	0.060 (1.52)	0.190 (4.77)	0.062 (1.57)	0.190 (4.93)
20	-	-	-	-	0.068 (1.73)	0.210 (5.43)	0.069 (1.75)	0.220 (5.50)
18	0.108 (2.74)	0.340 (2.64)	0.089 (2.26)	0.280 (7.10)	0.079 (2.01)	0.250 (6.31)	0.079 (2.00)	0.250 (6.28)
16	0.118 (3.00)	0.370 (9.42)	0.100 (2.54)	0.310 (7.98)	0.089 (2.26)	0.280 (7.10)	0.092 (2.34)	0.290 (7.35)
14	0.162 (4.11)	0.510 (12.91)	0.105 (2.67)	0.330 (8.38)	-	-	0.138 (3.50)	0.430 (10.99)
12	0.179 (4.55)	0.560 (14.29)	0.122 (3.10)	0.380 (9.73)	-	-	0.158 (4.01)	0.500 (12.59)
10	0.199 (5.05)	0.620 (15.86)	0.153 (3.89)	0.480 (12.21)	-	-	0.183 (4.65)	0.570 (14.60)
8	0.276 (7.01)	0.870 (22.01)	0.218 (5.54)	0.680 (17.40)	-	-	0.250 (6.35)	0.790 (19.94)
6	0.323 (8.20)	1.010 (25.75)	0.257 (6.53)	0.810 (20.50)	-	-	-	-
4	0.372 (9.45)	1.170 (29.67)	0.328 (8.33)	1.030 (26.16)	-	-	-	-
3	0.401 (10.19)	1.260 (32.00)	0.356 (9.04)	1.120 (28.39)	-	-	-	-
2	0.433 (11.00)	1.360 (34.54)	0.388 (9.86)	1.220 (30.96)	-	-	-	-
1	0.508 (12.90)	1.600 (40.51)	0.450 (11.43)	1.410 (35.89)	-	-	-	-
1/0	0.549 (13.95)	1.720 (43.80)	0.491 (12.47)	1.540 (39.16)	-	-	-	-
2/0	0.595 (15.11)	1.870 (47.45)	0.537 (13.64)	1.690 (42.83)	-	-	-	-
3/0	0.647 (16.43)	2.030 (51.59)	0.588 (14.94)	1.850 (46.91)	-	-	-	-
4/0	0.705 (17.91)	2.210 (56.24)	0.646 (16.41)	2.030 (51.53)	-	-	-	-

*American Wire Gauge

Compatible to EU Directive 2002 / 95 / RoHS

Material*	Results	Material*	Results	Material*	Results	Material*	Results
B-11	Pass ¹	B-422	Pass ¹	B-495	Pass ¹	B-712	Pass ¹
B-12	Pass ¹	B-423	Pass ¹	B-497	Pass ¹	B-722	Pass ¹
B-103	Pass ¹	B-424	Pass ¹	B-498	Pass ¹	B-725 white	Pass ¹
B-104	Pass ¹	B-425	Pass ¹	B-499	Pass ¹	B-737 white	Pass ¹
B-107	Pass ¹	B-426	Pass ¹	B-500 dark blue	Pass ¹	B-737 yellow	Pass ¹
B-109 white	Pass ¹	B-428	Pass ¹	B-500 dark green	Pass ¹	B-747 white	Pass ¹
B-110	Pass ¹	B-430	Pass ¹	B-500 orange	Pass ¹	B-747 yellow	Pass ¹
B-111	Pass ¹	B-432	Pass ¹	B-500 printed	Pass ¹	B-759	Pass ¹
B-112	Pass ¹	B-433	Pass ¹	B-500 red	Pass ¹	B-773	Pass ¹
B-113	Pass ¹	B-434	Pass ¹	B-500 white	Pass ¹	B-799	Pass ¹
B-115	Pass ¹	B-435	Pass ¹	B-502 white	Pass ¹	B-966B	Pass ¹
B-121	Pass ¹	B-436	Pass ¹	B-502 yellow	Pass ¹	B-969	Pass ¹
B-122	Pass ¹	B-437	Pass ¹	B-503	Pass ¹	B-7546	Pass ¹
B-124	Pass ¹	B-438	Pass ¹	B-505	Pass ¹	B-7566	Pass ¹
B-145	Pass ¹	B-439 White	Pass ¹	B-508 white	Pass ¹	B-7576	Pass ¹
B-164	Pass ¹	B-439 yellow	Pass ¹	B-508 yellow	Pass ¹	B-8423	Pass ¹
B-184	Pass ¹	B-439 light blue	Pass ¹	B-540	Pass ¹	B-8425	Pass ¹
B-302	Pass ¹	B-439 purple	Pass ¹	B-605 white	Pass ¹	B-8457	Pass ¹
B-319	Pass ¹	B-439 white	Pass ¹	B-607	Pass ¹		
B-321	Pass ¹	B-439 black	Pass ¹	B-609	Pass ¹	Ribbon	Results
B-322	Pass ¹	B-439 silver	Pass ¹	B-619	Pass ¹	R2000 Series Black	Pass ¹
B-330	Pass ¹	B-449	Pass ¹	B-621	Pass ¹	R4300	Pass ¹
B-341	Pass ¹	B-451	Pass ¹	B-624	Pass ¹	R4400 blue	Pass ¹
B-342	Pass ¹	B-457	Pass ¹	B-632	Pass ¹	R4400 green	Pass ¹
B-350	Pass ¹	B-459	Pass ¹	B-637 white	Pass ¹	R4400 red	Pass ¹
B-351	Pass ¹	B-461	Pass ¹	B-637 yellow	Pass ¹	R4400 white	Pass ¹
B-352	Pass ¹	B-466	Pass ¹	B-639	Pass ¹	R4500 blue	Pass ¹
B-354	Pass ¹	B-473	Pass ¹	B-642	Pass ¹	R4500 red	Pass ¹
B-358	Pass ¹	B-477	Pass ¹	B-652	Pass ¹	R4500 silver	Pass ¹
B-359	Pass ¹	B-478	Pass ¹	B-654	Pass ¹	R4800 white	Pass ¹
B-361	Pass ¹	B-479	Pass ¹	B-658	Pass ¹	R4900	Pass ¹
B-389	Pass ¹	B-483	Pass ¹	B-673	Pass ¹	R5000	Pass ¹
B-402	Pass ¹	B-484	Pass ¹	B-688	Pass ¹	R5200	Pass ¹
B-407	Pass ¹	B-486	Pass ¹	B-693	Pass ¹	R6000	Pass ¹
B-408	Pass ¹	B-487	Pass ¹	B-697	Pass ¹	R6100	Pass ¹
B-409	Pass ¹	B-488	Pass ¹	B-702	Pass ¹	R6200	Pass ¹
B-410	Pass ¹	B-489	Pass ¹	B-707	Pass ¹	R6300	Pass ¹
B-412	Pass ¹	B-490	Pass ¹	B-709	Pass ¹	R7300	Pass ¹

* All preprinted materials listed as "Pass" were tested using black ink only. If your application requires a preprinted label with colors other than black, please contact Brady directly for compatibility information.

¹ Labels with our thermal transfer printers must be printed with the proper RoHS compatible ribbon to meet RoHS specifications. Based on the results of testing using recognized analytical methods performed by a third party, independent laboratory, the base material is RoHS compliant to the current TAG MCV proposal to the EU Commission for Cadmium, Lead, Chrome6+, Mercury, PBBs, and PBDEs. For specific testing data please contact Brady.

For more information, visit
www.bradyid.com/WEEE-RoHS

Prefix Index

AF	250-252	CPTWM	258	OG	268	PWM-LC	262	TLS2200	16
BCDAT	157, 161-162, 164, 167, 188, 190	CT	157, 175, 184	OGB	268	PWM-PK	262	TLSPC	17
BHMF	241	CV	233	OGH	268	PWS-PK	264	TMM	260
BIA	237	CV-VP	233	OLWM	250-252, 254	PWMC	263	TMXM	261
BLS	261	DAT	155-156, 158-166, 168-174, 177-179, 181-183, 185, 187-188	PAL	7	PWS	264	TWM	250-252, 254-256
BP	73	DIA	237	PAM	77	QD	238	WIL	121, 234
BPE	266	DMC	54, 61, 198	PCK	16-17, 52, 66, 74, 154	QF	265	WM	251-256, 258
BPL	266	DMIDP	54, 61	PCPS	265	QFK	265	WML	54-58
BP-THT	70-71	DMPF	198	PHCPS	265	R	16, 52, 66, 123, 153-154	WMS	55, 60
BPR	266	DSP	74	PJET	143-145, 149	RCM	156-157, 174, 183	WMT	55, 62
BPSPT	21, 36	DSTHT	81, 87, 91	PMF	241	SCK	74	WM-TM	251
BPTDS	21, 36	EIA	235-237	PMS-HG	191, 243	SCN	267	WM-VP	258
BPTL	21, 24-33, 35, 37-41, 48-49	ECL	54, 66	PPH	265	SCPS	192-194	WO	228-232
BPTLTB	21, 24-25	EL	232	PS/3PS	54, 59, 81, 111-113, 157, 195-197	SEHCPS	192-194	WOAF	228-232
BS	203	HCPS	192-194	PSBXP	54, 59	SEHSCPS	192-194	WOAF-VP	232
BT	157, 176, 184	HH	250-251, 258	PSIDP	54, 59	SER	239	WO-VP	232
CAB	259	HSA	242, 244	PSL	54, 62, 157, 167, 189	SL	235	WOS	228
CH	261	HSB	242, 244	PSPT	21, 36	SLDAT	157, 166, 180, 236	WOX	228, 230-232, 239
CL	54, 63-65	IDPAL	6	PTDS	21, 36	SLF	257	WRAP	76
CL-FILM	74	IDPRO	52, 66	PTL	21-49	SLFW	257	WRCM	55-56
CLSL	54, 65	JET	145-148	PTLCM	23, 31	SLHW	257	XTHT	84, 89-91, 93-97, 118-119
CLWO	54, 65	JET	145-148	PTLFP	23, 29, 38	SLSH	157, 172-173, 181	X	9-10, 12-13, 15
CMC	240	LAM	240	PTLFT	23, 29, 38	SLV-DAT-PRO	154	XC	9, 11-1-15
CMKC	238	LAT	127-140	PTLTB	23-25, 37	SLV-DAT-PTR	152-153	XPERT	8
CPCWM	258	LM	206	PTPSL	23, 28, 43	TB	54, 62	XPS	9, 11
CPOLWM	258	LMC	240	PTS	23, 37	TCOM	262	XSL	9-10, 13
CPS	192-193	LS2000	52	PVC	242-243	THT	81-83, 85-110, 113-114, 116		
CPT	157, 176, 186	MD	258	PWC-PK	264	THTHD	83-86, 102-106		
		MP	232, 266	PWM	263	TL	234		

WARRANTY: Our products are sold with the understanding that the buyer will test them in actual use and determine for himself their adaptability to his intended uses. Brady warrants to the buyer that its products are free from defects in material and workmanship, but limits its obligation under this warranty to replacement of the product shown to Brady's satisfaction to have been defective at the time Brady sold it. This warranty does not extend to any persons obtaining the product from the buyer. THIS WARRANTY IS IN LIEU OF ANY OTHER WARRANTY, EXPRESS OR IMPLIED, INCLUDING, BUT NOT LIMITED TO, ANY IMPLIED WARRANTY OF MERCHANTABILITY OR FITNESS FOR PARTICULAR PURPOSE, AND OF ANY OTHER OBLIGATIONS OR LIABILITY ON BRADY'S PART. UNDER NO CIRCUMSTANCES WILL BRADY BE LIABLE FOR ANY LOSS, DAMAGE, EXPENSE OR CONSEQUENTIAL DAMAGES OF ANY KIND ARISING IN CONNECTION WITH THE USE OR INABILITY TO USE, BRADY PRODUCTS.

Other products, logos and company names mentioned or illustrated herein may be trademarks of their respective owners.

1244/1344 Series Printers	73	Circular Masks	240
Arc Flash Labels	232	Clip Sleeve™ Wire Markers	267
Asset Track	215	Cloth Tags	175
Bar Code Laser (BCL)	219	Code Reader 1.0	219
BradyMarker™ XC Plus Supplies		Code Reader 2.0 (CR2)	220-221
Circuit Board & Component Labels	66	Conduit and Voltage Markers	186
Continuous Label Rolls	56	Connector Pull-Tabs	175, 186
Permashield™ Labels	62	Continuous Label Rolls	
Printer Cleaning Kit	154	BradyMarker XC Plus Printer	56
Ribbons	153	ID Pro® Plus Wire Marker Printer	56
Self-Laminating Labels	56	LS2000 Labeling System	56
Tags	62	Thermal Transfer Printable	120
BradyPack™ Wire Markers	266	TLS PC Link™ Thermal Labeling System	40, 44
Bradysleeve™ Wire Marking Sleeves		TLS2200® Thermal Labeling System	40, 44
Dot Matrix Printable	191-194	CSA Accepted Materials	280
Heat Gun	191, 243	Custom Label Quote Request Form	227
ID Pro® Plus Wire Marker Printer	60	Custom Labels	223-226
Porta-Pack® Wire Marker Books	265	Data Collection	218-221
TLS PC Link™ Thermal Labeling System	37	Data Collection Hardware	
TLS2200® Thermal Labeling System	37	See Scanners or Data Collection Terminals	
BradySoft™ Software	202-203	Data Collection Software	
Brand Protection	247	See Software	
BradyTag®		Data Communication Labels	
BradyMarker XC Plus Printable	62	Laser Printable	137-138
Dot Matrix Printable	176, 184	Fiber Optic Flag Labels	38
LS2000 Printable	62	Thermal Transfer Printable	114
TLS PC Link™ Printable	37	TLS PC Link™ Thermal Labeling System	38-40
TLS2200® Printable	37	TLS2200® Thermal Labeling System	38-40
Bulk Tubing	242	Die Cut Solutions	245-246
Brady Bar Code Printing Services	225	Dot Matrix Printers & Labels	
Cable & Harness Tags	175-176	Bradysleeve Wire Marking Sleeves	191-194
ChemLabel™ Hazardous Material Labeling Software	205	Circuit Board & Component Labels	177-180
Circuit Board & Component Labels		Connector Pull-Tabs	175, 186
BradyMarker™ XC Plus Printable	66	Durasleeve® Wire Marking	198
Dot Matrix Printable	177-180	Label Index by Part Number	155-157
ID Pro® Plus Printable	66	Label Index by Size	158-176
Ink Jet Printable	147-148	Permashield™ Labels	189
Inspection Arrows	237	Permasleeve™ Wire Marking Sleeves	195-197
Laser Printable	133-135	Printer Cleaning Kit	154
LS2000 Printable	66	Rating Plate Labels	188
Micro-Miniature Labels	224	Ribbons	153-154
Preprinted Revision Labels	239	Self-Laminating Labels	181-182, 185
Solder Masks	228	Sleeve and DATAB® Printer	152
Static Awareness Labels	235-236	SLV-DAT-PRO Printer	154
Thermal Transfer Printable	101-109	Tags	175-176, 184
TLS PC Link™ Printable	46-49	Terminal Block Marking	167-169, 186
TLS2200® Printable	46-49	Wire and Cable Marking	181-186
Water Indicating Labels	234	DSP-2 Label Dispenser	72
Circuit Board Solder Masks	238	DSP-5 Label Dispenser	72

Master Product Index

Durasleeve® Wire Marking System	
Dot Matrix Printable	198
ID Pro® Plus Printable	61
LS2000 Printable	61
TLS PC Link™ Printable	36
TLS2200® Printable	36
Equipment Labels	232
Faceplate Labels	
Laser Printable	132, 137
FacilityManager	214
FireProof™ XT	214
GlobalMark™ Industrial Label Maker	
Tapes	75
Value Plus Package	75
HandiMark™ Portable Label Maker	
Accessories	50
Ribbons	50
Tapes	51
Heat Gun	191, 243
Heat Shrink Markers	
Bradysleeve Wire Marking Sleeves	191-194
Bulk Tubing	242
Custom Printed Sleeves	243
Heat Gun	191, 243
Hot Stampers	241
Permasleeve™ Wire Marking Sleeves	57, 195-198
Hot Stamp Bulk Tubing	242
Hot Stampers Consumables	241
ID PAL™ Labeling Tool	
Accessories	6
Label Cartridges	7
ID Pro® Plus Wire Marker Supplies	
Accessories	52
BradySleeve™ Wire Marking Sleeves	60
Bradytag®	62
Circuit Board & Component Labels	66
Component and General Labels	63-64
Continuous Label Rolls	56
Durasleeve® Wire Marking	61
Label Index by Part Number	54-55
Permasield™ Labels	62
Permasleeve™ Wire Marking Sleeves	58
Pre-printed Labels	65
Printer Cleaning Kit	52
Ribbons	52
Self-Laminating Labels	56
Terminal Block Marking	62
Wire and Cable Marking	56-58
IdentiLab™ Laboratory Labeling Software	208
IDXPert™ Thermal Labeling System	
Accessories	8
Electrical I.D. Labels	10-12
Label Index by Part Number	9
MRO / Facility / Safety Labels	14-15
Voice / Data Communications I.D. Labels	13
Ink Jet Printable Labels	
Circuit Board & Component Labels	147-148
Full Sheets	149
General Identification	149
Label Index by Part Number	143
Label Index by Size	144-146
Permasield™ Labels	149
Rating Plate Labels	149
Self-Laminating Labels	146, 148
Wire and Cable Marking	148
Inspection Arrows	237
Inspection Manager FLX	214
Inventory Track	215
Label Dispensers	
DSP-2 Dispenser	72
DSP-5 Dispenser	72
Printer Applicator Machine 3000 (PAM)	77
Labeling Pens	232
Labelmark™ Software	206-207
Lanpak Labels	137
Laser Printable Labels	
110 Block Marking	138
Circuit Board & Component Labels	133-135
Data Communication - General	137-138
Faceplate	132, 137
Full Sheets	140
Label Index by Part Number	127
Label Index by Size	128-132
Lanpak	137
Patch Panel	138
Permasield™ Labels	140
Rating Plate Labels	139-140
Security Labels	135
Self-Laminating Labels	131, 136
Tamper-Resistant / Evident	139
Voice and Data Cabling	137-138
Wire and Cable Marking	136
Workstation Labels	137
Lockout PRO™ Graphical Procedure Writing Software	210-211
Lockout PRO™ Enterprise	211

LS2000 Labeling Supplies

Accessories 52
 Bradysleeve Wire Marking Sleeves 60
 Bradytag® 62
 Circuit Board & Component Labels 66
 Component and General Labels 63-64
 Continuous Label Rolls 56
 Durasleeve® Wire Marking 61
 Label Index by Part Number 54-55
 Permashield™ Labels 62
 Permasleeve™ Wire Marking Sleeves 59
 Pre-printed Labels 65
 Printer Cleaning Kit 154
 Ribbons 52
 Self-Laminating Labels 62
 Tags 62
 Terminal Block Marking 62
 Wire and Cable Marking 56-58

MarkWare™ Facility Identification Software 204

Masks - Circular 240

Masks - Solder 238

Master Materials Chart 269-276

Materials Cross Reference Chart 280-281

MEDI-MIZER™ 214

Micro-Miniature Labels 224

Motor Hook-up Diagrams 258

MVP Series Printers 71

NetDoc™ Network Documentation and Cable Management Software 216-217

Omni-Grip® Sleeve Markers 268

Overlaminates (Diecut) 240

Patch Panel Labels

Laser Printable 138
 TLS PC Link™ Thermal Labeling System 39
 TLS2200® Thermal Labeling System 39

Permashield™ Labels

BradyMarker™ XC Plus Printer 62
 Dot Matrix Printable 189
 ID Pro® Plus Wire Marker Printer 62
 Ink Jet Printable 149
 Laser Printable 140
 LS2000 Labeling System 62
 Thermal Transfer Printable 98
 TLS PC Link™ Printable 43
 TLS2200® Printable 43

Permasleeve™ Wire Marking Sleeves

Dot Matrix Printable 195-197
 Heat Gun 191
 Thermal Transfer Printable 111-113
 TLS PC Link™ Thermal Labeling System 36
 TLS2200® Thermal Labeling System 36

Porta-Pack® Wire Marker Books

Accessories 265
 Books 262-266
 Bradysleeve™ Wire Marking Sleeves 265
 Labeling Pens 266
 Refills 263
 Self-Laminating Labels 264

PowerScan™ 219

Prefix Index 284

Printer Applicator Machine 3000 (PAM) 77

Printer Cleaning Kits

BradyMarker™ XC Plus Printer 154
 Dot Matrix Printers 154
 ID Pro® Plus Wire Marker Printer 52
 LS2000 Labeling System 154
 Sleeve and DATAB® Printer 154
 Thermal Transfer Printers 74
 TLS PC Link™ Thermal Labeling System 17
 TLS2200® Thermal Labeling System 16

Quick-Dots™ Markers 238

Rating Plate Labels

Dot Matrix Printable 188
 Laser Printable 139-140
 Thermal Transfer Printable 117-119
 TLS PC Link™ Thermal Labeling System 41-42
 TLS2200® Thermal Labeling System 41-42

Revision Labels 239

Rewinder 74

Ribbons

BradyMarker™ XC Plus Printer 154
 Dot Matrix Printers 153-154
 ID Pro® Plus Wire Marker Printer 52
 LS2000 Labeling System 52
 Thermal Transfer Printers 123-124
 TLS PC Link™ Thermal Labeling System 18
 TLS2200® Thermal Labeling System 18

RoHS Data 283

Scanners

Bar Code Laser (BCL) 219
 PowerScan™ 219
 Code Reader 1.0 219
 Code Reader 2.0 (CR2) 220-221

Security Labels

Dot Matrix Printable 179
 Laser Printable 139
 Preprinted Tamper Seals 234
 Thermal Transfer Printable 121-122
 TLS PC Link™ Printable 45
 TLS2200® Printable 45
 Water Indicating Labels 121

Master Product Index

Self-Laminating Labels		Tagus Series Printers	72
BradyMarker™ XC Plus	62	Tamperséal™	234
Dot Matrix Printable	181-182, 185	Tamper-Resistant / Evident Labels	
ID Pro® Plus Wire Marker	56	Dot Matrix Printable	179
Laser Printable	131, 136	Laser Printable	139
LS2000 Labeling System	56	Preprinted Tamperséal™	234
Porta-Pack® Wire Marker Books	262-266	Tamperséal™	234
Thermal Transfer Printable	99-100	Thermal Transfer Printable	121-122
TLS PC Link™ Thermal Labeling System	35, 38	TLS PC Link™ Printable	45
TLS2200® Thermal Labeling System	35, 38	TLS2200® Printable	45
		Water Indicating Labels	121, 234
Sleeve and DATAB® Printer		Terminal Block Labels	
Printer Cleaning Kit	154	Dot Matrix Printable	167-169, 186
Ribbons	153-154	Thermal Transfer Printable	113
SLV-DAT-PTR Printer	152	TLS PC Link™ Thermal Labeling System	37
		TLS2200® Thermal Labeling System	37
Sleeves		Terminal Markers - Preprinted	251
Bradysleeve™ Wire Marking Sleeves	37, 191-194	Thermal Transfer Printers & Labels	
Bulk Tubing	242	Accessories	74
Custom Printed Sleeves	243	Circuit Board & Component Labels	101-109
Durasleeve® Wire Marker Sleeves	36	Continuous Label Rolls	120
Heat Gun	191	Data Communication - General	114
Hot Stampers Consumables	241	General Identification	117-120
Permasleeve™ Wire Marking Sleeves	36, 11-113, 195-197	Label Index by Part Number	81-84
		Label Index by Size	85-100
SLV-DAT-PRO Printer	154	Model 1244	73
		Model 1344	73
Software		Model 200MVP	71
Asset Track	215	Model 300MVP	71
BradySoft™ 8	202-203	Model 300X-Plus II Printer	70
ChemLabel™	205	Model 360X-Plus II Printer	70
FacilityManager	214	Model 600X-Plus II Printer	70
FireProof™ XT	214	Model T200 Printer	72
LabelMark™ V3	206-207	Model T300 Printer	72
IdentiLab™	208	Permashield™ Labels	98
Inspection Manager FLX	214	Printer Applicator Machine 3000 (PAM)	77
Inventory Track	215	Printer Cleaning Kit	74
Lockout PRO™	210-211	Rating Plate Labels	117-119
MarkWare™	204	Ribbons	123-124
MEDI-MIZER™	214	Security Labels	121-122
NetDoc™	216	Self-Laminating Labels	99-100
Surf on Signs™	204	Sleeves	111-113
Tool Track	215	Tags	100, 120
Solder Masks	238	Tamper-Resistant / Evident	121-122
Static Awareness Labels	235-236	Terminal Block Marking	113
Storeganizer Work Center	261	Water Indicating Labels	121
Surf On Signs™ Signs and Labels Database	209	Wire and Cable Marking	110
Tags			
BradyMarker™ XC Plus Printable	62		
Cable & Harness	175-176		
Cloth	175		
Data Communications	38		
Dot Matrix Printable	175-176, 184		
LS2000 Printable	62		
Thermal Transfer Printable	100, 120		
TLS PC Link™ Printable	37		
TLS2200® Printable	37		

TLS PC Link™ Thermal Labeling System

Accessories 17
 Bradysleeve Wire Marking Sleeves 37
 Bulk Labels 18
 Circuit Board & Component Labels 46-49
 Continuous Label Rolls 40, 44
 Data Communications 38-40
 Durasleeve® Wire Marker Sleeves 36
 Label Inex by Part Number 21-23
 Label Index by Size 24-34
 Patch Panel 39
 Permashield™ Labels 43
 Permasleeve™ Wire Marking Sleeves 36
 Preprinted Labels 43
 Printer Cleaning Kit 17
 Rating Plate Labels 41-42
 Ribbons 18
 Self-Laminating Labels 35, 38
 Tags 37
 Tamper-Resistant / Evident 45
 Terminal Block Marking 37
 Voice and Data Cabling 38-40
 Wire and Cable Marking 35-37
 Workstation Labels 39

TLS 2200® Thermal Labeling System

Accessories 16
 Bradysleeve Wire Marking Sleeves 37
 Bulk Labels 18
 Circuit Board & Component Labels 46-49
 Continuous Label Rolls 40, 44
 Data Communications 38-40
 Durasleeve® Wire Marker Sleeves 36
 Label Index by Part Number 21-23
 Label Index by Size 24-34
 Patch Panel 39
 Permashield™ Labels 43
 Permasleeve™ Wire Marking Sleeves 36
 Preprinted Labels 43
 Printer Cleaning Kit 16
 Rating Plate Labels 41-42
 Ribbons 18
 Self-Laminating Labels 35, 38
 Tags 37
 Tamper-Resistant / Evident 45
 Terminal Block Marking 37
 Voice and Data Cabling 38-40
 Wire and Cable Marking 35-37
 Workstation Labels 39

Tool Track 215

UL Recognized Materials 281

Voice and Data Cabling Labels

Laser Printable 137-138
 Thermal Transfer Printable 114
 TLS PC Link™ Thermal Labeling System 38-40
 TLS2200® Thermal Labeling System 38-40

Void Labels

Pre-Printed 234
 Thermal Transfer Printable 121-122
 TLS PC Link™ Printable 45
 TLS2200® Printable 45

Water Indicating Labels 121, 234

Wire and Cable Marking

Bradypack™ Wire Markers 266
 Bradytag® 37, 62, 184
 Card Dispenser 261
 Clip Sleeve™ Wire Markers 267
 Connector Pull-Tabs 175, 186
 Custom Printed Sleeves 243
 Dot Matrix Printable 181-186
 Heat Gun 191
 Hot Stamper Bulk Tubing 242
 Laser Printable 136
 Micro Markers 261
 Motor Hook-up Diagrams 258
 Omni-Grip® Dispenser Holder 268
 Omni-Grip® Sleeve Markers 268
 Porta-Pack® Wire Marker Books 262-266
 Storeganizer Work Center 261
 Terminal Markers - Preprinted 251
 Thermal Transfer Printable 110
 TLS PC Link™ Thermal Labeling System 35-37
 TLS2200® Thermal Labeling System 35-37
 Wire Marker Cards & Books 250-266

Wire Conductor Dimension Guide 282

Wire Marker Card Dispenser 261

Wire Marker Card Storeganizer 261

Wire Marker Cards & Books 250-266

Workstation Labels

Laser Printable 137
 TLS PC Link™ Thermal Labeling System 39
 TLS2200® Thermal Labeling System 39

Wraptor™ Wire ID Printer Applicator 76

Write-On Labels 228-232

X-Plus II Series Printers 70

Notes



LEARN MORE ABOUT OUR FULL LINE OF
SAFETY, FACILITY & EQUIPMENT IDENTIFICATION PRODUCTS

**CALL BRADY AT
 1-888-BRADYGO**



**MAKE-IT-YOURSELF
 SYSTEMS & SOFTWARE**

- Printing systems that allow you to create your own labels, signs and tags
- Portable & benchtop systems
- Software to help you create specialized signs, labels and tags



**PIPE MARKERS &
 IDENTIFICATION TAGS**

- Pipe markers meet ASME (ANSI) A13.1 Standard for I.D. identification of pipe system contents
- Over 11 different identification tag markers
- Turnkey facility assessment services available, visit www.bradyid.com/idservices for more information



**EMERGENCY
 EVACUATION PRODUCTS**

- Photoluminescent signs, tapes & labels to help you find your way out in an emergency
- BradyGlo™ Framed Exit signs are listed to UL 924 and have received the Energy Star® mark



LOCKOUT/TAGOUT

- Over 100 innovative new products
- New padlocks in Brass, Aluminum, Steel and Plastic
- Large selection of lockout kits, stations and circuit breaker lockouts



VISUAL WARNINGS

- Products that inform workers of potential hazards and risks
- Wide range of tapes, barricades, posts and more



**SAFETY SIGNS, TAGS
 & LABELS**

- A material for virtually every application
- Thousands of stock legends
- Custom sign, tag and label options



**Specify Brady...
FOR ALL YOUR IDENTIFICATION NEEDS.**



PORTABLE PRINTERS

With the addition of the IDXPERT™ Handheld Labeler, Brady offers a complete line of portable printing systems that help you get the job done fast and efficiently.

PG 3-66

SOFTWARE

Brady's selection of powerful, flexible label generation software offers a choice of features, print technologies and operating systems to meet today's growing identification needs.

PG 199-221



THERMAL TRANSFER PRINTERS

Brady desktop printers offer a full range of capabilities and options to provide high quality, cost-effective printing on a complete line of labeling materials.

PG 67-77



CONTENTS:

3-66	PORTABLE PRINTERS
67-77	THERMAL TRANSFER PRINTERS
78-124	THERMAL TRANSFER LABELS
125-140	LASER LABELS
141-149	INK JET LABELS
150-198	DOT MATRIX LABELS
199-221	SOFTWARE, SERVICES & DATA COLLECTION
222-247	CUSTOM & SPECIALTY PRODUCTS
248-268	PRE-PRINTED WIRE MARKERS
269-290	INDEX/REFERENCE

DISTRIBUTED BY:

Identification Solutions



6555 West Good Hope Road, Milwaukee, WI 53223 U.S.A.
 CUSTOMER SERVICE ▶PH:1-888-BRADYGO (1-888-272-3946) ▶FX: 1-800-292-2289
 TECHNICAL SUPPORT ▶PH:1-800-643-8766 ▶FX: 1-800-358-6767

355 Apple Creek Blvd, Markham, Ontario L3R 9X7 CANADA
 CUSTOMER SERVICE ▶PH:1-800-263-6179 ▶FX: 1-800-387-4935
 TECHNICAL SUPPORT ▶PH:1-888-262-7576



▶ www.bradyd.com ▶ www.bradycorp.com for worldwide locations

AN ISO-9001 REGISTERED FIRM ©2006 BRADY Corporation, Printed in U.S.A. All rights reserved. Specifications subject to change without notice. Reprint 7/06 MS414367