



# UFO-6W

Emergency Lighting Fluorescent Battery Pack



## INSTALLATION INSTRUCTIONS - Auto Select

# IMPORTANT SAFEGUARDS

When using electrical equipment, basic safety precautions should always be followed including the following.

## READ AND FOLLOW ALL SAFETY INSTRUCTIONS

1. To prevent high voltage from being present on red & yellow output leads prior to installation, inverter connector must be open. Do not join inverter connections until installation is complete and AC power is supplied to the emergency ballast.
2. This product is for use with 16W through 40W (2ft - 4ft) T8 and T12 single pin or bipin for one or two lamp emergency mode operation, instant start and rapid start; 40W through 215W (5ft - 8ft) T8 and T12 single pin or bipin for one lamp emergency mode operation, instant start and rapid start; and 16W through 31W U-Bend T8 bipin for one or two lamp emergency mode operation, instant start and rapid start fluorescent lamp fixtures.
3. Make sure all connections are in accordance with the National Electrical Code and any local regulations.
4. To reduce the risk of electrical shock, disconnect both normal and emergency power supplies and inverter connector of the emergency ballast before servicing.
5. This emergency ballast is for factory or field installation in either the ballast channel or on top of the fixture.
6. This product is suitable for damp locations where the ambient temperature is 0°C minimum, +50°C maximum. Product is also suitable for installation in sealed and gasketed fixtures. Product is not suitable for heated air outlets and wet or hazardous locations.
7. An unswitched AC power source is required (120 through 277 VAC, 50/60 Hz).
8. Do not install near gas or electric heater.
9. Do not attempt to service the battery. A sealed, no-maintenance battery is used that is not field replaceable. Contact the manufacturer for information on service.
10. The use of accessory equipment not recommended by the manufacturer may cause an unsafe condition.
11. Do not use this product for other than intended use.
12. Servicing should be performed by qualified service personnel.

**CAUTION:** Verify that all replacement lamp types marked on the installed luminaire are also identified as suitable for use with this inverter/charger pack.

## SAVE THESE INSTRUCTIONS

**WARNING** - This product contains chemicals known to the State of California to cause cancer, birth defects, and/or other reproductive harm. Thoroughly wash hands after installing, cleaning, or otherwise touching this product.



**CONTAINS NICKEL-CADMIUM RECHARGEABLE BATTERY. MUST BE RECYCLED OR DISPOSED OF PROPERLY.**



# INSTALLATION



**WARNING: TO PREVENT HIGH VOLTAGE FROM BEING PRESENT ON RED AND YELLOW OUTPUT LEADS PRIOR TO INSTALLATION, INVERTER CONNECTOR MUST BE OPEN. DO NOT JOIN INVERTER CONNECTOR UNTIL INSTALLATION IS COMPLETE AND AC POWER IS SUPPLIED TO THE EMERGENCY BALLAST.**

NOTE: Make sure the necessary branch circuit wiring is available. An unswitched source of power is required. The emergency ballast must be fed from the same branch circuit as the AC ballast.

1. Disconnect AC power from the fixture. Remove the ballast channel cover and install the emergency ballast either in the ballast channel (see Illustrations 1 & 2) or on top of the fixture\* (see Illustration 3).
2. Select the appropriate wiring diagram to connect the emergency ballast to the AC ballast and lamp. Make sure all connections are in accordance with the National Electrical Code and any local regulations.

**ILLUSTRATION 1**

**ILLUSTRATION 2**

**ILLUSTRATION 3**

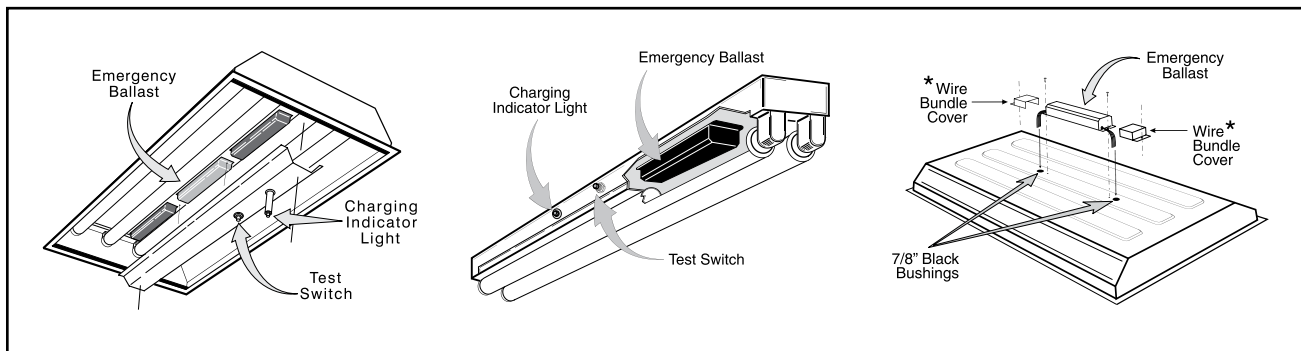

\*For installation on top of the fixture, wire bundle covers may be required by state or local codes. These covers are available from the manufacturer as an accessory kit and must be ordered separately. Call your local distributor or the factory for complete information.

3. Install the test switch through the ballast channel cover of a troffer or through the side of a strip fixture. Drill a 1/2" hole and install the switch as shown (see Illustration 1 & 2). Refer to the wiring diagrams section and wire the test switch so it removes AC power from the unswitched hot line to the emergency ballast.
4. Refer to Illustration 4 and install the charging indicator light so that it will be visible after the fixture is installed.

NOTE: After installing the charging indicator light and test switch, mark each with the appropriate label. If a detached charging indicator light is used, connect by matching wire colors and install as shown in Illustration 4.

5. In a readily visible location, attach the label "CAUTION—This Unit Has More Than One Power Connection Point. To Reduce The Risk Of Electric Shock, Disconnect Both The Branch Circuit-Breakers Or Fuses And Emergency Power Supplies Before Servicing."

## ILLUSTRATION 4

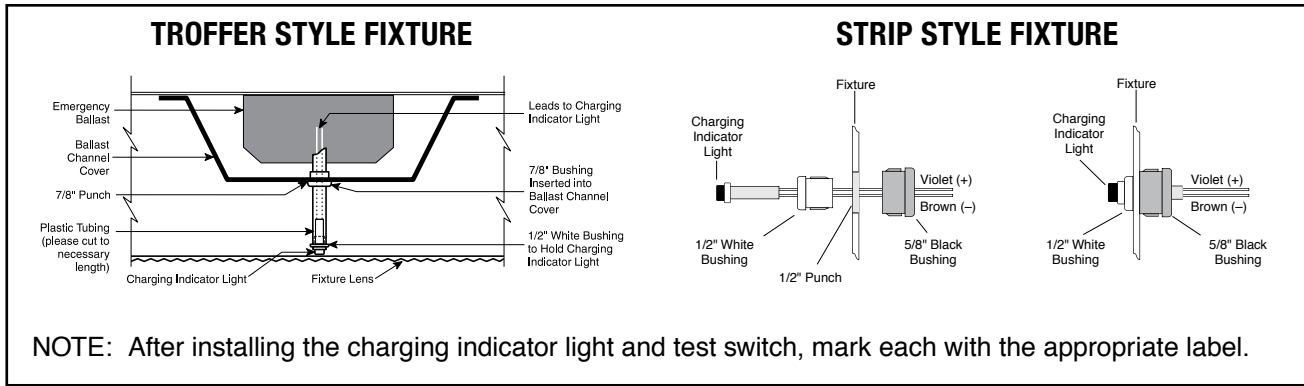

- After installation is complete, supply AC power to the emergency ballast and join the inverter connector.
- A short-term discharge test may be conducted after the emergency ballast has been charging for one hour. Charge for 24 hours before conducting a long-term discharge test. Refer to OPERATION.

## OPERATION

When AC power is applied, the charging indicator light is illuminated, indicating the battery is being charged. When power fails, the emergency ballast automatically switches to emergency power, operating one or two lamps at reduced illumination. When AC power is restored, the emergency ballast returns to the charging mode and delays AC ballast operation for approximately three seconds to prevent false-tripping of AC ballast (end-of-lamp-life) shutdown circuits. This emergency ballast will operate the rated lamp load for a minimum of 90 minutes.

## MAINTENANCE

Although no routine maintenance is required to keep the emergency ballast functional, it should be checked periodically to ensure that it is working. The following schedule is recommended:

- Visually inspect the charging indicator light monthly. It should be illuminated.
- Test the emergency operation of the fixture at 30-day intervals for a minimum of 30 seconds. Either one or two lamps should operate at reduced illumination.
- Conduct a 90-minute discharge test once a year. Either one or two lamps should operate at reduced illumination for at least 90 minutes.

**REFER ANY SERVICING INDICATED BY THESE CHECKS TO QUALIFIED PERSONNEL**

## WIRING DIAGRAMS

The following diagrams are typical schematics only. May be used with other ballasts. Consult the factory for other wiring diagrams. Emergency Ballast and AC Ballast must be fed from the SAME BRANCH CIRCUIT.

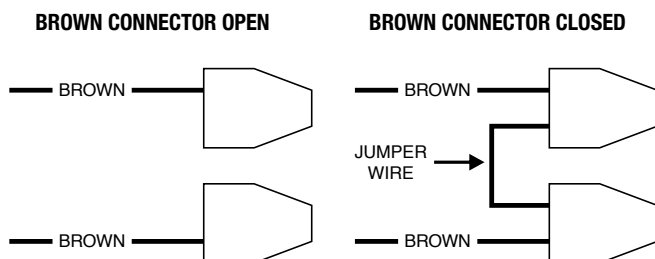

**IMPORTANT TEXT: REFER TO TABLE 1 REGARDING BROWN CONNECTOR**

**Table 1**

LAMP (DIAMETER)	BASE TYPE	WATTAGE (Length)	NO. of LAMPS (EMERGENCY-MODE)	BROWN CONNECTOR
T8,T12 (1", 1½")	Single or Bipin	16 - 40 W (2'-4')	1	CLOSED
			2	OPEN
		40 - 215 W (5' -8')	1	OPEN

**EMERGENCY BALLAST AND AC BALLAST MUST BE FED FROM THE SAME BRANCH CIRCUIT**  
 TYPICAL SCHEMATICS ONLY. MAY BE USED WITH OTHER BALLASTS. CONSULT THE FACTORY FOR OTHER WIRING DIAGRAMS.

**WIRING DIAGRAM for 1-LAMP emergency operation**

FIG A ONE (1) LAMP RAPID START BALLAST

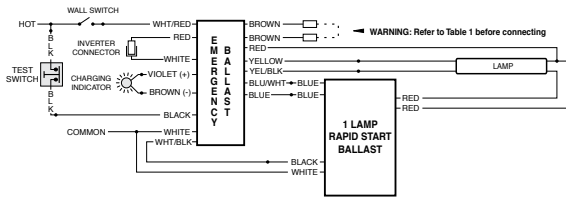

FIG B ONE (1) LAMP INSTANT START BALLAST

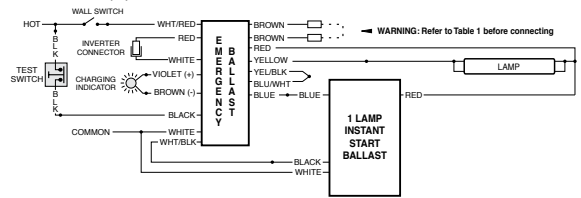

FIG C TWO (2) LAMP RAPID START BALLAST

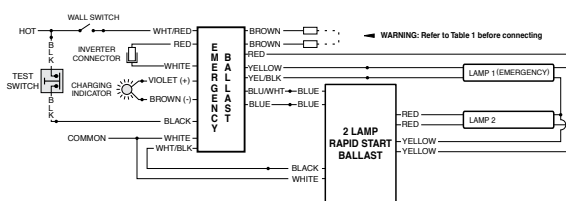

FIG D TWO (2) LAMP INSTANT START BALLAST

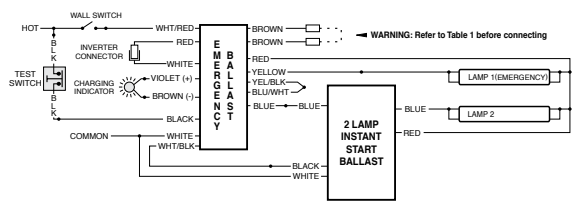

FIG E THREE (3) LAMP RAPID START BALLAST

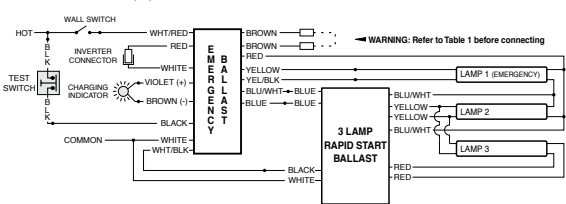

FIG F THREE (3) LAMP INSTANT START BALLAST

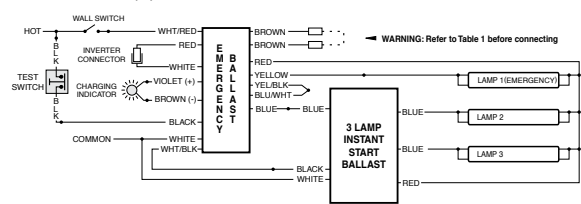

FIG G FOUR (4) LAMP RAPID START BALLAST

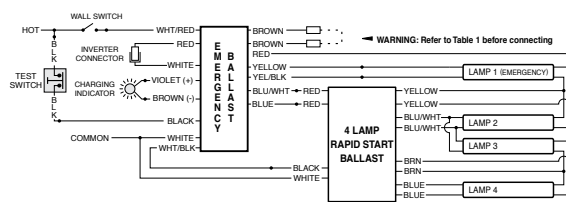

FIG H FOUR (4) LAMP INSTANT START BALLAST

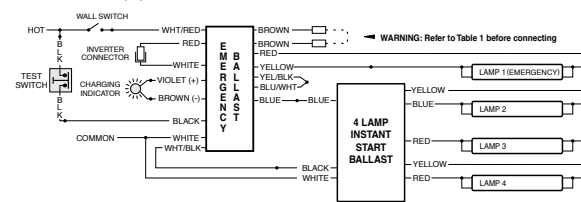
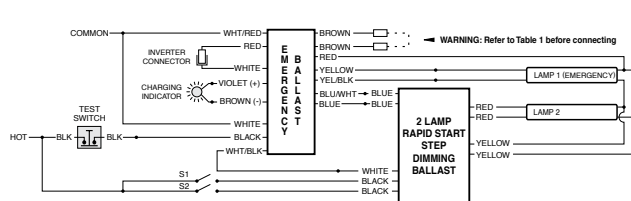

FIG I TWO (2) LAMP RAPID START STEP DIMMING BALLAST



THE WHITE/BLACK LEAD MUST CONNECT TO THE WHITE LEAD OF THE STEP-DIMMING BALLAST ASSOCIATED WITH THE EMERGENCY BALLAST ONLY. CONNECTIONS TO OTHER BALLASTS OR FIXTURES COULD RESULT IN ABNORMAL OPERATION AND CAUSE PRODUCT DAMAGE.

# WIRING DIAGRAMS FOR 2-LAMP EMERGENCY OPERATION (2'- 4', 16- 40 W LAMPS ONLY)

Two-lamp emergency operation is not possible with all ballasts.  
Consult the factory for any ballast other than those shown.

FIG J TWO (2) LAMP RAPID START BALLAST

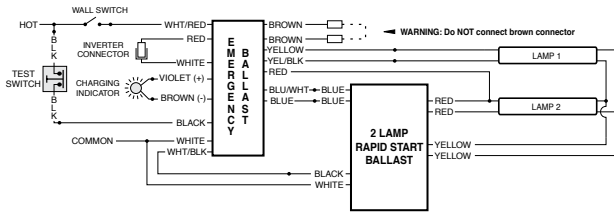

FIG K TWO (2) LAMP INSTANT START BALLAST

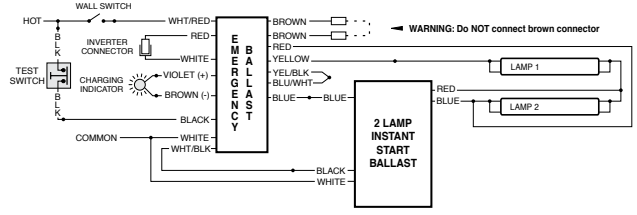

FIG L THREE (3) LAMP RAPID START BALLAST

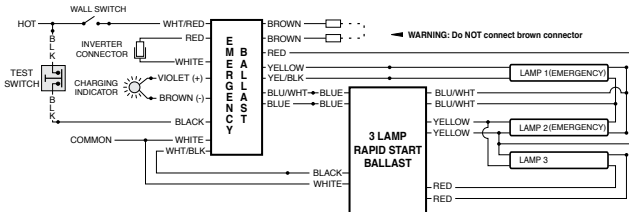

FIG M THREE (3) LAMP INSTANT START BALLAST

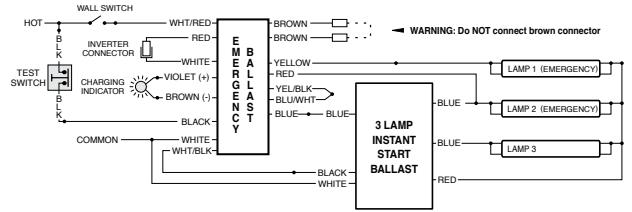

FIG N FOUR (4) LAMP RAPID START BALLAST

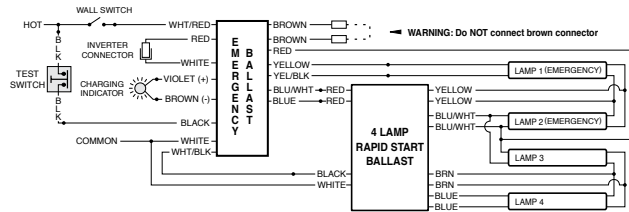
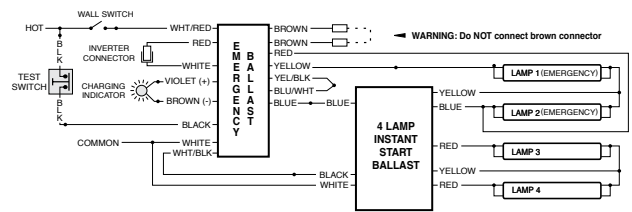

FIG O FOUR (4) LAMP INSTANT START BALLAST



## WIRING DIAGRAMS for EMERGENCY ONLY Fixtures

FIG P ONE (1) LAMP WITHOUT AC BALLAST (16W-215W)

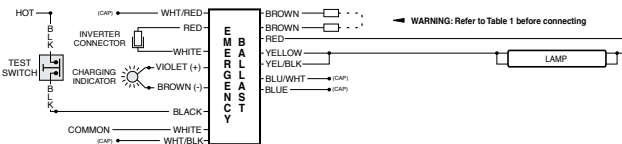
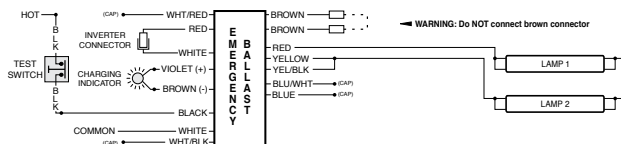

FIG Q TWO (2) LAMPS WITHOUT AC BALLAST (16W-40W)



09/16

©

Copyright Hubbell Lighting, Inc. • 701 Millennium Blvd • Greenville, SC 29607 • (864) 678-1000 • FAX(864) 678-1415 • www.dual-lite.com

93063952

