



Assembly & Installation Instructions

CAUTION: Read instructions carefully and turn electricity off at main circuit breaker panel before beginning installation.

3052, 3053, 3054, 3055, 3056

WARNING - If any Special Control Devices are used with this Fixture, Follow the Instructions Carefully to assure full compliance with N.E.C. requirements. If there are any questions, contact a Qualified Electrical Contractor.

CAUTION - All glass is fragile, use care when handling Glass component(s) and or Lamp(s).

WARNING - This product contains chemicals known to the State of California to cause cancer, birth defects and /or other reproductive harm. Thoroughly wash hands after installing, handling, cleaning, or otherwise touching this product.

ASSEMBLY STEPS:

PASOS PARA ENSAMBLAR:

MODE D'ASSEMBLAGE:

1. E,H → A
2. D → H
3. B,A → C
4. P → Q
5. F → G
6. I,K → H
7. M,N → L
8. O → L

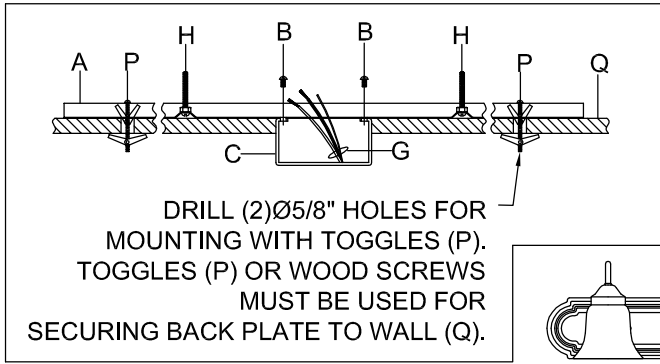

B, C, G & O
(NOT FURNISHED)
(NO INCLUIDA)
(NON FOURNIE)

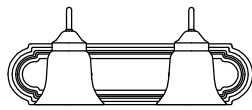

P3052

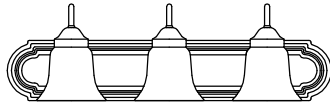

P3053

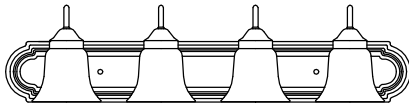

P3054

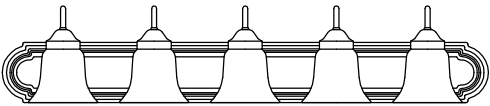

P3055

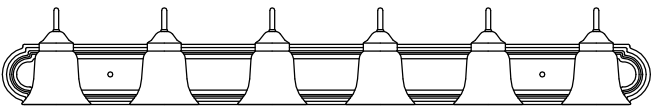

P3056

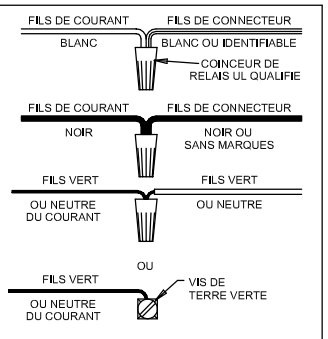
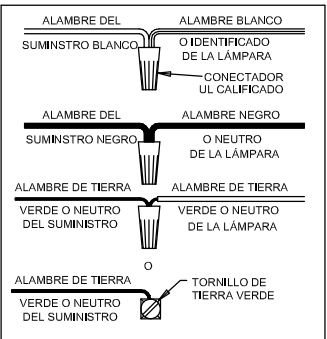
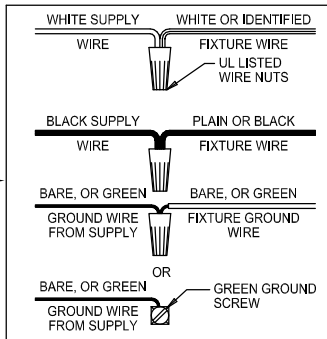
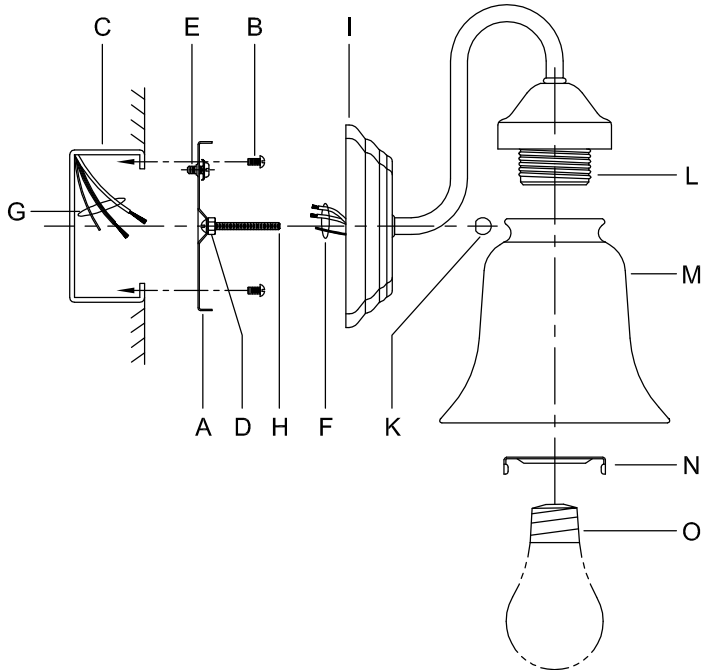

Instrucciones de ensamblaje e instalación

Precaución: Lea cuidadosamente las instrucciones y desconecte la electricidad del cortacircuitos principal antes de iniciar la instalación.

ADVERTENCIA - Si usa algún dispositivo especial de control con este aparato de luz, siga las instrucciones cuidadosamente para asegurar la completa conformidad con los requisitos N.E.C. Si existe alguna duda, contacte un electricista calificado.

PRECAUCION - El vidrio es frágil; tenga cuidado al manipular el (los) elemento(s) de vidrio y/o la(s) bombilla(s).

ADVERTENCIA - Este producto contiene sustancias químicas que según el Estado de California causa cáncer, defectos de nacimiento y (o) daño al sistema reproductor. Lavarse bien las manos después de instalar, manipular, limpiar o tocar de manera alguna este producto.

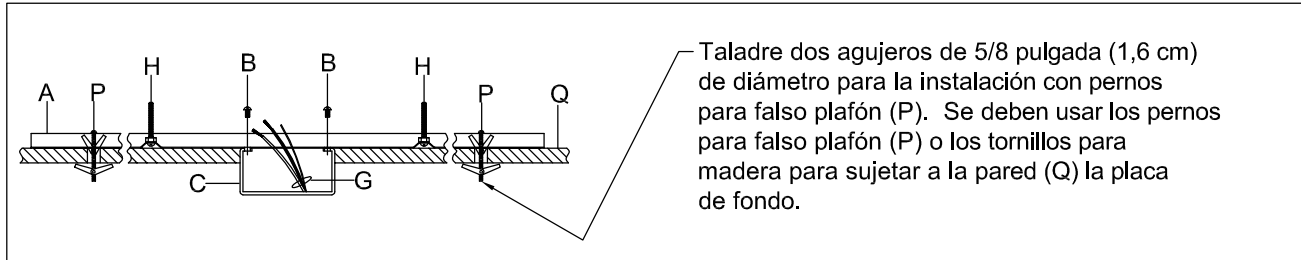

Instructions d'Assemblage et Installation

Mise en garde: Lire les instructions avec soin et couper le courant au disjoncteur central avant de commencer l'installation.

AVERTISSEMENT - S'il y a d'autres mécanismes régulateurs qui s'emploient avec ce dispositif, suivre soigneusement les instructions pour satisfaire aux exigences NEC. Si vous avez des questions, consulter un électricien qualifié.

MISE EN GARDE - Le verre est toujours fragile; maniez le(s) composant(s) et/ou l' (les) ampoule(s) avec prudence.

AVERTISSEMENT - Ce produit contient des composants chimiques qui selon L'état de Californie provoquent un cancer, des infirmités de naissance et (ou) du mal au système reproductif. Il faut laver les mains soigneusement après avoir installé, manipulé, nettoyé, ou autrement touché ce produit.

