

## Catalog Numbers • Les Numéros de Catalogue • Los Números de Catálogo: DSW-100 v3/DSW-200 v3

Country of Origin: Made in China • Pays d'origine: Fabriqué en Chine • País de origen: Hecho en China

### SPECIFICATIONS

Specifications

Voltages:

DSW-100 & DSW-200 ..... 120/277VAC, 50/60Hz

Load Limits for each relay:

@120VAC ..... 0-800W tungsten or ballast, 1/6 HP

@277VAC ..... 0-1200W ballast

Load Type Compatibility:

Incandescent, fluorescent, magnetic or electronic ballast

Horsepower Rating (each relay) ..... 1/6 HP @120VAC

Time Delay Adjustment ..... 5 to 30 minutes

Walk-Through Mode ..... 3 minutes if no activity after 30 sec.

Test Mode ..... 5 sec. for 10 min. with DIP switch setting

PIR Adjustment ..... High or Low (DIP switch)

Ultrasonic Adjustment ..... Minimum to Maximum (trimpot), Off

Frequency ..... 40kHz

Light Level Adjustment ..... 8fc to 180+fc

Alerts ..... Selectable Audible

US Patents: 5640113, 6617560

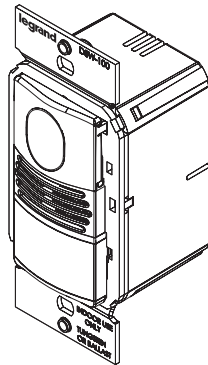

DSW-100

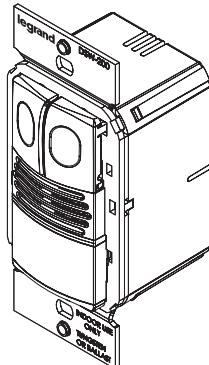

DSW-200

### DESCRIPTION AND OPERATION

The DSW Dual Technology Wall Switch sensors combine advanced passive infrared (PIR) and ultrasonic technologies into one unit. The combined technologies help to eliminate false triggering even in difficult applications.

Selectable operating modes allow the sensor to turn a load **ON** when PIR motion is detected and held **ON** using either or both technologies. After no movement is detected for the selected time delay, the lights switch **OFF**. A “walk-through” mode can turn lights off after only 3 minutes, if no activity is detected after 30 seconds following an occupancy detection.

The DSW-100 has one relay and one ON/OFF button. The DSW-200 contains two relays and two **ON/OFF** buttons to allow control of one or two loads independently. Pressing a button toggles the state of the corresponding relay.

DSW sensors contain a light level sensor. If adequate daylight is present, the sensor holds the load **OFF** until light levels drop, even if the area is occupied. In the DSW-200, light level only affects the load on Relay 2. Users can overrule this function by pressing the **ON/OFF** button. See Light Level Adjustment.

#### Turning ON the Load (ON Mode)

The relays are programmed independently for either **Auto ON** or **Manual ON**. In either mode, the load can be turned **ON** or **OFF** using the **ON/OFF** button.

<b>Auto ON</b> DIP 8 <b>OFF</b> for Relay 1 DIP 9 <b>OFF</b> for Relay 2	With an <b>ON Mode</b> DIP Switch in the <b>OFF</b> position, the load turns <b>ON</b> and <b>OFF</b> automatically based on occupancy. If the load is turned <b>OFF</b> manually, <b>Presentation Mode</b> operation applies. This prevents the load from turning <b>ON</b> automatically after it was deliberately turned <b>OFF</b> . Pressing the button to turn lights <b>ON</b> returns the sensor to <b>Auto ON</b> mode.
<b>Manual ON</b> DIP 8 <b>ON</b> for Relay 1 DIP 9 <b>ON</b> for Relay 2	With an ON Mode DIP Switch in the <b>ON</b> position, the occupant must press the <b>ON/OFF</b> button to turn <b>ON</b> the load. The sensor keeps the load <b>ON</b> until no motion is detected for the selected time delay. There is a 30 second re-trigger delay. If occupancy re-triggers during the delay (see <b>Trigger Mode</b> ), the sensor turns the load back <b>ON</b> . After the re-trigger delay elapses the <b>ON/OFF</b> button must be pressed to turn <b>ON</b> the load.

Model #	Relay	Default ON Mode	DIP Switch #	Setting
DSW-100	1	Manual ON	8	ON
DSW-200	1	Auto ON	8	OFF
	2	Manual ON	9	ON

## Presentation Mode

This is a feature of the **Auto ON** mode. When both relays are manually turned **OFF** the DSW holds the lights **OFF** until no motion has been detected for the duration of the Time Delay. With subsequent occupancy, the DSW turns the load **ON**. If both relays are **ON** and one relay is manually turned **OFF** this relay remains **OFF** until both the Time Delay and retrigger delay expires for the relay that is **ON**, after that time the **ON** Mode control settings again apply.

**NOTE:** Shaded cells in the tables below indicate the default operation.

## Time Delays

The DSW sensor holds the load **ON** until no motion is detected for the selected time delay. Select the time delay using DIP switch settings. In the DSW-200, both relays use the same delay.

<b>Test/20 min</b> (DIP 1 & 2 <b>OFF</b> )	A Test Mode with a short time delay of five seconds is set when DIP Switches 1 & 2 are <b>OFF</b> . It cancels automatically after ten minutes, or when you set a fixed time delay. When the Test Mode times out, the sensor will assume a 20 minute time delay. To restart Test Mode, change the time delay setting to any fixed amount and then return it to the Test setting.
<b>Time Delay</b> (15 min. DIP 1 <b>ON</b> & 2 <b>OFF</b> )	Time delays of 5, <b>15</b> (default), or 30 minutes are available. See DIP SWITCH SETTINGS for information.

## Walk-Through

The Walk-Through mode shortens the time delay to reduce the amount of time the load is **ON** after a brief moment of occupancy, such as returning to an office to pick up a forgotten item then immediately exiting.

<b>Walk-Through Mode</b> (DIP #3 <b>ON</b> )	The DSW sensor turns the load <b>OFF</b> 3 minutes after the area is initially occupied, if no motion is detected after the first 30 seconds. If motion continues beyond the first 30 seconds, the set time delay applies.
<b>No Walk-Through</b>	Walk-Through mode disabled.

## PIR Sensitivity Adjustment

The DSW sensor constantly monitors the controlled environment and automatically adjusts the PIR to avoid common ambient conditions that can cause false detections, while providing maximum coverage.

<b>High</b> (DIP #4 <b>OFF</b> )	Default setting. Suitable for most applications.
<b>Low, 50%</b> (DIP #4 <b>ON</b> )	Reduces sensitivity by approximately 50%. Useful in cases where the PIR is detecting movement outside of the desired area (also consider masking the lens) and where heat sources cause unnecessary activation.

## Alerts

The DSW can provide audible alerts as a warning before the load turns **OFF**.

<b>Audible Alerts</b> (DIP #7 <b>ON</b> )	Unit will beep at one minute, at 30 seconds and at 10 seconds before turning <b>OFF</b> load. When Walk-Through is active, the unit beeps three times at 10 seconds before the load goes <b>OFF</b> .
<b>No Alerts</b>	No warnings provided.

## Trigger Mode

The DSW sensor has four occupancy trigger options, set with DIP switches 5 and 6. Determine the appropriate option using the Trigger matrix.

In the Trigger Mode DIP switch setting table, in order to deem the area occupied:

- Both requires motion detection by the PIR and the Ultrasonic.
- Either requires motion detection by only one technology.
- PIR requires motion detection by the PIR.

**Initial Occupancy:** The method that activates a change from “Standby” (area unoccupied and load off) to “Occupied” (area occupied and load may turn **ON**).

**Maintain Occupancy:** The method indicating that the area is still occupied and the lights should remain **ON**.

**Re-trigger:** In **Auto On Mode**, after the load turns off, detection by the selected technology within 5 seconds turns the lights back **ON**. If the load was configured as **Manual ON**, the re-trigger time is 30 seconds.

Trigger Mode	Initial Occupancy	Maintain Occupancy	Re-trigger	5	6
Standard	PIR	Either	Either	↓	↓
Option A	PIR	PIR	PIR	↓	↑
Option B	PIR	Both	Both	↑	↓
Option C	PIR	Both	Both	↑	↑

## COVER PLATES

Wattstopper DSW series wall switches fit behind industry standard decorator-style switch cover plates. Cover plates are not included.

Units come in the following colors, which are indicated by the final suffix of the catalog number (shown here in parentheses):

White (-W), Light Almond (-LA), Ivory (-I), Grey (-G), Black (-B).

## COVERAGE PATTERNS

Coverage testing has been performed according to the NEMA WD 7 guideline. For best performance, use in spaces not larger than 18' x 15'.

### PIR Sensor

The sensor has a two-tiered, multi-cell viewing Fresnel lens with 180 degree field of view. The red LED on the sensor flashes when the PIR detects motion.

### Masking the lens

Opaque adhesive tape is supplied so that sections of the PIR sensor's view can be masked. You can eliminate coverage in unwanted areas. Since masking removes bands of coverage, take this into account when troubleshooting coverage problems.

### Ultrasonic Sensor

The sensor has two ultrasonic transceivers operating at 40kHz. Detection sensitivity can be adjusted using the trimpot under the **ON/OFF** buttons.

**Top View**

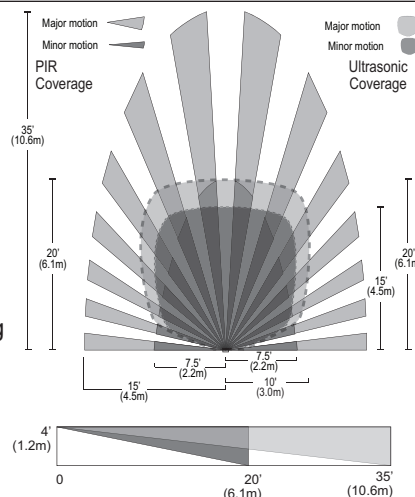

**Side View**

## INSTALLATION

1. Make sure that the power has been turned **OFF** at the circuit breaker.
2. Connect wires to the DSW flying leads as shown in the wiring diagram below that is appropriate to the DSW model and electrical supply.
3. Attach the DSW to the wall box by inserting screws into the two wide holes on the top and bottom of the attached metal bracket. Match them up with the holes in the wall box and tighten.
4. Turn the circuit breaker **ON**. Wait one minute, then push the **ON/OFF** button for each load and the lights will turn **ON**.
5. Test and adjust the sensor if necessary.
6. Attach the cover plate.



**#12 — #14 AWG**

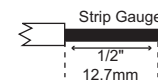

**Cu Wire Only**

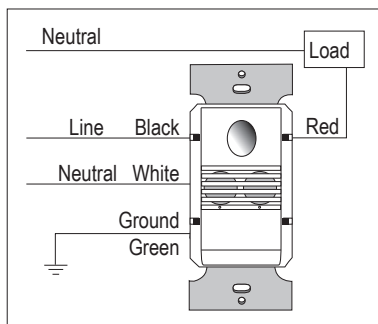

**DSW-100 and DW-100-347 Wiring**

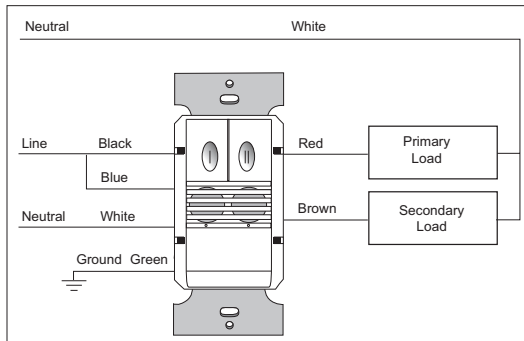

**DSW-200 Bi-Level Wiring**

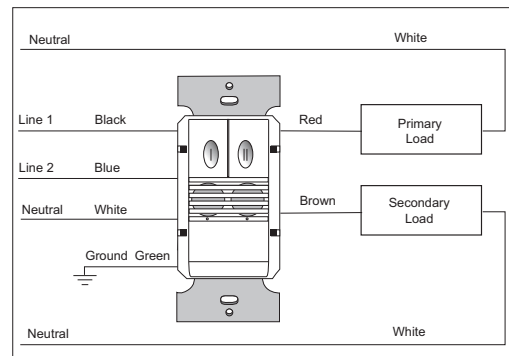

**DSW-200 Dual Circuit Wiring**

## ADJUSTMENTS

### Sensor Adjustment

Remove the wall plate. Remove the button cap by firmly squeezing together the top sides of the button assembly. Gently pull it away from the unit. When the adjustments are completed, replace the button cap by inserting its hinges into the tabs on the main unit and then squeeze the top of the button while pressing it into the unit. Reinstall the cover plate.

### Light Level Adjustment

The light level can be set with loads **ON** or **OFF**. To enable light level control and set the threshold: 1) Make sure the room is lit appropriately. 2) Put the sensor into TEST mode. You have 5 minutes to complete the procedure. 3) Press and hold the **ON/OFF** button (Relay 1 button on the DSW-200) for 3 seconds, until you hear a beep. 4) Step away from the sensor. After 25 seconds a beep sounds, indicating that the threshold level is set. This threshold is retained, even if power is lost, until it is re-set or disabled. In the DSW-200, light level control only affects Relay 2. To disable light level control, press and hold the Relay 1 button for 7 seconds, until a double beep tone sounds.

### Reset to Default

Use the DIP Switch Settings tables on the previous page to return features to factory settings. To reset the DSW press and hold the **ON/OFF** button for 10 seconds, until a triple beep sounds. This resets the sensor and disables light level control (the brightest ambient light will not hold the light **OFF**).

## DIP SWITCH SETTINGS

Time Delay	1	2
Test/20 min	↓	↓
5 minutes	↓	↑
15 minutes	↑	↓
30 minutes	↑	↑

Walk-Through	3
Enabled	↑
Disabled	↓

PIR Sensitivity	4
Low, 50%	↑
High	↓

Initial Occupancy	Maintain Occupancy	Re-trigger (seconds duration)	5	6
Standard	PIR	Either	Either	↓
Option A	PIR	PIR	PIR	↓
Option B	PIR	Both	Both	↑
Option C	PIR	Both	Both	↑

Audible Alert	7
Enabled	↑
Disabled	↓

Relay 1 On Mode	8
Manual On	↑
Auto On	↓

DSW-200 only:	Relay 2 On Mode	9
	Manual On	↑
	Auto On	↓

Factory Settings:  
 ◀ All models  
 ▲ DSW-100 series  
 ▲ DSW-200 series

↑ = ON    ↓ = OFF

**ON/OFF Buttons**  
Relay 1  
Relay 2

**Ultrasonic Sensitivity Adjustment Trimpot**

**DIP Switches**

**Ultrasonic Cones**

**Detection LEDs**  
Red = PIR  
Green = Ultrasonic

**PIR Lens**

**Button Hinges**

**Tabs**

**DSW-200 shown. DSW-100 has a single button and the Ultrasonic sensitivity adjustment trimpot is in a slightly different position.**

## TROUBLESHOOTING

### Lights do not turn ON with motion (LED does flash)

1. Press and release each button to make sure that the correct lights come **ON** for each relay. If the lights do **NOT** turn **ON**, check wire connections, especially the Load connection. If the lights turn **ON**, verify that the correct **On Mode** is selected in DIP Switches 8 and 9.
2. Check to see if light level control is enabled: cover the sensor lens with your hand. If the lights come **ON**, adjust the light level setting.
3. If lights still do not turn **ON**, call 800.879.8585 for technical support.

### Lights do not turn ON with motion (LED does not flash)

1. Press and release each button. Make sure that the correct lights come **ON** for each relay. If the lights turn **ON**, set PIR and Ultrasonic Sensitivity to High.
2. Check the wire connections, in particular, the Neutral and Line connections. Verify that connections are tightly secured.
3. If lights still do not turn **ON**, call 800.879.8585 for technical support.

### Lights do not turn OFF

1. There can be up to a 30 minute time delay after the last motion is detected. To verify proper operation, set DIP switch 1 to **ON**, then reset switches 1 and 2 to **OFF** to start Test Mode. Move out of view of the sensor. The lights should turn **OFF** in approximately 5 seconds.
2. Verify that the sensor is mounted at least six feet (2 meters) away from any heating/ventilating/air conditioning device that may cause false detection. Verify that there is no significant heat source (such as a high wattage light bulb) mounted near the sensor.
3. Verify that the trimpot is not pointing at "Service" (red LED **ON**). If so, rotate the trimpot to its middle setting (pointing up). The Service setting allows users to operate the sensor as a service switch in the unlikely event of a failure.
4. If the lights still do not turn **OFF**, call 800.879.8585 for technical support.

### Sensing motion outside desired areas

1. Select PIR Sensitivity — Low (DIP Switch 4 = **ON**) if necessary.
2. Mask the PIR sensor's lens to eliminate unwanted coverage area.
3. Adjust the Ultrasonic Sensitivity. Rotate trimpot counterclockwise to reduce sensitivity.

### Red LED is lit all the time and the sensor features don't work.

1. Check the Ultrasonic trimpot. If it is set at fully clockwise (MIN) the unit is in Service Mode. Set the trimpot to a mid-range position.
2. If re-setting the trimpot does not clear the LED, call technical support.

### WARRANTY INFORMATION

Wattstopper warrants its products to be free of defects in materials and workmanship for a period of five (5) years. There are no obligations or liabilities on the part of Wattstopper for consequential damages arising out of, or in connection with, the use or performance of this product or other indirect damages with respect to loss of property, revenue or profit, or cost of removal, installation or reinstallation.

### INFORMATIONS RELATIVES À LA GARANTIE

Wattstopper garantit que ses produits sont exempts de défauts de matériaux et de fabrication pour une période de cinq (5) ans. Wattstopper ne peut être tenu responsable de tout dommage consécutif causé par ou lié à l'utilisation ou à la performance de ce produit ou tout autre dommage indirect lié à la perte de propriété, de revenus, ou de profits, ou aux coûts d'enlèvement, d'installation ou de réinstallation.

### INFORMACIÓN DE LA GARANTÍA

Wattstopper garantiza que sus productos están libres de defectos en materiales y mano de obra por un período de cinco (5) años. No existen obligaciones ni responsabilidades por parte de Wattstopper por daños consecuentes que se deriven o estén relacionados con el uso o el rendimiento de este producto u otros daños indirectos con respecto a la pérdida de propiedad, renta o ganancias, o al costo de extracción, instalación o reinstalación.