

ALADDIN®

ALL300RM/ALL300RM-CM

INSTALLATION INSTRUCTIONS

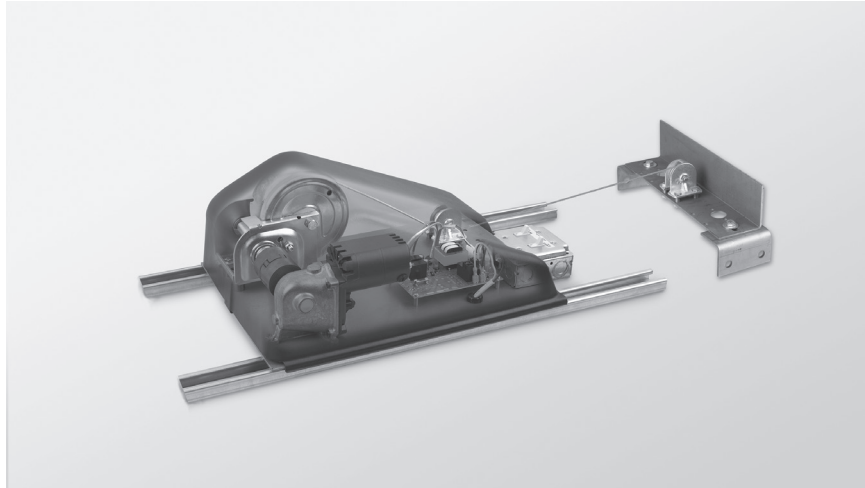

Aladdin® Light Lift, Inc.
61 Shields Road
Huntsville, AL 35811

(256) 429-9700
(877) 287-4601
www.aladdinlightlift.com

Patent #5105349

WARNING: Disconnect power source before servicing to avoid electrical shock

CAUTION: To Reduce the Risk of Electric Shock or Injury, Use Indoors Only.

Light and motor circuits are rated at AC 110V

Pour usage seulement dans un endroit

Avec acces au dessus du plafonds

Model Number: ALL300RM (300lb. rated working load, 1/8" steel galvanized lay cable,
1.5amp, 50/60Hz)
_____ MC Cable (if checked)

Light lift is equipped with a 65' cable unless checked below:

_____ 90'
_____ 120'

Light lift is equipped with a 1,650 watt (15 amps)
lighting capacity unless checked below:

_____ 2200 watts (20 amps)



Manufacture Date





© 2017 All Rights Reserved

Electric Hoist
91F5

Read the following guidelines prior to installing the ALL300RM:

- I. The ALL300RM must be installed by a licensed, bonded, and insured electrician.
- II. The ALL300RM must be installed in an accessible location.
- III. For installation clarification, click the Youtube links or scan the QR codes located throughout the Installation Instructions.
- IV. Thoroughly read, understand, and follow each step and safety warning in the ALL300RM installation instructions and orange safety precautions supplement.
- V. Motor pulley, directional pulley(s), and chandelier pulley must be installed on the same plane. Do not install the ALL300RM with lateral cable direction changes.
- VI. During installation of the ALL300RM, take one step at a time and check off each step upon completion.
- VII. Call Aladdin Light Lift (877) 287-4601 if assistance is needed for installation and/or operation of the ALL300RM. Refer to the Keyswitch Controller Guide or SmartLift Controller Guide for operation instructions.
- VIII. Ignoring any safety warnings and/or symbols not only voids the warranty, but may cause death, personal injury, and/or property damage.
- IX. Give all Aladdin paperwork to property owner and/or anyone that will be using the ALL300RM.

ALL300RM Parts Bag List

	A. 5/16" x 2" Lag Bolts	(QTY 4)
	B. 5/16" x 1 1/4" Fender Washers	(QTY 4)
	C. Thread Lock	(QTY 1)
	D. 3/32" Allen Wrench	(QTY 1)
	E. 1/4 IPS x 3/8 IPS Fixture Coupler	(QTY 1)

ALL300 RM Hardware Box List



5/16" USS Flat Washers

(QTY 4)



3/8" Nylon Lock Nuts

(QTY 2)



3/8" x 1 1/4" Hex Tap Bolts

(QTY 2)



7/16" x 4" Hex Tap Bolt

(QTY 4)



3/8" USS Flat Washers

(QTY 8)



7/16" Nylon Lock Nuts

(QTY 4)



Side Brackets for Chandelier Pulley Bracket

(QTY 2)

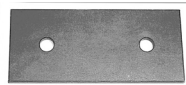

Flat Brackets

(QTY 2)
per directional pulley (optional)



7/16" x 3 1/4" Hex Head

(QTY 2)
per directional pulley (optional)



3/8" USS Flat Washers

(QTY 4)
per directional pulley (optional)



7/16" Nylon Lock Nuts

(QTY 2)
per directional pulley (optional)

STEP 1

Determine mounting location of ALL300RM motor assembly. The ALL300RM may be mounted on an angle, vertically, horizontally or upside down, if secured properly. See [Diagram A](#).

! Never install the ALL300RM where the ceiling height and total cable run through the pulleys exceeds five feet less than the exact length of winch cable. For example, if the ALL300RM is equipped with a 65ft. cable do not install the ALL300RM with a ceiling height and total cable run that is greater than 60ft. This could cause the cable to become reverse wrapped on the winch. An ALL300RM installed with a reverse wrapped cable could cause the chandelier to fall, which could cause death, personal injury, and/or property damage. Winch cable length can be found on the ALL300RM product sticker, shipping box, and the front page of these installation instructions.

[Diagram A](#)

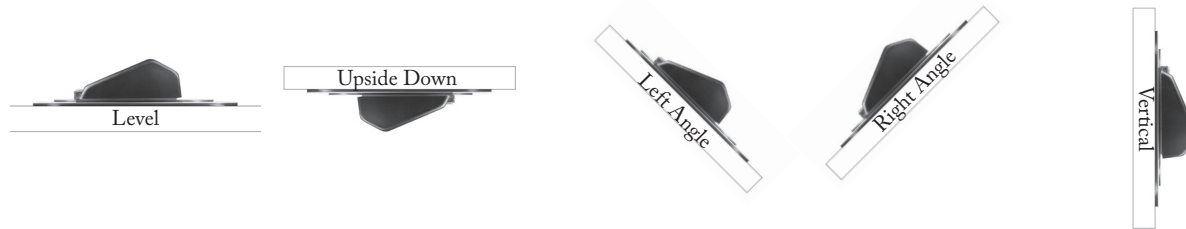

STEP 2

Determine mounting location of chandelier pulley assembly. Chandelier pulley assembly must be mounted directly above where chandelier will hang. See [Diagram B](#).

! Never mount the chandelier pulley assembly off plane or unlevel in a remote installation. This could cause the chandelier to fall, which could cause death, personal injury, and/or property damage. The winch cable must hang plumb through the center of the top contact plate on the ceiling box.

[Diagram B](#)

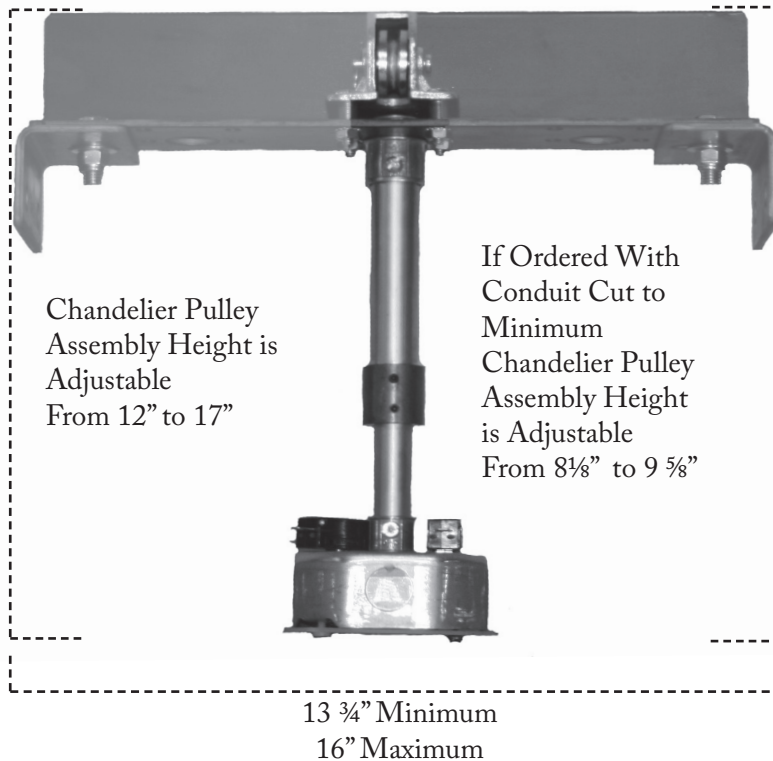

STEP 3

Determine mounting location of directional pulleys if they are to be installed with ALL300RM. Directional pulleys can be used to change winch cable direction, up or down, between motor pulley and chandelier pulley. See [Diagram C](#).

! Never mount directional pulleys off plane in a remote installation. This could cause the chandelier to fall, which could cause death, personal injury, and/or property damage.

[Diagram C](#)

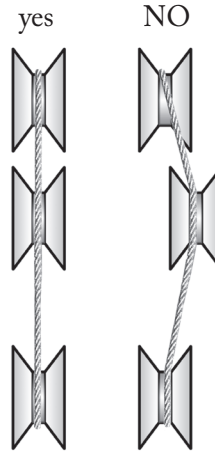
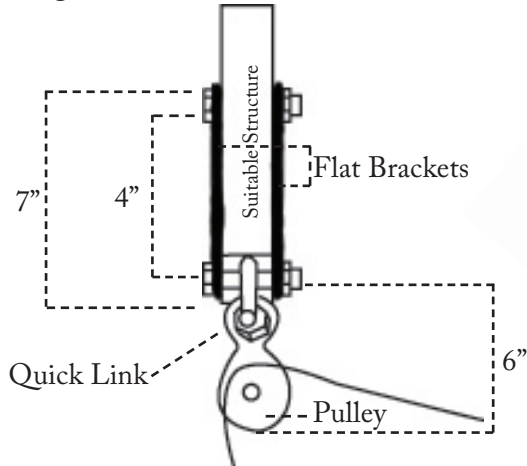

STEP 4

Determine that cable position on motor pulley is correct for installation. ALL300RM is equipped with cable running under motor pulley. See [Diagram D](#).

! Never position cable on motor pulley improperly. This could damage the cable which could cause the chandelier to fall, which could cause death, personal injury, and/or property damage.

[Diagram D](#)

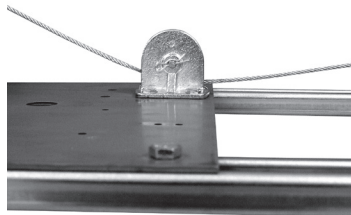

Under

STEP 5

If cable rubs on motor pulley housing or motor assembly plate, change cable configuration so that cable runs over motor pulley. See [Diagram E](#).

! Never position cable on motor pulley improperly. This could damage the cable which could cause the chandelier to fall, which could cause death, personal injury, and/or property damage.

[Diagram E](#)

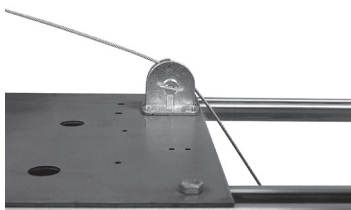

Over

STEP 6

Position ALL300RM motor assembly where it will be mounted. Adjustments can be made loosening 3/8" channel strut bolts that hold ALL300RM motor assembly to channel struts. Retighten channel strut bolts after adjustments are made. Confirm strut nuts are seated properly. See [Diagram F](#).

! Never adjust the channel struts improperly. This could cause the chandelier to fall, which could cause death, personal injury, and/or property damage.

STEP 7

Securely fasten ALL300RM motor assembly to a suitable structure using 5/16" lag bolts and 5/16" fender washers included in parts bag. See [Diagram F](#).

! Never install the ALL300RM without properly fastening it to a suitable structure. This could interfere with the safety and operation of the ALL300RM and could cause the chandelier to fall, which could cause death, personal injury, and/or property damage.

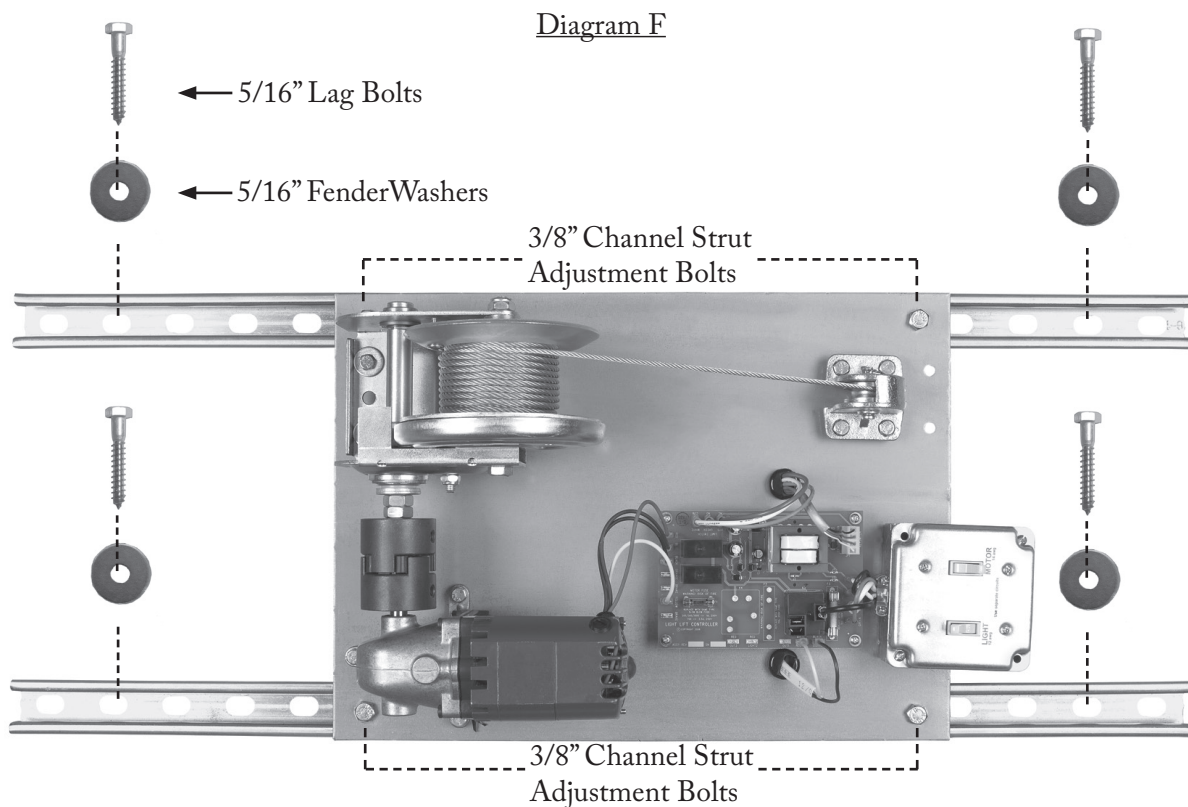

STEP 8



Turn off supply power before wiring ALL300RM motor switch. Turn off motor switch in square box. Wire motor switch with 110V wiring (cannot wire to an arc fault breaker). The 110V motor feed must be kept separate from 110V light switch leg. Keep motor and light neutrals separate. The lift's motor neutral is white and 14 gauge. Motor draws 2 amps or less at 110V. Only wire motor switch at this time. See [Diagram G. https://youtu.be/7TIXOAAKvUM?t=25s](https://youtu.be/7TIXOAAKvUM?t=25s)

⚠ Never wire the ALL300RM improperly. Make sure electricity is turned off when installing and/or performing maintenance on the ALL300RM. Improper wiring and/or electricity could cause death, personal injury, and/or property damage.

Diagram G

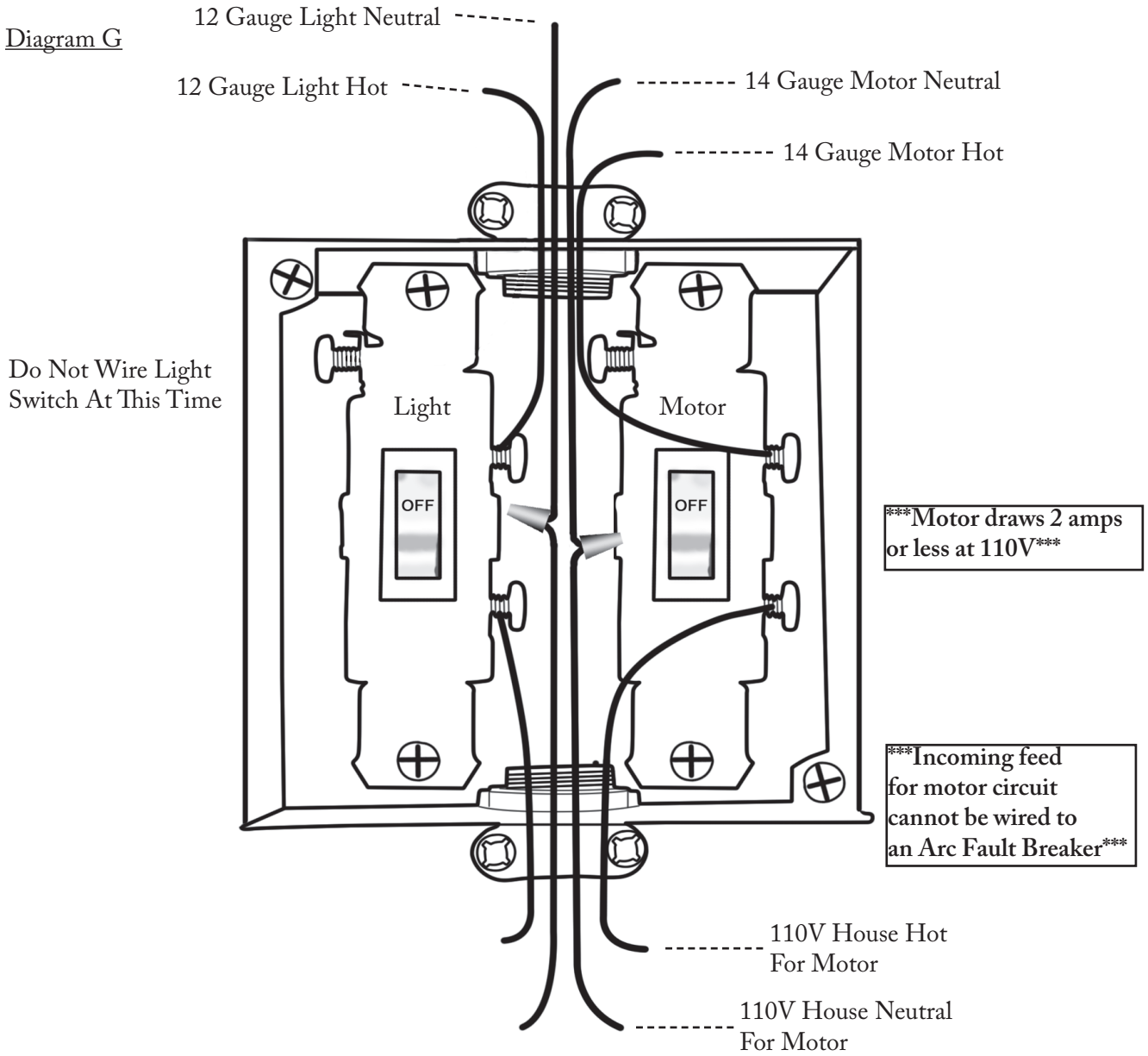

STEP 9

Remove dust cover and remove paper tape from winch drum while keeping tension on winch cable.

! Never operate the ALL300RM without tension on the cable. Never remove or tamper with the cable safety device. Never install an ALL300RM that has the cable safety device removed or tampered with. The cable safety device consists of the limit switch and small gauge rectangular wire and is located directly in front of the winch drum. Removing or tampering with the cable safety device could cause the cable to become reversed wrapped on the winch and could also cause the cable to unravel off the winch drum and get damaged. Never install or operate an ALL300RM that has a frayed, kinked, or otherwise damaged cable. Never operate the ALL300RM without first removing the paper tape from the winch drum. Avoiding any of these could cause the chandelier to fall, which could cause death, personal injury, and/or property damage.

STEP 10

Replace dust cover and locate controller wire. Controller wire is a low voltage, gray sheathed, four conductor wire with white plugs on either end. <https://youtu.be/7TIXOAAKvUM>



STEP 11

Ensure paper tape is removed from winch drum (Step 9). Plug controller to controller wire and operate motor down to extend winch cable to desired length for installation. Do not operate motor up. Reference Keyswitch Controller or SmartLift Controller guide for operation instruction. Keep tension on cable at all times. <https://youtu.be/AcaCOVKDM3A>



! Never extend the full length of winch cable from the ALL300RM. This could cause the cable to become reverse wrapped on the winch. An ALL300RM installed with a reverse wrapped cable can cause the chandelier to fall, which could cause death, personal injury, and/or property damage. Refer to the Keyswitch or SmartLift Controller tag for correct operating instructions. Winch cable length can be found on the ALL300RM product sticker, shipping box, and on the front page of these installation instructions.

! Never operate the ALL300RM without tension on the cable. Never remove or tamper with the cable safety device. Never install an ALL300RM that has the cable safety device removed or tampered with. The cable safety device consists of the limit switch and small gauge rectangular wire and is located directly in front of the winch drum. Removing or tampering with the cable safety device could cause the cable to become reversed wrapped on the winch and could also cause the cable to unravel off the winch drum and get damaged. Never install or operate an ALL300RM that has a frayed, kinked, or otherwise damaged cable. Never operate the ALL300RM without first removing the paper tape from the winch drum. Avoiding any of these could cause the chandelier to fall, which could cause death, personal injury, and/or property damage.

STEP 12

Proceed to step 13 unless bottom contact plate must be removed. Follow Diagram H *if and only if* bottom contact plate must be removed from winch cable. Diagram H must be followed precisely for proper detachment and reattachment procedure. Diagram H is on next page.

! Never stray from or alter the contact plate attachment/reattachment procedure. This could cause the chandelier to fall, which could cause death, personal injury, and/or property damage.

! Never detach the winch cable from the winch drum. This could cause the chandelier to fall, which could cause death, personal injury, and/or property damage.

Diagram H

See **STEP 12** on previous page for instruction and safety warnings before proceeding.

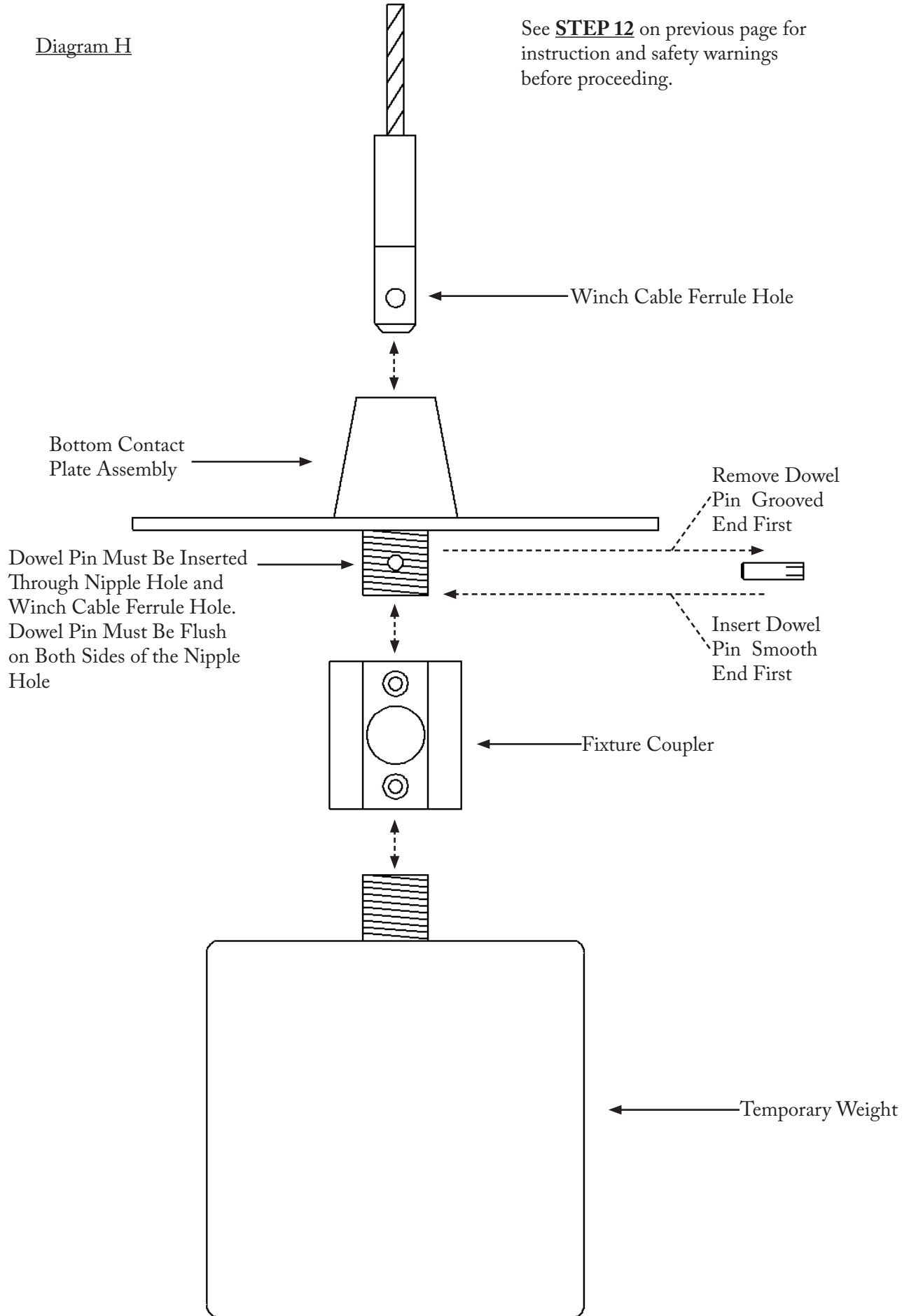

STEP 13

After turning off power, remove and discard existing electrical box if present in ceiling. Only use ceiling box provided with ALL300RM.

! Never remove an existing ceiling box while the power is connected. Electricity could cause death, personal injury, and/or property damage.

STEP 14

Cut a 4 1/2" hole in ceiling for ceiling box. If you removed an existing ceiling box, existing hole may need to be enlarged.

STEP 15

Tighten temporary weight to fixture coupler on bottom contact plate. Make sure jam nut on weight is tight.

! Never install or operate an ALL300RM before securing the temporary weight to the fixture coupler. This could cause the temporary weight to fall, which could cause death, personal injury, and/or property damage.

STEP 16

Fasten side brackets to chandelier pulley bracket using 3/8" x 1 1/4" hex tap bolts, 3/8" nylon lock nuts, and 5/16" USS flat washers. See [Diagram I](#).

Diagram I

3/8" x 1 1/4" Hex Tap Bolts
5/16" USS Flat Washers
3/8" Nylon Lock Nuts

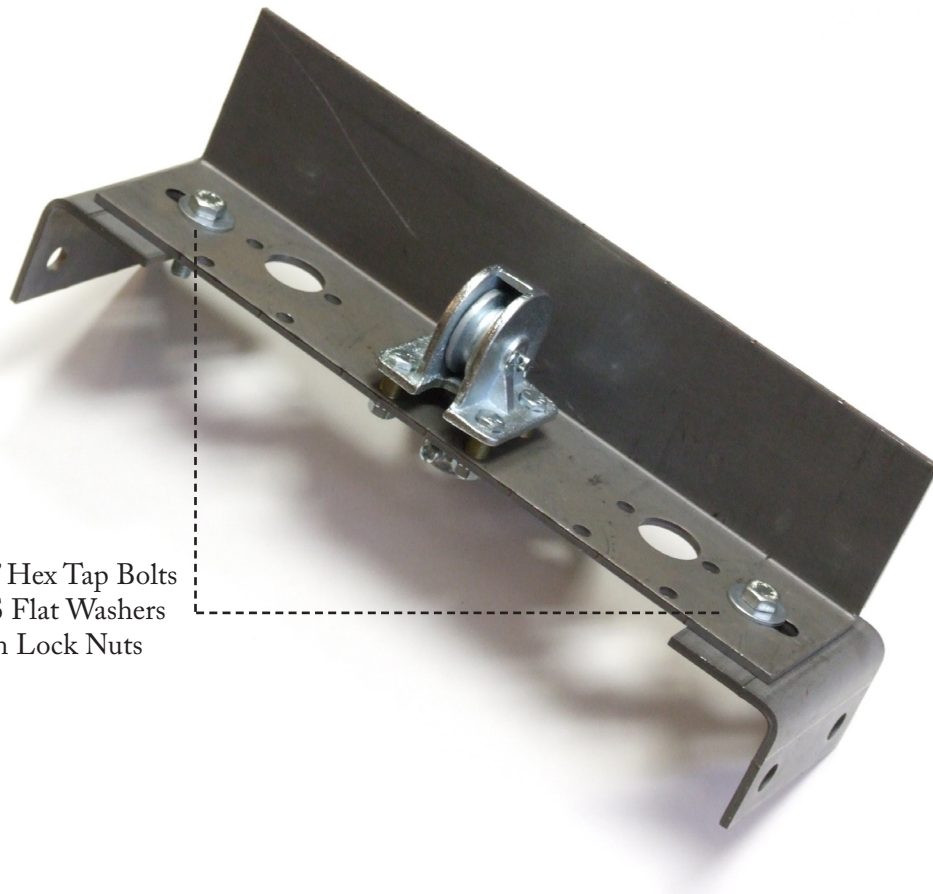

STEP 17

Attach conduit assembly to 3/4" conduit connector mounted below chandelier pulley. Once completely inserted, tighten set screw on conduit connector. See [Diagram K](#).

! Never attach or adjust the conduit assembly improperly. This could interfere with the automatic shutoff system and could cause the chandelier to fall, which could cause death, personal injury, and/or property damage.

STEP 18

Attach 1/2" conduit connector on ceiling box to bottom of conduit assembly. Once completely inserted, tighten set screw on conduit connector. See [Diagram K](#).

! Never attach or adjust the conduit assembly improperly. This could interfere with the automatic shutoff system and could cause the chandelier to fall, which could cause death, personal injury, and/or property damage.

STEP 19

Position chandelier pulley assembly where ceiling box will be centered in ceiling hole. Weight and bottom contact plate assembly should hang down through ceiling hole. See [Diagram K](#).

<https://youtu.be/IoMS5aDNN04>

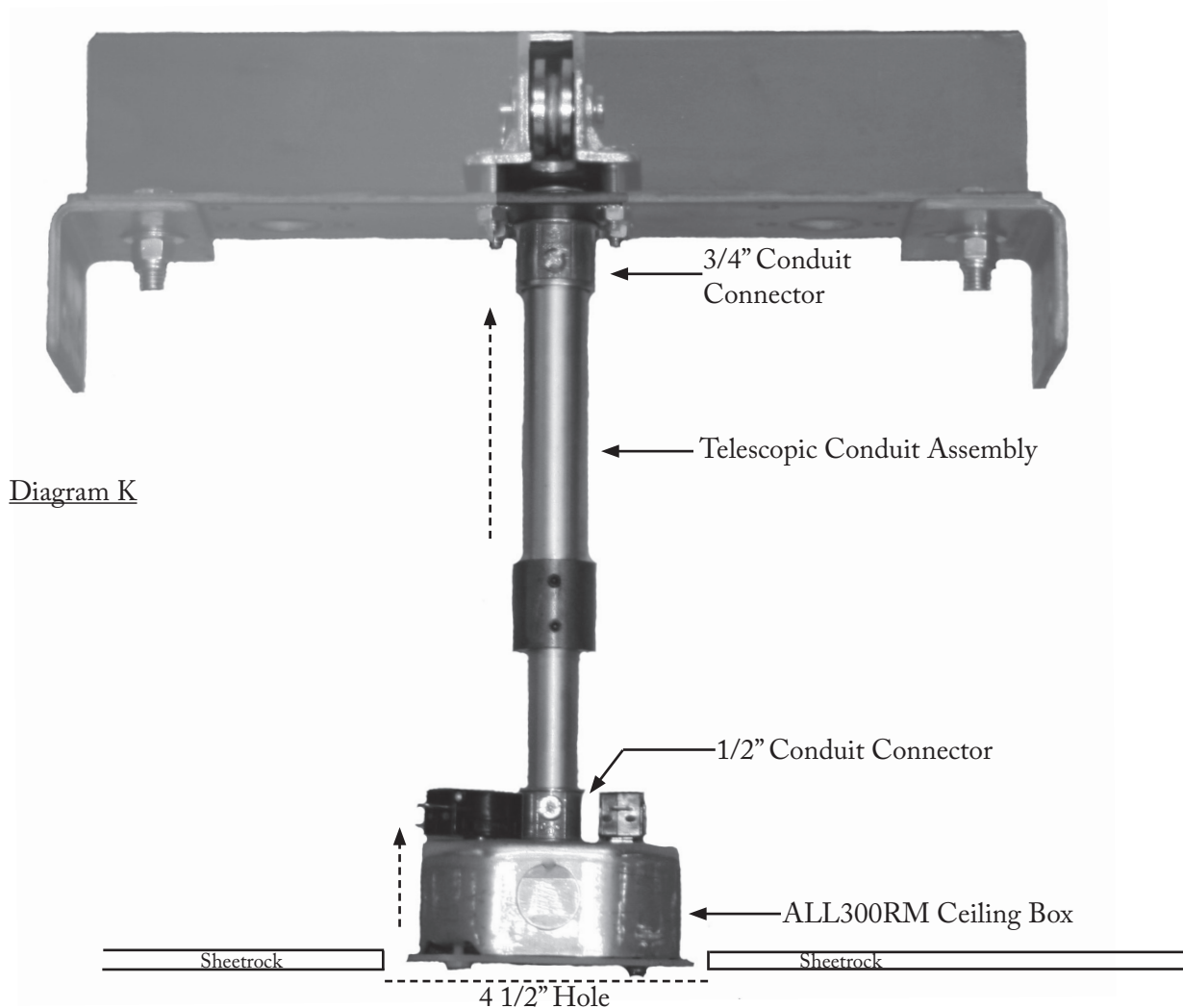

STEP 20

Loosely fasten chandelier pulley assembly to suitable structure using 7/16" x 4" hex tap bolts, 7/16" nylon lock nuts and 3/8" USS flat washers. See Diagram L.

STEP 21

Adjust ceiling box elevation up or down to be flush with sheetrock (this is a starting position, after the fixture is installed see step 34 for final adjustments). Use 3/32" Allen wrench on conduit coupler to loosen bottom set screw. Conduit is telescopic. The ceiling box should not touch inside of ceiling hole. Retighten bottom set screw on conduit coupler and confirm top set screw is tight. See Diagram L.

<https://youtu.be/JghN8ECvTz4>

! Never attach or adjust the conduit assembly and chandelier pulley assembly improperly. This could interfere with the automatic shutoff system and could cause the chandelier to fall, which could cause death, personal injury, and/or property damage.



Diagram L

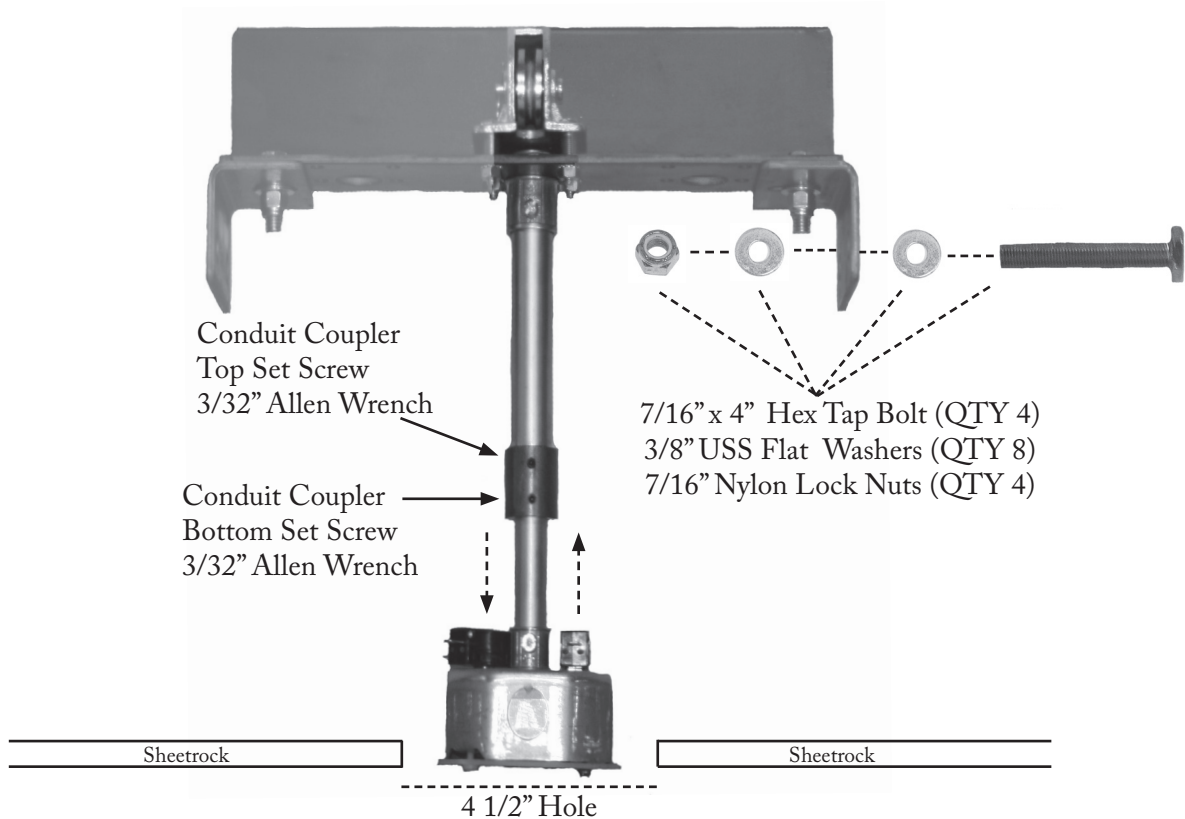

STEP 22

Shim and adjust chandelier pulley assembly so that winch cable hangs plumb through center of hole in top contact plate on ceiling box. See Diagram M. Look up at ceiling box from floor level to verify cable is plumb. <https://youtu.be/wpEWWOCOVCM>



! Never install the ALL300RM where the cable is not plumb through the center of the ceiling box. This could interfere with the automatic shutoff system and could cause the chandelier to fall, which could cause death, personal injury, and/or property damage.

STEP 23

Securely tighten chandelier pulley assembly hardware and verify that winch cable hangs plumb through center hole in top contact plate on ceiling box. Look up at ceiling box from floor level to verify cable is plumb. See Diagram M. <https://youtu.be/wpEWWOCOVCM>



Diagram M

Confirm winch cable hangs plumb through center of hole in top contact plate on ceiling box.

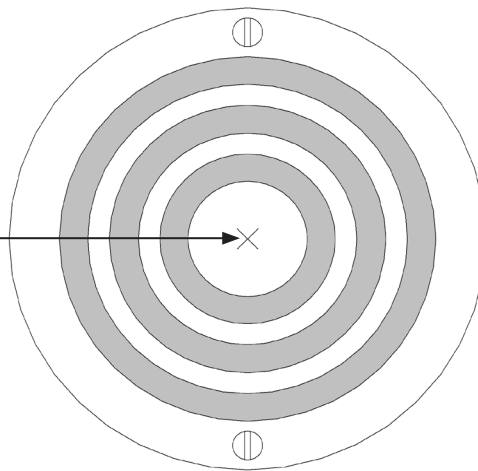

View from Floor Level

STEP 24

Install directional pulleys to suitable structure using 7/16" x 3 1/4" bolts, 7/16" nylon lock nuts, and 3/8" USS flat washers as per Diagram N. Securely tighten hardware.

! Never install directional pulleys without properly fastening them to the structure. This could interfere with the automatic shutoff system and could cause the chandelier to fall, which could cause death, personal injury, and/or property damage.

! Never install directional pulleys and/or the chandelier pulley assembly off plane. Never install directional pulleys and/or the chandelier pulley assembly where there will be right and left hand turns in the winch cable. This could damage the winch cable and could cause the chandelier to fall, which could cause death, personal injury, and/or property damage. Make sure the winch cable travels straight to and from the pulley grooves of each pulley. Make sure the winch cable is completely unobstructed between pulleys.

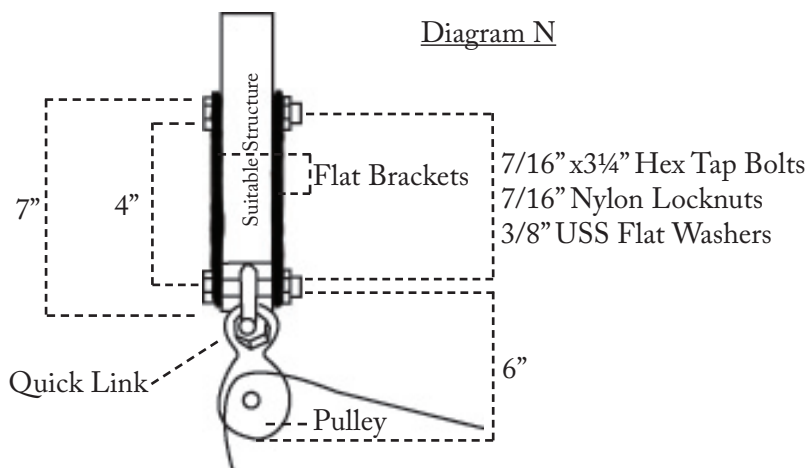

yes

NO



STEP 25

Turn off supply power before wiring ALL300RM light switch. Turn off light switch in square box. Wire light switch with 110V wiring. The 110V light switch leg can not be used as motor feed. Keep light and motor neutrals separate. The lift's light neutral is white and 12 gauge. If wired properly, a dimmer may be used. Wire a two-circuit light package on separate phases for lights (2 hots - 1 neutral). See Diagram O. <https://youtu.be/7TIXOAAKvUM?t=25s>



⚠ Never wire the ALL300RM improperly. Make sure electricity is turned off when installing and/or performing maintenance on the ALL300RM. Improper wiring and/or electricity could cause death, personal injury, and/or property damage.

Diagram O

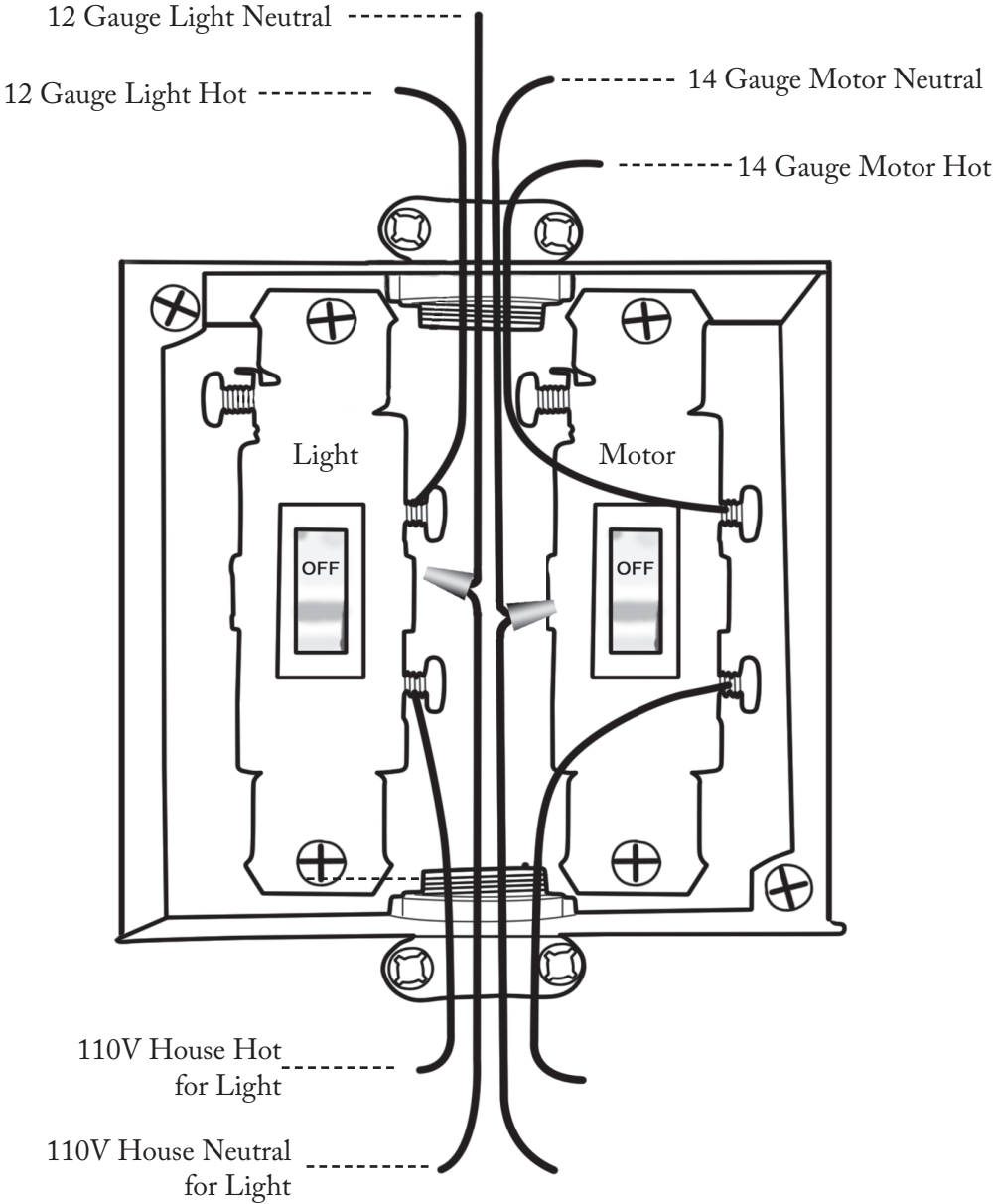

STEP 26

Run controller wire in to single gang box for Keyswitch Controller or optional SmartLift Controller. Chandelier must be visible from controller location. <https://youtu.be/7TIXOAAKvUM>



STEP 27

If using a Keyswitch Controller instead of a SmartLift Controller, secure key cylinder to cover plate using supplied keyswitch nut.

Plug controller to controller wire. Use supplied cover plate screws to attach controller to single gang box.

STEP 28

Ensure paper tape is removed from winch drum (Step 9). Test motor and automatic shut-off system of ALL300RM. For operation instruction, reference Keyswitch Controller Guide or SmartLift Controller Guide, then follow below:

Operate ALL300RM down a few inches. Operate ALL300RM up to CEILING POSITION. When ALL300RM pulls bottom contact plate and temporary weight to the CEILING POSITION, the motor will, if installed and adjusted properly, shut off by itself. <https://youtu.be/AcaCOVKDM3A>



Call Aladdin Light Lift (877) 287-4601 if ALL300RM does not shut off at CEILING POSITION.

 **Never extend the full length of winch cable from the ALL300RM. This could cause the cable to become reverse wrapped on the winch. An ALL300RM installed with a reverse wrapped cable can cause the chandelier to fall, which could cause death, personal injury, and/or property damage. Refer to the Keyswitch or SmartLift Controller tag for correct operating instructions. Winch cable length can be found on the ALL300RM product sticker, shipping box, and on the front page of these installation instructions.**

STEP 29

Operate ALL300RM to the DOWN POSITION. Temporary weight should be at desired elevation to install chandelier.

STEP 30



Holding tension on winch cable, unscrew temporary weight from fixture coupler.

 **Never operate the ALL300RM without tension on the cable. This could cause the cable to wind off the winch drum and get damaged. A damaged cable could cause the chandelier to fall, which could cause death, personal injury, and/or property damage.**

STEP 31

Fully thread screw collar loop or threaded stem that was supplied with chandelier to 1/4 IPS fixture coupler. If chandelier was supplied with a 3/8 IPS screw collar loop, obtain 1/4 IPS x 3/8 IPS fixture coupler included in parts bag. If chandelier was supplied with a 1/8 IPS or 1/2 IPS screw collar loop or threaded stem, contact Aladdin Light Lift (877) 287-4601 to obtain proper coupler. See [Diagram P](#).
<https://youtu.be/-MARQGfesIQ>



-  **Never install a chandelier on an ALL300RM using metric threaded fittings. They will not thread together properly and could cause the chandelier to fall, which could cause death, personal injury, and/or property damage. Only use IPS threaded fittings.**
-  **Never hang a chandelier from an ALL300RM using anything but the Aladdin Light Lift supplied fixture coupler, bottom contact plate, and dowel pin. This could cause the chandelier to fall, which could cause death, personal injury, and/or property damage.**

STEP 32

Attach chandelier canopy to screw collar loop using screw collar rings. See [Diagram P](#).

[Diagram P](#)

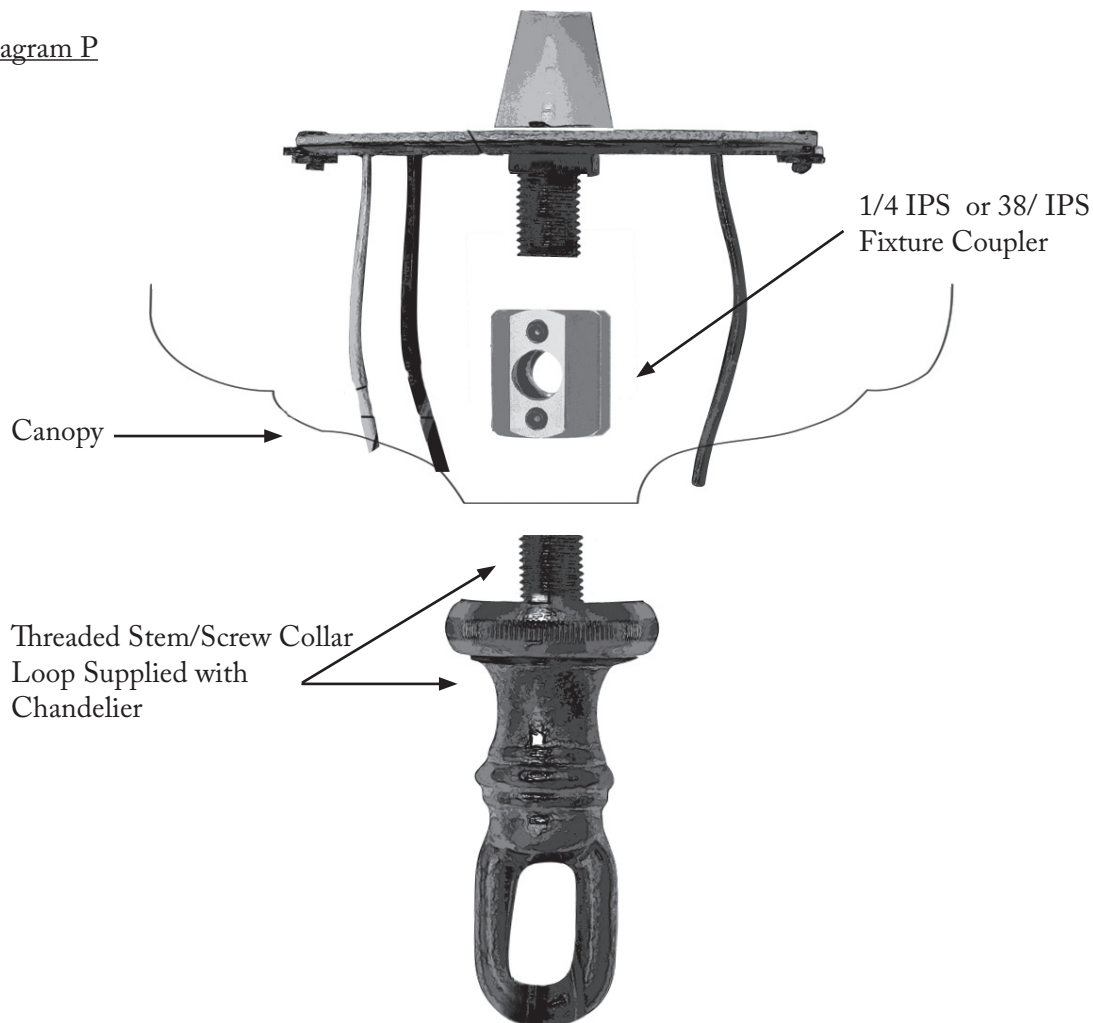

STEP 33

Adjust chandelier chain to desired length and attach to screw collar loop.

-  **Never cut, modify, or adjust the winch cable and never install an ALL300RM with a cut, modified or adjusted winch cable. Adjust the chandelier elevation by adjusting the chandelier chain or stem. An ALL300RM installed with a cut, modified, or improperly adjusted cable could cause the chandelier to fall, which could cause death, personal injury, and/or property damage.**

STEP 34

Adjust canopy and telescopic conduit assembly so contact plates meet before the canopy touches the ceiling. See Diagram R. <https://youtu.be/eQqLRAexFq8>



! Never allow the chandelier canopy to make contact with the ceiling before the contact plates meet. This could interfere with the automatic shutoff system and could cause the chandelier to fall, which could cause death, personal injury, and/or property damage.

STEP 35

Loosen bottom screw collar ring to allow easy wire access. See Diagram R.

STEP 36

Run chandelier wires through screw collar or threaded stem and pull through fixture coupler holes. See Diagram R. <https://youtu.be/-MARQGfesIQ>



STEP 37

Wire nut chandelier hot wire to black bottom contact plate wire, neutral to white, and ground to green. If the chandelier has two hot wires, wire extra hot to red wire. See Diagram R. Bare ground wire from chandelier can not touch underside of bottom contact plate. A direct short will occur. <https://youtu.be/-MARQGfesIQ>



Diagram R

Bottom Contact
Plate Must Meet
Top Contact Plate
Before Canopy
Touches Ceiling

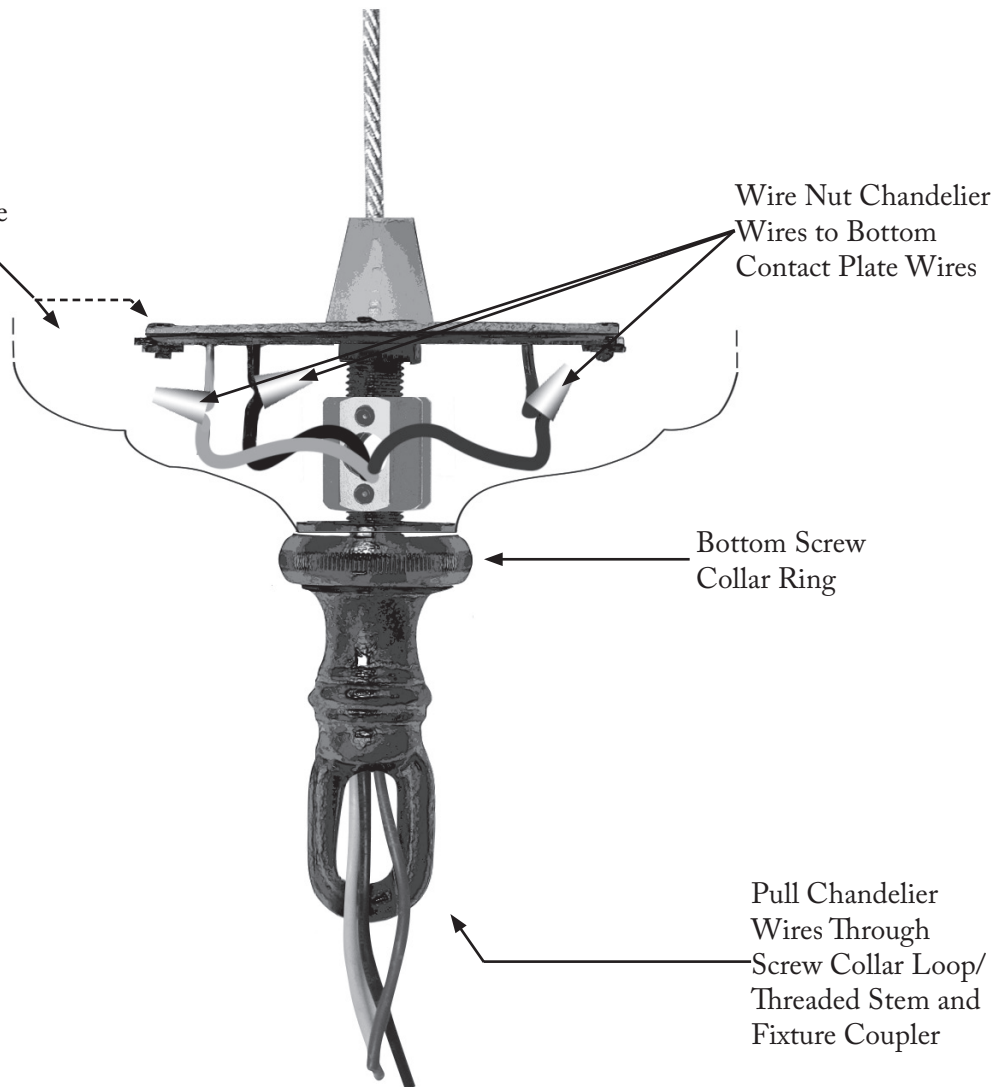

STEP 38

Tighten fixture coupler set screws using supplied 3/32" Allen wrench. Fixture coupler set screws have thread lock already applied at factory. See Diagram S. <https://youtu.be/-MARQGfesIQ>



STEP 39

Apply supplied liquid thread lock to all fittings including fixture coupler and screw collar loop fittings. See Diagram S.

! Never attach the chandelier to the ALL300RM improperly. Failure to secure the fixture coupler set screws and properly apply thread lock could cause the chandelier to fall, which could cause death, personal injury, and/or property damage.

STEP 40

Replace canopy and screw collar ring. Confirm adjustment of canopy and telescopic conduit assembly allows contact plates to meet before the canopy touches the ceiling. See Diagram S. https://youtu.be/GT_nwiZWa9o



! Never allow the chandelier canopy to make contact with the ceiling before the contact plates meet. This could interfere with the automatic shutoff system and could cause the chandelier to fall, which could cause death, personal injury, and/or property damage.

Diagram S

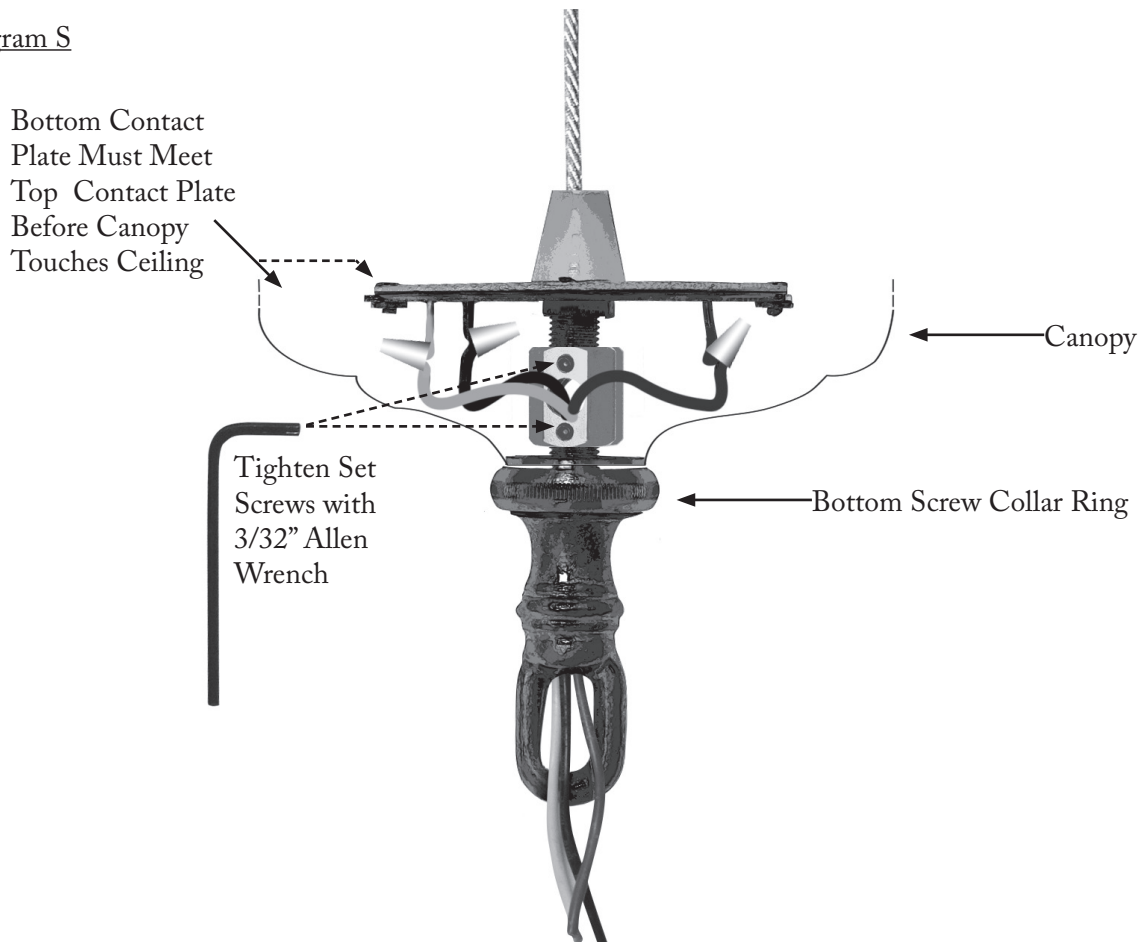

STEP 41

Confirm winch cable still hangs plumb through center of hole in top contact plate on ceiling box. See [STEP 22](#) and [Diagram M](#). <https://youtu.be/wpEWW0COVCM>



Diagram M

Confirm winch cable hangs plumb through center of hole in top contact plate on ceiling box.

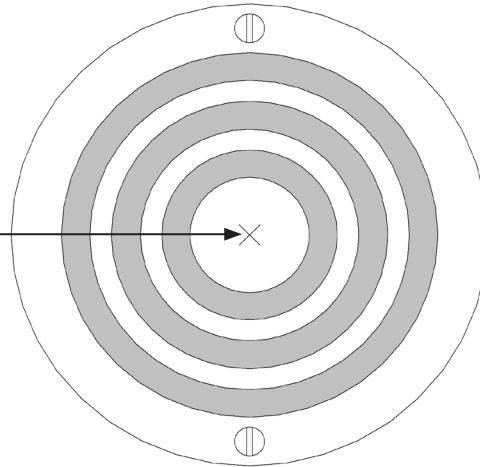

View from Floor Level

STEP 42

Operate ALL300RM to the CEILING POSITION. Test lights and call Aladdin Light Lift (877) 287-4601 with any questions regarding installation and/or operation of ALL300RM. https://youtu.be/GT_nwiZWa9o



ALL300RM TROUBLESHOOTING GUIDE

TECH SUPPORT: (877) 287-4601 Monday through Friday 8:00am to 4:00pm CST

I. Troubleshooting and installation must be performed by a licensed, bonded, and insured electrician. Electricity can cause death, personal injury, and/or property damage.

II. To perform most troubleshooting procedures, the following tools will be needed:

- a. 5/16" nut driver or 5/16" socket and ratchet
- b. Volt Meter
- c. 14 AWG jumper wire

III. Prior to troubleshooting or installation, read, understand and follow each safety warning in the ALL300RM installation instructions and safety precautions supplement. Failure to follow Aladdin's safety precautions and/or warnings could cause the chandelier to fall, which could cause death, injury, and/or property damage.

SYMPTOM: ALL300RM DOES NOT OPERATE:

Once ALL300RM is installed per the installation instructions, use the following steps to troubleshoot.

1. Confirm motor switch in the square box is turned on. The square box is mounted on the chassis plate of the ALL300RM, right in front of the control board. If it was found in the off position, flip it to the on position and use the controller to test the ALL300RM. If ALL300RM still does not operate, proceed to step 2.

2. Turn the motor and light switch in the square box to the off position. Using the 5/16" nut driver or socket, remove control board cover. Confirm motor fuse is good. The motor fuse is held to the control board by fuse clips and is located right in front of the motor assembly. Remove and perform a continuity test on the motor fuse. If the fuse reads continuity, place it back in the fuse clips. If it does not read continuity, it must be replaced with a good, 1.6 amp, slow blow fuse. Turn the motor and light switch in the square box to the on position, and use controller to test the ALL300RM. If the ALL300RM still does not operate, proceed to step 3.

3. Turn the motor and light switch in the square box to the off position. Confirm limit switch wires are attached properly. Confirm the limit switch wires are properly connected to the limit switch as well as the limit switch terminals on the control board. The limit switch is located on top of the ceiling box. The purple or white limit switch wire should be plugged from COM on the control board to the single terminal side of one limit switch. The orange or green limit switch wire should be plugged from NO on the control board to the top limit switch terminal on the double terminal side of the limit switch. The brown or red limit switch wire should be plugged from NC on the control board to the bottom limit switch terminal on the double terminal side of the limit switch. All three wires should be plugged to the same limit switch. If limit wires were found plugged incorrectly, plug them to their corresponding terminal and use the controller to test the ALL300RM. If the ALL300RM still does not operate, proceed to step 4.

4. From where the ALL300RM is installed, call Aladdin Light Lift technical support Monday through Friday during normal business hours at (877) 287-4601.

SYMPTOM: CHANDELIER WILL NOT LIGHT:

Once the ALL300RM is installed per the installation instructions, use the following steps to troubleshoot.

Note: If the top contact plate is painted, the chandelier will not light. The motor circuit must be hot in order for the lights to work.

ALL300RM TROUBLESHOOTING GUIDE cont.

1. Confirm ALL300RM is at the CEILING POSITION. If not, use the controller to operate the ALL300RM to the CEILING POSITION. Chandelier will only light at the CEILING POSITION. If operated to the CEILING POSITION and the chandelier will still not light, proceed to step 2.
2. Confirm light and motor switch in the square box are turned on. The square box is mounted on the chassis plate of the ALL300RM, right in front of the control board. If it was found in the off position, flip it to the on position and to test the chandelier. If chandelier still does not light, proceed to step 3.
3. Turn the motor and light switch in the square box to the off position. Confirm light fuse is good. The light fuse is held to the control board by fuse clips and is located right in front of the light relay. Remove and perform a continuity test on the light fuse. If the fuse reads continuity, place it back in the fuse clips. If it does not read continuity, it must be replaced with a new, 15 amp, fast blow fuse. If the ALL300RM was equipped with a 2200 watt upgrade package, replace with a new, 20 amp, fast blow fuse. Turn the motor and light switch in the square box to the on position, and test the chandelier. If the chandelier still does not light, proceed to step 4.
4. From where the ALL300RM is installed, call Aladdin Light Lift technical support Monday through Friday during normal business hours at (877) 287-4601. A voltage meter will be needed to further test the ALL300RM.

SYMPTOM: ALL300RM WILL NOT SHUT OFF PROPERLY AT CEILING POSITION:

Discontinue use immediately and contact Aladdin Light Lift at (877) 287-4601.

After all troubleshooting is complete, replace control board cover.

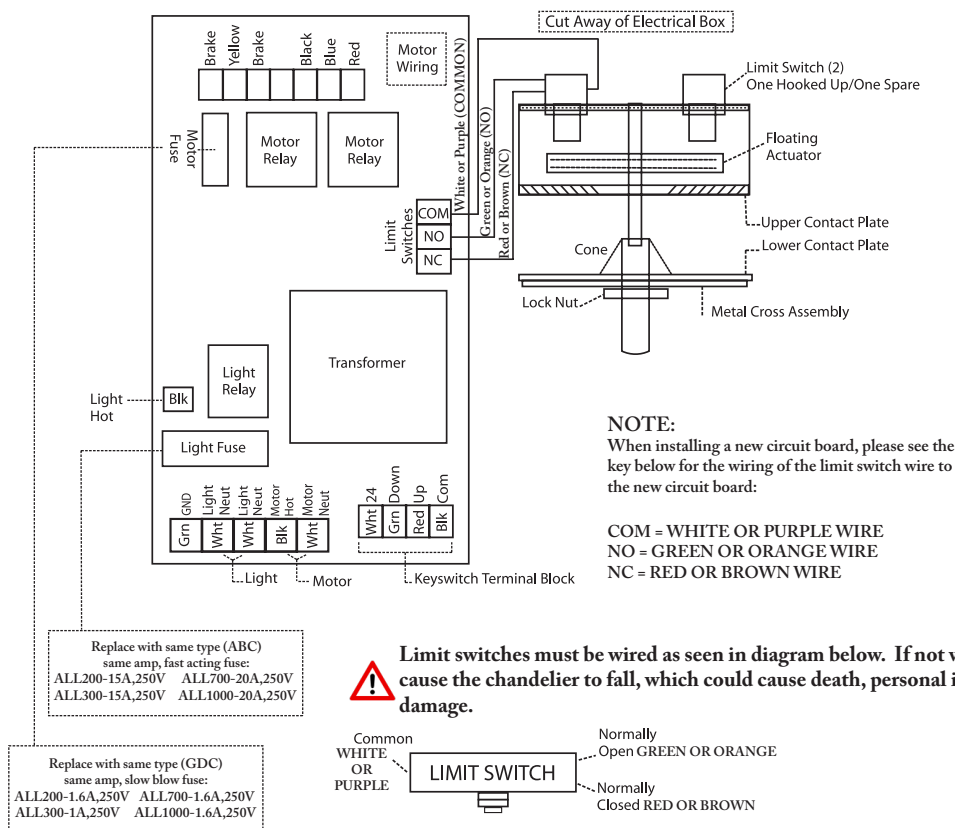

Warranty Agreement

Aladdin Light Lift, Inc. warrants its chandelier light lift unit for one year from the date of purchase. The warranty includes all parts provided the unit is installed properly by a licensed electrician. Labor charges will be the responsibility of the purchaser. If the unit does not operate properly, the purchaser must contact a factory authorized service technician approved by Aladdin Light Lift, Inc. to determine if the unit was installed properly. The technician will furnish a written report to the purchaser and Aladdin concerning any problem with the lift system which will be binding on all parties concerned. All defective parts must be returned to Aladdin Light Lift, Inc. for the warranty to apply. Any alteration or by-passing of the electrical or mechanical system of exceeding the wattage maximum (as indicated on the lift) will void the warranty and can result in an electrical hazard. This warranty agreement showing date of purchase and distributor must be filled out at www.aladdinlightlift.com/warranty-card.php within 30 days of purchase to validate the warranty. Call your distributor to obtain the name of a factory authorized technician in your area.