

INSTALLATION INSTRUCTIONS

FPDL/U

EMERGILITE BRAND

**When using this lighting device
the safety precautions should be followed at all time
PLEASE READ CAREFULLY AND FOLLOW ALL
INSTRUCTIONS FOR YOUR OWN SAFETY**

1. This device is designed for indoor use. Do not use outdoors.
2. Prior to installation, battery connector must be open to prevent high voltage from being present on output leads (red & yellow).
3. This product is for use with 14 W through 54W(2'-4')T5 and T8 single pin or bipin for one lamp, Instant Start and Rapid Start, 14W through 39W(2'-4')T5 and T8 single pin or bipin for two lamp, Instant Start and Rapid Start, 18 W through 50 W (4-pin) long compact Rapid Start, or 32 W (4-pin) compact, 24W through 32W U-Bend FBT8 fluorescent lamps from Philips, Osram and GE or equivalent manufacture.
4. Please ensure the electrical connections conform to the National Electrical Code and local regulations if applicable.
5. To avoid electric shock, please disconnect normal and emergency power supplies, and battery connector of the emergency ballast before servicing.
6. This device is designed for factory or field installation in either the ballast channel, or on top of the indoor fixture, except air handling heated air outlets, wet or hazardous location fixtures. Do not install this device near gas or electric heaters.
7. AC power source of 120VAC or 277VAC is required.
8. The battery is sealed, non-maintenance, and is not replaceable in the field. Please contact manufacturer for information on service. Do not attempt to service the battery please.
9. Do not use accessory equipment that is not recommended by manufacturer. Failure to do so may cause unsafe conditions. Servicing should only be performed by qualified service personnel.
10. Do not use the product for other purpose that the product is NOT designed for.

PLEASE SAVE THESE INSTRUCTIONS

INSTALL INSTRUCTION

NOTE: All the branch circuit wiring has to be ready as well as an unswitched source of power before the fixture is installed. Both AC and Emergency Ballasts must be Fed From the same branch circuit.

CAUTION Battery connector has to be opened to prevent high voltage on output leads (Red and Yellow). Wait until all the installation process is completed and AC is supplying power to the emergency ballast before joining the battery connector.

1. AC power has to be off before installation.
2. Choose the right wiring diagram to connect the emergency ballast to AC ballast and lamp.
3. Please ensure the electrical connections conform to the National Electrical Code and local regulations if applicable.
4. Follow the diagram 1&2 to install the emergency ballast in the ballast channel.
5. Wall switch has to be connected properly (Check diagram 3), Match the violet and brown leads to connect the **TBIL** to the emergency ballast (Check diagram 4). The **TBIL** would be on after the fixture is installed properly.
6. Please search in readily visible location and stick the label with "CAUTION: This Unit Has More Than One Power Supply Connection Point. To Reduce The Risk Of Electric Shock, Disconnect Both The Branch Circuit-Breakers Or Fuses And Emergency Power Supplies Before Servicing."
7. Do not join the inverter connector until the fixture is completely installed and AC power is supplied to the emergency ballast.
8. The battery needs to be charged for one hour in order to have short-term testing on the emergency function. Before having a long-term emergency function testing, the battery in emergency ballast has to be charged for 24 hours.

DIAGRAM 1

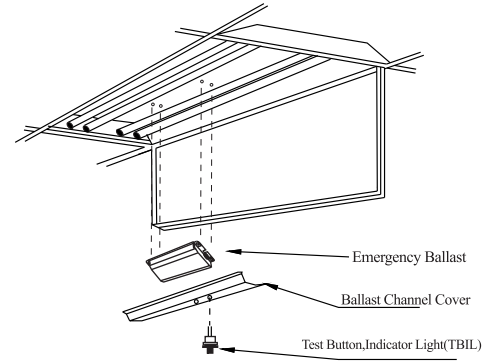

DIAGRAM 2

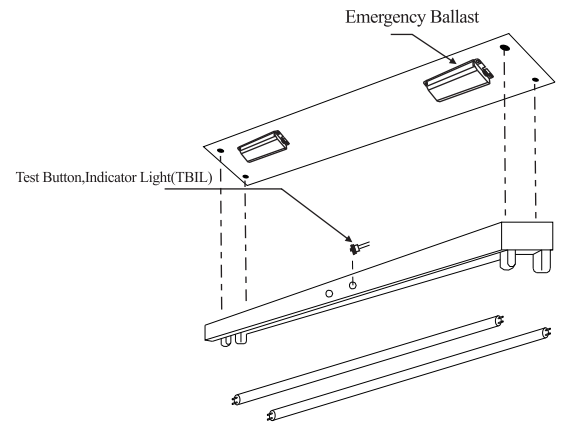
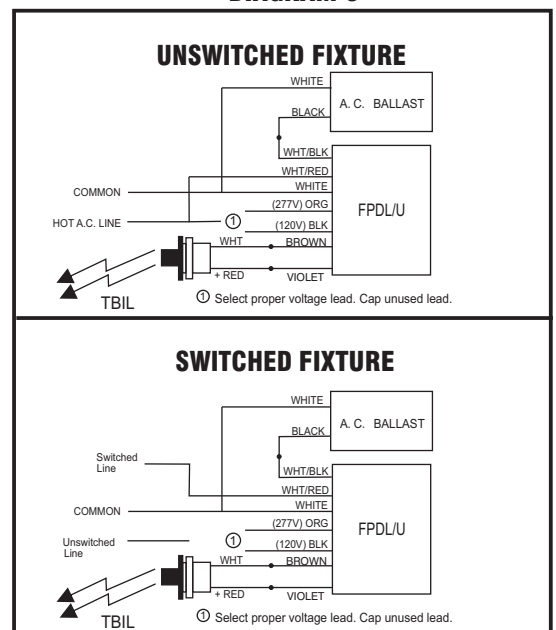

DIAGRAM 3



NOTE: MARK AN APPROPRIATE LABEL ON INDICATOR LIGHT AND TEST SWITCH AFTER INSTALLATION.

DIAGRAM 4

OPERATION

THE CHARGING INDICATOR LIGHT WOULD BE ON TO INDICATE THE BATTERY IS BEING CHARGED WHEN AC POWER IS APPLIED.

THIS EMERGENCY BALLAST WOULD FUNCTION AND OPERATE ONE OR TWO LAMPS AT LEAST 90 MINUTES WHEN THE AC POWER IS FAILED.

THE EMERGENCY BALLAST WILL OPERATE 14WATT TO 54WATT LAMPS AT LEAST 90MINUTES.

MAINTENANCE

NOTE: SERVICES SHOULD ONLY PERFORMED BY QUALIFIED PERSONNEL.

THE EMERGENCY BALLAST SHOULD BE CHECKED PERIODICALLY TO CONFIRM FUNCTIONING AND THE FOLLOWING SCHEDULE IS RECOMMENDED.

- 1) INSPECT THE CHARGING INDICATOR EVERY MONTH AND CONFIRM THAT IS ILLUMINATED.
- 2) PUSH THE TEST SWITCH FOR 30 SECONDS TO ENSURE THE EMERGENCY BALLAST IS FUNCTIONING. PERFORM THIS TEST EVERY 30 DAYS.
- 3) PERFORMING A LONG-TERM TEST (90 MINUTE BATTERY DISCHARGE) ONCE IN EVERY YEAR. ONE OR TWO LAMPS SHOULD BE OPERATED FOR NO LESS THAN 90 MINUTES.

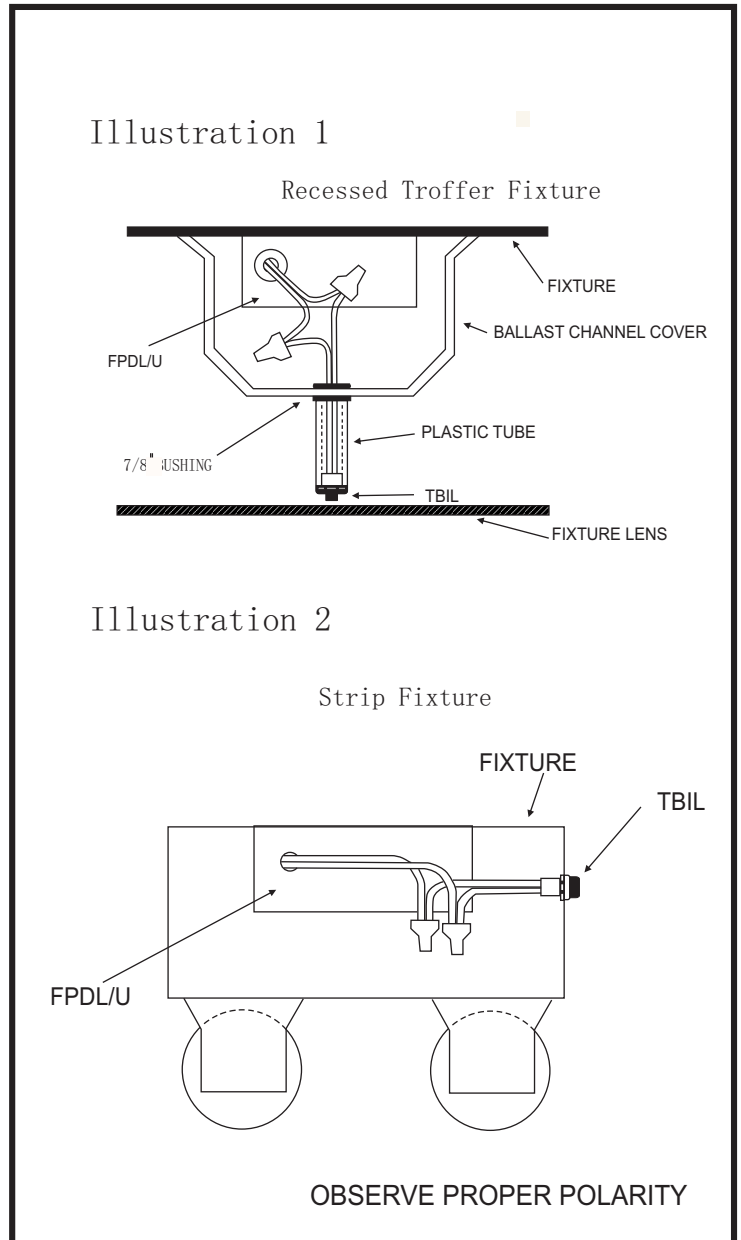

NOTE: MARK AN APPROPRIATE LABEL ON INDICATOR LIGHT AND TEST SWITCH AFTER INSTALLATION.

TABLE 1 (FOR BROWN CONNETOR)

LAMP DIAMETER	T5 ,T8		LONG COMPACT			COMPACT	U-Bend FBT8	
BASE TYPE	SINGLE OR BIPIN		4 PIN(2G11)			4-PIN	4 PIN	
POWER (LENGTH)	14W-39W	40W-54W	18W-39W	40W-50W		32W	24-32W	
NUMBER OF LAMPS EMER.	1	2	1	1	2	1	1	2
BROWN CONNECTOR	CLOSE	OPEN	CLOSE	CLOSE	OPEN	CLOSE	CLOSE	OPEN

EMERGENCY BALLAST AND AC BALLAST MUST BE FED FROM THE SAME BRANCH CIRCUIT

TYPICAL SCHEMATICS ONLY. MAY BE USED WITH OTHER BALLASTS. CONSULT THE FACTORY FOR OTHER WIRING DIAGRAMS.

WIRING DIAGRAM

For One Lamp Emergency Operation(14-54W)

A. ONE (1) LAMP INSTANT START BALLAST

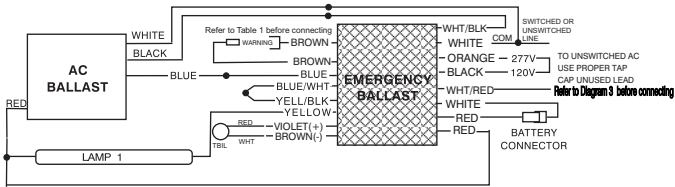

E. ONE (1) LAMP RAPID START BALLAST

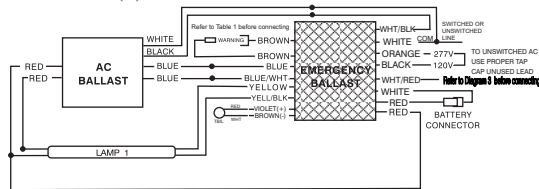

B. TWO (2) LAMP INSTANT START BALLAST

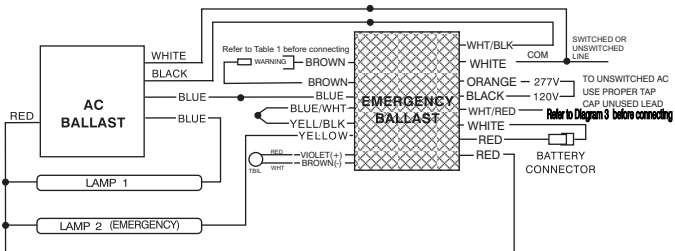

F. TWO (2) LAMP RAPID START BALLAST

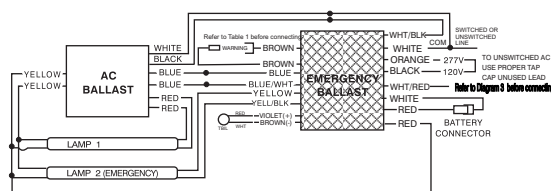

C. THREE (3) LAMP INSTANT START BALLAST

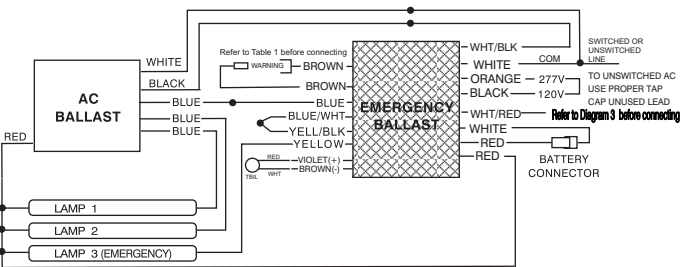

G. TWO (2) LAMP RAPID START BALLAST

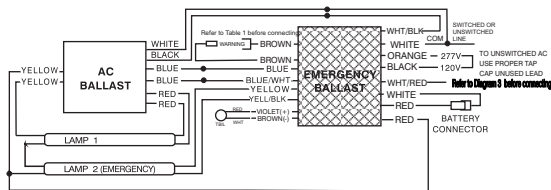

H. THREE (3) LAMP RAPID START BALLAST

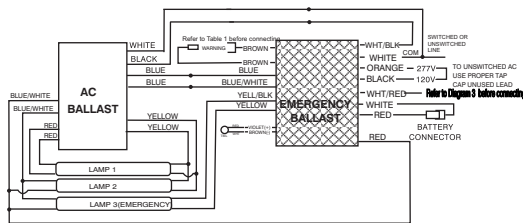

D. FOUR (4) LAMP INSTANT START BALLAST

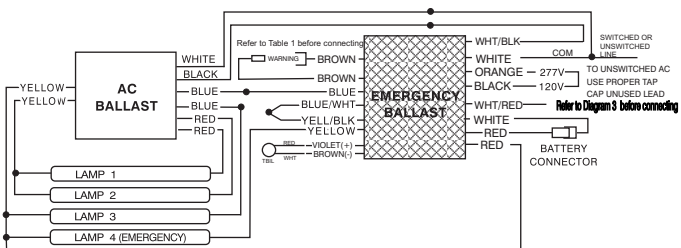

I. FOUR (4) LAMP RAPID START BALLAST

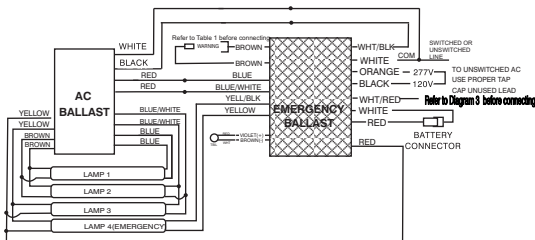

NOTE: Use the proper input voltage lead, cap unused lead

EMERGENCY BALLAST AND AC BALLAST MUST BE FED FROM THE SAME BRANCH CIRCUIT

TYPICAL SCHEMATICS ONLY. MAY BE USED WITH OTHER BALLASTS. CONSULT THE FACTORY FOR OTHER WIRING DIAGRAMS.

WIRING DIAGRAM

For Two Lamps Emergency Operation (14-54W)

A. TWO (2) LAMP INSTANT START BALLAST

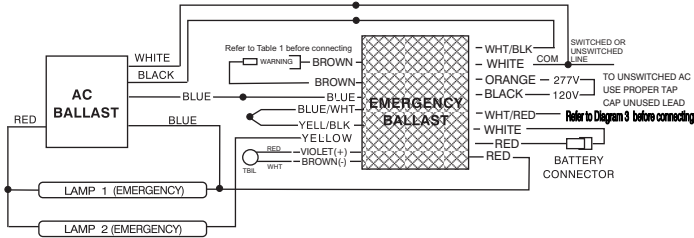

D. TWO (2) LAMP RAPID START BALLAST

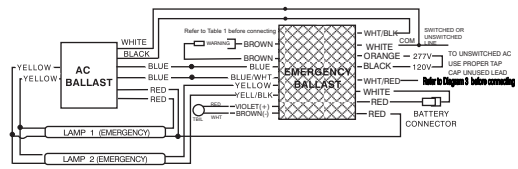

B. THREE (3) LAMP INSTANT START BALLAST

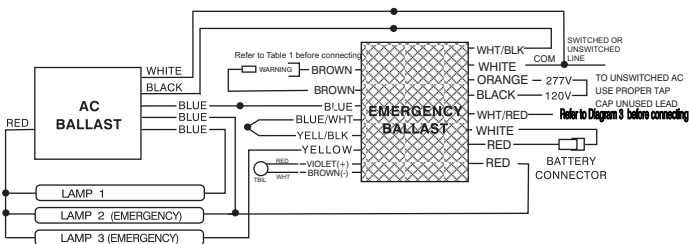

E. TWO (2) LAMP RAPID START BALLAST

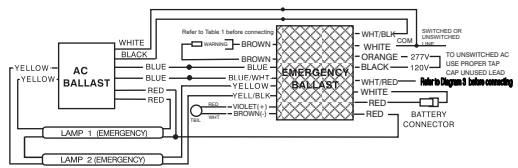

C. FOUR (4) LAMP INSTANT START BALLAST

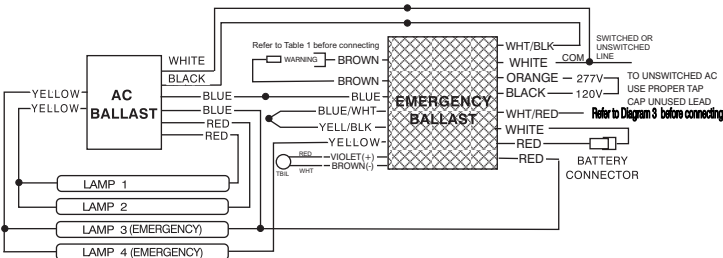

F. THREE (3) LAMP RAPID START BALLAST

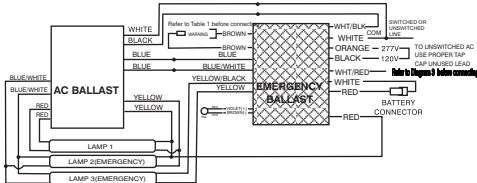

G. FOUR (4) LAMP RAPID START BALLAST

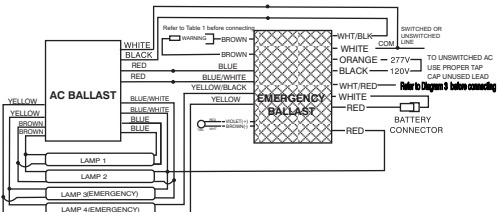

Emergency only Operation

A. ONE (1) LAMP WITHOUT AC BALLAST (14-54W)

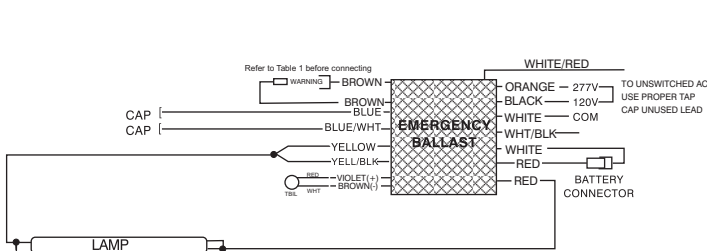

B. TWO (2) LAMP WITHOUT BALLAST (14-54W)

