

LED-8024E Instruction/Installation Manual

<u>SKU (USA)</u>	<u>SKU (Canada)</u>	<u>Description</u>
LED-8024E30	LED-8024E30C	45W 3000K
LED-8024E42	LED-8024E42C	45W 4200K
LED-8024E57	LED-8024E57C	45W 5700K

Notes:

1. Before beginning installation of LED for HID lamp, please read the complete instructions list below. Keep this document for future reference
2. To avoid possible electric shock, power supply must be turned off at fuse box or circuit breaker before installing or servicing.
3. Dropping, over torqueing screw base or impacting lamp during installation may cause damage and may void warranty.
4. Risk of Fire: High voltage wiring connecting the fixture must have a temperature rated minimum of 194°F.
5. Before installation of any LED for HID model into existing HID fixture, check your local electrical code. This code sets wiring standards for your area and should carefully studied before starting installation
6. Protect the lamp from dust and dirt, clean with soft damp cloth only, do not use chemical cleaners.
7. Ensure that outdoor fixture is sealed per manufacturers recommendations to reduce dust and insects from gaining entry.
8. When installing LED-8000 series retrofit lamps within HID fixtures, ballast must be bypassed when present.
9. 8000 series retrofits are UL damp rated, sealing the fixtures after installation will deliver best results.
10. Installing surge/lightning protectors is highly recommended and helps to eliminate premature driver failure caused by surges and other power fluctuations.
11. The recessed luminaire can not use with through-branch wiring.

Contents:





- 1 PCS LED Retrofit lamp**
- 1 PCS Re-lamping label**
- 1 PCS Instruction/Installation Manual**

REQUIREMENTS		
Input Voltage:	USA	Canada
		120-277VAC
Frequency:	50/60Hz	
Base:	E26 Medium	
Approved Housings:	Recessed	
	Fully Enclosed	
	Open (indoor)	
Min. Housing Size: (Inches)		
Height:	9.4"	
Diameter:	3.9"	



IMPORTANT SAFETY INSTRUCTIONS FOR LED RETROFIT CONVERSION:

FOR USE ONLY WITH HID LUMINAIRES IN ACCORDANCE WITH THE INSTRUCTIONS PROVIDED WITH THIS RETROFIT KIT.

-  **WARNING - RISK OF FIRE OR ELECTRICAL SHOCK.** LED retrofit kit installation requires knowledge of luminaires electrical systems. If not qualified, do not attempt installation. Contact a qualified electrician.
-  **WARNING - RISK OF FIRE OR ELECTRICAL SHOCK.** Install this kit only in the luminaires that have the construction features and dimensions shown in the photographs and/or drawings and where the input rating of the retrofit kit does not exceed the input rating of the luminaire.
-  **WARNING -** Do not make or alter any open holes in an enclosure of wiring or electrical components during kit installation.
-  **WARNING -** To prevent wiring damage or abrasion, do not expose wiring to sharp edges of housing or other sharp surface.
-  **WARNING -** Not for use with HID ballast, 120-277VAC(USA)/120-347VAC(Canada) direct line voltage only.

THIS DEVICE IS NOT INTENDED FOR USE WITH EMERGENCY EXITS.

<u>SKU (USA)</u>	<u>SKU (Canada)</u>	<u>Description</u>
LED-8024E30	LED-8024E30C	45W 3000K
LED-8024E42	LED-8024E42C	45W 4200K
LED-8024E57	LED-8024E57C	45W 5700K

Installation:

- Step 1:** Disconnect Electrical Power to fixture.
- Step 2:** Remove or wire past the ballast where applicable.
- Step 3:** Connect the two common wires from the power source directly to the corresponding leads to the socket.
note: The screw of the lamp holder shall be connected to the NEUTRAL wire (white or gray).
- Step 4:** Attach the retrofit lamp to the female socket of the existing luminaire. To avoid damaging lamp do not over-torque or overtighten lamp. The E26 medium female lamp holder should have suitable mounting strength to securely hold lamp in place.
- Step 5:** Apply the silver adhesive label to the inside of the luminaire where it will be visible during re-lamping.
- Step 6:** Turn on electrical power to the fixture.

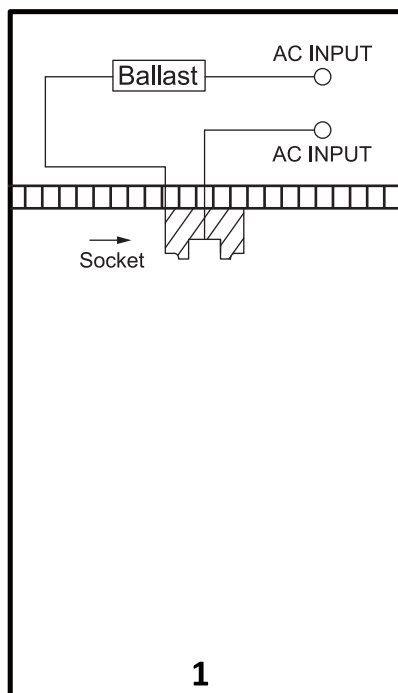

Before Rewiring

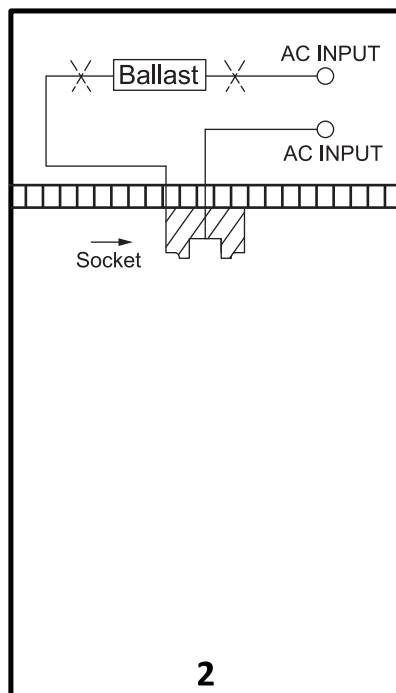

**Disconnect and/or
Remove Ballast**

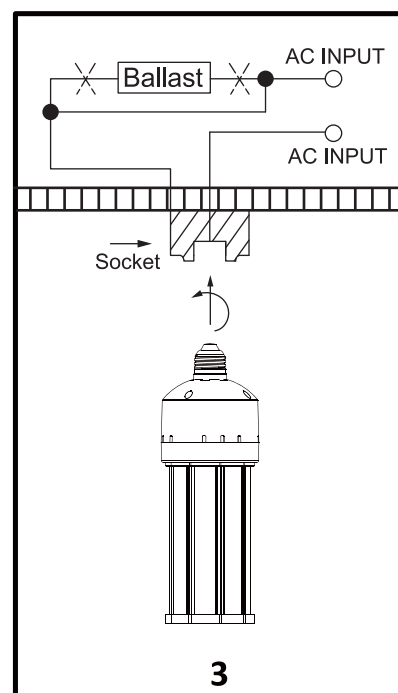

Socket Wiring Diagram