



# AMTC/25DTC Communications Add-On Covers

## INSTALLATION INSTRUCTIONS

Wiremold Electrical Systems conform to and should be installed and properly grounded in compliance with requirements of the current National Electrical Code, Canadian Electrical Code or codes administered by local authorities. All electrical products may represent possible shock or fire hazard if improperly installed or used. Wiremold electrical products are UL listed, made for interior use only and should be installed in conformance with current local and/or the National Electrical Code.

Components Included: ACT Series - One (1) High Profile Bezel, One (1) Sheet of 30 Designation Icons (white), Two (2) Outlet ID Labels with Clear Covers, and Two (2) Color Matched Screw Covers.

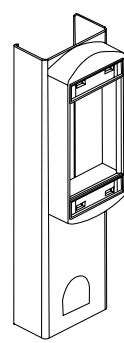

25DTC-ACT

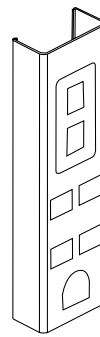

25DTC-CVR

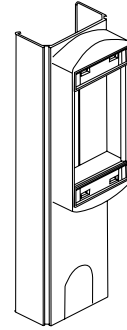

AMTC-ACT

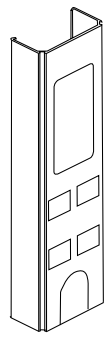

AMTC-CVR

### For Replacing Existing Covers:

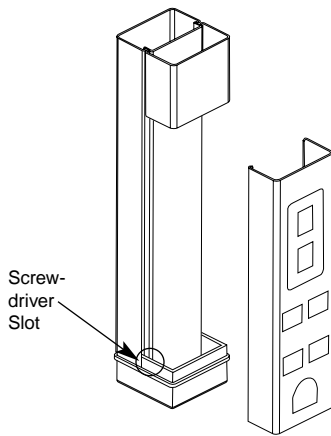

1. Unsnap existing 8" cover from center divider using screwdriver slot (screwdriver required).

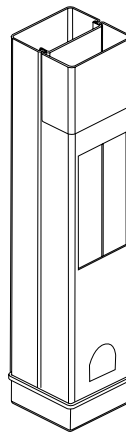

2. Snap on new cover to center divider.

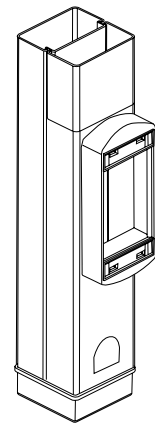

3. Snap on Activate™ bezel for 25DTC/AMTC-ACT covers. Refer to Activate instructions for installing inserts.

### For Adding Additional Cover:

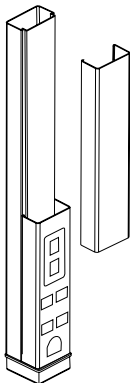

1. Unsnap main cover from center divider (screwdriver required).

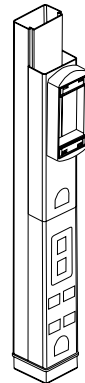

2. Cut 8" off main cover. Snap on new communications cover to center divider.

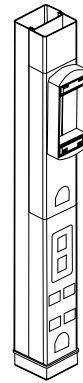

3. Snap on main cover to center divider **with factory cut side placed at new seam** (cut cover edge is in ceiling).