

INSTALLATION AND QUICK START GUIDE

WARNINGS AND CAUTIONS:

- **TO AVOID FIRE SHOCK OR DEATH; TURN OFF POWER** at circuit breaker or fuse and test that power is off before wiring, servicing, installing or removing device.
- WSS20-GXX products do not require a neutral wire. There is a minimum load requirement of **25 Watts** for these products.
- To be installed and/or used in accordance with electrical codes and regulations.
- If you are unsure about any part of these instructions, consult an electrician.
- Recommended minimum wall box depth is 2-1/2".
- Use this device with **copper or copper clad wire only**.

DESCRIPTION

The LevNet RF Decora® Rocker Switch (WSS20) is designed to use wireless communication (902.875MHz) and provide remote control of your lighting. The relay will turn the load ON when the top button is pressed and OFF when the bottom button is pressed. The Indicator LED will blink Red when a message is received from a learned wireless device such as an occupancy sensor or remote switch. **NOTE:** The no-neutral version of the WSS20 has a minimum load requirement of 25 watts.

Devices can be learned directly into the WSS20 via the Programming Mode Selection Menu or via the Leviton ComWi software and WSCOM tool.

The WSS20 Decora® rocker switch has a 100-150 ft. reception range depending upon the environment and transmission device. Range will be reduced by signals having to transmit through walls.

Transmit range for WSS20, when utilized as a repeater or for initial setup/commissioning is approximately 50ft.

FEATURES

- Able to switch single load ON/OFF remotely
- Scene Capable
- Green Locator LED when device is OFF
- Can be remotely configured and commissioned using the LevNetRF ComWi software and WSCOM hardware
- Includes repeater function to increase wireless reception to other devices
- Ease of installation – No new wiring
- Title 24 Vacancy Mode (Manual ON/Auto OFF) supported when paired with occupancy sensor
- WSS20-G has built in air-gap switch to disable current flowing to the load for replacing bulbs

COMPATIBLE DEVICES

Most EnOcean Alliance enabled devices which conform to the EnOcean Equipment Profile (EEP) are compatible with the WSS20 Decora® rocker switch. This includes but is not limited to room controllers, occupancy sensors, key cards, unpowered switches, door and window sensors made by Leviton as well as other EnOcean Alliance companies which support EEP 2.5 and above.

• **WSCxx & WSS20 (together):** In Manual-On/Auto-Off mode, the button must be pressed to turn the lights ON. In the absence of occupied messages sent from the occupancy sensor, the receiver switch will Time-Out and turn the lights OFF. This mode has a 30 second vacancy confirmation feature which exists to turn the relay back ON in case of false OFF scenarios.

• **WSCxx & WSS20 (together):** In Auto-On/Auto-Off mode, the sensor will send a message to the receiver to turn the lights ON. In the absence of occupied messages sent from the occupancy sensor, the receiver switch will Time-Out and turn the lights OFF.

NOTE: The sensor must sense motion and send a message to start the time delay and enable Auto-Off.

EQUIPMENT NEEDED FOR INSTALLATION

- Slotted/Phillips Screwdriver
- Electrical Tape
- Pliers
- Pencil
- Cutters
- Ruler

INSTALLATION

Changing the color of your WSS20 switch:

Your WSS20 switch includes three color options. The WSS20 switch ships with the white frame attached. To change color of the frame, proceed as follows:

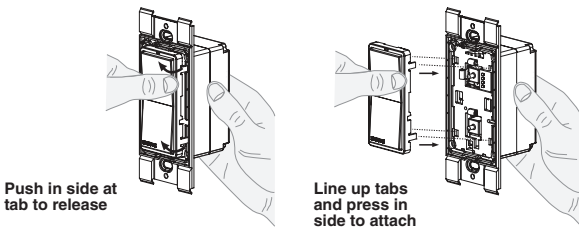

INSTALLING YOUR WSS20 SWITCH

NOTE: Use check boxes when Steps are completed.

Step 1 **WARNING: TO AVOID FIRE SHOCK OR DEATH; TURN OFF POWER** at circuit breaker or fuse and test that power is off before wiring!

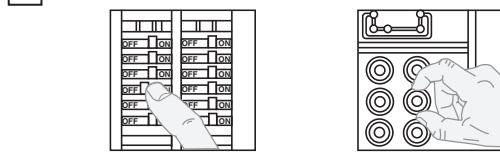

Step 2 **Identifying your wiring application (most common):**

NOTE: If the wiring in your wall box does not resemble this configuration, consult an electrician.

Single Pole

1. Line
2. Neutral
3. Ground
4. Load

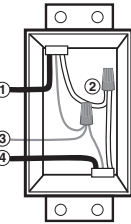

Step 3 **Single Pole Wiring Application:**

- WSS20 Receiver Control Switch is only intended as a Single Pole device.

Multiple Location Wiring Application:

- WSS0S Wireless Remote Switch can be used for additional switches (3-way and 4-way), no wires necessary.

WIRING SWITCH:

Connect wires per WIRING DIAGRAM below as follows:

- Connect (Hot) wire from wall box to black wire on switch.
- Connect (Load) wire in wall box to blue wire on switch.
- Connect (Neutral) wire in wall box to white wire on switch.

NOTE: For No Neutral model, white wire will not be available (Figure 2).

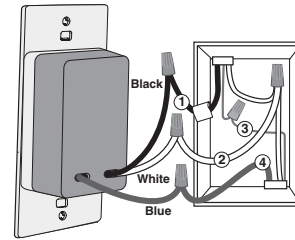

Figure 1 - With Neutral (white wire)

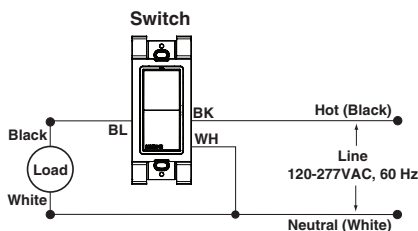
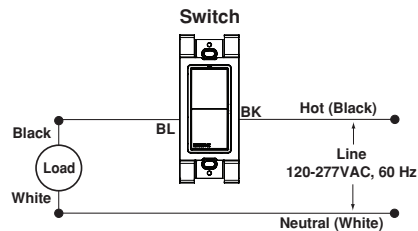
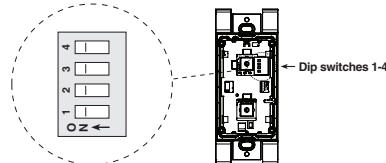

Figure 2 - No Neutral (no white wire)



Step 4 **Dip Switch Settings:**

NOTE: dip switch settings, the switch frame and paddle will need to be removed. Refer back to the "Changing the color of your WSS20 switch" section for removal instructions of the switch frame. This can only be done with the wall plate removed.



Auto-ON / Auto-OFF mode: Auto mode can be enabled using the dip switches, product comes from the factory in Manual-ON/Auto-OFF.

Walk-through: Can be used only in Auto-ON mode. It is recommended to only use this setting when wireless occupancy sensors with batteries have been installed.

Timeout: 2 (test), 10, 20, 30min; (Longer time delay is recommended for continuous self-powering of the occupancy sensor and to ensure packets are sent to the WSS20 receiver switch.

DIP SWITCH SETTINGS		
Dip Switch	ON Position	OFF Position
1	Manual-ON/Auto-OFF	Auto-ON/Auto-OFF
2	Walk Through ON	Walk Through OFF
2 Min Time-Out		
3	-	X
4	-	X
10 Min Time-Out		
3	-	X
4	X	-
20 Min Time-Out		
3	X	-
4	-	X
30 Min Time-Out		
3	X	-
4	X	-

Step 5 **Testing your WSS20 prior to mounting in wall box:**

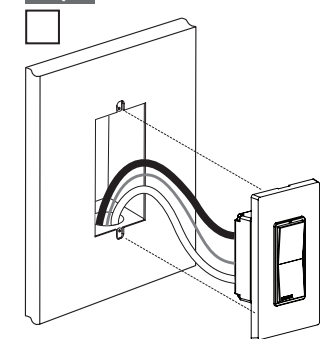

- Position all wires to provide room in outlet wall box for WSS20.
- Ensure that the locator LED is facing up on WSS20.
- Partially screw in mounting screws in wall box mounting holes.

NOTE: Dress wires with a bend as shown in diagram in order to relieve stress when mounting WSS20.

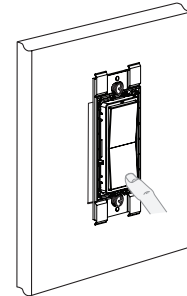

- Restore power at circuit breaker or fuse.
- Press pad at the TOP until locator LED is OFF. Lights should turn ON.

If lights do not turn ON, refer to the TROUBLESHOOTING section.

Step 6 **Switch Mounting:**
TURN OFF POWER AT CIRCUIT BREAKER OR FUSE.

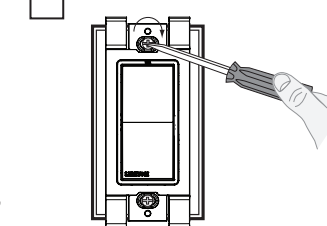

Tighten mounting screws to secure the device to the wall box.

Step 7 **Wall Plate Mounting:**

Place plastic/nylon Decora® wallplate over device and secure in place with screws provided.

Note: Usage of a metal wall plate may result in reduction, or loss of receiving range for WSS20 wall switch.

Step 8 **Restore Power:**

Restore power at circuit breaker or fuse.
Installation is complete.

AIR-GAP SWITCH (WSS20 with No Neutral):

The WSS20 switches with No Neutral have a built in air-gap switch to disconnect voltage and current flowing to the load in the event of replacing the load (bulb, etc.) or to disconnect the load for safety reasons. On the switch, engage the air-gap switch by pushing hard on the bottom of the switch until you hear a click and the green locator LED goes OFF (refer to figure). When the air-gap is engaged, the locator LED will be OFF and the LOAD will be OFF. This confirms the air-gap switch has been activated and the load is no longer receiving power.

Once the WSS20 air-gap is activated and power has been removed from the load the lighting bulb(s) can be safely replaced.

Push on bottom of switch until a click is heard and Green Locator LED goes OFF.

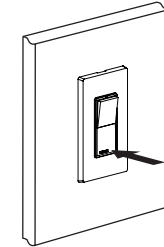

General Operation

The **locator LED** will illuminate GREEN when the load is in the OFF position to facilitate access in the dark.

Push Pad (Default settings)

Turn ON from OFF position: Push the top of the switch.

Turn OFF from ON position: Push the bottom of the switch.

Cleaning: Clean with a damp cloth. **DO NOT** use chemical cleaners.

If there is a power outage, when the power is restored, the lights will return to the last known state so long as the device was in that state for 30 seconds or more.

INSTALLING SOFTWARE (OPTIONAL)

For users who have purchased the LevNet RF USB computer link tool (WSCOM) or similar device, Leviton offers an optional configuration and commissioning software package (www.levnetrf.com). This software works with the WSCOM hardware to allow for user configuration of the WSS20 registers as well as adding new devices remotely.

For additional details refer to the ComWi Installation & Operation instructions. Consult the factory for details.

Programming Instructions:

All devices are learned in a "reduced sensitivity" mode to avoid interference from other devices which may be active in areas close by. This reduction of sensitivity reduces the range so devices learned to the WSS20 Decora® Rocker Switch should be within 10 ft when learning.

Factory settings:

WSS20: Manual ON/Auto OFF, Walk Through mode OFF (disabled), Occupancy Time-Out delay = 20min, Key Card/Momentary Time-Out delay = 0s, Repeater = disabled.

Factory setting operation:

When entering the room, the wireless receiver control switch will need to be manually turned ON. Once learned into the receiver switch, the Wireless occupancy sensor will send messages to the receiver switch, keeping the lights on until the room is vacant. Once the occupancy sensor stops sending messages and the receiver time out period expires the lights will turn OFF.

Time-Outs:

When used with an occupancy sensor the WSS20 has four time-out settings: 2 (test), 10, 20, or 30 min. (a longer timeout is recommended when using self-powered devices in dark spaces). The time-out duration is user selected through the use of the Dip Switch Settings. **NOTE:** Since the sensor is only sending a message every one to two minutes, the 2 minute time delay is not sufficient for normal operation.

Walk-Through Time Delay:

The walk-through feature is only active in the Auto-ON/Auto-OFF mode with time delay > 2 minutes. This feature is useful when a room is momentarily occupied. When enabled, the WSS20 will turn the lights OFF shortly after the person leaves the room. The walk-through feature works in the following manner: When a person enters the room, the lights will turn ON. If the person leaves the room before the walk-through time-out of 2.5 minutes, the Sensor will turn the lights OFF within 2.5 minutes of no occupancy detected. If the room is occupied for longer than 2.5 minutes, the Sensor will enter the Occupied Mode with the time-out duration specified by the Dip Switch settings.

There are six distinct programming modes, each represented by a different Amber Blink:

Amber Blinks	Mode	Details
1	Rocker	<ul style="list-style-type: none"> • Door and Window Sensors – "Normal" mode. OPEN = OFF (magnet is not near sensor), CLOSED = ON (magnet near sensor). • Switches – Sets the device to use the "I" side to turn the light ON and the "O" side to turn the light OFF. Acts like normal rocker light switch. • Occupancy sensor – Can be learned in mode, Dip-Switch controls Auto or Manual ON and walk through modes. • SLT Device – "Normal" mode. Similar to a switch which turns lights ON and keeps lights on when active.
2	Momentary	<ul style="list-style-type: none"> • Door and Window Sensors – "Inverted" mode. OPEN = ON (magnet is not near sensor), CLOSED = OFF (magnet near sensor). • Switches and Key Cards – Press turns the lights ON and release turns them OFF. Intended for key card devices to turn lights ON when card is inserted and OFF when removed. Only applies to the actual button pressed on the device (ignores the other side of a Decora® rocker switch). • Occupancy sensor – Can be learned in mode, Dip-Switch controls Auto or Manual ON and walk through modes.
3	Toggle	<ul style="list-style-type: none"> • Door and Window Sensors – "Inverted" mode. OPEN = ON (magnet is not near sensor), CLOSED = OFF (magnet near sensor). • Switches/Key Cards – The state of the lights will toggle with the press of the switch or insertion of a Key Card. Only applies to the actual button pressed on the device (ignores the other side of a Decora® rocker switch). • Occupancy sensor – Can be learned in mode, Dip-Switch controls Auto or Manual ON and walk through modes.
4	Scene	<ul style="list-style-type: none"> • Door and Window Sensors – "Inverted" mode. OPEN = ON (magnet is not near sensor), CLOSED = OFF (magnet near sensor). • Switch and Key card devices – Restores the state of the lights to what they were when the device was learned. Only applies to the actual button pressed on the device (ignores the other side of a Decora® rocker switch).
5	Clear	<ul style="list-style-type: none"> • Clears all devices from memory and returns non-switch configured device parameters to factory default configuration.
6	Repeater	<ul style="list-style-type: none"> • Repeater disabled – 2 Red blinks • Repeater Level 1 enabled – 2 Green blinks

Follow these directions for the standard way to program and configure the WSS20 Decora® Rocker Switch. The **BOTTOM** button of the WSS20 rocker switch (aka Programming Button) is the only button used during the Programming Mode.

1. Enter Programming Mode by pressing and holding the **BOTTOM** switch button for 15 Seconds until the LED on the WSS20 begins blinking Amber slowly once (1x). This is the Mode Selection Menu of programming.
2. Press the Programming Button to advance between the six programming modes. The Amber LED will blink to represent the Programming Mode.
3. Press and hold the Programming Button 3-5 seconds to enter the desired Programming Learn Mode. The LED will blink Red (empty) or Green (devices in memory) upon entering the Programming Learn Mode.

- Press the Programming Button for 1-2 seconds to leave the programming mode and go back to the Mode Selection Menu (Amber blink).
 - Device will exit Programming Mode after 20 seconds of inactivity.
- NOTE:** Amber blinking LED represents the Mode Selection Menu of programming. No devices can be learned into the WSS20 with Amber blinking lights. A Red or Green blinking LED represents the Programming Learn Mode.

Rocker Mode Programming Instructions (One Amber Blink)

- Upon entering Programming Mode, the device will automatically begin in Rocker Mode (Amber LED blinking once).
- To Learn a device in Rocker Mode press and hold the Programming Button for 3-5 seconds until the LED changes from Amber to Red or Green to signify you are now in the Programming Learn Mode.
- When learning a wireless switch to the WSS20, press one end of a switch rocker. When learning a transmitter other than a wireless switch or keypad, press the LEARN button on the transmitter (**see appropriate transmitter instruction sheet**). The LED on the WSS20 will turn Amber and the load will toggle states for 2 seconds indicating that the WSS20 has stored the transmitter's unique ID in its memory.
NOTE: The LED will change from Blinking Red to Blinking Green on the first learned device or increase the number of Green blinks to represent a device was learned.
NOTE: Pressing the transmitter switch again will unlearn the unique ID. The load will not toggle and the Green LED will light up for 2 seconds before going back to a Red or Green blink.
NOTE: If only one transmitter is desired then skip to Step 6.
- To program additional transmitters to communicate with the WSS20 in Rocker Mode, wait until LED blinking resumes. Repeat the instructions in Step 3 until the unique IDs of all desired transmitters are stored in the Rocker Mode memory of the receiver (up to 20). The Green tracking blinks for up to 20 devices learned, however, the Programming Mode will exit after 20 seconds of inactivity so it will not be possible to tell if 20 devices are learned.
- To program additional transmitters to communicate with this WSS20 in another Mode, press the Programming Button and return to the Mode Selection Menu (Amber LED blinking). The Amber LED will be blinking 1x for Rocker Mode. Pressing the Programming Button on the WSS20 will advance the Amber blinking to the next Programming Mode, Momentary Mode (Amber Blink 2x). Follow Steps 3 and 4 to program transmitters to Momentary Mode.
- To exit Learn Mode, just wait; the receiver automatically exits Learn Mode after 20 seconds (indicated by the ceasing of the LED blinking).

Momentary Mode Programming Instructions (Two Amber Blinks)

- Read all Rocker Mode programming steps before taking any action to program the receiver in Momentary Mode.
- While the WSS20 is in the Mode Selection Menu (Amber LED blinking) press the Programming Button to advance the Amber LED to blinking 2x (Momentary Mode).
- To Learn a device in Momentary Mode press and hold the Programming Button for 3-5 seconds. The LED will change from Amber to Red or Green to signify you are now in Programming Learn Mode.
- Follow Steps 3-6 of "Rocker Mode Programming Instructions" described above.

Toggle Mode Programming Instructions (Three Amber Blinks)

- Read all Rocker Mode programming steps before taking any action to program the receiver in Toggle Mode.
- While the receiver is in the Mode Selection Menu (Amber LED blinking) press the Programming Button to advance the Amber LED to blinking 3x (Toggle Mode).
- To Learn a device in Toggle Mode press and hold the Programming Button for 3-5 seconds. The LED will change from Amber to Red or Green to signify you are now in the Programming Learn Mode.
- Follow Steps 3-6 of "Rocker Mode Programming Instructions" described above.

Scene Mode Programming Instructions (Four Amber Blinks)

- Before going into Programming Mode toggle the load of the WSS20 to the state desired for Scene Mode. Turn load ON if load is desired ON or OFF if it is desired OFF for the Scene Mode being programmed.
- Enter Programming Mode (hold down the Programming Button for 15 seconds until the Amber LED begins blinking).
- While the receiver is in the Mode Selection Menu (Amber LED blinking) press the Programming Button to advance the Amber LED to blinking 4x (Scene Mode).
- To Learn a device in Scene Mode press and hold the Programming Button for 3-5 seconds. The LED will change from Amber to Red or Green to signify you are now in the Programming Learn Mode.
- Press the wireless light switch to be learned for the Scene. The load will stay ON for 2-3 seconds indicating that the receiver has stored the transmitter's unique ID in its memory. The LED will change from Red to Green or increase the number of Green blinks per cycle as additional devices are learned.
- Follow Steps 4-6 of "Rocker Mode Programming Instructions" described above.

Clear Mode Programming Instructions (Five Amber Blinks)

- While the receiver is in the Mode Selection Menu (Amber LED blinking) press the Programming Button to advance the Amber LED to blinking 5x (Clear Mode).
- To enter the Clear Mode, hold the Programming Button for 3-5 seconds. The LED will change from Amber to a single Red or Green blink to signify you are now in the Clear Mode of programming.
- To CLEAR ALL devices from memory and reset to factory defaults press the Programming Button for 5 seconds. The entire memory of the receiver will be deleted. The receiver LED will blink Red when the process is complete.
- To program new devices, press the receiver Programming Button and return to the Mode Selection Menu (Amber LED blinking). Select the mode desired for programming devices.

Repeater Mode Programming Instructions (Six Amber Blinks)

- While the receiver is in the Mode Selection Menu (Amber LED blinking) press the Programming Button to advance the Amber LED to blinking 6x (Repeater Mode).
- To enter the Repeater Mode, hold the Programming Button for 3-5 seconds. The LED will change from Amber to a double Red or double Green blink to signify Repeater disabled (Red) or Repeater Enabled (Green).
- Press and hold the Programming Button for 2-3 seconds to toggle between repeater modes.
- To leave this mode and program new devices, press the Programming Button for less than 2 seconds to return to the Mode Selection Menu (Amber LED blinking). Select the mode desired for programming devices.

Selective Deleting (unlearn): Go back to the same mode the device was learned (Rocker Switch = Rocker Mode, Key Card = Momentary Mode) and enter the Programming Learn Mode. Press the button on the transmitter to be unlearned. The load will not toggle but the Green locator LED will remain ON for 2 seconds. The number of devices in memory will reduce by one resulting in either a Red blink (nothing in memory) or one less Green blink representing the number of devices learned. If the device toggles the load and the Amber LED stays on for 2 seconds then the device was learned. This means the device has been learned in another mode. Unlearn the device and go to a different Learn Mode to try again.

LED feedback/indicators in the learn programming mode:

- 1 Red blink = no learned devices
- 1 Green blink = 1 learned device
- 2 Green blinks = 2 learned devices
- 3 Green blinks = 3 learned devices
- X Green blinks = X or more learned devices (A maximum of 20 devices can be learned)

Helpful Hint: When operating normally, pressing the learn button will toggle the state of the lights (Occ Sensors/SLT devices) to allow for validating range.

DEBUG MODE

A special debug mode is accessible by holding down the TOP Decora® Rocker button for 5 or more seconds. On release of the button the LED will blink Amber once to confirm the special debug mode has been entered. The debug mode will be enabled for 3 minutes to allow for signal strength testing of LEARNED devices. The estimated signal strength of a learned device will be shown as follows:

- No LED blink = no packet received
- Red LED blink = Low Signal Strength (RSSI -83dB or less)
- Amber LED blink = Medium Signal Strength (RSSI between -66dB to -82dB)
- Green LED blink = High Signal Strength (RSSI -65dB and above)

If the device shows RED (make sure it is in debug mode) from the transmitting device then it is recommend to relocate that device so the receiver shows either amber or green to allow sufficient signal strength for receiving all messages sent by the transmitter.

TROUBLESHOOTING

WSS20 has no power:

- WSS20 has a bad wiring connection
- WSS20 air-gap switch maybe engaged (No-Neutral device)

Locator LED does not turn ON with device in OFF state:

- Circuit breaker or fuse has tripped
- Neutral connection is not wired for neutral device
- Device air-gap is engaged (No-Neutral device)
- The device is not connected up to sufficient load of 25 Watts (No-Neutral)

When paired with an Occupancy Sensor:

System is set to Manual ON but lights automatically turn ON

- The device has a 30 second vacancy confirmation when lights go out or power is lost to allow the lights to turn back on for false-OFF issues.
- Adjust range POT (CCW) slightly to reduce sensitivity, relocate Sensor away from heat/light source, or re-configure WSS20 to MANUAL ON mode.

Sensor turns lights back ON right after they turn OFF

- Adjust Occupancy Sensor range POT sensitivity (CCW) slightly to reduce range or relocate Sensor farther away from light or heat source.

False Tripping when no one is around

- Adjust range POT (CCW) slightly to reduce sensitivity, relocate Sensor closer to light source, or re-configure WSS20 to MANUAL ON mode.

Confirm Range

- Press the learn button on the occupancy sensor several times with it at the installed location. The load should toggle on the WSS20. If not, try rotating Occupancy sensor 90 degrees (point Leviton logo towards WSS20) and try again.

Lights Flickering: If lights are flickering in the OFF or ON state check to insure minimum load (25 Watts) requirement is met for the no-neutral device. The WSS20 no-neutral may not work with some CFL's or dimmable devices which use slow or program start electronics; increasing the load or adding instant start devices will help.

Marginal-Poor Signal Quality: Reposition the transmitter so the antenna is aligned with the receiving device. When re-position of the transmitter or receiver is not possible, then adding repeaters or enabling the repeaters in WSS20 and nearby devices may be required.

Improving Performance: Metal around or near the antenna will cause signal degradation. Keep these guidelines in mind to increase device operational performance:

- Avoid installing near metal or behind metal faceplates
- Avoid installing occupancy sensors on metal ceilings
- Leviton occupancy sensors should be rotated so that the Leviton logo points towards the receiver
- Relays packs installed in a metal single or dual gang electrical switch boxes need to have their antenna outside of the metal enclosure
- The distance between the receivers and other transmitting devices such as computers, RFID devices, audio and video equipment that also emit high-frequency signals should be at least 3 ft

Technical Notes:

- Noise interference can be either line noise (from motors) or Radio Frequency (RF)
- The WSS20 will go into a reduced range mode when in programming mode (learn devices within 10 feet)
- Range can be reduced by metal objects (metal decreases the effectiveness of RF transmission)
- A fixed whip antenna is integrated into the product

Consider Factors affecting the Environment:

- Device placement
- Obstructions (metal, concrete, other construction materials)
- Interference (nearby electronic devices)

Obstructions:

- Does the system work more reliably at close range (without obstructions)?
- Identify nearby metal, concrete and other objects possibly affecting signal strength
- Can either device be relocated (even slightly) away from obstructions to improve the system performance?

Interference:

- Does the system work better at certain times of the day?
- Look for pieces of equipment that may affect wireless performance when they are ON
- Try using a WSCOM tool to measure (RF) noise floor and quantify packet receiving reliability

Product variations:

- Replace one piece of hardware at a time to isolate any variation in product performance

Product LED indicators:

Red LED:

- Indicates reception of wireless package from a sensor in normal mode
- Blinks when the DIP switch positions are adjusted
- In Programming Mode it signals no devices learned
- In Debug mode it means LOW signal strength (-83dB or less) for wireless message received

Green LED:

- In Programming Mode this indicates number of devices learned
- In Programming Mode a 2 second blink represents a device is unlearned
- In Normal Mode the Green LED will remain lit when the load is OFF
- In Debug mode it means GOOD signal strength (-65dB and above) for wireless message received

Amber LED:

- In programming mode indicates Mode Selection Menu (1-6 blinks)
- Indicates a device was learned when in the Programming Learn Mode
- Five blinks on start-up or during relay transition signals a zero crossing failure
- In Debug mode it means MEDIUM signal strength (-66dB to -82dB) for wireless message received
- One amber blink upon pushing of top button (>5s) represents entry into the Debug mode

FCC COMPLIANCE STATEMENT:

Contains FCC ID: SZV-STM300U

The enclosed device complies with Part 15 of the FCC Rules.

Operation is subject to the following two conditions:

- This device may not cause harmful interference
- This device must accept any interference received, including interference that may cause undesired operation.

Any changes or modifications not expressly approved by Leviton could void the user's authority to operate this equipment.

This equipment has been tested and found to comply with the limits for a Class B digital device, pursuant to part 15 of the FCC Rules. These limits are designed to provide reasonable protection against harmful interference in a residential installation. This equipment generates uses and can radiate radio frequency energy and, if not installed and used in accordance with the instructions, may cause harmful interference to radio communications. However, there is no guarantee that interference will not occur in a particular installation. If this equipment does cause harmful interference to radio or television reception, which can be determined by turning the equipment off and on, the user is encouraged to try to correct the interference by one or more of the following measures:

- Reorient or relocate the receiving antenna.
- Increase the separation between the equipment and receiver.
- Connect the equipment into an outlet on a circuit different from that to which the receiver is connected.
- Consult the dealer or an experienced radio/TV technician for help.

INDUSTRY CANADA COMPLIANCE STATEMENT:

Contains IC: 5713A-STM300U

This device complies with Industry Canada license-exempt RSS standard(s). Operation is subject to the following two conditions: (1) this device may not cause interference, and (2) this device must accept any interference, including interference that may cause undesired operation of the device.

IMPORTANT! Any changes or modifications not expressly approved by the party responsible for compliance could void the user's authority to operate this equipment.

This Class B digital apparatus complies with Canadian ICES-003.

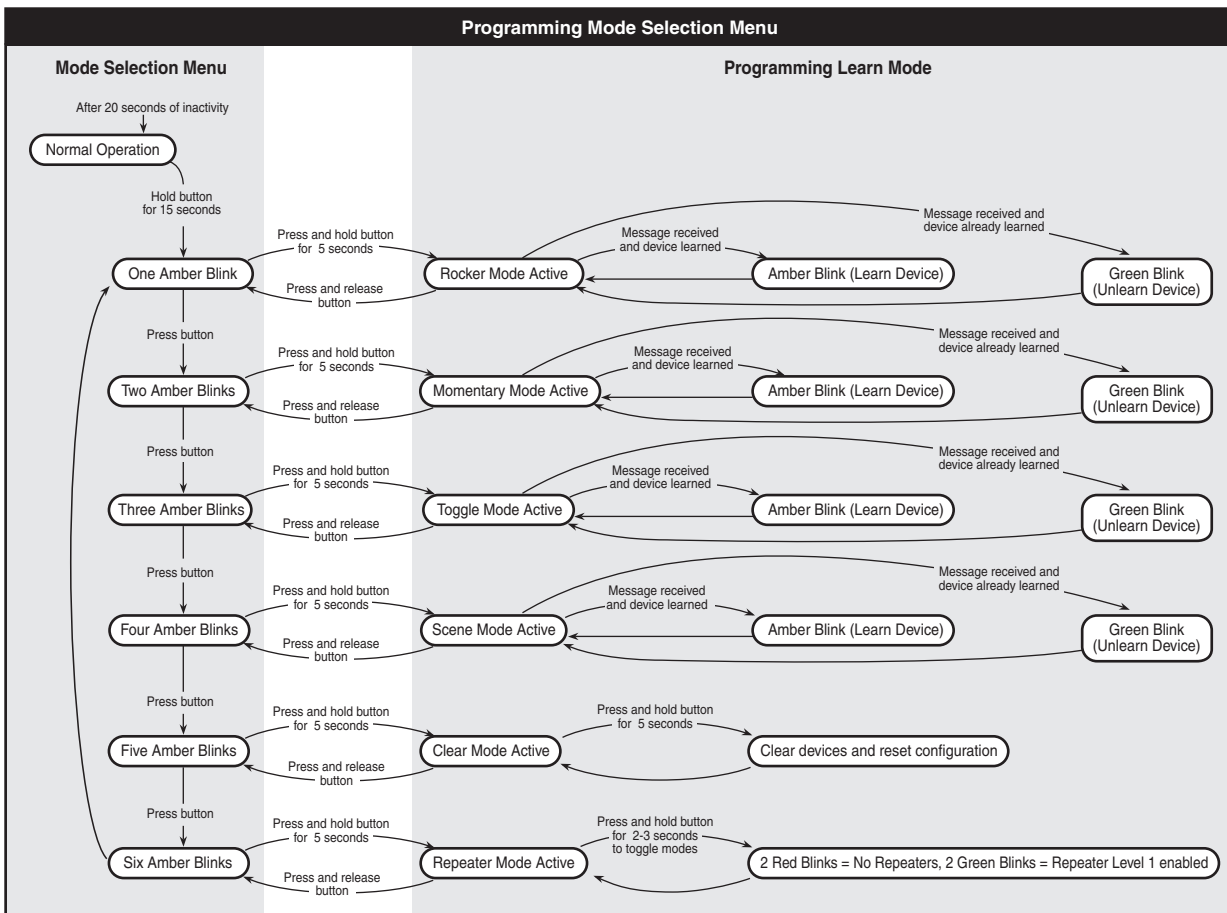

Leviton is a registered trademark of Leviton Mfg. Co. in the United States, Canada, Mexico, and other countries.
EnOcean is a registered trademark of EnOcean GmbH.
Windows is a registered trademark of Microsoft Corporation.
Other trademarks herein are the property of their respective owners.

FOR CANADA ONLY

For warranty information and/or product returns, residents of Canada should contact Leviton in writing at **Leviton Manufacturing of Canada Ltd to the attention of the Quality Assurance Department, 165 Hymus Blvd, Pointe-Claire (Quebec), Canada H9R 1E9** or by telephone at **1-800-405-5320**.

LIMITED 5 YEAR WARRANTY AND EXCLUSIONS

Leviton warrants to the original consumer purchaser and not for the benefit of anyone else that this product at the time of its sale by Leviton is free of defects in materials and workmanship under normal and proper use for five years from the purchase date. Leviton's only obligation is to correct such defects by repair or replacement, at its option. **For details visit www.leviton.com or call 1-800-824-3005.** This warranty excludes and there is disclaimed liability for labor for removal of this product or reinstallation. This warranty is void if this product is installed improperly or in an improper environment, overloaded, misused, opened, abused, or altered in any manner, or is not used under normal operating conditions or not in accordance with any labels or instructions. **There are no other or implied warranties of any kind, including merchantability and fitness for a particular purpose,** but if any implied warranty is required by the applicable jurisdiction, the duration of any such implied warranty, including merchantability and fitness for a particular purpose, is limited to five years. **Leviton is not liable for incidental, indirect, special, or consequential damages, including without limitation, damage to, or loss of use of, any equipment, lost sales or profits or delay or failure to perform this warranty obligation.** The remedies provided herein are the exclusive remedies under this warranty, whether based on contract, tort or otherwise.

SPECIFICATIONS	
Frequency / Range	902.875MHz / 100-150ft
Modulation Type	FSK (Frequency Shift Keying)
Operational Temperature	0° to +40°C
Power Consumption (< 1 Watt)	120VAC @6.2mA AC (330mW typical) 277VAC @4.5mA AC (460mW typical)
Addressing	Factory set unique ID (1 of 4 billion)
Antenna	902.875MHz 6.4cm whip antenna
ETL Certified to UL Standard	UL-508, CAN/CSA-C22.2 No. 14
Radio Certification	FCC Part 15 Subpart C IC RSS-Gen Issue 2, RSS-210 Issue 7, RSS-102 Issue 4 Contains FCC ID: SZV-STM300U Contains IC: 5713A-STM300U

For Technical Assistance Call: 1-800-824-3005 (U.S.A. Only)
www.leviton.com