



Business² Hand Dryer



High Speed

Surface Mounted High Speed Hand Dryer

Operating Instructions and Parts Manual



Technical Specifications

Item Category	Performance Data
Operating Voltage	110-120Vac, 60Hz, 700 watts (heater off) 1400 watts (heater on)
Warm Air Speed Output	246mph
Display	LED countdown
Motor Type	35,000 rpm, Brushless DC
Motor Thermal Protection	Auto Resetting Thermostat turns unit off at 271.4°F (133°C)
Heater Element	700 Watts
Heater Thermal Protection	Auto resetting
Filter	Antibacterial filter
Air Freshener/Sanitizer	Organic ocean breeze fragrance
Drying Time	10 - 15 seconds
Circuit Operation	Infrared Automatic, self adjusting
Timing Protection	30 seconds auto shut off
Decibel Rating	78dba @ 3 feet
Drip Proof	IP22
Isolation	CLASS I
Net Weight	18.4lbs
Shipping Weight	22lbs
Unit Size	11 3/4" W x 26 3/4" H x 9 3/4" D
Certificates	CE, WEEE, Greenspec, ETL
Item Code	Cover Type/Finish
JDBUSI2-WUS	ABS White
JDBUSI2-SUS	ABS Metallic Silver

Surface Mounted High Speed Hand Dryer

Operating Instructions and Parts Manual

General Safety Information

WARNING

This product is intended for installation by a qualified service person. Use AWAG No. 16 solid conductor for wiring.

Failure to properly ground unit could result in electrical shock and/or death.

Disconnect power at the service breaker before installing or servicing.

NOT FOR HOUSEHOLD USE - MAY CAUSE BURNS

All units must be supplied with a 3-wire service. The ground wire must be connected with the dryers back plate.

NOTE: Do not install dryer over wash basin.

Type Y attachment

If the power supply cord is damaged, it must be replaced by the manufacturer or its service agent or a similar qualified person in order to avoid a hazard.

Means for disconnection must be incorporated in the fixed wiring in accordance with the wiring rules.

Installation

Installation must be carried out only by a qualified electrician

1. Make sure power supply breaker is switched off. Installation must be carried out in accordance with the current edition of the local wiring regulations code having jurisdiction. Installation should be performed only by a qualified electrician.

2. Place template against wall at desired height (see mounting height recommendations) and mark locations of 4 mounting holes and wire service entry at knockout (KO) location.

NOTE: For two or more dryers, dryers should be no closer than 24 inches (610 mm) on centre.

3. Remove and retain 2 cover screws.

4. Connect supply wires to terminal block where indicated and connect ground wire to baseplate with ground screw.

Connections:

- a. Connect the live wire (black) to the terminal block marked "L".
- b. Connect the neutral wire (white) to the terminal block marked "N".

Note that the colour of live and neutral wires depends on voltage of supply service.

5. Replace cover screens. Do not over-tighten.

Surface Mounted High Speed Hand Dryer

Operating Instructions and Parts Manual

Recommended Mounting Heights

From floor to bottom of dryer.

Men's	Ladies	Children, ages 11-17	Children, ages 3-10	Disabled
13"	11"	10"	6"	4"
350 mm	300 mm	250 mm	150 mm	100 mm

Consumables

Anti Bacterial Filter

The Anti Bacterial Filter is fitted to ensure dust and airborne bacteria are restricted from entering the internal components and airflow of the dryer. The filter should be replaced every 3 - 6 months, depending on usage.



Gels

JetDryer Gels perform 3 jobs in one:

1. Moisturise the hands.
2. Sanitise the product internally, and the users hands.
3. Fragrances the surrounding washroom area whilst in use.



The Gels are manufactured from natural sources and are chemical free.

Product	Order Code
Antibacterial filter	JDBUSI2-AF
Moisturising Gel	JDBUSI2-GEL

Operation

- No touch operation.
- Shake excess water from hands.
- Place hands into the aperture.
- Move hands up and down.
- Green LEDs count down drying time.
- Stops automatically after hands are removed, or after 30 seconds.

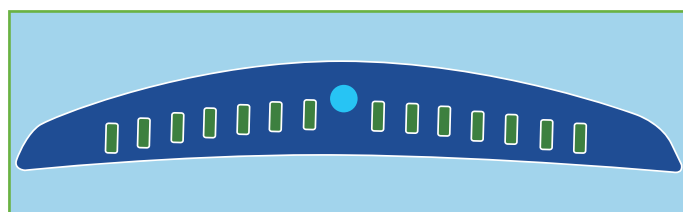

Surface Mounted High Speed Hand Dryer

Operating Instructions and Parts Manual

Cleaning and Maintenance Instructions

Periodic cleaning of the unit is recommended to ensure optimum performance.

- Switch to service mode located on the top left side of the dryer.
- Wipe the cover with a soft cloth and a mild cleaning solution. Do not Soak. Never use abrasives to clean the cover.

WARNING

- Never spray water directly onto hand dryer
- Never use any abrasives or harsh chemicals
- Turn off electricity prior to cleaning the hand dryer

5. Disassemble water tank and rinse clean using a disinfectant, then replace. Moisturising gels should be replaced every month.

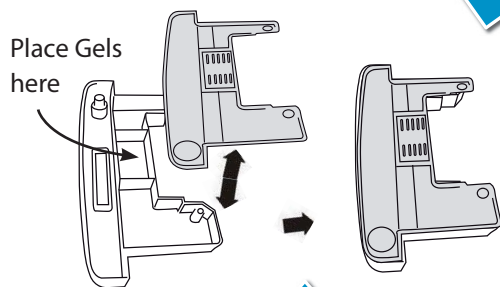

6. Wipe down the external surfaces of the hand dryer with a soft cloth. Switch power back on and test operation.

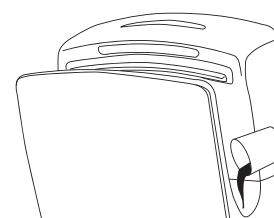

1. Pour a cup of water down drain hole. Use cleaning brush supplied to clean drain hole.

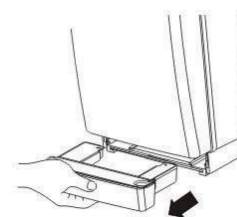

2. Remove water tank and empty.

4. Clean filter casing by wiping with soft damp cloth. Replace the antibacterial filter every 3 - 6 months. Slide filter back into place

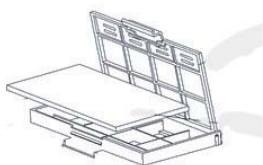

3. Remove filter.

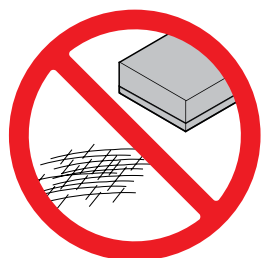

Surface Mounted High Speed Hand Dryer

Operating Instructions and Parts Manual

Diagram

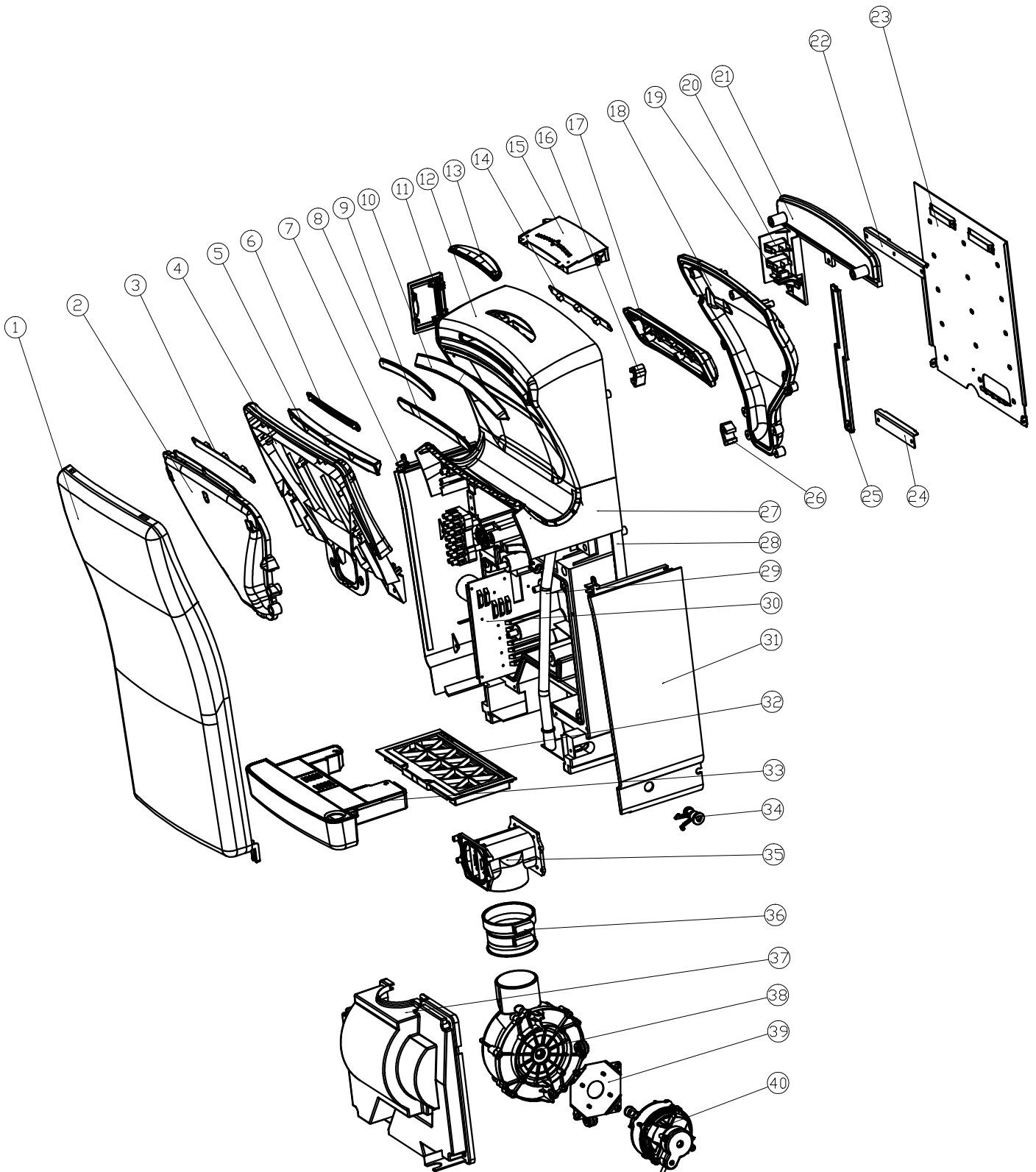

Surface Mounted High Speed Hand Dryer

Operating Instructions and Parts Manual

Parts List

Key	Description	Product Code
1	Cover	HD-BB7023159-01
2	Fan house cover	HD-BB7023159-02
3	LED light	HD-BB7023159-03
4	Fan house cover	HD-BB7023159-04
5	Air outlet	HD-BB7023159-05
6	Eradiating screen	HD-BB7023159-06
7	Left side board	HD-BB7023159-07
8	Incept screen	HD-BB7023159-08
9	Lighting screen	HD-BB7023159-09
10	Air outlet	HD-BB7023159-10
11	Door of power switch	HD-BB7023159-11
12	Fan house cover	HD-BB7023159-12
13	Display screen ornament	HD-BB7023159-13
14	Sensor light PCB	HD-BB7023159-14
15	Sensor PCB module	HD-BB7023159-15
16	Left fixer	HD-BB7023159-16
17	Lighting PCB module	HD-BB7023159-17
18	Fan house cover	HD-BB7023159-18
19	Switch button	HD-BB7023159-19
20	USB port	HD-BB7023159-20

Key	Description	Product Code
21	Bracket	HD-BB7023159-21
22	Big pothook	HD-BB7023159-22
23	Fixing board	HD-BB7023159-23
24	Small pothook	HD-BB7023159-24
25	PP seal board	HD-BB7023159-25
26	Right fixer	HD-BB7023159-26
27	Connector	HD-BB7023159-27
28	Base plate	HD-BB7023159-28
29	Hose	HD-BB7023159-29
30	Motor PCB	HD-BB7023159-30
31	Right side board	HD-BB7023159-31
32	Filter	HD-BB7023159-32
33	Water tank	HD-BB7023159-33
34	Lock	HD-BB7023159-34
35	Heater	HD-BB7023159-35
36	Passage	HD-BB7023159-36
37	Motor cover	HD-BB7023159-37
38	Fan house module	HD-BB7023159-38
39	Motor bracket	HD-BB7023159-39
40	Motor module	HD-BB7023159-40

Warranty

1 year warranty

 **JetDryer**