

PC1616/PC1832/PC1864 v4.6 NA

Installation Guide

PowerSeries[™]
SECURITY SYSTEM



WARNING: This manual contains information on limitations regarding product use and function and information on the limitations as to liability the manufacturer. The entire manual should be read carefully.

Table of Contents

Guidelines for Locating Smoke Detectors and CO Detectors	ii
Chapter 1 Installation & Wiring	1
Installation	1
1.1 Keybus Wiring	3
1.2 Zone Wiring	3
1.3 Zone Expanders	3
1.4 Bell Wiring	3
1.5 AUX Power Wiring	4
1.6 PGM Wiring	4
1.7 Carbon Monoxide Detector Wiring	4
1.8 Telephone Line Wiring	5
1.9 Ground	5
1.10 Battery	5
1.11 AC Wiring	5
1.12 RFK5500 and RFK5564 Easy Wireless Enrollment Procedure	5
Chapter 2 User Commands	6
2.1 Away Arming	6
2.2 Stay Arming	6
2.3 Disarming	6
2.4 [*] Commands	6
2.5 Function Keys	8
Chapter 3 Programming	9
3.1 Template Programming	9
3.2 DLS Programming	9
3.3 Advanced Keypad Programming	9
Chapter 4 Programming Descriptions	11
Chapter 5 Programming Worksheets	29
5.1 Index to Programming Worksheets	29
Appendix A: Reporting Codes	55
Appendix B: UL Listed Commercial and Residential Installations	57
Appendix C: SIA False Alarm Reduction	58
Appendix D: Troubleshooting Guide	59
Appendix E: Template Programming	63
Appendix F: Communicator Format Options	65
SAFETY INSTRUCTIONS FOR SERVICE PERSONNEL	67
FCC COMPLIANCE STATEMENT	69

Guidelines for Locating Smoke Detectors and CO Detectors

The following information is for general guidance only and it is recommended that local fire codes and regulations be consulted when locating and installing smoke and carbon monoxide alarms.

Smoke Detectors

Research indicates that all hostile fires in homes generate smoke to a greater or lesser extent. Detectable quantities of smoke precede detectable levels of heat in most cases. Smoke alarms should be installed outside of each sleeping area and on each level of the home.

DSC recommends that additional smoke alarms beyond those required for minimum protection be installed. Additional areas that should be protected include: the basement; bedrooms, especially where smokers sleep; dining rooms; furnace and utility rooms; and any hallways not protected by the required units.

On smooth ceilings, detectors may be spaced 9.1m (30 feet) apart as a guide. Other spacing may be required depending on ceiling height, air movement, the presence of joists, uninsulated ceilings, etc. Consult National Fire Alarm Code NFPA 72, CAN/ULC-S553-02 or other appropriate national standards for installation recommendations.

- Do not locate smoke detectors at the top of peaked or gabled ceilings; dead air space in these locations may prevent smoke detection.
- Avoid areas with turbulent air flow, such as near doors, fans or windows. Rapid air movement around the detector may prevent smoke from entering the unit.
- Do not locate detectors in areas of high humidity.
- Do not locate detectors in areas where the temperature rises above 38°C (100°F) or falls below 5°C (41°F).
- Smoke detectors should always be installed in USA in accordance with Chapter 11 of NFPA 72, the National Fire Alarm Code: 11.5.1.1. : Where required by applicable laws, codes, or standards for a specific type of occupancy, approved single- and multiple-station smoke alarms shall be installed as follows:

- (1) In all sleeping rooms and guest rooms.
- (2) Outside of each separate dwelling unit sleeping area, within 6.4 m (21 ft) of any door to a sleeping room, the distance measured along a path of travel.
- (3) On every level of a dwelling unit, including basements.
- (4) On every level of a residential board and care occupancy (small facility), including basements and excluding crawl spaces and unfinished attics.
- (5) In the living area(s) of a guest suite.
- (6) In the living area(s) of a residential board and care occupancy (small facility).

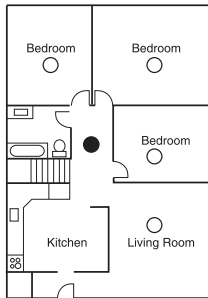

Figure 1

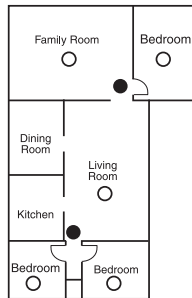

Figure 2

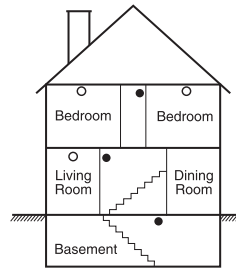

Figure 3

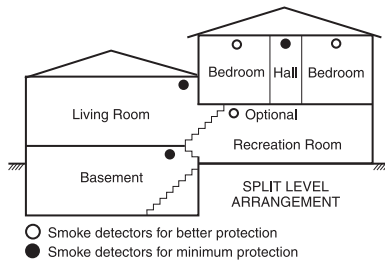

Figure 3a

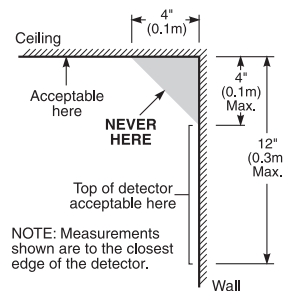

Figure 4

CO Detectors

Carbon monoxide gas moves freely in the air. The human body is most vulnerable to the effects of CO gas during sleeping hours. For maximum protection, a CO alarm should be located outside primary sleeping areas or on each level of your home. Figure 5 indicates the suggested locations in the home. The electronic sensor detects carbon monoxide, measures the concentration and sounds a loud alarm before a potentially harmful level is reached.

Do NOT place the CO alarm in the following areas:

- Where the temperature may drop below -10°C or exceed 40 °C.
- Near paint thinner fumes.
- Within 5 feet (1.5 meters) of open flame appliances such as furnaces, stoves and fireplaces.
- In exhaust streams from gas engines, vents, flues or chimneys.
- In close proximity to an automobile exhaust pipe; this will damage the detector.

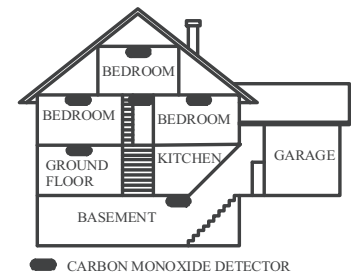

Figure 5

Chapter 1 Installation & Wiring

This Installation Guide provides the basic installation, wiring and programming information required to program the PowerSeries PC1616, PC1832, and PC1864 control panels.

i All necessary information required to meet UL Listing requirements is included in this document.

Technical Summary

	FEATURES	PC1616	PC1832	PC1864
OUT OF THE BOX Qty 1 <input type="checkbox"/> Cabinet Qty 1 <input type="checkbox"/> PC Module Qty 1 <input type="checkbox"/> Installation Guide Qty 1 <input type="checkbox"/> User Manual Qty 2 <input type="checkbox"/> Cabinet Label Qty 1 <input type="checkbox"/> Cabinet Door Plug Qty 5 <input type="checkbox"/> Standoffs Qty 16 <input type="checkbox"/> 5.6KΩ Resistors Qty 1 <input type="checkbox"/> 2.2KΩ Resistor Qty 1 <input type="checkbox"/> 1.0KΩ Resistor Qty 1 <input type="checkbox"/> Grounding Kit	On-board Zones	6	8	8
	Hardwired Zones	16 (1xPC5108)	32(3xPC5108)	64 (7xPC5108)
	Wireless Zones	32	32	64
	Keypad Zone Support	✓	✓	✓
	On-board PGM Outputs	PGM 1 - 50mA PGM 2 - 300mA	PGM 1 - 50mA PGM 2 - 300mA	PGM 1, 3, 4 - 50mA PGM 2 - 300mA
	PGM Expansion	8x50mA (PC5208) 4x500 mA (PC5204)	8x50mA (PC5208) 4x500 mA (PC5204)	8x50mA (PC5208) 4x500 mA (PC5204)
	Keypads	8	8	8
	Partitions	2	4	8
	User Codes	47 + Master Code	71 + Master Code	94 + Master Code
	Event Buffer	500 Events	500 Events	500 Events
Transformer Required	16.5VAC/40VA	16.5VAC/40VA	16.5VAC/40VA	
Battery Required	4Ah / 7Ah/14Ahr	4Ah / 7Ah/14Ahr	4Ah / 7Ah/14Ahr	
Bell Output	12V/700 mA (cont)	12V/700 mA (cont)	12V/700 mA (cont)	

SPECIFICATIONS

Temp Range . . . 0°C-49°C (32°F-120°F)
 Humidity (Max) 93%R.H.
 Power Supply . . 16.5VAC/40VA @60Hz
 Current Draw (Panel) 110mA (nom.)
 Aux+ Output 11.1-12.6VDC/700mA
 Bell Output. 11.1-12.6VDC/700mA

COMPATIBLE DEVICES

Keypads (Backward compatible with all PowerSeries keypads)

PK55XX Keypad..... 125mA (max.)
 RFK55XX Keypad..... 135mA (max.)
 LCD5511 Fixed Message LCD Keypad 85mA (max.)
 LED5511Z 8-zone LED Keypad 100mA (max.)

Cabinets

PC5003C..... 222x298x78mm (11.3x11.7x3.0in)
 PC500C (residential burg only) 213x235x78mm (8.4x9.25x3.0in)
 PC4050CAR (UL commercial burg).. 305x 376x124mm (12.0x14.8x4.9in)
 CMC-1 (UL commercial burg) 287x297x76mm (11.3x11.7x3.0in)
 Suttle, SAE 14 355.6 x 362x 95mm (14x14.25x 3.75in)
 Suttle, SAE 21 533.4 x 362x 95mm (21x14.25x 3.75in)
 Suttle, SAE 28 711.2 x 362x 95mm (28x14.25x 3.75in)
 Suttle, SAE 42 1066.8 x 362x 95mm (42x14.25x 3.75in)

Modules

TL-250/TL300 Communicator 275/350mA
 GS2060/GS2065 (GPRS/GSM only)..... 65mA
 GS2060-SM (GPRS only) 90mA
 TL260GS/TL265GS (Ethernet/GPRS) 100mA
 TL260-SM (Ethernet only) 100mA
 TL260GS-SM (Ethernet/GPRS only)..... 120mA
 PC5100 2-wire Interface..... 40mA plus devices to 170mA max.
 RF5132-433 Wireless Receiver 125mA
 RF5108-433 Wireless Receiver 125mA
 PC5108 Zone Expander 30mA
 PC5200 Power Supply 20mA
 PC5204 Power Supply with 4 Programmable Outputs..... 30mA
 PC5208 Low Current Programmable Output Module 50mA
 Escort5580 Telephone Interface Module 130m

**The T-Link TL-150 is not UL/ULC listed*

Classified in Accordance with ANSI/SIA CP-01-2000 (SIA-FAR)

INSTALLATION

Begin the installation by mounting additional modules in the cabinet using the stand-offs provided, then mount the cabinet in a dry, protected area with access to unswitched AC power. Install hardware in the sequence indicated in the following pages. Do NOT apply power until installation is complete.

i All wiring entry points are designated by arrows. All circuits are classified UL power limited except for the battery leads. Minimum 1/4" (6.4mm) separation must be maintained at all points between power limited and non-power limited wiring and connections.

PC1616/1832/1864 Wiring Diagram

North America Only

1. Insert Stand off into cabinet mounting hole in the desired location. Snap-in-place.
2. Position circuit board mounting holes over standoffs. Press firmly on board to snap-in-place.

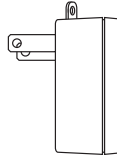
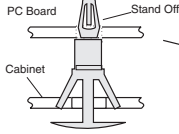

Primary: 120VAC/60Hz.
 Secondary: 16.5VAC 40VA
 DSCPTD 1640U
 Class II Transformer

NOTE: Do not connect transformer to receptacle controlled by a switch

230 VAC/50 Hz International

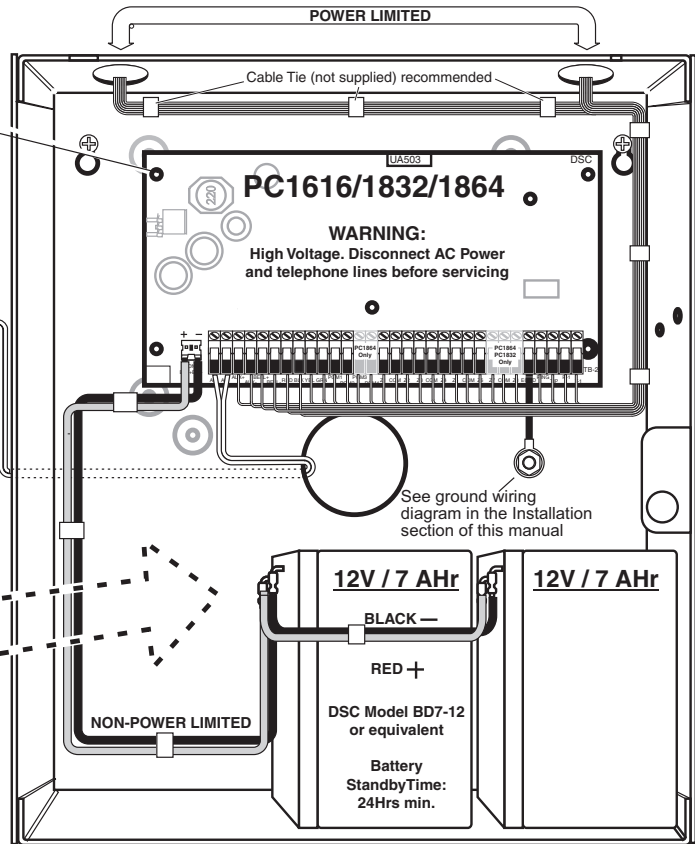
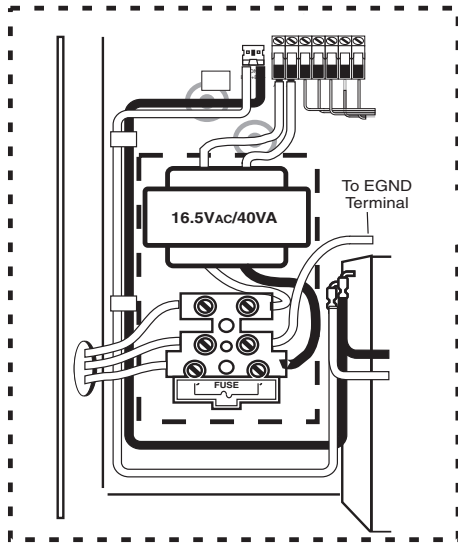

WARNING: Incorrect connections may result in PTC failure or improper operation. Inspect wiring and ensure connections are correct before applying power.

Incorrect connection of batteries may result in battery rupture or Fire Hazard. Do NOT allow metal objects to connect the Positive and Negative Terminals. Ensure that batteries are connected with correct polarity [Red to (+), Black to (-)]. Failure to comply with this may result in battery rupture and/or Fire Hazard. All circuits are classified for UL Installations as Power Limited/Class II Power Limited except for battery leads which are not power limited.

Do NOT route any wiring over circuit boards. Maintain at least 1"(25.4mm) separation. A minimum of 1/4" (6.4mm) separation must be maintained at all points between power limited wiring and all other non-power limited wiring.

IMPORTANT:

- This equipment, Alarm Controller PC1616/1832/1864 shall be installed and used within an environment that provides the pollution degree max 2 and overvoltages category II NON-HAZARDOUS LOCATIONS, indoor only. The equipment is FIXED and PERMANENTLY connected and is designed to be installed by service persons only; [service person is defined as a person having the appropriate technical training and experience necessary to be aware of hazards to which that person may be exposed in performing a task and of measures to minimize the risks to that person or other persons.]
- The connection to the mains supply must be made as per the local authorities rules and regulations. An appropriate disconnect device must be provided as part of the building installation. Where it is not possible to rely on identification of the neutral in the AC Mains supply the disconnecting device must disconnect both poles simultaneously (line and neutral). The device shall disconnect the supply during servicing.
- The equipment enclosure must be secured to the building structure before operation.
- Internal wiring must be routed in a manner that prevents:
 - Excessive strain on wire and on terminal connections;
 - Loosening of terminal; connections;
 - Damage of conductor insulation
- Disposal of the used batteries shall be made according to the waste recovery and recycling regulations applicable to the intended market.

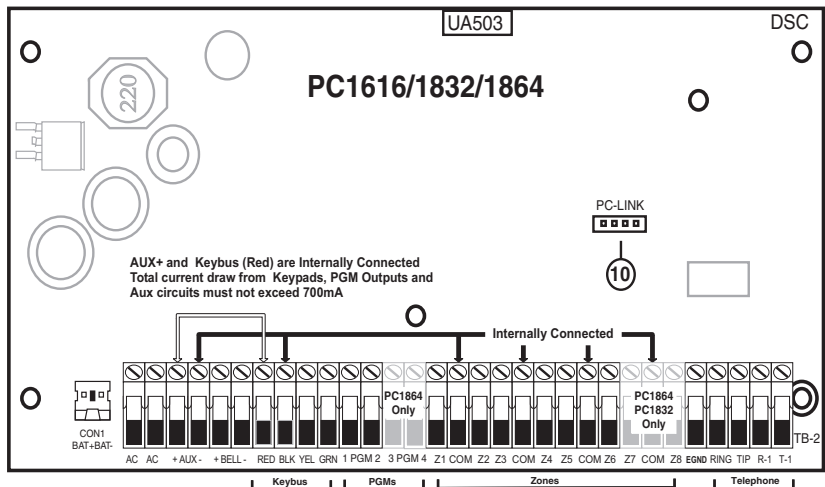

WARNING:
 High Voltage. Disconnect AC Power and telephone lines before servicing

DG009606

1.1 Keybus Wiring

The 4-wire KEYBUS (red, black, yellow and green) is the communication connection between the control panel and all modules. The 4 KEYBUS terminals of all modules must be connected to the 4 KEYBUS terminals of the main control panel.

The following rules must be followed when wiring the Keybus:

- Minimum 22 AWG wire, max. 18 AWG (2-wire twisted preferred)
- Do not use shielded wire
- Modules can be home run, connected in series or T-tapped, provided that the maximum wire distance from the control panel to any module does not exceed 1,000 feet (305m)
- No more than 3,000 feet (915m) of wire can be used in total

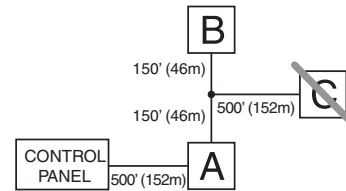

1.2 Zone Wiring

Zones can be wired for Normally Open or Normally Closed contacts, with Single-End-of-Line (SEOL) or Double End-of-Line (DEOL) resistors. Observe the following guidelines:

- For UL Listed Installations use SEOL or DEOL only.
- Minimum 22 AWG wire, maximum 18 AWG
- Do **not** use shielded wire
- Wire run resistance shall not exceed 100Ω. Refer to the chart below:

Burglary Zone Wiring Chart	
Wire Gauge	Maximum Wire Length to End-of-Line Resistor (ft/meters)
22	3000 / 914
20	4900 / 1493
19	6200 / 1889
18	7800 / 2377

Figures are based on maximum wiring resistance of 100Ω

- [001]-[004] Selects Zone Definition
- [013] Opt [1] Selects Normally Closed or EOL resistors
- [013] Opt [2] Selects SEOL or DEOL resistors
- [101]-[108] Opt [14], [15], [16] Selects Normally Closed SEOL or DEOL for on-board zones (PC1832/1864, Zone 1-8; PC1616, Zones 1-6)

Zone Status - Loop Resistance/Loop Status

- **Fault** - 0Ω (shorted wire/loop)
- **Secure** - 5600Ω (contact closed)

1.3 Zone Expanders

Zone expanders add zones in groups of eight to the Alarm system. Module jumpers J1, J2, J3 are required to assign zones to these modules. Jumper settings for PC5108 v2 are shown here.

- PC5108 v1.0 supports first 32 zones only.
- PC5700 enrolls as two modules
- Do NOT use PC5108 v1 and PC5108 v2 on the same panel.

Module Jumpers	Zones Assigned			Zones Disabled
	J1	J2	J3	
ON ON ON	ON	ON	ON	Zones 09-16
OFF ON ON	ON	ON	ON	Zones 17-24
ON OFF ON	OFF	ON	ON	Zones 25-32
OFF OFF ON	ON	ON	OFF	Zones 33-40
ON ON OFF	OFF	ON	OFF	Zones 41-48
OFF ON OFF	ON	OFF	OFF	Zones 49-56
ON OFF OFF	OFF	OFF	OFF	Zones 57-64

Normally Closed Loops - Do NOT use for UL Installations

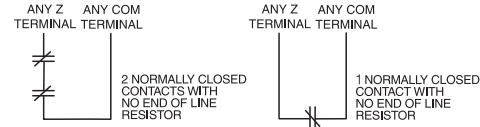

Single End-of-Line Resistor Wiring

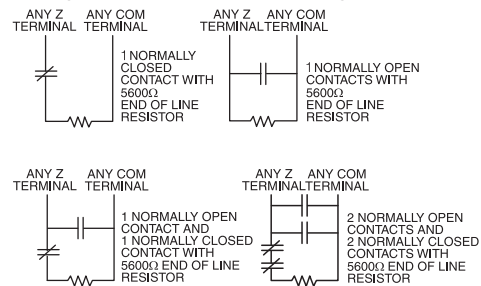

Double End-of-Line Resistor Wiring

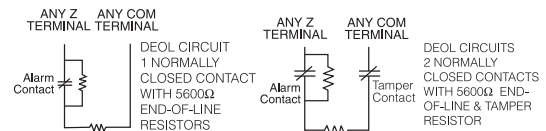

- **Tamper** - infinite (broken wire, open)
- **Violated** - 11,200Ω (contact open)

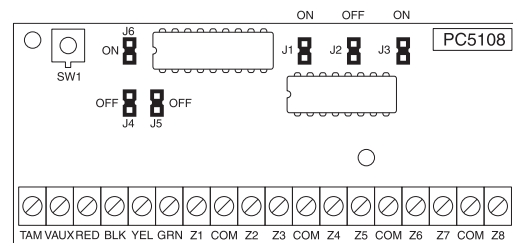

Refer to the associated installation sheet for Jumper locations for the PC5108 v1 and PC5700.

1.4 Bell Wiring

These terminals supply 700mA of current at 12VDC for commercial installations and 11.1-12.6VDC for residential installations (e.g. DSC SD-15 WULF). To comply with NFPA 72 Temporal Three Pattern requirements: **Program [013] Opt [8] ON**. Note that Steady, Pulsed alarms are also supported.

The Bell output is supervised and power limited by 2A PTC. If unused, connect a 1000Ω resistor across Bell+ and Bell- to prevent the panel from displaying a trouble. See [*][2].



1.5 AUX Power Wiring

The control panel can provide a maximum of 700mA of current for modules, powered detectors, relays, LEDs, etc. If the total current required exceeds 700mA an additional power supply is required (e.g., PC5200, PC5204). See list below.

Min/max operating voltages for devices, sensors and modules is 9.5VDC - 14VDC.

1.6 PGM Wiring

PGMs switch to ground when activated from the control panel. Connect the positive side of the device to be activated to the AUX+ Terminal. Connect the negative terminal to the PGM.

Current output is as follows:

- PGM 1, 3, 4 50mA
- PGM 2 300mA

For current levels greater than 300mA, a relay is required. PGM2 can also be used for 2-wire smoke detectors.

NOTE: Use SEOL resistors on fire zones only.

LED output with current limiting resistor and optional relay driver output

2-Wire Smoke Detectors Initiating Circuit

- Style B (Class B), Supervised, Power Limited
- UL Compatibility Identifier PC18-1
- DC Output Voltage 9.8-13.8 VDC
- Detector Load2mA (MAX)
- Single End-of-Line (SEOL) Resistor 2200Ω
- Loop Resistance 24Ω (MAX)
- Standby Impedance 1020Ω (NOM)
- Alarm Impedance 570Ω (MAX)
- Alarm Current89mA (MAX)

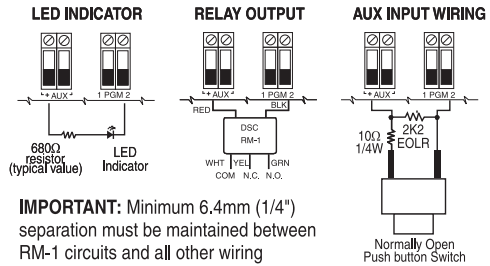

IMPORTANT: Minimum 6.4mm (1/4") separation must be maintained between RM-1 circuits and all other wiring

UL Compatibility ID For FSA-210B Series is: FS200

NOTE: For ULC Listed installations use FSA-210A and FSA-410A series.

4-Wire Smoke Detectors

- Compatible 2-wire Smoke Detector DSC FSA-210B Series
- FSA-210B
 - FSA-210BT
 - FSA-210BS
 - FSA-210BST
 - FSA-210BLST
 - FSA-210BR
 - FSA-210BRT
 - FSA-210BRS
 - FSA-210BRST
 - FSA-210BLRST

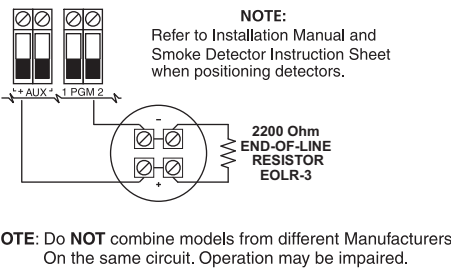

NOTE: Refer to Installation Manual and Smoke Detector Instruction Sheet when positioning detectors.

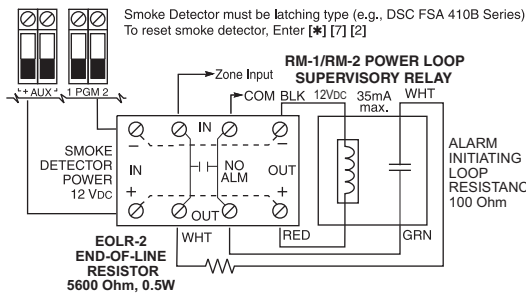

- Compatible 4-wire Smoke Detector DSC FSA-410B Series
- FSA-410B
 - FSA-410BT
 - FSA-410BS
 - FSA-410BST
 - FSA-410BLST
 - FSA-410BR
 - FSA-410BRT
 - FSA-410BRS
 - FSA-410BRST
 - FSA-410BLRST

1.7 Carbon Monoxide Detector Wiring

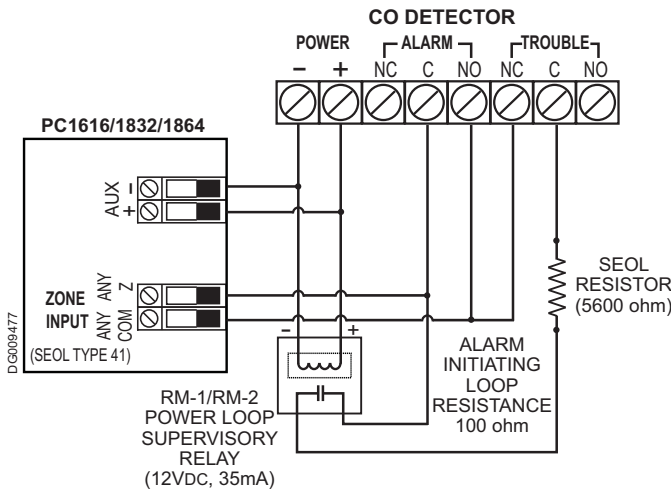

The following hardwired CO Detector models can be used with PC1616/PC1832/PC1864 v4.5 (and higher) control panels:

- Potter Model CO-12/24, UL File E321434
- Quantum Model 12-24SIR, UL File E186246
- NAPCO Model FW-CO12 or FW-CO1224, UL File E306780
- System Sensor Model CO1224, UL File E307195

NOTE: For multiple unit connections, the leads between CO detectors need to be broken. The power supervision relay has to be powered from the last detector in the loop.

Wireless CO detectors are also available. When installing wireless CO detectors, use only DSC model WS4913. A DSC wireless receiver model RF5132-433 v5.1 (and higher) or DSC keypad receiver models RFK55XX-433 (xx= 00/01/08/16/64) v1.2 (and higher) are required when installing wireless CO detectors. For more details on either the WS4913 CO detector or the receivers, please refer to their respective installation manuals.

1.8 Telephone Line Wiring

Wire the telephone connection terminals (TIP, Ring, T-1, R-1) to an RJ-31X Connector as indicated. For connection of multiple devices to the telephone line, wire in the sequence indicated. Use 26 AWG wire minimum for wiring. Telephone format is programmed in option [350].

Telephone Call Directions are programmed in options [351]-[376].

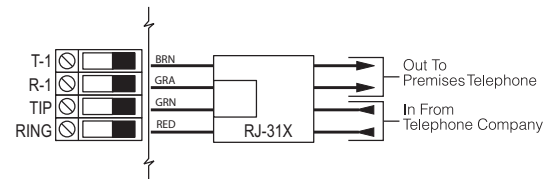

1.9 Ground

Ground Installation

Tighten nut to break paint and make good connection to the cabinet

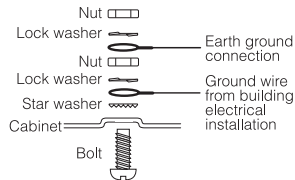

1.10 Battery

Standby Battery Guide

Battery Charging Current: 400 mA

Battery Size	Standby	
	4Hr	24Hr
4Ahr	700mA	---
7Ahr	700mA	180mA
14Ahr	700mA	470mA

NOTE: Battery capacity will deteriorate with age and the number of charge/discharge cycles. Replace every 3-5 years.

A sealed, rechargeable, lead acid battery or gel type battery is required to meet UL requirements for power standby times.

NOTE: UL Residential/Commercial Burglary installations require 4Hrs of standby battery time.

NOTE: UL/ULC Residential Fire & Health Care installations require 24 Hrs of standby battery time. ULC Commercial Burglary and Fire monitoring installations require 24Hrs of standby battery time plus 5 minutes of alarm condition.

1.11 AC Wiring

AC Wiring (UL Listed Installations)

Primary: 120VAC/60Hz./0.33A

Secondary: 16.5VAC/40VA DSC PTD1640U, DSC PTC1640U, DSC PTD1640U-CC Plug-in, Class 2 Transformer.

NOTE: Use DSC PTD1640 for Canadian installations.



For UL Listed installations, do NOT connect transformer to a receptacle controlled by a switch.

1.12 RFK5500 and RFK5564 Easy Wireless Enrollment Procedure

- Enter [*][8][Installer Code][898]. The LCD displays the following: "Wireless Enrollment Mode."
- Place the wireless device in the desired location.
- Activate the device as described in the associated installation sheet. The electronic serial number (ESN) is displayed.
- Press [*] to confirm the ESN. If the serial number is incorrect, press [#] to discard it, and repeat this step. After successful confirmation of the serial number, the system prompts for the zone number. The next available zone is displayed.
- Enter a zone number (01-64) then press [*] to accept. The next available zone is preloaded.
NOTE: Only one device may be enrolled in each zone. If a zone already has a device enrolled, press [*] to overwrite the zone or [#] to enter another zone number.
- After successful entry of the zone number, the system prompts for the zone type. (The recommended zone type is displayed). Press [*] to accept the zone type or enter:

Device Type	Zone Definition
2 Door/Window Contact	[01] Delay 1
3 PIR or Glassbreak	[05] Interior, Stay-Away
4 Smoke Detector	[88] Standard 24 Hr Fire (Wireless)
5 Pendant	[16] 24 Hour Panic
8 CO Detector	[81] 24 Hour CO Detection

Chapter 2 User Commands

Any system keypad can be used to program or perform any keypad command. LED keypads use status and zone indicator lights to represent alarm functions and status. The LCD keypad displays the description and status indicator lights represent alarm functions and status. This section describes basic keypad commands.

i Press the [#] key to reset the keypad if an error has been made entering user codes or keypad commands.

2.1 Away Arming

The Ready light must be ON to arm the system. If the Ready light is OFF, ensure that all protected doors and windows are secure or bypassed. To arm the system in the Away mode, either press and hold the Away function button for 2 seconds or enter a valid user code and leave the premises through a door programmed as Delay. Upon arming, the Armed light will turn ON. If a user code was used to arm the system and Stay/Away zones are programmed, the Bypass light will turn ON and will turn OFF when a door programmed as Delay is violated. If the Audible Exit Delay option is enabled, the keypad will beep once every second during the exit delay (and three times a second during the last 10 seconds) to prompt the user to leave.

2.2 Stay Arming

The Ready light must be ON to arm the system. If the Ready light is OFF, ensure that all protected doors and windows are secure or bypassed. To arm the system in the Stay mode, either press and hold the Stay function button for 2 seconds or enter a valid user code and stay within the premises (do NOT violate a door programmed as Delay). Upon arming, the Armed light and Bypass light will turn ON. If the Stay function button is used, the keypad will not beep during the exit delay. If a user code was used, the keypad will beep if the Audible Exit Delay option is enabled.

2.3 Disarming

The user must enter through a door programmed as Delay. Upon entering, the keypad will emit a steady tone (and emit a pulsing tone during the last 10 seconds of entry delay) to prompt the user to disarm the system. Enter a valid user code to disarm the system. If an alarm occurred while the panel was armed, the Memory light and the zones that went into alarm will be flashing (LED keypad) or the keypad will display ‘Alarm in Memory’ (LCD keypad). Press the [#] key to return the keypad to the Ready state.

2.4 [*] Commands

The following is a list of the [*] commands available and a description of each:

[*][1]	Bypass (disarmed state)/Reactivate Stay/Away Zones (armed state)
[*][2]	Display Trouble Conditions
[*][3]	Display Alarm Memory
[*][4]	Door Chime Enable/Disable
[*][5]	User Code Programming
[*][6]	User Commands
[*][7][x]	Command Functions 1 – 4
[*][8]	Installer Programming
[*][9][code]	No-Entry Arming
[*][0]	Quick Arm (disarmed state)/Quick Exit (armed state)

[*][1] Bypass/Re-activate Stay/Away Zones

LED Keypad

Press [*][1] to enter the bypass mode. If the Code Required for the Bypass option is enabled, enter a valid user code. The Bypass light will flash. The keypad will turn ON the corresponding zone light to indicate a zone is bypassed. To bypass or unbypass a zone, enter the 2-digit zone number. Once the correct zones are bypassed, press [#] to exit. The Bypass light will be ON if any zones are manually bypassed.

LCD Keypad

Press [*][1] to enter the bypass mode. If the Code Required for the Bypass option is enabled, enter a valid user code. The keypad will display ‘Scroll to View Zones’. The keypad will display the programmed zone labels for the zones and include the letter ‘O’ in the bottom right corner if the zone is violated, or the letter ‘B’ if the zone is bypassed. Scroll to the appropriate zone and press the [*] key to change the bypass status (or enter the 2-digit zone number). Once the correct zones are bypassed, press [#] to exit.

Additional Bypass Commands:

Bypass Recall:	Press [99]. The keypad will recall the last group of zones that were bypassed
Clear Bypass:	Press [00]. The keypad will clear the bypass on all zones.
Save Bypass:	Press [95]. The keypad will save which zones are manually bypassed.
Recall Save:	Press [91]. The keypad will recall the bypassed zones that were saved.

i Hold-up Zones cannot be assigned to bypass groups.

Re-activate Stay/Away Zones: Press [*][1] when the system is armed in the Stay mode to change the armed status to Away mode. The system will add the Stay/Away zones back into the system after the exit delay time expires.

[*][2] Trouble Display

Refer to Appendix D – Troubleshooting Guide, for troubleshooting assistance and a detailed description of all trouble conditions.

i *When powering up the system for the first time, or in the event of a loss of power (including battery removal), a Loss of Clock trouble will appear on the display. Press [8] on any keypad or [*] on any PK series keypad to access the time and date programming menu.*

[*][3] Alarm Memory Display

The Memory light will be ON if an alarm occurred during the last armed period. Press [*][3]. The Memory light will flash and the keypad will display the zones that went into alarm.

i *To clear the Memory light, arm then disarm the system.*

[*][4] Door Chime Enable/Disable

Press [*][4]. The keypad will emit 3 rapid beeps if the door chime feature is now enabled and a steady 2-second tone if it is now disabled. The same function can be performed by pressing and holding the Chime function button for 2 seconds.

[*][5] Program User Codes

The following table identifies available user codes:

Code	Type	Function
[01]-[39], [41]-[95]	General User Codes	Arm, disarm
[40]	Master Code	All functions

Programming User Codes:**LED Keypad:**

Press [*][5] followed by the Master Code. The Program light will flash. The keypad will turn ON the corresponding zone lights to indicate if any user codes are programmed. To add or change a user code, enter the 2-digit user code to be programmed. The zone light will flash. Enter a new 4 or 6-digit user code or press [*] to delete the user code. After the user code is programmed or deleted, the zone light corresponding to the user code will stop flashing. To add or change another user code, enter the 2-digit user code to be programmed or press [#] to exit.

LCD Keypad:

Press [*][5] followed by the Master Code. The keypad will display the first user (user 01) and include the letter 'P' in the bottom, right corner if the user code is programmed. Scroll to the appropriate user and press the [*] key to program the user (or enter the 2-digit user number). Enter a new 4 or 6-digit user code or press [*] to delete the user code. After the user code is programmed or deleted, scroll to another user or press [#] to exit.

Programming Partition Assignment:

Press [*][5] followed by the Master Code or Supervisor Code. Press [98] followed by the 2-digit user to change to the partition assignment. The keypad will turn ON the corresponding zone light to indicate which partition(s) the user is assigned to. For example, if zone light 1 is ON, the user is assigned to partition 1. To change the partition assignment, press the number corresponding to the partition. Once the correct partitions are assigned to the user, press [#] to exit. To change the partition assignment for another user, press [98] followed by the 2-digit user number. When finished, press [#] to exit.

Programming User Attributes:

Press [*][5] followed by the Master Code or Supervisor Code. Press [99] followed by the 2-digit user to change to the user attributes. The keypad will turn ON the corresponding zone light to indicate which attributes are assigned to the user.

Light [1]	User can enter User Code Programming section with this code
Light [2]	Duress Reporting Code is sent whenever this code is entered
Light [3]	User can manually bypass zones
Light [4]	User can access the Escort5580 module remotely
Light [5]	For Future Use
Light [6]	For Future Use
Light [7]	The panel will squawk when the user arms/disarms
Light [8]	One-time use code – Can disarm the system once per day and is reset at midnight.

To change the user attributes, press the number corresponding to the attribute. Once the correct attributes are assigned to the user, press [#] to exit. To change the user attributes for another user, press [99] followed by the 2-digit user number. When finished, press [#] to exit.

[*][6] User Functions

Press [*][6] followed by the Master Code, then press the number corresponding to the following functions:

- [1] **Program Time and Date:** Enter the time and date using the following format [HH:MM] [MM/DD/YY]. Program the time using the twenty-four-hour system (e.g., 8:00 PM = 2000 hours).
- [2] **Auto-arm/Auto-disarm Enable/Disable:** The keypad will emit 3 rapid beeps if the Auto-arm/Auto-disarm feature is now enabled and a steady 2-second tone if it is now disabled.
- [3] **Auto-arm Time/Day:** Press the number corresponding to the day of the week (1=Sunday, 2=Monday etc.) followed by the auto-arm time (HH:MM). Program the time using the twenty-four-hour system (e.g., 8:00 PM = 2000 hours).
- [4] **System Test:** The panel will perform the following: activate the bell output, keypad buzzer and all keypad status lights for 2 seconds, test the backup battery and transmit a reporting code to the central station (if programmed).
- [5] **Enable DLS:** The panel will temporarily enable DLS for 1 or 6 hours depending on programming (see Sect [702] opt.[7]).
- [6] **User Initiated DLS:** The panel will attempt to call the DLS computer.
- [7] -[8] For Future Use

 *If using LCD keypads, scroll to the desired option then press [*].*

Additional Alphanumeric Keypad Functions:

When scrolling through the list of available functions, the following additional functions are available:

Event Buffer:	Used to view the 500-event panel log
Brightness Control:	Used to adjust the display backlighting level for optimal viewing
Contrast Control:	Used to adjust the display contrast level for optimal viewing
Buzzer Control:	Used to adjust the keypad buzzer tone for optimal sound

[*][7][x] Command Output (1-4)

Press [*][7][x]. If the Command Output Code Required option is enabled, enter a valid user code. The panel will activate any PGM output assigned to the command output.

[*][8] Installer Programming

Press [*][8] followed by the Installer Code to enter Installer Programming. Refer to the 'How to Program' section for more information.

[*][9][User Code] No-Entry Arming

Press [*][9] followed by a valid user code. The system will arm in the Stay mode, and after the exit delay expires, it will remove entry delay. All zones programmed as Delay will function like Instant zones. The system will flash the Armed light to indicate that the system is armed with no entry delay.

[*][0] Quick Arm/Quick Exit

Quick Arm: When disarmed, press [*][0] to arm the system. The system will arm as if a valid user code was entered.

Quick Exit: When armed, press [*][0] to activate Quick Exit. The system will allow a single zone programmed as Delay to be violated a single time during the following 2-minute time period without changing the status of the system.

2.5 Function Keys

Keypads have 5 programmable one-touch function buttons located in a column down the right side of the keypad. These buttons can also be activated by pressing and holding numbers [1] through [5] respectively for 2 seconds. The default for these function buttons on the PK series keypads are as follows:

- [1] Stay Arm
- [2] Away Arm
- [3] Chime Enable/Disable
- [4] Fire Reset – Command Output 2
- [5] Quick Exit

Chapter 3 Programming

This chapter provides the information necessary to program all the features required for a basic system, as well as common applications.

3.1 Template Programming

Selecting [*][8][Installer Code][899] displays the current 5-digit template programming code. Refer to Appendix E - Template Programming for a detailed description of available templates and corresponding 5-digit codes. After entering a valid 5-digit template programming code, you will be prompted to enter the following in the sequence indicated below:

 *This feature requires a PK55xx or RFK55xx series keypad, v.1.1 or higher.*

1. Central Station Telephone Number, enter 32-Character Telephone number

Program the required Central Station phone number. Press [#] to complete your entry if less than 32 digits. This phone number will be entered into the programming option [301].

2. Central Station Account Code, enter 6-digit code

Program the required Central Station Account Code. Press [#] to complete your entry if less than 6 digits. This account code will be entered into the programming option [310].

3. Partition Account Code, enter 4-digit code

This programming section will only be prompted if Contact ID has been selected as a communications format. Program the required Partition Account Code. This Partition account code will be entered into the programming option [311].

4. DLS Access Code, enter 6-digit code

Program the required DLS Access Code. Press [#] to complete your entry if less than 6 digits. This access code will be entered into the programming option [403].

5. Partition 1 Entry Delay 1, Partition 1 Exit Delay, enter each 3-digit delay time

Program the desired 3-digit Partition 1 Entry Delay (in seconds) followed by the desired 3-digit Partition 1 Exit Delay (in seconds). These values will be entered in [005] > [01], entries 1 and 3, respectively.

6. Installer Code

Enter the required 4- or 6-digit access code installer access code (dependent on [701], entry 5). This Installer Access Code will be entered in [006]. After the installer code has been programmed the keypad will return to the base installer programming menu.

 *All template programming information must be re-entered after performing a hardware or software panel default.*

3.2 DLS Programming

3.2.1 Local Programming:

Follow the steps below in the sequence indicated to set up local programming using DLS:

1. Initiate downloading using the DLS software.
2. Connect an RS-232 to PC-Link Cable between the Computer with DLS Software installed and the alarm panel to be programmed.

 *Connecting the DLS PC to the panel will automatically initiate the connection.*

3.2.2 Remote Programming (via telephone line):

Refer to Section [401] on page 22 for details.

 *The panel battery voltage can be monitored with DLS software. After the panel information has uploaded, battery voltage can be viewed in the DLS session window.*

3.3 Advanced Keypad Programming

DSC recommends filling in the Programming Worksheet with the required information before programming the system. This will reduce the time required to program and will help eliminate errors.

To enter Installer Programming press [*][8][Installer Code]. The Program light will flash (programmable LCD keypad displays will change to 'Enter Section'). An error tone indicates the installer code entered is incorrect. Press [#] to clear any key presses and try again.

 *The default Installer Code is [5555].*

The Armed and Ready lights indicate programming status:

Armed Light On	Panel waiting for 3-digit section number
	If in module programming, waiting for section # to be entered
Ready Light On	Panel waiting for data to be entered
Ready Light Flashing	Panel waiting for HEX data to be entered

 *You cannot enter Installer Programming while the system or any partition is armed or in alarm.*

3.3.1 Programming Toggle Options:

Enter the 3-digit programming section number:

- The Armed light will turn **OFF** and
- The Ready light will turn **ON**.
- The keypad will display which toggle options are **ON** or **OFF** according to the chart.
- To toggle an option **ON** or **OFF**, press the corresponding number on the keypad. The display will change accordingly.
- When all the toggle options are configured correctly, press the [#] key to exit the program section.
- The Ready light will turn **OFF** and the Armed light will turn **ON**.

Keypad Type	Option ON	Option OFF
LED	Zone Light ON	Zone Light OFF
Fixed-Message LCD	Indicator # ON	Indicator # OFF
Programmable-Message LCD	# Displayed	Dash [-] Displayed

3.3.2 Programming Decimal and Hexadecimal (HEX) Data:

- Enter the 3-digit programming section number.
- The Armed light will turn **OFF** and the Ready light will turn **ON**.
- Enter the data written in the boxes.

For sections that require multiple 2- or 3-digit numbers, the keypad will beep twice after each 2- or 3-digit entry and move to the next item in the list. After the last digit in the section is entered, the keypad will beep rapidly 5 times and exit the program section. The Ready light will turn **OFF** and the Armed light will turn **ON**.

For sections that do not require data for every box (such as phone numbers), press the [#] key to exit the program section after entering all the required data. The Ready light will turn **OFF** and the Armed light will turn **ON**.

At any time the [#] key can be pressed to exit any program section. All changes made up to that point will be saved.

HEX (or hexadecimal) digits are sometimes required. To enter a HEX digit, press the [*] key to begin HEX programming. The Ready light will flash.

Refer to the following chart and press the number corresponding to the HEX digit required. The Ready light will continue to flash. Press [*] again to return to normal decimal programming. The Ready light will turn **ON**.

Value	Enter	Telephone Dialer
HEX [A]	Press [*][1][*]	Not Supported
HEX [B]	Press [*][2][*]	Simulated [*] key
HEX [C]	Press [*][3][*]	Simulated [#] key
HEX [D]	Press [*][4][*]	Dial tone search
HEX [E]	Press [*][5][*]	Two second pause
HEX [F]	Press [*][6][*]	End of Number



In addition to the standard digits 0-9, HEX digits and special dialer functions can also be programmed.

3.3.3 How to Exit Installer Programming:

To exit installer programming, press the [#] key when the panel is waiting for a 3-digit section number (the Armed light is ON).

3.3.4 Viewing Programming

LED and LCD5501Z Keypads

Any programming section can be viewed from an LED or LCD5501Z keypad. When a programming section is entered, the keypad will immediately display the first digit of information programmed in that section.

The keypad displays the information using a binary format, according to the following chart:

Press any of the Emergency keys (Fire, Auxiliary or Panic) to advance to the next digit.

Please See Hex Data Entry Instructions

Value	0	1	2	3	4	5	6	7	8	9	A	B	C	D	E	F
Zone 1	<input type="checkbox"/>	<input checked="" type="checkbox"/>	<input type="checkbox"/>	<input checked="" type="checkbox"/>	<input type="checkbox"/>	<input checked="" type="checkbox"/>	<input type="checkbox"/>	<input checked="" type="checkbox"/>	<input type="checkbox"/>	<input checked="" type="checkbox"/>	<input type="checkbox"/>	<input checked="" type="checkbox"/>	<input type="checkbox"/>	<input checked="" type="checkbox"/>	<input type="checkbox"/>	<input checked="" type="checkbox"/>
Zone 2	<input type="checkbox"/>	<input type="checkbox"/>	<input checked="" type="checkbox"/>	<input checked="" type="checkbox"/>	<input type="checkbox"/>	<input checked="" type="checkbox"/>	<input type="checkbox"/>	<input checked="" type="checkbox"/>	<input type="checkbox"/>	<input checked="" type="checkbox"/>	<input type="checkbox"/>	<input checked="" type="checkbox"/>	<input type="checkbox"/>	<input checked="" type="checkbox"/>	<input type="checkbox"/>	<input checked="" type="checkbox"/>
Zone 3	<input type="checkbox"/>	<input type="checkbox"/>	<input type="checkbox"/>	<input checked="" type="checkbox"/>	<input checked="" type="checkbox"/>	<input type="checkbox"/>	<input checked="" type="checkbox"/>	<input type="checkbox"/>	<input checked="" type="checkbox"/>	<input type="checkbox"/>	<input checked="" type="checkbox"/>	<input type="checkbox"/>	<input checked="" type="checkbox"/>	<input type="checkbox"/>	<input checked="" type="checkbox"/>	<input type="checkbox"/>
Zone 4	<input type="checkbox"/>	<input type="checkbox"/>	<input type="checkbox"/>	<input type="checkbox"/>	<input type="checkbox"/>	<input type="checkbox"/>	<input type="checkbox"/>	<input checked="" type="checkbox"/>	<input type="checkbox"/>	<input checked="" type="checkbox"/>	<input type="checkbox"/>	<input checked="" type="checkbox"/>	<input type="checkbox"/>	<input checked="" type="checkbox"/>	<input type="checkbox"/>	<input checked="" type="checkbox"/>

Zone Light OFF
 Zone Light ON

When all the digits in a section have been viewed, the panel will exit the section. The Ready light will turn **OFF**, and the Armed light will turn **ON**. The system is now waiting for the next 3-digit programming section number to be entered. Press the [#] key to exit the section.

LCD Keypad

The keypad will immediately display all the information programmed when a programming section is entered. Use the arrow keys (< >) to scroll through the data being displayed. Scroll past the end of the data displayed or press the [#] key to exit the section.

Chapter 4 Programming Descriptions

The following is a brief description of the features and options available in the Power PC1616/1832/1864 control panel. Please refer to the keypad installation sheet for function key programming.

Global Stay Arming

If enabled by the installer, when this function key is pressed the panel will prompt the user for an access code. The panel will arm all partitions assigned to that access code in Stay Mode when exit delay expires. If a partition was armed in Away mode when the Global Stay Arming key is pressed, that partition will switch armed status to Stay when the delay expires. The Force arm attribute must be enabled on Entry/Exit points for this feature.

Global Away Arming

If enabled by the installer, when this function key is pressed the panel will prompt the user for an access code. The panel will arm all partitions assigned to that access code in Away Mode when exit delay expires. If a partition was armed in Stay mode when the Global Away Arming key is pressed, that partition will switch armed status to Away when the delay expires. The Force arm attribute must be enabled on Entry/Exit points for this feature.

Global Disarming

If enabled by the installer, when this function key is pressed the panel will prompt the user for an access code. The panel will then disarm all partitions assigned to that access code.

[001] to [004] Zone Definitions

Option	Description
[00]	Null Zone: Zone not used
[01]	Delay 1: When armed, provides entry delay when violated (follows Entry Delay 1)
[02]	Delay 2: When armed, provides entry delay when violated (follows Entry Delay 2)
[03]	Instant: When armed, instant alarm when violated
[04]	Interior: When armed, instant alarm will sound first if the zone is violated; instant alarm will follow the entry delay if entry delay is active
[05]	Interior Stay/Away: Similar to 'Interior' except that panel will auto-bypass the zone if Armed in the Stay mode
[06]	Delay Stay/Away: Similar to 'Delay 1' except that panel will auto-bypass the zone if Armed in the Stay mode
[07]	Delayed 24-Hour Fire (Hardwire): Instant audible alarm when violated, communication is delayed 30 seconds. If alarm is acknowledged during this time (by pressing a key), the alarm will be silenced 90 seconds and will repeat the cycle. If not, alarm will latch and communicate after a 30-second delay
[08]	Standard 24-Hour Fire (Hardwire): Instant alarm and communication when violated
[09]	24-Hr Supervision (Hardwire): Instant alarm and communication when violated. Will not sound the bell or keypad buzzer
[10]	24-Hr Supervisory Buzzer: Instant alarm, panel will activate keypad buzzer instead of bell output
[11]	24-Hr Burglary: Instant alarm when violated, audible alarm at default. Reporting code BA, BH
[12]	24-Hr Hold-up: Instant alarm when violated, silent alarm at default. Reporting code HA, HH
[13]	24-Hr Gas: Instant alarm when violated, audible alarm at default. Reporting code GA, GH
[14]	24-Hr Heat: Instant alarm when violated, audible alarm at default (also known as high-temp). Reporting code KA, KH
[15]	24-Hr Auxiliary (Medical): Instant alarm when violated, silent alarm at default. Reporting code MA, MH
[16]	24-Hr Panic: Instant alarm when violated, audible alarm at default. Reporting code PA, PH
[17]	24-Hr Emergency: Instant alarm when violated, audible alarm at default. Reporting code QA, QH
[18]	24-Hr Sprinkler: Instant alarm when violated, audible alarm at default. Reporting code SA, SH
[19]	24-hr Water: Instant alarm when violated, audible alarm at default (also known as high water level). Reporting code WA, WH
[20]	24-Hour Freeze: Instant alarm when violated, audible alarm at default (also known as low-temp). Reporting code ZA, ZH
[21]	24-Hr Latching Tamper: Instant alarm when violated, panel cannot be armed until Installer Programming is entered
[22]	Momentary Keyswitch Arm: Arm or disarm the system when violated
[23]	Maintained Keyswitch Arm: Arm system when violated, disarm system when restored
[24]	For Future Use
[25]	Interior/Delay: Zone will function as an Interior zone when armed in Away mode, and as a Delay zone when armed in Stay mode
[26]	24-Hr Non-Alarm: Zone will NOT create an alarm. Can be used with zone follower function for automation applications
[29]	Auto-Verified Fire: When violated, system will reset all smoke detectors for 20 seconds, then wait 10 seconds for detectors to settle. If another fire alarm is detected within 60 seconds, the zone will go into alarm immediately

- [30] **Fire Supervisory:** Instant alarm, system will activate keypad buzzer. A valid user code is required to silence keypad buzzer
- [31] **Day Zone:** Instant alarm when system is armed, keypad buzzer (no alarm) when system is disarmed
- [32] **Instant Stay/Away:** Similar to 'Instant' except panel will auto-bypass the zone if Armed in the Stay mode
- [35] **24-Hr Bell/Buzzer:** Instant alarm when violated, system will activate bell output if armed, keypad buzzer if disarmed
- [36] **24-Hr Non-Latching Tamper Zone:** Instant tamper condition when violated. Active in both the armed and disarmed state
- [37] **Night Zone:** Functions like Interior Stay/Away but will remain bypassed if the user presses [*][1] to re-activate Stay/Away zones when armed in the Stay mode
- [41] **24 Hr. Carbon Monoxide:** This zone type is used with a hardwired CO detector. This zone definition has a distinct bell cadence in the event of an alarm. The cadence of this alarm is 4 cycles of 100ms on/off pulses, followed by a 5-second pause, and then repeated. After 4 minutes, the 5-second pause is extended to 60 seconds in duration. The bell is silenced when an access code is entered or the bell times out (see your Carbon Monoxide instruction sheet for more details).
- [81] **24 Hr. Carbon Monoxide (Wireless):** This zone type is used with a wireless CO detector. This zone definition has a distinct bell cadence in the event of an alarm. The cadence of this alarm is 4 cycles of 100ms on/off pulses, followed by a 5-second pause, and then repeated. After 4 minutes, the 5-second pause is extended to 60 seconds in duration. The bell is silenced when an access code is entered or the bell times out.
- [87] **Delayed 24-Hour Fire (Wireless/Addressable):** Same as Delayed 24-Hour Fire (Hardwire) but must be used for wireless or addressable smoke detectors
- [88] **Standard 24-Hour Fire (Wireless/Addressable):** Same as Standard 24-Hour Fire (Hardwire) but must be used for wireless or addressable smoke detectors

[005] System Times

After entering Section [005], enter the 2-digit subsection number for the desired partition and program the Entry Delay 1, Entry Delay 2 and Exit Delay for each active partition on the system. Valid entries are from [001] to [255] or [045] to [255] for SIA CP-01 panels (in seconds). Enter subsection [09] to program the Bell Cut-Off Time. Valid entries are from [001] to [255] (in minutes).

[006] Installer Code

The default Installer Code is [5555] or [555555] if 6-Digit Access Codes is enabled.

[007] Master Code

The default Master Code is [1234] or [123456] if 6-digit Access Codes is enabled.

[008] Maintenance Code

The default Maintenance Code is [AAAA] (not programmed). This code can arm any partition, but cannot disarm unless the partition is in alarm.

[009] to [011] PGM Outputs

The PC1616 and PC1832 have two on-board PGM outputs (PGM1 and PGM2). The PC1864 has four on-board PGM outputs (PGM1 to PGM4). The panel has the capacity for up to 14 PGM outputs (8 additional low-current PGM outputs with PC5208 module, 4 additional high-current PGM outputs with a PC5204 module).

PGM Output Options:

Option	Description
[00]	For Future Use
[01]	Fire and Burglary: Output will activate (steady for burglary, pulsing for fire) if an alarm occurs on the selected partition
[02]	For Future Use
[03]	Sensor Reset: Output will normally be active and deactivate for 5 seconds when a [*][7][2] fire reset command is entered or when an Auto-Verify Fire alarm is detected
[04]	2-Wire Smoke: Configures PGM2 as 2-wire smoke detector input (PGM2 only)
[05]	Armed Status: Output will activate when all of the selected partitions are armed
[06]	Ready Status: Output will activate when all the selected partitions are in the Ready state (Ready light ON)
[07]	Keypad Buzzer Follow: Output will activate and follow the keypad buzzer for the selected partition when the following events occur: entry delay, door chime, audible exit delay, automatic arming pre-alert, 24-hr Supervisory Buzzer zone alarm
[08]	Courtesy Pulse: Output will activate during entry/exit delay if the selected partition is armed, and will remain active for an additional 2 minutes after the entry or exit delay expires
[09]	System Trouble: Output will activate when any selected trouble condition is present
[10]	Latched System Event (Strobe): Output will activate when a selected condition occurs on any selected partition. Note output can be programmed to follow timer

- [11] **System Tamper:** Output will activate when any tamper condition is present
- [12] **TLM and Alarm:** Output will activate if a telephone line trouble is present and then an alarm occurs
- [13] **Kissoff:** Output will activate for 2 seconds when a valid kissoff is received from the central station
- [14] **Ground Start:** Output will activate for 2 seconds when the panel attempts to seize the phone line (additional dial tone search must be programmed in the central station phone number – HEX [D])
- [15] **Remote Operation:** Output can be activated/deactivated via the DLS software
- [16] **For Future Use**
- [17] **Away Armed Status:** Activates when all of the selected partitions are armed in Away mode
- [18] **Stay Armed Status:** Activates when all of the selected partitions are armed in Stay mode
- [19] **Command Output 1:** Activates when a [*][7][1] command is entered on the selected partition – Command can be programmed to require a valid access code and output can be programmed to activate for the time programmed in Section [170] or programmed to latch.
- [20] **Command Output 2:** Activates when a [*][7][2] command is entered on the selected partition – Command can be programmed to require a valid access code and output can be programmed to activate for the time programmed in Section [170] or programmed to latch.
- [21] **Command Output 3:** Activates when a [*][7][3] command is entered on the selected partition – Command can be programmed to require a valid access code and output can be programmed to activate for the time programmed in Section [170] or programmed to latch.
- [22] **Command Output 4:** Activates when a [*][7][4] command is entered on the selected partition – Command can be programmed to require a valid access code and output can be programmed to activate for the time programmed in Section [170] or programmed to latch.
- [23] **Silent 24-Hour Input:** Changes PGM to a 24-hr Silent zone (PGM2 only)
- [24] **Audible 24-Hour Input:** Changes PGM to a 24-hr Audible zone (PGM2 only)
- [25] **Delayed Fire and Burglary:** Functions as a Fire and Burglary output but does not activate until the TX Delay time expires
- [26] **Battery Test Output:** Output activates for 10 seconds at midnight each day.
- [27] **For Future Use**
- [28] **Holdup Output:** Activates when a Holdup Alarm occurs on any assigned partition. Remains active until all assigned partitions have been armed or disarmed. Will not activate if a Holdup Zone goes into a fault or tamper condition.
- [29] **Zone Follower (Zones 1-8):** Active when any of the selected zones are active and deactivates when all of the selected zones are restored.
- [30] **Partition Status Alarm Memory:** Activates if the selected partition is armed. Output will pulse “one second ON / one second OFF if an alarm occurs
- [31] **Alternate Communicator:** Activates when selected system event occurs. If active in the armed state, it remains active until the system is disarmed. If activated in the disarmed state, it remains active until a valid access code is entered within the bell cut-off time, or when the system is armed after the bell cut-off time has expired.
- [32] **For Future Use**
- [33] **For Future Use**
- [34] **Away Armed with no Zone Bypassed Status:** Activates when armed with stay/away zones active and no zones bypassed.
- [35] **Zone Follower (Zones 9-16):** Active when any of the selected zones are active and deactivates when all of the selected zones are restored.
- [36] **Zone Follower (Zones 17-24):** Active when any of the selected zones are active and deactivates when all of the selected zones are restored.
- [37] **Zone Follower (Zones 25-32):** Active when any of the selected zones are active and deactivates when all of the selected zones are restored.
- [38] **Zone Follower (Zones 33-40):** Active when any of the selected zones are active and deactivates when all of the selected zones are restored.
- [39] **Zone Follower (Zones 41-48):** Active when any of the selected zones are active and deactivates when all of the selected zones are restored.
- [40] **Zone Follower (Zones 49-56):** Active when any of the selected zones are active and deactivates when all of the selected zones are restored.
- [41] **Zone Follower (Zones 57-64):** Active when any of the selected zones are active and deactivates when all of the selected zones are restored.

* See Section [501]-[514] Programmable Output Attributes, PGM Output Option [29] and [35]-[41] Option 8 on 24.

[012] Keypad Lockout

The system can be programmed to ‘lockout’ keypads if a series of incorrect user or installer codes are entered. When lockout is active, all keypads emit a steady 2-second error tone when a key is pressed. Program the Number of Invalid Codes Before Lockout with the desired number. Valid entries are from [000] to [255]. Program data [000] to disable the feature. Keypads will remain locked out for the number of minutes programmed for the Lockout Duration. Valid entries are from [000] to [255].

[013] First System Option Code**Option Description**

- [1] **ON:** zones require normally-closed loops. **OFF:** zones require End-Of-Line resistors, as determined by option [2].
- [2] **ON:** zones require double End-Of-Line resistors. **OFF:** zones require single End-Of-Line resistors.
- [3] **ON:** keypads will display all trouble conditions while armed. **OFF:** keypads will only display fire trouble when armed. This option must be **OFF** if LCD5500 v2.x (or older) keypads are used on the system.
- [4] **ON:** only a trouble will be displayed. **OFF:** keypads will display a trouble and a zone violation if a tamper or fault is detected.
- [5] **ON:** auto-arming schedules (Program Sections [181]-[188]) will be available to the user in the [*][6] menu.
OFF: auto-arming schedules will not be available to the user in the [*][6] menu.
- [6] **ON:** the Audible Exit Fault feature will be enabled. If a delay zone is not secured correctly and not force-armed at the end of the exit delay, the system will go into entry delay and turn ON the bell output. The bell will also sound if the delay zone is opened within 10 seconds of the exit delay timeout.
OFF: the keypad will sound the entry delay through the keypad as per usual.
- [7] **ON:** the system will NOT log additional alarms for a zone that has reached the swinger shutdown threshold.
OFF: all zone alarms will be logged.
- [8] **ON:** Temporal Three Fire Signal is used to sound fire alarms (½ second ON, ½ second OFF, ½ second ON, ½ second OFF ½ second ON, 1 ½ seconds OFF).
OFF: the system will pulse the bell output (½ second ON, ½ second OFF).

[014] Second System Option Code**Option Description**

- [1] **ON:** the system squawks the bell output once when a partition is armed, twice when disarmed.
OFF: the bell output does not activate. Refer to section [017] option 8.
- [2] **ON:** the system squawks the bell output every 10 seconds during the auto-arm pre-alert.
OFF: the bell output does not activate.
- [3] **ON:** the system will squawk the bell output once every second during Exit Delay, 3 squawks per second for the last 10s.
OFF: the bell output will not activate.
- [4] **ON:** the system will squawk the bell output once every second during Entry Delay, 3 squawks per second for the last 10s.
OFF: the bell output will not activate.
- [5] **ON:** the system squawks the bell output once every 10 seconds when a trouble condition is present.
OFF: the bell output does not activate.
- [6] **ON:** the system will beep the keypads once every second, and 3 times a second over the last 10 seconds, during an exit delay when the system is armed with a user code or armed in the Away mode.
OFF: the keypads will not beep.
- [7] **ON:** the exit delay will be terminated (reduced to 5 seconds) when a Delay 1 zone is violated and restored after the system is armed.
OFF: the exit delay will count down as normal.
- [8] **ON:** the bell output will not timeout if a fire alarm occurs. The user must turn OFF the bell by entering a valid user code.
OFF: the bell output will timeout normally.

[015] Third System Option Code**Option Description**

- [1] **ON:** the keypad fire emergency key will be enabled. **OFF:** the keypad fire emergency key will be disabled.
- [2] **ON:** the keypad Panic emergency will be audible (bell output). **OFF:** the Panic emergency key will be silent.
- [3] **ON:** the Quick Exit feature will be enabled. **OFF:** the Quick Exit feature will be disabled.
- [4] **ON:** the Quick Arming [*][0] feature will be enabled. **OFF:** Quick Arming [*][0] feature will be disabled.
 If this feature is disabled, a valid user code must be entered after the **Stay** or **Away** function buttons are pressed.
- [5] **ON:** a valid user code must be entered after pressing [*][1] to access the Bypass feature. **OFF:** user code is not required.
- [6] **ON:** the Master Code (user code 40) can only be changed in Installer Programming.
OFF: the Master Code can be changed using the User Programming [*][5] command.
- [7] **ON:** the system supervises the telephone line and displays a trouble if disconnected.
OFF: the telephone line is not supervised.
- [8] **ON:** the system activates the bell output if a telephone line trouble is detected while the system is armed.
OFF: the system activates the keypad buzzer trouble tone.

[016] Fourth System Option Code**Option Description**

- [1] **ON:** the system supervises the AC input and displays a trouble if a failure is detected. **OFF:** AC Input is not supervised.
- [2] **ON:** the trouble light will flash when an AC trouble is detected. **OFF:** the trouble light turns on, does not flash.
- [3] **ON:** the keypad blanks (no indicator lights) if a key is not pressed for 30 seconds. **OFF:** the keypad does not blank.
- [4] **ON:** a valid user code must be entered to restore normal keypad operation after the blanking.
OFF: pressing any key will return the keypad to normal operation.
- [5] **ON:** keypad backlighting enabled. **OFF:** keypad backlighting disabled.
- [6] **ON:** the system temporarily enables the Keypad Blanking feature if an AC failure is detected (to preserve the back-up battery).
OFF: the system will operate as normal.
- [7] **ON:** the keypad turns ON the Bypass light if zones are bypassed while the system is armed.
OFF: the Bypass light turns OFF when the system is armed.
- [8] **ON:** the system supervises keypad tampers. **OFF:** the system does not supervise keypad tampers.

[017] Fifth System Option Code**Option Description**

- [1] **ON:** the system does NOT associate wireless keys to user codes.
OFF: the system will assign user code 17 to wireless key #01, user code 18 to wireless key #02 etc. If the wireless key is used to arm or disarm, the system will report the Opening or Closing for the associated User Code.
- [2] **ON:** the system logs an RF Jam trouble condition if the condition is present for 5 minutes.
OFF: the system logs the trouble condition after 30 seconds.
- [3] **ON:** the keypads beep if an RF Jam trouble is detected.
OFF: the trouble is not announced via the keypad buzzer.
- [4] **ON:** the Double Hit feature will be enabled. Two violations from the same zone within the Cross Zone Timer will be considered a valid Police Code or Cross Zone event. The system will report the event and log it to the event buffer.
OFF: two alarms from the same zone is not a valid Police Code or Cross Zone event.
- [5] **ON:** the system logs and communicates a Late-To-Close event when the auto-arm time comes, but the function has been disabled (not if auto-arming was caused by the No-Activity Arming feature).
OFF: the system does not transmit or log a Late-To-Close event.
- [6] **ON:** enables the Daylight Savings automatic clock adjustment feature.
OFF: the system does not automatically adjust the clock for Daylight Savings.
- [7] **For Future Use**
- [8] **ON:** the system only squawks the bell output when the system is armed in the Away mode.
OFF: the system squawks the siren when the system is armed in any mode. (See Section [14], Option [1]).

[018] Sixth System Option Code**Option Description**

- [1] **ON:** the system only transmits a Test Transmission reporting code if no other event was transmitted to the central station during the programmed time.
OFF: the system always transmits a Test Transmission reporting code as programmed.
- [2]-[4] **For Future Use**
- [5] **ON:** the keypad buzzer follows the bell output for all alarms.
OFF: the system only activates the bell output for all alarms.
- [6] **ON:** When an alarm is detected on a zone (with the Cross Zone attribute enabled), a timer is started. The alarm is not transmitted and the bell output is not activated unless a second cross zone enabled zone is violated before the Cross Zone timer times out.
OFF: the system reports all alarms normally and logs and transmits a Police Code reporting code if a second zone alarm is detected during the armed period.
- [7] **ON:** The system restarts the Exit Delay (one time) if a Delay zone is violated and restored during the exit delay time.
OFF: The Exit Delay does not restart.
- [8] **ON:** The system activates the trouble beeps when an AC trouble is detected.
OFF: the system does not announce AC troubles using the keypad buzzer.

[019] Seventh System Option Code

Option	Description
[1]	For Future Use
[2]	For Future Use
[3]	ON: When disarming, the keypad will display only the first alarm to occur during the last arming period. OFF: When disarming, the keypad will display all zones that were in alarm during the last arming period
[4]-[5]	For Future Use
[6]	ON: the green LED indicator on the keypads indicate the status of AC on the system OFF: the green LED indicator on the keypads indicate the partition ready status
[7]	ON: All user access codes can enter the User Functions menu. OFF: Only the Master Code can enter the User Functions menu.
[8]	For Future Use

[020] Keypad Zone Assignment

Enter the two-digit zone number to be assigned to each keypad assigned to a specific slot. Only one keypad can be assigned to a specific slot. See Keypad Assignment. Valid entries are from [00] to [64].

[021] Eighth System Option Code

Option	Description
[1]	ON: Access codes will not be accepted by the system during entry delay. OFF: An access code can be used to disarm the system during entry delay
[2]-[5]	For Future Use
[6]	ON: Key-switches and wireless keys can only disarm the system during an entry delay OFF: Key-switches and wireless keys can disarm the system regardless if entry delay is active or not.
[7]-[8]	For Future Use

[022] Ninth System Option Code

Option	Description
[1]	ON: An access code is required for access to the [*][1], [*][2], [*][3] menus. OFF: No access code is required for [*][1], [*][2], [*][3] menu access.
[2]-[3]	For Future Use
[4]	ON: Only the Master code can be used to bypass a hold up zone. OFF: Any valid access code can bypass a hold up zone.
[5]	For Future Use
[6]	ON: RF Delinquency Enabled, if any wireless zone supervisory transmission is not received by the PC5132 during a 15-minute period, the PC5132 will place the panel into Not Ready To Arm mode. In the armed state, the Zone faults will generate tamper alarms. The panel will generate a silent trouble (NO trouble beeps but the Trouble LED is turned ON) called "RF Device Delinquency", which is only viewable in [*][2] (Trouble Menu). The user can override the condition and arm the panel by using the feature. OFF: RF Delinquency Disabled, the system will not indicate an RF Delinquency when a zone supervisory transmission is not received during a 15 minute period.
[7]	Future Use
[8]	ON: When the system is armed in Stay mode, during the Exit delay, the system will sound one beep every 3 seconds. OFF: When the system is armed in Stay mode, the system will be silent during the Exit delay.

[023] Tenth System Option Code

Option	Description
[1]	ON: the keypad [F] emergency key will only beep three times to acknowledge that the button has been pressed. The system will not activate the bell output. OFF: the system will activate the bell output and beep the keypad.
[2]	For Future Use
[3]	ON: the system will only transmit the Test Transmission reporting code if the system is armed at the time the system is programmed to report the event. OFF: the system will always report the Test Transmission reporting code at the programmed time.
[4]	ON: the system changes the Test Transmission Reporting Cycle Time from Days to Hours. OFF: the Test Transmission Reporting Cycle Time is in Days.

- [5] **ON:** the user cannot switch from Away Arm mode to Stay Arm mode using the function keys.
OFF: the user can switch arming modes.
- [6] **ON:** the system disconnects a listen in/two-way session if a new event occurs.
OFF: the system does NOT disconnect. New events are transmitted only after the session is terminated.
- [7] **ON:** the system does NOT activate the keypad buzzer for any trouble condition (excluding Fire Troubles).
OFF: the system announces troubles via the keypad buzzer (two beeps every 10 seconds).
- [8] **ON:** Keyswitches will always arm in Away mode.
OFF: Keyswitches will arm in Away mode if an entry/exit zone is violated during exit delay.

[030] Fast Loop Response

This section is used to determine the Loop Response Time for the main panel zones.

ON: the loop response time will be 36 ms. **OFF:** the loop response time will be 400 ms.

[101] to [164] Zone Attributes

These sections are used to customize the operation of the zones. There are 9 toggle options in each section:

Option	Description
[1]	ON: alarms are audible (bell output). OFF: alarms are silent.
[2]	ON: the bell output is steady (burglary). OFF: the alarm output pulses (fire).
[3]	ON: a zone violation or restoral will activate Chime. OFF: Chime is not activated.
[4]	ON: the user can manually bypass the zone using the [*][1] command. OFF: the zone cannot be manually bypassed.
[5]	ON: the partition can be armed even if the zone is violated (the zone will not affect the Ready status). OFF: the zone must be secure before arming.
[6]	ON: the system shuts down alarm reporting after the programmed number of alarms have occurred. OFF: the panel will always report the event if an alarm occurs.
[7]	ON: the system delays reporting the event for the time programmed for the Transmission Delay time. OFF: the panel immediately transmits the reporting event when an alarm is detected.
[8]	ON: the zone is a wireless or addressable device. OFF: the zone is a hardwire zone (main panel, zone expander or keypad zone).
[9]	ON: the zone has the Cross Zone feature enabled. OFF: the zone functions normally.
[10]-[13]	For Future Use
[14]	ON: the zone requires a normally-closed loop OFF: the zone will follow the EOL configuration in [013]
[15]	ON: the zone requires a single End-of-Line resistor OFF: the zone will follow the EOL configuration in [013]
[16]	ON: the zone requires double End-of-Line resistors OFF: the zone will follow the EOL configuration in [013]

Options [14], [15], [16] apply to first 8 zones only. If more than one of these options are enabled then lowest numbered option is enabled. E.g., If Option [14] and option [15] are enabled then the zones are configured as normally closed loops.

i *Keypad zones and zone expanders will always follow [013].*

When Zone Types ([001] to [004]) are programmed, the system will change the Zone Attributes to those found in the chart included in the Programming Worksheets. The Zone Attributes will default if a new Zone Type is programmed for a specific zone. After programming the Zone Types, enter [101] to [164] and ensure that all options are programmed correctly.

Ready light ON: Program attributes [1-8] (press [1]-[8] to turn option ON or OFF)

Ready light and Armed light ON: Program attributes [9-16] (press [1]-[8] to turn option ON or OFF)

Press [9] to switch between attributes [1-8] and attribute [9-16].

[165] Maximum Dialing Attempts

Program the Maximum Dialing Attempts before the panel will generate a Failure to Communicate (FTC) trouble condition.

Valid entries are [001] to [005]. For UL Listed installations, 5 attempts is required.

[166] Post Dial Wait for Handshake

Program the maximum time the panel will wait, after dialing, for a valid handshake from the central station. Valid entries are [001] to [255] seconds.

[167] TL/GS Module Wait for Acknowledgement

Program the maximum time the panel will wait, after sending a data packet, for an acknowledgement from the central station. Valid entries are [060] to [255] seconds.



Do not program this section with a value less than 60.

[168] Daylight Saving Time (Move Clock Ahead)

This option is used to program the Date, Time and Increment that the clock will move ahead for Daylight Savings Time each year. Programming can be accomplished by programming the Month, Day, Hour and Increment or Month, Week, Day of Week, Hour and Increment:

Month: Data [001] to [012] represents January to December.

Week: Data [000] indicates that the day of the month will be programmed in the Day section below. Data [001] to [005] represents weeks 1 to 5 of the month. Week 5 always represents the last week in the month, regardless if the number of weeks in the month is 4 or 5.

Day: Data [001] to [031] represents day of the month if [000] was programmed in the Week section above. If [001] to [005] was programmed in the Week Section above, then Data [000] to [006] represents Sunday to Saturday

Hour: Data [000] to [022] represents the hour that Daylight Saving Time will take effect.

Increment: Data [001] to [002] represents the number of hours to advance the clock for Daylight Savings Time.



Do not program the Hour outside of the valid range or the time will not change. Do not program the value of the Increment to be greater than the number of hours remaining in the current day.

[169] Standard Time (Set Clock Back)

This option is used to program the Date, Time, and Increment that the clock will move back for Standard Time each year. Programming can be accomplished by programming the Month, Day, Hour, and Increment or Month, Week, Day of Week, Hour, and Increment:

Month: Data [001] to [012] represents January to December.

Week: Data [000] indicates that the day of the month will be programmed in the Day section below. Data [001] to [005] represents weeks 1 to 5 of the month. Week 5 always represents the last week in the month, regardless if the number of weeks in the month is 4 or 5.

Day: Data [001] to [031] represents day of the month if [000] was programmed in the Week section above. If [001] to [005] was programmed in the Week section above, then Data [000] to [006] represents Sunday to Saturday.

Hour: Data [000] or [023] represents the hour that Standard Time will take effect.

Increment: Data [001] or [002] represents the number of hours to roll back the clock for Daylight Saving Time.

[170] PGM Output Timer

Program the amount of time, in seconds, that the PGM Output Timer will be active. Valid entries are [001] to [255].

[171] Tamper PGM Output Timer

Program the amount of time, in minutes, that a tamper condition will latch the Tamper PGM output. Valid entries are [000] to [255].

[175] Auto-arm Postpone Timer

Program the amount of time, in minutes, that the system will postpone automatic arming. When the programmed time has expired, the system will attempt to auto-arm again. If data [000] is programmed, the system will instead abort the auto-arm sequence. Valid entries are [001] to [255].

[176] Cross Zone/Police Code Timer

Program the amount of time in seconds (Cross Zone), or minutes (Police Code), that the panel will use to determine if a Cross Zone or Police Code event has occurred. If data [000] is programmed when using the Police Code feature, and if any two zones go into alarm during any armed-to-armed period, the panel will generate a Police Code event. Valid entries are [001] to [255].

[181] to [188] Auto-arm Schedules

Program the amount of time to auto-arm ([181] for partition 1, [182] for partition 2, etc.) for each day of the week. Each option has seven, 4-digit entries: two digits for the hour, two digits for the minute, Sunday through Saturday. Program using the twenty-four-hour system (for example, to auto-arm at 8:00 pm, program data [20][00]). Valid entries are [00][00] to [23][59]. Program [99][99] to disable auto-arming.

[190] No Activity Arming Pre-Alert Duration

Program the amount of time, in minutes, for the No Activity Arming Pre-Alert Duration. The keypads will emit a steady tone, warning the user that the system is about to arm. The user can either violate a zone or press any key to abort the arming sequence. Valid entries are [000] to [255].

[191] to [198] No Activity Arm Timer

Program the amount of time, in minutes, for the No Activity Arm Timer ([191] for Partition 1, [192] for Partition 2, etc.). If Delay Zones are restored and no zone activity is detected for the time programmed, the system will start the auto-arm sequence. Valid entries are [000]-[255].

[199] Auto-Arming Pre-alert Timer

Program the amount of time, in minutes, for the Auto-Arming Pre-Alert Time. This timer is used for all programmed auto-arming features (is not used for No Activity Arming). The keypads will provide a steady tone, warning the user that the system will arm. The user can enter a valid access code to abort the arming sequence. Valid entries are [001] to [255].

[201] Partition Selection Mask

Turn the corresponding option ON to enable partitions [1] to [8]. ON (bit 1 cannot be turned OFF).

[202] to [265] Partition Zone Assignments

These options are used to assign zones to specific partitions ([202] to [209] for Partition 1, [210] to [217] for Partition 2, etc.). Turn ON the option corresponding to the partition and zone to enable the zone on the specified partition. Turn the option OFF to disable the zone on the specified partition. Zones assigned to more than one partition are called 'common zones' and will be armed only if all the partitions the zone is assigned to are armed. Default = Zones 1-8 enabled on Partition 1.

[301] First Telephone Numbers

The information in this section also applies to sections [302] and [303]. Telephone number 3 is dedicated as a back-up to Telephone number 1. These sections determine which type of communicator is activated in the event of an alarm (telephone, GPRS and Ethernet) and the sequence that the system follows in the event of an unsuccessful communication.

- Entry of [D] followed by a [Telephone Number] terminated with "F" configures the section for telephone dialing.
E.g.: [D12223334444F]
- Entry of [D] followed by [CAA] terminated with "F" allows the system configuration to be determined by the GPRS/Ethernet module.
E.g.: [DCAAF]
- Enter [DCBBF] to configure the section for Ethernet Receiver 1
- Enter [DCCCF] to configure the section for Ethernet Receiver 2
- Enter [DCDDF] to configure the section for GPRS Receiver 1
- Enter [DCEEF] to configure the section for GPRS Receiver 2



Please refer to Section [350] Communicator Formats, only SIA and Contact ID are valid alternate communicator formats. Programming any other format will send SIA by default.



Please refer to your associated communicator manual for more details.

Telephone Communications

All telephone number sections are 32 digits in length. Hexadecimal digits may be programmed in the telephone number to perform additional functions as follows:

- Enter [*][2][*] – HEX B to dial "*"
- Enter [*][3][*] – HEX C to dial "#"
- Enter [*][4][*] – HEX D for an additional dial tone search, as is required for PBX telephone systems
- Enter [*][5][*] – HEX E to insert a 2-second pause in the telephone number.



There is an automatic 2-second pause before additional dial tone searches are initiated.

- HEX A is not used.
- HEX F represents the end of the phone number (everything after F is ignored).
- Pressing [#] in these sections will exit and save the entire phone number.
- The panel will not attempt to communicate, if no phone number is programmed. This applies to phone numbers 1 and 2.

[302] Second Telephone Number

See [301] First Telephone Number for details.

[303] Third Telephone Number

See [301] First Telephone Number for details.

[304] Call Waiting Cancel String

Program the digits required to disable call waiting. If enabled, the system will dial the programmed string on the first dialing attempt. Program unused digits with data [F].

[310] System Account Number

Program the System Account Number. Only the SIA format supports 6-digit account numbers. If a 4-digit account number is required, program the last two digits as data [FF]. When using the SIA format, this account number will be used for all reporting events. When using a different format, this account number will be used for all events that are not partition-specific (for example, low battery, AC trouble, etc.). For partition-specific events the system will use the programmed Partition Account Number. For all formats other than SIA, program a HEX [A] for any digit [0] in the account number being used.

[311] to [318] Partition Account Numbers

Program the Partition Account Number for each active partition ([311] for partition 1, [312] for partition 2, etc.). When using the Automatic SIA format, these account numbers are not used. The system will use the System Account Number for all reporting events. For all formats other than SIA, program a HEX [A] for any digit [0] in the account number being used.

[320] to [349] Reporting Codes

Program the reporting code for all events to be transmitted. For a description of when each reporting event will be transmitted, refer to Appendix A – Reporting Codes. The panel also supports Automatic SIA and Automatic Contact ID reporting. Program data [00] to disable the reporting of an event. If any other data is programmed (Data [01] to [FF]), the panel will automatically generate the correct reporting event when transmitting to the central station. For all formats excluding Automatic SIA and Automatic Contact ID, the panel will not attempt to report an event if data [00] or data [FF] is programmed for the reporting code.

[350] Communicator Format

Program the 2-digit number for the desired Communicator Format for the First Phone Number and the Second Phone Number. When dialing the Third Phone Number, the system will use the Communicator Format programmed for Phone Number 1. Refer to the Programming Worksheet for a list of the available Communicator Formats. See Appendix F for details.

[351] to [376] Communicator Call Direction Options

Reporting events are categorized into 5 groups: Alarm/Restore, Opening/Closing, Tamper Alarm/Restore, System Maintenance, and Test Transmissions. Program which Phone Number the control panel will use to transmit reporting events by turning the option ON in the correct section. Phone Number 1 and/or Phone Number 2 can be used.

[377] Communicator Variables

Program a 3-digit number for each program entry:

Swinger Shutdown (Alarms): Maximum number of alarm/restoral transmissions per zone. Valid entries: [001] to [014]. Program data [000] to disable shutdown.

Swinger Shutdown (Tamper): Maximum number of tamper alarm/restoral transmissions per zone. Valid entries: [000] to [014]. Program data [000] to disable shutdown.

Swinger Shutdown (Trouble): Maximum number of trouble alarm/restoral transmissions per trouble condition. Valid entries: [000] to [014]. Program data [000] to disable shutdown.

Communicator (Transmission) Delay: Time, in seconds, the panel will delay reporting an alarm event. Valid entries: [000] to [255].

AC Failure Communication Delay: Time, in minutes, the panel will delay reporting an AC trouble event. Valid entries: [000] to [255].

TLM Trouble Delay: Time, in 3-second intervals, before the system will consider the phone line disconnected. Valid entries: [003] to [255] (e.g., 3 x10 seconds = 30 seconds).



TLM Restoral follows the same delay.

Test Transmission Cycle (Land Line): Number of days between test transmission reporting events. Valid entries: [001] to [255].

Wireless Zone Low Battery Delay: Number of days the system will delay reporting a wireless low battery to the central station. Valid entries: [000] to [255]. Program data [000] for no delay.

Delinquency Transmission Delay: Number of hours (Activity Delinquency) or days (Arming Delinquency) the panel will delay before transmitting the event to the central station. Valid entries: [001] to [255].

Communication Cancel Window: Time, in minutes, after an alarm has occurred that the system will report a Communication Cancel reporting event if the system is disarmed. They keypad will beep rapidly to indicate that the Communication Cancel reporting event has been communicated successfully. Valid entries: [001] to [255]. Entering [000] will disable this window.

[378] Test Transmission Time

Program the time the system will report a Test Transmission reporting event. Program 4 digits – [HH][MM] using the twenty-four-hour system. For a test transmission at 11:00 pm, program data [23][00]). Valid entries are [00][00] to [23][59]. Entering [99][99] will disable the test transmission.



[379] Periodic DLS Time of Day

Programs the time the system will auto-call DLS. Program 4 digits – [HH][MM] using the twenty-four-hour system. For a DLS auto-call at 11:00 pm, program data [23][00]). Valid entries are [00][00] to [23][59]. Programming [99][99] will select a random time, [FF][FF] will disable it.

[380] First Communicator Option Code

Option	Description
[1]	ON: the system communicator is enabled. OFF: the communicator is disabled.
[2]	ON: the system transmits alarm restorals if the zone is restored and the bell has timed out. OFF: the system transmits alarm restorals immediately when the zone is restored.
[3]	ON: the panel uses rotary (pulse) dialing. OFF: the panel uses DTMF (touchtone) dialing.
[4]	ON: the panel will switch from DTMF dialing to rotary dialing after the 4th failed attempt to communicate. OFF: the panel will use DTMF dialing for all dialing attempts.
[5]	ON: the system uses the Third Phone Number to back up the First Phone Number. OFF: the Third Phone Number is disabled.
[6]	ON: the system alternates between the First Phone Number and Third Phone Number when attempting to report an event. OFF: the panel will dial the First Phone Number for the programmed number of attempts, then switch to the Third Phone Number.
[7]	For Future Use
[8]	ON: the Delinquency feature follows zone activity. OFF: the Delinquency feature follows arming.

[381] Second Communicator Option Code

Option	Description
[1]	ON: the keypad beeps 8 times after successfully transmitting the Opening After Alarm reporting event. OFF: the keypad does not beep.
[2]	ON: the bell output squawks 8 times after successfully transmitting the Opening After Alarm reporting event. OFF: the bell output does not activate.
[3]	ON: the system uses programmed reporting codes when transmitting using the SIA format. OFF: the system automatically generates all reporting codes transmitted.
[4]	ON: the system beeps the keypad 8 times after successfully transmitting a Closing reporting event. OFF: the keypad does not beep.
[5]	ON: the system requests a Listen in/two-way session the next time it calls the 1st/3rd Phone Number when the PC59xx transmits a request. OFF: the system ignores the request from the PC59xx.  <i>This option is used with PC59xx series modules.</i>
[6]	ON: the system requests a Listen in/Two-way session the next time it calls the 2nd Phone Number when the PC59xx transmits a request. OFF: the system will ignore the request from the PC59xx.  <i>This option is used with PC59xx series modules.</i>
[7]	ON: the system uses Contact ID format programmed reporting codes when transmitting reporting codes. OFF: the system automatically generates all reporting codes transmitted.
[8]	ON: the system will follow ULC Communication Priority. OFF: the system will follow standard communications priority.

[382] Third Communicator Option Code

Option	Description
[1]	For Future Use
[2]	ON: the system will transmit all alarms during Walk Test. OFF: the system will not report alarm events during Walk Test.
[3]	ON: the keypad will display the message 'Communications Cancelled' (programmable LCD) or 'CC' (fixed-message LCD) upon successful transmission of the Communication Cancelled reporting event. OFF: the keypad will not display these messages.
[4]	ON: the system dials the Call Waiting Cancel String on the first attempt to dial the central station. OFF: the system does not dial the Call Waiting Cancel String.
[5]	ON: enables support for the TL/GS Module. OFF: disables TL/GS Module.
[6]	ON: the AC Failure Transmission Delay Timer is in hours. OFF: the delay is in minutes.
[7]	ON: sets the number of Dialing attempts to 1 when using Residential Dial Format. OFF: residential Dial follows Dialing Attempt Counter.
[8]	For Future Use

[383] Fourth Communicator Option Code**Option Description**

- [1] **ON:** events programmed to communicate to phone #1 will use the Partition Account Number in [311]. Events Programmed to communicate to phone #2 will use the Partition Account Number in [312].
OFF: each event will use its respective partition account code.
- [2]-[8] For Future Use

[389] TL/GS Module Fault Check Timer

Program the time, in 3-second intervals, before the system considers the TL/GS Module disconnected. Valid entries: [002] to [255] (e.g., 010 x 3 seconds = 30 seconds).

[401] First Downloading Option Code**Option Description**

- [1] **ON:** the system answers incoming calls for downloading (either Programmed Number of Rings or Double Call).
OFF: the system does not answer incoming calls using the double call routine for downloading.
-  *These settings do not affect the 6-hour DLS downloading window on power-up.*
- [2] **ON:** the user can enable downloading for the DLS Window using the [*][6] command.
OFF: the user cannot enable downloading.
- [3] **ON:** the system will hang up after a successful DLS connection and call the computer back using the DLS Phone Number ([402]).
OFF: the system stays connected to the computer.
- [4] **ON:** the user can initiate a downloading session using the [*][6] command.
OFF: the user cannot initiate a downloading session.
- [5] **ON:** the system attempts to call the downloading computer after transmitting an Event Buffer 75% Full event to the central station.
OFF: the system does NOT call the downloading computer after transmitting this event.
- [6] **ON:** panel communicates with DLS at 300 Baud. **OFF:** panel communicates with DLS at 110 Baud.
- [7]-[8] For Future Use

[402] Downloading Computer Phone Number

The Downloading Computer Telephone Number is used for Call Back, User Initiated DLS, and the Auto Event Buffer Upload functions. Program the phone number as required. HEX digits can be included for special applications:

HEX [A]	Not used
HEX [B]	Simulates a [*] key press
HEX [C]	Simulates a [#] key press
HEX [D]	Additional dial tone search
HEX [E]	2-second pause
HEX [F]	End of phone number marker

[403] Downloading Access Code

Program the 6-digit Downloading Access Code. Upon connection, the system will only connect to the downloading computer if the Downloading Access Code matches the Downloading Access Code programmed in the computer file.

[404] Panel Identification Code

Program the 6-digit Panel Identification Code. This code is used by the downloading computer to verify the correct account is calling back (Call Back feature) or to identify which customer account file should be used (User Initiated DLS and Auto Event Buffer Upload features).

[405] Double-Call Timer

Program the maximum amount of time, in seconds, between calls when connecting to a panel using the double call feature. Valid entries are [001] to [255].

[406] Number of Rings to Answer On

Program the number of consecutive rings that panel must detect to answer for downloading. Valid entries are [000] to [010].

[499] PC-Link Communications

Enter the following command to initiate downloading via PC-Link: [499] [Installer Code] [499]. Plugging in the PC-Link connector will automatically initiate the connection if DLS is initiated before connecting the PC-Link Header. The session will NOT be automatically initiated if the system is in installer mode.

[501] to [514] Programmable Output Attributes

These options are used to customize the operation of the PGM outputs ([501] for PGM 1, [502] for PGM 2 etc.). The available options depend on which PGM output type has been programmed.

When the PGM Output Options ([009] to [011]) are programmed, the system will change the PGM Attributes to the default settings. The PGM Attributes will default if a new PGM output option is programmed.

PGM Output Option [01], [03] to [08], [11] to [22], [25],[26], [28], [30], [33], [34]**Option Description**

- [3] **ON:** the PGM output will operate normally (switch to ground when activated).
OFF: the PGM output will be grounded and switch to open collector (open circuit) when activated.

PGM Output Option [19] to [22]**Option Description**

- [4] **ON:** the PGM output will activate for the duration of the PGM Output Timer when the [*][7][x] command is performed.
OFF: the PGM output will latch until the [*][7][x] command is performed again.
- [5] **ON:** a valid user code must be entered after the [*][7][x] command. **OFF:** a user code is not required.

PGM Output Option [09]**Option Description**

- [1] **ON:** PGM output is activated if a Service Required trouble condition is present.
- [2] **ON:** PGM output is activated if an AC trouble condition is present.
- [3] **ON:** PGM output is activated if a Telephone Line trouble condition is present.
- [4] **ON:** PGM output is activated if a Failure to Communicate trouble condition is present.
- [5] **ON:** PGM output is activated if a Zone Fault condition is present.
- [6] **ON:** PGM output is activated if a Zone Tamper condition is present.
- [7] **ON:** PGM output is activated if a Wireless Low Battery trouble condition is present.
- [8] **ON:** PGM output is activated if a Loss of Clock trouble condition is present.

PGM Output Option [10]**Option Description**

- [1] **ON:** PGM output is activated if a Burglary Alarm occurs.
- [2] **ON:** PGM output is activated if a Fire Alarm occurs.
- [3] **ON:** PGM output is activated if a Panic Alarm occurs.
- [4] **ON:** PGM output is activated if a Medical Alarm occurs.
- [5] **ON:** PGM output is activated if a Supervisory Alarm occurs.
- [6] **ON:** PGM output is activated if a Priority Alarm occurs.
- [7] **ON:** PGM output is activated if a 24-Hour Hold-Up Alarm occurs.
- [8] **ON:** the PGM output is activated for the time programmed for the PGM Output Timer.
OFF: the PGM output will latch until a valid user code is entered.

PGM Output Option [31]**Option Description**

- [1] **ON:** PGM output is activated if a Fire Alarm occurs.
- [2] **ON:** PGM output is activated if a Panic Alarm occurs.
- [3] **ON:** PGM output is activated if a Burglary Alarm occurs.
- [4] **ON:** PGM output is activated if an Opening/Closing occurs.
- [5] **ON:** PGM output is activated if a zone is automatically bypassed.
- [6] **ON:** PGM output is activated if a Medical Alarm occurs.
- [7] **ON:** PGM output is activated if both a confirmed alarm and a Police Code occur.
- [8] **ON:** the PGM output is active when the selected condition is true. **OFF:** the PGM output will latch until a valid user code is entered

PGM Output Option [32]**Option Description**

- [1]-[7] For Future Use
- [8] **ON:** the PGM is activated for the duration programmed in PGM Output Timer.
OFF: the PGM is activated when an Opening After Alarm occurs, and will be deactivated when a valid access code is entered.

PGM Output Option [29] and [35]-[41]**Option Description**

- [1]-[2] For Future Use
- [3] **ON:** the PGM will switch to ground when the event occurs.
OFF: the PGM will switch to open when the event occurs.
- [4]-[7] For Future Use
- [8] **ON:** AND logic is selected, all zones that are enabled must be violated before the PGM will activate.
OFF: OR logic is selected, only one violated zone is required to activate the PGM. All zones must be restored to turn it OFF.

 **Zones are assigned to this PGM in the PGM Partition Assignment Section [551]-[564]**

[551] to [564] PGM Partition Assignment

These sections are used to customize the operation of the PGM outputs ([551] for PGM 1, [552] for PGM 2, etc.). Turn on the desired option in the correct section to assign the PGM output to a specified partition. PGM outputs can be assigned to more than one partition. For PGM outputs that are considered 'system' outputs (e.g., Trouble output), programming in these sections will not affect the operation of the PGM output. Zone Follower PGM types 29 and 35-41 are used to assign specific zones to the PGM.

 **Each Command Output PGM type can be assigned to one partition only.**

[601] to [608] Additional Reporting Codes

Program the reporting code for all events to be transmitted. For information of when each reporting event will be transmitted, refer to Appendix A – Reporting Codes. The panel also supports Automatic SIA and Automatic Contact ID reporting. Program data [00] to disable the reporting of an event. If any other data is programmed (Data [01] to [FF]) the panel will automatically generate the correct reporting event when transmitting to the central station. For all formats excluding Automatic SIA and Automatic Contact ID, the panel will not attempt to report an event if data [00] or data [FF] is programmed for the reporting code.

[681] to [688] Auto-Disarm Schedules

Program the time to auto-disarm ([681] for Partition 1, [682] for Partition 2, etc.) for each day of the week. Each section has seven, 4-digit entries: two digits for the hour, two digits for the minute, for Sunday through Saturday. Program using the twenty-four-hour system (for example, to auto-arm at 8:00 pm program data [20][00]). Valid entries are [00][00] to [23][59] – program [99][99] to disable auto disarming

[691] to [698] Auto-Disarm Holiday Schedule

Program the dates to be used for the Auto-Disarm holiday schedule ([691] for Partition 1, [692] for Partition 2, etc.) Each section has 14, 6-digit entries: two digits for the month, two digits for the day and two digits for the year. The panel will not disarm on the programmed dates. The format of entering the date is MMDDYY. Program [99][99][99] to disable the Auto-Disarm holiday schedule.

[700] Automatic Clock Adjust

Program the number of seconds for the last minute of the day. This can be used to make minor corrections to the clock if the AC frequency is not reliable. Valid entries are [01] to [99].

[701] First International Option Code**Option Description**

- [1] **ON:** configures the system for 50Hz AC. **OFF:** configures the system for 60Hz AC.
- [2] **ON:** the system uses the internal crystal for the internal panel clock. **OFF:** the system uses the AC frequency for the internal panel clock.
- [3] **ON:** the system will inhibit arming if a Low Battery or AC trouble condition is present. **OFF:** arming will not be inhibited.
- [4] **ON:** all Tamper troubles will latch and arming will be inhibited. Enter Installer Programming to clear the trouble condition and return to normal operation. **OFF:** Tamper troubles will not latch and will not inhibit arming.
- [5] **ON:** all access codes are 6-digits long. **OFF:** all access codes are 4-digits long.
- [6] **ON:** the system will hang up if a busy tone is detected. This attempt is not counted towards the Maximum Dialing Attempts. **OFF:** the panel will not detect busy tones.
- [7] **ON:** the system will charge the battery at approximately 700mA. **OFF:** the system will charge the battery at 400mA.
- [8] **ON:** the system will abort a DLS session, Escort access, Listen In/Two-way session if a new central station communication event occurs. **OFF:** non-critical events (Test transmission, Periodic Test and System Test) will not abort the session. Events will be communicated after the session is complete.

[702] Second International Option Code**Option Description**

- [1] **ON:** the communicator uses a 33/67 make/break ratio when pulse dialing.
OFF: the system uses a 40/60 make/break ratio.
- [2] **ON:** the system dials regardless of the presence of a dial tone after the first attempt.
OFF: the system dials only if a dial tone is detected.
- [3] **ON:** changes the Test Transmission Cycle Time to minutes.
OFF: sends a Test Transmission after the programmed number of days.
- [4] **ON:** the system accepts 1600Hz handshake pulse formats.
OFF: the system accepts 1400Hz or 2300Hz handshakes.
- [5] **ON:** the system generates a tone for 500ms every 2 seconds, indicating digital equipment is making the call vs. a voice call.
OFF: the system does not generate a tone.
- [6] **ON:** the tone generated (2100Hz.) indicates that digital equipment is making the call.
OFF: the tone is 1300Hz.
- [7] **ON:** the DLS down loading window is 1 hour. **OFF:** the DLS downloading window is 6 hours.
- [8] **ON:** the system activates the bell output if a Failure to Communicate trouble occurs while the system is armed.
OFF: the system does NOT activate the bell output if a Failure to Communicate trouble occurs while the system is armed.

[703] Delay Between Dialing Attempts

Program the amount of time (in seconds) the panel will wait between dialing attempts to transmit a reporting event to the central station. Valid entries are [001] to [255].

[800]-[851] Module Programming

The following program options are used to program different modules that can be connected to the control panel. Refer to the relevant Installation Manual for installation and programming information.

- [801]: PC5400 Printer Module Programming
- [802]: PC59xx VOX Module Programming
- [803]: Alternate Communicator Programming
- [804]: Wireless Programming
- [805]: PC5100 Addressable Programming
- [851]: TL/GS Module Programming

Special Installer Instructions**[898] Wireless Enrollment**

Refer to Section 1.12 RFK5500 and RFK5564 Easy Wireless Enrollment Procedure for details.

[899] Template Programming

Selecting [*][8] [Installer Code] [899] displays the current 5-digit template programming code. Refer to section 3.1 Template Programming for details. Refer to Appendix E - Template Programming for a detailed description of available templates and corresponding 5-digit codes.



This feature requires a PK55xx or RFK55xx series keypad, v.1.1 or higher.

[900] Panel Version Displayed

Only available with LCD5500 or PK5500 keypads. The system will display the version of the control panel (e.g., [0460] indicates panel version 4.60).

[901] Installer Walk Test

The system will turn Installer Walk Test ON. The Ready, Armed and Trouble LED's will flash rapidly while the test is active. Every time a zone is violated the system will activate the bell output for two seconds and log the event to the event buffer. To turn Installer Walk Test OFF enter [901] again. The system automatically terminates the test if there is no zone activity for 15 minutes.

[902] Module Supervision Reset

All modules are automatically detected within one minute after being connected to the Keybus. Enter [902] to clear detected modules if a module is removed, if PC5108 jumpers are changed, or if a keypad's slot assignments are programmed. The system will rescan the Keybus to determine which modules are connected.

[903] View Module Supervision

The keypad will display the modules detected by the system by turning on the associated zone light (LED keypads), flashing the numbers (fixed-message LCD keypads), or displaying the modules detected in plain language (programmable LCD keypads). Refer to the chart below:

Indicator Light (Zone)	Module
[01] to [08]	Keypad in Slot #1 to #8
[09] to [14]	PC5108 Zone Expander #1 to #6
[15]	PC5100 Module
[16]	PC5108 Zone Expander #7
[17]	RF5132 Module or RFK keypad with integrated wireless receiver
[18]	PC5208
[19]	PC5204 Module
[20]	PC5400 Module
[21]	PC59xx Module
[22]	Alternate Communicator
[24]	Escort5580 or Escort5580TC
[26] to [29]	PC5200 #1 to #4

[904] Wireless Placement Test

Enter [904] followed by the 2-digit number of the wireless zone to test. When a wireless signal is received from the selected transmitter, the system will indicate the location as Good or Bad, as follows:

- Good:** One bell squawk, 1 keypad beep, keypad zone light [1] ON
- Bad:** Three bell squawks, 3 keypad beeps, keypad zone light [3] ON

Press [#] to exit when testing is complete. Enter the 2-digit zone number for the next wireless device to test or press [#] to return to standard programming.

[989] Default Master Code

Enter [989][Installer Code] to default the Master Code to the factory defaults.

[990] Installer Lockout Enable

Enter [990][Installer Code][990] to enable the Installer Lockout feature. A hardware default cannot be performed when the Installer Lockout feature is ON. In addition, the system will chatter the line seizure relay 10 times if the panel is powered up, indicating that the feature is ON.

[991] Installer Lockout Disable

Enter [991][Installer Code][991] to turn the Installer Lockout feature OFF.

[993] to [999]: Factory Default Module/Panel

The following options can be used to restore a module or the main control panel to its factory default settings. Enter the appropriate option, followed by the Installer Code, followed by the option number (e.g., [993][Installer Code][993])

- [993]: Factory Default Alternate Communicator
- [995]: Factory Default Escort 5580 Module
- [996]: Factory Default Wireless Receiver
- [997]: Factory Default PC5400 Module
- [998]: Factory Default PC59xx Module
- [999]: Factory Default Main Control Panel

Hardware Reset (Default) Main Control Panel

Perform the following to restore the main control panel to its default settings:

1. Power down the system.
2. First removing all wires between Zone 1 and PGM1 on the control panel, connect a short between them.
3. Power up the control panel (AC power only) for 10 seconds.
4. Power down the control panel, remove the short between Zone 1 and PGM1.
5. Power up the control panel.

[001]-[064] Label Programming (Zone 1-64) (applies to PK5500/RFK5500/RFK5564 only)

Zone and other labels in these sections can be customized.

Default labels are in English and do not change when an alternate language is selected.

Labels can be programmed locally or downloaded/uploaded using DLS and Connect 24 interactive software.

To program a zone label:

1. Enter the section number of the label to be programmed. e.g., [*][8][Installer Code][*][001].
2. Scroll to the desired character's location using the < > Keys.
3. Enter the number of the corresponding character group until the desired character is displayed.
Example:
Press the "2" key 3 times to enter the letter "F."
Press the "2" key 4 times to enter the number "2."
4. Press [*] to access the "Select Option" menu.
Scroll to "Save" then press [*] to save the label.

Press	To Enter/Display
[<]	Display Left (Previous character position)
Display Right (Next character position)	
[*]	[SELECT]
[#]	[ESCAPE]
[0]	[SPACE]
[1]	[A], [B], [C], [1]
[2]	[D], [E], [F], [2]
[3]	[G], [H], [I], [3]
[4]	[J], [K], [L], [4]
[5]	[M], [N], [O], [5]
[6]	[P], [Q], [R], [6]
[7]	[S], [T], [U], [7]
[8]	[V], [W], [X], [8]
[9]	[Y], [Z], [9], [0]

WORDS - This option provides access to the Label Library, a collection of words commonly used when programming labels.

ASCII ENTRY - This option is for entering uncommon characters, or as a primary method for programming labels. 255 character entries are available, although some entries are duplicated. Use the [<] [>] keys to scroll through the characters or enter a 3-digit number from 000-255. Press the [*] key to enter a character in the label.

CHANGE CASE - This option toggles the letter entry between upper case letters (A, B, C) and lower case letters (a, b, c).

CLEAR TO END - This option clears the display from the character where the cursor is located to the end of the display.

CLEAR DISPLAY - This option sets all characters in a label to "space" or cleared.

SAVE - Saves the new label. If save is not selected before leaving the label programming section, the changes are lost.

Label Library

The Label Library is a database of words commonly used when programming labels. Individual words can be combined as needed. e.g., Front + Door. Each line of the display supports a maximum of 14 characters. If a word will not fit on a line, scroll right until the cursor appears at the first character of the second line then add the word.

To program a custom label using the Label Library:

1. Enter keypad programming and select the label to change. e.g., [*][8][Installer Code][*][001] (to program the label for zone 01).
2. Press [*] to open the "Select Options" menu.
3. Press [*] again to select the "Words" option.
4. Enter the 3-digit number corresponding to a word (see Words table below) or use the scroll keys [<] [>] to view words in the library.
5. Press [*] to select the word.
6. To add another word, repeat the above procedure from step 2.
7. To add a space, press the right scroll key [>].
8. To clear characters, select "Clear to End" or "Clear Display" from the "Select Options" menu.
9. To save the current label, press [*] to access the "Select Options" menu, scroll left [<] to "Save" then press [*] again.

Words Table

Item #	Text	Item #	Text	Item #	Text	Item #	Text	Item #	Text	Item #	Text
001	Aborted	042	Control	083	Garage	124	Motion	165	Shop	206	E
002	AC	043	Date	084	Gas	125	No	166	Side	207	F
003	Access	044	Daughter's	085	Glass	126	North	167	Siren	208	G
004	Active	045	Degrees	086	Goodbye	127	Not	168	Sliding	209	H
005	Activity	046	Delay	087	Gym	128	Now	169	Smoke	210	I
006	Alarm	047	Den	088	Hallway	129	Number	170	Son's	211	J
007	All	048	Desk	089	Heat	130	Off	171	Sound	212	K
008	AM	049	Detector	090	Hello	131	Office	172	South	213	L
009	Area	050	Dining	091	Help	132	OK	173	Special	214	M
010	Arm	051	Disarmed	092	High	133	On	174	Stairs	215	N
011	Armed	052	Door	093	Home	134	Open	175	Stay	216	O
012	Arming	053	Down	094	House	135	Opening	176	Sun	217	P
013	Attic	054	Download	095	In	136	Panic	177	Supervisory	218	Q
014	Auxiliary	055	Downstairs	096	Install	137	Partition	178	System	219	R
015	Away	056	Drawer	097	Interior	138	Patio	179	Tamper	220	S
016	Baby	057	Driveway	098	Intrusion	139	Pet	180	Temperature	221	T
017	Back	058	Duct	099	Invalid	140	Phone	181	Test	222	U
018	Bar	059	Duress	100	Is	141	Please	182	Time	223	V
019	Basement	060	East	101	Key	142	PM	183	To	224	W
020	Bathroom	061	Energy Saver	102	Kids	143	Police	184	Touchpad	225	X
021	Battery	062	Enter	103	Kitchen	144	Pool	185	Trouble	226	Y
022	Bedroom	063	Entry	104	Latchkey	145	Porch	186	Unbypass	227	Z
023	Bonus	064	Error	105	Laundry	146	Power	187	Unit	228	(Space)
024	Bottom	065	Exercise	106	Left	147	Press	188	Up	229	' (Apostrophe)
025	Breezeway	066	Exit	107	Level	148	Program	189	West	230	- (Dash)
026	Building	067	Exterior	108	Library	149	Progress	190	Window	231	_ (Underscore)
027	Bus	068	Factory	109	Light	150	Quiet	191	Zone	232	*
028	Bypass	069	Failure	110	Lights	151	Rear	192	0	233	#
029	Bypassed	070	Family	111	Living	152	Receiver	193	1	234	:
030	Cabinet	071	Father's	112	Load	153	Report	194	2	235	/
031	Cancelled	072	Feature	113	Loading	154	RF	195	3	236	?
032	Car	073	Fence	114	Low	155	Right	196	4		
033	Carbon	074	Fire	115	Lower	156	Room	197	5		
034	Central	075	First	116	Main	157	Safe	198	6		
035	Chime	076	Floor	117	Master	158	Schedule	199	7		
036	Closed	077	Force	118	Mat	159	Screen	200	8		
037	Closet	078	Foyer	119	Medical	160	Second	201	9		
038	Closing	079	Freeze	120	Memory	161	Sensor	202	A		
039	Code	080	Front	121	Menu	162	Service	203	B		
040	Communicator	081	Furnace	122	Monoxide	163	Shed	204	C		
041	Computer	082	Gallery	123	Mother's	164	Shock	205	D		

Chapter 5 Programming Worksheets

5.1 Index to Programming Worksheets

Programming Option	Page	Programming Option	Page
[000] Keypad Enrollment	30	[348] Test Transmission Reporting Codes	44
[001]-[004] Zone Definitions.....	30	[349] PC5700 Maintenance Reporting Codes	44
[005] System Times	31	[350] Communicator Format Options	44
[006] Installer Code	31	[351]-[358] Alarm/Restore Communicator Call Directions.....	44
[007] Master Code	31	[359]-[366] Tamper/Restore Communicator Call Directions.....	44
[008] Maintenance Code.....	31	[367]-[374] Opening/Closing Communicator Call Directions.....	45
[009] PGM 1&2 Output Programming (Main Panel).....	32	[375] System Maintenance Communicator Call Directions	45
[010] PGM 3-10 Output Programming (Main Panel/PC5208).....	32	[376] System Test Transmissions Communicator Call Directions.....	45
[011] PGM 11-14 Output Programming (PC5204)	32	[377] Communication Variables.....	45
[012] Keypad Lockout Options	32	[378] Test Transmission Time of Day	45
[013] 1st System Options.....	33	[379] Periodic DLS Time of Day	45
[014] 2nd System Options	33	[380] 1st Communicator Options	46
[015] 3rd System Options.....	33	[381] 2nd Communicator Options.....	46
[016] 4th System Options.....	33	[382] 3rd Communicator Options.....	46
[017] 5th System Options.....	34	[383] 4th Communicator Options.....	46
[018] 6th System Options.....	34	[389] TL/GS Module Fault Check Timer	46
[019] 7th System Options.....	34	[401] DLS Downloading Option Codes	47
[020] Keypad Zone Assignments	34	[402] DLS Downloading Telephone Number (32 Digits).....	47
[021] 8th System Options.....	35	[403]-[404] DLS Downloading Access Code / Panel ID Code	47
[022] 9th System Options.....	35	[405] Answering Machine Double Call Timer.....	47
[023] 10th System Options	35	[406] Number of Rings to Answer On	47
[030] Zone Loop Response (Zones 1-8).....	35	[499] Initiate PC-Link Downloading.....	47
[101] - [164] Zone Attributes.....	36	[501]-[502] PGM 1&2 Output Attributes (Main Panel).....	48
[165] Maximum Dialing Attempts to Each Telephone Number.....	38	[503]-[504] PGM 3&4 Output Attributes (Main Panel / PC5208).....	48
[166] Post Dial Wait for Handshake (All Formats)	38	[505]-[510] PGM 5-10 Output Attributes (5208).....	48
[167] TL/GS Module Wait for Acknowledgement.....	38	[511]-[514] PGM 11-14 Output Attributes (5204)	48
[168] Set Clock Forward (Daylight Saving Time).....	39	[551]-[552] PGM 1&2 Output Partition Assignment (Main Panel).....	49
[169] Set Clock Back (Standard Time).....	39	[553]-[554] PGM 3&4 Output Partition Assignment (Main Panel/PC5208)	49
[170] PGM Output Timer	39	[555]-[560] PGM 5-10 Output Partition Assignment (5208).....	49
[171] Tamper PGM Output Timer	39	[561]-[564] PGM 11-14 Output Partition Assignment (5204).....	49
[175] Auto-Arm Postpone Timer.....	39	[601]-[604] Closing (Arming) Reporting Codes, Access Codes 33-95.....	49
[176] Cross Zone/Police Code Timer	39	[605]-[608] Opening (Disarming) Reporting Codes, Access Codes 33-95.....	50
[181]-[188] Automatic Arming Schedule.....	39	[681]-[688] Automatic Disarming Schedule	50
[190] No Activity Arming Pre-Alert Time	39	[691]-[698] Auto-Disarm Holiday Schedule	50
[191]-[198] No Activity Arming Timers	39	[700] Automatic Clock Adjust	51
[199] Auto-Arming Pre-Alert Timer	39	[701] 1st International Options.....	51
[201] Partition Selection Mask	40	[702] 2nd International Options.....	51
[202]-[265] Partition 1-8 Zone Assignment	40	[703] Delay between Dialing Attempts	51
[301] 1st Telephone Number (32 Digits).....	40	[801] PC5400 Printer Module Programming	52
[302] 2nd Telephone Number (32 Digits).....	40	[802] PC59xx VOX Programming	52
[303] 3rd Telephone Number (32 Digits).....	40	[804] Wireless Expansion Programming.....	52
[304] Call Waiting Cancel String (6 Digits)	40	[805] PC5100 Programming.....	52
[310] System Account Code	41	[851] TL/GS Programming.....	52
[311]-[318] Partition 1-8 Account Numbers.....	41	[898] Wireless Enrollment.....	52
[320]-[323] Alarm Reporting Codes, Zones 01-64.....	41	[899] Template Programming.....	52
[324]-[327] Alarm Restoral Reporting Codes, Zones 01-64.....	41	[900] Panel Version Displayed	52
[328] Miscellaneous Alarm Reporting Codes.....	42	[901] Installer Walk Test Mode Enable/Disable	52
[329] Priority Alarm and Restoral	42	[902] Module Supervision Reset	52
[330]-[333] Tamper Reporting Codes, Zones 01-64.....	42	[903] Module Supervision Field	52
[334]-[337] Tamper Restoral Reporting Codes, Zones 01-64.....	42	[904] Wireless Module Placement Test	52
[338] Miscellaneous Tamper Reporting Codes	43	[989] Default Master Code	52
[339]-[340] Closing (Arming) Reporting Codes, Access Codes 1-32.....	43	[990] Installer Lockout Enable	52
[341] Miscellaneous Closing (Arming) Reporting Codes	43	[991] Installer Lockout Disable.....	52
[342]-[343] Opening (Disarming) Reporting Codes, Access Codes 1-32.....	43	[993] Restore Alternate Communicator to Default Programming	52
[344] Miscellaneous Opening (Disarming) Reporting Codes	43	[995] Restore Escort5580 to Default Programming	52
[345] Maintenance Alarm Reporting Codes.....	43	[996] Restore RF5132 to Default Programming	52
[346] Maintenance Restoral Reporting Codes	43	[997] Restore PC5400 to Default Programming	52
[347] Miscellaneous Maintenance Reporting Codes.....	44	[998] Restore PC59xx to Default Programming	52
		[999] Restore Control Panel to Default Programming	52

Programming Worksheets

f *Shaded programming sections indicate minimum programming requirements*

f *The defaults for SIA FAR CP-01 are indicated in gray text.*

Keypad Partition /Slot and Function Key Programming

[000] Keypad Enrollment

f *This must be done at each keypad requiring programming.*

[0] Slot address (For the partition, 0-8; for the slot, 1-8. For example, to enroll a keypad in partition 3, slot 1, enter (31).)

[1] Function Key 1 Assignment (Valid entries are 00-32)

[2] Function Key 2 Assignment (Valid entries are 00-32)

[3] Function Key 3 Assignment (Valid entries are 00-32)

[4] Function Key 4 Assignment (Valid entries are 00-32)

[5] Function Key 5 Assignment (Valid entries are 00-32)

Function Key Options (enter these values below in the table immediately following):

00 Not used	12 [*][6] User Functions	24 Recall Bypass Group
01 Select Partition 1	13 Command Output #1 [*][7][1]	25 For Future Use
02 Select Partition 2	14 Command Output #2 [*][7][2]/Sensor Reset	26 Time and Date
03 Stay Arm	15 Global Stay Arming	27 Select Partition 3
04 Away Arm	16 [*][0] Quick Exit	28 Select Partition 4
05 [*][9] No-Entry Arm	17 [*][1] Reactivate Stay/Away Zones	29 Select Partition 5
06 [*][4] Chime On / Off	18 Global Away Arming	30 Select Partition 6
07 [*][6][—][4] System Test	19 Command Output 3 [*][7][3]	31 Select Partition 7
08 [*][1] Bypass Mode	20 For Future Use	32 Select Partition 8
09 [*][2] Trouble Display	21 Command Output 4 [*][7][4]	33 For Future Use
10 [*][3] Alarm Memory	22 Global Disarming	
11 [*][5] Access Code Programming	23 Bypass Recall	

	Partition/Slot	[20] Zone Assigned	Key 1	Key 2	Key 3	Key 4	Key 5
ICON / LED Defaults	11	00	03	04	06	14	16
Full Message Defaults	18	00	03	04	06	14	16
KEYPAD 1		00					
KEYPAD 2		00					
KEYPAD 3		00					
KEYPAD 4		00					
KEYPAD 5		00					
KEYPAD 6		00					
KEYPAD 7		00					
KEYPAD 8		00					

[001]-[004] Zone Definitions (enter the values below in the table immediately following):

00 Null Zone (Not Used)	13 24-hr Gas*	26 24-hr Non-alarm*
01 Delay 1*	14 24-hr Heating*	29 Auto-Verified Fire
02 Delay 2*	15 24-hr Auxiliary (Medical)*	30 Fire Supervisory
03 Instant*	16 24-hr Panic*	31 Day Zone*
04 Interior*	17 24-hr Emergency*	32 Instant Stay/Away*
05 Interior, Stay/Away*	18 24-hr Sprinkler*	35 24-hr Bell/Buzzer
06 Delay, Stay/Away*	19 24-hr Water*	36 24-hr Non-Latching Tamper Zone
07 Delayed 24-hr Fire (Hardwired)**	20 24-hr Freeze*	37 Night Zone
08 Standard 24-hr Fire (Hardwired)	21 24-hr Latching Tamper*	39 For Future Use
09 24-hr Supervisory	22 Momentary Keyswitch Arm*	41 24-hr Carbon Monoxide (hardwired)
10 24-hr Supervisory Buzzer*	23 Maintained Keyswitch Arm*	81 24-hr Wireless Carbon Monoxide
11 24-hr Burglary*	24 For Future Use	87 Delay 24-hr Fire (Wireless/Addressable)**
12 24-hr Holdup*	25 Interior/Delay*	88 Standard 24-hr Fire (Wireless/Addressable)**

*For burglary applications only ** For residential fire applications only

Section	Zone	Def.		Section	Zone	Def.		Section	Zone	Def.		Section	Zone	Def.	
[001]	01	01	_ _	[002]	17	00	_ _	[003]	33	00	_ _	[004]	49	00	_ _
	02	03	_ _		18	00	_ _		34	00	_ _		50	00	_ _
	03	03	_ _		19	00	_ _		35	00	_ _		51	00	_ _
	04	03	_ _		20	00	_ _		36	00	_ _		52	00	_ _
	05	04	_ _		21	00	_ _		37	00	_ _		53	00	_ _
	06	04	_ _		22	00	_ _		38	00	_ _		54	00	_ _
	07	04	_ _		23	00	_ _		39	00	_ _		55	00	_ _
	08	04	_ _		24	00	_ _		40	00	_ _		56	00	_ _
	09	00	_ _		25	00	_ _		41	00	_ _		57	00	_ _
	10	00	_ _		26	00	_ _		42	00	_ _		58	00	_ _
	11	00	_ _		27	00	_ _		43	00	_ _		59	00	_ _
	12	00	_ _		28	00	_ _		44	00	_ _		60	00	_ _
	13	00	_ _		29	00	_ _		45	00	_ _		61	00	_ _
	14	00	_ _		30	00	_ _		46	00	_ _		62	00	_ _
	15	00	_ _		31	00	_ _		47	00	_ _		63	00	_ _
	16	00	_ _		32	00	_ _		48	00	_ _		64	00	_ _

[005] System Times

Valid entries for Entry Delay are 030-255; valid entries for Exit Delay are 045-255 for SIA CP-01.

[01] Partition 1 Entry/Exit times

030 |_|_|_| Entry Delay 1
 045 |_0_|_3_|_0_| Entry Delay 2
 120 |_0_|_6_|_0_| Exit Delay

[05] Partition 5 Entry/Exit times

030 |_|_|_| Entry Delay 1
 045 |_0_|_3_|_0_| Entry Delay 2
 120 |_0_|_6_|_0_| Exit Delay

[02] Partition 2 Entry/Exit times

030 |_|_|_| Entry Delay 1
 045 |_0_|_3_|_0_| Entry Delay 2
 120 |_0_|_6_|_0_| Exit Delay

[06] Partition 6 Entry/Exit times

030 |_|_|_| Entry Delay 1
 045 |_0_|_3_|_0_| Entry Delay 2
 120 |_0_|_6_|_0_| Exit Delay

[03] Partition 3 Entry/Exit times

030 |_|_|_| Entry Delay 1
 045 |_0_|_3_|_0_| Entry Delay 2
 120 |_0_|_6_|_0_| Exit Delay

[07] Partition 7 Entry/Exit times

030 |_|_|_| Entry Delay 1
 045 |_0_|_3_|_0_| Entry Delay 2
 120 |_0_|_6_|_0_| Exit Delay

[04] Partition 4 Entry/Exit times

030 |_|_|_| Entry Delay 1
 045 |_0_|_3_|_0_| Entry Delay 2
 120 |_0_|_6_|_0_| Exit Delay

[08] Partition 8 Entry/Exit times

030 |_|_|_| Entry Delay 1
 045 |_0_|_3_|_0_| Entry Delay 2
 120 |_0_|_6_|_0_| Exit Delay

[09] Bell Cut-Off Timer (All Partitions)

004 |_|_|_| Enter 3 digits from 001-255

i For SIA CP-01 compliant installations, the Exit Delay must be within the range of 045-255 seconds (Default 60 seconds). If the Exit Delay is silent (Section 14, Option 6 or Stay Function Key Arming), the exit delay must be twice the programmed value. It cannot, however, exceed 255 seconds (i.e., 090-255 seconds).

i For UL Installations, the Entry Delay plus the Communications Delay must not exceed 60 seconds.

i Exit Time Restart shall be disabled when the panel is used in combination with T-Link TL250/TL300.

[006] Installer's Code

Default
 5555 |_|_|_|_|

[007] Master Code

Default
 1234 |_|_|_|_|

[008] Maintenance Code

Default
 AAAA |_|_|_|_|

[007] Master Code

The master code can be restored to default in section [989] Default Master Code.

Programmable Output Options

- | | | |
|--|---|--|
| 01 Residential Burglary and Fire Bell Output | 18 Stay Armed Status | 36 Zone Follower Output (Zones 17-24) |
| 02 For Future Use | 19 Command Output #1 ([*][7][1]) | 37 Zone Follower Output (Zones 25-32) |
| 03 Sensor Reset ([*][7][2]) | 20 Command Output #2 ([*][7][2]) | 38 Zone Follower Output (Zones 33-40) |
| 04 2-Wire Smoke Support (PGM 2 only) | 21 Command Output #3 ([*][7][3]) | 39 Zone Follower Output (Zones 41-48) |
| 05 System Armed Status | 22 Command Output #4 ([*][7][4]) | 40 Zone Follower Output (Zones 49-56) |
| 06 Ready To Arm | 23 24-hr Silent Input (PGM 2 only) | 41 Zone Follower Output (Zones 57-64) |
| 07 Keypad Buzzer Follow Mode | 24 24-hr Audible Input (PGM 2 only) | |
| 08 Courtesy Pulse | 25 Delayed Fire and Burglary Output | |
| 09 System Trouble Output (with Trouble options) | 26 Battery Test Output | |
| 10 System Event (Strobe with Event options) | 28 Holdup Output | |
| 11 System Tamper (all sources) | 29 Zone Follower Output (Zones 1-8) | |
| 12 TLM and Alarm | 30 Partition Status Alarm Memory | |
| 13 Kissoff Output | 31 Alternate Communicator | |
| 14 Ground Start Pulse | 32 For Future Use | |
| 15 Remote Operation (DLS Support) | 33 For Future Use | |
| 16 For Future Use | 34 Away Armed with no Zone Bypassed Status | |
| 17 Away Armed Status | 35 Zone Follower Output (Zones 9-16) | |

Output types [03], [04] and [20] cannot be used together on the same system.

[009] PGM1 and PGM2 Output Programming (Main Panel)

i Program PGM Option Attributes in sections [501] - [514]. Program PGM partitions in sections [551] - [564].

i PC1616 and PC1832 have 2 onboard PGMs (PGM 1 and 2). PC1864 has 4 on-board PGMs (PGM 1-4).

Default	Default
19 <input type="text"/> <input type="text"/> PGM 1	10 <input type="text"/> <input type="text"/> PGM 2

[010] PGM3 to PGM10 Output Programming (Main Panel/PC5208)

i Program PGM Option Attributes in sections [501] - [514]. Program PGM partitions in sections [551] - [564]

Default	Default
01 <input type="text"/> <input type="text"/> PGM 3 (main panel/PC5208)*	01 <input type="text"/> <input type="text"/> PGM 7 (PC5208)
01 <input type="text"/> <input type="text"/> PGM 4 (main panel/PC5208)*	01 <input type="text"/> <input type="text"/> PGM 8 (PC5208)
01 <input type="text"/> <input type="text"/> PGM 5 (PC5208)	01 <input type="text"/> <input type="text"/> PGM 9 (PC5208)
01 <input type="text"/> <input type="text"/> PGM 6 (PC5208)	01 <input type="text"/> <input type="text"/> PGM 10 (PC5208)

These two sections above allow you to program both PGM3 and PGM4 on the main panel, and the first two PGM outputs on the PC5208. If you use both the main panel and the PC5208 outputs, PGM3 will work identically to the first PC5208 output, and PGM4 will work identically to the second PC5208 output.

[011] PGM 11 to PGM 14 Output Programming (PC5204)

i Program PGM Option Attributes in sections [501] - [514]. Program PGM partitions in sections [551] - [564]

Default	Default
01 <input type="text"/> <input type="text"/> PGM 11	01 <input type="text"/> <input type="text"/> PGM 13
01 <input type="text"/> <input type="text"/> PGM 12	01 <input type="text"/> <input type="text"/> PGM 14

Other System Options

[012] Keypad Lockout Options

i If Keypad Lockout is active, the panel cannot be disarmed with a keyswitch.

Default

000 Number of Invalid Codes Before Lockout (001-255 codes, 000 to disable)

000 Lockout Duration (000-255 minutes)

[013] First System Options

Opt	Def	ON	OFF
1	<input type="checkbox"/>	Normally Closed Loops	✓ <input type="checkbox"/> End-of-Line Resistors
2	<input type="checkbox"/>	Double End-of-Line Resistors	✓ <input type="checkbox"/> Single End-of-Line Resistors
3	✓ <input type="checkbox"/>	Panel shows all Troubles when armed	<input type="checkbox"/> Panel shows only Fire Troubles when armed
4	<input type="checkbox"/>	Tampers/Faults do not show as open	✓ <input type="checkbox"/> Tampers/Faults show as open
5	✓ <input type="checkbox"/>	Auto-Arm Schedule in [*][6] and installers	<input type="checkbox"/> Auto-arm Schedule in Installer Programming Only
6	✓ <input type="checkbox"/>	Audible Exit Fault Enabled	<input type="checkbox"/> Audible Exit Fault Disabled
7	✓ <input type="checkbox"/>	Event Buffer Follows Swinger Shutdown	<input type="checkbox"/> Event Buffer Logs Events past Shutdown
8	<input type="checkbox"/>	Temporal Three Fire Signal Enabled	✓ <input type="checkbox"/> Standard Pulsed Fire Signal

[014] Second System Options

Opt	Def	ON	OFF
1	<input type="checkbox"/>	Arm /Disarm Bell Squawk Enabled	✓ <input type="checkbox"/> Arm /Disarm Bell Squawk Disabled
2	<input type="checkbox"/>	Bell Squawk During Auto-Arm	✓ <input type="checkbox"/> No Bell Squawk During Auto-Arm
3	<input type="checkbox"/>	Bell Squawk On Exit Delay	✓ <input type="checkbox"/> No Bell Squawk On Exit Delay
4	<input type="checkbox"/>	Bell Squawk On Entry Delay	✓ <input type="checkbox"/> No Bell Squawk On Entry Delay
5	<input type="checkbox"/>	Bell Squawk On Trouble	✓ <input type="checkbox"/> No Bell Squawk On Trouble
6	✓ <input type="checkbox"/>	Audible Exit with Urgency	<input type="checkbox"/> Silent Exit Delay
7	<input type="checkbox"/>	Exit Delay Termination Enabled	✓ <input type="checkbox"/> Exit Delay Termination Disabled
8	<input type="checkbox"/>	Residential Fire Bell is Continuous	✓ <input type="checkbox"/> Residential Fire Bell is Cut-off

[015] Third System Options

Opt	Def	ON	OFF
1	✓ <input type="checkbox"/>	Fire Key Enabled	<input type="checkbox"/> Fire Key Disabled
2	<input type="checkbox"/>	Panic Key Audible (Bell / Beeps)	✓ <input type="checkbox"/> Panic Key Silent
3	<input type="checkbox"/>	Quick Exit Enabled (ON for SIA CP-01)	✓ <input type="checkbox"/> Quick Exit Disabled
4	✓ <input type="checkbox"/>	Quick Arming Enabled (No Code Required)	<input type="checkbox"/> Quick Arming Disabled (Code Required)
5	<input type="checkbox"/>	Code Required for Bypassing	✓ <input type="checkbox"/> Code Not Required for Bypassing
6	<input type="checkbox"/>	Master Code NOT Changeable	✓ <input type="checkbox"/> Master Code Changeable
7	✓ <input type="checkbox"/>	TLM Enabled	<input type="checkbox"/> TLM Disabled
8	<input type="checkbox"/>	TLM Audible (Bell) when Armed	✓ <input type="checkbox"/> TLM Trouble Beeps when Armed

[016] Fourth System Options

Opt	Def	ON	OFF
1	✓ <input type="checkbox"/>	AC Trouble Displayed	<input type="checkbox"/> AC Trouble Not Displayed
2	<input type="checkbox"/>	Trouble Light Flashes if AC Fails	✓ <input type="checkbox"/> Trouble Light does NOT follow AC Status
3	<input type="checkbox"/>	Blank Keypad when Not Used	✓ <input type="checkbox"/> Keypad Blanking Disabled
4	<input type="checkbox"/>	Code required to remove Keypad Blanking	✓ <input type="checkbox"/> No Code Required
5	✓ <input type="checkbox"/>	Keypad Backlighting is Enabled	<input type="checkbox"/> Keypad Backlighting is Disabled
6	<input type="checkbox"/>	Power Save Mode Enabled	✓ <input type="checkbox"/> Power Save Mode Disabled
7	<input type="checkbox"/>	Bypass Status Displayed While Armed	✓ <input type="checkbox"/> Bypass Status Not Displayed While Armed
8	<input type="checkbox"/>	Keypad Tampers Enabled	✓ <input type="checkbox"/> Keypad Tampers Disabled

[017] Fifth System Options

Opt	Def	ON	OFF
1	✓	<input type="checkbox"/> WLS Key Does Not use Access Codes	<input type="checkbox"/> WLS Key Uses Access Codes
2		<input type="checkbox"/> RF Jam Log after 5 Minutes	✓ <input type="checkbox"/> RF Jam Log after 30 Seconds
3		<input type="checkbox"/> Audible RF Jam Trouble Beeps	✓ <input type="checkbox"/> Silent RF Jam Trouble Beeps
4		<input type="checkbox"/> Double Hit Enabled	✓ <input type="checkbox"/> Double Hit Disabled
5		<input type="checkbox"/> Late to Close Enabled	✓ <input type="checkbox"/> Late to Close Disabled
6		<input type="checkbox"/> Daylight Saving Time Enabled	✓ <input type="checkbox"/> Daylight Saving Time Disabled
7		<input type="checkbox"/> For Future Use	✓ <input type="checkbox"/>
8		<input type="checkbox"/> Squawk on Away Key Arming/Disarming Only	✓ <input type="checkbox"/> Squawk on all Arming/Disarming

[018] Sixth System Options

Opt	Def	ON	OFF
1		<input type="checkbox"/> Test Transmission Exception Enabled	✓ <input type="checkbox"/> Test Transmission Exception Disabled
2		<input type="checkbox"/> For Future Use	✓ <input type="checkbox"/>
3		<input type="checkbox"/> For Future Use	✓ <input type="checkbox"/>
4		<input type="checkbox"/> For Future Use	✓ <input type="checkbox"/>
5		<input type="checkbox"/> Keypad Buzzer Follows Bell Enabled	✓ <input type="checkbox"/> Keypad Buzzer Follows Bell Disabled
6		<input type="checkbox"/> Cross Zoning Enabled	✓ <input type="checkbox"/> Police Code Enabled
7		<input type="checkbox"/> Exit Delay Restart Enabled (Enabled for SIA CP-01)	✓ <input type="checkbox"/> Exit Delay Restart Disabled
8		<input type="checkbox"/> AC Trouble Beeps Enabled	✓ <input type="checkbox"/> AC Trouble Beeps Disabled

[019] Seventh System Options

Opt	Def	ON	OFF
1		<input type="checkbox"/> For Future Use	✓ <input type="checkbox"/>
2		<input type="checkbox"/> For Future Use	✓ <input type="checkbox"/>
3		<input type="checkbox"/> First Zone in Alarm Enabled	✓ <input type="checkbox"/> First Zone in Alarm Disabled
4		<input type="checkbox"/> For Future Use	✓ <input type="checkbox"/>
5		<input type="checkbox"/> For Future Use	✓ <input type="checkbox"/>
6		<input type="checkbox"/> Green Keypad LED Power Indication	✓ <input type="checkbox"/> Ready Indication
7		<input type="checkbox"/> [*][6] Accessible by All Users	✓ <input type="checkbox"/> Master Code Only
8		<input type="checkbox"/> For Future Use	✓ <input type="checkbox"/>

Keypad Zone Assignments

[020] Keypad Zone Assignments

i Only one keypad may be assigned to a zone.

Default

00	<input type="text"/>	Keypad (slot 1) Zone
00	<input type="text"/>	Keypad (slot 2) Zone
00	<input type="text"/>	Keypad (slot 3) Zone
00	<input type="text"/>	Keypad (slot 4) Zone
00	<input type="text"/>	Keypad (slot 5) Zone
00	<input type="text"/>	Keypad (slot 6) Zone
00	<input type="text"/>	Keypad (slot 7) Zone
00	<input type="text"/>	Keypad (slot 8) Zone

Only one keypad may be assigned to a slot. Only one zone can be assigned to a keypad. Valid entries are from 01 to 64.

[021] Eighth System Options

Opt	Def	ON	OFF
1	<input type="checkbox"/>	Access Code Entry Blocked During Entry Delay	✓ <input type="checkbox"/> Access Code Entry Not Blocked During Entry Delay
2	<input type="checkbox"/>	For Future Use	✓ <input type="checkbox"/>
3	<input type="checkbox"/>	For Future Use	✓ <input type="checkbox"/>
4	<input type="checkbox"/>	For Future Use	✓ <input type="checkbox"/>
5	<input type="checkbox"/>	For Future Use	✓ <input type="checkbox"/>
6	<input type="checkbox"/>	Keyswitch Disarming During Entry Delay Only	✓ <input type="checkbox"/> Keyswitch Disarming at Any Time
7	<input type="checkbox"/>	For Future Use	✓ <input type="checkbox"/>
8	<input type="checkbox"/>	For Future Use	✓ <input type="checkbox"/>

[022] Ninth System Options

Opt	Def	ON	OFF
1	<input type="checkbox"/>	Access Code Req'd for [*][1], [*][2], [*][3]	✓ <input type="checkbox"/> No Access Code Req'd for [*][1], [*][2], [*][3]
2	<input type="checkbox"/>	For Future Use	✓ <input type="checkbox"/>
3	<input type="checkbox"/>	For Future Use	✓ <input type="checkbox"/>
4	<input type="checkbox"/>	Master Code Bypasses Holdup Zones Only	✓ <input type="checkbox"/> Any Code Bypasses Holdup Zones
5	<input type="checkbox"/>	For Future Use	✓ <input type="checkbox"/>
6	<input type="checkbox"/>	RF Delinquency enabled	✓ <input type="checkbox"/> RF Delinquency disabled
7	<input type="checkbox"/>	For Future Use	✓ <input type="checkbox"/>
8	<input type="checkbox"/>	Audible Exit Delay for Stay Arming	✓ <input type="checkbox"/> Stay Arming Silent

[023] Tenth System Options

Opt	Def	ON	OFF
1	<input type="checkbox"/>	Fire Key Beeps Only	✓ <input type="checkbox"/> Fire Key Beeps and Sounds Bell
2	<input type="checkbox"/>	For Future Use	✓ <input type="checkbox"/>
3	<input type="checkbox"/>	Test Transmission While Armed Only	✓ <input type="checkbox"/> Test Transmission While Armed/Disarmed
4	<input type="checkbox"/>	Test Transmission in Hours	✓ <input type="checkbox"/> Test Transmission in Days
5	<input type="checkbox"/>	Switching from AWAY to STAY disabled	✓ <input type="checkbox"/> AWAY to STAY toggle Option Permitted
6	<input type="checkbox"/>	2-way Audio will Not Disconnect for a New Event	✓ <input type="checkbox"/> 2-way Audio will Disconnect for a New Event
7	<input type="checkbox"/>	Trouble Beeps are Silent*	✓ <input type="checkbox"/> Trouble Beeps sound every 10 seconds
8	<input type="checkbox"/>	Keyswitch Arm in Away Mode	✓ <input type="checkbox"/> Keyswitch arms in STAY or AWAY

* This option must be off for UL residential fire applications

[030] Zone Loop Response (Zones 1-8)

Opt	Def	ON	OFF
1	<input type="checkbox"/>	Zone 1 is Fast Loop Response	✓ <input type="checkbox"/> Zone 1 is Normal Loop Response
2	<input type="checkbox"/>	Zone 2 is Fast Loop Response	✓ <input type="checkbox"/> Zone 2 is Normal Loop Response
3	<input type="checkbox"/>	Zone 3 is Fast Loop Response	✓ <input type="checkbox"/> Zone 3 is Normal Loop Response
4	<input type="checkbox"/>	Zone 4 is Fast Loop Response	✓ <input type="checkbox"/> Zone 4 is Normal Loop Response
5	<input type="checkbox"/>	Zone 5 is Fast Loop Response	✓ <input type="checkbox"/> Zone 5 is Normal Loop Response
6	<input type="checkbox"/>	Zone 6 is Fast Loop Response	✓ <input type="checkbox"/> Zone 6 is Normal Loop Response
7	<input type="checkbox"/>	Zone 7 is Fast Loop Response	✓ <input type="checkbox"/> Zone 7 is Normal Loop Response
8	<input type="checkbox"/>	Zone 8 is Fast Loop Response	✓ <input type="checkbox"/> Zone 8 is Normal Loop Response

[101]-[164] Zone Attributes

Zone Attribute Defaults (Y = Option ON; N = Option OFF): Bold entries are opposite for SIA CP-01

Attribute:	1	2	3	4	5	6	7	8	9
	Audible Silent	Steady Pulsed	Chime No	Bypass No	Force* No	Swing No	Tx. Delay No	Wireless Zn No	Cross Zn No
Zone Type:									
00 Null Zone	N	N	N	N	N	N	N	N	N
01 Delay 1	Y	Y	Y	Y	N	Y	N	N	N
02 Delay 2	Y	Y	Y	Y	N	Y	N	N	N
03 Instant	Y	Y	Y	Y	N	Y	N	N	N
04 Interior	Y	Y	N	Y	N	Y	N	N	N
05 Int. Stay/Away	Y	Y	N	Y	Y	Y	N	N	N
06 Dly. Stay/Away	Y	Y	N	Y	Y	Y	N	N	N
07 Dly. 24hr Fire (Hardw.)	Y	N	N	N	N	N	N	N	N
08 Stand. 24hr Fire (Hardw.)	Y	N	N	N	N	N	N	N	N
09 24hr Superv.	N	Y	N	N	Y	N	N	N	N
10 24hr Superv. Buzzer	N	Y	N	Y	N	N	N	N	N
11 24hr Burglary	Y	Y	N	Y	N	N	N	N	N
12 24hr Holdup	N	Y	N	N	N	N	N	N	N
13 24hr Gas	Y	N	N	N	N	N	N	N	N
14 24hr Heating	Y	N	N	N	N	N	N	N	N
15 24hr Auxiliary (Medical)	Y	Y	N	N	N	N	N	N	N
16 24hr Panic	Y	Y	N	N	N	N	N	N	N
17 24hr Emergency	Y	Y	N	N	N	N	N	N	N
18 24hr Sprinkler	Y	Y	N	N	N	N	N	N	N
19 24hr Water	Y	Y	N	N	N	N	N	N	N
20 24hr Freeze	Y	Y	N	N	N	N	N	N	N
21 24hr Latching Tamper	Y	Y	N	N	N	N	N	N	N
22 Momentary Keypress	N	N	N	N	Y	N	N	N	N
23 Maintained Keypress	N	N	N	N	Y	N	N	N	N
25 Interior/Delay	Y	Y	N	Y	N	Y	N	N	N
26 24hr Non-alarm	N	N	N	N	Y	N	N	N	N
29 Auto Verified Fire	Y	N	N	N	N	N	N	N	N
30 Fire Supervisory	N	N	N	N	N	N	N	N	N
31 Day Zone	Y	Y	N	Y	Y	Y	Y	N	N
32 Instant Stay/Away	Y	Y	N	Y	N	N	N	N	N
35 24 hr Bell/Buzzer	Y	Y	N	Y	N	Y	N	N	N
36 24hr Non Latching Tamper	N	Y	N	N	N	Y	N	N	N
37 Night Zone	Y	Y	N	Y	Y	Y	N	N	N
41 24hr Carbon Monoxide	Y	N	N	N	N	N	N	N	N
81 24hr Carbon Monoxide (WLS)	Y	N	N	N	N	N	N	Y	N
87 Dly. 24hr Fire (Wireless)	Y	N	N	N	N	N	N	Y	N
88 Stand. 24hr Fire (Wireless)	Y	N	N	N	N	N	N	Y	N

f * For UL installations, do not change attribute 5 (Force Arming) from the default setting.

Attribute:	10	11	12	13	14	15	16
	Zone Attributes 10-13 For Future Use				NC Loops Config.	SEOL Config.	DEOL Config.
Zone Type:							
00 Null Zone	N	N	N	N	N	N	N
01 Delay 1	N	N	N	N	N	N	N
02 Delay 2	N	N	N	N	N	N	N
03 Instant	N	N	N	N	N	N	N
04 Interior	N	N	N	N	N	N	N
05 Int. Stay/Away	N	N	N	N	N	N	N
06 Dly. Stay/Away	N	N	N	N	N	N	N
07 Dly. 24hr Fire (Hardw.)	N	N	N	N	N	Y	N
08 Stand. 24hr Fire (Hardw.)	N	N	N	N	N	Y	N
09 24hr Superv.	N	N	N	N	N	N	N
10 24hr Superv. Buzzer	N	N	N	N	N	N	N
11 24hr Burglary	N	N	N	N	N	N	N
12 24hr Holdup	N	N	N	N	N	N	N
13 24hr Gas	N	N	N	N	N	N	N
14 24hr Heating	N	N	N	N	N	N	N
15 24hr Medical	N	N	N	N	N	N	N
16 24hr Panic	N	N	N	N	N	N	N
17 24hr Emergency	N	N	N	N	N	N	N
18 24hr Sprinkler	N	N	N	N	N	N	N

Attribute:	10	11	12	13	14	15	16
	Zone Attributes 10-13 For Future Use				NC Loops	SEOL	DEOL
	ON				Config.	Config.	Config.
OFF							
19 24hr Water	N	N	N	N	N	N	N
20 24hr Freeze	N	N	N	N	N	N	N
21 24hr Latching Tamper	N	N	N	N	N	N	N
22 Momentary Keyswitch	N	N	N	N	N	N	N
23 Maintained Keyswitch	N	N	N	N	N	N	N
25 Interior Delay	N	N	N	N	N	N	N
26 24hr Non-alarm	N	N	N	N	N	N	N
29 Auto Verified Fire	N	N	N	N	N	N	N
30 Fire Supervisory	N	N	N	N	N	N	N
31 Day Zone	N	N	N	N	N	N	N
32 Instant Stay/Away	N	N	N	N	N	N	N
35 24hr Bell/Buzzer	N	N	N	N	N	N	N
36 24hr Non Latching Tamper	N	N	N	N	N	N	N
37 Night Zone	N	N	N	N	N	N	N
41 24hr Carbon Monoxide	N	N	N	N	N	Y	N
81 24hr Carbon Monoxide (Wireless)	N	N	N	N	N	N	N
87 Dly. 24hr Fire (Wireless)	N	N	N	N	N	N	N
88 Stand. 24hr Fire (Wireless)	N	N	N	N	N	N	N

Section	Zone #	Zone Type**	Audible/ Silent 1	Steady/ Pulsed 2	Chime No 3	Bypass No 4	Force* No 5	Swing No 6	Tx. Delay No 7	Wireless No 8	Cross Zn No 9
[101]	01	()	<input type="checkbox"/>	<input type="checkbox"/>	<input type="checkbox"/>	<input type="checkbox"/>	<input type="checkbox"/>	<input type="checkbox"/>	<input type="checkbox"/>	<input type="checkbox"/>	<input type="checkbox"/>
[102]	02	()	<input type="checkbox"/>	<input type="checkbox"/>	<input type="checkbox"/>	<input type="checkbox"/>	<input type="checkbox"/>	<input type="checkbox"/>	<input type="checkbox"/>	<input type="checkbox"/>	<input type="checkbox"/>
[103]	03	()	<input type="checkbox"/>	<input type="checkbox"/>	<input type="checkbox"/>	<input type="checkbox"/>	<input type="checkbox"/>	<input type="checkbox"/>	<input type="checkbox"/>	<input type="checkbox"/>	<input type="checkbox"/>
[104]	04	()	<input type="checkbox"/>	<input type="checkbox"/>	<input type="checkbox"/>	<input type="checkbox"/>	<input type="checkbox"/>	<input type="checkbox"/>	<input type="checkbox"/>	<input type="checkbox"/>	<input type="checkbox"/>
[105]	05	()	<input type="checkbox"/>	<input type="checkbox"/>	<input type="checkbox"/>	<input type="checkbox"/>	<input type="checkbox"/>	<input type="checkbox"/>	<input type="checkbox"/>	<input type="checkbox"/>	<input type="checkbox"/>
[106]	06	()	<input type="checkbox"/>	<input type="checkbox"/>	<input type="checkbox"/>	<input type="checkbox"/>	<input type="checkbox"/>	<input type="checkbox"/>	<input type="checkbox"/>	<input type="checkbox"/>	<input type="checkbox"/>
[107]	07	()	<input type="checkbox"/>	<input type="checkbox"/>	<input type="checkbox"/>	<input type="checkbox"/>	<input type="checkbox"/>	<input type="checkbox"/>	<input type="checkbox"/>	<input type="checkbox"/>	<input type="checkbox"/>
[108]	08	()	<input type="checkbox"/>	<input type="checkbox"/>	<input type="checkbox"/>	<input type="checkbox"/>	<input type="checkbox"/>	<input type="checkbox"/>	<input type="checkbox"/>	<input type="checkbox"/>	<input type="checkbox"/>
[109]	09	()	<input type="checkbox"/>	<input type="checkbox"/>	<input type="checkbox"/>	<input type="checkbox"/>	<input type="checkbox"/>	<input type="checkbox"/>	<input type="checkbox"/>	<input type="checkbox"/>	<input type="checkbox"/>
[110]	10	()	<input type="checkbox"/>	<input type="checkbox"/>	<input type="checkbox"/>	<input type="checkbox"/>	<input type="checkbox"/>	<input type="checkbox"/>	<input type="checkbox"/>	<input type="checkbox"/>	<input type="checkbox"/>
[111]	11	()	<input type="checkbox"/>	<input type="checkbox"/>	<input type="checkbox"/>	<input type="checkbox"/>	<input type="checkbox"/>	<input type="checkbox"/>	<input type="checkbox"/>	<input type="checkbox"/>	<input type="checkbox"/>
[112]	12	()	<input type="checkbox"/>	<input type="checkbox"/>	<input type="checkbox"/>	<input type="checkbox"/>	<input type="checkbox"/>	<input type="checkbox"/>	<input type="checkbox"/>	<input type="checkbox"/>	<input type="checkbox"/>
[113]	13	()	<input type="checkbox"/>	<input type="checkbox"/>	<input type="checkbox"/>	<input type="checkbox"/>	<input type="checkbox"/>	<input type="checkbox"/>	<input type="checkbox"/>	<input type="checkbox"/>	<input type="checkbox"/>
[114]	14	()	<input type="checkbox"/>	<input type="checkbox"/>	<input type="checkbox"/>	<input type="checkbox"/>	<input type="checkbox"/>	<input type="checkbox"/>	<input type="checkbox"/>	<input type="checkbox"/>	<input type="checkbox"/>
[115]	15	()	<input type="checkbox"/>	<input type="checkbox"/>	<input type="checkbox"/>	<input type="checkbox"/>	<input type="checkbox"/>	<input type="checkbox"/>	<input type="checkbox"/>	<input type="checkbox"/>	<input type="checkbox"/>
[116]	16	()	<input type="checkbox"/>	<input type="checkbox"/>	<input type="checkbox"/>	<input type="checkbox"/>	<input type="checkbox"/>	<input type="checkbox"/>	<input type="checkbox"/>	<input type="checkbox"/>	<input type="checkbox"/>
[117]	17	()	<input type="checkbox"/>	<input type="checkbox"/>	<input type="checkbox"/>	<input type="checkbox"/>	<input type="checkbox"/>	<input type="checkbox"/>	<input type="checkbox"/>	<input type="checkbox"/>	<input type="checkbox"/>
[118]	18	()	<input type="checkbox"/>	<input type="checkbox"/>	<input type="checkbox"/>	<input type="checkbox"/>	<input type="checkbox"/>	<input type="checkbox"/>	<input type="checkbox"/>	<input type="checkbox"/>	<input type="checkbox"/>
[119]	19	()	<input type="checkbox"/>	<input type="checkbox"/>	<input type="checkbox"/>	<input type="checkbox"/>	<input type="checkbox"/>	<input type="checkbox"/>	<input type="checkbox"/>	<input type="checkbox"/>	<input type="checkbox"/>
[120]	20	()	<input type="checkbox"/>	<input type="checkbox"/>	<input type="checkbox"/>	<input type="checkbox"/>	<input type="checkbox"/>	<input type="checkbox"/>	<input type="checkbox"/>	<input type="checkbox"/>	<input type="checkbox"/>
[121]	21	()	<input type="checkbox"/>	<input type="checkbox"/>	<input type="checkbox"/>	<input type="checkbox"/>	<input type="checkbox"/>	<input type="checkbox"/>	<input type="checkbox"/>	<input type="checkbox"/>	<input type="checkbox"/>
[122]	22	()	<input type="checkbox"/>	<input type="checkbox"/>	<input type="checkbox"/>	<input type="checkbox"/>	<input type="checkbox"/>	<input type="checkbox"/>	<input type="checkbox"/>	<input type="checkbox"/>	<input type="checkbox"/>
[123]	23	()	<input type="checkbox"/>	<input type="checkbox"/>	<input type="checkbox"/>	<input type="checkbox"/>	<input type="checkbox"/>	<input type="checkbox"/>	<input type="checkbox"/>	<input type="checkbox"/>	<input type="checkbox"/>
[124]	24	()	<input type="checkbox"/>	<input type="checkbox"/>	<input type="checkbox"/>	<input type="checkbox"/>	<input type="checkbox"/>	<input type="checkbox"/>	<input type="checkbox"/>	<input type="checkbox"/>	<input type="checkbox"/>
[125]	25	()	<input type="checkbox"/>	<input type="checkbox"/>	<input type="checkbox"/>	<input type="checkbox"/>	<input type="checkbox"/>	<input type="checkbox"/>	<input type="checkbox"/>	<input type="checkbox"/>	<input type="checkbox"/>
[126]	26	()	<input type="checkbox"/>	<input type="checkbox"/>	<input type="checkbox"/>	<input type="checkbox"/>	<input type="checkbox"/>	<input type="checkbox"/>	<input type="checkbox"/>	<input type="checkbox"/>	<input type="checkbox"/>
[127]	27	()	<input type="checkbox"/>	<input type="checkbox"/>	<input type="checkbox"/>	<input type="checkbox"/>	<input type="checkbox"/>	<input type="checkbox"/>	<input type="checkbox"/>	<input type="checkbox"/>	<input type="checkbox"/>
[128]	28	()	<input type="checkbox"/>	<input type="checkbox"/>	<input type="checkbox"/>	<input type="checkbox"/>	<input type="checkbox"/>	<input type="checkbox"/>	<input type="checkbox"/>	<input type="checkbox"/>	<input type="checkbox"/>
[129]	29	()	<input type="checkbox"/>	<input type="checkbox"/>	<input type="checkbox"/>	<input type="checkbox"/>	<input type="checkbox"/>	<input type="checkbox"/>	<input type="checkbox"/>	<input type="checkbox"/>	<input type="checkbox"/>
[130]	30	()	<input type="checkbox"/>	<input type="checkbox"/>	<input type="checkbox"/>	<input type="checkbox"/>	<input type="checkbox"/>	<input type="checkbox"/>	<input type="checkbox"/>	<input type="checkbox"/>	<input type="checkbox"/>
[131]	31	()	<input type="checkbox"/>	<input type="checkbox"/>	<input type="checkbox"/>	<input type="checkbox"/>	<input type="checkbox"/>	<input type="checkbox"/>	<input type="checkbox"/>	<input type="checkbox"/>	<input type="checkbox"/>
[132]	32	()	<input type="checkbox"/>	<input type="checkbox"/>	<input type="checkbox"/>	<input type="checkbox"/>	<input type="checkbox"/>	<input type="checkbox"/>	<input type="checkbox"/>	<input type="checkbox"/>	<input type="checkbox"/>
[133]	33	()	<input type="checkbox"/>	<input type="checkbox"/>	<input type="checkbox"/>	<input type="checkbox"/>	<input type="checkbox"/>	<input type="checkbox"/>	<input type="checkbox"/>	<input type="checkbox"/>	<input type="checkbox"/>
[134]	34	()	<input type="checkbox"/>	<input type="checkbox"/>	<input type="checkbox"/>	<input type="checkbox"/>	<input type="checkbox"/>	<input type="checkbox"/>	<input type="checkbox"/>	<input type="checkbox"/>	<input type="checkbox"/>

Section	Zone #	Zone Type**	Audible/Silent 1	Steady/Pulsed 2	Chime No 3	Bypass No 4	Force* No 5	Swing No 6	Tx. Delay No 7	Wireless No 8	Cross Zn No 9
[135]	35	()	<input type="checkbox"/>	<input type="checkbox"/>	<input type="checkbox"/>	<input type="checkbox"/>	<input type="checkbox"/>	<input type="checkbox"/>	<input type="checkbox"/>	<input type="checkbox"/>	<input type="checkbox"/>
[136]	36	()	<input type="checkbox"/>	<input type="checkbox"/>	<input type="checkbox"/>	<input type="checkbox"/>	<input type="checkbox"/>	<input type="checkbox"/>	<input type="checkbox"/>	<input type="checkbox"/>	<input type="checkbox"/>
[137]	37	()	<input type="checkbox"/>	<input type="checkbox"/>	<input type="checkbox"/>	<input type="checkbox"/>	<input type="checkbox"/>	<input type="checkbox"/>	<input type="checkbox"/>	<input type="checkbox"/>	<input type="checkbox"/>
[138]	38	()	<input type="checkbox"/>	<input type="checkbox"/>	<input type="checkbox"/>	<input type="checkbox"/>	<input type="checkbox"/>	<input type="checkbox"/>	<input type="checkbox"/>	<input type="checkbox"/>	<input type="checkbox"/>
[139]	39	()	<input type="checkbox"/>	<input type="checkbox"/>	<input type="checkbox"/>	<input type="checkbox"/>	<input type="checkbox"/>	<input type="checkbox"/>	<input type="checkbox"/>	<input type="checkbox"/>	<input type="checkbox"/>
[140]	40	()	<input type="checkbox"/>	<input type="checkbox"/>	<input type="checkbox"/>	<input type="checkbox"/>	<input type="checkbox"/>	<input type="checkbox"/>	<input type="checkbox"/>	<input type="checkbox"/>	<input type="checkbox"/>
[141]	41	()	<input type="checkbox"/>	<input type="checkbox"/>	<input type="checkbox"/>	<input type="checkbox"/>	<input type="checkbox"/>	<input type="checkbox"/>	<input type="checkbox"/>	<input type="checkbox"/>	<input type="checkbox"/>
[142]	42	()	<input type="checkbox"/>	<input type="checkbox"/>	<input type="checkbox"/>	<input type="checkbox"/>	<input type="checkbox"/>	<input type="checkbox"/>	<input type="checkbox"/>	<input type="checkbox"/>	<input type="checkbox"/>
[143]	43	()	<input type="checkbox"/>	<input type="checkbox"/>	<input type="checkbox"/>	<input type="checkbox"/>	<input type="checkbox"/>	<input type="checkbox"/>	<input type="checkbox"/>	<input type="checkbox"/>	<input type="checkbox"/>
[144]	44	()	<input type="checkbox"/>	<input type="checkbox"/>	<input type="checkbox"/>	<input type="checkbox"/>	<input type="checkbox"/>	<input type="checkbox"/>	<input type="checkbox"/>	<input type="checkbox"/>	<input type="checkbox"/>
[145]	45	()	<input type="checkbox"/>	<input type="checkbox"/>	<input type="checkbox"/>	<input type="checkbox"/>	<input type="checkbox"/>	<input type="checkbox"/>	<input type="checkbox"/>	<input type="checkbox"/>	<input type="checkbox"/>
[146]	46	()	<input type="checkbox"/>	<input type="checkbox"/>	<input type="checkbox"/>	<input type="checkbox"/>	<input type="checkbox"/>	<input type="checkbox"/>	<input type="checkbox"/>	<input type="checkbox"/>	<input type="checkbox"/>
[147]	47	()	<input type="checkbox"/>	<input type="checkbox"/>	<input type="checkbox"/>	<input type="checkbox"/>	<input type="checkbox"/>	<input type="checkbox"/>	<input type="checkbox"/>	<input type="checkbox"/>	<input type="checkbox"/>
[148]	48	()	<input type="checkbox"/>	<input type="checkbox"/>	<input type="checkbox"/>	<input type="checkbox"/>	<input type="checkbox"/>	<input type="checkbox"/>	<input type="checkbox"/>	<input type="checkbox"/>	<input type="checkbox"/>
[149]	49	()	<input type="checkbox"/>	<input type="checkbox"/>	<input type="checkbox"/>	<input type="checkbox"/>	<input type="checkbox"/>	<input type="checkbox"/>	<input type="checkbox"/>	<input type="checkbox"/>	<input type="checkbox"/>
[150]	50	()	<input type="checkbox"/>	<input type="checkbox"/>	<input type="checkbox"/>	<input type="checkbox"/>	<input type="checkbox"/>	<input type="checkbox"/>	<input type="checkbox"/>	<input type="checkbox"/>	<input type="checkbox"/>
[151]	51	()	<input type="checkbox"/>	<input type="checkbox"/>	<input type="checkbox"/>	<input type="checkbox"/>	<input type="checkbox"/>	<input type="checkbox"/>	<input type="checkbox"/>	<input type="checkbox"/>	<input type="checkbox"/>
[152]	52	()	<input type="checkbox"/>	<input type="checkbox"/>	<input type="checkbox"/>	<input type="checkbox"/>	<input type="checkbox"/>	<input type="checkbox"/>	<input type="checkbox"/>	<input type="checkbox"/>	<input type="checkbox"/>
[153]	53	()	<input type="checkbox"/>	<input type="checkbox"/>	<input type="checkbox"/>	<input type="checkbox"/>	<input type="checkbox"/>	<input type="checkbox"/>	<input type="checkbox"/>	<input type="checkbox"/>	<input type="checkbox"/>
[154]	54	()	<input type="checkbox"/>	<input type="checkbox"/>	<input type="checkbox"/>	<input type="checkbox"/>	<input type="checkbox"/>	<input type="checkbox"/>	<input type="checkbox"/>	<input type="checkbox"/>	<input type="checkbox"/>
[155]	55	()	<input type="checkbox"/>	<input type="checkbox"/>	<input type="checkbox"/>	<input type="checkbox"/>	<input type="checkbox"/>	<input type="checkbox"/>	<input type="checkbox"/>	<input type="checkbox"/>	<input type="checkbox"/>
[156]	56	()	<input type="checkbox"/>	<input type="checkbox"/>	<input type="checkbox"/>	<input type="checkbox"/>	<input type="checkbox"/>	<input type="checkbox"/>	<input type="checkbox"/>	<input type="checkbox"/>	<input type="checkbox"/>
[157]	57	()	<input type="checkbox"/>	<input type="checkbox"/>	<input type="checkbox"/>	<input type="checkbox"/>	<input type="checkbox"/>	<input type="checkbox"/>	<input type="checkbox"/>	<input type="checkbox"/>	<input type="checkbox"/>
[158]	58	()	<input type="checkbox"/>	<input type="checkbox"/>	<input type="checkbox"/>	<input type="checkbox"/>	<input type="checkbox"/>	<input type="checkbox"/>	<input type="checkbox"/>	<input type="checkbox"/>	<input type="checkbox"/>
[159]	59	()	<input type="checkbox"/>	<input type="checkbox"/>	<input type="checkbox"/>	<input type="checkbox"/>	<input type="checkbox"/>	<input type="checkbox"/>	<input type="checkbox"/>	<input type="checkbox"/>	<input type="checkbox"/>
[160]	60	()	<input type="checkbox"/>	<input type="checkbox"/>	<input type="checkbox"/>	<input type="checkbox"/>	<input type="checkbox"/>	<input type="checkbox"/>	<input type="checkbox"/>	<input type="checkbox"/>	<input type="checkbox"/>
[161]	61	()	<input type="checkbox"/>	<input type="checkbox"/>	<input type="checkbox"/>	<input type="checkbox"/>	<input type="checkbox"/>	<input type="checkbox"/>	<input type="checkbox"/>	<input type="checkbox"/>	<input type="checkbox"/>
[162]	62	()	<input type="checkbox"/>	<input type="checkbox"/>	<input type="checkbox"/>	<input type="checkbox"/>	<input type="checkbox"/>	<input type="checkbox"/>	<input type="checkbox"/>	<input type="checkbox"/>	<input type="checkbox"/>
[163]	63	()	<input type="checkbox"/>	<input type="checkbox"/>	<input type="checkbox"/>	<input type="checkbox"/>	<input type="checkbox"/>	<input type="checkbox"/>	<input type="checkbox"/>	<input type="checkbox"/>	<input type="checkbox"/>
[164]	64	()	<input type="checkbox"/>	<input type="checkbox"/>	<input type="checkbox"/>	<input type="checkbox"/>	<input type="checkbox"/>	<input type="checkbox"/>	<input type="checkbox"/>	<input type="checkbox"/>	<input type="checkbox"/>

Section	Zone #	Zone Type**	For Future Use 10	For Future Use 11	For Future Use 12	For Future Use 13	NC Loops Config. 14	SEOL Config. 15	DEOL Config. 16
[101]	01	()	<input type="checkbox"/>	<input type="checkbox"/>	<input type="checkbox"/>	<input type="checkbox"/>	<input type="checkbox"/>	<input type="checkbox"/>	<input type="checkbox"/>
[102]	02	()	<input type="checkbox"/>	<input type="checkbox"/>	<input type="checkbox"/>	<input type="checkbox"/>	<input type="checkbox"/>	<input type="checkbox"/>	<input type="checkbox"/>
[103]	03	()	<input type="checkbox"/>	<input type="checkbox"/>	<input type="checkbox"/>	<input type="checkbox"/>	<input type="checkbox"/>	<input type="checkbox"/>	<input type="checkbox"/>
[104]	04	()	<input type="checkbox"/>	<input type="checkbox"/>	<input type="checkbox"/>	<input type="checkbox"/>	<input type="checkbox"/>	<input type="checkbox"/>	<input type="checkbox"/>
[105]	05	()	<input type="checkbox"/>	<input type="checkbox"/>	<input type="checkbox"/>	<input type="checkbox"/>	<input type="checkbox"/>	<input type="checkbox"/>	<input type="checkbox"/>
[106]	06	()	<input type="checkbox"/>	<input type="checkbox"/>	<input type="checkbox"/>	<input type="checkbox"/>	<input type="checkbox"/>	<input type="checkbox"/>	<input type="checkbox"/>
[107]	07	()	<input type="checkbox"/>	<input type="checkbox"/>	<input type="checkbox"/>	<input type="checkbox"/>	<input type="checkbox"/>	<input type="checkbox"/>	<input type="checkbox"/>
[108]	08	()	<input type="checkbox"/>	<input type="checkbox"/>	<input type="checkbox"/>	<input type="checkbox"/>	<input type="checkbox"/>	<input type="checkbox"/>	<input type="checkbox"/>

i **Record here based on programming in sections [001]-[004].
Zone attributes 10-16 only apply to zones 1-8.

System Timers

[165] Maximum Dialing Attempts to Each Telephone Number
Default 005 Valid entries are 001-005 attempts
For UL Listed Installations, 5 dialing attempts are required.

[166] Post Dial Wait for Handshake (All Formats)
Default 040 Valid entries are 001-255 seconds

[167] TL/GS Module Wait for Acknowledgement
Default 060 Valid entries are 060-255 seconds

[168] Set Clock Forward (Daylight Saving Time)

Def 003	Month	_ _ _ _	Valid Entries 001-012
Def 002	Week	_ _ _ _	Valid Entries 000-005
Def 000	Day	_ _ _ _	Valid Entries 000-031
Def 002	Hour	_ _ _ _	Valid Entries 000-023
Def 001	Increment	_ _ _ _	Valid Entries 001-002

[169] Set Clock Back (Standard Time)

Def 011	Month	_ _ _ _	Valid Entries 001-012
Def 001	Week	_ _ _ _	Valid Entries 000-005
Def 000	Day	_ _ _ _	Valid Entries 000-031
Def 002	Hour	_ _ _ _	Valid Entries 000-023
Def 001	Decrement	_ _ _ _	Valid Entries 001-002

[170] PGM Output Timer

Default 005 |_|_|_|_| Valid entries are 001-255 seconds

[171] Tamper PGM Output Timer

Default 000 |_|_|_|_| Valid entries are 000-255 minutes

[175] Auto-arm Postpone Timer

Default 000 |_|_|_|_| Valid entries are 001-255 minutes; 000 disables automatic arming

[176] Cross Zone/Police Code Timer

Default 060 |_|_|_|_| Valid entries are 001-255 seconds/minutes; 000 for armed-to-armed period for Police Code

Automatic Arming Schedule

Enter a four-digit number (HH:MM) for each day that the system will Auto-Arm on each partition ([181] for Partition 1 through [188] for Partition 8). All entries are disabled (9999) by default. Valid entries are 0000-2359.

	Sunday	Monday	Tuesday	Wednesday	Thursday	Friday	Saturday
[181]	_ _ _	_ _ _	_ _ _	_ _ _	_ _ _	_ _ _	_ _ _
[182]	_ _ _	_ _ _	_ _ _	_ _ _	_ _ _	_ _ _	_ _ _
[183]	_ _ _	_ _ _	_ _ _	_ _ _	_ _ _	_ _ _	_ _ _
[184]	_ _ _	_ _ _	_ _ _	_ _ _	_ _ _	_ _ _	_ _ _
[185]	_ _ _	_ _ _	_ _ _	_ _ _	_ _ _	_ _ _	_ _ _
[186]	_ _ _	_ _ _	_ _ _	_ _ _	_ _ _	_ _ _	_ _ _
[187]	_ _ _	_ _ _	_ _ _	_ _ _	_ _ _	_ _ _	_ _ _
[188]	_ _ _	_ _ _	_ _ _	_ _ _	_ _ _	_ _ _	_ _ _

[190] No Activity Arming Pre-Alert Time

Default Partition
001 All |_|_|_|_| Valid entries are 001-255 minutes; 000 for no pre-alert

No Activity Arming Timers - Default is [000] for all partitions

Section	Partition		
[191]	1	_ _ _ _	Valid entries are 001-255 minutes; 000 disables
[192]	2	_ _ _ _	Valid entries are 001-255 minutes; 000 disables
[193]	3	_ _ _ _	Valid entries are 001-255 minutes; 000 disables
[194]	4	_ _ _ _	Valid entries are 001-255 minutes; 000 disables
[195]	5	_ _ _ _	Valid entries are 001-255 minutes; 000 disables
[196]	6	_ _ _ _	Valid entries are 001-255 minutes; 000 disables
[197]	7	_ _ _ _	Valid entries are 001-255 minutes; 000 disables
[198]	8	_ _ _ _	Valid entries are 001-255 minutes; 000 disables

[199] Auto-arming Pre-Alert Timer

Default: 004 |_|_|_|_| Valid entries are 001-255 minutes

Partition Programming

[201] Partition Selection Mask

Opt	Def	ON	OFF
1	✓	<input type="checkbox"/> Partition 1 is enabled	<input type="checkbox"/> Cannot be disabled
2		<input type="checkbox"/> Partition 2 is enabled	✓ <input type="checkbox"/> Disabled
3		<input type="checkbox"/> Partition 3 is enabled	✓ <input type="checkbox"/> Disabled
4		<input type="checkbox"/> Partition 4 is enabled	✓ <input type="checkbox"/> Disabled
5		<input type="checkbox"/> Partition 5 is enabled	✓ <input type="checkbox"/> Disabled
6		<input type="checkbox"/> Partition 6 is enabled	✓ <input type="checkbox"/> Disabled
7		<input type="checkbox"/> Partition 7 is enabled	✓ <input type="checkbox"/> Disabled
8		<input type="checkbox"/> Partition 8 is enabled	✓ <input type="checkbox"/> Disabled

i For the PC1864 and PC1832, the default setting is partition 1, zones 1-16 ON. For the PC1616, the default setting is partition 1, zones 1-6 ON.

Partition 1 Zone Assignment		Partition 2 Zone Assignment		Partition 3 Zone Assignment		Partition 4 Zone Assignment	
[202] 1-8	<input type="checkbox"/>	[210] 1-8	<input type="checkbox"/>	[218] 1-8	<input type="checkbox"/>	[226] 1-8	<input type="checkbox"/>
[203] 9-16	<input type="checkbox"/>	[211] 9-16	<input type="checkbox"/>	[219] 9-16	<input type="checkbox"/>	[227] 9-16	<input type="checkbox"/>
[204] 17-24	<input type="checkbox"/>	[212] 17-24	<input type="checkbox"/>	[220] 17-24	<input type="checkbox"/>	[228] 17-24	<input type="checkbox"/>
[205] 25-32	<input type="checkbox"/>	[213] 25-32	<input type="checkbox"/>	[221] 25-32	<input type="checkbox"/>	[229] 25-32	<input type="checkbox"/>
[206] 33-40	<input type="checkbox"/>	[214] 33-40	<input type="checkbox"/>	[222] 33-40	<input type="checkbox"/>	[230] 33-40	<input type="checkbox"/>
[207] 41-48	<input type="checkbox"/>	[215] 41-48	<input type="checkbox"/>	[223] 41-48	<input type="checkbox"/>	[231] 41-48	<input type="checkbox"/>
[208] 49-56	<input type="checkbox"/>	[216] 49-56	<input type="checkbox"/>	[224] 49-56	<input type="checkbox"/>	[232] 49-56	<input type="checkbox"/>
[209] 57-64	<input type="checkbox"/>	[217] 57-64	<input type="checkbox"/>	[225] 57-64	<input type="checkbox"/>	[233] 57-64	<input type="checkbox"/>
Partition 5 Zone Assignment		Partition 6 Zone Assignment		Partition 7 Zone Assignment		Partition 8 Zone Assignment	
[234] 1-8	<input type="checkbox"/>	[242] 1-8	<input type="checkbox"/>	[250] 1-8	<input type="checkbox"/>	[258] 1-8	<input type="checkbox"/>
[235] 9-16	<input type="checkbox"/>	[243] 9-16	<input type="checkbox"/>	[251] 9-16	<input type="checkbox"/>	[259] 9-16	<input type="checkbox"/>
[236] 17-24	<input type="checkbox"/>	[244] 17-24	<input type="checkbox"/>	[252] 17-24	<input type="checkbox"/>	[260] 17-24	<input type="checkbox"/>
[237] 25-32	<input type="checkbox"/>	[245] 25-32	<input type="checkbox"/>	[253] 25-32	<input type="checkbox"/>	[261] 25-32	<input type="checkbox"/>
[238] 33-40	<input type="checkbox"/>	[246] 33-40	<input type="checkbox"/>	[254] 33-40	<input type="checkbox"/>	[262] 33-40	<input type="checkbox"/>
[239] 41-48	<input type="checkbox"/>	[247] 41-48	<input type="checkbox"/>	[255] 41-48	<input type="checkbox"/>	[263] 41-48	<input type="checkbox"/>
[240] 49-56	<input type="checkbox"/>	[248] 49-56	<input type="checkbox"/>	[256] 49-56	<input type="checkbox"/>	[264] 49-56	<input type="checkbox"/>
[241] 57-64	<input type="checkbox"/>	[249] 57-64	<input type="checkbox"/>	[257] 57-64	<input type="checkbox"/>	[265] 57-64	<input type="checkbox"/>

Communications

[301] First Telephone Number (32 Digits)

D | | | | | | | | | | | | | | | | | | | | | | | | | | | | | | | | | | | | | | | | |

[302] Second Telephone Number (32 Digits)

D | | | | | | | | | | | | | | | | | | | | | | | | | | | | | | | | | | | | | | | | |

[303] Third Telephone Number (32 Digits)

D | | | | | | | | | | | | | | | | | | | | | | | | | | | | | | | | | | | | | | | | |

[304] Call Waiting Cancel String (6 Digits) - This feature is activated in [382] Option 4

| | | | | | | | Default = DB70EF Program unused digits with Hex F

i All six digits must be entered for changes to be saved. Fill unused digit spaces with 'F'.

Account Codes

Enter a 6-digit account number for the system account code. SIA will use this account code for all eight partitions. Only SIA supports 6-digit account codes. If the last two digits of the account code are FF, the panel will only use the first four digits.

Section [310] System Account Code [FFFFFF]

--	--	--	--	--	--	--	--

Enter a four-digit account number for each active partition.

[311] Partition 1 Account Number

--	--	--	--

[312] Partition 2 Account Number

--	--	--	--

[313] Partition 3 Account Number

--	--	--	--

[314] Partition 4 Account Number

--	--	--	--

[315] Partition 5 Account Number

--	--	--	--

[316] Partition 6 Account Number

--	--	--	--

[317] Partition 7 Account Number

--	--	--	--

[318] Partition 8 Account Number

--	--	--	--

i All Account Number codes are defaulted to FFFF.

Reporting Codes

[320]-[323] Alarm Reporting Codes, Zones 01-64

i All Reporting Codes defaulted to FF unless otherwise indicated.

Section

[320]	Zone 01	Zone 02	Zone 03	Zone 04	Zone 05	Zone 06	Zone 07	Zone 08
	<input type="text"/>	<input type="text"/>	<input type="text"/>	<input type="text"/>	<input type="text"/>	<input type="text"/>	<input type="text"/>	<input type="text"/>
	Zone 09	Zone 10	Zone 11	Zone 12	Zone 13	Zone 14	Zone 15	Zone 16
	<input type="text"/>	<input type="text"/>	<input type="text"/>	<input type="text"/>	<input type="text"/>	<input type="text"/>	<input type="text"/>	<input type="text"/>
[321]	Zone 17	Zone 18	Zone 19	Zone 20	Zone 21	Zone 22	Zone 23	Zone 24
	<input type="text"/>	<input type="text"/>	<input type="text"/>	<input type="text"/>	<input type="text"/>	<input type="text"/>	<input type="text"/>	<input type="text"/>
	Zone 25	Zone 26	Zone 27	Zone 28	Zone 29	Zone 30	Zone 31	Zone 32
	<input type="text"/>	<input type="text"/>	<input type="text"/>	<input type="text"/>	<input type="text"/>	<input type="text"/>	<input type="text"/>	<input type="text"/>
[322]	Zone 33	Zone 34	Zone 35	Zone 36	Zone 37	Zone 38	Zone 39	Zone 40
	<input type="text"/>	<input type="text"/>	<input type="text"/>	<input type="text"/>	<input type="text"/>	<input type="text"/>	<input type="text"/>	<input type="text"/>
	Zone 41	Zone 42	Zone 43	Zone 44	Zone 45	Zone 46	Zone 47	Zone 48
	<input type="text"/>	<input type="text"/>	<input type="text"/>	<input type="text"/>	<input type="text"/>	<input type="text"/>	<input type="text"/>	<input type="text"/>
[323]	Zone 49	Zone 50	Zone 51	Zone 52	Zone 53	Zone 54	Zone 55	Zone 56
	<input type="text"/>	<input type="text"/>	<input type="text"/>	<input type="text"/>	<input type="text"/>	<input type="text"/>	<input type="text"/>	<input type="text"/>
	Zone 57	Zone 58	Zone 59	Zone 60	Zone 61	Zone 62	Zone 63	Zone 64
	<input type="text"/>	<input type="text"/>	<input type="text"/>	<input type="text"/>	<input type="text"/>	<input type="text"/>	<input type="text"/>	<input type="text"/>

[324]-[327] Alarm Restoral Reporting Codes, Zones 01-64

Section

[324]	Zone 01	Zone 02	Zone 03	Zone 04	Zone 05	Zone 06	Zone 07	Zone 08
	<input type="text"/>	<input type="text"/>	<input type="text"/>	<input type="text"/>	<input type="text"/>	<input type="text"/>	<input type="text"/>	<input type="text"/>
	Zone 09	Zone 10	Zone 11	Zone 12	Zone 13	Zone 14	Zone 15	Zone 16
	<input type="text"/>	<input type="text"/>	<input type="text"/>	<input type="text"/>	<input type="text"/>	<input type="text"/>	<input type="text"/>	<input type="text"/>
[325]	Zone 17	Zone 18	Zone 19	Zone 20	Zone 21	Zone 22	Zone 23	Zone 24
	<input type="text"/>	<input type="text"/>	<input type="text"/>	<input type="text"/>	<input type="text"/>	<input type="text"/>	<input type="text"/>	<input type="text"/>
	Zone 25	Zone 26	Zone 27	Zone 28	Zone 29	Zone 30	Zone 31	Zone 32
	<input type="text"/>	<input type="text"/>	<input type="text"/>	<input type="text"/>	<input type="text"/>	<input type="text"/>	<input type="text"/>	<input type="text"/>
[326]	Zone 33	Zone 34	Zone 35	Zone 36	Zone 37	Zone 38	Zone 39	Zone 40
	<input type="text"/>	<input type="text"/>	<input type="text"/>	<input type="text"/>	<input type="text"/>	<input type="text"/>	<input type="text"/>	<input type="text"/>
	Zone 41	Zone 42	Zone 43	Zone 44	Zone 45	Zone 46	Zone 47	Zone 48
	<input type="text"/>	<input type="text"/>	<input type="text"/>	<input type="text"/>	<input type="text"/>	<input type="text"/>	<input type="text"/>	<input type="text"/>
[327]	Zone 49	Zone 50	Zone 51	Zone 52	Zone 53	Zone 54	Zone 55	Zone 56
	<input type="text"/>	<input type="text"/>	<input type="text"/>	<input type="text"/>	<input type="text"/>	<input type="text"/>	<input type="text"/>	<input type="text"/>
	Zone 57	Zone 58	Zone 59	Zone 60	Zone 61	Zone 62	Zone 63	Zone 64
	<input type="text"/>	<input type="text"/>	<input type="text"/>	<input type="text"/>	<input type="text"/>	<input type="text"/>	<input type="text"/>	<input type="text"/>

[328] Miscellaneous Alarm Reporting Codes

- Duress Alarm
- Opening After Alarm
- Recent Closing
- Zone Expander Supervisory Alarm
- Zone Expander Supervisory Restore
- Cross Zone Police Code Alarm
- Burglary Not Verified
- Alarm Cancelled

[329] Priority Alarm and Restoral

- Keypad Fire Alarm
- Keypad Auxiliary Alarm
- Keypad Panic Alarm
- Auxiliary Input Alarm
- Keypad Fire Restoral
- Keypad Auxiliary Restoral
- Keypad Panic Restoral
- Auxiliary Input Restore

[330]-[333] Tamper Reporting Codes, Zones 01-64

Section

[330]	Zone 01	Zone 02	Zone 03	Zone 04	Zone 05	Zone 06	Zone 07	Zone 08
	<input type="checkbox"/>	<input type="checkbox"/>	<input type="checkbox"/>	<input type="checkbox"/>	<input type="checkbox"/>	<input type="checkbox"/>	<input type="checkbox"/>	<input type="checkbox"/>
	Zone 09	Zone 10	Zone 11	Zone 12	Zone 13	Zone 14	Zone 15	Zone 16
	<input type="checkbox"/>	<input type="checkbox"/>	<input type="checkbox"/>	<input type="checkbox"/>	<input type="checkbox"/>	<input type="checkbox"/>	<input type="checkbox"/>	<input type="checkbox"/>
[331]	Zone 17	Zone 18	Zone 19	Zone 20	Zone 21	Zone 22	Zone 23	Zone 24
	<input type="checkbox"/>	<input type="checkbox"/>	<input type="checkbox"/>	<input type="checkbox"/>	<input type="checkbox"/>	<input type="checkbox"/>	<input type="checkbox"/>	<input type="checkbox"/>
	Zone 25	Zone 26	Zone 27	Zone 28	Zone 29	Zone 30	Zone 31	Zone 32
	<input type="checkbox"/>	<input type="checkbox"/>	<input type="checkbox"/>	<input type="checkbox"/>	<input type="checkbox"/>	<input type="checkbox"/>	<input type="checkbox"/>	<input type="checkbox"/>
[332]	Zone 33	Zone 34	Zone 35	Zone 36	Zone 37	Zone 38	Zone 39	Zone 40
	<input type="checkbox"/>	<input type="checkbox"/>	<input type="checkbox"/>	<input type="checkbox"/>	<input type="checkbox"/>	<input type="checkbox"/>	<input type="checkbox"/>	<input type="checkbox"/>
	Zone 41	Zone 42	Zone 43	Zone 44	Zone 45	Zone 46	Zone 47	Zone 48
	<input type="checkbox"/>	<input type="checkbox"/>	<input type="checkbox"/>	<input type="checkbox"/>	<input type="checkbox"/>	<input type="checkbox"/>	<input type="checkbox"/>	<input type="checkbox"/>
[333]	Zone 49	Zone 50	Zone 51	Zone 52	Zone 53	Zone 54	Zone 55	Zone 56
	<input type="checkbox"/>	<input type="checkbox"/>	<input type="checkbox"/>	<input type="checkbox"/>	<input type="checkbox"/>	<input type="checkbox"/>	<input type="checkbox"/>	<input type="checkbox"/>
	Zone 57	Zone 58	Zone 59	Zone 60	Zone 61	Zone 62	Zone 63	Zone 64
	<input type="checkbox"/>	<input type="checkbox"/>	<input type="checkbox"/>	<input type="checkbox"/>	<input type="checkbox"/>	<input type="checkbox"/>	<input type="checkbox"/>	<input type="checkbox"/>

[334]-[337] Tamper Restoral Reporting Codes, Zones 01-64

Section

[334]	Zone 01	Zone 02	Zone 03	Zone 04	Zone 05	Zone 06	Zone 07	Zone 08
	<input type="checkbox"/>	<input type="checkbox"/>	<input type="checkbox"/>	<input type="checkbox"/>	<input type="checkbox"/>	<input type="checkbox"/>	<input type="checkbox"/>	<input type="checkbox"/>
	Zone 09	Zone 10	Zone 11	Zone 12	Zone 13	Zone 14	Zone 15	Zone 16
	<input type="checkbox"/>	<input type="checkbox"/>	<input type="checkbox"/>	<input type="checkbox"/>	<input type="checkbox"/>	<input type="checkbox"/>	<input type="checkbox"/>	<input type="checkbox"/>
[335]	Zone 17	Zone 18	Zone 19	Zone 20	Zone 21	Zone 22	Zone 23	Zone 24
	<input type="checkbox"/>	<input type="checkbox"/>	<input type="checkbox"/>	<input type="checkbox"/>	<input type="checkbox"/>	<input type="checkbox"/>	<input type="checkbox"/>	<input type="checkbox"/>
	Zone 25	Zone 26	Zone 27	Zone 28	Zone 29	Zone 30	Zone 31	Zone 32
	<input type="checkbox"/>	<input type="checkbox"/>	<input type="checkbox"/>	<input type="checkbox"/>	<input type="checkbox"/>	<input type="checkbox"/>	<input type="checkbox"/>	<input type="checkbox"/>
[336]	Zone 33	Zone 34	Zone 35	Zone 36	Zone 37	Zone 38	Zone 39	Zone 40
	<input type="checkbox"/>	<input type="checkbox"/>	<input type="checkbox"/>	<input type="checkbox"/>	<input type="checkbox"/>	<input type="checkbox"/>	<input type="checkbox"/>	<input type="checkbox"/>
	Zone 41	Zone 42	Zone 43	Zone 44	Zone 45	Zone 46	Zone 47	Zone 48
	<input type="checkbox"/>	<input type="checkbox"/>	<input type="checkbox"/>	<input type="checkbox"/>	<input type="checkbox"/>	<input type="checkbox"/>	<input type="checkbox"/>	<input type="checkbox"/>
[337]	Zone 49	Zone 50	Zone 51	Zone 52	Zone 53	Zone 54	Zone 55	Zone 56
	<input type="checkbox"/>	<input type="checkbox"/>	<input type="checkbox"/>	<input type="checkbox"/>	<input type="checkbox"/>	<input type="checkbox"/>	<input type="checkbox"/>	<input type="checkbox"/>
	Zone 57	Zone 58	Zone 59	Zone 60	Zone 61	Zone 62	Zone 63	Zone 64
	<input type="checkbox"/>	<input type="checkbox"/>	<input type="checkbox"/>	<input type="checkbox"/>	<input type="checkbox"/>	<input type="checkbox"/>	<input type="checkbox"/>	<input type="checkbox"/>

[338] Miscellaneous Tamper Reporting Codes

- ____ General System Tamper
- ____ General System Tamper Rest.
- ____ Keypad Lockout

[339]-[340] Closing (Arming) Reporting Codes, Access Codes 1-32

Section

[339]	Code 1	Code 2	Code 3	Code 4	Code 5	Code 6	Code 7	Code 8
	____	____	____	____	____	____	____	____
	Code 9	Code 10	Code 11	Code 12	Code 13	Code 14	Code 15	Code 16
	____	____	____	____	____	____	____	____
[340]	Code 17	Code 18	Code 19	Code 20	Code 21	Code 22	Code 23	Code 24
	____	____	____	____	____	____	____	____
	Code 25	Code 26	Code 27	Code 28	Code 29	Code 30	Code 31	Code 32
	____	____	____	____	____	____	____	____

[341] Miscellaneous Closing (Arming) Reporting Codes

- ____ For Future Use
- ____ For Future Use
- ____ For Future Use
- ____ For Future Use
- 010** Automatic Zone Bypass
- ____ Partial Closing
- ____ Special Closing
- ____ Late to Close
- ____ Exit Fault

[342]-[343] Opening (Disarming) Reporting Codes, Access Codes 1-32

Section

[342]	Code 1	Code 2	Code 3	Code 4	Code 5	Code 6	Code 7	Code 8
	____	____	____	____	____	____	____	____
	Code 9	Code 10	Code 11	Code 12	Code 13	Code 14	Code 15	Code 16
	____	____	____	____	____	____	____	____
[343]	Code 17	Code 18	Code 19	Code 20	Code 21	Code 22	Code 23	Code 24
	____	____	____	____	____	____	____	____
	Code 25	Code 26	Code 27	Code 28	Code 29	Code 30	Code 31	Code 32
	____	____	____	____	____	____	____	____

[344] Miscellaneous Opening (Disarming) Reporting Codes

- ____ For Future Use
- ____ For Future Use
- ____ For Future Use
- ____ For Future Use
- ____ For Future Use
- ____ Auto Arm Cancellation/Postpone
- ____ Special Opening

[345] Maintenance Alarm Reporting Codes

- ____ Battery Trouble Alarm
- ____ AC Failure Trouble Alarm
- ____ Bell Circuit Trouble Alarm
- ____ Fire Trouble Alarm
- ____ Auxiliary Power Supply Trouble Alarm
- ____ TLM Trouble Code
- ____ General System Trouble
- ____ General System Supervisory
- ____ For Future Use

[346] Maintenance Restoral Reporting Codes

- ____ Battery Trouble Restoral
- ____ AC Failure Trouble Restoral
- ____ Bell Circuit Trouble Restoral
- ____ Fire Trouble Restoral
- ____ Auxiliary Power Supply Trouble Restoral
- ____ TLM Restoral
- ____ General System Trouble Restoral
- ____ General System Supervisory Restoral
- ____ Cold Start

[347] Miscellaneous Maintenance Reporting Codes

- Telephone Number 1 FTC Restore
- Telephone Number 2 FTC Restore
- Event Buffer 75% Full Since Last Upload
- _0_ _0_ DLS Lead IN
- _0_ _0_ DLS Lead OUT
- Zone Fault Alarm
- Zone Fault Restore
- Delinquency Code
- General Zone Low Battery Alarm
- General Zone Low Battery Restoral
- _0_ _0_ Installer Lead Out
- _0_ _0_ Installer Lead In

[348] Test Transmission Reporting Codes

- Walk Test End
- Walk Begin
- Periodic Test Transmission with Trouble
- Periodic Test Transmission
- System Test
- For Future Use

[349] PC5700 Maintenance Reporting Codes (only available in Canada)

- PC5700 Ground Fault Trouble
- PC5700 Ground Fault Restore
- PC5700 TLM Line 1 Trouble
- PC5700 TLM Line 1 Restore
- PC5700 TLM Line 2 Trouble
- PC5700 TLM Line 2 Restore

[350] Communicator Format Options

Default

- 04 1st Telephone Number
- 04 2nd Telephone Number

- 01 20 BPS, 1400 HZ handshake
- 05 Pager
- 08 10 BPS, 2300Hz handshake
- 02 20 BPS, 2300 HZ handshake
- 06 Residential Dial**
- 09-13 For Future Use
- 03 DTMF CONTACT ID
- 07 10 BPS, 1400Hz handshake
- 04 SIA FSK

**Failure to communicate using Residential Dial will not generate a Failed To Communicate Trouble.

Call Direction Options

[351]-[358] Alarm/Restore Communicator Call Directions

Section	Partition	Option 1 1st Telephone Number (Def ON)	Option 2 2nd Telephone Number (Def OFF)	Option 3 Not Used (Def OFF)	Option 4 Not Used (Def OFF)	Option 5 Alt Comm (Def ON)	Options 6,7,8 Future Use
[351]	1	<input type="text"/>	<input type="text"/>	<input type="text"/>	<input type="text"/>	<input type="text"/>	<input type="text"/>
[352]	2	<input type="text"/>	<input type="text"/>	<input type="text"/>	<input type="text"/>	<input type="text"/>	<input type="text"/>
[353]	3	<input type="text"/>	<input type="text"/>	<input type="text"/>	<input type="text"/>	<input type="text"/>	<input type="text"/>
[354]	4	<input type="text"/>	<input type="text"/>	<input type="text"/>	<input type="text"/>	<input type="text"/>	<input type="text"/>
[355]	5	<input type="text"/>	<input type="text"/>	<input type="text"/>	<input type="text"/>	<input type="text"/>	<input type="text"/>
[356]	6	<input type="text"/>	<input type="text"/>	<input type="text"/>	<input type="text"/>	<input type="text"/>	<input type="text"/>
[357]	7	<input type="text"/>	<input type="text"/>	<input type="text"/>	<input type="text"/>	<input type="text"/>	<input type="text"/>
[358]	8	<input type="text"/>	<input type="text"/>	<input type="text"/>	<input type="text"/>	<input type="text"/>	<input type="text"/>

[359]-[366] Tamper/Restore Communicator Call Directions

Section	Partition	Option 1 1st Telephone Number (Def ON)	Option 2 2nd Telephone Number (Def OFF)	Option 3 Not Used (Def OFF)	Option 4 Not Used (Def OFF)	Option 5 Alt Comm (Def ON)	Options 6,7,8 Future Use
[359]	1	<input type="text"/>	<input type="text"/>	<input type="text"/>	<input type="text"/>	<input type="text"/>	<input type="text"/>
[360]	2	<input type="text"/>	<input type="text"/>	<input type="text"/>	<input type="text"/>	<input type="text"/>	<input type="text"/>
[361]	3	<input type="text"/>	<input type="text"/>	<input type="text"/>	<input type="text"/>	<input type="text"/>	<input type="text"/>
[362]	4	<input type="text"/>	<input type="text"/>	<input type="text"/>	<input type="text"/>	<input type="text"/>	<input type="text"/>
[363]	5	<input type="text"/>	<input type="text"/>	<input type="text"/>	<input type="text"/>	<input type="text"/>	<input type="text"/>
[364]	6	<input type="text"/>	<input type="text"/>	<input type="text"/>	<input type="text"/>	<input type="text"/>	<input type="text"/>
[365]	7	<input type="text"/>	<input type="text"/>	<input type="text"/>	<input type="text"/>	<input type="text"/>	<input type="text"/>
[366]	8	<input type="text"/>	<input type="text"/>	<input type="text"/>	<input type="text"/>	<input type="text"/>	<input type="text"/>

[367]-[374] Opening/Closing Communicator Call Directions

Section	Partition	Option 1 1st Telephone Number (Def OFF)	Option 2 2nd Telephone Number (Def OFF)	Option 3 Not Used (Def OFF)	Option 4 Not Used (Def OFF)	Option 5 Alt Comm (Def OFF)	Options 6,7,8 Future Use
[367]	1	<input type="text"/>	<input type="text"/>	<input type="text"/>	<input type="text"/>	<input type="text"/>	<input type="text"/>
[368]	2	<input type="text"/>	<input type="text"/>	<input type="text"/>	<input type="text"/>	<input type="text"/>	<input type="text"/>
[369]	3	<input type="text"/>	<input type="text"/>	<input type="text"/>	<input type="text"/>	<input type="text"/>	<input type="text"/>
[370]	4	<input type="text"/>	<input type="text"/>	<input type="text"/>	<input type="text"/>	<input type="text"/>	<input type="text"/>
[371]	5	<input type="text"/>	<input type="text"/>	<input type="text"/>	<input type="text"/>	<input type="text"/>	<input type="text"/>
[372]	6	<input type="text"/>	<input type="text"/>	<input type="text"/>	<input type="text"/>	<input type="text"/>	<input type="text"/>
[373]	7	<input type="text"/>	<input type="text"/>	<input type="text"/>	<input type="text"/>	<input type="text"/>	<input type="text"/>
[374]	8	<input type="text"/>	<input type="text"/>	<input type="text"/>	<input type="text"/>	<input type="text"/>	<input type="text"/>

[375] System Maintenance Communicator Call Directions

Section	Partition	Option 1 1st Telephone Number (Def ON)	Option 2 2nd Telephone Number (Def OFF)	Option 3 Not Used (Def OFF)	Option 4 Not Used (Def OFF)	Option 5 Alt Comm (Def ON)	Options 6,7,8 Future Use
[375]		<input type="text"/>	<input type="text"/>	<input type="text"/>	<input type="text"/>	<input type="text"/>	<input type="text"/>

[376] System Test Transmissions Communicator Call Directions

Section	Partition	Option 1 1st Telephone Number (Def ON)	Option 2 2nd Telephone Number (Def OFF)	Option 3 Not Used (Def OFF)	Option 4 Not Used (Def OFF)	Option 5 Alt Comm (Def ON)	Options 6,7,8 Future Use
[376]		<input type="text"/>	<input type="text"/>	<input type="text"/>	<input type="text"/>	<input type="text"/>	<input type="text"/>

[377] Communication Variables

The values in *gray* are required for CP-01 compliant systems.

Default

003	<input type="text"/>	Swinger Shutdown (Alarms and Rest)	001-014 Transmissions; 000=disabled
003	<input type="text"/>	Swinger Shutdown (Tampers and Rest)	001-014 Transmissions; 000=disabled
003	<input type="text"/>	Swinger Shutdown (Maintenance and Rest)	001-014 Transmissions; 000=disabled
000	<input type="text"/>	Communication Delay*	000-255 seconds
030	<input type="text"/>	AC Failure Communication Delay	001-255 hours/minutes**; 000=disabled
010	<input type="text"/>	TLM Trouble Delay	No. of checks required - valid entries 003 - 255
030	<input type="text"/>	Test Transmission Cycle (land line)	001-255 days/minutes***
030	<input type="text"/>	For Future Use	
007	<input type="text"/>	Zone Low Battery Transmission Delay	000-255 days
030	<input type="text"/>	Delinquency Transmission Cycle	000-255 days/hours****
000	<input type="text"/>	Communications Cancelled Window	000-255 minutes

* For UL installations, the Entry Delay plus Communication Delay time must not exceed 60 seconds.

**Dependent on programming in [382], Option [6].

***Dependent on programming in [702], Option [3].

****Dependent on programming in [380], Option [8].

[378] Test Transmission Time of Day**Default**

9999 Valid entries are 0000-2359 (9999 to disable)

[379] Periodic DLS Time of Day**Default**

FFFF Valid entries are 0000-2359 (9999 for Random; FFFF to disable)

[380] First Communicator Options

Opt	Def	ON	OFF
1	✓	<input type="checkbox"/> Communications Enabled	<input type="checkbox"/> Communications Disabled
2		<input type="checkbox"/> Restorals on Bell Time-out	✓ <input type="checkbox"/> Restorals Follow Zones
3		<input type="checkbox"/> Pulse Dialing	✓ <input type="checkbox"/> DTMF Dialing
4		<input type="checkbox"/> Switch to Pulse Dialing on 5th Attempt	✓ <input type="checkbox"/> DTMF Dial For All Attempts
5		<input type="checkbox"/> 3rd Telephone Number Enabled	✓ <input type="checkbox"/> 3rd Telephone Number Disabled
6		<input type="checkbox"/> Alternate Dial (1st & 3rd)	✓ <input type="checkbox"/> Call 1st Number, Back up to 3rd
7		<input type="checkbox"/> For Future Use	✓ <input type="checkbox"/>
8		<input type="checkbox"/> Delinquency Follows Zone Activity (Hours)	✓ <input type="checkbox"/> Delinquency Follows Arming (Days)

[381] Second Communicator Options

Opt	Def	ON	OFF
1		<input type="checkbox"/> Open After Alarm Keypad Ringback Enabled	✓ <input type="checkbox"/> Open After Alarm Keypad Ringback Disabled
2		<input type="checkbox"/> Open After Alarm Bell Ringback Enabled	✓ <input type="checkbox"/> Open After Alarm Bell Ringback Disabled
3		<input type="checkbox"/> SIA Sends Programmed Reporting Codes	✓ <input type="checkbox"/> SIA Sends Automatic Reporting Codes
4		<input type="checkbox"/> Closing Confirmation Enabled	✓ <input type="checkbox"/> Closing Confirmation Disabled
5	✓	<input type="checkbox"/> Talk/Listen on Phone Lines 1/3	<input type="checkbox"/> No Talk/Listen on Phone Lines 1/3
6	✓	<input type="checkbox"/> Talk/Listen on Phone Line 2	<input type="checkbox"/> No Talk/Listen on Phone Line 2
7		<input type="checkbox"/> Contact ID Uses Programmed Reporting Codes	✓ <input type="checkbox"/> Contact ID Uses Automatic Reporting Codes
8		<input type="checkbox"/> ULC Communications Priority Enabled	✓ <input type="checkbox"/> ULC Communications Priority Disabled/Standard Priority Followed

[382] Third Communicator Options

Opt	Def	ON	OFF
1		<input type="checkbox"/> For Future Use	✓ <input type="checkbox"/>
2		<input type="checkbox"/> Alarm Communications Enabled During Walk Test*	✓ <input type="checkbox"/> Alarm Communications Disabled During Walk Test
3		<input type="checkbox"/> Communication Cancelled Message Enabled (ON for SIA CP-01)	✓ <input type="checkbox"/> Communication Cancelled Message Disabled
4		<input type="checkbox"/> Call Waiting Cancel Enabled**	✓ <input type="checkbox"/> Call Waiting Cancel Disabled
5		<input type="checkbox"/> T-Link Interface Enabled	✓ <input type="checkbox"/> T-Link Interface Disabled
6		<input type="checkbox"/> AC Failure Transmission Delay is in Hours	✓ <input type="checkbox"/> AC Failure Transmission Delay is in Minutes
7		<input type="checkbox"/> Number of Dialing Attempt for Residential Dial is 1	✓ <input type="checkbox"/> Residential Dial Follows Dialing Attempts Counter
8		<input type="checkbox"/> For Future Use	✓ <input type="checkbox"/>

*This option must remain OFF for SIA CP-01 installations.

** A Call Waiting Cancel on a non-Call Waiting line will prevent successful connection to the central station.

[383] Fourth Communicator Options

Opt	Def	ON	OFF
1		<input type="checkbox"/> Account Code Follows Phone Number	✓ <input type="checkbox"/> Account Code Follows Partition
2-8		<input type="checkbox"/> For Future Use	✓ <input type="checkbox"/>

[389] TL/GS Module Fault Check Timer

Default: 003 | | | | | Enter no. of checks X 3 seconds - valid entries 002 to 255

DLS Downloading

[401] Downloading Option Codes

Opt	Def	ON	OFF
1	<input type="checkbox"/>	Answering Machine/Double Call enabled	✓ <input type="checkbox"/> Answering Machine/Double Call disabled
2	<input type="checkbox"/>	User Can Enable DLS Window	✓ <input type="checkbox"/> User Cannot Enable DLS Window
3	<input type="checkbox"/>	Call Back enabled	✓ <input type="checkbox"/> Call Back disabled
4	<input type="checkbox"/>	User Initiated Call Up enabled	✓ <input type="checkbox"/> User Initiated Call Up disabled
5	<input type="checkbox"/>	Auto Event Buffer Upload enabled	✓ <input type="checkbox"/> Auto Event Buffer Upload disabled
6	<input type="checkbox"/>	300 Baud Call Up	✓ <input type="checkbox"/> 110 Baud Call Up
7-8	<input type="checkbox"/>	For Future Use	✓ <input type="checkbox"/>

[402] DLS Downloading Telephone Number (32 Digits)

D _____

[403]-[404] DLS Downloading Access Code / Panel ID Code (Enter 6 Hexadecimal Digits)

Panel	Default	[403] Downloading Access Code	[404] Panel ID Code
PC1616	161600	_____	_____
PC1832	183200	_____	_____
PC1864	186400	_____	_____

[405] Answering Machine Double Call Timer

Default 060 _____ (001-255 seconds)

[406] Number of Rings to Answer On

Default 000 _____ (000-255 rings)

[499] Initiate PC-Link Downloading

Enter [499][Installer Code][499]

[501]- [554] Programmable Output Attributes

Program only the following attributes for the PGM options listed. All others will be ignored. PGM options are programmed in [009], [010] & [011]. PGM Attribute Defaults (Y = Attribute ON; N = Attribute OFF; Blank = Attribute not available):

Attribute:	ON	1	2	3	4	5	6	7	8
OFF	OFF	Not used	Not used	True Output	Follows Timer	Code Req.	Not used	Not used	Not used
		—	—	Inverted	On / Off	No Code Req.	—	—	—
PGM Option									
[01] Residential Burglary / Fire Bell Output				Y					
[02] For Future Use									
[03] Sensor Reset [*][7][2]				Y					
[04] 2-Wire Smoke Support (PGM2 only)				Y					
[05] System Armed Status				Y					
[06] Ready To Arm				Y					
[07] Keypad Buzzer Follower Mode				Y					
[08] Courtesy Pulse				Y					
[11] System Tamper (all sources)				Y					
[12] TLM and Alarm				Y					
[13] Kiss-off Output				Y	Y				
[14] Ground Start Pulse				Y	Y				
[15] Remote Operation (DLS Support)				Y	Y				
[16] For Future Use				Y					
[17] Away Armed Status				Y					
[18] Stay Armed Status				Y					
[19] Command Output #1, [*][7][1]				Y	Y	Y			
[20] Command Output #2, [*][7][2]				Y	Y	N			
[21] Command Output #3, [*][7][3]				Y	Y	N			
[22] Command Output #4, [*][7][4]				Y	Y	N			

[23] 24-hr Silent Input (PGM2 only)	Y
[24] 24-hr Audible Input (PGM2 only)	Y
[25] Delayed Burglary & Fire Output	Y
[26] Battery Test Output	Y
[28] Holdup Output	Y
[30] Partition Status Alarm Memory Output	Y
[33] For Future Use	
[34] Away Armed with no Zone Bypassed Status	Y

Attribute: PGM Option	1	2	3	4	5	6	7	8
ON	Serv. req.	AC Fail	TLM Fault	FTC	Zone Fault	Zone Tmp.	Zn. Low Bat.	Loss of Clock
OFF	Disabled	Disabled	Disabled	Disabled	Disabled	Disabled	Disabled	Disabled
[09] System Trouble	Y	Y	Y	Y	Y	Y	Y	Y
ON	Burg. Evnt.	Fire Evnt.	Panic Evnt.	Med. Evnt.	Supv. Evnt.	Priority Evnt.	Holdup Evnt.	Follows Timer*
OFF	Disabled	Disabled	Disabled	Disabled	Disabled	Disabled	Disabled	Latched
[10] System Event	Y	Y	Y	Y	Y	Y	Y	N
ON	Fire Alarm	Panic Alarm	Burglary Alarm	Open/Close	Zone Auto Bypass	Medical Alarm	Police Code	Active When true
OFF	Disabled	Disabled	Disabled	Disabled	Disabled	Disabled	Disabled	Latched
[31] Alternate Communicator	N	N	N	N	N	N	N	N
ON	Future Use	Future Use	True Output	Future Use	Future Use	Future Use	Future Use	AND Logic
OFF			Inverted					OR Logic
[29], [35]-[41] Zone Follower	N	N	Y	N	N	N	N	N

Section	PGM #	Output Type*	1	2	3	4	5	6	7	8
<i>Main Board</i>										
[501]	1	()	<input type="checkbox"/>	<input type="checkbox"/>	<input type="checkbox"/>	<input type="checkbox"/>	<input type="checkbox"/>	<input type="checkbox"/>	<input type="checkbox"/>	<input type="checkbox"/>
[502]	2	()	<input type="checkbox"/>	<input type="checkbox"/>	<input type="checkbox"/>	<input type="checkbox"/>	<input type="checkbox"/>	<input type="checkbox"/>	<input type="checkbox"/>	<input type="checkbox"/>
<i>Main Board / PC5208</i>										
[503]**	3	()	<input type="checkbox"/>	<input type="checkbox"/>	<input type="checkbox"/>	<input type="checkbox"/>	<input type="checkbox"/>	<input type="checkbox"/>	<input type="checkbox"/>	<input type="checkbox"/>
[504]**	4	()	<input type="checkbox"/>	<input type="checkbox"/>	<input type="checkbox"/>	<input type="checkbox"/>	<input type="checkbox"/>	<input type="checkbox"/>	<input type="checkbox"/>	<input type="checkbox"/>

*Record here based on programming in [009], [010] and [011].

** These sections allow you to program both PGM3 and PGM4 on the main panel, and the first two PGM outputs on the PC5208. If you use both the main panel and the PC5208 outputs, PGM3 will work identically to the first PC5208 output, and PGM4 will work identically to the second PC5208 output.

Section	PGM #	Output Type*	1	2	3	4	5	6	7	8
<i>PC5208</i>										
[505]	5	()	<input type="checkbox"/>	<input type="checkbox"/>	<input type="checkbox"/>	<input type="checkbox"/>	<input type="checkbox"/>	<input type="checkbox"/>	<input type="checkbox"/>	<input type="checkbox"/>
[506]	6	()	<input type="checkbox"/>	<input type="checkbox"/>	<input type="checkbox"/>	<input type="checkbox"/>	<input type="checkbox"/>	<input type="checkbox"/>	<input type="checkbox"/>	<input type="checkbox"/>
[507]	7	()	<input type="checkbox"/>	<input type="checkbox"/>	<input type="checkbox"/>	<input type="checkbox"/>	<input type="checkbox"/>	<input type="checkbox"/>	<input type="checkbox"/>	<input type="checkbox"/>
[508]	8	()	<input type="checkbox"/>	<input type="checkbox"/>	<input type="checkbox"/>	<input type="checkbox"/>	<input type="checkbox"/>	<input type="checkbox"/>	<input type="checkbox"/>	<input type="checkbox"/>
[509]	9	()	<input type="checkbox"/>	<input type="checkbox"/>	<input type="checkbox"/>	<input type="checkbox"/>	<input type="checkbox"/>	<input type="checkbox"/>	<input type="checkbox"/>	<input type="checkbox"/>
[510]	10	()	<input type="checkbox"/>	<input type="checkbox"/>	<input type="checkbox"/>	<input type="checkbox"/>	<input type="checkbox"/>	<input type="checkbox"/>	<input type="checkbox"/>	<input type="checkbox"/>
<i>PC5204</i>										
[511]	11	()	<input type="checkbox"/>	<input type="checkbox"/>	<input type="checkbox"/>	<input type="checkbox"/>	<input type="checkbox"/>	<input type="checkbox"/>	<input type="checkbox"/>	<input type="checkbox"/>
[512]	12	()	<input type="checkbox"/>	<input type="checkbox"/>	<input type="checkbox"/>	<input type="checkbox"/>	<input type="checkbox"/>	<input type="checkbox"/>	<input type="checkbox"/>	<input type="checkbox"/>
[513]	13	()	<input type="checkbox"/>	<input type="checkbox"/>	<input type="checkbox"/>	<input type="checkbox"/>	<input type="checkbox"/>	<input type="checkbox"/>	<input type="checkbox"/>	<input type="checkbox"/>
[514]	14	()	<input type="checkbox"/>	<input type="checkbox"/>	<input type="checkbox"/>	<input type="checkbox"/>	<input type="checkbox"/>	<input type="checkbox"/>	<input type="checkbox"/>	<input type="checkbox"/>

*Record here based on programming in [009], [010] and [011].

PGM Output Partition Assignment

Section	PGM #	Partition: 1	2	3	4	5	6	7	8
<i>Main Board</i>									
[551]	1	<input type="checkbox"/>	<input type="checkbox"/>	<input type="checkbox"/>	<input type="checkbox"/>	<input type="checkbox"/>	<input type="checkbox"/>	<input type="checkbox"/>	<input type="checkbox"/>
[552]	2	<input type="checkbox"/>	<input type="checkbox"/>	<input type="checkbox"/>	<input type="checkbox"/>	<input type="checkbox"/>	<input type="checkbox"/>	<input type="checkbox"/>	<input type="checkbox"/>
<i>Main Board / PC5208</i>									
[553]	3	<input type="checkbox"/>	<input type="checkbox"/>	<input type="checkbox"/>	<input type="checkbox"/>	<input type="checkbox"/>	<input type="checkbox"/>	<input type="checkbox"/>	<input type="checkbox"/>
[554]	4	<input type="checkbox"/>	<input type="checkbox"/>	<input type="checkbox"/>	<input type="checkbox"/>	<input type="checkbox"/>	<input type="checkbox"/>	<input type="checkbox"/>	<input type="checkbox"/>
<i>PC5208</i>									
[555]	5	<input type="checkbox"/>	<input type="checkbox"/>	<input type="checkbox"/>	<input type="checkbox"/>	<input type="checkbox"/>	<input type="checkbox"/>	<input type="checkbox"/>	<input type="checkbox"/>
[556]	6	<input type="checkbox"/>	<input type="checkbox"/>	<input type="checkbox"/>	<input type="checkbox"/>	<input type="checkbox"/>	<input type="checkbox"/>	<input type="checkbox"/>	<input type="checkbox"/>
[557]	7	<input type="checkbox"/>	<input type="checkbox"/>	<input type="checkbox"/>	<input type="checkbox"/>	<input type="checkbox"/>	<input type="checkbox"/>	<input type="checkbox"/>	<input type="checkbox"/>
[558]	8	<input type="checkbox"/>	<input type="checkbox"/>	<input type="checkbox"/>	<input type="checkbox"/>	<input type="checkbox"/>	<input type="checkbox"/>	<input type="checkbox"/>	<input type="checkbox"/>
[559]	9	<input type="checkbox"/>	<input type="checkbox"/>	<input type="checkbox"/>	<input type="checkbox"/>	<input type="checkbox"/>	<input type="checkbox"/>	<input type="checkbox"/>	<input type="checkbox"/>
[560]	10	<input type="checkbox"/>	<input type="checkbox"/>	<input type="checkbox"/>	<input type="checkbox"/>	<input type="checkbox"/>	<input type="checkbox"/>	<input type="checkbox"/>	<input type="checkbox"/>
<i>PC5204</i>									
[561]	11	<input type="checkbox"/>	<input type="checkbox"/>	<input type="checkbox"/>	<input type="checkbox"/>	<input type="checkbox"/>	<input type="checkbox"/>	<input type="checkbox"/>	<input type="checkbox"/>
[562]	12	<input type="checkbox"/>	<input type="checkbox"/>	<input type="checkbox"/>	<input type="checkbox"/>	<input type="checkbox"/>	<input type="checkbox"/>	<input type="checkbox"/>	<input type="checkbox"/>
[563]	13	<input type="checkbox"/>	<input type="checkbox"/>	<input type="checkbox"/>	<input type="checkbox"/>	<input type="checkbox"/>	<input type="checkbox"/>	<input type="checkbox"/>	<input type="checkbox"/>
[564]	14	<input type="checkbox"/>	<input type="checkbox"/>	<input type="checkbox"/>	<input type="checkbox"/>	<input type="checkbox"/>	<input type="checkbox"/>	<input type="checkbox"/>	<input type="checkbox"/>

Zone Follower PGM Zone Assignment

If a Zone Follower PGM type 29, 35-41 is used, the PGM Output Partition Assignment will be treated as a PGM Output Zone Assignment. Each Zone Follower PGM applies to a different bank of zones, as in the following table. Record the assignments above.

Option:	1	2	3	4	5	6	7	8
[29] Zone Follower (1-8)	Zone 1	Zone 2	Zone 3	Zone 4	Zone 5	Zone 6	Zone 7	Zone 8
[35] Zone Follower (9-16)	Zone 9	Zone 10	Zone 11	Zone 12	Zone 13	Zone 14	Zone 15	Zone 16
[36] Zone Follower (17-24)	Zone 17	Zone 18	Zone 19	Zone 20	Zone 21	Zone 22	Zone 23	Zone 24
[37] Zone Follower (25-32)	Zone 25	Zone 26	Zone 27	Zone 28	Zone 29	Zone 30	Zone 31	Zone 32
[38] Zone Follower (33-40)	Zone 33	Zone 34	Zone 35	Zone 36	Zone 37	Zone 38	Zone 39	Zone 40
[39] Zone Follower (41-48)	Zone 41	Zone 42	Zone 43	Zone 44	Zone 45	Zone 46	Zone 47	Zone 48
[40] Zone Follower (49-56)	Zone 49	Zone 50	Zone 51	Zone 52	Zone 53	Zone 54	Zone 55	Zone 56
[41] Zone Follower (57-64)	Zone 57	Zone 58	Zone 59	Zone 60	Zone 61	Zone 62	Zone 63	Zone 64

Extended Reporting Codes

[601]-[604] Closing (Arming) Reporting Codes, Access Codes 33-95

Section

[601]	Code 33	Code 34	Code 35	Code 36	Code 37	Code 38	Code 39	Code 40
	<input type="checkbox"/>	<input type="checkbox"/>	<input type="checkbox"/>	<input type="checkbox"/>	<input type="checkbox"/>	<input type="checkbox"/>	<input type="checkbox"/>	<input type="checkbox"/>
	Code 41	Code 42	Code 43	Code 44	Code 45	Code 46	Code 47	Code 48
[602]	<input type="checkbox"/>	<input type="checkbox"/>	<input type="checkbox"/>	<input type="checkbox"/>	<input type="checkbox"/>	<input type="checkbox"/>	<input type="checkbox"/>	<input type="checkbox"/>
	Code 49	Code 50	Code 51	Code 52	Code 53	Code 54	Code 55	Code 56
	<input type="checkbox"/>	<input type="checkbox"/>	<input type="checkbox"/>	<input type="checkbox"/>	<input type="checkbox"/>	<input type="checkbox"/>	<input type="checkbox"/>	<input type="checkbox"/>
[603]	Code 57	Code 58	Code 59	Code 60	Code 61	Code 62	Code 63	Code 64
	<input type="checkbox"/>	<input type="checkbox"/>	<input type="checkbox"/>	<input type="checkbox"/>	<input type="checkbox"/>	<input type="checkbox"/>	<input type="checkbox"/>	<input type="checkbox"/>
	Code 65	Code 66	Code 67	Code 68	Code 69	Code 70	Code 71	Code 72
[604]	<input type="checkbox"/>	<input type="checkbox"/>	<input type="checkbox"/>	<input type="checkbox"/>	<input type="checkbox"/>	<input type="checkbox"/>	<input type="checkbox"/>	<input type="checkbox"/>
	Code 73	Code 74	Code 75	Code 76	Code 77	Code 78	Code 79	Code 80
	<input type="checkbox"/>	<input type="checkbox"/>	<input type="checkbox"/>	<input type="checkbox"/>	<input type="checkbox"/>	<input type="checkbox"/>	<input type="checkbox"/>	<input type="checkbox"/>
[604]	Code 81	Code 82	Code 83	Code 84	Code 85	Code 86	Code 87	Code 88
	<input type="checkbox"/>	<input type="checkbox"/>	<input type="checkbox"/>	<input type="checkbox"/>	<input type="checkbox"/>	<input type="checkbox"/>	<input type="checkbox"/>	<input type="checkbox"/>
	Code 89	Code 90	Code 91	Code 92	Code 93	Code 94	Code 95	
	<input type="checkbox"/>	<input type="checkbox"/>	<input type="checkbox"/>	<input type="checkbox"/>	<input type="checkbox"/>	<input type="checkbox"/>	<input type="checkbox"/>	

[605]-[608] Opening (Disarming) Reporting Codes, Access Codes 33-95

Section

[605]	Code 33 _ _ _	Code 34 _ _ _	Code 35 _ _ _	Code 36 _ _ _	Code 37 _ _ _	Code 38 _ _ _	Code 39 _ _ _	Code 40 _ _ _
	Code 41 _ _ _	Code 42 _ _ _	Code 43 _ _ _	Code 44 _ _ _	Code 45 _ _ _	Code 46 _ _ _	Code 47 _ _ _	Code 48 _ _ _
[606]	Code 49 _ _ _	Code 50 _ _ _	Code 51 _ _ _	Code 52 _ _ _	Code 53 _ _ _	Code 54 _ _ _	Code 55 _ _ _	Code 56 _ _ _
	Code 57 _ _ _	Code 58 _ _ _	Code 59 _ _ _	Code 60 _ _ _	Code 61 _ _ _	Code 62 _ _ _	Code 63 _ _ _	Code 64 _ _ _
[607]	Code 65 _ _ _	Code 66 _ _ _	Code 67 _ _ _	Code 68 _ _ _	Code 69 _ _ _	Code 70 _ _ _	Code 71 _ _ _	Code 72 _ _ _
	Code 73 _ _ _	Code 74 _ _ _	Code 75 _ _ _	Code 76 _ _ _	Code 77 _ _ _	Code 78 _ _ _	Code 79 _ _ _	Code 80 _ _ _
[608]	Code 81 _ _ _	Code 82 _ _ _	Code 83 _ _ _	Code 84 _ _ _	Code 85 _ _ _	Code 86 _ _ _	Code 87 _ _ _	Code 88 _ _ _
	Code 89 _ _ _	Code 90 _ _ _	Code 91 _ _ _	Code 92 _ _ _	Code 93 _ _ _	Code 94 _ _ _	Code 95 _ _ _	

Automatic Disarming Schedule

Enter a four-digit number (HH:MM) for each day that the system will auto-disarm for each partition ([681] for Partition 1 through [688] for Partition 8). Valid entries are 0000-2359. All entries are disabled (9999) by default.

	Sunday	Monday	Tuesday	Wednesday	Thursday	Friday	Saturday
[681]	_ _ _	_ _ _	_ _ _	_ _ _	_ _ _	_ _ _	_ _ _
[682]	_ _ _	_ _ _	_ _ _	_ _ _	_ _ _	_ _ _	_ _ _
[683]	_ _ _	_ _ _	_ _ _	_ _ _	_ _ _	_ _ _	_ _ _
[684]	_ _ _	_ _ _	_ _ _	_ _ _	_ _ _	_ _ _	_ _ _
[685]	_ _ _	_ _ _	_ _ _	_ _ _	_ _ _	_ _ _	_ _ _
[686]	_ _ _	_ _ _	_ _ _	_ _ _	_ _ _	_ _ _	_ _ _
[687]	_ _ _	_ _ _	_ _ _	_ _ _	_ _ _	_ _ _	_ _ _
[688]	_ _ _	_ _ _	_ _ _	_ _ _	_ _ _	_ _ _	_ _ _

Auto-Disarm Holiday Schedule

Enter a six-digit number (MM:DD:YY) for each day that the system will skip auto-disarm for each partition ([691] for Partition 1 through [698] for Partition 8). Program [99][99][99] to disable Auto-Disarm schedule. All entries are disabled by default.

[691]	Holiday 1 _ _ _ _ _	Holiday 2 _ _ _ _ _	Holiday 3 _ _ _ _ _	Holiday 4 _ _ _ _ _	Holiday 5 _ _ _ _ _	Holiday 6 _ _ _ _ _	Holiday 7 _ _ _ _ _
	Holiday 8 _ _ _ _ _	Holiday 9 _ _ _ _ _	Holiday 10 _ _ _ _ _	Holiday 11 _ _ _ _ _	Holiday 12 _ _ _ _ _	Holiday 13 _ _ _ _ _	Holiday 14 _ _ _ _ _
[692]	Holiday 1 _ _ _ _ _	Holiday 2 _ _ _ _ _	Holiday 3 _ _ _ _ _	Holiday 4 _ _ _ _ _	Holiday 5 _ _ _ _ _	Holiday 6 _ _ _ _ _	Holiday 7 _ _ _ _ _
	Holiday 8 _ _ _ _ _	Holiday 9 _ _ _ _ _	Holiday 10 _ _ _ _ _	Holiday 11 _ _ _ _ _	Holiday 12 _ _ _ _ _	Holiday 13 _ _ _ _ _	Holiday 14 _ _ _ _ _
[693]	Holiday 1 _ _ _ _ _	Holiday 2 _ _ _ _ _	Holiday 3 _ _ _ _ _	Holiday 4 _ _ _ _ _	Holiday 5 _ _ _ _ _	Holiday 6 _ _ _ _ _	Holiday 7 _ _ _ _ _
	Holiday 8 _ _ _ _ _	Holiday 9 _ _ _ _ _	Holiday 10 _ _ _ _ _	Holiday 11 _ _ _ _ _	Holiday 12 _ _ _ _ _	Holiday 13 _ _ _ _ _	Holiday 14 _ _ _ _ _
[694]	Holiday 1 _ _ _ _ _	Holiday 2 _ _ _ _ _	Holiday 3 _ _ _ _ _	Holiday 4 _ _ _ _ _	Holiday 5 _ _ _ _ _	Holiday 6 _ _ _ _ _	Holiday 7 _ _ _ _ _
	Holiday 8 _ _ _ _ _	Holiday 9 _ _ _ _ _	Holiday 10 _ _ _ _ _	Holiday 11 _ _ _ _ _	Holiday 12 _ _ _ _ _	Holiday 13 _ _ _ _ _	Holiday 14 _ _ _ _ _

[695]	Holiday 1	Holiday 2	Holiday 3	Holiday 4	Holiday 5	Holiday 6	Holiday 7
	Holiday 8	Holiday 9	Holiday 10	Holiday 11	Holiday 12	Holiday 13	Holiday 14
[696]	Holiday 1	Holiday 2	Holiday 3	Holiday 4	Holiday 5	Holiday 6	Holiday 7
	Holiday 8	Holiday 9	Holiday 10	Holiday 11	Holiday 12	Holiday 13	Holiday 14
[697]	Holiday 1	Holiday 2	Holiday 3	Holiday 4	Holiday 5	Holiday 6	Holiday 7
	Holiday 8	Holiday 9	Holiday 10	Holiday 11	Holiday 12	Holiday 13	Holiday 14
[698]	Holiday 1	Holiday 2	Holiday 3	Holiday 4	Holiday 5	Holiday 6	Holiday 7
	Holiday 8	Holiday 9	Holiday 10	Holiday 11	Holiday 12	Holiday 13	Holiday 14

INTERNATIONAL PROGRAMMING

[700] Automatic Clock Adjust

Default = 60 Valid Entries 00-99 Seconds

[701] First International Options

Opt	Def	ON		OFF
1	<input type="checkbox"/>	50 Hz AC	✓	<input type="checkbox"/> 60 Hz AC
2	<input type="checkbox"/>	Time Base - Internal Crystal	✓	<input type="checkbox"/> Time Base - AC Line
3	<input type="checkbox"/>	AC/DC Arming Inhibit Enabled	✓	<input type="checkbox"/> AC/DC Arming Inhibit Disabled
4	<input type="checkbox"/>	All System Tamper Require Installer Reset	✓	<input type="checkbox"/> All System Tamper Follow Restore
5	<input type="checkbox"/>	6-digit User Access Codes	✓	<input type="checkbox"/> 4-digit User Access Codes
6	<input type="checkbox"/>	Busy Tone Detection Enabled	✓	<input type="checkbox"/> Busy Tone Detection Disabled
7	<input type="checkbox"/>	High Current Battery Charge	✓	<input type="checkbox"/> Standard Current Battery Discharge
8	<input type="checkbox"/>	DLS/Audio has no priority	✓	<input type="checkbox"/> DLS/Audio has priority

[702] Second International Options

Opt	Def	ON		OFF
1	<input type="checkbox"/>	Pulse Dialing Make/Break Ratio is 33/67	✓	<input type="checkbox"/> Pulse Dialing Make/Break Ratio is 40/60
2	✓ <input type="checkbox"/>	Force Dialing Enabled		<input type="checkbox"/> Force Dialing Disabled
3	<input type="checkbox"/>	Land Line Test Transmission in Minutes	✓	<input type="checkbox"/> Land Line Test Transmission in Days
4	<input type="checkbox"/>	1600 Hz Handshake	✓	<input type="checkbox"/> Standard Handshake
5	<input type="checkbox"/>	ID Tone Enabled	✓	<input type="checkbox"/> ID Tone Disabled
6	<input type="checkbox"/>	2100 Hz ID Tone	✓	<input type="checkbox"/> 1300 Hz ID Tone
7	<input type="checkbox"/>	One-Time 1-hr User Enabled DLS Window	✓	<input type="checkbox"/> Full 6-hr User Enabled DLS Window
8	<input type="checkbox"/>	Bell on FTC when Armed	✓	<input type="checkbox"/> FTC Trouble only when Armed

[703] Delay Between Dialing Attempts

Default = 003 Valid Entries 000-255 sec.

Module Programming

[801] PC5400 Printer Module Programming

Refer to the PC5400 *Installation Manual* for installation and programming instructions.

[802] PC59xx VOX Module Programming

Refer to the PC59xx *Installation Manual* for installation and programming instructions.

[804] Wireless Expansion Programming

Refer to the RF5132/RFK55xx *Installation Manual* for programming locations and instructions.

[805] PC5100 Programming

Refer to the PC5100 *Installation Manual* for programming locations and instructions.

[851] TL/GS Module Programming

Refer to the TL/GS *Installation Manual* for programming locations and instructions.

Special Installer Functions

[898] Wireless Enrollment

[899] Template Programming

[900] Panel Version Displayed

[901] Installer Walk Test Mode Enable/Disable

[902] Module Supervision Reset

[903] Module Supervision Field

[904] Wireless Module Placement Test

[905] - [909] For Future Use

[989] Default Master Code

[990][Installer Code][990] Installer Lockout Enable

[991][Installer Code][991] Installer Lockout Disable

[992] For Future Use

[993][Installer Code][993] Restore Alternate Communicator to Default Programming

[994] For Future Use

[995][Installer Code][995] Restore Escort5580 to Default Programming

[996][Installer Code][996] Restore RF5132 to Default Programming

[997][Installer Code][997] Restore PC5400 to Default Programming

[998][Installer Code][998] Restore PC59xx to Default Programming

[999][Installer Code][999] Restore Control Panel to Default Programming

For the Record

Customer: _____

Address: _____

Telephone: _____ Installation Date: _____

Installer's Code: _____

Module Name Description Location

PC1616/PC1832/PC1864	Main Panel	_____
_____	_____	_____
_____	_____	_____
_____	_____	_____
_____	_____	_____
_____	_____	_____
_____	_____	_____
_____	_____	_____

Keypads

Keypad Type

Location

Keypad 1	_____	_____
Keypad 2	_____	_____
Keypad 3	_____	_____
Keypad 4	_____	_____
Keypad 5	_____	_____
Keypad 6	_____	_____
Keypad 7	_____	_____
Keypad 8	_____	_____

Zone Programming Summary

Zone programming can be found in sections [001] - [004], [101] - [164], [020], [202] - [265]. Use this area to record a summary of your zone programming.

System Zone	Zone Label	Zone Type	System Zone	Zone Label	Zone Type
Zone 1			Zone 33		
Zone 2			Zone 34		
Zone 3			Zone 35		
Zone 4			Zone 36		
Zone 5			Zone 37		
Zone 6			Zone 38		
Zone 7			Zone 39		
Zone 8			Zone 40		
Zone 9			Zone 41		
Zone 10			Zone 42		
Zone 11			Zone 43		
Zone 12			Zone 44		
Zone 13			Zone 45		
Zone 14			Zone 46		
Zone 15			Zone 47		
Zone 16			Zone 48		
Zone 17			Zone 49		
Zone 18			Zone 50		
Zone 19			Zone 51		
Zone 20			Zone 52		
Zone 21			Zone 53		
Zone 22			Zone 54		
Zone 23			Zone 55		
Zone 24			Zone 56		
Zone 25			Zone 57		
Zone 26			Zone 58		
Zone 27			Zone 59		
Zone 28			Zone 60		
Zone 29			Zone 61		
Zone 30			Zone 62		
Zone 31			Zone 63		
Zone 32			Zone 64		

Section #	Reporting Code	Code Sent When...	Dialer Direction*	Automatic Contact ID Codes	SIA Auto Rep Codes**
[345]-[346]	TLM Failure/Restore	Telephone line monitoring trouble/Telephone line restored	MA/R	E(3)51-000/ R(3)51-000	LT-01/LR-01
[345]-[346]	Gen System Trouble/Rest.	"Service Required" trouble (view troubles using [*][2])/trouble restored	MA/R	E(3)AA-000/ R(3)AA-000	YX-00/YZ-00
[345]-[346]	Gen System Supervisory Trouble/Rest.	Control panel loses/restores communications with module(s) connected to the Keybus	MA/R	E(3)3A-000/ R(3)3A-000	ET-00/ER-00
[346]	Cold Start (System Reset)	The system has been restarted after a total power loss. The reporting code is sent after a 2 minute start-up delay	MA/R	R(3)A5-000	RR-00
[347]	Phone# 1 or 2 FTC Restoral	Control panel has restored communications to central station on Phone# 1 or 2 (after FTC)	MA/R	R(3)54-000	YK-00
[347]	Event Buffer is 75% Full	Event buffer is almost full since last upload	MA/R	E(6)22-000	JL-00
[347]	DLS Lead In	Downloading session start	MA/R	E(4)11-000	RB-00
[347]	DLS Lead Out	Downloading session complete	MA/R	E(4)12-000	RS-00
[347]	Zone Fault/Rest.	One or more zones have faults/restored	MA/R	E(3)8A-ZZZ/ R(3)8A-ZZZ	UT-ZZ/UJ-ZZ
[347]	Delinquency	Programmed amount of time (days or hours) for delinquency has expired without zone activity, or without system being armed	MA/R	E(6)54-000***	CD-00
[347]	Wireless Device Low Battery Trouble/Rest.	Wireless zones, panic pendants, handheld keypads, wireless keys have low battery/all low batteries restored	MA/R	E(3)84-000/ R(3)84-000	XT-00/XR-00 XT-ZZ/XR-ZZ****
[347]	Installer Lead In/Lead Out	Installer's mode has been entered/exited	MA/R	E(6)27-000/ E(6)28-000	LB-00/LS-00
[348]	Walk Test End/Begin	End of test/Beginning of test	T	R(6)A7-UUU/ E(6)A7-UUU	TE-00/TS-00
[348]	Periodic Test with Trouble	Periodic system test transmission with trouble	T	E(6)A8-000	RY-00
[348]	Periodic Test	Periodic system test transmission	T	E(6)A2-000	RP-00
[348]	System Test	[*][6] bell/communications test	T	E(6)A1-000	RX-00
[349]	PC5700 Ground Fault Trouble/Rest	Ground/Fault/Trouble occurs on the PC5700	MA/R	E(3)1A-000	US-00/UR-00
[349]	PC5700 TLMLine 1 Trouble/Rest.	TLM Trouble /Restore occurs on the PC5700	MA/R	E(3)51-000/ R(3)51-000	LT-01/LR-01
[349]	PC5700 TLMLine 2 Trouble/Rest.	TLM Trouble /Restore occurs on the PC5700	MA/R	E(3)52-000/ R(3)52-000	LT-02/LR-02
[601]-[604]	Closings	System armed (user 33-95 indicated)	O/C	R(4)A1-UUU	CL-UU
[605]-[608]	Openings	System disarmed (user 33-95 indicated)	O/C	E(4)A1-UUU	OP-UU
* A/R = alarms/restorals; T/R = tampers/restorals; O/C = openings/closings; MA/R = miscellaneous alarms/restorals; T = test transmissions					
** UU = user number (User 01-95); ZZ = zone number (01-64)					
*** Use the "Fail to close" event code [(4)54] to report closing or activity delinquency. Ensure the central station is aware that this code is used.					
**** Zones are identified, panic pendants, wireless keys, and handheld keypads are not.					

Table 2: Contact ID Programmed Zone Alarm/Restoral Event Codes
(as per SIA DCS: "Contact ID" 01-1999): Program any of these codes for zone alarms/restorals when using the standard (non-automatic) Contact ID reporting format.

Medical Alarms	(1)34 Entry / Exit
(1)AA Medical	(1)35 Day / Night
(1)A1 Pendant Transmitter	(1)36 Outdoor
(1)A2 Fail to Report In	(1)37 Tamper
Fire Alarms	(1)38 Near Alarm
(1)1A Fire Alarm	General Alarms
(1)11 Smoke	(1)4A General Alarm
(1)12 Combustion	(1)43 Exp. module failure
(1)13 Water Flow	(1)44 Sensor tamper
(1)14 Heat	(1)45 Module Tamper
(1)15 Pull Station	(1)4A Cross Zone Police Code
(1)16 Duct	24 Hour Non-Burglary
(1)17 Flame	(1)5A 24 Hour non-Burg
(1)18 Near Alarm	(1)51 Gas detected
Panic Alarms	(1)52 Refrigeration
(1)2A Panic	(1)53 Loss of Heat
(1)21 Duress	(1)54 Water Leakage
(1)22 Silent	(1)55 Foil Break
(1)23 Audible	(1)56 Day Trouble
Burglar Alarms	(1)57 Low bottled Gas level
(1)3A Burglary	(1)58 High Temp
(1)31 Perimeter	(1)59 Low Temp
(1)32 Interior	(1)61 Loss of Air Flow
(1)33 24 Hour	

Table 3: Automatic Zone Alarm/Restoral Codes

Zone Definition	SIA Auto Rep Codes*	Contact ID Alarm Auto Rep Codes*	Contact ID Rest. Auto Rep Codes
Delay 1	BA-ZZ/BH-ZZ	E(1)3A-ZZZ	R(1)3A-ZZZ
Delay 2	BA-ZZ/BH-ZZ	E(1)3A-ZZZ	R(1)3A-ZZZ
Instant	BA-ZZ/BH-ZZ	E(1)3A-ZZZ	R(1)3A-ZZZ
Interior	BA-ZZ/BH-ZZ	E(1)3A-ZZZ	R(1)3A-ZZZ
Interior Stay/Away	BA-ZZ/BH-ZZ	E(1)3A-ZZZ	R(1)3A-ZZZ
Delay Stay/Away	BA-ZZ/BH-ZZ	E(1)3A-ZZZ	R(1)3A-ZZZ
Delayed 24-Hr Fire	FA-ZZ/FH-ZZ	E(1)1A-ZZZ	R(1)1A-ZZZ
Standard 24-Hr Fire	FA-ZZ/FH-ZZ	E(1)1A-ZZZ	R(1)1A-ZZZ
24-Hr Supervisory	US-ZZ/UR-ZZ	E(1)5A-ZZZ	R(1)5A-ZZZ
24-Hr Supervisory Buzzer	UA-ZZ/UH-ZZ	E(1)5A-ZZZ	R(1)5A-ZZZ
24-Hr Burglary	BA-ZZ/BH-ZZ	E(1)3A-ZZZ	R(1)3A-ZZZ
24-Hr Holdup	HA-ZZ/HH-ZZ	E(1)22-ZZZ	R(1)22-ZZZ
24-Hr Gas	GA-ZZ/GH-ZZ	E(1)51-ZZZ	R(1)51-ZZZ
24-Hr Heat	KA-ZZ/KH-ZZ	E(1)58-ZZZ	R(1)58-ZZZ
24-Hr Auxiliary (Medical)	MA-ZZ/MH-ZZ	E(1)AA-ZZZ	R(1)AA-ZZZ
24-Hr Panic	PA-ZZ/PH-ZZ	E(1)2A-ZZZ	R(1)2A-ZZZ
24-Hr Emerg. (non-medical)	QA-ZZ/QH-ZZ	E(1)A1-ZZZ	R(1)A1-ZZZ
24-Hr Sprinkler	SA-ZZ/SH-ZZ	E(1)13-ZZZ	R(1)13-ZZZ
24-Hr Water	WA-ZZ/WH-ZZ	E(1)54-ZZZ	R(1)54-ZZZ
24-Hr Freeze	ZA-ZZ/ZH-ZZ	E(1)59-ZZZ	R(1)59-ZZZ
24-Hr Latching	UA-ZZ/UH-ZZ	E(1)4A-ZZZ	R(1)4A-ZZZ
Interior Delay	BA-ZZ/BH-ZZ	E(1)3A-ZZZ	R(1)3A-ZZZ
Auto Verified Fire	FA-ZZ/FH-ZZ	E(1)1A-ZZZ	R(1)1A-ZZZ
24-Hr Fire Supervisory	FS-ZZ/FV-ZZ	E(2)AA-ZZZ	R(2)AA-ZZZ
Day Zone	BA-ZZ/BH-ZZ	E(1)3A-ZZZ	R(1)3A-ZZZ
Instant Stay/Away	BA-ZZ/BH-ZZ	E(1)3A-ZZZ	R(1)3A-ZZZ
24-Hr Bell/Buzzer	UA-ZZ/UH-ZZ	E(1)5A-ZZZ	R(1)5A-ZZZ
24-Hr Non-latching Tamper	UA-ZZ/UH-ZZ	E(1)4A-ZZZ	R(1)4A-ZZZ
Night Zone	BA-ZZ/BH-ZZ	E(1)3A-ZZZ	R(1)3A-ZZZ
Delayed 24-Hr Fire (Wireless)	FA-ZZ/FH-ZZ	E(1)1A-ZZZ	R(1)1A-ZZZ
Standard 24-Hr Fire(Wireless)	FA-ZZ/FH-ZZ	E(1)1A-ZZZ	R(1)1A-ZZZ
24-Hr CO Alarm	GA-ZZ/GH-ZZ	E(1)62-ZZZ	R(1)62-ZZZ

* ZZ or ZZZ= zones 01-64

Appendix B: UL Listed Commercial and Residential Installations

The control panel model PC1616/PC1832/PC1864 has been tested and found in compliance with the following standard:

UL1610	Central-Station Burglar-Alarm Units
UL365	Police Station Connected Burglar Alarm Units and Systems
UL1023	Household Burglar-Alarm System Units
UL985	Household Fire Warning System Units
UL1635	Digital Alarm Communicator System Units
ULC-S304-06	Signal Receiving Centre & Premise Burglar Alarm Control Units
ULC-S559-04	Equipment for Fire Signal Receiving Centres and Systems
ULC-S545-02	Residential Fire Warning System Control Units
ORD-C1023-1974	Household Burglar-Alarm System Units

This product has also been tested and found in compliance with the ANSI/SIA CP-01-2000 Control Panel Standard - Features for False Alarm Reduction

This product is UL/ULC listed under the following categories:

AMCX/AMCXC	Central Stations Alarm Units
APAW	Police-station-connected Alarm Units
DAYRC	Central Station Fire Alarm System Units
UTOU/UTOUC	Control Units and Accessories, Household System Type
NBSX/NBSXC	Household Burglar Alarm System Units
AMTB	Control Panels, SIA False Alarm Reduction

The product is labeled with the UL and ULC listing marks along with the SIA CP-01 compliance statement (Also Classified in accordance with SIA-CP-01 Standard) as proof of compliance with the above mentioned standards. For further information on this product's listings please also refer to the official listing guides published at the UL web site (www.ul.com) under Certifications Section or ULC web site (www.ulc.ca) under Online Directories.

UL/ULC Installations Required Programming Options

- All burglary-type zones shall be configured with SEOL or DEOL configuration (refer to section [013], option 1 shall be OFF)
- Use at least one Smoke Detector for Fire Installations (refer to section [001], fire zone shall be programmed as type 08 (hardwired) or 88 (wireless))
- The entry delay shall not exceed 60 seconds (refer to section [005])
- The exit delay shall not exceed 120 seconds (refer to section [005])
- The minimum Bell Time-out is 4 minutes (refer to section [005])

For ULC Residential Fire Installations the minimum Bell Time-out is 5 min.

For UL Home Health Care Installations the minimum Bell Time-out is 5 min.

For UL Commercial Burglary Installations minimum Bell Time-out is 15 min.

- Temporal Three Fire Signal shall be enabled (Section [013], option 8 shall be ON)
- Arm/Disarm Bell Squawk shall be enabled when using wireless key WS4939 (refer to section [014], option 1 shall be ON)
- A code will be required for bypassing (Section [015], option 5 shall be ON)
- Trouble beeps shall be enabled (Section [023], option 7 shall be ON)
- AC trouble indication LED shall be enabled (refer to Keypad Programming, section [075], options 5 and 6 shall be ON)
- DACT Communicator shall be enabled for Supervising Station Monitoring (refer to section [380], option 1 shall be ON)

The DACT communicator for this product has no line security.

- Telephone Line Monitoring (TLM) shall be enabled (refer to section [015], option 7 shall be ON)

The product shall be programmed to perform 5 (min.) to 10 (max.) attempts for communication of an event to the supervising station. If unsuccessful, a Fail To Communicate (FTC) trouble is generated.

- Test transmission cycle shall be set for monthly transmission (see Section [377])

For ULC Residential/Commercial installations set for daily test transmission

UL Central Station and Police Connect with Standard or Encrypted Line Security Service

- The installation must use the T-Link TL250 or T-Link TL300 Internet/Intranet communicator which communicates over LAN/WAN/Internet to the SG-System II or SG-System II receivers.
- Polling time shall be 200 seconds and compromise detection time shall be 6 min.
- For Encrypted line security applications, the T-Link TL250 or TL300 shall have the Encryption Key enabled (AES128 bit encryption algorithm is validated under NIST Certificate No. 109).

UL Local, Central Station and Police Connect with No Line Security Service

- The installation shall use a Bell which is UL Listed for Mercantile local alarms (i.e. AMSECO MBL10B with model AB-12 bell housing).
- The digital communicator shall be enabled
- The control panel shall be in the attack resistant enclosure DSC Model CMC-1 or PC4050CAR

UL Home Health Care Signaling Equipment

- There must be at least two keypads, one of either one of the compatible keypads models PK5500, PK5501, PK5508, PK5516
- Each system shall be programmed to activate an audible Trouble signal within 90 seconds upon loss of microprocessor memory

ULC Central Station Fire and Burglary Monitoring Installations

- For installation requirements, levels of security, communication modules and configurations (Refer to the ULC Installation Information Sheet, DSC #29002157)
- Use a CSA/cUL approved transformer (hardwired connections required for Fire Monitoring)
- All tamper circuits may be connected to the same zone

Programming

The notes in the programming sections describing the system configurations for UL/ULC listed installations shall be implemented

Control of the Protected Premises

In order to have a UL certified system the protected area is to be under the responsibility of one ownership and management (i.e., one business under one name). This may be a group of buildings attached or unattached with different addresses but under the responsibility of someone having mutual interest. The person of the mutual interest is not the alarm-installing company.

Bell Location

The alarm sounding device (bell) shall be located where it can be heard by the person operating the security system during the daily arming and disarming cycle.

Protection of the Control Unit

The local control unit and the local power supply must be protected in one of the following ways:

- The control unit and audible alarm device must be in a protected area which is armed 24 hours a day.
- Each partition must arm the area protecting the control unit and the audible alarm device power supply. This may require duplicate protection armed by each partition. Access to this protected area, without causing an alarm, will require that all partitions be disarmed.
- In all cases described above, the protected area for the control unit must be programmed as not-bypassable.

Casual Users

The installer should caution the user(s) not to give system information (e.g. codes, bypass methods, etc.) to casual users (baby-sitters or service people). Only the One-Time Use codes shall be given to casual users.

User Information

The installer should advise the users and note in the User's Manual:

- Service organization name and telephone number
- The programmed exit time
- The programmed entry time
- Test system weekly
- The installer's code cannot arm or disarm the system

SIA False Alarm Reduction Installations

Minimum required system consists of one Control unit model PC1864 or PC1832 or PC1616 and any one of the compatible listed keypads: PK5500, PK5501, PK5508, PK5516, PKP-LCD, PKP-ICN. For a list of the defaults value programmed when the unit is shipped from the factory and for any other programming information refer to Appendix C: False Alarm Reduction.

The following optional subassembly modules also bear the SIA CP-01-2000 classification and may be used if desired: PC5108 Zone Expander, PC5208 PGM Output Module, PC5204 Auxiliary Power Supply and PC5400 Serial Output Module.

CAUTION

- For SIA FAR installations use only modules/devices that are listed on this page
- Fire Alarm Verification feature (Auto Verified Fire Zone type [29]) is not supported on 2-wire smoke detectors zones. This feature may be enabled for 4-wire smoke detectors only. The fire alarm delay is 60s.
- Call Waiting Cancel (Section [382], Option 4) feature on a non-Call Waiting line will prevent successful communication to the supervising station.
- All smoke detectors on the system must be tested annually by conducting the Installer Walk Test. Prior to exiting the walk test mode, a sensor reset must be conducted on the system, [*][7][2] to reset all latching 4-wire smoke detectors. Please refer to the smoke detector installation instructions on how to correctly test the detectors.

NOTES

- Programming at installation may be subordinate to other UL requirements for the intended application
- Cross zones have the ability to individually protect the intended area (e.g. motion detectors which overlap)
- Cross zoning is not recommended for line security Installations nor is to be implemented on exit/entry zones.
- There is a communication delay of 30 seconds in this control panel. It can be removed, or it can be increased up to 45 seconds at the option of the end user by consulting with the installer.
- Do not duplicate any reporting codes. This applies for all communication formats other than SIA or CID sending automatic programmed reporting codes.
- The security system shall be installed with the sounding device activated and the communicator enabled for transmission using SIA or CID format.

Appendix C: SIA False Alarm Reduction

SIA Feature Programming Section	Comments	Range/Default	Requirement
Exit Time - [005], 3rd entry	Access to Entry and Exit delays for each partition and Bell Time Out for the system	For Full or auto arming: Range: 45-255 seconds Default: 60 sec.	Required (programmable)
Progress Annunciation/Disable - for Silent Exit - [014], Option 6 ON	Enables audible exit beeps from the keypad for the duration of exit delay	Individual keypads may be disabled Default: All Enabled	Allowed
Exit Time Restart - [018], Option 7 ON	Enables the exit delay restart feature	Default: Enabled	Required
Auto Stay Arm on Unvacated Premises - [001]-[004] Zone type 05, 06	Function Key: Stay Arming. All Stay/Away type zones (05, 06) will be automatically bypassed	If no exit after full arm Default: Enabled	Required
Exit Time and Progress Annunciation/Disable or Remote Arming - [005] and [014] bit 6	System Times and Audible Exit beeps can be disabled when using the Key fob to arm away the system	Default: Enabled	Allowed
Entry Delay(s) - [005], 1st and 2nd entry	Access to Entry and Exit delays for each partition and Bell Time Out for the system. NOTE: Combined Entry delay and Communications Delay (Abort Window) shall not exceed 60s	Range: 30 sec. to 4 min. Default: 30 sec.	Required (programmable)
Abort Window for Non-Fire zones - [101]-[164] bit 7 ON	Access to zone attributes, i.e., swinger shutdown, transmission delay and cross zone. Individual zones attribute bit 7 (Transmission delay) is by default ON	May be disabled by zone or zone type Default: Enabled	Required
Abort Window - for Non-Fire zones - [377], 4th entry	Access to the programmable delay before communicating alarms. NOTE: Combined Entry delay and Communications Delay (Abort Window) shall not exceed 60s	Range: 15 - 45 sec. Default: 30 sec.	Required (programmable)
Abort Annunciation - [382], Option 3 ON	Enables the "Communication Cancelled" message display on all keypads	Annunciate that no alarm was transmitted Default: Enabled	Required
Cancel Annunciation - [328], 8th entry	Access to the reporting code for Alarm Cancelled	Annunciate that a Cancel was transmitted Default: Enabled	Required
Duress Feature - [*][5] Master Code - [99] Option 2 ON	Do not derive code from an existing Master/User code (e.g., Master code is 1234, the duress code should not be 1233 or 1235)	No 1+/- derivative of another user code. No duplicates with other user codes Default: disabled	Allowed
Cross Zoning - [018] Option 6 ON [101]-[164] bit 9 OFF	This option enables Cross Zoning for entire system. Individual zones can be enabled for Cross zoning via Zone attribute bit 9 in sections [101] - [164]	Programming required Default: Disabled	Required
Cross Zone Timer - [176]	Access to the programmable Cross Zone timer	May program Range: 001-255 sec. Default: 60 secs	Allowed
Swinger Shutdown for Alarms [377] 1st entry	Access to the swinger shutdown limit for zone alarms	For all non-fire zones shut down at 1 or 2 trips Default: 1 Trip	Required (programmable)
Swinger Shutdown Disable - [101] - [164] bit 6 ON	Access to zone attributes, i.e., swinger shutdown, transmission delay and cross zone. Individual zones attribute bit 6 (Swinger shutdown enabled) is by default ON	For non-police response zones Default: Enabled	Allowed
Fire Alarm Verification - Zone Type [29]	Auto Verified Fire, use only with 4 wire type detectors that can be reset by the panel 4-wire smoke detector powered from AUX + and PGM1 - PGM4 (type 03, Sensor reset)	70 seconds reset and confirmation time Default: disabled	Required
Call Waiting Cancel Dial String - [304], [382], Opt. 4 OFF	Access to the dialing sequence used to disable call waiting	Dependant on user phone line Default: disabled	Required
Testing			
System Test: [*][6] Master Code, Option 4	The system activates all keypad sounders, bells or sirens for 2 seconds and all keypad lights turn on. Refer to the User Manual (part no. 29008261).		
Installer Walk Test Mode: [901]	This mode is used to test each zone on the system for proper functionality.		
Alarm Communications During Walk Test [382] Opt. 2	Enables Communication of zone alarms while installer Walk Test is active.		
Walk Test End and Begin Reporting Codes [348], 1 st and 2 nd Entries	Access to the reporting codes for Walk Test Begin and Walk Test End.		

Appendix D: Troubleshooting Guide

Testing:

- Power up system
- Program options as required (See Programming Section)
- Violate, then restore zones
- Verify correct **Reporting Codes** are sent to the Central Station

Troubleshooting:

LCD Programmable-Message Keypad

- Press **[*][2]** to view a trouble condition.
- The trouble light will flash and the LCD will display the first trouble condition present.
- Use the arrow keys to scroll through all trouble conditions present.

NOTE: When additional information is available for a specific trouble condition a **[*]** will appear on the display.

Press the **[*]** key to view the additional information

LED Keypads, LCD Fixed Message Keypads

- Press **[*][2]** to view a trouble condition.
- The trouble light will flash.
- Refer to the **Trouble Summary** chart below to determine the trouble condition(s) present.

Trouble Summary:

Light [1][*] Service Required - Press [1] for more information

- [1] Low Battery
- [2] Bell Circuit
- [3] General System Trouble
- [4] General system Tamper
- [5] Module Supervision
- [6] RF Jam Detected
- [7] PC5204 Low Battery
- [8] PC5204 AC Failure

Light [2] AC Trouble

Light [3] Telephone Line Trouble

Light [4] Failure to Communicate

Light [5][*] Zone Fault -Press [5] for more information

Light [6][*] Zone Tamper - Press [6] for more information

Light [7][*] Wireless Device Low Battery - Press [7] for more information

Light [8] Loss of Time or Date

Trouble	Cause	Troubleshooting
Trouble [1] Service Required		Press [1] to determine specific trouble
[1] Low Battery	Main panel battery less than 11.1VDC <i>NOTE: This trouble condition will not clear until the battery voltage is 12.5VDC min., under load.</i>	<i>NOTE: If battery is new allow 1 hour for battery to charge.</i> <ul style="list-style-type: none"> Verify voltage measured across AC terminals is 16-18 VAC. Replace transformer if required Disconnect battery wire leads Verify battery charging voltage measured across battery leads = 13.70 - 13.80 VDC. Connect battery, remove AC power Verify measured voltage across battery terminals is 12.5VDC min.
[2] Bell Circuit	Bell+, Bell-...Open Circuit	<ul style="list-style-type: none"> Disconnect Bell-/Bell+ wire leads, measure resistance of wire leads. Open circuit indicates break in wiring or defective siren/bell Jumper Bell+, Bell- with 1K resistor (Brown, Black, Red) Verify trouble clears
[3] General System Trouble	PC5204 Output#1 Open Circuit	<ul style="list-style-type: none"> If Output #1 is unused: Ensure that terminals O1, AUX are jumpered with 1K resistor (Brown, Black, Red) If Output #1 is used: Disconnect wire leads from O1, AUX terminals, measure the resistance of the wire leads Open circuit indicates a break in the wiring
	PC5204 AUX	<ul style="list-style-type: none"> Verify voltage measured across AC input terminals is 16-18VAC. Disconnect all connections to PC5204 AUX terminal. Verify AUX voltage is 13.70 - 13.80 VDC.
	Printer connected to PC5400 offline	Verify printer operation (out of paper, paper jam etc.)
	T-Link Network Fault present T-Link Receiver Trouble present T-Link Interface Trouble present	Refer to the TL/GS Installation Manual for details.
[4] General System Tamper	Tamper input on module(s) open circuit	Short tamper terminal to COM terminal on unused modules connected to KEYBUS (PC5100, PC5108, PC5200, PC5204, PC5208, PC5320, PC5400, PC5700).
[5] Module Supervision	Panel does not communicate with module(s) on KEYBUS Keypad assigned to incorrect slot.	Modules are immediately enrolled and supervised when detected on the KEYBUS. If a module has been removed, or if the slot assignment of a keypad has been changed, module supervision must be reset. <ul style="list-style-type: none"> View the event buffer (via DLS or LCD5500 keypad) to identify the specific module(s) in trouble To reset module supervision: <ul style="list-style-type: none"> Enter Program Section [902]. Press [#] (wait 1 minute for panel to scan KEYBUS). Enter Program Section [903] to identify modules connected to the KEYBUS.
[6] RF Jam Detected	Wireless Receiver - excessive noise detected.	Check for external 433MHZ signal sources To disable RF Jam: enable Option [7] in program section [804] subsection [90].
[7] PC5204 Low Battery	PC5204 battery less than 11.5VDC <i>NOTE: This trouble condition will not clear until the battery voltage is 12.5VDC min., under load.</i>	See [1] Low Battery above
[8] PC5204 AC Failure	No AC at PC5204 AC inputs	Verify voltage measured across AC terminals is 16-18VAC. Replace transformer if required.

Trouble	Cause	Troubleshooting
Trouble [2] AC Failure		
	No AC at panel AC input terminals	Verify voltage measured across AC terminals is 16-18VAC. Replace transformer if required.
Trouble [3] Telephone Line Trouble		
	Phone Line Voltage at TIP, RING on main panel less than 3VDC	<ul style="list-style-type: none"> • Measure the voltage across TIP and RING on the panel: <ul style="list-style-type: none"> No phone off-hook – 50VDC (approx) Any phone off-hook – 5VDC (approx) • Wire incoming line directly to TIP and RING. If trouble clears, check wiring or the RJ-31 phone jack.
Trouble [4] Failure to Communicate		
	Panel fails to communicate one or more events to central station	Connect a handset to TIP and RING of the control panel. Monitor for the following conditions: <ul style="list-style-type: none"> • Continuous dial tone <ul style="list-style-type: none"> - Reverse TIP and RING • Recorded operator message comes on <ul style="list-style-type: none"> - Verify correct phone number is programmed - Dial the number programmed using a regular telephone to determine if a [9] must be dialed or if 800 service is blocked. • Panel does not respond to handshakes. <ul style="list-style-type: none"> - Verify the format programmed is supported by the central station. • Panel transmits data multiple times without receiving a handshake <ul style="list-style-type: none"> - Verify that the account number and reporting codes are correctly programmed. • Contact ID and Pulse formats <ul style="list-style-type: none"> Program a HEX [A] to transmit a digit [0] • SIA format <ul style="list-style-type: none"> Program a digit [0] to transmit a digit [0]
Trouble [5] Zone Fault Press [5] to determine specific zones with a fault trouble		
	Open circuit is present on one or more fire zones on the main panel or zone expander	<ul style="list-style-type: none"> • Ensure fire zones have a 5.6K resistor (Green, Blue, Red) connected. • Remove the wire leads from Z and COM terminals and measure the resistance of the wire leads. <ul style="list-style-type: none"> - An open circuit indicates a break in the wiring or resistor not connected. • Connect a 5.6K resistor (Green, Blue, Red) across the Z and COM terminals. Verify the trouble condition clears.
	An open circuit is present on PGM2 being used as a 2-wire smoke detector input	<ul style="list-style-type: none"> • Ensure the correct 2.2K end-of-line resistor is connected (Red, Red, Red). • Remove the wire leads from PGM2 and AUX+ terminals and measure the resistance of the wire leads. <ul style="list-style-type: none"> - An open circuit indicates a break in the wiring or no resistor connected. • Connect a 2.2K resistor (Red, Red, Red) across the PGM2 and AUX+ terminals. Verify the trouble condition clears.
	One or more wireless devices have not checked in within the programmed time	<ul style="list-style-type: none"> • If the trouble occurs immediately, a conflict with a hard wired zone exists: <ul style="list-style-type: none"> - The zone being used is already assigned to a PC5108 zone expander - The zone being used is assigned as a keypad zone • Perform a Module Placement Test – Program Section [904] and verify the wireless device is in a good location. <ul style="list-style-type: none"> - If bad test results occur, test the wireless device in another location - If the wireless device now tests good, the original mounting location is bad - If the wireless device continues to give bad test results replace the wireless device
	A short circuit is present on one or more zones with double end-of-line resistors enabled	<ul style="list-style-type: none"> • Remove the wire leads from Z and COM terminals and measure the resistance of the wire leads. <ul style="list-style-type: none"> - A short circuit indicates a short in the wiring. • Connect a 5.6K resistor (Green, Blue, Red) across the Z and COM terminals. <ul style="list-style-type: none"> - Verify the trouble condition clears.

Appendix E: Template Programming

Template programming allows quick programming of the minimum functions required for basic operation. The below tables are used to determine the desired template to be used (for information on performing template programming see Section 4 – Programming Descriptions). Each digit represents 1 of the template sections listed below. The option number selected for each digit will make up the 5 digit template programming code.

- Digit 1 selects Zone 1-8 definition options**

Digit 1 selects 1 of the following 6 options for zone definitions for the first 8 zones. A “0” in the digit 1 location indicates that the default settings for the first 8 zones are in place unless overridden. See Sections [001] to [004] on pages 30-31 for defaults.

Option	Zn1	Zn2	Zn3	Zn4	Zn5	Zn6	Zn7	Zn8
1	1	3	3	3	4	4	4	4
2	1	3	3	5	5	5	5	8
3	1	3	3	5	5	5	5	7
4	1	1	3	3	3	3	3	3
5	1	3	3	6	5	5	5	5
6	1	3	3	6	5	5	5	8

Refer to Section 4 for Zone definition details

- | | |
|---|-----------------------|
| 1 | Delay 1 |
| 2 | Delay 2 |
| 3 | Instant |
| 4 | Interior |
| 5 | Interior Stay/Away |
| 6 | Delayed Stay/Away |
| 7 | Delayed 24-Hour Fire |
| 8 | Standard 24-Hour Fire |

- Digit 2 selects system EOL configuration options**

Option		[013] Opt 1	[013] Opt 2
1	NC Loops	ON	OFF
2	SEOL	OFF	OFF
3	DEOL	OFF	ON

- Digit 3 selects panel communications options**

Option	Phone Line 1	Programming Section	Phone Line 2	Programming Section
1	Disabled	[380] Opt 1 OFF	Disabled	[380] Opt 1 OFF
2	SIA automatic Reporting Codes enabled	[350] 1st Phone # [04] [380] Opt 1 ON [381] Opt 3 OFF	SIA automatic Reporting Codes enabled	[350] 2nd Phone # [XX]
3	Contact ID Reporting Codes enabled	[350] 1st Phone # [03] [380] Opt 1 ON [381] Opt 7 OFF	SIA automatic Reporting Codes enabled	[350] 2nd Phone # [XX]
4	SIA automatic Reporting Codes enabled	[350] 1st Phone # [04] [380] Opt 1 ON [381] Opt 3 OFF	Residential Dial Enabled	[350] 2nd Phone # [06]
5	Contact ID Reporting Codes enabled	[350] 1st Phone # [03] [380] Opt 1 ON / Opt 7 OFF	Residential Dial Enabled	[350] 2nd Phone # [06]
6	Contact ID Reporting Codes enabled	[350] 1st Phone # [03] [380] Opt 1 ON [381] Opt 7 OFF	Contact ID Reporting Codes Enabled	[350] 2nd Phone # [03]

- Digit 4 selects reporting code configurations**

Option	Common Group	Selected Troubles	Openings/Closings	Zone Restorals	DLS/Installer Lead In/Out
1	✓			✗	✗
2	✓	✓		✗	✗
3	✓		✓	✗	✗
4	✓	✓	✓	✗	✗
5	✓	✓			✗
6	✓		✓		✗
7	✓	✓	✓		✗
8	✓				

✓ indicates included, Blank indicates default setting, ✗ indicates disabled

Common Group

Description	Phone 1	Phone 2	Sections
Set all Reporting Codes to automatic			[320] - [349], [601] - [608] FF
Alarm/Restore call directions enabled	✓		[351][1] ON, [2] OFF
Tamper/Restore Call directions disabled	✓	✓	[359][1] OFF, [2] OFF
Opening/Closing Call directions disabled	✓	✓	[367][1] OFF, [2] OFF
Maintenance Call Directions enabled	✓		[375][1] ON, [2] OFF
Test Transmission Call directions disabled	✓	✓	[376][1] OFF, [2] OFF

Selected Troubles

Trouble	[345] Alarms	[346] Restoral
Battery	FF	FF
AC Failure	00	00
Bell Circuit	FF	FF
Fire, Alarm	FF	FF
Aux PS	FF	FF
TLM	00	FF
General System	00	00
General System Supervisory	FF	FF
FF = Communicate in automatic format , 00 = Disabled		

Openings & Closings

Users	CLOSINGS, Residential Dial Reporting codes								Section
1-8	51	52	53	54	55	56	57	58	[339]
9-16	61	62	63	64	65	66	67	68	[339]
17-24	71	72	73	74	75	76	77	78	[340]
25-32	81	82	83	84	85	86	87	88	[340]
33-40	FF	FF	FF	FF	FF	FF	FF	98	[601]
Users	OPENINGS, Residential Dial Reporting codes								Section
1-8	11	12	13	14	15	16	17	18	[342]
9-16	21	22	23	24	25	26	27	28	[342]
17-24	31	32	33	34	35	36	37	38	[343]
25-32	41	42	43	44	45	46	47	48	[343]
33-40	FF	FF	FF	FF	FF	FF	FF	98	[605]
Enable Opening/Closings call directions for Phone 2									[367]

Zone Restorals

Zones	Alarm Restoral Reporting Codes								Section
1-64	00	00	00	00	00	00	00	00	[324]-[327]
00 = Disabled									

DLS/Installer Lead IN/OUT

Miscellaneous Maintenance Reporting Codes												Section
DEF	DEF	DEF	00	00	DEF	DEF	DEF	DEF	DEF	00	00	[347]
DEF = No change to default values, 00 = Disabled												

- Digit 5 selects DLS connection options.

Option	Programming Section	DLS Connection/Call back setting
1	[401] Option 1 OFF Option 3 OFF [406] 0	Double Call Disabled, Call Back Disabled Number of rings to answer on set to 0
2	[401] Option 1 ON Option 3 OFF [406] 9	Double Call Enabled, Call Back Disabled Number of rings to answer on set to 9
3	[401] Option 1 ON Option 3 ON [406] 9	Double Call Enabled, Call Back Enabled Number of rings to answer on set to 9

Appendix F: Communicator Format Options

This section requires two 2-digit entries to set the communications format that is to be used for each phone number (1 per phone number). The 3rd telephone number uses the format programmed for the 1st telephone number.

Entry	Communication Format
01	20 BPS, 1400 HZ handshake
02	20 BPS, 2300 HZ handshake
03	DTMF CONTACT I.D.
04	SIA FSK
05	Pager
06	Residential Dial
07	10 BPS, 1400 Hz handshake
08	10 BPS, 2300 Hz handshake
09	For Future Use
10	For Future Use
11	For Future Use
12	For Future Use
13	For Future Use

Reporting Codes

- SIA -0 is valid in Account or Rep Code (not 00 in a Reporting code though)
- ADEMCO Contact ID - 0 is not valid in Account or Rep Code (A must be used, 10 in checksum)
- BPS Formats - 0 is not valid in Account or Rep Code (A must be used)
- SIA - This format uses 300 Baud FSK as the communication media. The Account Code can be 4 or 6 hexadecimal digits in length, All reporting codes must be 2 digits in length. The SIA format will transmit a 4 (or 6) digit account code, a 2-digit identifier code and a 2-digit reporting code. The 2-digit identifier is pre programmed by the panel.

Contact ID

Contact ID is a specialized format that will communicate information quickly using tones rather than pulses. In addition to sending information more quickly the format also allows more information to be sent. For example, rather than reporting an alarm zone 1 the Contact ID format can also report the type of alarm, such as Entry/Exit alarm zone 1.

If **Contact ID Sends Automatic Reporting Codes** is selected, the panel will automatically generate a reporting code for each event. These identifiers are listed in Appendix A. If the Automatic Contact ID option is not selected, reporting codes must be programmed. The 2-digit entry determines the type of alarm. The panel will automatically generate all other information, including the zone number.

NOTE: If the Automatic Contact ID option is selected, the panel will automatically generate all zone and access code numbers, eliminating the need to program these items.

NOTE: The zone number for Zone Low Battery and Zone Fault events will not be identified when Programmed Contact ID is used.

If the **Contact ID uses Automatic Reporting Codes** option is enabled, the panel will operate as follows:

- If an event's reporting code is programmed as [00], the panel will not attempt to call the central station.
- If the reporting code for an event is programmed as anything from [01] to [FF], the panel will automatically generate the zone or access code number. See Appendix A for a list of the codes which will be transmitted.

If the **Contact ID uses Programmed Reporting Codes** option is enabled, the panel will operate as follows:

- If an event's reporting code is programmed as [00] or [FF], the panel will not attempt to call central station.
- If the reporting code for an event is programmed as anything from [01] to [FE], the panel will send the programmed reporting code.
- Account numbers must be four digits.
- If the digit '0' is in the account number substitute the HEX digit 'A' for the '0'.
- All reporting codes must be two digits.
- If the digit '0' is in the reporting code substitute the HEX digit 'A' for the '0'.
- To prevent the panel from reporting an event program the reporting code for the event as [00] or [FF].

Contact ID Sends Automatic

Reporting Codes Section [381], Option [7]

SIA (Level 2)

SIA is a specialized format that will communicate information quickly using frequency shift keying (FSK) rather than pulses. The SIA format will automatically generate the type of signal being transmitted, such as Burglary, Fire, Panic etc. The two digit reporting code is used to identify the zone or access code number.

If the SIA format is selected the panel can be programmed to automatically generate all zone and access code numbers eliminating the need to program these items.

If the **SIA Sends Automatic Reporting Codes** option is enabled the panel will operate as follows:

1. If the reporting code for an event is programmed as [00] the panel will not attempt to call the central station.
2. If the reporting code for an event is programmed as anything from [01] to [FF] the panel will AUTOMATICALLY generate the zone or access code number.
3. Bypassed zones will always be identified when partial closing the system.

The Communicator Call Direction Options can be used to disable reporting of events such as Openings/Closings. Also, if all the Opening/Closing reporting codes were programmed as [00] the panel would not report.

If the **SIA Sends Automatic Reporting Codes** option is disabled the panel will operate as follows:

1. If the reporting code for an event is programmed as [00] or [FF] the panel will not attempt to call the central station.
2. If the reporting code for an event is programmed as anything from [01] to [FE] the panel will send the programmed reporting code.
3. Bypassed zones will not be identified when partial closing the system.

NOTE: The zone number for Zone Low Battery and Zone Fault events will not be identified when Programmed SIA is used.

SIA Sends Automatic Reporting Codes Section [381], Option [3]
 Communicator Call Direction Options . . . Section [351] to [376]
 SIA Identifiers Appendix A

Residential Dial

If Residential Dial is programmed and an event that is programmed to communicate occurs, the panel will seize the line and dial the appropriate telephone number(s). Once the dialing is complete, the panel will emit an ID tone and wait for a handshake (press a 1, 2, 3, 4, 5, 6, 7, 8, 9, 0, * or # key from any telephone). It will wait for this handshake for

the duration of **Post Dial Wait for Handshake** timer. Once the panel receives the handshake, it will emit an alarm tone over the telephone line for 20 seconds. If several alarms occur at the same time, only one call will be made to each telephone number the panel is programmed to call.

Communicator Call Direction Options . . . Section [361] to [368]

Pager Format

The **Communicator Format** option for either telephone number can be programmed for Pager Format. If an event occurs and the **Communicator Call Direction** options direct the call to a telephone number with the Pager Format selected the panel will attempt to page.

When calling a pager extra digits will be required to make it work properly. The following is a list of Hex digits and what function they perform:

Hex [A] - not used

Hex [B] - simulates the * key on a touch tone telephone

Hex [E] - two second pause

Hex [C] - simulates the [#] key on a touch tone telephone

Hex [F] - end of telephone number marker

Hex [D] - forces the panel to search for dial tone

The panel will attempt to call the pager one time. After dialing the digits in the telephone number the panel will send the account number and reporting code followed by the [#] key (Hex [C]).

There is no ringback when using Pager Format. The panel has no way of confirming if the pager was called successfully; a failure to communicate trouble will only be generated once the maximum number of attempts has been reached.

NOTE: Do not use the digit C in a reporting code when using Pager Format. In most cases, the digit C will be interpreted as a [#], which will terminate the page before it has finished.

NOTE: If the panel detects a busy signal, it will attempt to page again. It will make the maximum number of attempts programmed in section [165].

Force dialing should be disabled when using Pager format.

When using Pager format, you must program two hex digit E's at the end of the telephone number.

Pulse Formats

Depending on the pulse format selected the panel will communicate using the following:

- 3/1, 3/2, 4/1 or 4/2
- 1400 or 2300 Hz handshake
- 10 or 20 bits per second
- non-extended

The digit '0' will send no pulses and is used as a filler. When programming account numbers enter four digits. When programming a three digit account number the fourth digit must be programmed as a plain '0' which will act as a filler digit.

If an account number has a '0' in it, substitute a HEX digit 'A' for the '0'. Examples:

- 3 digit account number [123]- program [1230]
- 3 digit account number [502] - program [5A20]
- 4 digit account number [4079] - program [4A79]

When programming reporting codes two digits must be entered. If one digit reporting codes are to be used the second digit must be programmed as a '0'. If a '0' is to be transmitted substitute a HEX digit 'A' for the '0'.

Examples:

- 1 digit reporting code [3] - program [30]
- 2 digit reporting code [30] - program [3A]

To prevent the panel from reporting an event program the reporting code for the event as [00] or [FF].

Telephone Line Monitoring (TLM)

When the **TLM Enable** option is selected, the panel will supervise the telephone line and will indicate a trouble condition if the telephone line is disconnected.

If the TLM Enable option is ON, the panel will check the telephone line every 10 seconds. If the telephone line voltage is below 3V for the number of checks programmed in the **TLM Trouble Delay** section, the panel will report a TLM trouble. The default number of checks is 10. Enter a number from (000) to (255) in the TLM Trouble Delay section to change the number of checks before the TLM trouble is reported. Programming a delay means that a momentary interruption of the telephone line will not cause a trouble condition.

If the **TLM Trouble Beeps When Armed** option is enabled, the panel will indicate a TLM trouble at the keypad while the system is armed. To activate the bell output in the case of a TLM trouble while the system is armed, the **TLM Audible (Bell) When Armed** option must be selected.

When the trouble condition is restored, the panel can send a **TLM Restoral** reporting code. Any events which occur while the telephone line is down will also be communicated. If an alternate communicator is being used, the panel can be programmed to report a **TLM Trouble Reporting Code**.

SAFETY INSTRUCTIONS FOR SERVICE PERSONNEL

WARNING: When using equipment connected to the telephone network, there are basic safety instructions that should always be followed. Refer to the Safety Instructions provided with this product; save them for future reference. Instruct the end-user regarding the safety precautions that shall be observed when operating this equipment.

Selecting a Suitable Location for the Alarm Controller

Use the following list as a guide to find a suitable place for this equipment:

- Locate the control panel near a telephone socket and a power outlet.
- Select a place that is free from vibration and shock.
- Place the alarm controller on a flat, stable surface and follow the installation instructions:
 - Do **NOT** locate this product where persons can walk on the secondary circuit cable(s).
 - Do **NOT** connect the alarm controller to electrical outlets on the same circuit as large appliances.
 - Do **NOT** select a place that exposes the alarm controller to direct sunlight, excessive heat, moisture, vapors, chemicals or dust.
 - Do **NOT** install this equipment near water (e.g., bathtub, wash bowl, kitchen/laundry sink, wet basement, or near a swimming pool).
 - Do **NOT** install this equipment and its accessories in areas where there is a risk of explosion.
 - Do **NOT** connect this alarm controller to electrical outlets controlled by wall switches or automatic timers.
 - AVOID** sources of radio interference.
 - AVOID** setting up the equipment near heaters, air conditioners, ventilators, and/or refrigerators.
 - AVOID** locating this equipment close to or on top of large metal objects (e.g., metal wall studs).

Safety Precautions Required During Installation

- **NEVER** install this equipment and/or telephone wiring during a lightning storm.
- **NEVER** touch uninsulated telephone wires or terminals unless the telephone line has been disconnected at the network interface.
- Ensure that cables are positioned so that accidents can not occur. Connected cables must not be subject to excessive mechanical strain.
- For Direct Plug-in versions, use the transformer supplied with the device.

The power supply must be Class II, FAIL SAFE with double or reinforced insulation between the PRIMARY and SECONDARY circuit/ENCLOSURE and be an approved type acceptable to the local authorities. All national wiring rules shall be observed.

Limited Warranty

Digital Security Controls warrants the original purchaser that for a period of twelve months from the date of purchase, the product shall be free of defects in materials and workmanship under normal use. During the warranty period, Digital Security Controls shall, at its option, repair or replace any defective product upon return of the product to its factory, at no charge for labour and materials. Any replacement and/or repaired parts are warranted for the remainder of the original warranty or ninety (90) days, whichever is longer. The original purchaser must promptly notify Digital Security Controls in writing that there is a defect in material or workmanship, such written notice to be received in all events prior to expiration of the warranty period. There is absolutely no warranty on software and all software products are sold as a user license under the terms of the software license agreement included with the product. The Customer assumes all responsibility for the proper selection, installation, operation and maintenance of any products purchased from DSC. Custom products are only warranted to the extent that they do not function upon delivery. In such cases, DSC can replace or credit at its option.

International Warranty

The warranty for international customers is the same as for any customer within Canada and the United States, with the exception that Digital Security Controls shall not be responsible for any customs fees, taxes, or VAT that may be due.

Warranty Procedure

To obtain service under this warranty, please return the item(s) in question to the point of purchase. All authorized distributors and dealers have a warranty program. Anyone returning goods to Digital Security Controls must first obtain an authorization number. Digital Security Controls will not accept any shipment whatsoever for which prior authorization has not been obtained.

Conditions to Void Warranty

This warranty applies only to defects in parts and workmanship relating to normal use. It does not cover:

- damage incurred in shipping or handling;
- damage caused by disaster such as fire, flood, wind, earthquake or lightning;
- damage due to causes beyond the control of Digital Security Controls such as excessive voltage, mechanical shock or water damage;
- damage caused by unauthorized attachment, alterations, modifications or foreign objects;
- damage caused by peripherals (unless such peripherals were supplied by Digital Security Controls Ltd.);
- defects caused by failure to provide a suitable installation environment for the products;
- damage caused by use of the products for purposes other than those for which it was designed;
- damage from improper maintenance;
- damage arising out of any other abuse, mishandling or improper application of the products.

Items Not Covered by Warranty

In addition to the items which void the Warranty, the following items shall not be covered by Warranty: (i) freight cost to the repair centre; (ii) products which are not identified with DSC's product label and lot number or serial number; (iii) products disassembled or repaired in such a manner as to adversely affect performance or prevent adequate inspection or testing to verify any warranty claim. Access cards or tags returned for replacement under warranty will be credited or replaced at DSC's option. Products not covered by this warranty, or otherwise out of warranty due to age, misuse, or damage shall be evaluated, and a repair estimate shall be provided. No repair work will be performed until a valid purchase order is received from the Customer and a Return Merchandise Authorization number (RMA) is issued by DSC's Customer Service.

Digital Security Controls Ltd.'s liability for failure to repair the product under this warranty after a reasonable number of attempts will be limited to a replacement of the product, as the exclusive remedy for breach of warranty. Under no circumstances shall Digital Security Controls be liable for any special, incidental, or consequential damages based upon breach of warranty, breach of contract, negligence, strict liability, or any other legal theory. Such damages include, but are not limited to, loss of profits, loss of the product or any associated equipment, cost of capital, cost of substitute or replacement equipment, facilities or services, down time, purchaser's time, the claims of third parties, including customers, and injury to property. The laws of some jurisdictions limit or do not allow the disclaimer of consequential damages. If the laws of such a jurisdiction apply to any claim by or against DSC, the limitations and disclaimers contained here shall be to the greatest extent permitted by law. Some states do not allow the exclusion or limitation of incidental or consequential damages, so that the above may not apply to you.

Disclaimer of Warranties

This warranty contains the entire warranty and shall be in lieu of any and all other warranties, whether expressed or implied (including all implied warranties of merchantability or fitness for a particular purpose) and of all other obligations or liabilities on the part of Digital Security Controls. Digital Security Controls neither assumes responsibility for, nor authorizes any other person purporting to act on its behalf to modify or to change this warranty, nor to assume for it any other warranty or liability concerning this product. This disclaimer of warranties and limited warranty are governed by the laws of the province of Ontario, Canada.

WARNING: Digital Security Controls recommends that the entire system be completely tested on a regular basis. However, despite frequent testing, and due to, but not limited to, criminal tampering or electrical disruption, it is possible for this product to fail to perform as expected.

Out of Warranty Repairs

Digital Security Controls will at its option repair or replace out-of-warranty products which are returned to its factory according to the following conditions. Anyone returning goods to Digital Security Controls must first obtain an authorization number. Digital Security Controls will not accept any shipment whatsoever for which prior authorization has not been obtained.

Products which Digital Security Controls determines to be repairable will be repaired and returned. A set fee which Digital Security Controls has predetermined and which may be revised from time to time, will be charged for each unit repaired.

WARNING - READ CAREFULLY

• Smoke Detectors

Smoke detectors that are a part of this system may not properly alert occupants of a fire for a number of reasons, some of which follow. The smoke detectors may have been improperly installed or positioned. Smoke may not be able to reach the smoke detectors, such as when the fire is in a chimney, walls or roofs, or on the other side of closed doors. Smoke detectors may not detect smoke from fires on another level of the residence or building.

Every fire is different in the amount of smoke produced and the rate of burning. Smoke detectors cannot sense all types of fires equally well. Smoke detectors may not provide timely warning of fires caused by carelessness or safety hazards such as smoking in bed, violent explosions, escaping gas, improper storage of flammable materials, overloaded electrical circuits, children playing with matches or arson.

Even if the smoke detector operates as intended, there may be circumstances when there is insufficient warning to allow all occupants to escape in time to avoid injury or death.

• Motion Detectors

Motion detectors can only detect motion within the designated areas as shown in their respective installation instructions. They cannot discriminate between intruders and intended occupants. Motion detectors do not provide volumetric area protection. They have multiple beams of detection and motion can only be detected in unobstructed areas covered by these beams. They cannot detect motion which occurs behind walls, ceilings, floor, closed doors, glass partitions, glass doors or windows. Any type of tampering whether intentional or unintentional such as masking, painting, or spraying of any material on the lenses, mirrors, windows or any other part of the detector system will impair its proper operation.

Passive infrared motion detectors operate by sensing changes in temperature. However their effectiveness can be reduced when the ambient temperature rises near or above body temperature or if there are intentional or unintentional sources of heat in or near the detection area. Some of these heat sources could be heaters, radiators, stoves, barbecues, fireplaces, sunlight, steam vents, lighting and so on.

• Warning Devices

Warning devices such as sirens, bells, horns, or strobes may not warn people or waken someone sleeping if there is an intervening wall or door. If warning devices are located on a different level of the residence or premise, then it is less likely that the occupants will be alerted or awakened. Audible warning devices may be interfered with by other noise sources such as stereos, radios, televisions, air conditioners or other appliances, or passing traffic. Audible warning devices, however loud, may not be heard by a hearing-impaired person.

• Telephone Lines

If telephone lines are used to transmit alarms, they may be out of service or busy for certain periods of time. Also an intruder may cut the telephone line or defeat its operation by more sophisticated means which may be difficult to detect.

• Insufficient Time

There may be circumstances when the system will operate as intended, yet the occupants will not be protected from the emergency due to their inability to respond to the warnings in a timely manner. If the system is monitored, the response may not occur in time to protect the occupants or their belongings.

• Component Failure

Although every effort has been made to make this system as reliable as possible, the system may fail to function as intended due to the failure of a component.

• Inadequate Testing

Most problems that would prevent an alarm system from operating as intended can be found by regular testing and maintenance. The complete system should be tested weekly and immediately after a break-in, an attempted break-in, a fire, a storm, an earthquake, an accident, or any kind of construction activity inside or outside the premises. The testing should include all sensing devices, keypads, controls, alarm indicating devices and any other operational devices that are part of the system.

• Security and Insurance

Regardless of its capabilities, an alarm system is not a substitute for property or life insurance. An alarm system also is not a substitute for property owners, renters, or other occupants to act prudently to prevent or minimize the harmful effects of an emergency situation.

IMPORTANT - READ CAREFULLY: DSC Software purchased with or without Products and Components is copyrighted and is purchased under the following license terms:

- This End-User License Agreement ("EULA") is a legal agreement between **You** (the company, individual or entity who acquired the Software and any related Hardware) and **Digital Security Controls, a division of Tyco Safety Products Canada Ltd.** ("DSC"), the manufacturer of the integrated security systems and the developer of the software and any related products or components ("HARDWARE") which you acquired.
- If the DSC software product ("SOFTWARE PRODUCT" or "SOFTWARE") is intended to be accompanied by HARDWARE, and is NOT accompanied by new HARDWARE, You may not use, copy or install the SOFTWARE PRODUCT. The SOFTWARE PRODUCT includes computer software, and may include associated media, printed materials, and "online" or electronic documentation.
- Any software provided along with the SOFTWARE PRODUCT that is associated with a separate end-user license agreement is licensed to You under the terms of that license agreement.
- By installing, copying, downloading, storing, accessing or otherwise using the SOFTWARE PRODUCT, You agree unconditionally to be bound by the terms of this EULA, even if this EULA is deemed to be a modification of any previous arrangement or contract. If You do not agree to the terms of this EULA, DSC is unwilling to license the SOFTWARE PRODUCT to You, and You have no right to use it.

SOFTWARE PRODUCT LICENSE

The SOFTWARE PRODUCT is protected by copyright laws and international copyright treaties, as well as other intellectual property laws and treaties. The SOFTWARE PRODUCT is licensed, not sold.

1. GRANT OF LICENSE This EULA grants You the following rights:

- Software Installation and Use** - For each license you acquire, You may have only one copy of the SOFTWARE PRODUCT installed.
- Storage/Network Use** - The SOFTWARE PRODUCT may not be installed, accessed, displayed, run, stored or used concurrently on or from different computers, including a workstation, terminal or other digital electronic device ("Device"). In other words, if You have several workstations, You will have to acquire a license for each workstation where the SOFTWARE will be used.
- Backup Copy** - You may make back-up copies of the SOFTWARE PRODUCT, but You may only have one copy per license installed at any given time. You may use the back-up copy solely for archival purposes. Except as expressly provided in this EULA, You may not otherwise make copies of the SOFTWARE PRODUCT, including the printed materials accompanying the SOFTWARE.

2. DESCRIPTION OF OTHER RIGHTS AND LIMITATIONS

- Limitations on Reverse Engineering, Decompilation and Disassembly** - You may not reverse engineer, decompile, or disassemble the SOFTWARE PRODUCT, except and only to the extent that such activity is expressly permitted by applicable law notwithstanding this limitation. You may not make any changes or modifications to the Software, without the written permission of an officer of DSC. You may not remove any proprietary notices, marks or labels from the Software Product. You shall institute reasonable measures to ensure compliance with the terms and conditions of this EULA.
- Separation of Components** - The SOFTWARE PRODUCT is licensed as a single product. Its component parts may not be separated for use on more than one HARDWARE unit.
- Single INTEGRATED PRODUCT** - If you acquired this SOFTWARE with HARDWARE, then the SOFTWARE PRODUCT is licensed with the HARDWARE as a single integrated product. In this case, the SOFTWARE PRODUCT may only be used with the HARDWARE as set forth in this EULA.
- Rental** - You may not rent, lease or lend the SOFTWARE PRODUCT. You may not make it available to others or post it on a server or web site.
- Software Product Transfer** - You may transfer all of Your rights under this EULA only as part of a permanent sale or transfer of the HARDWARE, provided You retain no copies, You transfer all of the SOFTWARE PRODUCT (including all component parts, the media and printed materials, any upgrades and this EULA), and provided the recipient agrees to the terms of this EULA. If the SOFTWARE PRODUCT is an upgrade, any transfer must also include all prior versions of the SOFTWARE PRODUCT.

(f) **Termination** - Without prejudice to any other rights, DSC may terminate this EULA if You fail to comply with the terms and conditions of this EULA. In such event, You must destroy all copies of the SOFTWARE PRODUCT and all of its component parts.

(g) **Trademarks** - This EULA does not grant You any rights in connection with any trademarks or service marks of DSC or its suppliers.

(3) **COPYRIGHT** - All title and intellectual property rights in and to the SOFTWARE PRODUCT (including but not limited to any images, photographs, and text incorporated into the SOFTWARE PRODUCT), the accompanying printed materials, and any copies of the SOFTWARE PRODUCT, are owned by DSC or its suppliers. You may not copy the printed materials accompanying the SOFTWARE PRODUCT. All title and intellectual property rights in and to the content which may be accessed through use of the SOFTWARE PRODUCT are the property of the respective content owner and may be protected by applicable copyright or other intellectual property laws and treaties. This EULA grants You no rights to use such content. All rights not expressly granted under this EULA are reserved by DSC and its suppliers.

(4) **EXPORT RESTRICTIONS** - You agree that You will not export or re-export the SOFTWARE PRODUCT to any country, person, or entity subject to Canadian export restrictions.

(5) **CHOICE OF LAW** - This Software License Agreement is governed by the laws of the Province of Ontario, Canada.

(6) **ARBITRATION** - All disputes arising in connection with this Agreement shall be determined by final and binding arbitration in accordance with the Arbitration Act, and the parties agree to be bound by the arbitrator's decision. The place of arbitration shall be Toronto, Canada, and the language of the arbitration shall be English.

7. LIMITED WARRANTY

(a) **NO WARRANTY** - DSC PROVIDES THE SOFTWARE "AS IS" WITHOUT WARRANTY. DSC DOES NOT WARRANT THAT THE SOFTWARE WILL MEET YOUR REQUIREMENTS OR THAT OPERATION OF THE SOFTWARE WILL BE UNINTERRUPTED OR ERROR-FREE.

(b) **CHANGES IN OPERATING ENVIRONMENT** - DSC shall not be responsible for problems caused by changes in the operating characteristics of the HARDWARE, or for problems in the interaction of the SOFTWARE PRODUCT with non-DSC SOFTWARE or HARDWARE PRODUCTS.

(c) **LIMITATION OF LIABILITY; WARRANTY REFLECTS ALLOCATION OF RISK** - IN ANY EVENT, IF ANY STATUTE IMPLIES WARRANTIES OR CONDITIONS NOT STATED IN THIS LICENSE AGREEMENT, DSC'S ENTIRE LIABILITY UNDER ANY PROVISION OF THIS LICENSE AGREEMENT SHALL BE LIMITED TO THE GREATER OF THE AMOUNT ACTUALLY PAID BY YOU TO LICENSE THE SOFTWARE PRODUCT AND FIVE CANADIAN DOLLARS (CAD\$5.00). BECAUSE SOME JURISDICTIONS DO NOT ALLOW THE EXCLUSION OR LIMITATION OF LIABILITY FOR CONSEQUENTIAL OR INCIDENTAL DAMAGES, THE ABOVE LIMITATION MAY NOT APPLY TO YOU.

(d) **DISCLAIMER OF WARRANTIES** - THIS WARRANTY CONTAINS THE ENTIRE WARRANTY AND SHALL BE IN LIEU OF ANY AND ALL OTHER WARRANTIES, WHETHER EXPRESSED OR IMPLIED (INCLUDING ALL IMPLIED WARRANTIES OF MERCHANTABILITY OR FITNESS FOR A PARTICULAR PURPOSE) AND OF ALL OTHER OBLIGATIONS OR LIABILITIES ON THE PART OF DSC. DSC MAKES NO OTHER WARRANTIES. DSC NEITHER ASSUMES NOR AUTHORIZES ANY OTHER PERSON PURPORTING TO ACT ON ITS BEHALF TO MODIFY OR TO CHANGE THIS WARRANTY, NOR TO ASSUME FOR IT ANY OTHER WARRANTY OR LIABILITY CONCERNING THIS SOFTWARE PRODUCT.

(e) **EXCLUSIVE REMEDY AND LIMITATION OF WARRANTY** - UNDER NO CIRCUMSTANCES SHALL DSC BE LIABLE FOR ANY SPECIAL, INCIDENTAL, CONSEQUENTIAL OR INDIRECT DAMAGES BASED UPON BREACH OF WARRANTY, BREACH OF CONTRACT, NEGLIGENCE, STRICT LIABILITY, OR ANY OTHER LEGAL THEORY. SUCH DAMAGES INCLUDE, BUT ARE NOT LIMITED TO, LOSS OF PROFITS, LOSS OF THE SOFTWARE PRODUCT OR ANY ASSOCIATED EQUIPMENT, COST OF CAPITAL, COST OF SUBSTITUTE OR REPLACEMENT EQUIPMENT, FACILITIES OR SERVICES, DOWN TIME, PURCHASERS TIME, THE CLAIMS OF THIRD PARTIES, INCLUDING CUSTOMERS, AND INJURY TO PROPERTY.

WARNING: DSC recommends that the entire system be completely tested on a regular basis. However, despite frequent testing, and due to, but not limited to, criminal tampering or electrical disruption, it is possible for this SOFTWARE PRODUCT to fail to perform as expected.

FCC COMPLIANCE STATEMENT

NOTE: CAUTION: Changes or modifications not expressly approved by Digital Security Controls could void your authority to use this equipment.

This equipment has been tested and found to comply with the limits for a Class B digital device, pursuant to Part 15 of the FCC Rules. These limits are designed to provide reasonable protection against harmful interference in a residential installation. This equipment generates, uses and can radiate radio frequency energy and, if not installed and used in accordance with the instructions, may cause harmful interference to radio communications. However, there is no guarantee that interference will not occur in a particular installation. If this equipment does cause harmful interference to radio or television reception, which can be determined by turning the equipment off and on, the user is encouraged to try to correct the interference by one or more of the following measures:

- Re-orient the receiving antenna.
- Increase the separation between the equipment and receiver.
- Connect the equipment into an outlet on a circuit different from that to which the receiver is connected.
- Consult the dealer or an experienced radio/television technician for help.

The user may find the following booklet prepared by the FCC useful: "How to Identify and Resolve Radio/Television Interference Problems". This booklet is available from the U.S. Government Printing Office, Washington D.C. 20402, Stock # 004-000-00345-4.

IMPORTANT INFORMATION

This equipment complies with Part 68 of the FCC Rules. On the side of this equipment is a label that contains, among other information, the FCC registration number and ringer equivalence number (REN) for this equipment. If requested, this number must be provided to the Telephone Company.

PC1864 Product Identifier	US: F53AL01BPC1864
PC1832 Product Identifier	US: F53AL01BPC1832
PC1616 Product Identifier	US: F53AL01BPC1614
REN:	0.1B
USOC Jack:	RJ-31X

Telephone Connection Requirements

A plug and jack used to connect this equipment to the premises wiring and telephone network must comply with the applicable FCC Part 68 rules and requirements adopted by the ACTA. A compliant telephone cord and modular plug is provided with this product. It is designed to be connected to a compatible modular jack that is also compliant. See installation instructions for details.

Ringer Equivalence Number (REN)

The REN is used to determine the number of devices that may be connected to a telephone line. Excessive RENs on a telephone line may result in the devices not ringing in response to an incoming call.

In most but not all areas, the sum of RENs should not exceed five (5.0). To be certain of the number of devices that may be connected to a line, as determined by the total RENs, contact the local Telephone Company. For products approved after July 23, 2001, the REN for this product is part of the product identifier that has the format.

US: AAAEQ##TXXXX. The digits represented by ## are the REN without a decimal point (e.g., 03 is a REN of 0.3). For earlier products, the REN is separately shown on the label.

Incidence of Harm

If this equipment PC1864/PC1832/PC1616 causes harm to the telephone network, the telephone company will notify you in advance that temporary discontinuance of service may be required. But if advance notice is not practical, the Telephone Company will notify the customer as soon as possible. Also, you will be advised of your right to file a complaint with the FCC if you believe it is necessary.

Changes in Telephone Company Equipment or Facilities

The Telephone Company may make changes in its facilities, equipment, operations or procedures that could affect the operation of the equipment. If this happens the Telephone Company will provide advance notice in order for you to make necessary modifications to maintain uninterrupted service.

The trademarks, logos, and service marks displayed on this document are registered in the United States [or other countries]. Any misuse of the trademarks is strictly prohibited and Tyco International Ltd. will aggressively enforce its intellectual property rights to the fullest extent of the law, including pursuit of criminal prosecution wherever necessary. All trademarks not owned by Tyco International Ltd. are the property of their respective owners, and are used with permission or allowed under applicable laws.

Product offerings and specifications are subject to change without notice. Actual products may vary from photos. Not all products include all features. Availability varies by region; contact your sales representative.

Equipment Maintenance Facility

If trouble is experienced with this equipment PC1616, PC1832, PC1864 for repair or warranty information, please contact the facility indicated below. If the equipment is causing harm to the telephone network, the Telephone Company may request that you disconnect the equipment until the problem is solved. This equipment is of a type that is not intended to be repaired by the end user.

DSC c/o APL Logistics, 757 Douglas Hill Rd., Lithia Springs, GA 30122

Additional Information

Connection to party line service is subject to state tariffs. Contact the state public utility commission, public service commission or corporation commission for information. Alarm dialling equipment must be able to seize the telephone line and place a call in an emergency situation. It must be able to do this even if other equipment (telephone, answering system, computer modem, etc.) already has the telephone line in use. To do so, alarm dialling equipment must be connected to a properly installed RJ-31X jack that is electrical-ly in series with and ahead of all other equipment attached to the same telephone line. Proper installation is depicted in the figure below. If you have any questions concerning these instructions, you should consult your telephone company or a qualified installer about installing the RJ-31X jack and alarm dialling equipment for you.

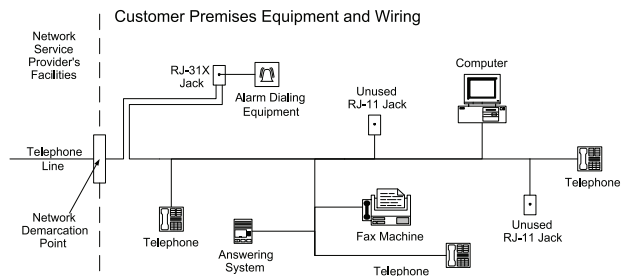

INDUSTRY CANADA STATEMENT

NOTICE: This Equipment meets the applicable Industry Canada Terminal Equipment Technical Specifications. This is confirmed by the registration number. The abbreviation, IC, before the registration number signifies that registration was performed based on a Declaration of Conformity indicating that Industry Canada technical specifications were met. It does not imply that Industry Canada approved the equipment.

NOTICE: The Ringer Equivalence Number (REN) for this terminal equipment is 0.1. The REN assigned to each terminal equipment provides an indication of the maximum number of terminals allowed to be connected to a telephone interface. The termination on an interface may consist of any combination of devices subject only to the requirement that the sum of the Ringer Equivalence Numbers of all devices does not exceed five.

PC1616 Registration numberIC: 160A-PC1614
PC1832 Registration numberIC: 160A-PC1832
PC1864 Registration numberIC: 160A-PC1864

This Class B digital apparatus meets all requirements of the Canadian interference-causing equipment regulations.

Cet appareil numérique de la Classe B respecte toutes les exigences de règlement sur le matériel brouilleur du Canada.