

Soft starters

SIRIUS 3RW30 / 3RW40

Manual · 01/2010



Industrial Controls

Answers for industry.

SIEMENS

SIEMENS

Industrial Controls

Soft starters SIRIUS 3RW30 / 3RW40

Manual

Introduction	1
Safety information	2
Product description	3
Product combinations	4
Functions	5
Application planning	6
Installation	7
Installation / mounting	8
Connecting	9
Operation	10
Configuration	11
Commissioning	12
Technical data	13
Dimension drawings	14
Typical circuit diagrams	15
Accessories	16
Appendix	A

Legal information

Warning notice system

This manual contains notices you have to observe in order to ensure your personal safety, as well as to prevent damage to property. The notices referring to your personal safety are highlighted in the manual by a safety alert symbol, notices referring only to property damage have no safety alert symbol. These notices shown below are graded according to the degree of danger.

⚠ DANGER
indicates that death or severe personal injury will result if proper precautions are not taken.
⚠ WARNING
indicates that death or severe personal injury may result if proper precautions are not taken.
⚠ CAUTION
with a safety alert symbol, indicates that minor personal injury can result if proper precautions are not taken.
CAUTION
without a safety alert symbol, indicates that property damage can result if proper precautions are not taken.
NOTICE
indicates that an unintended result or situation can occur if the corresponding information is not taken into account.

If more than one degree of danger is present, the warning notice representing the highest degree of danger will be used. A notice warning of injury to persons with a safety alert symbol may also include a warning relating to property damage.

Qualified Personnel

The product/system described in this documentation may be operated only by **personnel qualified** for the specific task in accordance with the relevant documentation for the specific task, in particular its warning notices and safety instructions. Qualified personnel are those who, based on their training and experience, are capable of identifying risks and avoiding potential hazards when working with these products/systems.

Proper use of Siemens products

Note the following:

⚠ WARNING
Siemens products may only be used for the applications described in the catalog and in the relevant technical documentation. If products and components from other manufacturers are used, these must be recommended or approved by Siemens. Proper transport, storage, installation, assembly, commissioning, operation and maintenance are required to ensure that the products operate safely and without any problems. The permissible ambient conditions must be adhered to. The information in the relevant documentation must be observed.

Trademarks

All names identified by ® are registered trademarks of the Siemens AG. The remaining trademarks in this publication may be trademarks whose use by third parties for their own purposes could violate the rights of the owner.

Disclaimer of Liability

We have reviewed the contents of this publication to ensure consistency with the hardware and software described. Since variance cannot be precluded entirely, we cannot guarantee full consistency. However, the information in this publication is reviewed regularly and any necessary corrections are included in subsequent editions.

Table of contents

1	Introduction	11
1.1	Important notes.....	11
2	Safety information	13
2.1	Before commencing work: Isolating the equipment from the supply system and ensuring that it cannot be reconnected.	13
2.2	Five safety rules for work in or on electrical systems	13
3	Product description	15
3.1	Fields of application.....	15
3.2	Basic physical principles of a three-phase induction motor.....	15
3.2.1	Three-phase induction motor	15
3.3	Functional principle of the SIRIUS 3RW30 and 3RW40 soft starters.....	17
3.3.1	Method of operation of a two-phase controlled soft starter	20
3.3.2	Starting current asymmetry	21
3.3.3	Applications and use	22
3.4	Comparison of device functions	24
4	Product combinations	25
4.1	SIRIUS modular system	25
5	Functions	27
5.1	Start modes	27
5.1.1	Voltage ramp	27
5.1.2	Current limiting and ramp-up detection (3RW40 only)	29
5.2	Stop modes	30
5.2.1	Stop without load (3RW30 and 3RW40)	31
5.2.2	Soft stop (3RW40 only)	31
5.3	Motor protection / intrinsic device protection (3RW40 only)	32
5.3.1	Motor protection function	32
5.3.2	Intrinsic device protection (3RW40 only)	35
5.4	Functions of the RESET buttons	36
5.4.1	SIRIUS 3RW40 2, 3RW40 3, and 3RW40 4 soft starters	36
5.4.2	SIRIUS 3RW40 5 and 3RW40 7 soft starters	38
5.4.3	Other functions of the RESET button	39
5.5	Functions of the inputs	40
5.5.1	Start input (terminal 1) on 3RW30 and 3RW40 2 to 3RW40 4	40
5.5.2	Start input (terminal 3) on 3RW40 5 and 3RW40 7	40
5.5.3	Thermistor input / connection on 3RW40 2 to 3RW40 4	41
5.6	Functions of the outputs	41
5.6.1	3RW30: Output terminal 13 / 14 ON	41
5.6.2	3RW40: Output terminals 13 / 14 ON / RUN and 23 / 24 BYPASSED	42

5.6.3	3RW40: Group fault output at terminal 95 / 96 / 98 OVERLOAD / FAILURE	43
5.7	Diagnostics and fault signals	44
5.7.1	3RW30: LEDs and troubleshooting	44
5.7.2	3RW40: LEDs and troubleshooting	46
6	Application planning	51
6.1	Application examples.....	51
6.1.1	Roller conveyor application	51
6.1.2	Hydraulic pump application	52
7	Installation	53
7.1	Installing the soft starter.....	53
7.1.1	Unpacking	53
7.1.2	Permissible mounting position	53
7.1.3	Mounting dimensions, clearances, and assembly type	54
7.1.4	Assembly type: Standalone assembly, side-by-side assembly, direct mounting	55
7.1.5	Installation requirements	56
8	Installation / mounting	57
8.1	General information	57
8.2	Five safety rules for work in or on electrical systems	58
8.3	General feeder assembly (type of coordination 1).....	59
8.4	Soft starter with line contactor (type of coordination 1).....	60
8.5	Soft starter assembly with type of coordination 2	61
8.6	Capacitors to improve the power factor.....	62
8.7	Maximum cable length.....	63
9	Connecting	65
9.1	Electrical connection.....	65
9.1.1	Control and auxiliary terminals	65
9.1.2	Main circuit connection	65
10	Operation	69
10.1	Operator controls, displays, and connections on the 3RW30.....	69
10.2	Operator controls, displays, and connections on the 3RW40.....	70
11	Configuration	73
11.1	Configuration in general.....	73
11.1.1	Configuration procedure	73
11.1.2	Selecting the optimum soft starter	74
11.2	Startup class.....	76
11.2.1	Application examples for normal starting (CLASS 10) with 3RW30 and 3RW40	77
11.2.2	Application examples for heavy-duty starting (CLASS 20): 3RW40 only	78
11.3	ON time and switching frequency	79
11.4	Reducing the rated data	80
11.5	Installation altitude and ambient temperature.....	80

11.6	Calculating the permissible switching frequency	81
11.6.1	Table of permissible assembly combinations with switching frequency factors	81
11.6.2	Calculating the switching frequency (example)	84
11.7	Configuration aids.....	86
11.7.1	Online configurator	86
11.7.2	Win-Soft Starter selection and simulation software	86
11.7.3	Technical Assistance	86
11.7.4	SIRIUS soft starter training course (SD-SIRIUSO)	87
11.8	Order number system for the 3RW30.....	88
11.9	Order number system for the 3RW40.....	89
12	Commissioning	91
12.1	Before commencing work: Isolating the equipment from the supply system and ensuring that it cannot be reconnected.....	91
12.2	Commissioning the 3RW30.....	92
12.2.1	Commissioning procedure	92
12.2.2	Quick commissioning of the 3RW30 and optimization of the parameters	93
12.2.3	Setting the soft start function	94
12.2.4	Setting the starting voltage	95
12.2.5	Setting the ramp time	95
12.2.6	ON output	96
12.3	3RW30: LEDs and troubleshooting	97
12.4	Commissioning the 3RW40.....	98
12.4.1	Commissioning procedure	99
12.4.2	Quick commissioning of the 3RW40 and optimization of the parameters	100
12.4.3	Setting the soft start function	101
12.4.4	Setting the starting voltage	102
12.4.5	Setting the ramp time	102
12.4.6	Current limiting in conjunction with a starting voltage ramp and ramp-up detection	103
12.4.7	Setting the motor current	103
12.4.8	Setting the current limiting value	104
12.4.9	Ramp-up detection	104
12.5	Setting the soft stop function	105
12.5.1	Setting the ramp-down time	105
12.6	Setting the motor protection function.....	105
12.6.1	Setting the electronic motor overload protection	106
12.6.2	Motor current settings	107
12.6.3	Motor protection acc. to ATEX	107
12.7	Thermistor motor protection	108
12.8	Motor protection trip test.....	108
12.9	Functions of the outputs	109
12.9.1	Functions of the BYPASSED and ON / RUN outputs	109
12.9.2	Parameterizing the 3RW40 outputs	110
12.9.3	Function of the FAILURE / OVERLOAD output	112
12.10	RESET MODE and functions of the RESET / TEST button	113
12.10.1	SIRIUS 3RW40 2. to 3RW40 4. soft starters	113

12.10.2	SIRIUS 3RW40 5. to 3RW40 7. soft starters	115
12.11	3RW40: LEDs and troubleshooting	117
13	Technical data	121
13.1	3RW30.....	121
13.1.1	Overview	121
13.1.2	Selection and ordering data for standard applications and normal starting	122
13.1.3	3RW30..-BB.. control electronics	123
13.1.4	3RW30..-BB.. control times and parameters	123
13.1.5	3RW30..-BB.. power electronics	124
13.1.6	3RW30 13, 14, 16, 17, 18-BB.. power electronics	124
13.1.7	3RW30 26, 27, 28-BB.. power electronics	125
13.1.8	3RW30 36, 37, 38, 46, 47-BB.. power electronics	125
13.1.9	3RW30 main conductor cross-sections	126
13.1.10	3RW30 auxiliary conductor cross-sections	127
13.1.11	Electromagnetic compatibility according to EN 60947-4-2	127
13.1.12	Recommended filters	128
13.1.13	Types of coordination	128
13.1.14	Fuseless version	129
13.1.15	Fused version (line protection only)	130
13.1.16	Fused version with SITOR 3NE1 fuses	131
13.1.17	Fused version with SITOR 3NE3/4/8 fuses	132
13.2	3RW40.....	134
13.2.1	Overview	134
13.2.2	Selection and ordering data for standard applications and normal starting (CLASS 10)	135
13.2.3	Selection and ordering data for standard applications and normal starting (CLASS 10) (with thermistor motor protection evaluation)	137
13.2.4	Selection and ordering data for standard applications and normal starting (CLASS 10)	139
13.2.5	Selection and ordering data for standard applications and heavy-duty starting (CLASS 20) ..	141
13.2.6	Selection and ordering data for standard applications and heavy-duty starting (CLASS 20) ..	143
13.2.7	3RW40 2., 3., 4. control electronics	145
13.2.8	3RW40 5., 7. control electronics	145
13.2.9	3RW40 2., 3., 4. control electronics	146
13.2.10	3RW40 5., 7. control electronics	146
13.2.11	3RW40 protection functions	147
13.2.12	3RW40 control times and parameters	147
13.2.13	3RW40 2. to 7. power electronics	148
13.2.14	3RW40 24, 26, 27, 28 power electronics	149
13.2.15	3RW40 36, 37, 38, 46, 47 power electronics	150
13.2.16	3RW40 55, 56, 73, 74, 75, 76 power electronics	151
13.2.17	3RW40 2., 3., 4. main conductor cross-sections	152
13.2.18	3RW40 5., 7. main conductor cross-sections	153
13.2.19	3RW40 .. auxiliary conductor cross-sections	154
13.2.20	Electromagnetic compatibility according to EN 60947-4-2	154
13.2.21	Recommended filters	155
13.2.22	Types of coordination	155
13.2.23	Fuseless version	156
13.2.24	Fused version (line protection only)	157
13.2.25	Fused version with SITOR 3NE1 fuses	158
13.2.26	Fused version with SITOR 3NE3/4/8 fuses	159
13.2.27	Motor protection tripping characteristics for 3RW40 (with symmetry)	161

13.2.28	Motor protection tripping characteristics for 3RW40 (with asymmetry)	161
13.3	Win-Soft Starter selection and simulation software	162
14	Dimension drawings	163
14.1	3RW30 for standard applications	163
14.2	3RW40 for standard applications	164
15	Typical circuit diagrams	167
15.1	Typical circuit for the optional thermistor motor protection evaluation.....	167
15.2	Control by pushbutton	168
15.2.1	Control of the 3RW30 by pushbutton	168
15.2.2	Control of the 3RW40 by pushbutton	169
15.3	Control by switch	170
15.3.1	Control of the 3RW30 by switch	170
15.3.2	Control of the 3RW40 by switch	171
15.4	Control in automatic mode.....	172
15.4.1	Control of the 3RW30 in automatic mode	172
15.4.2	Control of the 3RW40 in automatic mode	173
15.5	Control by PLC	175
15.5.1	Control of the 3RW30 with 24 V DC by PLC	175
15.5.2	Control of the 3RW40 by PLC	176
15.6	Control with an optional main / line contactor.....	177
15.6.1	Control of the 3RW30 with a main contactor	177
15.6.2	Control of the 3RW40 with a main contactor	178
15.7	Reversing circuit.....	180
15.7.1	3RW30 reversing circuit	180
15.7.2	3RW40 reversing circuit	181
15.8	Control of a magnetic parking brake.....	183
15.8.1	3RW30 motor with magnetic parking brake	183
15.8.2	3RW40 2 to 3RW40 4, control of a motor with a magnetic parking brake	184
15.8.3	3RW40 5 to 3RW40 7, control of a motor with a magnetic parking brake	185
15.9	Emergency stop.....	186
15.9.1	3RW30 emergency stop and 3TK2823 safety relay	186
15.9.2	3RW40 2 to 3RW40 4 emergency stop and 3TK2823 safety relay	187
15.9.3	3RW40 5 to 3RW40 7 emergency stop and 3TK2823 safety relay	189
15.10	3RW and contactor for emergency starting.....	191
15.10.1	3RW30 and contactor for emergency starting	191
15.10.2	3RW40 and contactor for emergency starting	192
15.11	Dahlander / multispeed motor	194
15.11.1	3RW30 and Dahlander motor starting	194
15.11.2	3RW40 2 to 3RW40 4 and Dahlander motor starting	195
15.11.3	3RW40 5 to 3RW40 7 and Dahlander motor starting	197
16	Accessories	199
16.1	Box terminal blocks for soft starters	199
16.2	Auxiliary conductor terminals.....	199

16.3	Covers for soft starters	199
16.4	Modules for RESET	200
16.5	Link modules to 3RV10 motor starter protectors	201
16.6	Link modules to 3RV20 motor starter protectors	201
16.7	Optional fan to increase the switching frequency (3RW40 2. to 3RW40 4.).....	202
16.8	Spare parts for fans (3RW40 5., 3RW40 7.).....	202
16.9	Operating instructions.....	202
A	Appendix	203
A.1	Configuration data	203
A.2	Table of parameters used.....	205
A.3	Correction sheet	206

Introduction

1.1 Important notes

Purpose of the manual

This manual contains fundamental information and practical tips for using SIRIUS soft starters. The SIRIUS 3RW30 and 3RW40 soft starters are electronic motor control devices that facilitate optimal starting and stopping three-phase induction motors. The manual describes all of the functions of the SIRIUS 3RW30 and 3RW40 soft starters.

Target group

This manual is intended for any user involved in

- Commissioning
- Servicing and maintaining
- Planning and configuring systems

Basic knowledge required

A general knowledge of the field of electrical engineering is required to understand this manual.

Scope of validity

The manual is valid for the SIRIUS 3RW30 and 3RW40 soft starters. It describes the components that are valid at the time of publication. SIEMENS reserves the right to include a Product Information for each new component, and for each component of a later version.

Standards and approvals

The SIRIUS 3RW30 and 3RW40 soft starters are based on the IEC/EN 60947-4-2 standard.

Disclaimer of liability

It is the responsibility of the manufacturer to ensure that a system or machine is functioning properly as a whole. SIEMENS AG, its regional offices, and associated companies (hereinafter referred to as "SIEMENS") cannot guarantee all the properties of a whole plant system or machine that has not been designed by SIEMENS.

Similarly, SIEMENS can assume no liability for recommendations that appear or are implied in the following description. No new guarantee, warranty, or liability claims beyond the scope of the SIEMENS general terms of supply are to be derived or inferred from the following description.

Orientation aids

The manual contains various features supporting quick access to specific information:

- At the beginning of the manual you will find a table of contents.
- A comprehensive index at the end of the manual allows quick access to information on specific subjects.

Continuously updated information

Your regional contact for low-voltage switchgear with communications capability will be happy to help you with any queries you have regarding the soft starters. A list of contacts and the latest version of the manual are available on the Internet at (www.siemens.com/softstarter):

For all technical queries, please contact:

Technical Assistance:	Phone: +49 (0) 911-895-5900 (8 ⁰⁰ - 17 ⁰⁰ CET) Fax: +49 (0) 911-895-5907 e-mail: (mailto:technical-assistance@siemens.com) Internet: (www.siemens.com/lowvoltage/technical-assistance)
------------------------------	---

Correction sheet

A correction sheet is included at the end of the manual. Please use it to record your suggestions for improvements, additions, and corrections, and return the sheet to us. This will help us to improve the next edition of the manual.

Safety information

2.1 Before commencing work: Isolating the equipment from the supply system and ensuring that it cannot be reconnected.

 **DANGER**

Hazardous voltage Will cause death or serious injury.

- Disconnect the system and all devices from the power supply before starting work.
- Secure against switching on again.
- Verify that the equipment is not live.
- Ground and short-circuit.
- Erect barriers around or cover adjacent live parts.

 **DANGER**

Hazardous voltage Will cause death or serious injury.

Qualified Personnel.

The equipment / system may only be commissioned and operated by qualified personnel. For the purpose of the safety information in these Operating Instructions, a "qualified person" is someone who is authorized to energize, ground, and tag equipment, systems, and circuits in accordance with established safety procedures.

2.2 Five safety rules for work in or on electrical systems

A set of rules, which are summarized in DIN VDE 0105 as the "five safety rules", are defined for work in or on electrical systems as a preventative measure against electrical accidents:

1. Isolate
2. Secure against switching on again
3. Verify that the equipment is not live
4. Ground and short-circuit
5. Erect barriers around or cover adjacent live parts

These five safety rules must be applied in the above order prior to starting work on an electrical system. After completing the work, proceed in the reverse order.

It is assumed that every electrician is familiar with these rules.

Explanations

1. The isolating distances between live and deenergized parts of the system must vary according to the operating voltage that is applied.
"Isolate" refers to the all-pole disconnection of live parts.
All-pole disconnection can be achieved, e.g. by.:
 - Switching off the miniature circuit breaker
 - Switching off the motor circuit breaker
 - Unscrewing fusible links
 - Removing LV HRC fuses
2. The feeder must be secured against inadvertent restarting to ensure that it remains isolated for the duration of the work. This can be achieved, for instance, by securing the motor and miniature circuit breakers with lockable blocking elements in the disconnected state, either using a lock or by unscrewing the fuses.
3. The deenergized state of the equipment should be verified using suitable test equipment, e.g. a two-pole voltmeter. Single-pole test pins are not suitable for this purpose. The absence of power must be established for all poles, phase to phase, and phase to N/PE.
4. Grounding and short-circuiting are only mandatory if the system has a nominal voltage greater than 1 kV. In this case, the system should always be grounded first and then connected to the live parts to be short-circuited.
5. These parts should be covered, or barriers erected around them, to avoid accidental contact during the work with adjacent parts that are still live.

Product description

3.1 Fields of application

Soft starters are used to start three-phase induction motors with reduced torque and reduced starting current.

SIRIUS soft starter family

The SIEMENS SIRIUS soft starter family comprises three different versions with different functionalities and prices.

3RW30 and 3RW40

Simple or standard applications are covered by the SIRIUS 3RW30 and 3RW40 soft starters and are described in this manual.

3RW44

The SIRIUS 3RW44 soft starter is used if higher functionality is specified, e.g. communication over PROFIBUS or the availability of measuring and monitoring values, as well as for ultra-heavy-duty starting. The SIRIUS 3RW44 soft starter is described in a separate system manual.

Download from 3RW44 manual (<http://support.automation.siemens.com/WWW/lisapi.dll?func=cslib.csinfo&lang=de&objid=21772518&caller=view>).

3.2 Basic physical principles of a three-phase induction motor

SIRIUS soft starters are used to reduce the current and torque of a three-phase induction motor during the startup process.

3.2.1 Three-phase induction motor

Fields of application

Three-phase induction motors are used in a wide range of applications in commerce, industry, and trade owing to their simple, robust design and their minimal maintenance.

Problem

If a three-phase induction motor is started directly, its typical current and torque characteristics can cause disturbances in the supply system and the load machine.

Starting current

Three-phase induction motors have a high direct starting current I_{starting} . Depending on the motor type, this current can be between three and fifteen times as high as the rated operational current. Seven or eight times the motor's rated current can be assumed as a typical value.

Disadvantage

This results in the following disadvantage:

- Higher load on the electrical supply system. The supply system must therefore be dimensioned for this higher power during the motor startup.



Figure 3-1 Typical starting current characteristic of a three-phase induction motor

Starting torque

The starting torque and the breakdown torque can usually be assumed to be between two and four times the rated torque. From the point of view of the load machine, this means that the starting and acceleration forces exert a higher mechanical load on the machine and the product being conveyed compared to nominal operation.

Disadvantages

This results in the following disadvantages

- A higher load is placed on the machine's mechanical components
- The costs for replacing worn parts and maintaining the application are higher

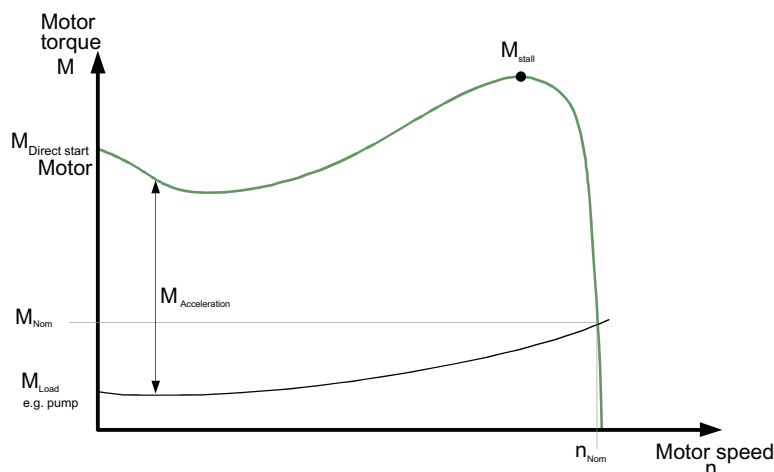

Figure 3-2 Typical starting torque characteristic of a three-phase induction motor

Remedy

The SIRIUS 3RW30 and 3RW40 electronic soft starters allow the current and torque characteristics during starting to be optimally adapted to the requirements of each application.

3.3 Functional principle of the SIRIUS 3RW30 and 3RW40 soft starters

The SIRIUS 3RW30 and 3RW40 soft starters have two antiparallel thyristors in two out of the three phases. One thyristor for the positive half-wave and one for the negative half-wave is provided in each phase (refer to Fig. "Phase angle control and schematic diagram of a two-phase controlled soft starter with integral bypass contacts"). The current in the third, uncontrolled phase is the sum of the currents in the controlled phases.

The rms value of the motor voltage is increased (from a settable starting voltage) to the rated motor voltage within a definable ramp-up time by means of the phase angle control.

The motor current changes in proportion to the voltage applied to the motor. As a result, the starting current is reduced by the factor of this voltage.

There is a quadratic relationship between the torque and the voltage applied to the motor. As a result, the starting torque is reduced quadratically in relation to this voltage.

Example

SIEMENS 1LG4253AA motor (55 kW)

Rated data at 400 V

P_e :	55 kW
I_e :	100 A
$I_{\text{direct starting}}$:	Approx. 700 A
M_e :	355 Nm ; e.g.: $M_e = 9.55 \times 55 \text{ kW} \times \frac{1000}{1480 \text{ min}^{-1}}$
n_e :	1480 rpm
$M_{\text{direct starting}}$:	Approx. 700 Nm
Set starting voltage:	50 % ($\frac{1}{2}$ of mains voltage)
$\Rightarrow I_{\text{starting}}$	$\frac{1}{2}$ of direct starting current (approx. 350 A)
$\Rightarrow M_{\text{starting}}$	$\frac{1}{4}$ of direct starting torque (approx. 175 Nm)

The diagrams below show the starting current and torque characteristics for a three-phase induction motor in combination with a soft starter:

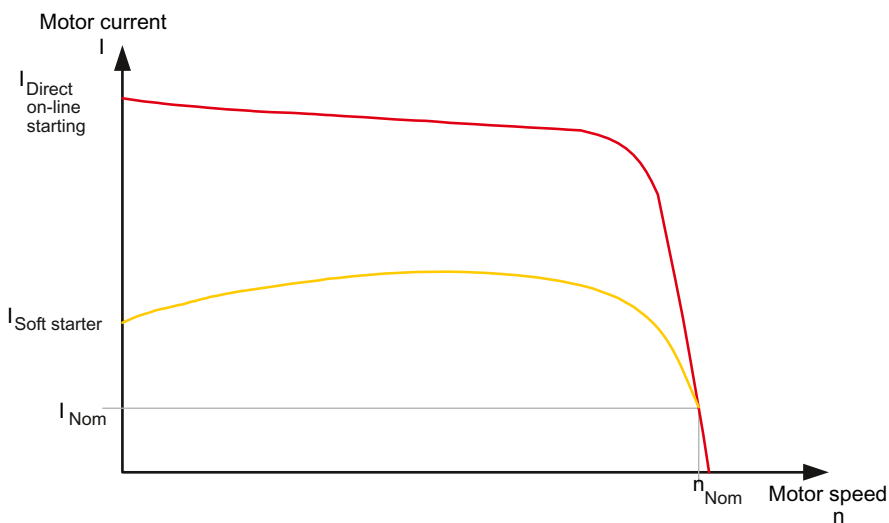

Figure 3-3 Reduced current characteristic of a three-phase induction motor during starting with a SIRIUS 3RW30 or 3RW40 soft starter

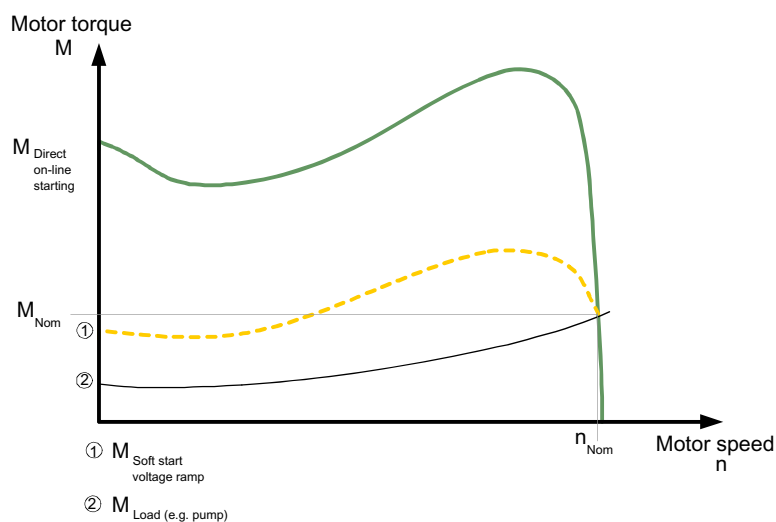

Figure 3-4 Reduced torque characteristic of a three-phase induction motor during starting with a SIRIUS 3RW30 or 3RW40 soft starter

Soft start /soft stop

This means that, since the motor voltage is controlled by the electronic soft starter during the startup process, the consumed starting current and the starting torque generated in the motor are also controlled.

The same principle is applied during the stop process. This ensures that the torque generated in the motor is gradually reduced, so that the application can stop smoothly (the soft stop function is only supported by the 3RW40).

The frequency remains constant during this process and corresponds to the mains frequency, in contrast to frequency controlled starting and stopping of a frequency converter.

Bypass mode

Once the motor has been started up correctly, the thyristors are subject to fully advanced control, meaning that the whole mains voltage is applied to the motor terminals. As the motor voltage does not have to be controlled during operation, the thyristors are bridged by integral bypass contacts that are rated for AC1 current. This minimizes the waste heat generated during uninterrupted duty (which is caused by the thyristor's power loss), and minimizes heating up of the switching device's environment.

The bypass contacts are protected by an integrated, electronic arc quenching system during operation. If they are opened in the event of a fault, e.g. if the control voltage is temporarily interrupted, mechanical vibrations occur, or the coil operating mechanism or the main contact spring has reached the end of its service life and is defective, the equipment is not damaged.

The diagram below shows the method of operation of the SIRIUS 3RW30 and 3RW40 soft starters:

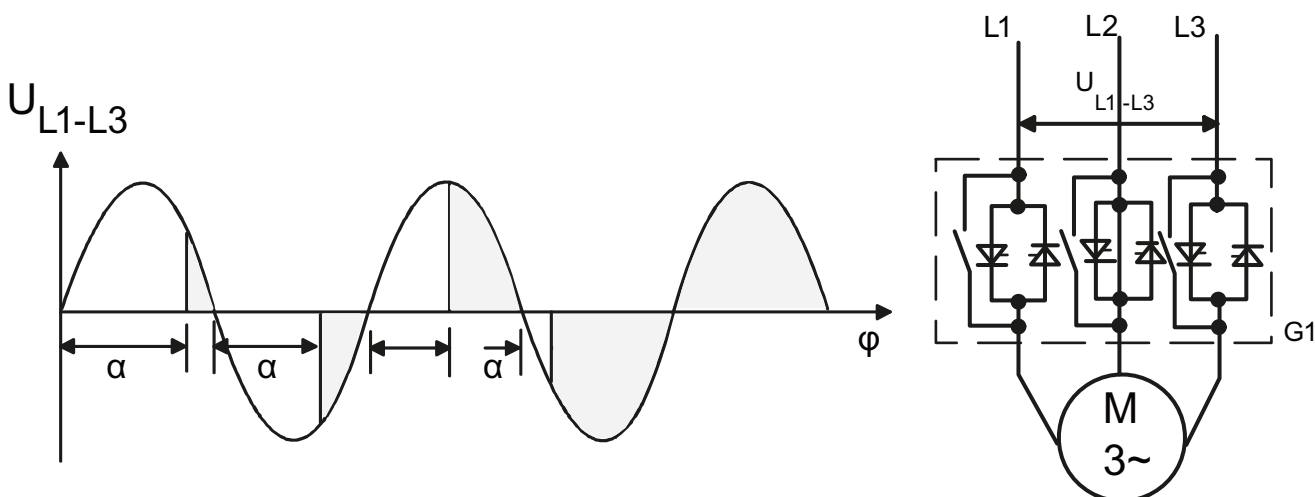

Figure 3-5 Phase angle control and schematic diagram of a two-phase controlled soft starter with integral bypass contacts

3.3.1 Method of operation of a two-phase controlled soft starter

A special method of operation is used for the SIRIUS 3RW30 and 3RW40 two-phase controlled soft starters based on SIEMENS' patented "polarity balancing" control principle.

Two-phase control

The SIRIUS 3RW30 and 3RW40 soft starters are two-phase controlled soft starters, in other words they are designed with two antiparallel thyristors in each of phases L1 and L3. Phase 2 is an uncontrolled phase, which is merely guided through the starter by a copper connection.

In a two-phase controlled soft starter, the current that results from the superimposition of the two controlled phases flows in the uncontrolled phase. The main advantages of two-phase control include the more compact size compared to a three-phase version and the lower hardware costs.

The occurrence of DC components, caused by the phase angle and the overlapping phase currents, is a negative physical effect of two-phase control during the startup process that can mean a louder noise is produced by the motor. The "polarity balancing" control principle was developed and patented by SIEMENS to prevent these DC components during starting.

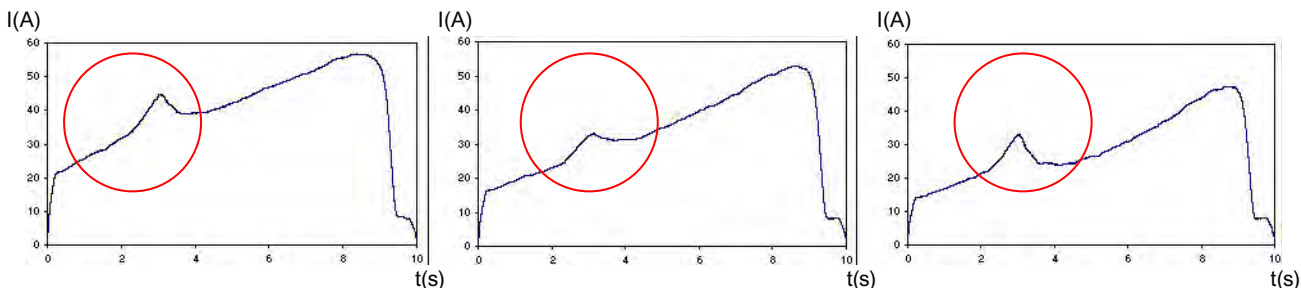

Figure 3-6 Current characteristic and occurrence of DC components in the three phases without "polarity balancing"

Polarity balancing

"Polarity balancing" effectively eliminates these DC components during the ramp-up phase. It allows the motor to be started up with a constant speed, torque, and current rise.

The acoustic quality of the startup process comes very close to that of a three-phase controlled startup. This is made possible by the continuous dynamic alignment and balancing of current half-waves with different polarities during the motor startup.

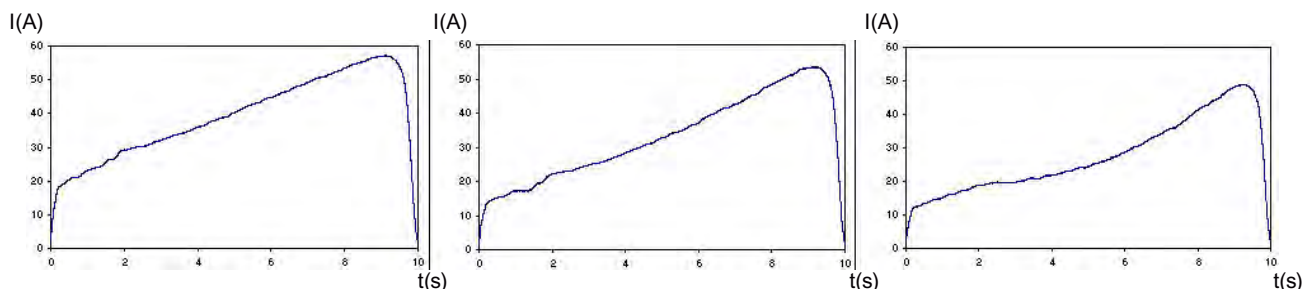

Figure 3-7 Current characteristic in the three phases without DC components thanks to "polarity balancing"

3.3.2 Starting current asymmetry

With two-phase control the starting current is asymmetrical for physical reasons, because the current in the uncontrolled phase is the sum of the currents in the two controlled phases.

This asymmetry can be as much as 30 to 40% during starting (ratio of minimum current to maximum current in all three phases).

Even though this cannot be influenced, it is not critical in most applications. It could cause an insufficiently rated fuse to trip in the uncontrolled phase, for instance. For recommended fuse ratings, refer to the tables in chapter Technical data [Page 121].

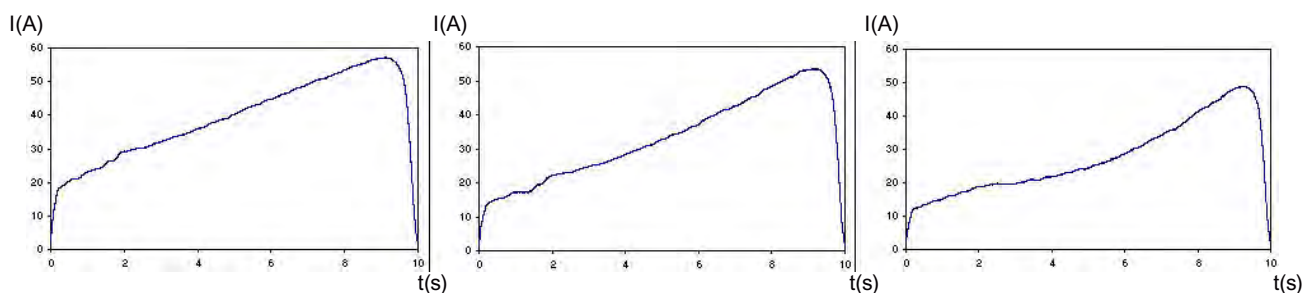

Figure 3-8 Starting current asymmetry

Note

If wye-delta starters are exchanged for soft starters in an existing system, you should check the fuse ratings in the feeder in order to avoid false tripping. This is particularly important in connection with heavy-duty starting or if the fuse that is installed has already been operated close to the thermal tripping limit with the wye-delta assembly.

All elements of the main circuit (such as fuses, motor starter protectors, and switching devices) must be dimensioned for direct starting and according to the on-site short-circuit conditions, and ordered separately.

For recommended fuse and motor starter protector ratings for the feeder with soft starter, refer to chapter Technical data [Page 121].

3.3.3 Applications and use

Applications and selection criteria

The SIRIUS 3RW30 and 3RW40 soft starters represent a good alternative to direct or wye-delta starters.

The most important advantages are:

- Soft start
- Soft stop (3RW40 only)
- Uninterrupted switching without current peaks that place a heavy load on the system
- Simple installation and commissioning
- Compact, space-saving design

Applications

The typical applications include:

- Conveyor belts
- Roller conveyors
- Compressors
- Fans
- Pumps
- Hydraulic pumps
- Agitators
- Circular saws / band saws

Advantages

Conveyor belts and transport systems:

- Smooth starting
- Smooth stopping

Rotary pumps and piston pumps:

- No pressure surges
- Increased service life of the pipe system

Agitators and mixers:

- Reduced starting current

Fans:

- Protection for the gearbox and V belt

3.4 Comparison of device functions



		SIRIUS 3RW30 Standard applications	SIRIUS 3RW40 Standard applications	SIRIUS 3RW44 High Feature applications
Rated current at 40 °C / 50 °C	A	3 ... 106 / 3 ... 98	12.5...432 / 11 ... 385	29 ... 1214 / 26 ... 1076
Rated operational voltage	V	200...480	200...600	200...690
Motor rating at 400 V / 460 V				
•Standard connection	kW /hp	1.5...55 / 1.5 ... 75	5.5...250 / 7.5 ... 300	15...710 / 15 ... 950
•Inside-delta circuit	kW /hp	–	–	22...1200 / 30 ... 1700
Ambient temperature	°C	-25...+60	-25...+60	0 ... + 60
Soft start/soft stop		✓ ¹⁾	✓	✓
Voltage ramp		✓	✓	✓
Starting/stopping voltage	%	40...100	40...100	20...100
Ramp-up and ramp-down time	s	0 ... 20	0 ... 20	1 ... 360
Torque control		–	–	✓
Starting/stopping torque	%	–	–	20...100
Torque limiting	%	–	–	20...200
Ramp time	s	–	–	1 ... 360
Integrated jumper contact system		✓	✓	✓
Intrinsic device protection		–	✓	✓
Motor overload protection		–	✓ ⁷⁾	✓
Thermistor motor protection		–	✓ ²⁾	✓
Integrated remote RESET		–	✓ ³⁾	✓
Settable current limiting		–	✓	✓
Inside-delta circuit		–	–	✓
Breakaway torque		–	–	✓
Creep speed in both directions of rotation		–	–	✓
Pump stop		–	–	✓ ⁴⁾
DC braking		–	–	✓ ^{4) 5)}
Combined braking		–	–	✓ ^{4) 5)}
Motor heating		–	–	✓
Communication		–	–	With PROFIBUS DP (option)
External display and operator control module		–	–	(option)
Status measured value display		–	–	✓
Error log		–	–	✓
Events list		–	–	✓
Min/max pointer function		–	–	✓
Trace function		–	–	✓ ⁶⁾
Programmable control inputs and outputs		–	–	✓
Number of parameter sets		1	1	3
Parameterizing software (SoftStarterES)		–	–	✓
Power semiconductors (thyristors)		2 controlled phases	2 controlled phases	3 controlled phases
Screw terminals		✓	✓	✓
Spring-loaded terminals		✓	✓	✓
UL/CSA		✓	✓	✓
CE mark		✓	✓	✓
Soft starting under heavy-duty starting		–	–	✓ ⁴⁾

Support for configuration
 Win-Soft Starter, electronic selection slider, Technical Assistance ++49 9118955900
 ✓ Function available; – function not available.
 1) For 3RW30 only soft start.
 2) Optional up to size S3 (device variants).

3) For 3RW402. to 3RW404.; for 3RW405. and 3RW407. optional.
 4) If necessary, overdimension soft starter and motor.

5) Not possible in inside-delta circuit.
 6) Trace function with SoftStarterES software.
 7) Acc. to ATEX

Product combinations

4.1 SIRIUS modular system

Switching, protecting, and starting motors

In order to simplify the assembly of load feeders, the SIRIUS modular system offers standard components that are optimally harmonized and are easy to combine. Just 7 sizes cover the entire performance range up to 250 kW / 300 hp. The individual switching devices can be assembled to form complete load feeders, either using link modules or by mounting directly.

For a selection of matching device combinations, e.g. soft starters and motor starter protectors, refer to chapter Technical data [Page 121].

For further information on individual products, refer to System manual (<http://support.automation.siemens.com/WW/llisapi.dll?aktprim=0&lang=en&referer=%2fWW%2f&func=cslib.csinfo&siteid=csius&caller=view&extranet=standard&viewreg=WW&nodeid0=20025979&objaction=csopen>) "Innovations in the SIRIUS modular system", Order No. 3ZX1012-0RA01-1AB1.

Product combinations

4.1 SIRIUS modular system



SIRIUS motor starter protectors				SENTRON circuit breakers		
						
3RV20 11 (S00)	3RV20 21 (S0)	3RV10 31 (S2)	3RV10 41 (S3)	VL250/3VL3	VL400/3VL4	VL630/3VL5
SIRIUS contactors						
						
3RT20 1 (S00)	3RT20 2 (S0)	3RT10 3 (S2)	3RT1. 4 (S3)	3RT1. 5 (S6)	3RT1. 6 (S10)	3RT1. 7 (S12)
SIRIUS overload relays						
						
3RB30 16 (S00)	3RB30 26 (S0)	3RB20 36 (S2)	3RB20 46 (S3)	3RB20 56 (S6)	3RB20 66 (S10/S12)	
SIRIUS soft starters						
						
3RW30 1 (S00)	3RW40 2 (S0)	3RW40 3 (S2)	3RW40 4 (S3)	3RW40 5 (S6)	3RW40 7 (S10/S12)	

Figure 4-1

SIRIUS modular system

Functions

5.1 Start modes

You can choose between different startup functions reflecting the wide range of applications and functionality of the SIRIUS 3RW30 and 3RW40 soft starters. The motor start can be optimally adapted to each particular application.

5.1.1 Voltage ramp

The SIRIUS 3RW30 and 3RW40 soft starters achieve soft starting by means of a voltage ramp. The motor terminal voltage is increased from a parameterizable starting voltage up to the mains voltage within a definable ramp-up time.

Starting voltage

The starting voltage determines the starting torque of the motor. A lower starting voltage results in a lower starting torque and a lower starting current. The starting voltage selected must be sufficiently high to ensure that motor starts up smoothly as soon as the start command is received by the soft starter.

Ramp time

The length of the set ramp time determines the time taken to increase the motor voltage from the parameterized starting voltage to the mains voltage. This influences the motor's acceleration torque, which drives the load during the ramp-up process. A longer ramp time results in a lower acceleration torque as the motor is started up. The startup is slower and smoother as a result. The ramp time should be long enough for the motor to reach its nominal speed. If the time selected is too short, in other words if the ramp time ends before the motor has started up successfully, a very high starting current that can even equal the direct starting current at the same speed occurs at this instant.

The SIRIUS 3RW40 soft starter limits the current to the value set with the current limiting potentiometer (refer to chapter Current limiting and ramp-up detection (3RW40 only) [Page 29]). As soon as the current limiting value is also reached, the voltage ramp or the ramp time is interrupted and the motor is started with the current limiting value until it has started up successfully. In this case, the motor ramp-up time may be longer than the maximum parameterizable 20 seconds ramp time (for further information about the maximum ramp-up times and switching frequencies, refer to chapter 3RW40 2. to 7. power electronics [Page 148] ff).

The SIRIUS 3RW40 soft starter has intrinsic device protection, current limiting, and ramp-up detection functions. These functions do not form part of the SIRIUS 3RW30 soft starter.

CAUTION

Risk of property damage

When using the 3RW30: Make sure the selected ramp time is longer than the actual motor ramp-up time. If not, the SIRIUS 3RW30 may be damaged because the internal bypass contacts close when the set ramp time elapses. If the motor has not finished starting up, an AC3 current that could damage the bypass contact system will flow.

When using the 3RW40: The 3RW40 has an integrated ramp-up detection function that prevents this operating state from occurring.

The maximum ramp time for the SIRIUS 3RW30 soft starter is 20 seconds. An appropriately dimensioned SIRIUS 3RW40 or 3RW44 soft starter should be chosen for startup processes with a motor ramp-up time > 20 seconds.

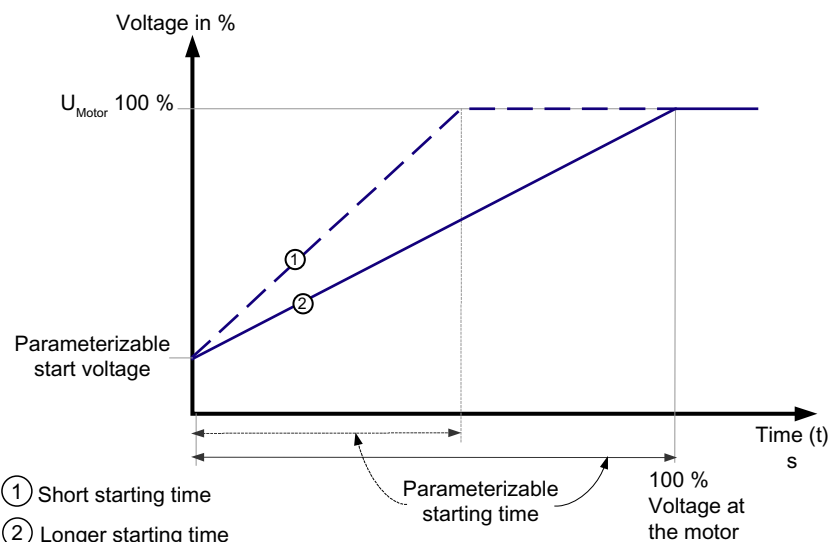

Figure 5-1 Principle of the voltage ramp

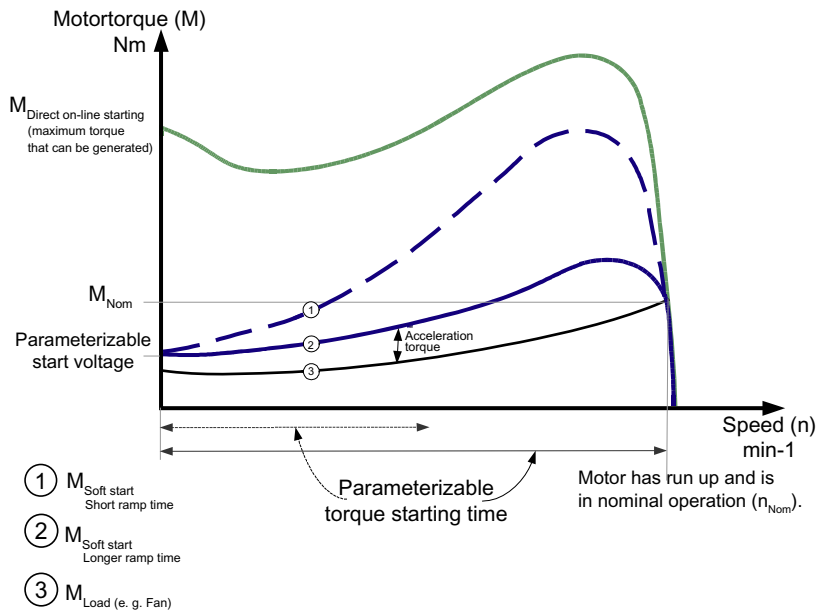

Figure 5-2 Principle of the voltage ramp for the torque characteristic

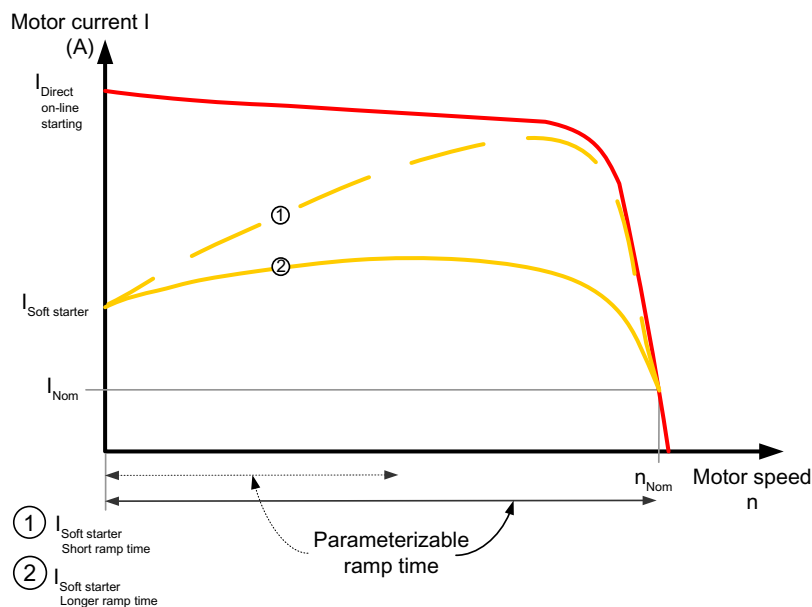

Figure 5-3 Principle of the voltage ramp for the starting current characteristic

Typical applications of the voltage ramp

The voltage ramp principle is valid for all applications, e.g. pumps, compressors, conveyor belts.

5.1.2 Current limiting and ramp-up detection (3RW40 only)

The SIRIUS 3RW40 soft starter measures the phase current (motor current) continuously with the help of integrated current transformers.

The motor current that flows during the startup process can be actively limited by means of the soft starter. The current limiting function takes priority over the voltage ramp function. As soon as a parameterizable current limit is reached, in other words, the voltage ramp is interrupted and the motor is started with the current limiting value until it has started up successfully. The current limiting function is always active with SIRIUS 3RW40 soft starters. If the current limiting potentiometer is set to the clockwise stop (maximum), the starting current is limited to five times the set rated motor current.

Current limiting value

The current limiting value is set to the current required during starting as a factor of the rated motor current. Since the starting current is asymmetrical, the set current corresponds to the arithmetic mean value for the three phases.

Example

If the current limiting value is set to 100 A, the currents might be approx. 80 A in L1, 120 A in L2, and 100 A in L3 (refer to chapter Starting current asymmetry [Page 21]).

As soon as the selected current limiting value is reached, the motor voltage is reduced or controlled by the soft starter to prevent the current from exceeding the limit. The set current limiting value must be high enough to ensure that the torque generated in the motor is sufficient to accelerate the motor to nominal speed. Three to four times the value of the motor's rated operational current (I_e) can be assumed as typical here.

The current limiting function is always active because it is required by the intrinsic device protection. If the current limiting potentiometer is set to the clockwise stop (maximum), the starting current is limited to five times the set rated motor current.

Ramp-up detection (3RW40 only)

The SIRIUS 3RW40 soft starter is equipped with an integrated ramp-up detection function. If it detects a motor startup, the motor voltage is immediately increased to 100 % of the mains voltage. The internal bypass contacts close and the thyristors are bridged.

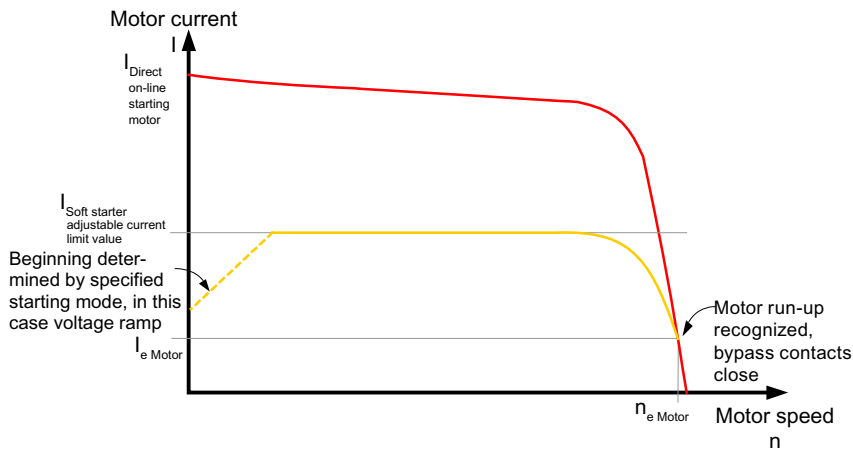

Figure 5-4 Current limiting with soft starter

Typical applications for current limiting

Current limiting is used for applications with large centrifugal masses (mass inertias) and therefore longer ramp-up times, e.g. fans, circular saws etc.

5.2 Stop modes

You can choose between different stop modes reflecting the wide range of applications for SIRIUS soft starters. The motor stop can be optimally adapted to each particular application.

If a start command is issued during the stop process, the process is interrupted and the motor is started again with the set start mode.

Note

If you select "soft stop" (3RW40 only) as the stop mode, the feeder (soft starter, cables, feeder protective devices, and motor) may need to be dimensioned for higher values because the current exceeds the rated motor current during the stop process.

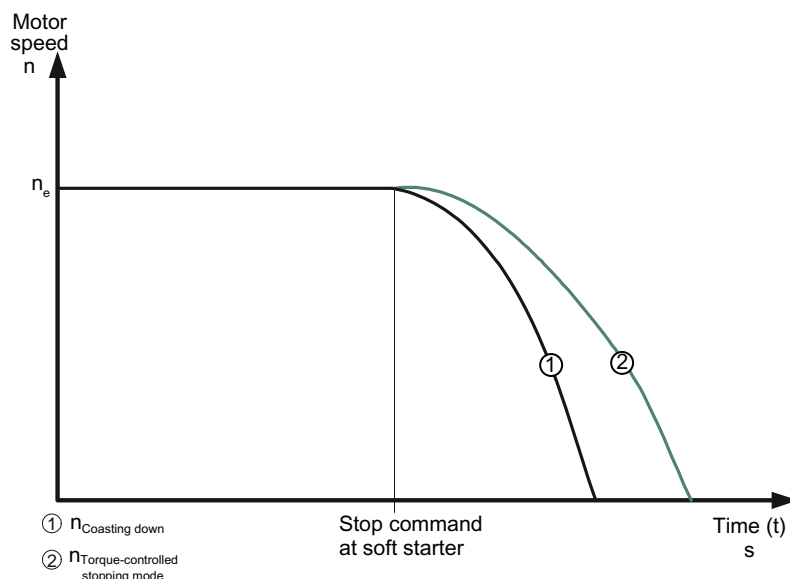

5.2.1 Stop without load (3RW30 and 3RW40)

"Stop without load" means the power supplied to the motor via the soft starter is interrupted when the ON command is removed from the starter. The motor coasts to a standstill, driven only by the mass inertia (centrifugal mass) of the rotor and load. This is also referred to as a natural stop. A large centrifugal mass means a longer stop time without load.

Typical applications for stop without load

Stop without load is used for loads that place no special demands on the startup characteristic, e.g. fans.

5.2.2 Soft stop (3RW40 only)

In "soft stop" mode, the natural stop process of the load is decelerated. The function is used when the load must be prevented from stopping abruptly. This is typically the case in applications with a low mass inertia or a high counter-torque.

Ramp-down time

The "Ramp-down time" potentiometer on the soft starter allows you to specify how long power should still be supplied to the motor after the ON command is removed. The torque generated in the motor is reduced by means of a voltage ramp function within this ramp-down time and the application stops smoothly.

If the motor is stopped abruptly in pump applications, as is normal with wye-delta or direct starting, for instance, water hammer can occur. Water hammer is caused by the sudden flow separation, leading to pressure fluctuations on the pump. It has the effect of producing noise and mechanical impacts on the pipelines as well as on any flaps and valves installed there.

Water hammer can be reduced compared to direct or wye-delta starting by using the SIRIUS 3RW40 soft starter. An optimum pump stop is achieved using a SIRIUS 3RW44 soft starter with an integrated pump stop function (refer to chapter Comparison of device functions [Page 24]).

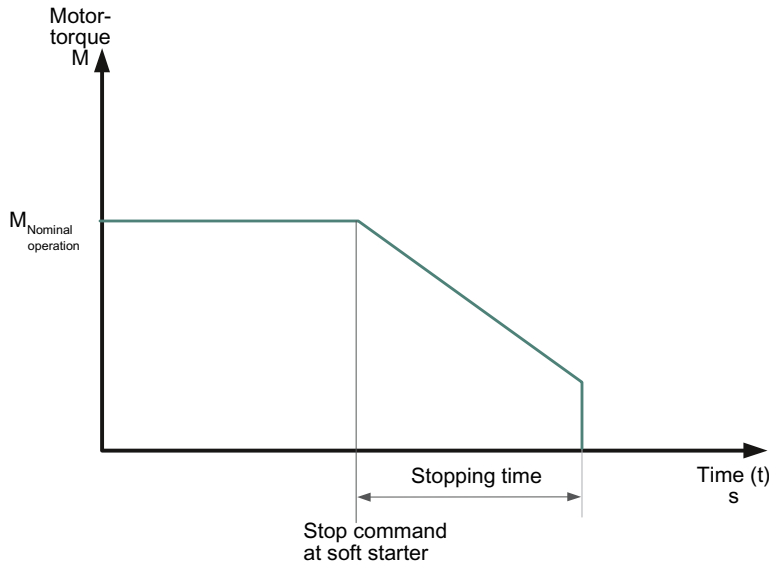

Typical applications for soft stop

Use soft stop for

- Pumps to reduce water hammer.
- Conveyor belts to prevent the conveyed product from tilting.

5.3 Motor protection / intrinsic device protection (3RW40 only)

NOTICE

If the soft starter is disconnected because the motor overload protection or the intrinsic device protection trips, you must wait a defined cooling time (recovery time) prior to acknowledging the fault or starting the motor again. (Motor overload tripping time: 60 seconds, temperature sensor: after cooling, intrinsic device protection tripping time: > 30 seconds)

5.3.1 Motor protection function

The motor overload protection function is implemented on the basis of the winding temperature. This indicates whether the motor is overloaded or functioning in the normal operating range.

The winding temperature can either be calculated with the help of the integrated, electronic motor overload function or measured with a connected motor thermistor.

The two types of protection must be combined to achieve full motor protection. This combination is recommended to protect the motor optimally.

Note

Thermistor motor protection evaluation

The thermistor motor protection evaluation function is optionally available for the SIRIUS 3RW40 2 to 3RW40 4 soft starters in the 24 V AC/DC control voltage version.

Motor overload protection

The current flow during motor operation is measured by measuring the current with transformers integrated in the soft starter. The temperature rise in the winding is calculated based on the rated operational current set for the motor.

A trip is generated by the soft starter when the characteristic is reached, depending on the trip class (CLASS setting).

ATEX

"Increased safety" type of protection EEx e acc. to ATEX Directive 94/9/EC

The SIRIUS 3RW40 soft starter sizes S0 to S12 are suitable for starting explosion-proof motors with the "increased safety" type of protection EEx e (type of protection / marking: Ex II (2) GD).

Wire the fault output (95 96) to an upstream switching device in such a way that if a fault occurs, this device disconnects the feeder (refer to Fig. "3RW40 wiring fault with 3RV").

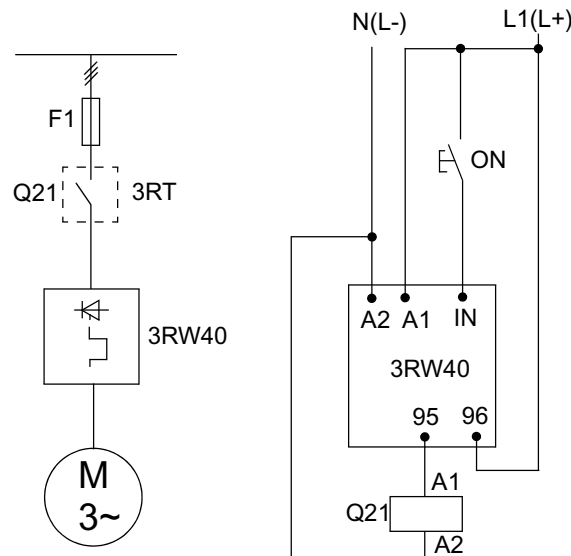

Figure 5-5 3RW40 wiring fault

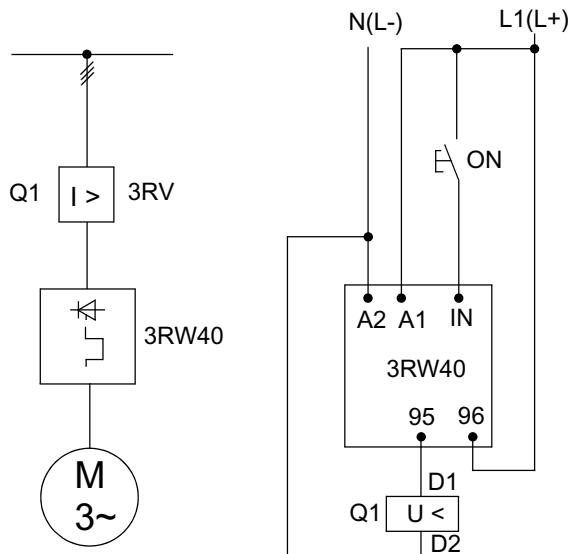

Figure 5-6 3RW40 wiring fault with 3RV

For further information, refer to the operating instructions, Order No. 3ZX1012-0RW40-1CA1 (<http://support.automation.siemens.com/WW/view/de/22809303>).

<p>⚠ WARNING</p> <p>Danger of death or serious injury.</p> <p>The 3RW40 is not suitable for installation in hazardous areas. The device is only allowed to be installed in a control cabinet with the IP4x degree of protection. Appropriate measures (e.g. encapsulation) must be taken if it is to be installed in a hazardous area.</p>
--

Trip class (electronic overload protection)

The trip class (CLASS) specifies the maximum time within which a protective device must trip from a cold state at 7.2 x the rated operational current (motor protection to IEC 60947). The tripping characteristics represent this time as a function of the tripping current (refer to chapter Motor protection tripping characteristics for 3RW40 (with symmetry) [Page 161]). You can set different CLASS characteristics according to the startup class.

Note

The rated data of the soft starters refers to normal starting (CLASS 10). The starters may need to be calculated with a size allowance for heavy-duty starting (> CLASS 10). You can only set a rated motor current that is lower than the soft starter rated current (for the permissible settings, refer to chapter Technical data [Page 121]).

Recovery time (motor overload protection)

A recovery time of 60 seconds, during which the motor cools down and cannot be restarted, starts if the thermal motor model is tripped.

Protection against voltage failure in the event of a fault

If the control supply voltage fails during a trip, the current tripping state of the thermal motor model and the current recovery time are stored in the soft starter. When the control supply voltage is restored, the current tripping state of the thermal motor model and the intrinsic device protection prior to the power failure are likewise automatically restored. If the control voltage is disconnected during operation (without a preceding fault trip), the starter is not protected against voltage failure.

Temperature sensor

Note

Temperature sensor

The temperature sensor evaluation function is optionally available for the SIRIUS 3RW40 24 to 3RW40 47 soft starters in the 24 V AC/DC control voltage version.

This motor protection function measures the motor's stator winding temperature directly with the help of a sensor installed in the motor, in other words the motor must have a sensor wound into the stator winding.

You can choose between two different sensor types for the evaluation.

1. Type A PTC thermistors ("type A sensors") for connection to terminals T11/21 and T12
2. Thermoclick sensors for connection to terminals T11/21 and T22

The wiring and sensors are monitored for wire breakage and short-circuits.

Recovery time (thermistor motor protection)

If the thermistor motor protection is tripped, the soft starter cannot be restarted until the sensor installed in the motor has cooled down. The recovery time varies according to the temperature state of the sensor.

5.3.2 Intrinsic device protection (3RW40 only)

Thyristor protection (thermal)

SIRIUS 3RW40 soft starters are equipped with integrated intrinsic device protection to prevent thermal overloading of the thyristors.

This is achieved on the one hand by means of current measuring transformers in the three phases and on the other, by measuring the temperature with temperature sensors on the thyristor's heat sink.

If the fixed, internally set trip value is exceeded, the soft starter is automatically disconnected.

Recovery time (intrinsic device protection)

If the intrinsic device protection is tripped, the soft starter cannot be restarted until a recovery time of at least 30 seconds has elapsed.

Thyristor protection (short-circuit)

SITOR semiconductor fuses must be connected upstream to protect the thyristors against short-circuits (e.g. in case of cable damage or an interturn fault in the motor; refer to chapter Soft starter assembly with type of coordination 2 [Page 61]). For the fuse selection tables, refer to chapter Technical data [Page 121].

Protection against voltage failure (in the event of a fault)

If the control supply voltage fails during a trip, the current tripping state of the thermal intrinsic device protection model and the current recovery time are stored in the soft starter. When the control supply voltage is restored, the current tripping state of the thermal intrinsic device protection prior to the power failure are likewise automatically restored.

NOTICE

If the control voltage is disconnected during operation (e.g. in "automatic mode"), the starter is not protected against voltage failure. You must wait five minutes between two starts to ensure that the motor protection and the intrinsic device protection are working correctly.
--

5.4 Functions of the RESET buttons

5.4.1 SIRIUS 3RW40 2, 3RW40 3, and 3RW40 4 soft starters

5.4.1.1 RESET MODE button and LED

By pressing the RESET MODE button, you define the reset procedure in case of a fault. This is indicated by the RESET MODE LED.

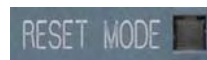

Yellow = AUTO
Off = MANUAL
Green = REMOTE

Note

On the SIRIUS 3RW40 2. soft starter, the RESET MODE button is located underneath the label (refer to chapter Operator controls, displays, and connections on the 3RW40 [Page 70])

5.4.1.2 Manual RESET

Manual RESET with the RESET / TEST button (RESET MODE LED = off)

You can reset a fault by pressing the RESET / TEST button.



5.4.1.3 Remote RESET

Remote RESET (RESET MODE LED = green)

You can reset a fault signal by disconnecting the control supply voltage for >1.5 s.

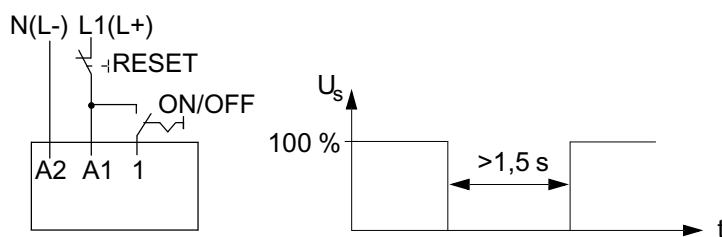

5.4.1.4 AUTO RESET

AUTO RESET (RESET MODE LED = yellow)

If you set the RESET mode to AUTO, a fault is automatically reset as follows:

- If the motor overload protection function trips: after 60 s
- If the intrinsic device protection function trips: after 30 s
- If the thermistor evaluation function trips: after the temperature sensor in the motor has cooled down

WARNING
<p>Automatic restart Danger of death, serious injury, or property damage.</p> <p>The automatic RESET mode (AUTO RESET) must not be used in applications where there is a risk of serious injury to persons or substantial damage to property if the motor starts up again unexpectedly. The start command (e.g. issued by a contact or the PLC) must be reset prior to issuing a RESET command because the motor attempts to restart again automatically following this RESET command if a start command is still present. This particularly applies if the motor protection has tripped. For safety reasons, you are advised to integrate the group fault output (terminals 95 and 96) in the controller.</p>

5.4.1.5 Acknowledging faults

For information about whether or not faults can be acknowledged as well as the corresponding LED and output contact states, refer to chapter Diagnostics and fault signals [Page 44].

5.4.2 SIRIUS 3RW40 5 and 3RW40 7 soft starters

5.4.2.1 RESET MODE button and AUTO LED

By pressing the RESET MODE button, you define the reset procedure in case of a fault. This is indicated by the AUTO LED.



Yellow = AUTO
Off = MANUAL (REMOTE)

5.4.2.2 Manual RESET

Manual RESET with the RESET / TEST button (AUTO LED = off)

You can reset a fault by pressing the RESET / TEST button.

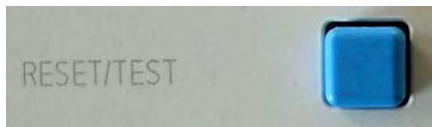

5.4.2.3 Remote RESET

Remote RESET (AUTO LED = green)

You can initiate a remote RESET by controlling the optional module for RESET (3RU1900-2A).

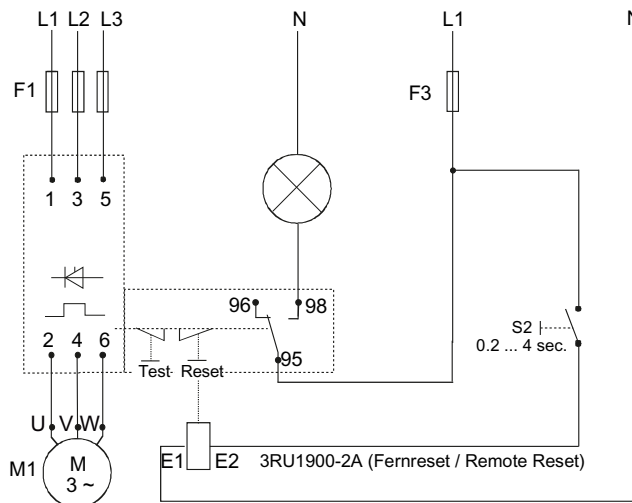

5.4.2.4 AUTO RESET

AUTO RESET (AUTO LED = yellow)

If you set the RESET mode to AUTO, a fault is automatically reset as follows:

- If the motor overload protection function trips: after 60 s
- If the intrinsic device protection function trips: after 30 s

 WARNING
<p>Automatic restart Can result in death, serious injury, or property damage.</p> <p>The automatic RESET mode (AUTO RESET) must not be used in applications where there is a risk of serious injury to persons or substantial damage to property if the motor starts up again unexpectedly. The start command (e.g. issued by a contact or the PLC) must be reset prior to issuing a RESET command because the motor attempts to restart again automatically following this RESET command if a start command is still present. This particularly applies if the motor protection has tripped. For safety reasons, you are advised to integrate the group fault output (terminals 95 and 96) in the controller.</p>

5.4.2.5 Acknowledging faults

For information about whether or not faults can be acknowledged as well as the corresponding LED and output contact states, refer to chapter Diagnostics and fault signals [Page 44].

5.4.3 Other functions of the RESET button

5.4.3.1 Motor protection trip test

You initiate a motor overload trip by pressing the RESET / TEST button for longer than five seconds. The SIRIUS 3RW40 soft starter is tripped by the fault signal at the OVERLOAD LED, the FAILURE / OVERLOAD contact 95-98 closes, and the motor that is connected and running is switched off.



RESET / TEST button on the 3RW40 2, 3RW40 3, and 3RW40 4

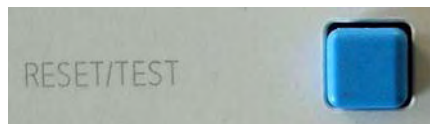

RESET / TEST button on the 3RW40 5 and 3RW40 7

5.4.3.2 Reparameterizing the ON / RUN output contact

For information about reparameterizing the output with the RESET / TEST button, refer to chapter Parameterizing the 3RW40 outputs [Page 110].

5.5 Functions of the inputs

5.5.1 Start input (terminal 1) on 3RW30 and 3RW40 2 to 3RW40 4

Rated control voltage is present at terminal A1 / A2: The startup process of the soft starter begins when a signal is present at terminal 1 (IN). The starter operates until the signal is removed again.

If a ramp-down time is parameterized (3RW40 only), a soft stop starts as soon as the signal is removed.

The potential of the signal at terminal 1 must correspond to the potential of the rated control voltage at terminal A1 / A2.



For recommended circuits, e.g. control by means of pushbuttons, contactor contacts, or a PLC, refer to chapter Typical circuit diagrams [Page 167].

5.5.2 Start input (terminal 3) on 3RW40 5 and 3RW40 7

Rated control voltage is present at terminal A1 / A2: The startup process of the soft starter begins when a signal is present at terminal 3 (IN). The starter operates until the signal is removed again. If a ramp-down time is parameterized, a soft stop starts as soon as the signal is removed.

The 24 V DC control voltage supplied by the soft starter must be taken from terminal 1 (+) as voltage for the signal at terminal 3.

If you select direct control by a PLC, the "M" of the PLC's reference potential must be connected to terminal 2 (-).

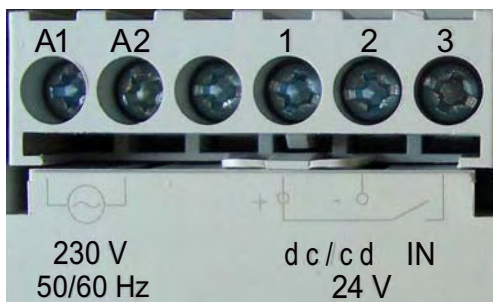

For recommended circuits, e.g. control by means of pushbuttons, contactor contacts, or a PLC, refer to chapter Typical circuit diagrams [Page 167].

5.5.3 Thermistor input / connection on 3RW40 2 to 3RW40 4

24 V AC/DC rated control voltage

After removing the copper jumper between T11/T21 and T22, you can connect and evaluate either a Klixon thermistor integrated in the motor winding (at terminal T11/T21-T22) or a type A PTC (at terminal T11/T21-T12).

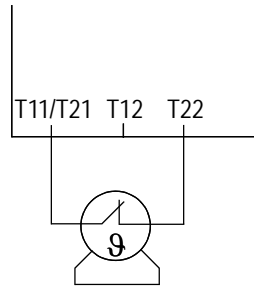

Klixon

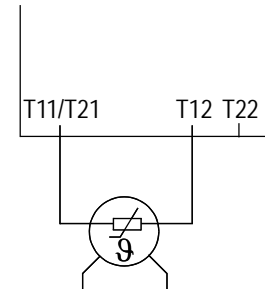

Type A PTC

5.6 Functions of the outputs

5.6.1 3RW30: Output terminal 13 / 14 ON

The potential-free output contact at terminal 13/14 (ON) closes if a signal is present at terminal 1 (IN); it remains closed until the start command is removed.

The output can be used, for instance, to control a line contactor connected upstream or to implement latching if you selected pushbutton control. For recommended circuits, refer to chapter Typical circuit diagrams [Page 167].

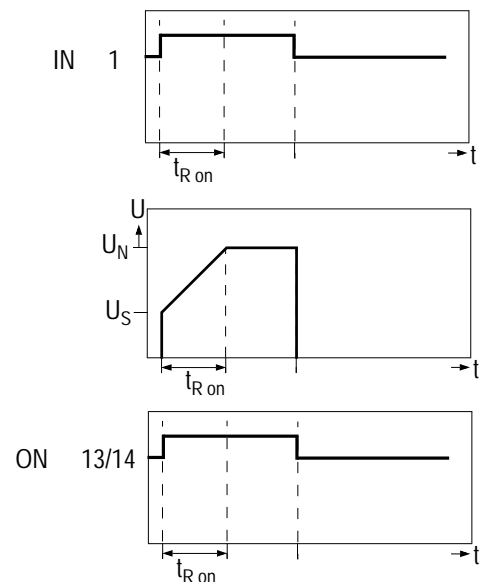

For a state diagram of the contact in the various operating states, refer to chapter Diagnostics and fault signals [Page 44].

5.6.2 3RW40: Output terminals 13 / 14 ON / RUN and 23 / 24 BYPASSED

ON

The potential-free output contact at terminal 13/14 (ON) closes if a signal is present at terminal 1 (IN); it remains closed until the start command is removed (factory default). The ON function can be used, for instance, as a latching contact if you selected pushbutton control.

Reparameterizing from ON to RUN

You can reparameterize the function of the ON output on the 3RW40 to RUN by simultaneously pressing the RESET TEST and RESET MODE buttons (refer to chapter Commissioning the 3RW40 [Page 98]).

RUN

The RUN output remains closed as long as the motor is controlled by the soft starter, in other words during the startup phase, in bypass mode, and during the soft stop (if set). This output function can be used, for instance, if a line contactor connected upstream must be controlled by the soft starter, especially if the soft stop function is set.

BYPASSED

The BYPASSED function can be used, for instance, to indicate that the motor has started up successfully.

The BYPASSED output at terminal 23 / 24 closes as soon as the SIRIUS 3RW40 soft starter detects that the motor has started up (refer to chapter Ramp-up detection [Page 104]).

The integral bypass contacts simultaneously close and the thyristors are bridged. The integral bypass contacts and output 23 / 24 open again as soon as the start input IN is removed.

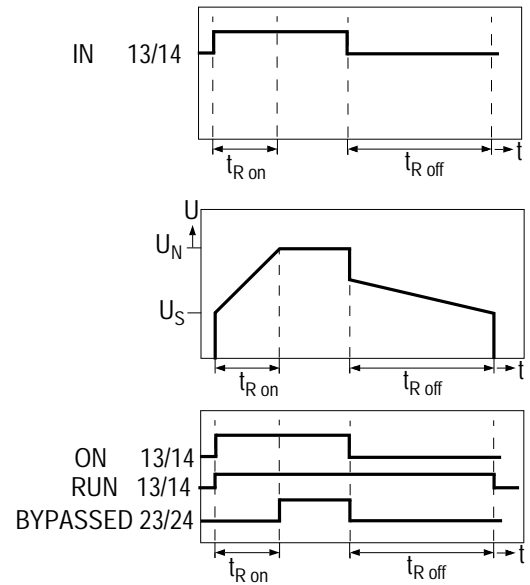

For a state diagram of the contacts and the LEDs in the various operating and fault states, refer to chapter Diagnostics and fault signals [Page 44].

For recommended circuits, refer to chapter Typical circuit diagrams [Page 167].

5.6.3 3RW40: Group fault output at terminal 95 / 96 / 98 OVERLOAD / FAILURE

If there is no rated control voltage or if a failure occurs, the potential-free FAILURE / OVERLOAD output is switched.



For recommended circuits, refer to chapter Typical circuit diagrams [Page 167].

For a state diagram of the contacts in the various fault and operating states, refer to chapter Diagnostics and fault signals [Page 44].

5.7 Diagnostics and fault signals

5.7.1 3RW30: LEDs and troubleshooting

		LEDs on 3RW30		Auxiliary contact
		Soft starter		
3RW30		DEVICE (rd/gn/ylw)	STATE/BYPASSED/ FAILURE (gn/rd)	13 14/ (ON)
$U_s = 0$				
Operating state	IN			
Off	0	gn		
Start	1	gn	gn	
Bypassed	1	gn	gn	
Fault				
Impermissible electronics supply voltage ¹⁾			rd	
Bypass overload ²⁾		ylw	rd	
- Missing load voltage ¹⁾ - Phase failure, missing load ¹⁾		gn	rd	
Device fault ³⁾		rd	rd	

LEDs					
			gn	rd	ylw
			=	=	=
Off	ON	Flashing	Green	Red	Yellow

1) The fault is automatically reset by an outgoing event. An automatic restart is initiated and the 3RW restarted if a start command is present at the input.

	WARNING
Automatic restart	
Danger of death, serious injury, or property damage.	
If you do not want the motor to start automatically, you must integrate suitable additional components, e.g. phase failure or load monitoring devices, into the control and main circuits.	

2) The fault can be acknowledged by removing the start command at the start input.

3) Switch off the control voltage, then switch it on again. If the fault is still present, contact your SIEMENS partner or Technical Assistance.

For notes on troubleshooting, refer to the table below.

Fault	Cause	Remedy
Impermissible electronics supply voltage	The control supply voltage does not correspond to the soft starter's rated voltage.	Check the control supply voltage; an incorrect control supply voltage could be caused by a power failure or a voltage dip.
Bypass overload	A current $> 3.5 \times I_e$ of the soft starter occurs for > 60 ms in bypass mode (e.g. because the motor is blocked).	Check the motor and load, and check the soft starter's dimensions.
Missing load voltage, phase failure / missing load	Cause 1: Phase L1 / L2 / L3 is missing or fails / collapses when the motor is operating. Tripped as a result of a dip in the permissible rated operational voltage $> 15\%$ for > 100 ms during the startup process or > 200 ms in bypass mode.	Connect L1 / L2 / L3 or correct the voltage dip.
	Cause 2: The motor that is connected is too small and the fault occurs as soon as it is switched to bypass mode.	If less than 10 % of the soft starter's rated current is flowing, the motor cannot be operated with soft starter. Use another soft starter.
	Cause 3: Motor phase T1 / T2 / T3 is not connected.	Connect the motor properly (e.g. jumpers in the motor terminal box, repair switch closed etc.)
Device fault	Soft starter defective.	Contact your SIEMENS partner or Technical Assistance.

5.7.2 3RW40: LEDs and troubleshooting

		LEDs on 3RW40				Auxiliary contacts						
		Soft starter		Motor protection		13 14 (ON)		13 14 (RUN)		24 23 (BYPASSED)		96 95 98 FAILURE / OVERLOAD
3RW40		DEVICE (rd/gn/ylw)	STATE / BYPASSED / FAILURE (gn/rd)	OVERLOAD (rd)	RESET MODE / AUTO (ylw/gn)							
$U_S = 0$		●	●	●	●							
Operating state	IN											
Off	0	gn	●	●	●							
Start	1	gn	gn	●	●							
Bypassed	1	gn	gn	●	●							
Stop	0	gn	gn	●	●							
Warning												
I_e / impermissible CLASS setting ²⁾		gn	gn / gn	rd	●							
Start inhibited, device too hot (cooling time may vary according to thyristor temperature) ³⁾		ylw	●	●	●							
Fault												
Impermissible electronics supply voltage ²⁾		●	rd	●	●							
Impermissible I_e / CLASS setting and IN (0 -> 1) ²⁾		gn	rd	rd	●							
Motor protection tripping, overload relay cooling time 60 s / thermistor cooling time may vary according to motor temperature ¹⁾		gn	●	rd	●							
Thermistor motor protection Wire breakage / short-circuit ^{1) 3)}		gn	●		●							
Thermal overload on device ³⁾ (cooling time > 30 s)		ylw	rd	●	●							
- Missing load voltage - Phase failure, missing load ³⁾		gn	rd	●	●							
Device fault (cannot be acknowledged, device defective) ⁵⁾		rd	rd	●	●							
Test function												
Press TEST $t > 5$ s ⁴⁾		gn	●	rd	●							
RESET MODE (press to change)												
Manual RESET		●	●	●	●							
Auto RESET		●	●	●	ylw							
Remote RESET		●	●	●	gn							
LEDs						1) Optional, 3RW40 2. to 3RW40 4. in 24 V AC/DC only						
				gn	ylw	rd	2) Automatically reset if the setting is corrected or when the system returns to normal					
Off	ON	Flashing	Flickering	Green	Yellow	Red	3) Must be acknowledged according to the selected RESET mode 4) Motor protection trip test					
							5) Device fault cannot be acknowledged. Contact your SIEMENS partner or Technical Assistance.					

 WARNING
<p>Automatic restart Can result in death, serious injury, or property damage.</p> <p>The automatic RESET mode (AUTO RESET) must not be used in applications where there is a risk of serious injury to persons or substantial damage to property if the motor starts up again unexpectedly. The start command (e.g. issued by a contact or the PLC) must be reset prior to issuing a RESET command because the motor attempts to restart again automatically following this RESET command if a start command is still present. This particularly applies if the motor protection has tripped. For safety reasons, you are advised to integrate the group fault output on the 3RW40 (terminals 95 and 96), or the signaling contact of the motor or miniature circuit breaker on all devices, in the controller.</p>

Notes on troubleshooting

Warning	Cause	Remedy
Impermissible I _e CLASS setting (control voltage present, no start command)	The rated operational current I _e set for the motor (control voltage present, no start command) exceeds the associated, maximum permissible setting current referred to the selected CLASS setting (chapter Motor current settings [Page 107]).	Check the rated operational current set for the motor, select a lower CLASS setting, or calculate the soft starter with a size allowance. As long as the 3RW40 is not controlled IN (0->1), this is only a status signal. However, it becomes a fault signal if the start command is applied.
Start inhibited, device too hot	The acknowledgment and the motor start are inhibited for a defined time by the inherent device protection following an overload trip, to allow the 3RW40 to cool down. Possible causes <ul style="list-style-type: none"> • Too many starts, • Motor ramp-up time too long, • Ambient temperature in switching device's environment too high, • Minimum installation clearances not complied with. 	The device cannot be started until the temperature of the thyristor or the heat sink has cooled down enough to guarantee sufficient reserve for a successful startup. The time until restarting is allowed can vary but is a minimum of 30 s. Rectify the causes and possibly retrofit the optional fan (3RW40 2. to 3RW40 4.).

Fault	Cause	Remedy
Impermissible electronics supply voltage:	The control supply voltage does not correspond to the soft starter's rated voltage.	Check the control supply voltage; could be caused by a power failure, voltage dip, or incorrect control supply voltage. Use a stabilized power supply unit if due to mains fluctuations.
Impermissible I_e /CLASS setting and IN (0->1) (control voltage present, IN start command changes from 0 to 1)	The rated operational current I_e set for the motor (control voltage present, start command present) exceeds the associated, maximum permissible setting current referred to the selected CLASS setting (chapter Motor current settings [Page 107]). For the maximum permissible settings, refer to chapter "Technical data [Page 121]".	Check the rated operational current set for the motor, select a lower CLASS setting, or calculate the soft starter with a size allowance.
Motor protection tripping Overload relay / thermistor:	The thermal motor model has tripped. After an overload trip, restarting is inhibited until the recovery time has elapsed. - Overload relay tripping time: 60 s - Thermistor tripping time: When the temperature sensor (thermistor) in the motor has cooled down.	<ul style="list-style-type: none"> - Check whether the motor's rated operational current I_e is set correctly, or - Change the CLASS setting, or - Possibly reduce the switching frequency, or - Deactivate the motor protection (CLASS OFF), or - Check the motor and the application.
Thermistor protection: wire breakage / short-circuit (optional for 3RW40 2. to 3RW40 4. devices):	Temperature sensor at terminals T11/ T12/T22 is short-circuited or defective, a cable is not connected, or no sensor is connected.	Check the temperature sensor and the wiring
Thermal overload on the device:	Overload trip of the thermal model for the power unit of the 3RW40 Possible causes <ul style="list-style-type: none"> • Too many starts, • Motor ramp-up time too long, • Ambient temperature in switching device's environment too high, • Minimum installation clearances not complied with. 	Wait until the device has cooled down again, possibly increase the current limiting value set for starting, or reduce the switching frequency (too many consecutive starts). Possibly retrofit the optional fan (3RW40 2. to 3RW40 4.). Check the load and the motor, check whether the ambient temperature in the soft starter's environment is too high (derating above 40 °C, refer to chapter Technical data [Page 121]), comply with the minimum clearances.

Fault	Cause	Remedy
Missing load voltage, phase failure / missing load:	Cause 1: Phase L1 / L2 / L3 is missing or fails / collapses when the motor is operating. Tripped as a result of a dip in the permissible rated operational voltage > 15 % for > 100 ms during the startup process or > 200 ms in bypass mode.	Connect L1 / L2 / L3 or correct the voltage dip.
	Cause 2: The motor that is connected is too small and the fault occurs as soon as it is switched to bypass mode.	Set the correct rated operational current for the connected motor or set it to the minimum value (if the motor current is less than 10 % of the set I_e , the motor cannot be operated with this starter).
	Cause 3: Motor phase T1 / T2 / T3 is not connected.	Connect the motor properly (e.g. jumpers in the motor terminal box, repair switch closed etc.)
Device fault	Soft starter defective.	Contact your SIEMENS partner or Technical Assistance.

Application planning

6.1 Application examples

6.1.1 Roller conveyor application

Using the 3RW30 with roller conveyors

Roller conveyors are employed, for example, in parcel distribution systems for transporting parcels to and from individual workstations. For this purpose, the direction of rotation of the 11 kW / 15 hp motor that is used has to be adjustable in order for the conveyor to work in both directions.

The following requirements must be met by the roller conveyor:

- The roller conveyor has to start smoothly, to prevent damage to the transported goods due to slipping or tilting.
- The machine's wear and maintenance intervals should be minimized, which is why slippage of the belt drive during startup must be prevented.
- The high current load upon motor startup must be reduced by means of a voltage ramp.
- The feeder assembly should be as small as possible so as not to exceed the control cabinet's space capacity.

The SIRIUS 3RW30 soft starter offers the following advantages:

- The roller conveyor is rapidly accelerated to the nominal speed without torque surges thanks to the optimum setting of the voltage ramp during startup.
- The motor's starting current is reduced.
- Reversing operation of the conveyor belt is realized through contactor interconnection with SIRIUS 3RA13 reversing contactor combinations.
- The feeder and the motor protection are implemented with SIRIUS 3RV motor starter protectors.
- The use of SIRIUS system components guarantees maximum wiring reductions and space savings.

6.1.2 Hydraulic pump application

Using the 3RW40 with hydraulic pumps

The SIRIUS 3RW40 is optimally suited for soft starting and stopping of hydraulic pumps. With a rating of 200 kW / 250 hp, this soft starter is used, for example, in the production of sheet parts to drive the presses.

The drives for hydraulic pumps must meet the following requirements:

- The motor's starting current has to be reduced to minimize the load on the higher-level mains transformer during startup.
- Integrated motor protection is called for to reduce wiring expenditure and space requirements in the control box.
- The hydraulic pump must be started and stopped in a soft manner to minimize the mechanical load on the drive and the pump caused by torque surges during starting and stopping.

The SIRIUS 3RW40 soft starter offers the following advantages:

- The settable current limiting of the SIRIUS 3RW40 limits the load on the mains transformer during the motor startup.
- Motor protection is ensured by the motor overload relay with settable tripping times integrated in the soft starter.
- The adjustable voltage ramp ensures that the hydraulic pump is started and stopped without torque surges.

Installation

7.1 Installing the soft starter

7.1.1 Unpacking

CAUTION

Do not lift the device by the cover in order to unpack it, especially sizes 3RW40 55 to 3RW40 76, because this could lead to damage.

7.1.2 Permissible mounting position

3RW30
3RW40

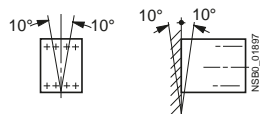

Vertical mounting

3RW40 2 to 3RW40 4 (with optional additional fan)
3RW40 5 to 3RW40 7

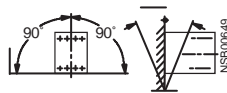

Horizontal mounting

NOTICE

The permissible switching frequency values can vary according to the selected mounting position. For information about factors and how to determine the new switching frequency, refer to chapter Configuration [Page 73].

Note

An optional fan can be ordered for the 3RW40 24 to 3RW40 47 sizes; this fan is integrated in the device for 3RW40 55 to 3RW40 76. The 3RW30 cannot be equipped with a fan.

7.1.3 Mounting dimensions, clearances, and assembly type

The minimum clearances from other devices must be complied with to ensure unobstructed cooling as well as the free supply and discharge of air to and from the heat sink.

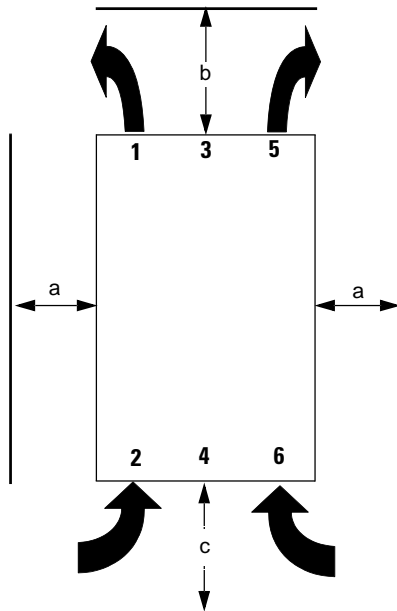

Figure 7-1 Clearances from other devices

MLFB	a (mm)	a (in)	b (mm)	b (in)	c (mm)	c (in)
3RW30 1./3RW30 2.	15	0.59	60	2.36	40	1.56
3RW30 3./3RW30 4	30	1.18	60	2.36	40	1.56
3RW40 2.	15	0.59	60	2.36	40	1.56
3RW40 3./3RW40 4.	30	1.18	60	2.36	40	1.56
3RW40 5./3RW40 7.	5	0.2	100	4	75	3

NOTICE

Allow sufficient clearances for the cooling air to circulate freely. The device is ventilated from bottom to top.

7.1.4 Assembly type: Standalone assembly, side-by-side assembly, direct mounting

Standalone assembly



The term "standalone assembly" is used if the clearances a / b / c described in chapter Mounting dimensions, clearances, and assembly type [Page 54] are complied with.

Side-by-side assembly



The term "side-by-side assembly" is used if the lateral clearance a described in chapter Mounting dimensions, clearances, and assembly type [Page 54] are not complied with, e.g. if several switching devices are assembled side by side.

Direct mounting



The term "direct mounting" is used if the top clearance *b* described in chapter Mounting dimensions, clearances, and assembly type [Page 54] is not complied with, e.g. if the soft starter is mounted directly on a motor starter protector (e.g. 3RV2) using a link module (e.g. 3RV29).

NOTICE

The permissible switching frequency values can vary according to the selected assembly type. For information about factors and how to determine the new switching frequency, refer to chapter Configuration [Page 73].

7.1.5 Installation requirements

Degree of protection IP00

The SIRIUS 3RW30 / 3RW40 soft starters conform to the IP00 degree of protection.

The devices must be installed in control cabinets with the IP54 degree of protection (pollution degree 2), taking account of the ambient conditions.

Make sure no liquids, dust, or conductive objects can get inside the soft starter. The soft starter produces waste heat (power loss) while it is operating (refer to chapter Technical data [Page 121]).

CAUTION

Provide adequate cooling at the place of installation to prevent the switching device from overheating.

Installation / mounting

8.1 General information

General information

A motor feeder comprises a **disconnecter**, a **contact**, and a **motor** as a minimum.

Line protection against short-circuits must be implemented, together with overload protection for the line and motor.

Disconnecter

The isolating function with line protection against overload and short-circuits can be achieved with a motor starter protector or a fuse disconnecter, for instance. The motor overload protection function is integrated in the SIRIUS 3RW40 soft starter. The motor overload protection for the SIRIUS 3RW30 soft starter can be implemented with a motor circuit breaker, for instance, or using a motor overload relay in conjunction with a contactor (for the fuse and motor starter protector assignment, refer to Technical data [Page 121]).

Contact

The contact function is taken care of by the SIRIUS 3RW30 or 3RW40 soft starter.

 DANGER
Hazardous voltage Danger of death or serious injury.
If mains voltage is present at the input terminals of the soft starter, hazardous voltage may still be present at the soft starter output even if a start command has not been issued. This voltage must be isolated by means of a disconnecter (open isolating distance, e.g. with an open switch disconnecter) whenever work is carried out on the feeder (refer to chapter Five safety rules for work in or on electrical systems [Page 58]).

Note

All elements of the main circuit (such as fuses, motor starter protectors, and switching devices) must be dimensioned for direct starting and according to the on-site short-circuit conditions, and ordered separately.

For recommended fuse and motor starter protector ratings for the feeder with soft starter, refer to chapter Technical data [Page 121].

8.2 Five safety rules for work in or on electrical systems

A set of rules, which are summarized in DIN VDE 0105 as the "five safety rules", are defined for work in or on electrical systems as a preventative measure against electrical accidents:

1. Isolate
2. Secure against switching on again
3. Verify that the equipment is not live
4. Ground and short-circuit
5. Erect barriers around or cover adjacent live parts

These five safety rules must be applied in the above order prior to starting work on an electrical system. After completing the work, proceed in the reverse order.

It is assumed that every electrician is familiar with these rules.

Explanations

1. The isolating distances between live and deenergized parts of the system must vary according to the operating voltage that is applied.
"Isolate" refers to the all-pole disconnection of live parts.
All-pole disconnection can be achieved, e.g. by:
 - Switching off the miniature circuit breaker
 - Switching off the motor circuit breaker
 - Unscrewing fusible links
 - Removing LV HRC fuses
2. The feeder must be secured against inadvertent restarting to ensure that it remains isolated for the duration of the work. This can be achieved, for instance, by securing the motor and miniature circuit breakers with lockable blocking elements in the disconnected state, either using a lock or by unscrewing the fuses.
3. The deenergized state of the equipment should be verified using suitable test equipment, e.g. a two-pole voltmeter. Single-pole test pins are not suitable for this purpose. The absence of power must be established for all poles, phase to phase, and phase to N/PE.
4. Grounding and short-circuiting are only mandatory if the system has a nominal voltage greater than 1 kV. In this case, the system should always be grounded first and then connected to the live parts to be short-circuited.
5. These parts should be covered, or barriers erected around them, to avoid accidental contact during the work with adjacent parts that are still live.

8.3 General feeder assembly (type of coordination 1)

The SIRIUS 3RW30 or 3RW40 soft starter is connected into the motor feeder between the motor starter protector and the motor.

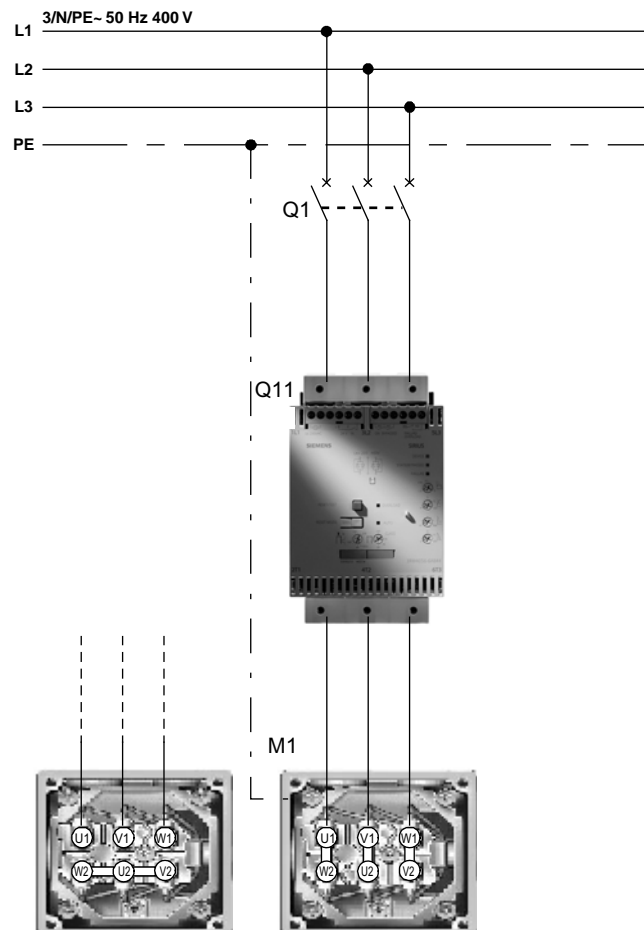

Figure 8-1 Block diagram of the SIRIUS 3RW40 soft starter

Note

For the component design, refer to chapter Technical data [Page 121].

8.4 Soft starter with line contactor (type of coordination 1)

If electrical isolation is specified, you can install a motor contactor between the soft starter and the motor starter protector.

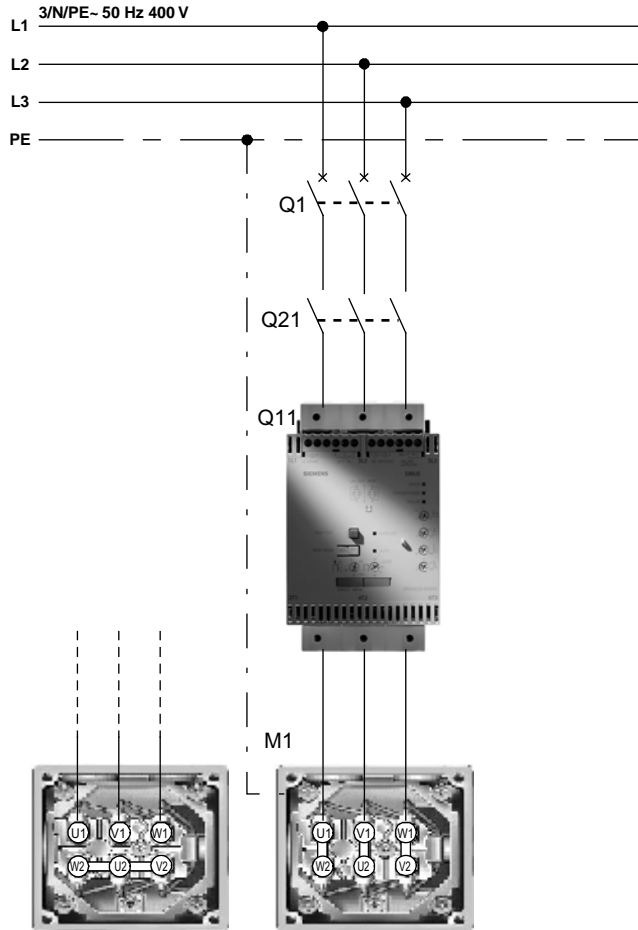

Figure 8-2 Block diagram of a feeder with an optional main / line contactor

Note

For the component design, refer to chapter Technical data [Page 121].

NOTICE

If a main or line contactor is used, it should not be connected between the soft starter and the motor. The soft starter could otherwise indicate a "Missing load voltage" fault in case of a start command and delayed connection of the contactor.

8.5 Soft starter assembly with type of coordination 2

The SIRIUS 3RW40 soft starter has internal protection to prevent overloading of the thyristors. The SIRIUS 3RW30 soft starter has no internal protection to prevent overloading of the thyristors. The soft starter must always be dimensioned according to the duration of the startup process and the desired starting frequency. If the feeder of the SIRIUS 3RW30 or 3RW40 soft starter is assembled accordingly with the feeder components recommended in chapter Technical data [Page 121] (e.g. motor starter protector or LV HRC fuse), type of coordination 1 is achieved. In order to achieve type of coordination 2, all thyristors must be additionally protected against short-circuits by means of special semiconductor fuses (e.g. SIEMENS SITOR). A short-circuit can occur, for instance, as a result of a defect in the motor windings or in the motor's power supply cable.

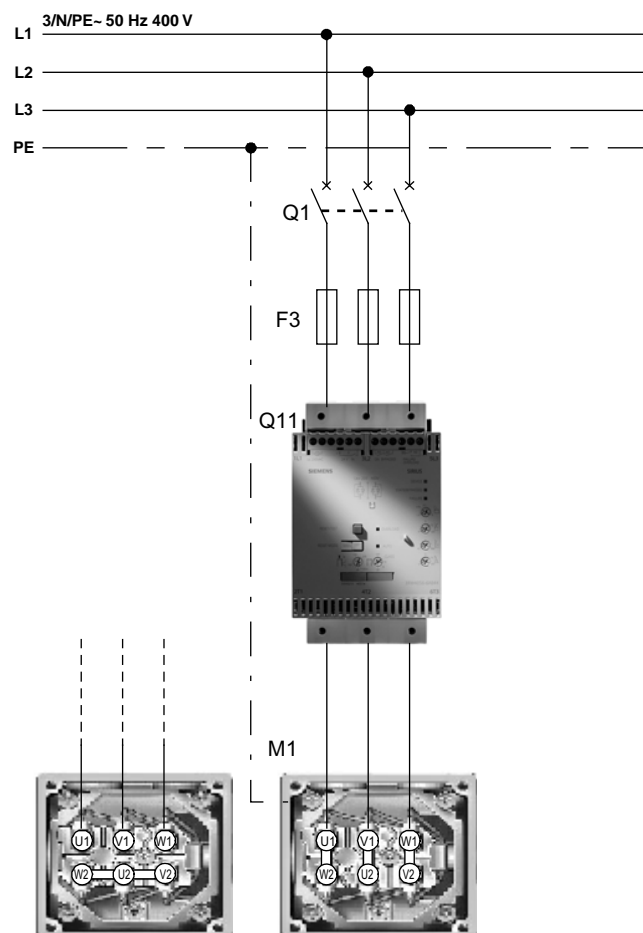

Figure 8-3 Block diagram of a feeder with semiconductor fuses

Note

For the component design, refer to chapter Technical data [Page 121].

Note

Minimum and maximum configuration of the semiconductor fuses

The fuses for the minimum and maximum configuration are specified in chapter Technical data [Page 121].

Minimum configuration: The fuse is optimized for the thyristor's I^2t value.

If the thyristor is cold (ambient temperature) and the startup process lasts a maximum of 20 s at 3.5 times the rated current of the device, the fuse does not trip.

Maximum configuration: The maximum current permitted for the thyristor can flow without the fuse tripping.

The maximum configuration is recommended for heavy-duty starting.

CAUTION

Risk of property damage

Type of coordination 1 in accordance with IEC 60947-4-1:

The device is defective following a short-circuit failure and therefore unsuitable for further use (personnel and equipment must not be put at risk).

Type of coordination 2 in accordance with IEC 60947-4-1:

The device is suitable for further use following a short-circuit failure (personnel and equipment must not be put at risk).

The type of coordination only refers to soft starters in conjunction with the stipulated protective device (motor starter protector / fuse), not to additional components in the feeder.

8.6 Capacitors to improve the power factor

 **CAUTION**

No capacitors must be connected to the output terminals of the soft starter. If so, the soft starter will be damaged.

Active filters, e.g. for power factor correction, must not be operated parallel to the motor control device.

If capacitors are to be used to correct the power factor, they must be connected on the device's line side. If an isolating or main contactor is used together with the electronic soft starter, the capacitors must be disconnected from the soft starter when the contactor is open.

8.7 Maximum cable length

The cable between the soft starter and the motor must not be more than 300 m long (3RW30 and 3RW40).

The voltage drop due to the length of the cable to the motor may need to be considered when dimensioning the cable.

Cable lengths up to 500 m are permitted for SIRIUS 3RW44 soft starters (refer to the 3RW44 System Manual (<http://support.automation.siemens.com/WW/llisapi.dll?query=3RW44&func=cslib.cssearch&content=skm%2Fmain.asp&lang=de&siteid=csius&objaction=cssearch&searchinprim=0&nodeid0=20025979>)).

Connecting

9.1 Electrical connection

9.1.1 Control and auxiliary terminals

The SIRIUS 3RW30 and 3RW40 soft starters can be supplied with two different connection technologies:

- Screw-type technology
- Spring-loaded technology

9.1.2 Main circuit connection

SIRIUS 3RW30 and 3RW40 soft starters up to the 55 kW / 75 hp size at 400 V / 480 V are designed with removable terminals at the main circuit connections.

Sizes 3RW30 1. to 3RW30 4.

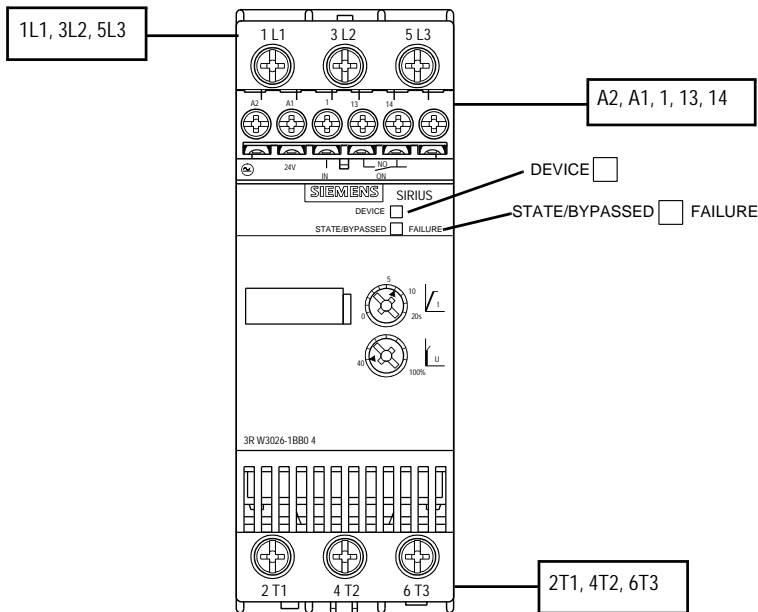

Sizes 3RW40 2. to 3RW40 4.

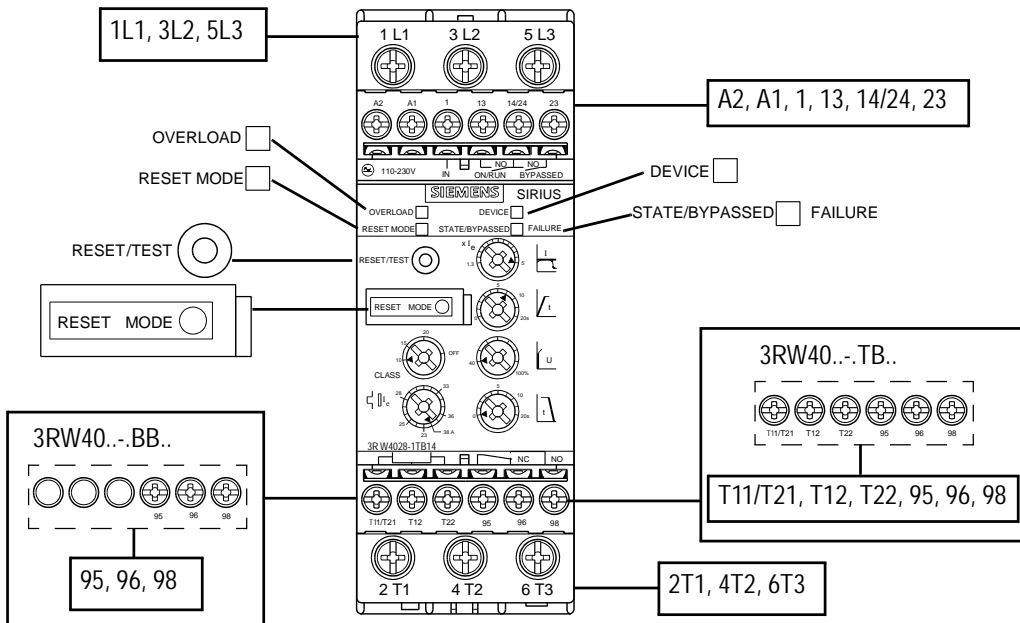

Sizes 3RW40 5. and 3RW40 7.

Sizes 3RW40 5. and 3RW40 7. have busbar connections for the main circuit connection.

Box terminals can be retrofitted on these devices as optional accessories (refer to chapter Accessories [Page 199]).

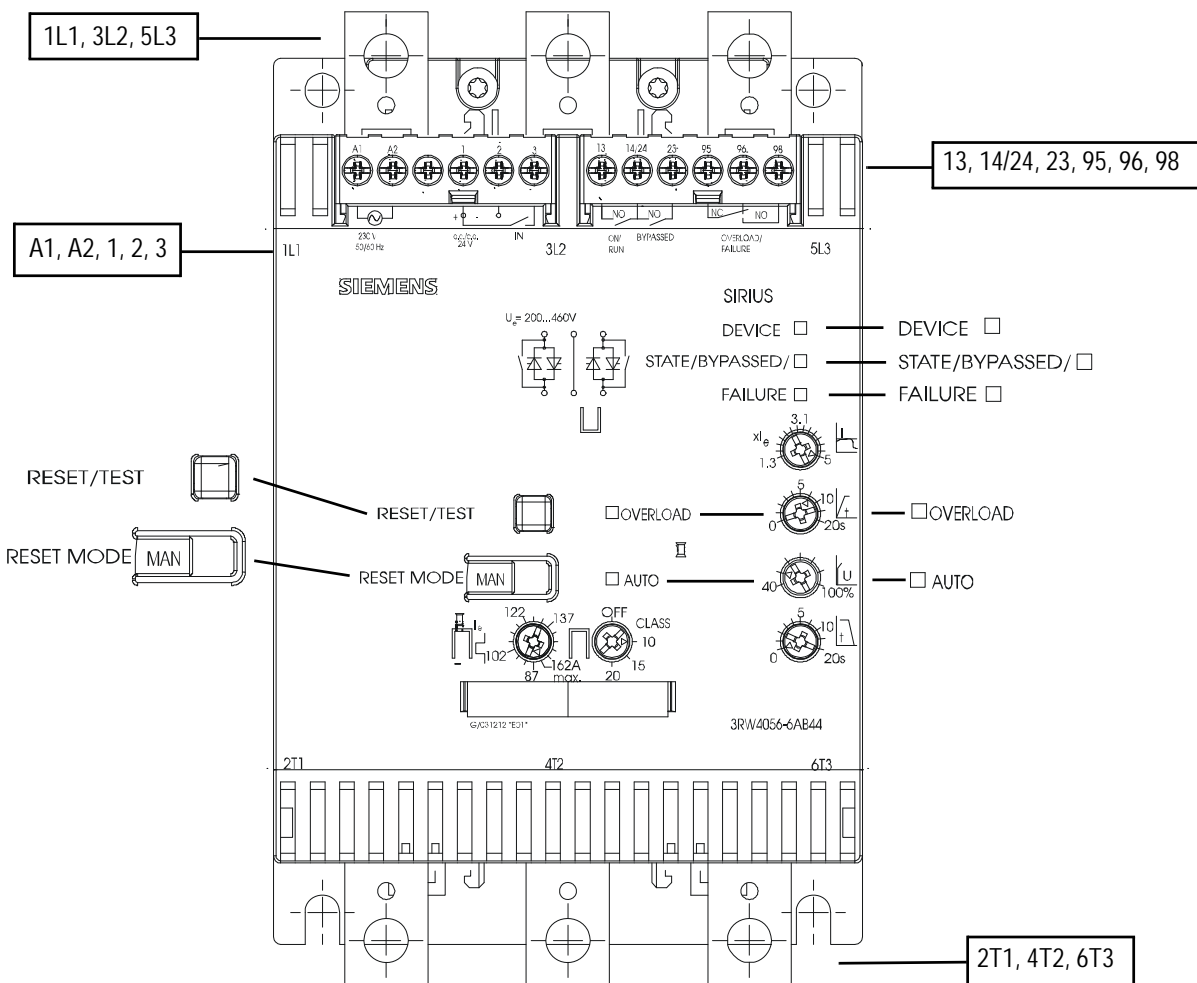

Operation

10.1 Operator controls, displays, and connections on the 3RW30

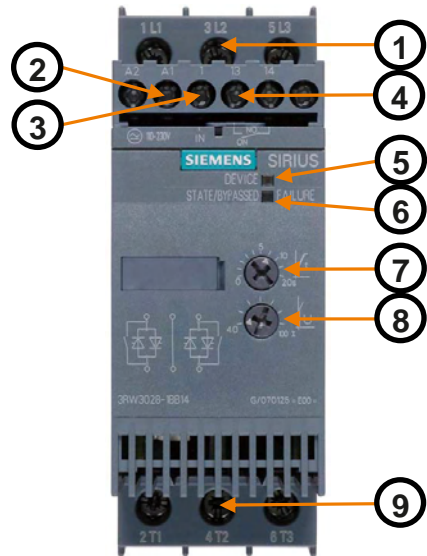

- 1 Operating voltage (three-phase mains voltage)
- 2 Control supply voltage
- 3 IN start input
- 4 ON output
- 5 DEVICE status LED
- 6 STATE / BYPASSED / FAILURE status LED
- 7 Ramp-up time
- 8 Starting voltage
- 9 Motor terminals

10.2 Operator controls, displays, and connections on the 3RW40

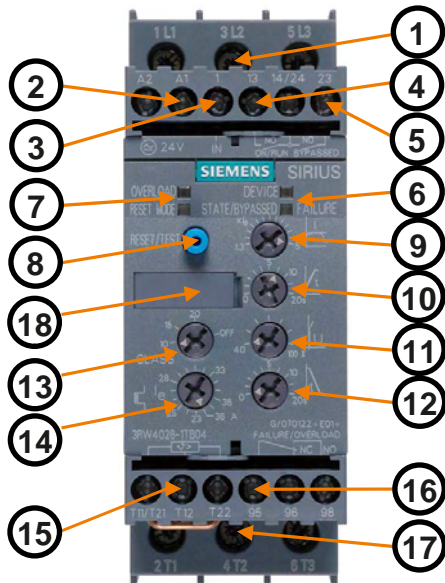

- 1 Operating voltage (three-phase mains voltage)
- 2 Control supply voltage
- 3 IN start input
- 4 ON / RUN output
- 5 BYPASSED output
- 6 DEVICE / STATE / BYPASSED / FAILURE status LEDs
- 7 OVERLOAD, RESET MODE status LEDs
- 8 TEST / RESET button
- 9 Current limiting
- 10 Ramp-up time
- 11 Starting voltage
- 12 Ramp-down time
- 13 Trip class
- 14 Motor current
- 15 Thermistor input (can be optionally ordered with 24 V AC/DC control voltage for 3RW40 2. to 3RW40 4. devices)
- 16 Fault output
- 17 Motor terminals
- 18 RESET MODE button (behind the label on the 3RW40 2., refer to the diagram below)

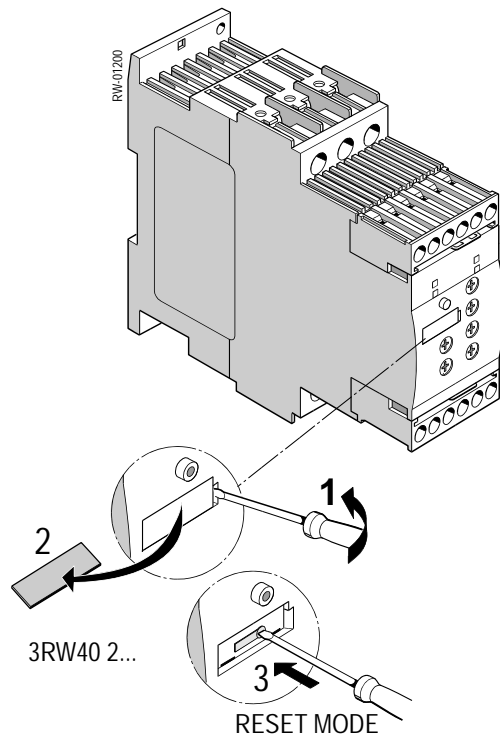

Figure 10-1 Button for setting RESET MODE behind the label

Configuration

11.1 Configuration in general

The SIRIUS 3RW30 and 3RW40 electronic soft starters are designed for normal starting. A larger size may need to be selected for longer ramp-up times or a higher starting frequency.

An appropriately dimensioned SIRIUS 3RW40 or 3RW44 soft starter should be chosen for startup processes with motor ramp-up times > 20 s.

The motor feeder between the soft starter and motor must not contain any capacitive elements (such as compensation systems). Active filters must not be operated in combination with soft starters.

All elements of the main circuit (such as fuses and switching devices) must be dimensioned for direct starting and according to the on-site short-circuit conditions, and ordered separately.

The harmonic component load of the starting current must be taken into consideration when selecting motor starter protectors (trip selection).

Note

Voltage dips generally occur in all start modes (direct starting, wye-delta starting, soft starting) when a three-phase motor is switched on. The infeed transformer must always be dimensioned so that the voltage dip at the motor startup remains within the permissible tolerance. If the infeed transformer is insufficiently dimensioned, the control voltage should be supplied from a separate circuit (independently of the main voltage) in order to prevent the voltage dip from disconnecting the 3RW.

Note

All elements of the main circuit (such as fuses, motor starter protectors, and switching devices) must be dimensioned for direct starting and according to the on-site short-circuit conditions, and ordered separately.

If wye-delta starters are exchanged for soft starters in an existing system, you should check the fuse ratings in the feeder in order to avoid false tripping. This is particularly important in connection with heavy-duty starting or if the fuse that is installed has already been operated close to the thermal tripping limit with the wye-delta assembly.

For recommended fuse and motor starter protector ratings for the feeder with soft starter, refer to chapter Technical data [Page 121].

11.1.1 Configuration procedure

1. Select the correct starter

What application must be started and what functionality must be provided by the soft starter?

Chapter Selecting the optimum soft starter [Page 74]

2. Take account of the startup class and the switching frequency

Chapters Startup class [Page 76] and Calculating the permissible switching frequency [Page 81]

3. Take account of a possible reduction in the soft starter's rated data due to the ambient conditions and the type of assembly.

Chapter Reducing the rated data [Page 80]

11.1.2 Selecting the optimum soft starter

Selection aid

You can choose the optimum starter from the soft starter types available based on the intended application or the required functionality.

Normal starting (CLASS 10) applications	3RW30	3RW40	3RW44
Pump	+	+	+
Pump with special stop (against water hammer)	-	-	+
Heat pump	+	+	+
Hydraulic pump	x	+	+
Press	x	+	+
Conveyor belt	x	+	+
Roller conveyor	x	+	+
Conveyor worm	x	+	+
Escalator	-	+	+
Piston compressor	-	+	+
Screw compressor	-	+	+
Small fan ¹⁾	-	+	+
Centrifugal blower	-	+	+
Bow thruster	-	+	+

+ Recommended soft starter

x Possible soft starter

1) Small fan: Mass inertia (centrifugal mass) of fan < 10 x mass inertia of motor

Heavy-duty starting (CLASS 20) applications	3RW30	3RW40	3RW44
Agitator	-	x	+
Extruder	-	x	+
Turning machine	-	x	+
Milling machine	-	x	+

+ Recommended soft starter

x Possible soft starter

Ultra-heavy-duty starting (CLASS 30) applications	3RW30	3RW40	3RW44
Large fan ²⁾	-	-	+
Circular saw / band saw	-	-	+
Centrifuge	-	-	+
Mill	-	-	+
Crusher	-	-	+

+ Recommended soft starter

2) Large fan: Mass inertia (centrifugal mass) of fan $\geq 10 \times$ mass inertia of motor

Soft starter functions	3RW30	3RW40	3RW44
Soft start function	+	+	+
Soft stop function	-	+	+
Integrated intrinsic device protection	-	+	+
Integrated electronic motor overload protection	-	+	+
Settable current limiting	-	+	+
Special pump stop function	-	-	+
Braking in ramp-down	-	-	+
Settable breakaway torque	-	-	+
Communication via PROFIBUS (optional)	-	-	+
External operation and indication display (optional)	-	-	+
Soft Starter ES parameterization software	-	-	+
Special functions, e.g. measured values, display languages etc.	-	-	+
Motor overload protection acc. to ATEX	-	+	-

+ Recommended soft starter

Note

SIRIUS 3RW44 soft starter

For more information about the SIRIUS soft starter, refer to the 3RW44 System Manual. You can download (<http://support.automation.siemens.com/WW/llisapi.dll?func=cslib.csinfo&lang=de&objID=20356385&subtype=133300>) the manual free of charge.

11.2 Startup class

To achieve the optimum soft starter design, it is important to know and take into account the ramp-up time (startup class) of the application. Long ramp-up times mean a higher thermal load on the thyristors of the soft starter. An appropriately dimensioned SIRIUS 3RW40 or 3RW44 soft starter should be chosen for startup processes with a motor ramp-up time > 20 s. The maximum permissible ramp-up time for SIRIUS 3RW30 soft starters is 20 seconds. SIRIUS soft starters are designed for continuous operation with normal starting (CLASS 10), an ambient temperature of 40 °C, and a defined switching frequency (refer to chapter Technical data [Page 121]). If other data applies, the starters may need to be calculated with a size allowance. Using the SIEMENS Win-Soft Starter selection and simulation software, you can enter your application data and requirements to obtain an optimally dimensioned soft starter (refer to chapter Win-Soft Starter selection and simulation software [Page 162]).

CAUTION
Risk of property damage
When using the 3RW30: Make sure the selected ramp time is longer than the actual motor ramp-up time. If not, the SIRIUS 3RW30 may be damaged because the internal bypass contacts close when the set ramp time elapses. If the motor has not finished starting up, an AC3 current that could damage the bypass contact system will flow.
When using the 3RW40: The 3RW40 has an integrated ramp-up detection function that prevents this operating state from occurring.

Selection criteria

Note

You must select the size of your SIRIUS soft starters according to the rated motor current (rated current_{soft starter} >= rated motor current).

11.2.1 Application examples for normal starting (CLASS 10) with 3RW30 and 3RW40

Recommended basic parameter settings

Assuming the conditions and constraints indicated below apply, the size of the soft starters can be equivalent to the motor rating for a normal starting characteristic (CLASS 10).

You can find a suitable soft starter for the required motor rating based on the required startup class in chapter Technical data [Page 121].

For typical applications where normal starting applies as well as recommended parameter settings for the soft starter, refer to the table below.

Normal starting (CLASS 10)

The soft starter rating can be equivalent to the motor rating.

Application	Conveyor belt	Roller conveyor	Compressor	Small fan ¹⁾	Pump	Heat / hydraulic pump
Start parameters						
• Voltage ramp and current limiting						
- Starting voltage	% 70	60	50	40	40	40
- Ramp-up time	s 10	10	10	10	10	10
- Current limiting value (3RW40)	Off (5 x I _M)	Off (5 x I _M)	4 x I _M	4 x I _M	4 x I _M	4 x I _M
Stop mode	Soft stop (3RW40 only)	Soft stop (3RW40 only)	Stop without load	Stop without load	Soft stop (3RW40 only)	Stop without load

1) Small fan: Mass inertia (centrifugal mass) of fan < 10 x mass inertia of motor

General conditions and constraints	
CLASS 10 (normal starting)	
3RW30: Maximum ramp-up time 3 s, 300 % starting current, 20 starts / hour	
3RW40: Maximum ramp-up time 10 s, 300 % current limiting, 5 starts / hour	
ON time	30 %
Standalone assembly	
Installation altitude	Max. 1000 m / 3280 ft
Ambient temperature kW	40 °C / 104 °F

11.2.2 Application examples for heavy-duty starting (CLASS 20): 3RW40 only

Recommended basic parameter settings

Assuming the conditions and constraints indicated below apply, the soft starter size must be at least one power class higher than the motor rating for heavy-duty starting (CLASS 20).

You can find a suitable soft starter for the required motor rating based on the required startup class in chapter Technical data [Page 121].

For typical applications where heavy-duty starting can apply as well as recommended parameter settings for the soft starter, refer to the table below.

Heavy-duty starting (CLASS 20)

The soft starter must be at least one power class larger than the motor rating.

Application	Agitator	Extruder	Milling machine
Start parameters			
• Voltage ramp and current limiting			
- Starting voltage	% 40	70	40
- Ramp-up time	s 20	10	20
- Current limiting value (3RW40)	$4 \times I_M$	Off ($5 \times I_M$)	$4 \times I_M$
Stop mode	Stop without load	Stop without load	Stop without load

General conditions and constraints	
CLASS 20 (heavy-duty starting)	
3RW40 2. / 3RW40 3. / 3RW40 4.	Maximum ramp-up time 20 s, 300 % current limiting, max. 5 starts / hour
3RW40 5. / 3RW40 7.	Maximum ramp-up time 40 s, 350 % current limiting, max. 1 start / hour
ON time	30 %
Standalone assembly	
Installation altitude	Max. 1000 m / 3280 ft
Ambient temperature kW	40 °C / 104 °F

Note

The settings and device dimensions indicated in these tables are examples only; they are merely provided for information purposes and are not binding. The actual settings depend on the application and must be optimized when the equipment is commissioned.

If other conditions and constraints apply, either refer to chapter Technical data [Page 121] or check your requirements and selection with the Win-Soft Starter software or with Technical Assistance (chapter Important notes [Page 11])

11.3 ON time and switching frequency

Based on the rated motor current and the startup class, the SIRIUS 3RW30 and 3RW40 soft starters are dimensioned for a maximum permissible switching frequency in combination with a relative ON time (refer to chapter Technical data [Page 121]). If these values are exceeded, a larger soft starter may have to be selected.

ON time

The relative ON time in % is the ratio between the load duration and the cycle duration for loads that are frequently switched on and off.

The ON time (OT) can be calculated using the following formula:

$$OT = \frac{t_s + t_b}{t_s + t_b + t_p}$$

where:

OT = ON time [%]

t_s = ramp-up time [s]

t_b = operating time [s]

t_p = idle time [s]

The following diagram illustrates this process.

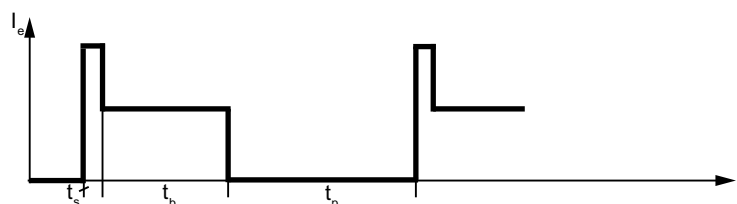

Figure 11-1 ON time

Switching frequency

The maximum permissible switching frequency must not be exceeded because the devices could be damaged due to thermal overloading.

Optional additional fan

The switching frequency of the 3RW40 2. to 3RW40 4. soft starters can be increased by installing an optional additional fan. For information about factors and how to determine the maximum switching frequency if an additional fan is installed, refer to chapter Calculating the permissible switching frequency [Page 81].

11.4 Reducing the rated data

You can reduce the rated data of the SIRIUS 3RW30 and 3RW40 soft starters if

- The installation altitude is higher than 1000 m.
- The ambient temperature in the switching device's environment exceeds 40 °C.
- The lateral clearances described earlier are not complied with, e.g. side-by-side assembly or direct mounting of other switching devices (assembly type).
- The vertical mounting position is not complied with.

11.5 Installation altitude and ambient temperature

Installation altitude

The permissible installation altitude must not be higher than 5000 m above sea level (higher than 5000 m on request).

If the installation altitude exceeds 1000 m, the rated operational current must be reduced for thermal reasons.

If the installation altitude exceeds 2000 m, the rated voltage must also be reduced owing to the restricted dielectric strength. A maximum permissible rated voltage of 460 V applies at installation altitudes between 2000 m and 5000 m above sea level.

The following diagram shows the reduction in the rated device current as a function of the installation altitude:

The rated operational current I_e must be reduced at altitudes higher than 1000 m above sea level.

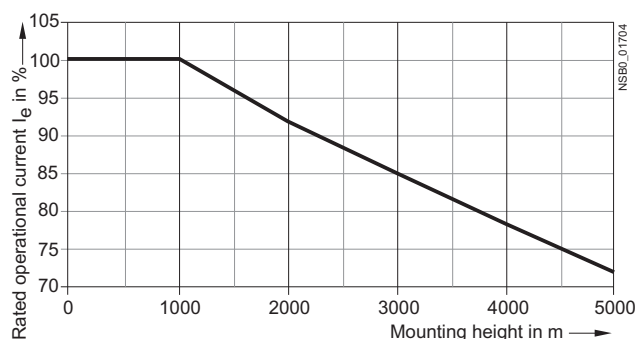

Figure 11-2 Reduction as a function of the installation altitude

Ambient temperature

The maximum permissible ambient temperature of the soft starter must not exceed 60 °C.

SIRIUS 3RW30 and 3RW40 soft starters are designed for operation with nominal current at an ambient temperature of 40 °C. If this temperature is exceeded, e.g. owing to an impermissible temperature rise in the control cabinet, other loads, or a general increase in the ambient temperature, the resulting deterioration in the soft starter's performance must be

taken into account when the device is dimensioned (refer to chapter Technical data [Page 121]).

CAUTION
Risk of property damage.
The soft starter may be damaged if the maximum installation altitude (5000 m above sea level) or an ambient temperature of 60 °C is ignored.

Mounting position, assembly type

The mounting position and assembly type (refer to chapter Installing the soft starter [Page 53]) can influence the soft starter's permissible switching frequency. Refer to chapter Calculating the permissible switching frequency [Page 81] for the permissible mounting and assembly combinations as well as the resulting factors for the soft starter switching frequencies.

11.6 Calculating the permissible switching frequency

11.6.1 Table of permissible assembly combinations with switching frequency factors

The factors indicated in the table refer to the switching frequency (starts / hour) as specified in chapter Technical data [Page 121].

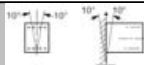
		 Vertical mounting							
Graph	Assembly type	3RW30			3RW40		3RW40 + optional fan		
		3RW301*	3RW302*	3RW303*3RW304*	3RW402*	3RW403*3RW404*	3RW402*	3RW403*3RW404*	
A	Standalone assembly	1.0			1.0		1.6	2.0	2.8
B	Side-by-side assembly	0.7	0.1	0.3	0.1	0.3	1.6	2.0	2.8
C	Standalone assembly	0.5			0.5		1.8		
D	Side-by-side assembly	0.3	-		-		1.7		

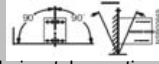
		 Horizontal mounting			
Graph	Assembly type	3RW30/40	3RW40 + optional fan		
			3RW402*	3RW403*	3RW404*
A	Standalone assembly	-	1.6	2.0	2.8
B	Side-by-side assembly	-	1.6	2.0	2.8
C	Standalone assembly	-	1.6		
D	Side-by-side assembly	-	1.4		

Standard switching frequency
High switching frequency (fan required)
Reduced switching frequency
Assembly type not permitted
Assembly type not tested

11.6 Calculating the permissible switching frequency

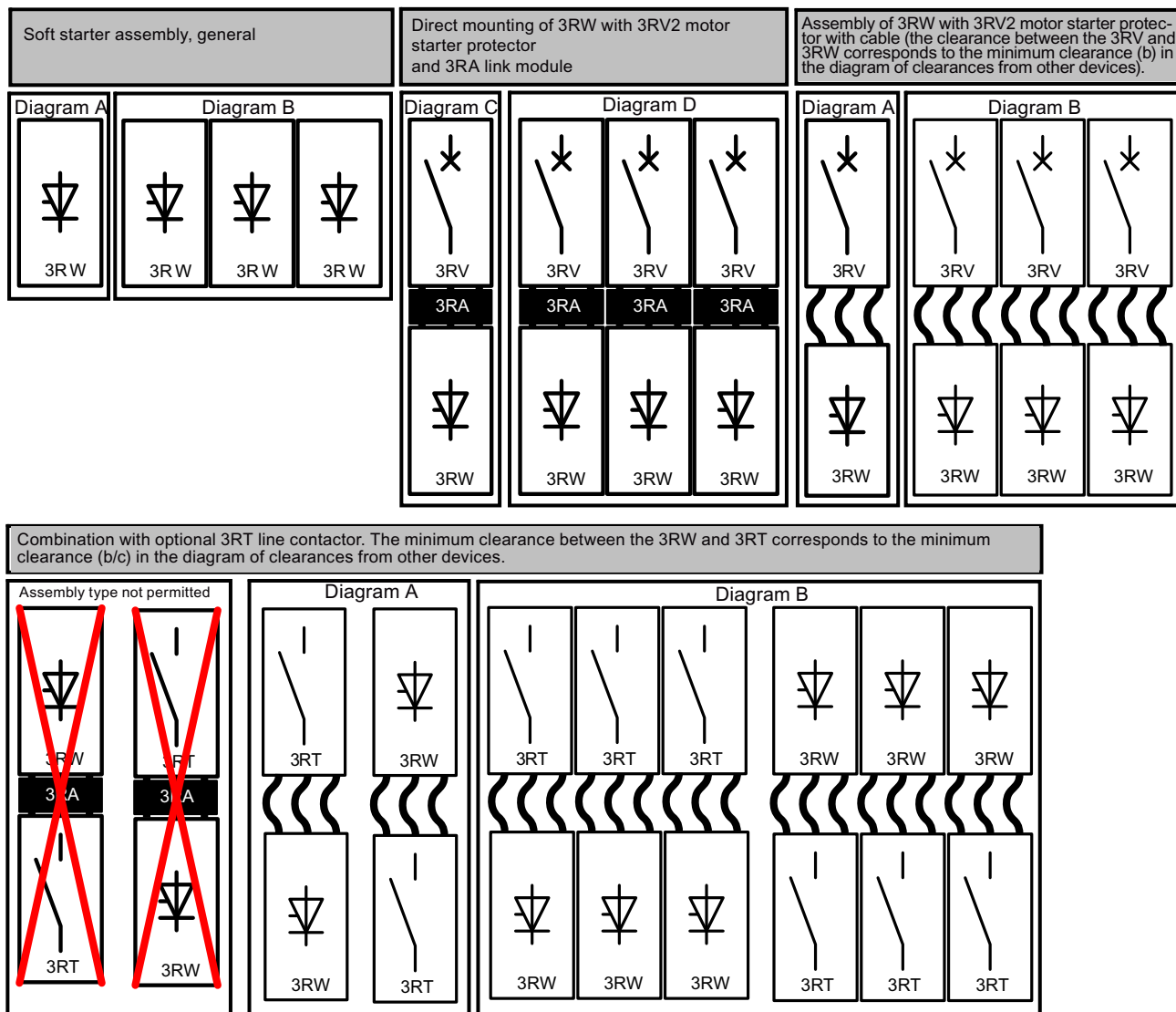

11.6 Calculating the permissible switching frequency

Assembly of 3RW with 3RV2 motor starter protector, 3RA link module, cable, and 3RT line contactor. The minimum clearance between the 3RW, 3RV, and 3RT corresponds to the minimum clearance (b/c) in the diagram of clearances from other devices.

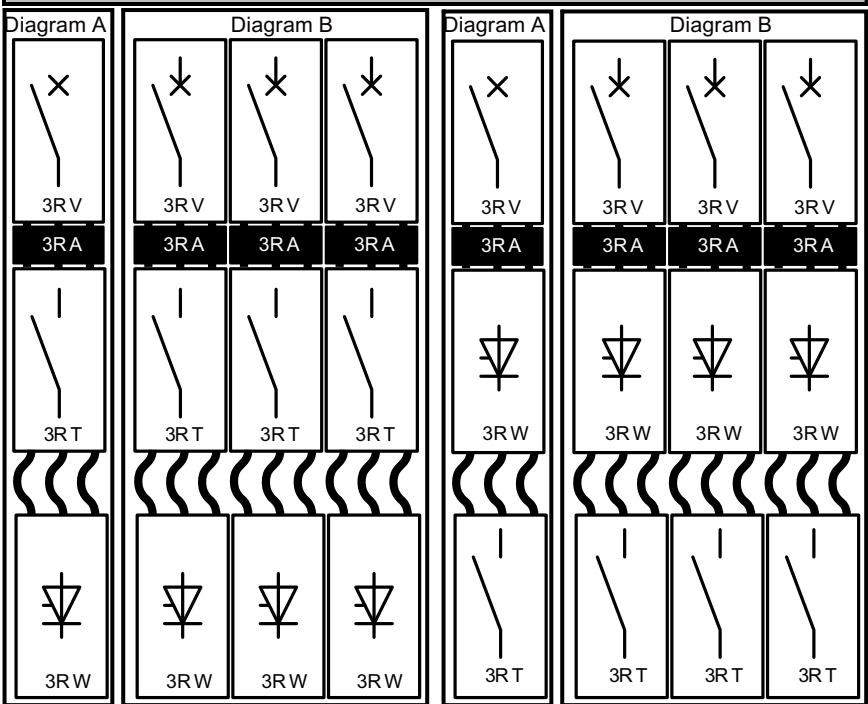

Assembly of 3RW with 3RV2 motor starter protector and 3RT line contactor with cable. The minimum clearance between the 3RV and 3RT corresponds to the minimum clearance (b/c) in the diagram of clearances from other devices.

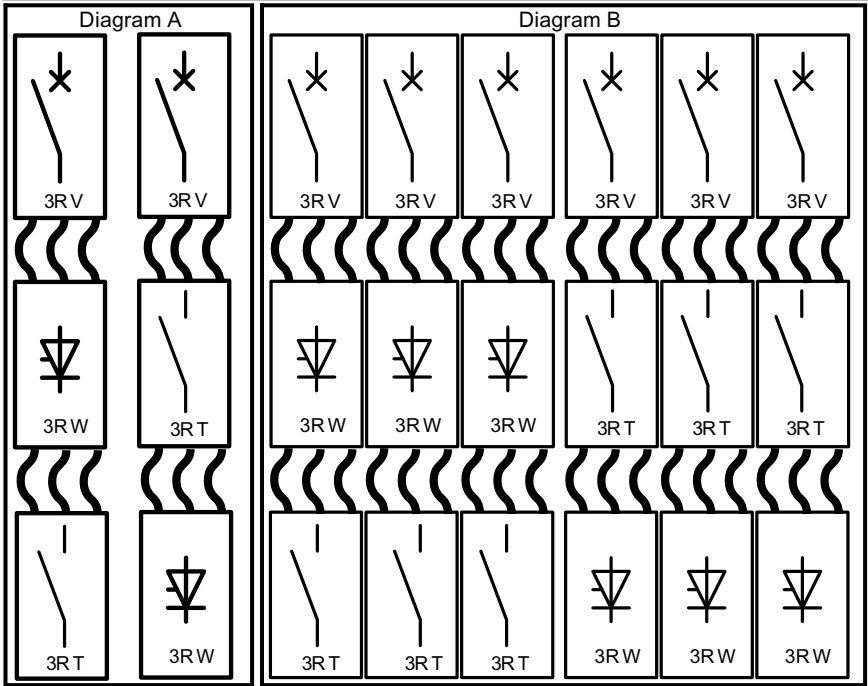

11.6 Calculating the permissible switching frequency

Figure 11-3 Clearances from other devices

MLFB	a (mm)	a (in)	b (mm)	b (in)	c (mm)	c (in)
3RW30 1./3RW30 2.	15	0.59	60	2.36	40	1.56
3RW30 3./3RW30 4.	30	1.18	60	2.36	40	1.56
3RW40 2.	15	0.59	60	2.36	40	1.56
3RW40 3./3RW40 4.	30	1.18	60	2.36	40	1.56
3RW40 5./3RW40 7.	5	0.2	100	4	75	3

11.6.2 Calculating the switching frequency (example)

Problem

The maximum permissible switching frequency of a 5.5 kW (12.5 A) 3RW4024 soft starter must be determined. The requirements are side-by-side assembly and vertical mounting. A ramp-up time of approx. 3 s at an ambient temperature of 40 °C is specified as a supplementary condition (e.g. a pump motor with CLASS 10 starting). The soft starter must be connected to a 3RV2021 motor starter protector by means of cables. (Clearance between 3RV and 3RW >= 40 mm)

Calculating the number of starts / hour of a 3RW40 for side-by-side assembly and vertical mounting

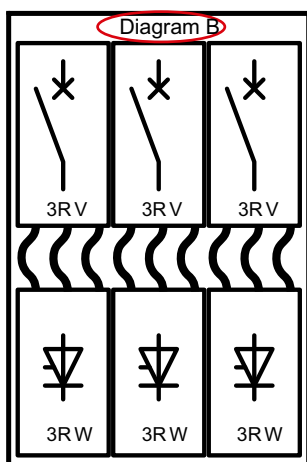

Graph	Assembly type	3RW30				3RW40			3RW40 + optional fan		
		3RW301*	3RW302*	3RW303*	3RW304*	3RW402*	3RW403*	3RW404*	3RW402*	3RW403*	3RW404*
A	Standalone assembly	1.0				1.0			1.6	2.0	2.8
B	Side-by-side assembly	0.7	0.1	0.3		0.1	0.3		1.6	2.0	2.8
C	Standalone assembly	0.5				0.5			1.8		
D	Side-by-side assembly	0.3	-			-			1.7		

Type	3RW4024
Power electronics	
Load rating with rated operational current I_p	
• According to IEC and UL/CSA ¹⁾ , for standalone assembly, AC-53a	
- At 40°C	A 12.5
- At 50°C	A 11
- At 60°C	A 10
Minimum settable rated motor current I_M for the motor overload protection	A 5
Power loss	
• During operation after successful startup with uninterrupted rated operational current (40°C) approx.	W 2
• During starting with current limit set to 300% I_M (40°C)	W 68
Permissible rated motor current and starts per hour	
• For normal starting (CLASS 10)	
- Rated motor current $I_M^{(2)}$, ramp-up time 3 s	A 12.5
- Starts per hour ³⁾	1/h 50

Assembly of a 3RV2021 motor starter protector and connection of a 3RW40 24 soft starter with cables and vertical mounting for CLASS 10 starting:

Switching frequency of 3RW40 with standalone assembly:	50 1/h
Switching frequency factor for diagram B without a fan:	0.1
Switching frequency factor for diagram B with a fan ¹⁾ :	1.6
Maximum permissible switching frequency:	
Without fan	50 1/h x 0.1 = 5 1/h
With fan ¹⁾ :	50 1/h x 1.6 = 80 1/h
1) Optional fan: 3RW49 28-8VB00	

Result

The pump could be started five times an hour providing the above assembly conditions are complied with (side-by-side assembly, vertical mounting). A switching frequency of up to 80 starts per hour can be achieved by equipping the 3RW4026 with the optional 3RW4928-8VB00 fan.

11.7 Configuration aids

11.7.1 Online configurator

Using the online configurator, you can select soft starters based on the rated motor data and the specified device functionality. The selection of the soft starter is subject to fixed conditions and constraints, such as switching frequency, startup class etc. These conditions cannot be changed. You can find the online configurator at [www.siemens.de/sanftstarter](https://mall.automation.siemens.com/WW/guest/configurators/ipc/ipcFrameset.asp?serumpage=guiipc&urlParams=PROD%5FID%3D3RW&MLFB=&proxy=all%2Eautomation%2Esiemens%2Ecom&retURL=%2FWW%2Fguest%2Findex%2Easp%3FnodeID%3D9990301%26lang%3Dde&lang=en) (<https://mall.automation.siemens.com/WW/guest/configurators/ipc/ipcFrameset.asp?serumpage=guiipc&urlParams=PROD%5FID%3D3RW&MLFB=&proxy=all%2Eautomation%2Esiemens%2Ecom&retURL=%2FWW%2Fguest%2Findex%2Easp%3FnodeID%3D9990301%26lang%3Dde&lang=en>).

11.7.2 Win-Soft Starter selection and simulation software

The Win-Soft Starter software can be used to simulate and select all SIEMENS soft starters, taking into account various parameters such as the supply system conditions, motor data, load data, high switching frequencies etc.

It is a useful tool, which does away with the need for time-consuming and complex manual calculations if you need to select the optimum soft starter for your particular case.

Further information under:

www.siemens.de/sanftstarter > software > Win-Soft Starter (<http://www.automation.siemens.com/mcms/low-voltage/en/industrial-controls/controls/solid-state-switching-devices/soft/software/win-soft-starter/Pages/default.aspx>)

11.7.3 Technical Assistance

SIEMENS Technical Assistance offers personal support to help you find the optimum device and provides assistance with technical queries relating to low-voltage switchgear and controlgear

Technical Assistance:	Phone: +49 (0) 911-895-5900 (8 ⁰⁰ - 17 ⁰⁰ CET) Fax: +49 (0) 911-895-5907 e-mail: (mailto:technical-assistance@siemens.com) Internet: (www.siemens.com/lowvoltage/technical-assistance)
------------------------------	---

11.7.4 SIRIUS soft starter training course (SD-SIRIUSO)

SIEMENS offers a two-day training course on SIRIUS electronic soft starters to keep both customers and our own employees up to date with the latest information about configuring, commissioning, and maintenance.

Please address all inquiries and enrollments to:

Training Center Erlangen
A&D PT 4
Werner-von-Siemens-Str. 65
D-91052 Erlangen
Phone: ++49 9131 729262
Fax: ++49 9131 728172
e-mail: (<mailto:sibrain.industry@siemens.com>)
Internet: (<http://www.siemens.com/sitrain>)

11.8 Order number system for the 3RW30

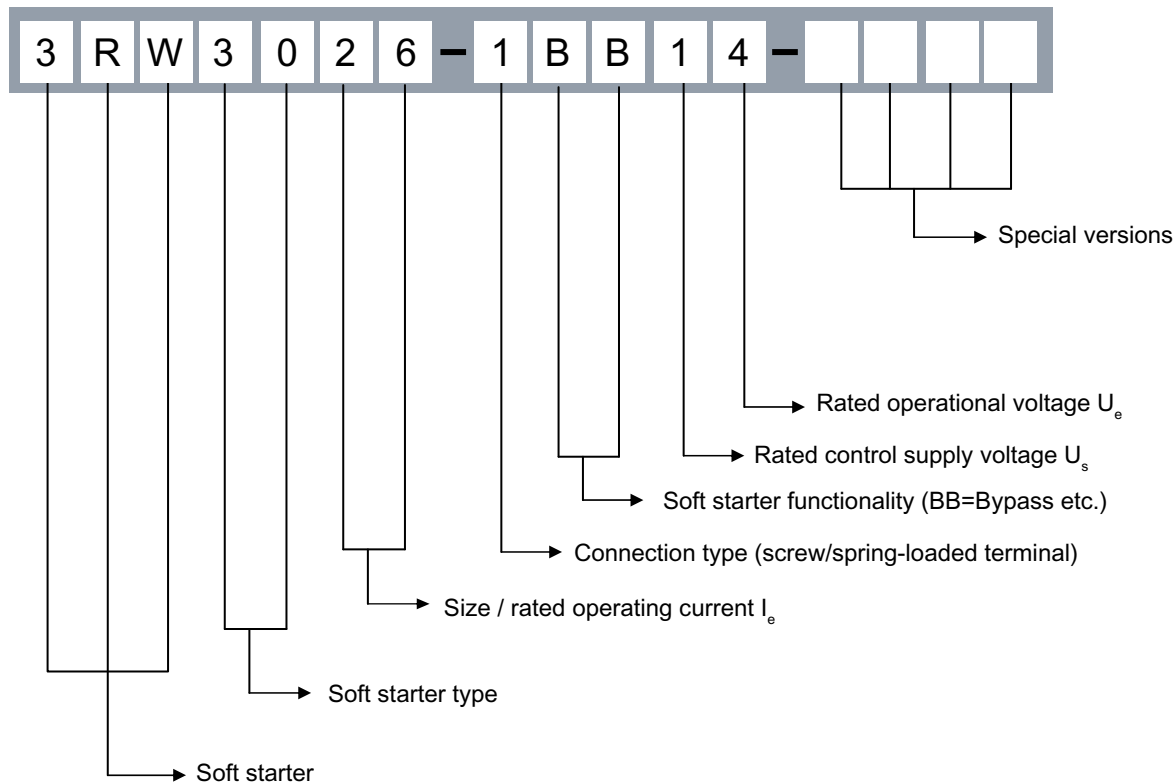

Rated current and rated power at $U_e = 400\text{ V} / 460\text{ V}$ and $T_{amb} = 40\text{ °C} / 50\text{ °C}$

13	$I_e = 3.6\text{ A} / 3\text{ A}$	$P_e = 1.5\text{ kW} / 1.5\text{ hp}$	Size S00
14	$I_e = 6.5\text{ A} / 4.8\text{ A}$	$P_e = 3\text{ kW} / 3\text{ hp}$	
16	$I_e = 9.0\text{ A} / 7.8\text{ A}$	$P_e = 4\text{ kW} / 5\text{ hp}$	
17	$I_e = 12.5\text{ A} / 11\text{ A}$	$P_e = 5.5\text{ kW} / 7.5\text{ hp}$	
18	$I_e = 17.6\text{ A} / 17\text{ A}$	$P_e = 7.5\text{ kW} / 10\text{ hp}$	
26	$I_e = 25\text{ A} / 23\text{ A}$	$P_e = 11\text{ kW} / 15\text{ hp}$	Size S0
27	$I_e = 32\text{ A} / 29\text{ A}$	$P_e = 15\text{ kW} / 20\text{ hp}$	
28	$I_e = 38\text{ A} / 34\text{ A}$	$P_e = 18.5\text{ kW} / 25\text{ hp}$	
36	$I_e = 45\text{ A} / 42\text{ A}$	$P_e = 22\text{ kW} / 30\text{ hp}$	Size S2
37	$I_e = 63\text{ A} / 58\text{ A}$	$P_e = 30\text{ kW} / 40\text{ hp}$	
38	$I_e = 72\text{ A} / 62\text{ A}$	$P_e = 37\text{ kW} / 40\text{ hp}$	
46	$I_e = 80\text{ A} / 73\text{ A}$	$P_e = 45\text{ kW} / 50\text{ hp}$	Size S3
47	$I_e = 106\text{ A} / 398\text{ A}$	$P_e = 55\text{ kW} / 75\text{ hp}$	

For more information, refer to chapter Technical data [Page 121].

11.9 Order number system for the 3RW40

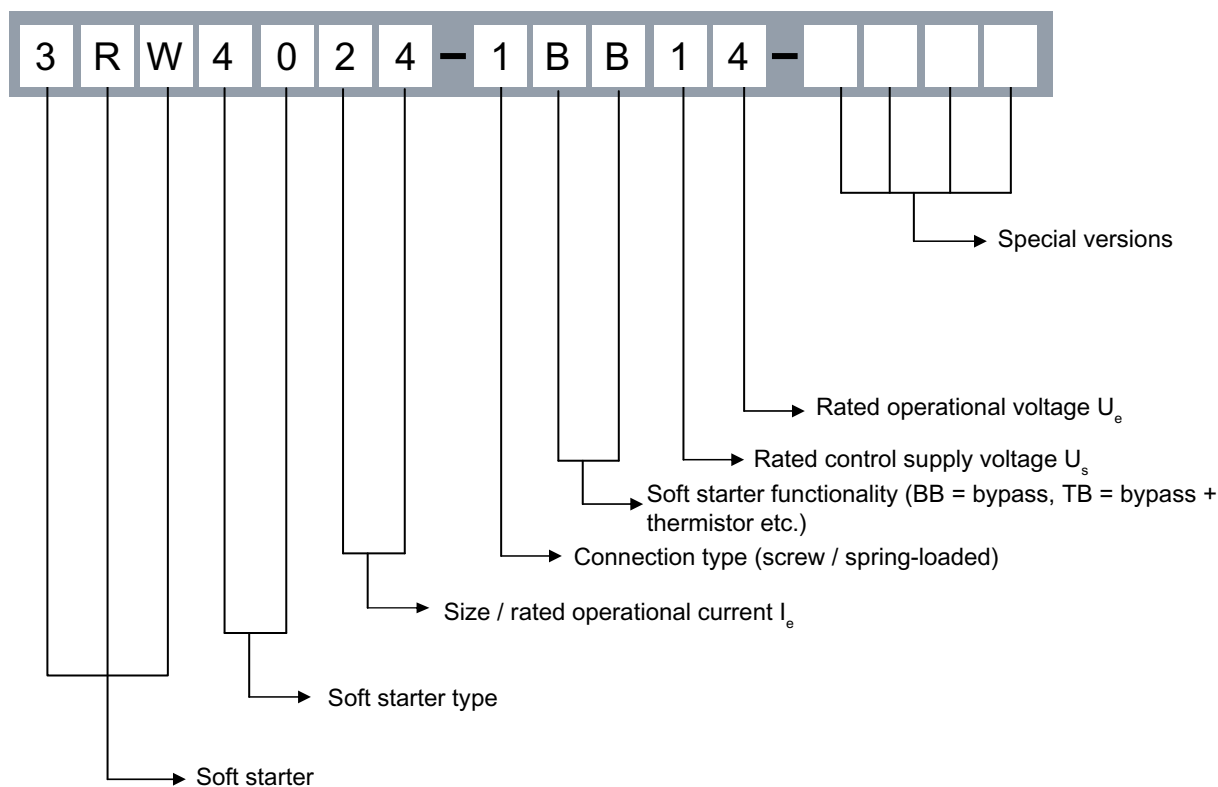

Rated current and rated power at $U_e = 400 \text{ V} / 460 \text{ V}$ and $T_{amb} = 40 \text{ °C} / 50 \text{ °C}$

24	$I_e = 12.5 \text{ A} / 11 \text{ A}$	$P_e = 5.5 \text{ kW} / 7.5 \text{ hp}$	Size S0
26	$I_e = 25 \text{ A} / 23 \text{ A}$	$P_e = 11 \text{ kW} / 15 \text{ hp}$	
27	$I_e = 32 \text{ A} / 29 \text{ A}$	$P_e = 15 \text{ kW} / 20 \text{ hp}$	
28	$I_e = 38 \text{ A} / 34 \text{ A}$	$P_e = 18.5 \text{ kW} / 25 \text{ hp}$	
36	$I_e = 45 \text{ A} / 42 \text{ A}$	$P_e = 22 \text{ kW} / 30 \text{ hp}$	Size S2
37	$I_e = 63 \text{ A} / 58 \text{ A}$	$P_e = 30 \text{ kW} / 40 \text{ hp}$	
38	$I_e = 72 \text{ A} / 62 \text{ A}$	$P_e = 37 \text{ kW} / 40 \text{ hp}$	
46	$I_e = 80 \text{ A} / 73 \text{ A}$	$P_e = 45 \text{ kW} / 50 \text{ hp}$	Size S3
47	$I_e = 106 \text{ A} / 98 \text{ A}$	$P_e = 55 \text{ kW} / 75 \text{ hp}$	
55	$I_e = 132 \text{ A} / 117 \text{ A}$	$P_e = 75 \text{ kW} / 75 \text{ hp}$	Size S6
56	$I_e = 160 \text{ A} / 145 \text{ A}$	$P_e = 90 \text{ kW} / 100 \text{ hp}$	
73	$I_e = 230 \text{ A} / 205 \text{ A}$	$P_e = 132 \text{ kW} / 150 \text{ hp}$	Size S12
74	$I_e = 280 \text{ A} / 248 \text{ A}$	$P_e = 160 \text{ kW} / 200 \text{ hp}$	
75	$I_e = 350 \text{ A} / 315 \text{ A}$	$P_e = 200 \text{ kW} / 250 \text{ hp}$	
76	$I_e = 432 \text{ A} / 385 \text{ A}$	$P_e = 250 \text{ kW} / 300 \text{ hp}$	

For more information, refer to chapter Technical data [Page 121].

Commissioning

12.1 Before commencing work: Isolating the equipment from the supply system and ensuring that it cannot be reconnected.

 **DANGER**

Hazardous voltage Will cause death or serious injury.

- Disconnect the system and all devices from the power supply before starting work.
- Secure against switching on again.
- Verify that the equipment is not live.
- Ground and short-circuit.
- Erect barriers around or cover adjacent live parts.

 **DANGER**

Hazardous voltage Will cause death or serious injury.

Qualified Personnel.

The equipment / system may only be commissioned and operated by qualified personnel. For the purpose of the safety information in these Operating Instructions, a "qualified person" is someone who is authorized to energize, ground, and tag equipment, systems, and circuits in accordance with established safety procedures.

12.2 Commissioning the 3RW30

Commissioning, description of the start and output parameters



12.2.1 Commissioning procedure

1. Check the voltages and wiring.
2. Set the start parameters (for recommended parameters, refer to the quick commissioning table).
3. Start up the motor and if necessary optimize the parameters (refer to the quick commissioning table).
4. Document the parameter settings if required (refer to chapter Table of parameters used [Page 205]).

12.2.2 Quick commissioning of the 3RW30 and optimization of the parameters

CAUTION

Risk of property damage.
Connection to unassigned terminals is not permitted.

Recommended setting	Start parameters	
	Starting voltage %	Ramp time s
Application		
Conveyor belt	70	10
Roller conveyor	60	10
Compressor	50	20
Small fan	40	20
Pump	40	10
Hydraulic pump	40	10
Agitator	40	20

CAUTION

Risk of property damage.
Take account of the switching frequency (refer to the technical data).
The soft starter could be damaged if the switching frequency is too high.

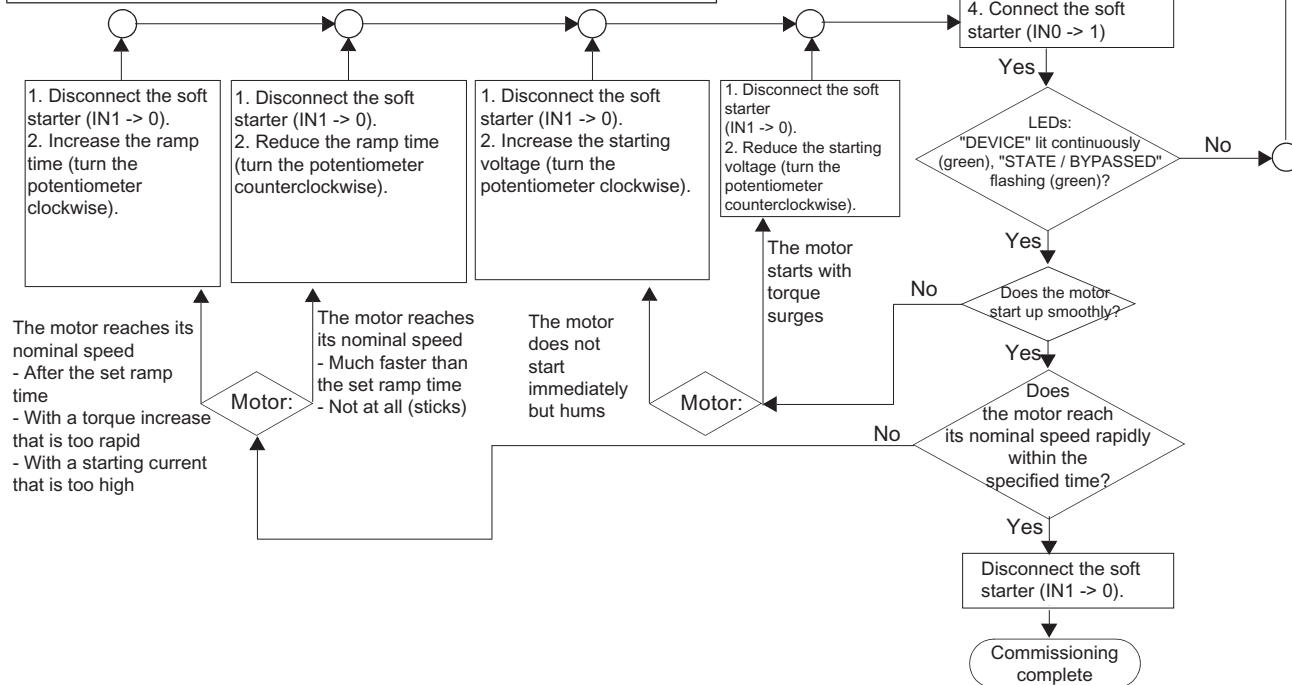

12.2.3 Setting the soft start function

Voltage ramp

The SIRIUS 3RW30 achieves soft starting by means of a voltage ramp. The motor terminal voltage is increased from a parameterizable starting voltage to the mains voltage within a definable ramp time.

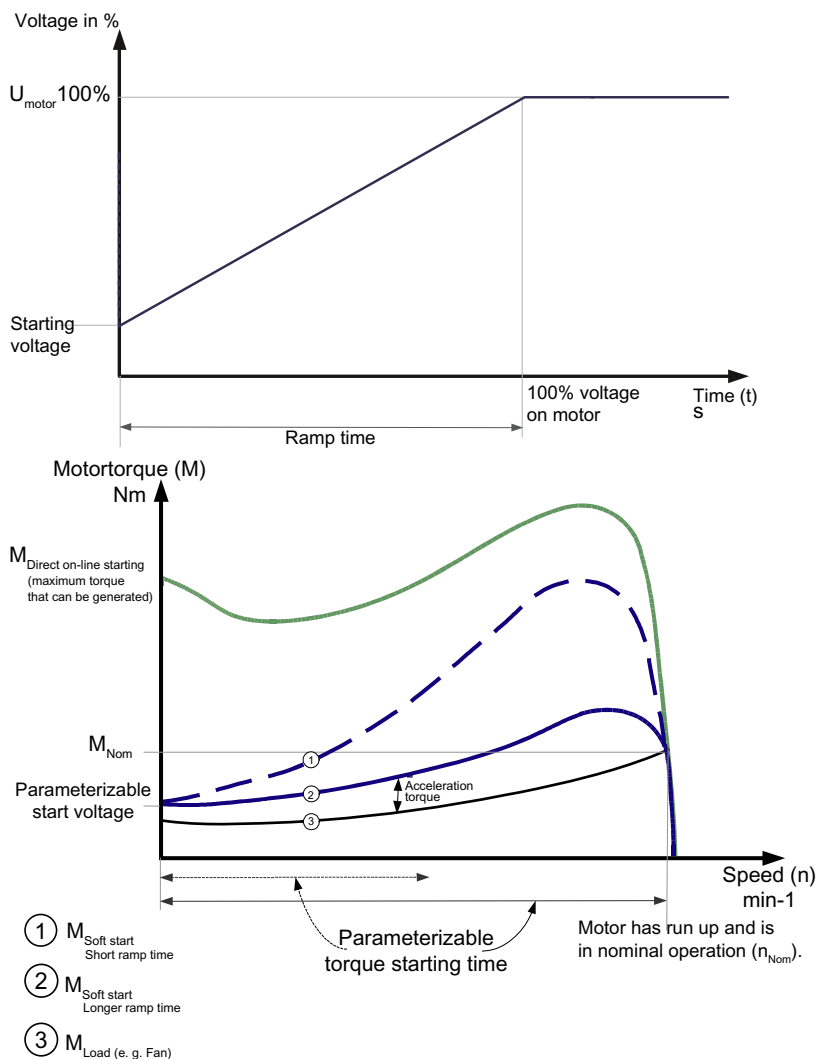

12.2.4 Setting the starting voltage

U potentiometer



The starting voltage value is set with the U potentiometer. This value determines the starting torque of the motor. A lower starting voltage results in a lower starting torque (softer start) and a lower starting current.

The starting voltage selected must be sufficiently high to ensure that motor starts up smoothly as soon as the start command is received by the soft starter.

12.2.5 Setting the ramp time

t potentiometer



You define the length of the required ramp time with the t potentiometer. The ramp time determines the time taken to increase the motor voltage from the parameterized starting voltage to the mains voltage. This time merely influences the motor's acceleration torque, which drives the load during the ramp-up process. The actual motor starting times are load-dependent and can differ from the 3RW soft starter settings.

A longer ramp time results in a lower starting current and a reduced acceleration torque as the motor starts up. The startup is slower and smoother as a result. The ramp time must be long enough for the motor to reach its nominal speed. If the time selected is too short, in other words if the ramp time ends before the motor has started up successfully, a very high starting current that can even equal the direct starting current at the same speed occurs at this instant.

The SIRIUS 3RW30 soft starter can be damaged in this application (set ramp time shorter than the actual motor ramp-up time). A maximum ramp-up time of 20 s is possible for the 3RW30. An appropriately dimensioned SIRIUS 3RW40 or 3RW44 soft starter should be chosen for startup processes with a motor ramp-up time > 20 s.

CAUTION

Risk of property damage

Make sure the selected ramp time is longer than the actual motor ramp-up time. If not, the SIRIUS 3RW30 may be damaged because the internal bypass contacts close when the set ramp time elapses. If the motor has not finished starting up, an AC3 current that could damage the bypass contact system will flow.

When using the 3RW40: The 3RW40 has an integrated ramp-up detection function that prevents this operating state from occurring.

12.2.6 ON output

ON output contact

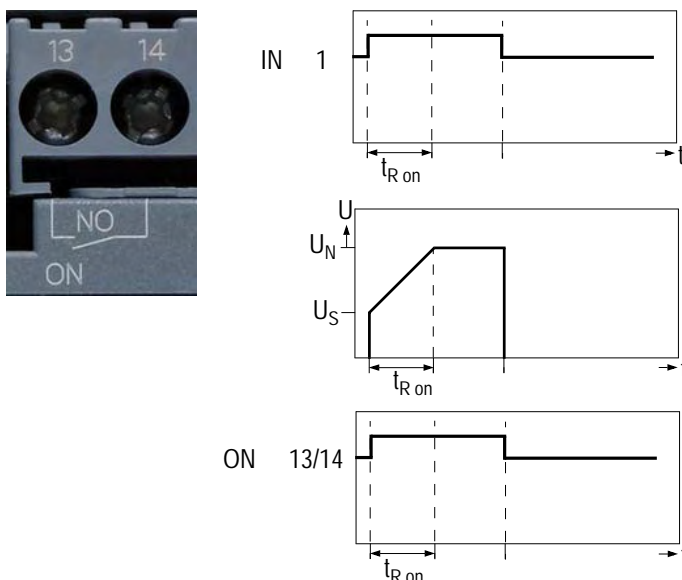

Figure 12-1 State diagram of the ON output contact

The output contact at terminal 13/14 (ON) closes if a signal is present at terminal 1 (IN); it remains closed until the start command is removed.

The output can be used, for instance, to control a line contactor connected upstream or to implement latching if you selected pushbutton control. For recommended circuits, refer to chapter Typical circuit diagrams [Page 167].

For the state diagram of the contacts in the various operating states, refer to chapter 3RW30: LEDs and troubleshooting [Page 44].

12.3 3RW30: LEDs and troubleshooting

3RW30		LEDs on 3RW30		Auxiliary contact
		Soft starter		
		DEVICE (rd/gn/ylw)	STATE/BYPASSED/ FAILURE (gn/rd)	13 14/ (ON)
$U_s = 0$		●	●	
Operating state	IN			
Off	0	☀ gn	●	
Start	1	☀ gn	◐ gn	
Bypassed	1	☀ gn	☀ gn	
Fault				
Impermissible electronics supply voltage ¹⁾		●	☀ rd	
Bypass overload ²⁾		☀ ylw	☀ rd	
- Missing load voltage ¹⁾ - Phase failure, missing load ¹⁾		☀ gn	☀ rd	
Device fault ³⁾		☀ rd	☀ rd	

LEDs			gn	rd	ylw
●	☀	◐	=	=	=
Off	ON	Flashing	Green	Red	Yellow

1) The fault is automatically reset by an outgoing event. An automatic restart is initiated and the 3RW restarted if a start command is present at the input.

WARNING

Automatic restart

Danger of death, serious injury, or property damage.

If you do not want the motor to start automatically, you must integrate suitable additional components, e.g. phase failure or load monitoring devices, into the control and main circuits.

2) The fault can be acknowledged by removing the start command at the start input.

3) Switch off the control voltage, then switch it on again. If the fault is still present, contact your SIEMENS partner or Technical Assistance.

For notes on troubleshooting, refer to the table below.

Fault	Cause	Remedy
Impermissible electronics supply voltage	The control supply voltage does not correspond to the soft starter's rated voltage.	Check the control supply voltage; an incorrect control supply voltage could be caused by a power failure or a voltage dip.
Bypass overload	A current $> 3.5 \times I_e$ of the soft starter occurs for > 60 ms in bypass mode (e.g. because the motor is blocked).	Check the motor and load, and check the soft starter's dimensions.

Fault	Cause	Remedy
Missing load voltage, phase failure / missing load	Cause 1: Phase L1 / L2 / L3 is missing or fails / collapses when the motor is operating. Tripped as a result of a dip in the permissible rated operational voltage > 15 % for > 100 ms during the startup process or > 200 ms in bypass mode.	Connect L1 / L2 / L3 or correct the voltage dip.
	Cause 2: The motor that is connected is too small and the fault occurs as soon as it is switched to bypass mode.	If less than 10 % of the soft starter's rated current is flowing, the motor cannot be operated with soft starter. Use another soft starter.
	Cause 3: Motor phase T1 / T2 / T3 is not connected.	Connect the motor properly (e.g. jumpers in the motor terminal box, repair switch closed etc.)
Device fault	Soft starter defective.	Contact your SIEMENS partner or Technical Assistance.

12.4 Commissioning the 3RW40

Commissioning, description of the start, stop, motor protection, and output parameters

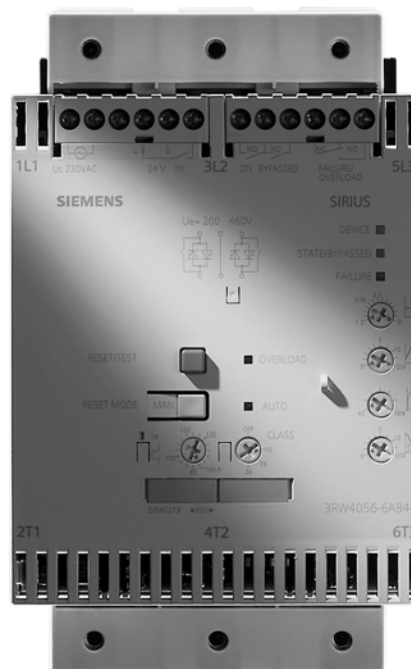

12.4.1 Commissioning procedure

1. Check the voltages and wiring.
2. Set the start and stop parameters (for recommended parameters, refer to the quick commissioning table).
3. Set the motor overload function (if required)
4. Define the RESET mode if a failure occurs.
5. Start up the motor and if necessary optimize the parameters (refer to the quick commissioning table).
6. Document the parameter settings if required.

12.4.2 Quick commissioning of the 3RW40 and optimization of the parameters

CAUTION

Risk of property damage.
Connection to unassigned terminals is not permitted.

Quick commissioning of SIRIUS 3RW40 soft starter

1. Check the wiring
 - Control unit, and
 - Power unit

2. Parameterize the device
 - Motor protection
 - Set the rated motor current of the operating mechanism with the I_e adjuster
 - Set the required trip class with the CLASS switch
 - Soft start function
 - Current limiting value ($\times I_e$)
 - Ramp time (s)
 - Ramp-down time (s)
 Set to the required values (refer to table of recommended settings).

Application	Start parameters			Stop parameter
	Starting voltage %	Ramp time s	Current limiting value	Ramp-down time s
Conveyor belt	70	10	$5 \times I_e$	5
Roller conveyor	60	10	$5 \times I_e$	5
Compressor	50	10	$4 \times I_e$	0
Small fan	40	10	$4 \times I_e$	0
Pump	40	10	$4 \times I_e$	10
Hydraulic pump	40	10	$4 \times I_e$	0
Agitator	40	20	$4 \times I_e$	0
Milling machine	40	20	$4 \times I_e$	0

3. Check and connect the voltages in the control and main circuits.

Determine and rectify the cause of the fault using the LEDs and the state table. (refer to Troubleshooting chapter)

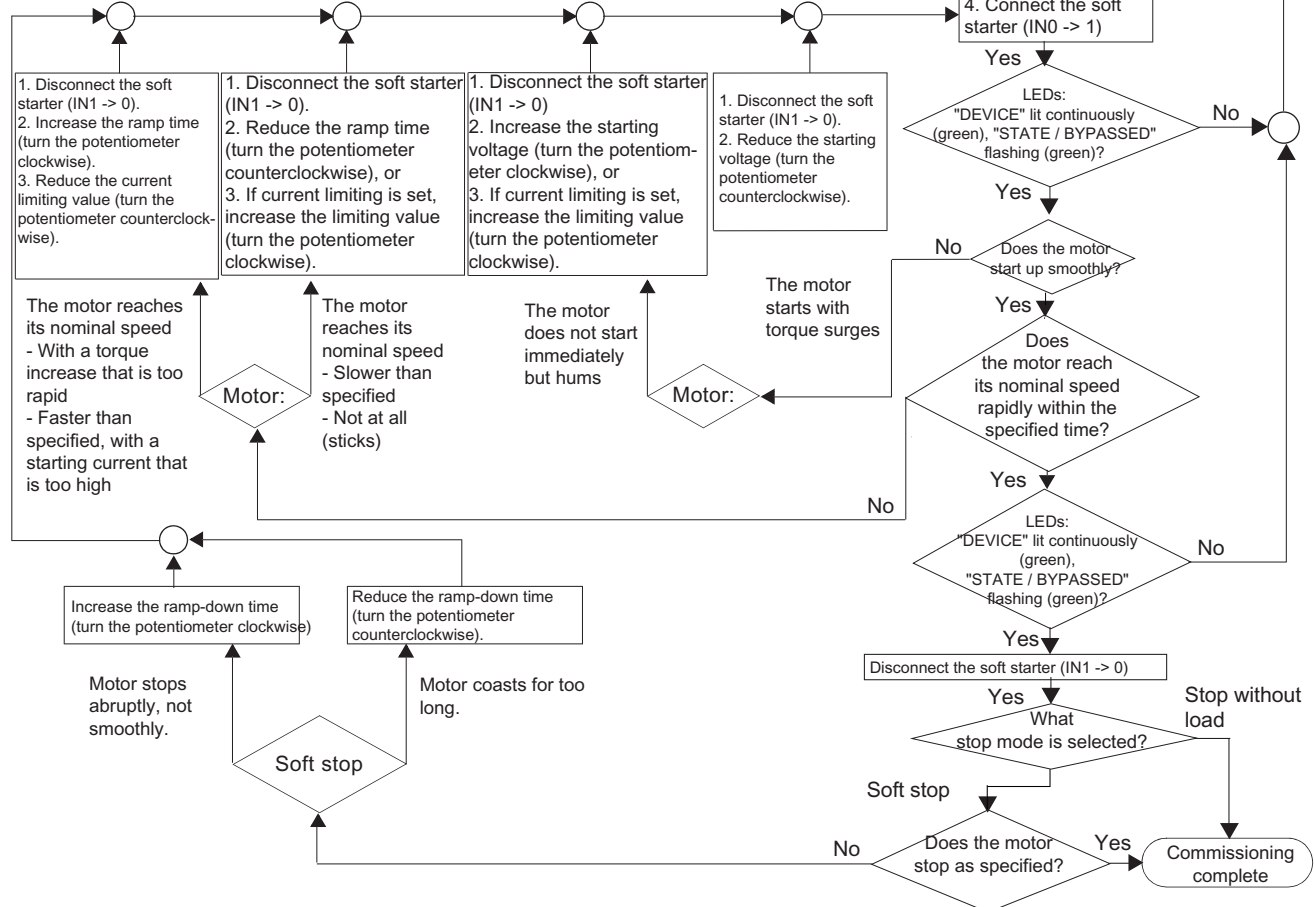

12.4.3 Setting the soft start function

Voltage ramp

The SIRIUS 3RW40 achieves soft starting by means of a voltage ramp. The motor terminal voltage is increased from a parameterizable starting voltage to the mains voltage within a definable ramp time.

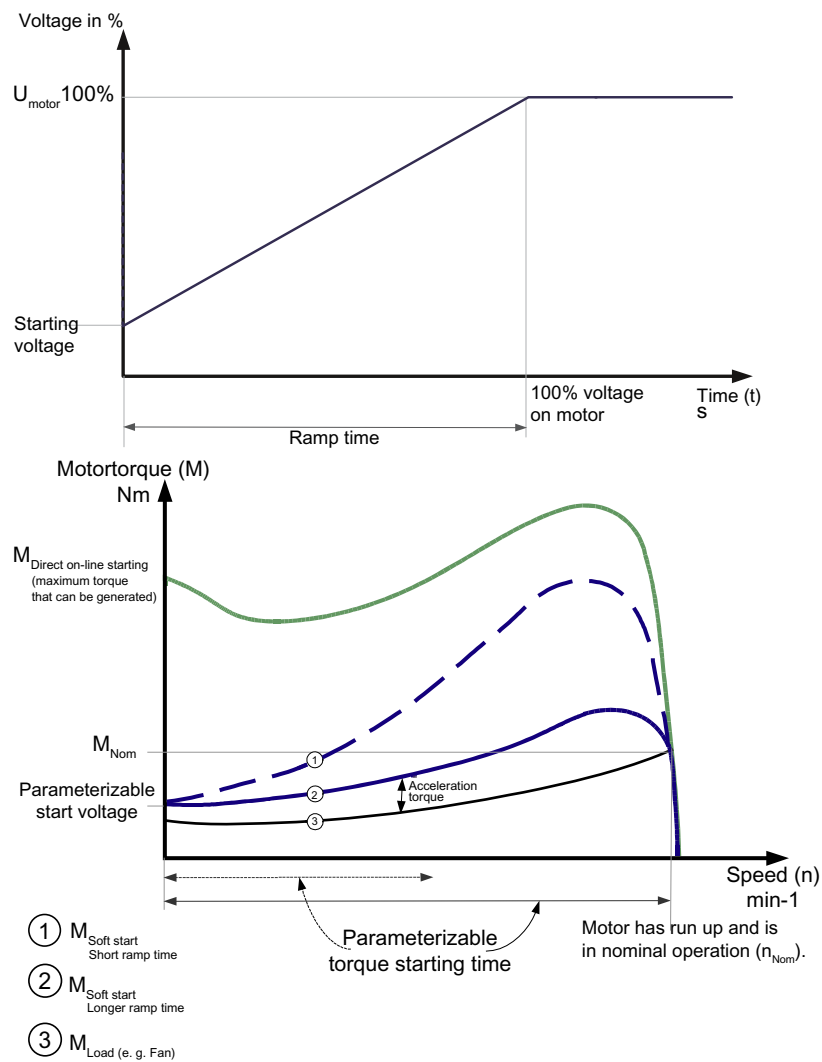

12.4.4 Setting the starting voltage

U potentiometer



The starting voltage value is set with the U potentiometer. This value determines the starting torque of the motor. A lower starting voltage results in a lower starting torque (softer start) and a lower starting current.

The starting voltage selected must be sufficiently high to ensure that motor starts up smoothly as soon as the start command is received by the soft starter.

12.4.5 Setting the ramp time

t potentiometer



You define the length of the required ramp time with the t potentiometer. The ramp time determines the time taken to increase the motor voltage from the parameterized starting voltage to the mains voltage. This time merely influences the motor's acceleration torque, which drives the load during the ramp-up process. The actual motor starting times are load-dependent and can differ from the 3RW soft starter settings.

A longer ramp time results in a lower starting current and a reduced acceleration torque as the motor starts up. The startup is slower and smoother as a result. The ramp time must be long enough for the motor to reach its nominal speed. If the time selected is too short, in other words if the ramp time ends before the motor has started up successfully, a very high starting current that can even equal the direct starting current at the same speed occurs at this instant.

The SIRIUS 3RW40 soft starter additionally limits the current to the value set with the current limiting potentiometer. As soon as the current limiting value is reached, the voltage ramp or the ramp time is interrupted and the motor is started with the current limiting value until it has started up successfully. In this case, the motor ramp-up times may be longer than the maximum parameterizable 20 seconds ramp time or the ramp time that is actually set on the soft starter (for further information about the maximum ramp-up times and switching frequencies, refer to the Technical data chapter > 3RW30 13, 14, 16, 17, 18-.BB.. power electronics [Page 124] ff. and 3RW40 24, 26, 27, 28 power electronics [Page 149] ff.).

12.4.6 Current limiting in conjunction with a starting voltage ramp and ramp-up detection

Current limiting

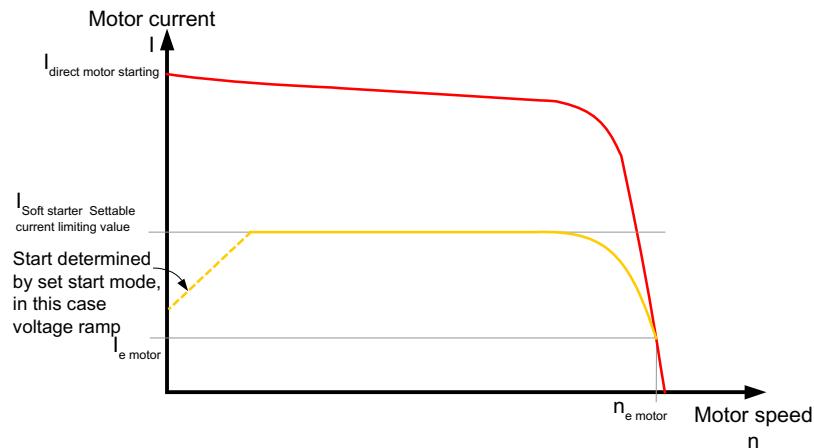

The SIRIUS 3RW40 soft starter measures the phase current (motor current) continuously with the help of integrated current transformers.

The motor current that flows during the startup process can be actively limited by means of the soft starter. The current limiting function takes priority over the voltage ramp function.

As soon as a parameterizable current limit is reached, in other words, the voltage ramp is interrupted and the motor is started with the current limiting value until it has started up successfully. The current limiting function is always active with SIRIUS 3RW40 soft starters. If the current limiting potentiometer is set to the clockwise stop (maximum), the starting current is limited to five times the set rated motor current.

12.4.7 Setting the motor current

I_e potentiometer

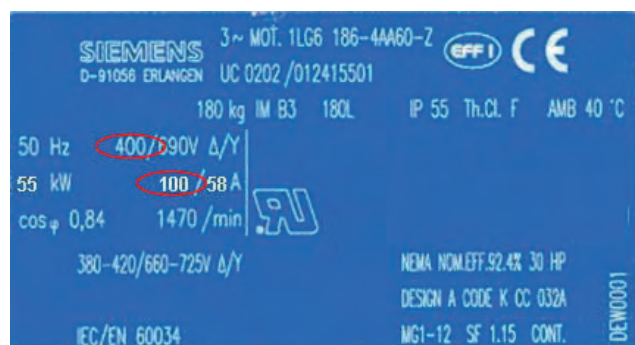

The rated operational current of the motor must be set with the I_e potentiometer according to the mains voltage and the motor connection (wye-delta). The electronic motor overload

protection also refers to this set value if it is active. For the permissible settings referred to the required motor overload trip class, refer to chapter Motor current settings [Page 107].

12.4.8 Setting the current limiting value

xI_e potentiometer



The current limiting value is set with the xI_e potentiometer to the maximum required starting current as a factor of the set rated motor current (I_e).

Example

- I_e potentiometer set to 100 A
- xI_e potentiometer set to 5 => current limiting 500 A.

As soon as the selected current limiting value is reached, the motor voltage is reduced or controlled by the soft starter to prevent the current from exceeding the limit. Since the starting current is asymmetrical, the set current corresponds to the arithmetic mean value for the three phases.

If the current limiting value is set to the equivalent of 100 A, the starting currents might be approx. 80 A in L1, 120 A in L2, and 100 A in L3 (refer to chapter Starting current asymmetry [Page 21]).

The set current limiting value must be high enough to ensure that the torque generated in the motor is sufficient to accelerate the motor to nominal speed. Three to four times the value of the motor's rated operational current (I_e) can be assumed as typical here.

The current limiting function is always active because it is required by the intrinsic device protection. If the current limiting potentiometer is set to the clockwise stop (maximum), the starting current is limited to five times the set rated motor current.

12.4.9 Ramp-up detection

The SIRIUS soft starter has a motor ramp-up detection function that is always active regardless of the start mode. If it detects a motor startup, the motor voltage is immediately increased to 100 % of the mains voltage. The thyristors of the soft starter are bridged by the bypass contacts integrated in the device and the successful startup is indicated by means of the BYPASS output and the STATE / BYPASSED LED.

12.5 Setting the soft stop function

In "soft stop" mode, the natural stop process of the load is decelerated. The function is used when the load must be prevented from stopping abruptly. This is typically the case in applications with a low mass inertia or a high counter-torque.

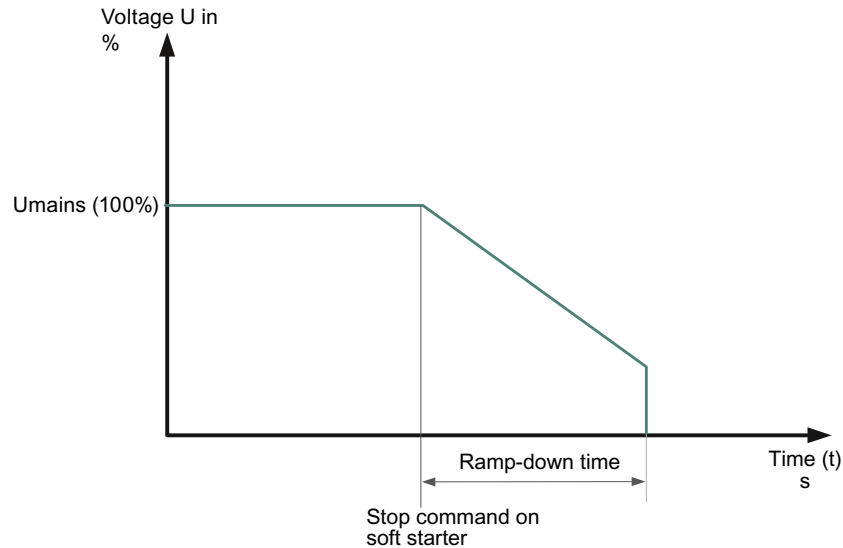

12.5.1 Setting the ramp-down time

t potentiometer



You can set a ramp-down time with the t potentiometer. This determines how long power should still be supplied to the motor after the ON command is removed. The torque generated in the motor is reduced by means of a voltage ramp function within this ramp-down time and the application stops smoothly.

If the potentiometer is set to 0, there is no voltage ramp during stopping (stop without load).

12.6 Setting the motor protection function

The motor overload protection function is implemented on the basis of the winding temperature. This indicates whether the motor is overloaded or functioning in the normal operating range.

The winding temperature can either be calculated with the help of the integrated, electronic motor overload function or measured with a connected motor thermistor.

12.6.1 Setting the electronic motor overload protection

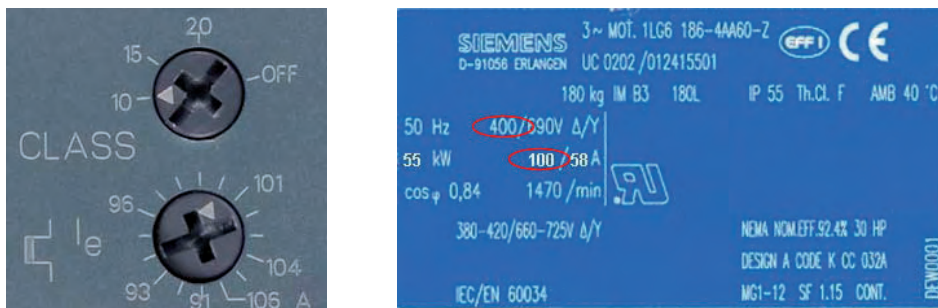

I_e potentiometer

The rated operational current of the motor must be set with the I_e potentiometer according to the mains voltage and the motor connection (wye-delta).

The current flow during motor operation is measured by measuring the current with transformers integrated in the soft starter. This value is also used for the current limiting function. The temperature rise in the winding is calculated based on the rated operational current set for the motor.

CLASS potentiometer

You can set the required trip class (10, 15, or 20) with the CLASS potentiometer. A trip is generated by the soft starter when the standardized characteristic is reached, depending on the trip class (CLASS setting).

The trip class specifies the maximum time within which a protective device must trip from a cold state at $7.2 \times$ the rated operational current (motor protection to IEC 60947). The tripping characteristics represent this time as a function of the tripping current (refer to chapter Motor protection tripping characteristics for 3RW40 (with symmetry) [Page 161]).

You can set different CLASS characteristics according to the startup class. If the potentiometer is set to OFF, the "electronic motor overload protection" function is deactivated.

Note

The rated data of the soft starters refers to normal starting (CLASS 10). The starters may need to be calculated with a size allowance for heavy-duty starting ($>$ CLASS 10). You can only set a rated motor current that is lower than the soft starter rated current (refer to chapter Motor current settings [Page 107]); if not, a fault will be indicated by the OVERLOAD LED (red flashing) and it will not be possible to start the SIRIUS 3RW soft starter.

12.6.2 Motor current settings

Motor current settings

	I_e [A]	I_{min} [A]	I_{max} [A] CLASS 10	I_{max} [A] CLASS 15	I_{max} [A] CLASS 20
3RW40 24-...	12.5	5	12.5	11	10
3RW40 26-...	25.3	10.3	25.3	23	21
3RW40 27-...	32.2	17.2	32.2	30	27
3RW40 28-...	38	23	38	34	31
3RW40 36-...	45	22.5	45	42	38
3RW40 37-...	63	25.5	63	50	46
3RW40 38-...	72	34.5	72	56	50
3RW40 46-...	80	42.5	80	70	64
3RW40 47-...	106	46	106	84	77
3RW40 55-...	134	59	134	134	124
3RW40 56-...	162	87	162	152	142
3RW40 73-...	230	80	230	210	200
3RW40 74-...	280	130	280	250	230
3RW40 75-...	356	131	356	341	311
3RW40 76-...	432	207	432	402	372

12.6.3 Motor protection acc. to ATEX

Refer to the information in chapter Motor protection / intrinsic device protection (3RW40 only) [Page 32].

12.7 Thermistor motor protection

(Optional for 3RW40 2. to 3RW40 4. with 24 V AC/DC rated control voltage)

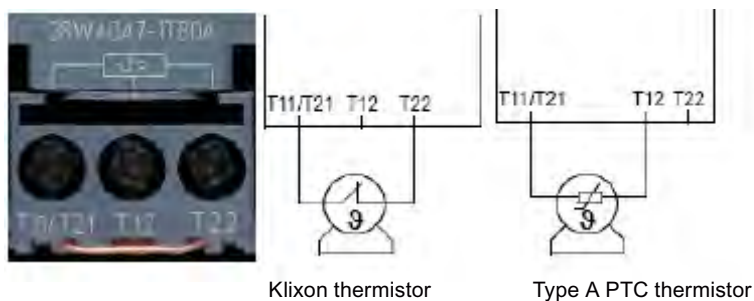

Thermistor motor protection

After removing the copper jumper between T11/21 and T22, you can connect and evaluate either a Klixon thermistor integrated in the motor winding (at terminal T11/T21-T22) or a type A PTC (at terminal T11/T21-T12).

12.8 Motor protection trip test



TEST / RESET button

You initiate a motor overload trip by pressing the RESET / TEST button for longer than five seconds. The SIRIUS 3RW40 soft starter is tripped by the fault signal at the OVERLOAD LED, the FAILURE / OVERLOAD contact 95-98 closes, and the motor that is connected and running is switched off.

12.9 Functions of the outputs

12.9.1 Functions of the BYPASSED and ON / RUN outputs

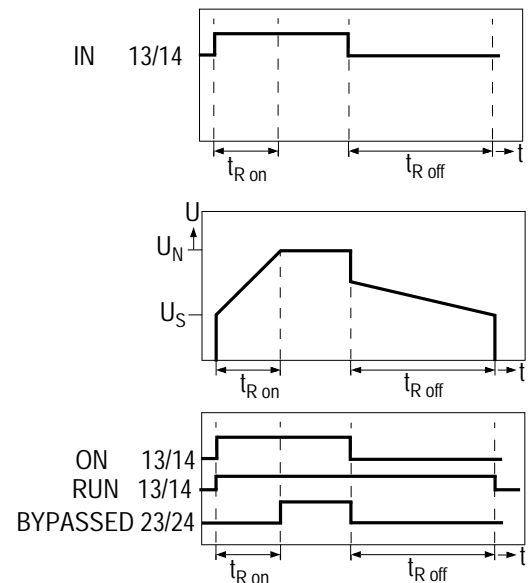

BYPASSED output contact

The BYPASSED output at terminal 23 / 24 closes as soon as the SIRIUS 3RW40 soft starter detects that the motor has started up (refer to chapter Ramp-up detection [Page 104]). The integral bypass contacts simultaneously close and the thyristors are bridged. The integral bypass contacts and output 23 / 24 open again as soon as the start input IN is removed.

ON / RUN output contact

ON function set: The potential-free output contact at terminal 13/14 (ON) closes if a signal is present at terminal 1 (IN); it remains closed until the start command is removed (factory default). The ON function can be used, for instance, as a latching contact if you selected pushbutton control (refer to chapter Control by pushbutton [Page 168]).

Reparameterizing the output of the ON function (factory default) to RUN

You can reparameterize the output function from ON to RUN by simultaneously pressing two buttons (refer to chapter Parameterizing the 3RW40 outputs [Page 110]).

RUN function set: The potential-free output contact at terminal 13/14 closes if a signal is present at terminal 1 (IN); it remains closed until the start command is removed and after that until the set ramp-down time has elapsed.

If the RUN function is set, you can control a line contactor during the startup process, operation, or the set soft stop (refer to chapter Control with an optional main / line contactor [Page 177])

For recommended circuits, refer to chapter Typical circuit diagrams [Page 167].

12.9.2 Parameterizing the 3RW40 outputs

Programming the ON / RUN output 13/14 on the SIRIUS 3RW40 soft starter

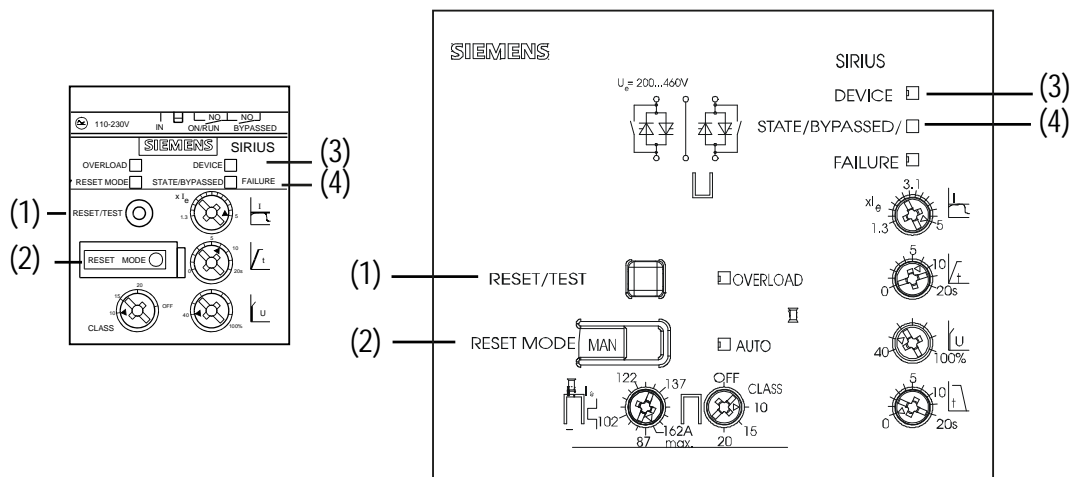
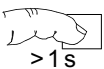
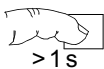













Figure 12-2 Overview of buttons / LEDs on the 3RW40 2 to 3RW40 4 and 3RW40 5 to 3RW40 7

	A	B	C	D	E
RESET / TEST (1)					
RESET MODE (2)					
		=	=	=	=
DEVICE (3)	gn 	gn 	rd 	rd 	gn 
STATE BYPASSED (4)	● OFF	● OFF	◐ ON/ ◑ RUN	◑ RUN/ ◐ ON	● OFF
FAILURE	● OFF	● OFF	● OFF	● OFF	● OFF
AUTO	● / 	 / ●			● / 

●		◐	◑
OFF	ON	Flashing	Flickering

Reparameterizing the ON / RUN output

A: Control voltage is present and the soft starter is in the normal, fault-free position:
The DEVICE LED is continuously lit (green) while the STATE / BYPASSED and FAILURE LEDs are off.
The AUTO LED indicates the color of the set RESET mode.

B: Start programming:
(On the 3RW40 2 device, remove the RESET MODE cover as shown in chapter Setting the RESET MODE [Page 113].) Press the RESET MODE button (2) for longer than 2 s until the DEVICE LED (3) flickers (green). Hold the RESET MODE button (2) pressed down.

C: Simultaneously press the RESET / TEST button (1) for longer than 1 s until the DEVICE LED (3) lights up (red). The active mode set at the ON / RUN output is indicated by the STATE / BYPASSED / FAILURE LED (4):
STATE / BYPASSED / FAILURE LED (4) flashes (green): ON mode (factory setting).
STATE / BYPASSED / FAILURE LED (4) flickers (green): RUN mode.

D: Change the mode:
Press the RESET MODE button (2) briefly. By pressing this button, you change the mode at the output, and the new mode is indicated by the STATE / BYPASSED / FAILURE LED (4):
STATE / BYPASSED / FAILURE LED (4) flickers (green): RUN mode is set.
STATE / BYPASSED / FAILURE LED (4) flashes (green): ON mode is set.

E: Exit programming and save the settings:
Press the RESET / TEST MODE button (1) for longer than 1 s until the DEVICE LED (3) lights up (green).
The LEDs indicate the following states again if the output was successfully parameterized:

DEVICE LED: Continuously lit (green).
STATE / BYPASSED and FAILURE LEDs: Off.
The AUTO LED indicates the color of the set RESET mode.

12.9.3 Function of the FAILURE / OVERLOAD output



FAILURE / OVERLOAD output contact

If there is no rated control voltage or if a failure occurs, the potential-free FAILURE / OVERLOAD output is switched.

Note

For information about whether or not faults can be acknowledged, as well as the recovery time and the corresponding LED and output contact states, refer to chapter Diagnostics and fault signals [Page 44].

12.10 RESET MODE and functions of the RESET / TEST button

12.10.1 SIRIUS 3RW40 2. to 3RW40 4. soft starters

12.10.1.1 Setting the RESET MODE

Position of the RESET button behind the label on the 3RW40 2.

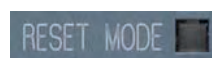
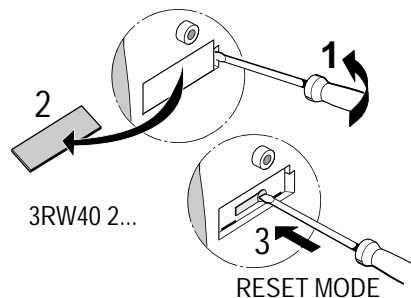

AUTO RESET
Manual RESET
Remote RESET

Yellow
Off
Green

RESET MODE button

By pressing the RESET MODE button, you define the reset procedure in case of a fault. This is indicated by the RESET MODE LED.

12.10.1.2 Manual RESET



RESET / TEST button (RESET MODE LED off)

You can reset a fault by pressing the RESET / TEST button.

12.10.1.3 Remote RESET

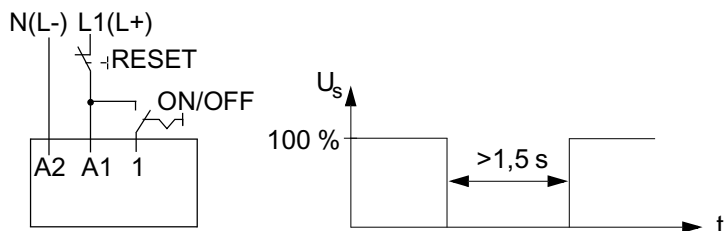

Remote RESET (RESET MODE LED = green)

You can reset a fault signal by disconnecting the control supply voltage for >1.5 s.

12.10.1.4 AUTO RESET

AUTO RESET (RESET MODE LED = yellow)

If you set the RESET mode to AUTO, a fault is automatically reset.

Note

For information about whether or not faults can be acknowledged, as well as the recovery time and the corresponding LED and output contact states, refer to chapter Diagnostics and fault signals [Page 44].

⚠ WARNING

Automatic restart

Can result in death, serious injury, or property damage.

The automatic RESET mode (AUTO RESET) must not be used in applications where there is a risk of serious injury to persons or substantial damage to property if the motor starts up again unexpectedly. The start command (e.g. issued by a contact or the PLC) must be reset prior to issuing a RESET command because the motor attempts to restart again automatically following this RESET command if a start command is still present. This particularly applies if the motor protection has tripped. For safety reasons, you are advised to integrate the group fault output on the 3RW40 (terminals 95 and 96), or the signaling contact of the motor or miniature circuit breaker on all devices, in the controller.

12.10.2 SIRIUS 3RW40 5. to 3RW40 7. soft starters

12.10.2.1 Setting the RESET MODE



AUTO RESET

Yellow

Manual / (remote) RESET

Off

RESET MODE button

By pressing the RESET MODE button, you define the reset procedure in case of a fault. This is indicated by the AUTO LED.

12.10.2.2 Manual RESET



RESET / TEST button (AUTO LED off)

You can reset a fault by pressing the RESET / TEST button.

12.10.2.3 Remote RESET

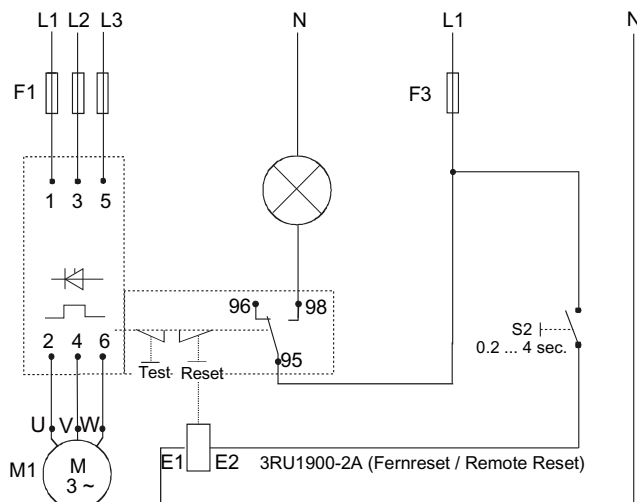

Remote RESET with module for RESET (AUTO LED = off)

You can perform a remote RESET (the RESET MODE set on the starter is MANUAL RESET) by controlling the optional module for RESET (3RU1900-2A).

12.10.2.4 AUTO RESET

AUTO RESET (AUTO LED = yellow)

If you set the RESET mode to AUTO, a fault is automatically reset.

Note

For information about whether or not faults can be acknowledged, as well as the recovery time and the corresponding LED and output contact states, refer to chapter Diagnostics and fault signals [Page 44].

<p>⚠ WARNING</p> <p>Automatic restart Can result in death, serious injury, or property damage.</p> <p>The automatic RESET mode (AUTO RESET) must not be used in applications where there is a risk of serious injury to persons or substantial damage to property if the motor starts up again unexpectedly. The start command (e.g. issued by a contact or the PLC) must be reset prior to issuing a RESET command because the motor attempts to restart again automatically following this RESET command if a start command is still present. This particularly applies if the motor protection has tripped. For safety reasons, you are advised to integrate the group fault output on the 3RW40 (terminals 95 and 96), or the signaling contact of the motor or miniature circuit breaker on all devices, in the controller.</p>
--

12.11 3RW40: LEDs and troubleshooting

		LEDs on 3RW40				Auxiliary contacts			
		Soft starter		Motor protection		13 14 (ON)		24 23 (BYPASSED)	96 95 98 FAILURE / OVERLOAD
3RW40		DEVICE (rd/gn/ylw)	STATE / BYPASSED / FAILURE (gn/rd)	OVERLOAD (rd)	RESET MODE / AUTO (ylw/gn)				
U _s = 0		●	●	●	●				
Operating state	IN								
Off	0	gn	●	●	●				
Start	1	gn	gn	●	●				
Bypassed	1	gn	gn	●	●				
Stop	0	gn	gn	●	●				
Warning									
I _e / impermissible CLASS setting ²⁾		gn	gn	gn	●				
Start inhibited, device too hot (cooling time may vary according to thyristor temperature) ³⁾		ylw	●	●	●				
Fault									
Impermissible electronics supply voltage ²⁾		●	rd	●	●				
Impermissible I _e / CLASS setting and IN (0 -> 1) ²⁾		gn	rd	gn	●				
Motor protection tripping, overload relay cooling time 60 s / thermistor cooling time may vary according to motor temperature ¹⁾		gn	●		●				
Thermistor motor protection Wire breakage / short-circuit ^{1) 3)}		gn	●		●				
Thermal overload on device ³⁾ (cooling time > 30 s)		ylw	rd	●	●				
- Missing load voltage - Phase failure, missing load ³⁾		gn	rd	●	●				
Device fault (cannot be acknowledged, device defective) ⁵⁾		rd	rd	●	●				
Test function									
Press TEST t>5 s ⁴⁾		gn	●	rd	●				
RESET MODE (press to change)									
Manual RESET		●	●	●	●				
Auto RESET		●	●	●	ylw				
Remote RESET		●	●	●	gn				
LEDs					1) Optional, 3RW40 2. to 3RW40 4. in 24 V AC/DC only				
				gn	ylw	rd	2) Automatically reset if the setting is corrected or when the system returns to normal		
Off	ON	Flashing	Flickering	= Green	= Yellow	= Red	3) Must be acknowledged according to the selected RESET mode 4) Motor protection trip test		
							5) Device fault cannot be acknowledged. Contact your SIEMENS partner or Technical Assistance.		

 WARNING
<p>Automatic restart Can result in death, serious injury, or property damage.</p> <p>The automatic RESET mode (AUTO RESET) must not be used in applications where there is a risk of serious injury to persons or substantial damage to property if the motor starts up again unexpectedly. The start command (e.g. issued by a contact or the PLC) must be reset prior to issuing a RESET command because the motor attempts to restart again automatically following this RESET command if a start command is still present. This particularly applies if the motor protection has tripped. For safety reasons, you are advised to integrate the group fault output on the 3RW40 (terminals 95 and 96), or the signaling contact of the motor or miniature circuit breaker on all devices, in the controller.</p>

Notes on troubleshooting

Warning	Cause	Remedy
Impermissible I _e CLASS setting (control voltage present, no start command)	The rated operational current I _e set for the motor (control voltage present, no start command) exceeds the associated, maximum permissible setting current referred to the selected CLASS setting (chapter Motor current settings [Page 107]).	Check the rated operational current set for the motor, select a lower CLASS setting, or calculate the soft starter with a size allowance. As long as the 3RW40 is not controlled IN (0->1), this is only a status signal. However, it becomes a fault signal if the start command is applied.
Start inhibited, device too hot	The acknowledgment and the motor start are inhibited for a defined time by the inherent device protection following an overload trip, to allow the 3RW40 to cool down. Possible causes <ul style="list-style-type: none"> • Too many starts, • Motor ramp-up time too long, • Ambient temperature in switching device's environment too high, • Minimum installation clearances not complied with. 	The device cannot be started until the temperature of the thyristor or the heat sink has cooled down enough to guarantee sufficient reserve for a successful startup. The time until restarting is allowed can vary but is a minimum of 30 s. Rectify the causes and possibly retrofit the optional fan (3RW40 2. to 3RW40 4.).

Fault	Cause	Remedy
Impermissible electronics supply voltage:	The control supply voltage does not correspond to the soft starter's rated voltage.	Check the control supply voltage; could be caused by a power failure, voltage dip, or incorrect control supply voltage. Use a stabilized power supply unit if due to mains fluctuations.
Impermissible I_e /CLASS setting and IN (0->1) (control voltage present, IN start command changes from 0 to 1)	The rated operational current I_e set for the motor (control voltage present, start command present) exceeds the associated, maximum permissible setting current referred to the selected CLASS setting (chapter Motor current settings [Page 107]). For the maximum permissible settings, refer to chapter "Technical data [Page 121]".	Check the rated operational current set for the motor, select a lower CLASS setting, or calculate the soft starter with a size allowance.
Motor protection tripping Overload relay / thermistor:	The thermal motor model has tripped. After an overload trip, restarting is inhibited until the recovery time has elapsed. - Overload relay tripping time: 60 s - Thermistor tripping time: When the temperature sensor (thermistor) in the motor has cooled down.	<ul style="list-style-type: none"> - Check whether the motor's rated operational current I_e is set correctly, or - Change the CLASS setting, or - Possibly reduce the switching frequency, or - Deactivate the motor protection (CLASS OFF), or - Check the motor and the application.
Thermistor protection: wire breakage / short-circuit (optional for 3RW40 2. to 3RW40 4. devices):	Temperature sensor at terminals T11/ T12/T22 is short-circuited or defective, a cable is not connected, or no sensor is connected.	Check the temperature sensor and the wiring
Thermal overload on the device:	Overload trip of the thermal model for the power unit of the 3RW40 Possible causes <ul style="list-style-type: none"> • Too many starts, • Motor ramp-up time too long, • Ambient temperature in switching device's environment too high, • Minimum installation clearances not complied with. 	Wait until the device has cooled down again, possibly increase the current limiting value set for starting, or reduce the switching frequency (too many consecutive starts). Possibly retrofit the optional fan (3RW40 2. to 3RW40 4.). Check the load and the motor, check whether the ambient temperature in the soft starter's environment is too high (derating above 40 °C, refer to chapter Technical data [Page 121]), comply with the minimum clearances.

Fault	Cause	Remedy
Missing load voltage, phase failure / missing load:	Cause 1: Phase L1 / L2 / L3 is missing or fails / collapses when the motor is operating. Tripped as a result of a dip in the permissible rated operational voltage > 15 % for > 100 ms during the startup process or > 200 ms in bypass mode.	Connect L1 / L2 / L3 or correct the voltage dip.
	Cause 2: The motor that is connected is too small and the fault occurs as soon as it is switched to bypass mode.	Set the correct rated operational current for the connected motor or set it to the minimum value (if the motor current is less than 10 % of the set I_e , the motor cannot be operated with this starter).
	Cause 3: Motor phase T1 / T2 / T3 is not connected.	Connect the motor properly (e.g. jumpers in the motor terminal box, repair switch closed etc.)
Device fault	Soft starter defective.	Contact your SIEMENS partner or Technical Assistance.

Technical data

13.1 3RW30

13.1.1 Overview

SIRIUS 3RW30 soft starters reduce the motor voltage through variable phase angle control and increase it from a selectable starting voltage up to the mains voltage within the ramp time. They limit the starting current and torque, so that the shocks that occur during direct starts or wye-delta starting are avoided. Mechanical loads and mains voltage dips can be effectively prevented in this way.

Soft starting reduces the stress on the connected equipment, resulting in lower wear and therefore longer periods of trouble-free production. The selectable starting voltage means the soft starters can be individually adjusted to the requirements of the application in question and – unlike wye-delta starters – are not restricted to two-stage starting with fixed voltage ratios.

SIRIUS 3RW30 soft starters are characterized above all by their small space requirements. Integral bypass contacts mean that no power loss has to be taken into account at the power semiconductors (thyristors) after the motor has started up. This cuts down on heat losses, enabling a more compact design and making external bypass circuits superfluous.

Soft starters rated up to 55 kW (at 400 V) can be supplied for standard applications in three-phase systems. Extremely small sizes, low power losses and simple startup are just three of the many advantages of this soft starter.

13.1.2 Selection and ordering data for standard applications and normal starting



Ambient temperature 40°C				Ambient temperature 50°C				Size	Normal starting	
Rated operational current I _e ¹⁾	Rated power of three-phase induction motors for rated operational voltage U _e			Rated operational current I _e ¹⁾	Rated power of three-phase induction motors for rated operational voltage U _e					Order No.
A	230 V	400 V	500 V	A	200 V	230 V	460 V	575 V		
	kW	kW	kW		hp	hp	hp	hp		
Rated operational voltage U_e 200 to 480 V²⁾										
• With screw or spring-loaded terminals										
3.6	0.75	1.5	–	3	0.5	0.5	1.5	–	S00	3RW30 13-□BB□4
6.5	1.5	3	–	4.8	1	1	3	–	S00	3RW30 14-□BB□4
9	2.2	4	–	7.8	2	2	5	–	S00	3RW30 16-□BB□4
12.5	3	5.5	–	11	3	3	7.5	–	S00	3RW30 17-□BB□4
17.6	4	7.5	–	17	3	3	10	–	S00	3RW30 18-□BB□4
• With screw terminals										
25	5.5	11	–	23	5	5	15	–	S0	3RW30 26-□BB□4
32	7.5	15	–	29	7.5	7.5	20	–	S0	3RW30 27-□BB□4
38	11	18.5	–	34	10	10	25	–	S0	3RW30 28-□BB□4
• With screw or spring-loaded terminals										
45	11	22	–	42	10	15	30	–	S2	3RW30 36-□BB□4
58	18.5	30	–	58	15	20	40	–	S2	3RW30 37-□BB□4
72	22	37	–	62	20	20	40	–	S2	3RW30 38-□BB□4
• With screw or spring-loaded terminals										
80	22	45	–	73	20	25	50	–	S3	3RW30 46-□BB□4
106	30	55	–	98	30	30	75	–	S3	3RW30 47-□BB□4
Order number supplement for connection types										
• With screw terminals										
• With spring-loaded terminals ³⁾										
Order number supplement for rated control supply voltage U _s										
• 24 V AC/DC										
• 110 to 230 V AC/DC										

1) Standalone assembly without additional fan.
 2) Soft starter with screw terminals.

3) Main circuit connection: screw terminals.

Note

The rated motor current is extremely important when selecting a soft starter.

Refer to the information about selecting soft starters in chapter Configuration [Page 73].

Conditions for normal starting:

Max. ramp time 3 s, starting current 300 %, 20 starts / hour, ON time 30 %, standalone assembly, max. installation altitude 1000 m / 3280 ft, ambient temperature kW 40 °C / 104 °F. A larger model may need to be selected if other conditions and constraints apply or for a higher starting frequency. We recommend using the "Win-Soft Starter" selection and simulation software. For information about the rated currents for ambient temperatures > 40 °C, refer to chapter 3RW30..-BB.. power electronics [Page 124].

13.1.3 3RW30...BB.. control electronics

Type	3RW301., 3RW302.		3RW303., 3RW304.			
Control electronics						
Rated values	Terminal					
Rated control supply voltage	A1 / A2	V	24	110...230	24	110...230
• Tolerance		%	±20	-15/+10	±20	-15/+10
Rated control supply current						
• STANDBY		mA	<50	6	20	<50
• During pickup		mA	<100	15	<4000	<500
• ON		mA	<100	15	20	<50
Rated frequency		Hz	50/60			
• Tolerance		%	±10			
Control input			ON / OFF			
IN						
Power consumption with version			approx. 12			
• 24 V DC		mA	AC: 3/6; DC: 1.5/3			
• 110/230 V AC		mA				
Relay outputs			Operating indication (NO)			
Output 1	ON	13/14				
Rated operational current		A	3AC-15/AC-14 at 230 V, 1DC-13 at 24 V			
Protection against overvoltages			Protection by means of varistor through contact			
Short-circuit protection			4 A gL/gG operational class; 6 A quick (fuse is not included in scope of supply)			
Operating indications		LED	DEVICE	STATE/BYPASSED/ FAILURE	DEVICE	STATE/BYPASSED/ FAILURE
Off			Green	Off	Green	Off
Start			Green	Green flashing	Green	Green flashing
Bypass			Green	Green	Green	Green
Fault signals						
• 24 V DC: $U < 0.75 \times U_s$ or $U > 1.25 \times U_s$			Off	Red	Off	Red
• AC 110...230 V: $U < 0.75 \times U_s$ or $U > 1.15 \times U_s$			Off	Red	Off	Red
Electrical overloading of bypass (reset by removing IN command)			Yellow	Red	Yellow	Red
Missing mains voltage, phase failure / missing load			Green	Red	Green	Red
Device fault			Red	Red	Red	Red

13.1.4 3RW30...BB.. control times and parameters

Type	3RW301...3RW304.		Factory default
Control times and parameters			
Control times			
Closing delay (with connected control voltage)	ms	<50	
Closing delay (automatic / line contactor mode)	ms	<300	
Mains failure bridging time			
Control supply voltage	ms	50	
Mains failure response time ¹⁾			
Load current circuit	ms	500	
Start parameters			
• Ramp-up time	s	0...20	7.5
• Starting voltage	%	40...100	40
Ramp-up detection		No	
Operating mode output 13/14			
Rising edge at	Start command	ON	
Falling edge at	Off command		

1) Mains failure detection only in standby state, not during operation.

13.1 3RW30

13.1.5 3RW30..-BB.. power electronics

Type	3RW301..BB.4...3RW304..BB.4	
Power electronics		
Rated operational voltage	V AC	200...480
Tolerance	%	-15/+10
Rated frequency	Hz	50/60
Tolerance	%	±10
Continuous duty at 40°C (% of I _e)	%	115
Minimum load (% of I _e)	%	10 (at least 2 A)
Maximum cable length between soft starter and motor	m	300
Permissible installation altitude	m	5000 (Derating from 1000, see characteristic curves); higher on request
Permissible mounting position (auxiliary fan not available)		
Permissible ambient temperature	°C	-25...+60; (derating from +40)
Operation	°C	-40...+80
Storage	°C	-40...+80
Degree of protection	IP20 for 3RW30 1. and 3RW30 2.; IP00 for 3RW30 3. and 3RW30 4.	

13.1.6 3RW30 13, 14, 16, 17, 18-BB.. power electronics

Type		3RW3013	3RW3014	3RW3016	3RW3017	3RW3018
Power electronics						
Current carrying capacity rated operating current I _e						
•Acc. to IEC and UL/CSA ¹⁾ , for standalone assembly, AC-53a						
-At 40°C	A	3.6	6.5	9	12.5	17.6
-At 50°C	A	3.3	6	8	12	17
-At 60°C	A	3	5.5	7	11	14
Power loss						
•During operation after startup of the motor at uninterrupted rated operat. curr. (40°C) approx.	W	0,25	0,5	1	2	4
•During starting at 300% I _M (40 °C)	W	24	52	80	80	116
Permissible rated motor current and starts per hour for normal starting (class 10):						
-Rated motor curr. I _M ²⁾ , ramp-up time 3s	A	3.6 / 3.3	6,5 / 6,0	9 / 8	12.5 / 12.0	17.6 / 17.0
-Starts per hour ³⁾	1/h	200 / 150	87 / 60	50 / 50	85 / 70	62 / 46
-Rated motor curr. I _M ²⁾ , ramp-up time 4s	A	3.6 / 3.3	6,5 / 6,0	9 / 8	12.5 / 12.0	17.6 / 17.0
-Starts per hour ³⁾	1/h	150 / 100	64 / 46	35 / 35	62 / 47	45 / 32

1) Measurement at 60°C in accordance with UL/CSA not required.

2) At 300% I_M. Tamb = 40 °C / 50 °C

3) For intermittent duty S4 with ON time 30%, T_{amb}=40°C / 50 °C, vertical standalone assembly. The specified switching frequencies do not apply to automatic mode.

13.1.7 3RW30 26, 27, 28-.BB.. power electronics

Type		3RW3026	3RW3027	3RW3028
Power electronics				
Current carrying capacity rated operating current I_g				
•Acc. to IEC and UL/CSA ¹⁾ , for standalone assembly, AC-53a				
-At 40°C	A	25.3	32.2	38
-At 50°C	A	23	29	34
-At 60°C	A	21	26	31
Power loss				
•During operation after startup of the motor at uninterrupted rated operat. curr.(40°C) approx.				
	W	8	13	19
•During starting at 300% $I_M(40°C)$				
	W	188	220	256
Permissible rated motor current and starts per hour at normal starting (class 10)				
-Rated motor curr. $I_M^{(2)}$, ramp-up time 3s	A	25 / 23	32 / 29	38 / 34
-Starts per hour ³⁾	1/h	23 / 23	23 / 23	19 / 19
-Rated motor curr. $I_M^{(2)}$, ramp-up time 4s	A	25 / 23	32 / 29	38 / 34
-Starts per hour ³⁾	1/h	15 / 15	16 / 16	12 / 12

1) Measurement at 60°C in accordance with UL/CSA not required.

2) At 300% I_M . $T_{amb} = 40\text{ °C} / 50\text{ °C}$

3) For intermittent duty S4 with ON time 30%, $T_{amb} = 40\text{ °C} / 50\text{ °C}$, vertical standalone assembly. The specified switching frequencies do not apply to automatic mode. Factors for permissible switching frequency with different mounting position, direct assembly, side-by-side assembly, see Configuration chapter.

13.1.8 3RW30 36, 37, 38, 46, 47-.BB.. power electronics



Type		3RW3036	3RW3037	3RW3038	3RW3046	3RW3047
Power electronics						
Current carrying capacity rated operating current I_g						
•Acc. to IEC and UL/CSA ¹⁾ , for standalone assembly, AC-53a						
-At 40°C	A	45	65	72	80	106
-At 50°C	A	42	58	62.1	73	98
-At 60°C	A	39	53	60	66	90
Power loss						
•During operation after startup of the motor at uninterrupted rated operat. curr.(40°C) approx.						
	W	6	12	15	12	21
•During starting at 300% $I_M(40°C)$						
	W	316	444	500	576	768
Permissible rated motor current and starts per hour at normal starting (class 10)						
-Rated motor curr. $I_M^{(2)}$, ramp-up time 3s	A	45 / 42	63 / 58	72 / 62	80 / 73	106 / 108
-Starts per hour ³⁾	1/h	38 / 38	23 / 23	22 / 22	22 / 22	15 / 15
-Rated motor curr. $I_M^{(2)}$, ramp-up time 4s	A	45 / 42	63 / 58	72 / 62	80 / 73	106 / 98
-Starts per hour ³⁾	1/h	26 / 26	15 / 15	15 / 15	15 / 15	10 / 10

1) Measurement at 60°C in accordance with UL/CSA not required.

2) At 300% I_M . $T_{amb} = 40\text{ °C} / 50\text{ °C}$

3) For intermittent duty S4 with ON time 70%, $T_{amb} = 40\text{ °C} / 50\text{ °C}$, vertical standalone assembly. The specified switching frequencies do not apply to automatic mode.

13.1.9 3RW30 main conductor cross-sections

Soft starter	Type		3RW301.	3RW302.	3RW303.	3RW304.
Conductor cross-sections						
Screw terminals	Main conductors					
 Front clamping point connected	• Solid	mm ²	2 x (1...2.5); 2 x (2.5...6) acc. to IEC 60947	2 x (1...2.5); 2 x (2.5...6) acc. to IEC 60947; max. 1 x 10	2 x (1.5...16)	2 x (2.5...16)
	• Finely stranded with end sleeve	mm ²	2 x (1.5...2.5); 2 x (2.5...6)	2 x (1...2.5); 2 x (2.5...6)	1 x (0.75...25)	1 x (2.5...35)
	• Stranded	mm ²	–	–	1 x (0.75...35)	1 x (4...70)
	• AWG cables - Solid - Solid or stranded - Stranded	AWG AWG AWG	2 x (16 ... 12) 2 x (14...10) 1 x 8	2 x (16 ... 12) 2 x (14...10) 1 x 8	–	1 x (10...2/0)
 Rear clamping point connected	• Solid	mm ²	–	–	2 x (1.5...16)	2 x (2.5...16)
	• Finely stranded with end sleeve	mm ²	–	–	1 x (1.5...25)	1 x (2.5...50)
	• Stranded	mm ²	–	–	1 x (1.5...35)	1 x (10...70)
	• AWG cables - Solid or stranded	AWG	–	–	1 x (16...2)	1 x (10...2/0)
 Both clamping points connected	• Solid	mm ²	–	–	2 x (1.5...16)	2 x (2.5...16)
	• Stranded	mm ²	–	–	2 x (1.5...25)	2 x (10...50)
	• Finely stranded with end sleeve	mm ²	–	–	2 x (1.5...16)	2 x (2.5...35)
	• AWG cables - Solid or stranded	AWG	–	–	2 x (16...2)	2 x (10...1/0)
	• Tightening torque	Nm lb.in	2...2.5 18...22	2...2.5 18...22	4.5 40	6.5 58
	Tools		PZ2	PZ2	PZ2	Allen screw 4 mm
	Degree of protection		IP20	IP20	IP20 (terminal compartment IP00)	IP20 (terminal compartment IP00)
Spring-loaded terminals	Main conductors					
	• Solid	mm ²	1...4	1...10	–	–
	• Finely stranded with end sleeve	mm ²	1...2.5	1...6; end sleeves, without plastic collar	–	–
	• AWG cables - Solid or stranded (finely stranded) - Stranded	AWG AWG	16...14 16...12	16...10 1 x 8	– –	– –
	Tools		DIN ISO 2380- 1A0; 5 x 3	DIN ISO 2380- 1A0; 5 x 3	–	–
	Degree of protection		IP20	IP20	–	–
Busbar connections	Main conductors					
	• With cable lug according to DIN 46234 or max. 20 mm wide					
	- Stranded	mm ²	–	–	–	2 x (10...70)
	- Finely-stranded	mm ²	–	–	–	2 x (10...50)
	• AWG cables, solid or stranded	AWG	–	–	–	2 x (7...1/0)

13.1.10 3RW30 auxiliary conductor cross-sections

Soft starters	Type	3RW301....3RW304.	
Conductor cross-sections			
Auxiliary conductors (1 or 2 conductors can be connected):			
	Screw terminals		
	• Solid	mm ²	2 x (0.5...2.5)
	• Finely stranded with end sleeve	mm ²	2 x (0.5...1.5)
	• AWG cables		
	- Solid or stranded	AWG	2 x (20...14)
	- Finely stranded with end sleeve	AWG	2 x (20...16)
	• Terminal screws		
	- Tightening torque	Nm lb.in	0.8...1.2 7...10.3
	Spring-loaded terminals		
	• Solid	mm ²	2 x (0.25...2.5)
	• Finely stranded with end sleeve	mm ²	2 x (0.25...1.25)
	• AWG cables, solid or stranded	AWG	2 x (24...14)

13.1.11 Electromagnetic compatibility according to EN 60947-4-2

	Standard	Parameters
Electromagnetic compatibility according to EN 60947-4-2		
<i>EMC interference immunity</i>		
Electrostatic discharge (ESD)	EN 61000-4-2	±4 kV contact discharge, ±8 kV air discharge
Electromagnetic RF fields	EN 61000-4-3	Frequency range: 80 to 2000 MHz with 80% at 1 kHz Degree of severity 3: 10 V/m
Conducted RF interference	EN 61000-4-6	Frequency range: 150 kHz...80 MHz with 80% at 1 kHz Interference 10 V
RF voltages and RF currents on cables		
• Burst	EN 61000-4-4	±2 kV / 5 kHz
• Surge	EN 61000-4-5	±1 kV line to line ±2 kV line to ground
<i>EMC interference emission</i>		
EMC interference field strength	EN 55011	Limit value of Class A at 30...1000 MHz, Limit value of Class B for 3RW302.; 24 V AC/DC
Radio interference voltage	EN 55011	Limit value of Class A at 0.15...30 MHz, Limit value of Class B for 3RW302.; 24 V AC/DC
<i>Radio interference suppression filters</i>		
Degree of noise suppression A (industrial applications)	Not required	
Degree of noise suppression B (applications for residential areas)		
Control voltage		
• 230 V AC/DC	Not available ¹⁾	
• 24 V AC/DC	Not required for 3RW301. and 3RW302; Required for 3RW303. and 3RW304. (see table)	

1) Degree of noise suppression B cannot be obtained through the use of filters as the strength of the electromagnetic field is not attenuated by the filter.

13.1.12 Recommended filters

Soft starter types	Nominal current Soft starter A	Recommended filters ¹⁾		
		Filter types	Nominal current filters A	Terminals mm ²
3RW30 36	45	4EF1512-1AA10	50	16
3RW30 37	63	4EF1512-2AA10	66	25
3RW30 38	72	4EF1512-3AA10	90	25
3RW30 46	80	4EF1512-3AA10	90	25
3RW30 47	106	4EF1512-4AA10	120	50

1) The radio interference suppression filter is used to remove the conducted interference from the main circuit. The field-related emissions comply with degree of noise suppression B. The filter should be selected under standard conditions: 10 starts per hour, ramp-up time 4 s at 300% I_e

13.1.13 Types of coordination

Types of coordination

The type of coordination according to which the motor feeder with soft starter is mounted depends on the application-specific requirements. Normally, fuseless mounting (combination of motor starter protector and soft starter) is sufficient.

If type of coordination 2 needs to be fulfilled, semiconductor fuses must be fitted in the motor feeder.

- T_{OC}
1 Type of coordination 1 in accordance with IEC 60947-4-1:
 The device is defective following a short-circuit failure and therefore unsuitable for further use. (Personnel and equipment must not be put at risk).
- T_{OC}
2 Type of coordination 2 in accordance with IEC 60947-4-1:
 The device is suitable for further use following a short-circuit failure. (Personnel and equipment must not be put at risk).
 The type of coordination only refers to soft starters in conjunction with the stipulated protective device (motor starter protector / fuse), not to additional components in the feeder.

13.1.14 Fuseless version

Fuseless version

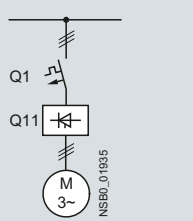

Soft starters ToC 1 Q11	Nominal current	Motor starter protectors ¹⁾		$I_{q \max}$ kA	Rated current A
Type	A	Type			
Type of coordination ²⁾					
3RW30 03	3	3RV1011-1EA10	3RV20 11-1EA (provis.)	50	4
3RW30 13	3.6	3RV1021-1FA10	3RV20 11-1FA	10	5
3RW30 14	6.5	3RV1021-1HA10	3RV20 11-1HA	10	8
3RW30 16	9	3RV1021-1JA10	3RV20 11-1JA	10	10
3RW30 17	12.5	3RV1021-1KA10	3RV20 11-1KA	10	12.5
3RW30 18	17.6	3RV1021-4BA10	3RV20 21-4BA	10	20
3RW30 26	25	3RV1021-4DA10	3RV20 21-4DA	55	25
3RW30 27	32	3RV1031-4EA10	3RV20 21-4EA	55	32
3RW30 28	38	3RV1031-4FA10	3RV20 21-4FA	55	40
3RW30 36	45	3RV1031-4GA10		20	45
3RW30 37	63	3RV1041-4JA10		20	63
3RW30 38	72	3RV1041-4KA10		20	75
3RW30 46	80	3RV1041-4LA10		11	90
3RW30 47	106	3RV1041-4MA10		11	100

¹⁾ The rated motor current must be considered when selecting the devices.

²⁾ The types of coordination are described in chapter Types of coordination [Page 128].

13.1.15 Fused version (line protection only)

Fused version (line protection only)

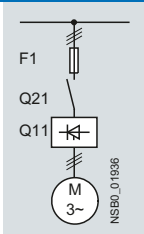

Soft starters Q11 Type	Nominal current A	Line protection, maximum F1 Type	Rated current A	Size	Line contactors (optional) Q21
Type of coordination 1 ¹⁾ : I _q = 65 kA at 480 V + 10%					
3RW30 03 ²⁾	3	3NA3805 ³⁾	20	000	3RT10 15 3RT20 15
3RW30 13	3.6	3NA3803-6	10	000	3RT10 15 3RT20 15
3RW30 14	6.5	3NA3805-6	16	000	3RT10 15 3RT20 15
3RW30 16	9	3NA3807-6	20	000	3RT10 16 3RT20 16
3RW30 17	12.5	3NA3810-6	25	000	3RT10 24 3RT20 18
3RW30 18	17.6	3NA3814-6	35	000	3RT10 26 3RT20 26
3RW30 26	25	3NA3822-6	63	00	3RT10 26 3RT20 26
3RW30 27	32	3NA3824-6	80	00	3RT10 34 3RT20 27
3RW30 28	38	3NA3824-6	80	00	3RT10 35 3RT20 28
3RW30 36	45	3NA3130-6	100	1	3RT10 36
3RW30 37	63	3NA3132-6	125	1	3RT10 44
3RW30 38	72	3NA3132-6	125	1	3RT10 45
3RW30 46	80	3NA3136-6	160	1	3RT10 45
3RW30 47	106	3NA3136-6	160	1	3RT10 46

1) The types of coordination are described in chapter Types of coordination [Page 128]. Type of coordination 1 only refers to soft starters in conjunction with the stipulated protective device (motor starter protector / fuse), not to any additional components in the feeder.

2) I_q = 50 kA at 400 V.

3) 3NA3 805-1 (NH00), 5SB2 61 (DIAZED), 5SE2 201-6 (NEOZED).

13.1.16 Fused version with SITOR 3NE1 fuses

Assembly as for type of coordination 2, with SITOR all-range fuses (F'1) for combined thyristor and line protection.

Fused version with SITOR 3NE1 fuses (semiconductor and line protection)

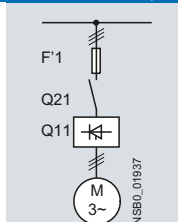

For suitable fuse bases, refer to "SENTRON switching and protecting devices for power distribution" —> "Switch disconnectors" in the LV1 Catalog and to "BETA protecting" —> "SITOR semiconductor fuses" the ET B1 Catalog or consult www.siemens.de/sitor

Soft starters Q11 Type	Nominal current A	All-range fuses F'1 Type	Rated current A	Size	Line contactors (optional) Q21	
Type of coordination 2 ¹⁾ : I _q = 65 kA at 480 V + 10%						
3RW30 03 ²⁾	3	3NE1813-0 ³⁾	16	000	3RT10 15	3RT20 15
3RW30 13	3.6	3NE1813-0	16	000	3RT10 15	3RT20 15
3RW30 14	6.5	3NE1813-0	16	000	3RT10 15	3RT20 15
3RW30 16	9	3NE1813-0	16	000	3RT10 16	3RT20 16
3RW30 17	12.5	3NE1813-0	16	000	3RT10 24	3RT20 18
3RW30 18	17.6	3NE1814-0	20	000	3RT10 26	3RT20 26
3RW30 26	25	3NE1803-0	35	000	3RT10 26	3RT20 26
3RW30 27	32	3NE1020-2	80	00	3RT10 34	3RT20 27
3RW30 28	38	3NE1020-2	80	00	3RT10 35	3RT20 28
3RW30 36	45	3NE1020-2	80	00	3RT10 36	
3RW30 37	63	3NE1820-0	80	000	3RT10 44	
3RW30 38	72	3NE1820-0	80	000	3RT10 45	
3RW30 46	80	3NE1021-0	100	00	3RT10 45	
3RW30 47	106	3NE1022-0	125	00	3RT10 46	

1) The types of coordination are described in chapter Types of coordination [Page 128]. Type of coordination 2 only refers to soft starters in conjunction with the stipulated protective device (motor starter protector / fuse), not to additional components in the feeder.

2) I_q = 50 kA at 400 V.

3) No SITOR fuse required!
Alternatively: 3NA3 803 (NH00), 5SB2 21 (DIAZED), 5SE2 206 (NEOZED)

13.1.17 Fused version with SITOR 3NE3/4/8 fuses

Assembly as for type of coordination 2, with additional SITOR fuses (F3) for thyristor protection only.

Fused version with 3NE3 SITOR fuses (semiconductor protection by fuse, line, and overload protection by motor starter protector; alternatively, installation with contactor and overload relay possible)

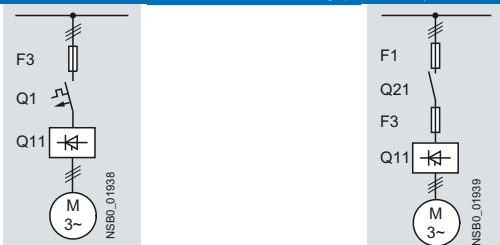

For suitable fuse bases, refer to "SENTRON switching and protecting devices for power distribution" -> "Switch disconnectors" the LV1 Catalog and to "BETA protecting" -> "SITOR semiconductor fuses" in the ET B1 Catalog or consult www.siemens.de/sitor

Soft starters Q11 Type	Nominal current A	Semiconductor fuses, minimum			Semiconductor fuses, maximum			Semiconductor fuses, minimum		
		F3 Type	Rated current A	Size	F3 Type	Rated current A	Size	F3 Type	Rated current A	Size
Type of coordination 2 ¹⁾ : I _q = 65 kA at 480 V + 10%										
3RW30 03 ²⁾	3	-	-	-	-	-	-	-	-	-
3RW30 13	3.6	-	-	-	-	-	-	3NE4101	32	0
3RW30 14	6.5	-	-	-	-	-	-	3NE4101	32	0
3RW30 16	9	-	-	-	-	-	-	3NE4101	32	0
3RW30 17	12.5	-	-	-	-	-	-	3NE4101	32	0
3RW30 18	17.6	-	-	-	3NE3221	100	1	3NE4101	32	0
3RW30 26	25	-	-	-	3NE3221	100	1	3NE4102	40	0
3RW30 27	32	-	-	-	3NE3222	125	1	3NE4118	63	0
3RW30 28	38	-	-	-	3NE3222	125	1	3NE4118	63	0
3RW30 36	45	-	-	-	3NE3224	160	1	3NE4120	80	0
3RW30 37	63	-	-	-	3NE3225	200	1	3NE4121	100	0
3RW30 38	72	3NE3221	100	1	3NE3227	250	1	-	-	-
3RW30 46	80	3NE3222	125	1	3NE3225	200	1	-	-	-
3RW30 47	106	3NE3224	160	1	3NE3231	350	1	-	-	-

Soft starters Q11 Type	Nominal current A	Semiconductor fuses, max.			Semiconductor fuses, min.			Semiconductor fuses, max.			Cylindrical fuses	
		F3 Type	Rated current A	Size	F3 Type	Rated current A	Size	F3 Type	Rated current A	Size	F3 Type	Rated current A
Type of coordination 2 ¹⁾ : I _q = 65 kA at 480 V + 10%												
3RW30 03 ²⁾	3	-	-	-	3NE8015-1	25	00	3NE8015-1	25	00	3NC1010	10
3RW30 13	3.6	-	-	-	3NE8015-1	25	00	3NE8015-1	25	00	3NC2220	20
3RW30 14	6.5	-	-	-	3NE8015-1	25	00	3NE8015-1	25	00	3NC2220	20
3RW30 16	9	-	-	-	3NE8015-1	25	00	3NE8015-1	25	00	3NC2220	20
3RW30 17	12.5	-	-	-	3NE8015-1	25	00	3NE8018-1	63	00	3NC2250	50
3RW30 18	17.6	-	-	-	3NE8003-1	35	00	3NE8021-1	100	00	3NC2263	63
3RW30 26	25	3NE4117	50	0	3NE8017-1	50	00	3NE8021-1	100	00	3NC2263	63
3RW30 27	32	3NE4118	63	0	3NE8018-1	63	00	3NE8022-1	125	00	3NC2280	80
3RW30 28	38	3NE4118	63	0	3NE8020-1	80	00	3NE8022-1	125	00	3NC2280	80
3RW30 36	45	3NE4120	80	0	3NE8020-1	80	00	3NE8024-1	160	00	3NC2280	80
3RW30 37	63	3NE4121	100	0	3NE8021-1	100	00	3NE8024-1	160	00	-	-
3RW30 38	72	-	-	-	3NE8022-1	125	00	3NE8024-1	160	00	-	-
3RW30 46	80	-	-	-	3NE8022-1	125	00	3NE8024-1	160	00	-	-
3RW30 47	106	-	-	-	3NE8024-1	160	00	3NE8024-1	160	00	-	-

Soft starters TOC 2	Nominal current	Line contactors (optional)		Motor starter protectors 400 V +10%		Line protection, maximum			
						Rated current	Rated current	Size	
Q11 Type	A	Q21		Q1 Type		A	F1 Type	A	
Type of coordination 2 ¹⁾ : I _q = 65 kA at 480 V + 10%									
3RW30 03 ²⁾	3	3RT10 15	3RT20 15	3RV1011-1EA10	3RV20 11-1EA (provis.)	4	3NA3805 ³⁾	20	000
3RW30 13	3.6	3RT10 15	3RT20 15	3RV1021-1FA10	3RV20 11-1FA	5	3NA3803-6	10	000
3RW30 14	6.5	3RT10 15	3RT20 15	3RV1021-1HA10	3RV20 11-1HA	8	3NA3805-6	16	000
3RW30 16	9	3RT10 16	3RT20 16	3RV1021-1JA10	3RV20 11-1JA	10	3NA3807-6	20	000
3RW30 17	12.5	3RT10 24	3RT20 18	3RV1021-1KA10	3RV20 11-1KA	12.5	3NA3810-6	25	000
3RW30 18	17.6	3RT10 26	3RT20 26	3RV1021-1BA10	3RV20 21-4BA	20	3NA3814-6	35	000
3RW30 26	25	3RT10 26	3RT10 26	3RV1031-4DA10	3RV20 21-4DA	25	3NA3822-6	63	00
3RW30 27	32	3RT10 34	3RT20 27	3RV1031-4EA10	3RV20 21-4EA	32	3NA3824-6	80	00
3RW30 28	38	3RT10 35	3RT20 28	3RV1031-4EA10	3RV20 21-4FA	40	3NA3824-6	80	00
3RW30 36	45	3RT10 36		3RV1031-4GA10		45	3NA3130-6	100	1
3RW30 37	63	3RT10 44		3RV1041-4JA10		63	3NA3132-6	125	1
3RW30 38	72	3RT10 45		3RV1041-4KA10		75	3NA3132-6	125	1
3RW30 46	80	3RT10 45		3RV1041-4LA10		90	3NA3136-6	160	1
3RW30 47	106	3RT10 46		3RV1041-4MA10		100	3NA3136-6	160	1

1) The types of coordination are described in chapter Types of coordination [Page 128].
 Type of coordination 2 only refers to soft starters in conjunction with the stipulated protective device (motor starter protector / fuse), not to additional components in the feeder.

2) I_q = 50 kA at 400 V.

13.2 3RW40

13.2.1 Overview

SIRIUS 3RW40 soft starters have all the same advantages as the 3RW30 soft starters.

SIRIUS 3RW40 soft starters are characterized above all by their small space requirements. Integral bypass contacts mean that no power loss has to be taken into account at the power semiconductors (thyristors) after the motor has started up. This cuts down on heat losses, enabling a more compact design and making external bypass circuits superfluous.

At the same time, this soft starter comes with additional integrated functions such as settable current limiting, motor overload and intrinsic device protection, and optional thermistor motor protection. The higher the motor rating, the more important these functions become because they make it unnecessary to purchase and install protection equipment (such as overload relays).

Internal intrinsic device protection prevents thermal overloading of the thyristors and the power unit defects this can cause. As an option, the thyristors can also be protected against short-circuiting with semiconductor fuses.

Thanks to integrated status and fault monitoring, this compact soft starter offers many different diagnostics options. Up to four LEDs and relay outputs permit differentiated monitoring and diagnostics of the operating mechanism by indicating the operating state as well as, for example, mains or phase failures, missing load, impermissible tripping times / CLASS settings, thermal overloading, or device faults.

Soft starters rated up to 250 kW (at 400 V) can be supplied for standard applications in three-phase systems. Extremely small sizes, low power losses, and simple commissioning are just three of the many advantages of the SIRIUS 3RW40 soft starters.

"Increased safety" type of protection EEx e according to ATEX Directive 94/9/EC

The SIRIUS 3RW40 soft starter sizes S0 to S12 are suitable for starting explosion-proof motors with the "increased safety" type of protection EEx e.

13.2.2 Selection and ordering data for standard applications and normal starting (CLASS 10)



3RW40 28-1BB14



3RW40 38-1BB14



3RW40 47-1BB14

Ambient temperature 40°C				Ambient temperature 50°C				Size	Normal starting	
Rated operational current $I_e^{1)}$	Rated power of three-phase induction motors for rated operational voltage U_e			Rated operational current $I_e^{1)}$	Rated power of three-phase induction motors for rated operational voltage U_e					
	230 V	400 V	500 V		200 V	230 V	460 V	575 V		
A	kW	kW	kW	A	hp	hp	hp	hp	Order No.	
Rated operational voltage U_e 200 to 480 V²⁾										
• With screw or spring-loaded terminals										
12.5	3	5.5	–	11	3	3	7.5	–	S0	3RW40 24-□BB□4
25	5.5	11	–	23	5	5	15	–	S0	3RW40 26-□BB□4
32	7.5	15	–	29	7.5	7.5	20	–	S0	3RW40 27-□BB□4
38	11	18.5	–	34	10	10	25	–	S0	3RW40 28-□BB□4
• With screw or spring-loaded terminals										
45	11	22	–	42	10	15	30	–	S2	3RW40 36-□BB□4
58	18.5	30	–	58	15	20	40	–	S2	3RW40 37-□BB□4
72	22	37	–	62	20	20	40	–	S2	3RW40 38-□BB□4
• With screw or spring-loaded terminals										
80	22	45	–	73	20	25	50	–	S3	3RW40 46-□BB□4
106	30	55	–	98	30	30	75	–	S3	3RW40 47-□BB□4
Rated operational voltage U_e 400 to 600 V²⁾										
• With screw or spring-loaded terminals										
12.5	–	5.5	7.5	11	–	–	7.5	10	S0	3RW40 24-□BB□5
25	–	11	15	23	–	–	15	20	S0	3RW40 26-□BB□5
32	–	15	18.5	29	–	–	20	25	S0	3RW40 27-□BB□5
38	–	18.5	22	34	–	–	25	30	S0	3RW40 28-□BB□5
• With screw or spring-loaded terminals										
45	–	22	30	42	–	–	30	40	S2	3RW40 36-□BB□5
58	–	30	37	58	–	–	40	50	S2	3RW40 37-□BB□5
72	–	37	45	62	–	–	40	60	S2	3RW40 38-□BB□5
• With screw or spring-loaded terminals										
80	–	45	55	73	–	–	50	60	S3	3RW40 46-□BB□5
106	–	55	75	98	–	–	75	75	S3	3RW40 47-□BB□5
Order number supplement for connection types										
• With screw terminals										
• With spring-loaded terminals ³⁾										
Order number supplement for rated control supply voltage U_s										
• 24 V AC/DC										
• 110 to 230 V AC/DC										

1
2

0
1

1) Standalone assembly without additional fan.

2) Soft starter with screw terminals.

3) Main circuit connection: screw terminals.

Note

The rated motor current is extremely important when selecting a soft starter.

Refer to the information about selecting soft starters in chapter Configuration [Page 73].

Conditions for normal starting (CLASS 10):

Max. ramp-up time 10 s, current limiting 300 %, 5 starts / hour, ON time 30 %, standalone assembly, max. installation altitude 1000 m / 3280 ft, ambient temperature kW 40 °C / 104 °F.

A larger model may need to be selected if other conditions and constraints apply or for a higher starting frequency. We recommend using the "Win-Soft Starter" selection and simulation software. For information about the rated currents for ambient temperatures > 40 °C, refer to chapter 3RW40 2. to 7. power electronics [Page 148].

13.2.3 Selection and ordering data for standard applications and normal starting (CLASS 10) (with thermistor motor protection evaluation)



3RW40 28-1TB04



3RW40 38-1TB04



3RW40 47-1TB04

Ambient temperature 40°C				Ambient temperature 50°C				Size	Normal starting (CLASS 10)	
Rated operational current I _e ¹⁾	Rated power of three-phase induction motors for rated operational voltage U _e			Rated operational current I _e ¹⁾	Rated power of three-phase induction motors for rated operational voltage U _e					
	230 V	400 V	500 V		200 V	230 V	460 V	575 V	Order No.	
A	kW	kW	kW	A	hp	hp	hp	hp		
Rated operational voltage U _e 200 to 480 V ²⁾ , with thermistor motor protection, rated control supply voltage U _c 24 V AC/DC										
• With screw or spring-loaded terminals										
12.5	3	5.5	–	11	3	3	7.5	–	S0	3RW40 24-□TB04
25	5.5	11	–	23	5	5	15	–	S0	3RW40 26-□TB04
32	7.5	15	–	29	7.5	7.5	20	–	S0	3RW40 27-□TB04
38	11	18.5	–	34	10	10	25	–	S0	3RW40 28-□TB04
• With screw or spring-loaded terminals										
45	11	22	–	42	10	15	30	–	S2	3RW40 36-□TB04
63	18.5	30	–	58	15	20	40	–	S2	3RW40 37-□TB04
72	22	37	–	62	20	20	40	–	S2	3RW40 38-□TB04
• With screw or spring-loaded terminals										
80	22	45	–	73	20	25	50	–	S3	3RW40 46-□TB04
106	30	55	–	98	30	30	75	–	S3	3RW40 47-□TB04
Rated operational voltage U _e 400 to 600 V, with thermistor motor protection, rated control supply voltage U _c 24 V AC/DC										
• With screw or spring-loaded terminals										
12.5	–	5.5	7.5	11	–	–	7.5	10	S0	3RW40 24-□TB05
25	–	11	15	23	–	–	15	20	S0	3RW40 26-□TB05
32	–	15	18.5	29	–	–	20	25	S0	3RW40 27-□TB05
38	–	18.5	22	34	–	–	25	30	S0	3RW40 28-□TB05
• With screw or spring-loaded terminals										
45	–	22	30	42	–	–	30	40	S2	3RW40 36-□TB05
63	–	30	37	58	–	–	40	50	S2	3RW40 37-□TB05
72	–	37	45	62	–	–	40	60	S2	3RW40 38-□TB05
• With screw or spring-loaded terminals										
80	–	45	55	73	–	–	50	60	S3	3RW40 46-□TB05
106	–	55	75	98	–	–	75	75	S3	3RW40 47-□TB05
Order number supplement for connection types										
• With screw terminals										
• With spring-loaded terminals ³⁾										

1) Standalone assembly without additional fan.

2) Soft starter with screw terminals.

3) Main circuit connection: screw terminals.

1
2

Note

The rated motor current is extremely important when selecting a soft starter.

Refer to the information about selecting soft starters in chapter Configuration [Page 73].

Conditions for normal starting (CLASS 10):

Max. ramp-up time 10 s, current limiting 300 %, 5 starts / hour, ON time 30 %, standalone assembly, max. installation altitude 1000 m / 3280 ft, ambient temperature kW 40 °C / 104 °F. A larger model may need to be selected if other conditions and constraints apply or for a higher starting frequency. We recommend using the "Win-Soft Starter" selection and simulation software. For information about the rated currents for ambient temperatures > 40 °C, refer to chapter 3RW40 2. to 7. power electronics [Page 148].

13.2.4 Selection and ordering data for standard applications and normal starting (CLASS 10)



3RW40 56-6BB44



3RW40 76-6BB44

Ambient temperature 40°C				Ambient temperature 50°C				Size	Normal starting (CLASS 10)	
Rated operational current $I_e^{1)}$	Rated power of three-phase induction motors for rated operational voltage U_e			Rated operational current $I_e^{1)}$	Rated power of three-phase induction motors for rated operational voltage U_e					
	230 V	400 V	500 V		200 V	230 V	460 V	575 V		
A	kW	kW	kW	A	hp	hp	hp	hp	Order No.	
Rated operational voltage U_e 200 to 460 V²⁾										
• With screw or spring-loaded terminals										
134	37	75	–	117	30	40	75	–	S6	3RW40 55-□BB□4
162	45	30	–	145	40	50	100	–		3RW40 56-□BB□4
• With screw or spring-loaded terminals										
230	75	132	–	205	60	75	150	–	S12	3RW40 73-□BB□4
280	90	160	–	248	75	100	200	–		3RW40 74-□BB□4
356	110	200	–	315	100	125	250	–		3RW40 75-□BB□4
432	132	250	–	385	125	150	300	–		3RW40 76-□BB□4
Rated operational voltage U_e 400 to 600 V²⁾										
• With screw or spring-loaded terminals										
134	–	75	90	117	–	–	75	100	S6	3RW40 55-□BB□5
162	–	90	110	145	–	–	100	150		3RW40 56-□BB□5
• With screw or spring-loaded terminals										
230	–	132	160	205	–	–	150	200	S12	3RW40 73-□BB□5
280	–	160	200	248	–	–	200	250		3RW40 74-□BB□5
356	–	200	250	315	–	–	250	300		3RW40 75-□BB□5
432	–	250	315	385	–	–	300	400		3RW40 76-□BB□5

Order number supplement for connection types³⁾

- With spring-loaded terminals
- With screw terminals

Order number supplement for rated control supply voltage $U_s^{4)}$

- 115 V AC
- 230 V AC

1) Standalone assembly.

2) Soft starter with screw terminals.

3) Main circuit connection: busbar connection.

4) Control by way of the internal 24 V DC supply or direct control by means of PLC possible

2
6

3
4

Note

The rated motor current is extremely important when selecting a soft starter.

Refer to the information about selecting soft starters in chapter Configuration [Page 73].

Conditions for normal starting (CLASS 10):

Max. ramp-up time 10 s, current limiting 300 %, 5 starts / hour, ON time 30 %, standalone assembly, max. installation altitude 1000 m / 3280 ft, ambient temperature kW 40°C / 104 °F.

A larger model may need to be selected if other conditions and constraints apply or for a higher starting frequency. We recommend using the "Win-Soft Starter" selection and simulation software. For information about the rated currents for ambient temperatures > 40 °C, refer to chapter 3RW40 2. to 7. power electronics [Page 148].

13.2.5 Selection and ordering data for standard applications and heavy-duty starting (CLASS 20)



3RW40 28-1BB14 3RW40 28-1TB04 3RW40 38-1BB14 3RW40 38-1TB04 3RW40 47-1BB14 3RW40 47-1TB04

Ambient temperature 40°C				Ambient temperature 50°C				Size	Heavy-duty starting (CLASS 20)	
Rated operational current $I_e^{1)}$	Rated power of three-phase induction motors for rated operational voltage U_e			Rated operational current $I_e^{1)}$	Rated power of three-phase induction motors for rated operational voltage U_e					
	230 V	400 V	500 V		200 V	230 V	460 V	575 V		
A	kW	kW	kW	A	hp	hp	hp	hp	Order No.	
Rated operational voltage U_e 200 to 480 V²⁾										
• With screw or spring-loaded terminals										
12.5	3	5.5	–	11	3	3	7.5	–	S0	3RW40 26-□□B□4
25	5.5	11	–	23	5	5	15	–	S0	3RW40 27-□□B□4
32	7.5	15	–	29	7.5	7.5	20	–	S2	3RW40 36-□□B□4
38	11	18.5	–	34	10	10	25	–	S2	3RW40 37-□□B□4
45	11	22	–	42	10	15	30	–	S2	3RW40 37-□□B□4
63	18.5	30	–	58	15	20	40	–	S3	3RW40 47-□□B□4
72	22	37	–	62	20	20	40	–	S3	3RW40 47-□□B□4
Rated operational voltage U_e 400 to 600 V										
• With screw or spring-loaded terminals										
12.5	–	5.5	7.5	11	–	–	7.5	10	S0	3RW40 26-□□B□5
25	–	11	15	23	–	–	15	20	S0	3RW40 27-□□B□5
32	–	15	18.5	29	–	–	20	25	S2	3RW40 36-□□B□5
38	–	18.5	22	34	–	–	25	30	S2	3RW40 37-□□B□5
45	–	22	30	42	–	–	30	40	S2	3RW40 37-□□B□5
63	–	30	37	58	–	–	40	50	S3	3RW40 47-□□B□5
72	–	37	45	62	–	–	40	60	S3	3RW40 47-□□B□5

Order number supplement for connection types

- With screw terminals
- With spring-loaded terminals³⁾

Order number supplement for thermistor motor protection

- Standard function
- Thermistor motor protection only with rated control supply voltage U_s 24 V AC/DC

Order number supplement for rated control supply voltage U_s

- 24 V AC/DC
- 110...230 V AC/DC

¹⁾ Standalone assembly without additional fan.

²⁾ Soft starter with screw terminals.

³⁾ Main circuit connection: screw terminals.

1
2

B
T 0

0
1

Note

The rated motor current is extremely important when selecting a soft starter.

Refer to the information about selecting soft starters in chapter Configuration [Page 73].

Conditions for normal starting (CLASS 10):

Max. ramp-up time 20 s, current limiting 300 %, 5 starts / hour, ON time 30 %, standalone assembly, max. installation altitude 1000 m / 3280 ft, ambient temperature kW 40 °C / 104°.

A larger model may need to be selected if other conditions and constraints apply or for a higher starting frequency. We recommend using the "Win-Soft Starter" selection and simulation software. For information about the rated currents for ambient temperatures > 40 °C, refer to chapter 3RW40 24, 26, 27, 28 power electronics [Page 149].

13.2.6 Selection and ordering data for standard applications and heavy-duty starting (CLASS 20)



3RW40 56-6BB44



3RW40 76-6BB44

Ambient temperature 40°C				Ambient temperature 50°C				Size	Heavy-duty starting (CLASS 20)	
Rated operational current $I_e^{1)}$	Rated power of three-phase induction motors for rated operational voltage U_e			Rated operational current $I_e^{1)}$	Rated power of three-phase induction motors for rated operational voltage U_e					
	230 V	400 V	500 V		200 V	230 V	460 V	575 V	Order No.	
A	kW	kW	kW	A	hp	hp	hp	hp		
Rated operational voltage U_e 200 to 460 V²⁾										
• With screw or spring-loaded terminals										
80	22	45	–	73	20	25	50	–	S6	3RW40 55-□BB□4
106	30	55	–	98	25	30	60	–	S6	3RW40 55-□BB□4
134	37	75	–	117	30	40	75	–	S6	3RW40 56-□BB□4
162	45	90	–	145	40	50	100	–	S12	3RW40 73-□BB□4
230	75	132	–	205	60	75	150	–	S12	3RW40 74-□BB□4
280	90	160	–	248	75	100	200	–	S12	3RW40 75-□BB□4
356	110	200	–	315	100	125	250	–	S12	3RW40 76-□BB□4
Rated operational voltage U_e 400 to 600 V²⁾										
• With screw or spring-loaded terminals										
80	–	45	55	73	–	–	50	60	S6	3RW40 55-□BB□5
106	–	55	75	98	–	–	60	75	S6	3RW40 55-□BB□5
134	–	75	90	117	–	–	75	100	S6	3RW40 56-□BB□5
162	–	90	110	145	–	–	100	150	S12	3RW40 73-□BB□5
230	–	132	160	205	–	–	150	200	S12	3RW40 74-□BB□5
280	–	160	200	248	–	–	200	250	S12	3RW40 75-□BB□5
356	–	200	250	315	–	–	250	300	S12	3RW40 76-□BB□5
Order number supplement for connection types ³⁾										
• With spring-loaded terminals										
• With screw terminals										
Order number supplement for rated control supply voltage U_s ⁴⁾										
• 115 V AC										
• 230 V AC										

¹⁾ Standalone assembly.

²⁾ Soft starter with screw terminals.

³⁾ Main circuit connection: busbar connection.

⁴⁾ Control by way of the internal 24 V DC supply or direct control by means of PLC possible

2
6

3
4

Note

The rated motor current is extremely important when selecting a soft starter.

Refer to the information about selecting soft starters in chapter Configuration [Page 73].

Conditions for normal starting (CLASS 10):

Max. ramp-up time 40 s, current limiting 350 %, 1 starts / hour, ON time 30 %, standalone assembly, max. installation altitude 1000 m / 3280 ft, ambient temperature kW 40 °C / 104 °F. A larger model may need to be selected if other conditions and constraints apply or for a higher starting frequency. We recommend using the "Win-Soft Starter" selection and simulation software. For information about the rated currents for ambient temperatures > 40 °C, refer to chapter 3RW40 55, 56, 73, 74, 75, 76 power electronics [Page 151].

13.2.7 3RW40 2., 3., 4. control electronics

Type			3RW402.		3RW403., 3RW404.	
Control electronics						
Rated values	Terminal					
Rated control supply voltage	A1 / A2	V	24	110...230	24	110...230
• Tolerance		%	±20	-15/+10	±20	-15/+10
Rated control supply current						
• STANDBY		mA	<150	<50	<200	<50
• During pickup		mA	<200	<100	<5000	<1500
• ON without fan		mA	<250	<50	<200	<50
• ON with fan		mA	<300	<70	<250	<70
Rated frequency		Hz	50/60			
• Tolerance		%	±20			
Control inputs						
IN			ON / OFF			
Rated operational current						
• AC		mA	Approx. 12	3/6	Approx. 12	3/6
• DC		mA	Approx. 12	1.5/3	Approx. 12	1.5/3
Relay outputs						
Output 1	ON / RUN mode ¹⁾	13/14	Operating indication (NO)			
Output 2	BYPASSED	23/24	Bypass indication (NO)			
Output 3	OVERLOAD/FAILURE	95/96/98	Overload / fault indication (NC/NO)			
Rated operational current		A	3AC-15/AC-14 at 230 V,			
		A	1DC-13 at 24 V			
Protection against overvoltages			Protection by means of varistor through contact			
Short-circuit protection			4 A gL/gG operational class;			
			6 A quick (fuse is not included in scope of supply)			

1) Factory default: ON mode.

13.2.8 3RW40 5., 7. control electronics

Type			3RW405.		3RW407.	
Control electronics						
Rated values	Terminal					
Rated control supply voltage	A1 / A2	V AC	115	230	115	230
• Tolerance		%	-15/+10		-15/+10	
Rated control supply current						
• STANDBY		mA	15		15	
• During pickup		mA	<1700	<850	<400	<2000
• ON ¹⁾		mA	440	200	660	360
Rated frequency		Hz	50/60		50/60	
• Tolerance		%	±10		±10	
Control inputs						
IN			ON / OFF			
Rated operational current		mA	Approx. 10 according to DIN 19240			
Rated operational voltage		V DC	24 from internal supply DC+ or external DC supply (according to DIN 19240) through terminals and IN			
Relay outputs						
Output 1	ON / RUN mode ²⁾	13/14	Operating indication (NO)			
Output 2	BYPASSED	23/24	Bypass indication (NO)			
Output 3	OVERLOAD/FAILURE	95/96/98	Overload / fault indication (NC/NO)			
Rated operational current		A	3AC-15/AC-14 at 230 V,			
		A	1DC-13 at 24 V			
Protection against overvoltages			Protection by means of varistor through contact			
Short-circuit protection			4 A gL/gG operational class;			
			6 A quick (fuse is not included in scope of supply)			

1) Values for the coil power consumption at +10% U_n , 50 Hz.

2) Factory default: ON mode.

13.2.9 3RW40 2., 3., 4. control electronics

Type	3RW402., 3RW403., 3RW404.			
Control electronics				
Operating indications	LED	DEVICE	STATE/BYPASSED/FAILURE	OVERLOAD
Off		Green	Off	Off
Start		Green	Green flashing	Off
Bypass		Green	Green	Off
Stop		Green	Green flashing	Off
Alarm signals				
Impermissible I_e / CLASS setting		Green	Not relevant	Red flashing
Start inhibited / thyristors too hot		Yellow flashing	Not relevant	Off
Fault signals				
• 24 V: $U < 0.75 \times U_s$ or $U > 1.25 \times U_s$		Off	Red	Off
• 110...230 V: $U < 0.75 \times U_s$ or $U > 1.15 \times U_s$		Off	Red	Off
Impermissible I_e / CLASS setting for edge 0→1 on input IN		Green	Red	Red flashing
Motor protection tripping (overload thermistor)		Green	Off	Red
Thermistor defective (wire breakage, short-circuit)		Green	Off	Red flickering
Thermal overload of the thyristors		Yellow	Red	Off
Missing mains voltage, phase failure / missing load		Green	Red	Off
Device fault		Red	Red	Off

13.2.10 3RW40 5., 7. control electronics

Type	3RW405. and 3RW407.				
Control electronics					
Operating indications	LEDs	DEVICE	STATE/BYPASSED	FAILURE	OVERLOAD
Off		Green	Off	Off	Off
Start		Green	Green flashing	Off	Off
Bypass		Green	Green	Off	Off
Stop		Green	Green flashing	Off	Off
Alarm signals					
Impermissible I_e / CLASS setting		Green	Not relevant	Not relevant	Red flashing
Start inhibited / thyristors too hot		Yellow flashing	Not relevant	Not relevant	Off
Fault signals					
$U < 0.75 \times U_s$ or $U > 1.15 \times U_s$		Off	Off	Red	Off
Impermissible I_e / CLASS setting for edge 0→1 on input IN		Green	Off	Red	Red flashing
Motor protection tripping		Green	Off	Off	Red
Thermal overload of the thyristors		Yellow	Off	Red	Off
Missing mains voltage, phase failure / missing load		Green	Off	Red	Off
Device fault		Red	Off	Red	Off

13.2.11 3RW40 protection functions

Type	3RW40..		Factory default
Protection functions			
Motor protection functions			
Trips in the event of		Thermal overloading of the motor	
Trip class to IEC 60947-4-1	Class	10/15/20	10
Phase failure sensitivity	%	>40	
Overload warning		No	
Thermistor protection according to IEC 60947-8, type A / IEC 60947-5-1		Yes ¹⁾	
Reset option after tripping		Manual / automatic / remote reset ²⁾ (MAN / AUTO / REMOTE ²⁾)	
Recovery time	min	5	
Device protection functions			
Trips in the event of		Thermal overloading of the thyristors or bypass ³⁾	
Reset option after tripping		Manual / automatic / remote reset ²⁾ (MAN / AUTO / REMOTE ²⁾)	
Recovery time			
• During overloading of the thyristors	s	30	
• During overloading of the bypass	s	60	

1) Optional up to size S3 (device version).

2) Integrated remote reset (REMOTE) available only for 3RW40 2. to 3RW40 4.; remote reset with accessory module 3RU19 available for 3RW405. and 3RW407.

3) Bypass protection up to size S3.

13.2.12 3RW40 control times and parameters

Type	3RW40..		Factory default
Control times and parameters			
Control times			
Closing delay (with connected control voltage)	ms	<50	
Closing delay (automatic / line contactor mode)	ms	<300	
Recovery time (closing command during active stop)	ms	100	
Mains failure bridging time			
Control supply voltage	ms	50	
Mains / phase failure response time			
Load current circuit			
• During starting and stopping	s	1	
• During bypass	s	5	
Reclosing lockout after overload trip			
Motor protection trip	min	5	
Device protection trip			
• During overloading of the thyristors	s	30	
• During overloading of the bypass	s	60	
Start parameters			
Ramp-up time	s	0...20	7.5
Starting voltage	%	40...100	40
Starting current limiting		1.3...5 x I _e	5 x I _e
Stop parameter			
Ramp-down time	s	0...20	0
Reset mode parameters (for motor / device protection trip)			
Manual reset	LED	Off	Off
Automatic reset	LED	Yellow	
Remote reset (REMOTE) ¹⁾	LED	Green	
Ramp-up detection		Yes	
Operating mode output 13/14			
Rising edge at	Start command		
Falling edge at	Off command	ON	ON
	Ramp-down end	RUN	

1) Integrated remote reset (REMOTE) available only for 3RW40 2. to 3RW40 4.; remote reset with accessory module 3RU19 available for 3RW405. and 3RW407.

13.2.13 3RW40 2. to 7. power electronics

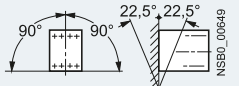
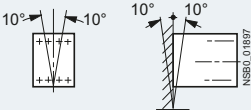
Type		3RW402.-.B.4, 3RW403.-.B.4, 3RW404.-.B.4	3RW402.-.B.5, 3RW403.-.B.5, 3RW404.-.B.5	3RW405.-BB.4, 3RW407.-BB.4	3RW405.-BB.5, 3RW407.-BB.5
Power electronics					
Rated operational voltage	V AC	200...480	400...600	200...460	400...600
Tolerance	%	-15/+10	-15/+10	-15/+10	-15/+10
Maximum thyristor blocking voltage	V AC	1600		1400	1800
Rated frequency	Hz	50/60			
Tolerance	%	±10			
Continuous duty at 40°C (% of I _e)		115			
Minimum load (% of minimum selectable rated motor current I _M)	%	20 (at least 2 A)			
Maximum cable length between soft starter and motor	m	300			
Permissible installation altitude	m	5000 (Derating from 1000, see characteristic curves); higher on request			
Permissible mounting position		<ul style="list-style-type: none"> • With auxiliary fan (for 3RW402. ... 3RW404.) 			
		<ul style="list-style-type: none"> • Without auxiliary fan (for 3RW402. ... 3RW404.) 			
		– (fan integrated in the soft starter)			
Permissible ambient temperature					
Operation	°C	-25...+60; (derating from +40)			
Storage	°C	-40...+80			
Degree of protection		IP20 for 3RW40 2.; IP00 for 3RW40 3. and 3RW40 4.		IP00	

13.2.14 3RW40 24, 26, 27, 28 power electronics

Type		3RW4024	3RW4026	3RW4027	3RW4028
Power electronics					
Current carrying capacity rated operating current I_B					
•Acc. to IEC and UL/CSA ¹⁾ , for standalone assembly, AC-53a					
-At 40°C	A	12.5	25.3	32.2	38
-At 50°C	A	11	23	29	34
-At 60°C	A	10	21	26	31
Minimum settable rated motor current I_M for motor overload protection					
	A	5	10	17	23
Power loss					
•During operation after startup of the motor at uninterrupted rated operat. curr. (40°C) approx.					
	W	2	8	13	19
•During starting at 300 % current limiting I_M (40°C)					
	W	68	188	220	256
Permissible rated motor current and starts per hour					
•For normal starting (class 10):					
-Rated motor curr. $I_M^{(2)}$, ramp-up t. 3s	A	12.5 / 11	25 / 23	32 / 29	38 / 34
-Starts per hour ³⁾	1/h	50 / 50	23 / 23	23 / 23	19 / 19
-Rated motor curr. $I_M^{(2)4)}$, ramp-up t. 4s	A	12.5 / 11	25 / 23	32 / 29	38 / 34
-Starts per hour ³⁾	1/h	36 / 36	15 / 15	16 / 16	12 / 12
•For heavy-duty starting (class 15)					
-Rated motor curr. $I_M^{(2)}$, ramp-up t. 4,5s	A	11 / 10	23 / 21	30 / 27	34 / 31
-Starts per hour ³⁾	1/h	49 / 49	21 / 21	18 / 18	18 / 18
-Rated motor curr. $I_M^{(2)4)}$, ramp-up t. 6s	A	11 / 10	23 / 21	30 / 27	34 / 31
-Starts per hour ³⁾	1/h	36 / 36	14 / 14	13 / 13	13 / 13
•For heavy-duty starting (class 20)					
-Rated motor curr. $I_M^{(2)}$, ramp-up t. 6s	A	10 / 9	21 / 19	27 / 24	31 / 28
-Starts per hour ³⁾	1/h	47 / 47	21 / 21	20 / 20	18 / 18
-Rated motor curr. $I_M^{(2)4)}$, ramp-up t. 8s	A	10 / 9	21 / 19	27 / 24	31 / 28
-Starts per hour ³⁾	1/h	34 / 34	15 / 15	14 / 14	13 / 13

1) Measurement at 60°C in accordance with UL/CSA not required.

2) 300 % current limiting on soft starter I_M . Tamb = 40 °C / 50 °C.

3) For intermittent duty S4 with ON time 30%, T_{amb}=40°C / 50 °C, vertical standalone assembly. The specified switching frequencies do not apply to automatic mode. Factors for permissible switching frequency with different mounting position, direct assembly, side-by-side assembly and installation of an optional additional fan, see Configuration chapter.

4) Maximum settable rated motor current I_M , depending on the CLASS setting.

13.2.15 3RW40 36, 37, 38, 46, 47 power electronics

Type		3RW4036	3RW4037	3RW4038	3RW4046	3RW4047
Power electronics						
Current carrying capacity rated operating current I_e						
•Acc. to IEC and UL/CSA ¹⁾ , for standalone assembly, AC-53a						
-At 40 °C	A	45	63	72	80	106
-At 50 °C	A	42	58	62.1	73	98
-At 60 °C	A	39	53	60	66	90
Minimum settable rated motor current I_M for motor overload protection						
	A	23	26	35	43	46
Power loss						
•During operation after startup of the motor at uninterrupted rated operat. curr. (40°C) approx.	W	6	12	15	12	21
•During starting at 300 % current limiting I_M (40°C)	W	316	444	500	576	768
Permissible rated motor current and starts per hour						
•For normal starting (class 10):						
-Rated motor curr. $I_M^{(2)}$, ramp-up t. 3s	A	45 / 42	63 / 58	72 / 62	80 / 73	106 / 98
-Starts per hour ³⁾	1/h	38 / 38	23 / 23	22 / 22	22 / 22	15 / 15
-Rated motor curr. $I_M^{(2)4)}$, ramp-up t. 4s	A	45 / 42	63 / 58	72 / 62	80 / 73	106 / 98
-Starts per hour ³⁾	1/h	26 / 26	15 / 15	15 / 15	15 / 15	10 / 10
•For heavy-duty starting (class 15)						
-Rated motor curr. $I_M^{(2)}$, ramp-up t. 4.5s	A	42 / 38	50 / 46	56 / 52	70 / 64	84 / 77
-Starts per hour ³⁾	1/h	30 / 30	34 / 34	34 / 34	24 / 24	23 / 23
-Rated motor curr. $I_M^{(2)4)}$, ramp-up t. 6s	A	42 / 38	50 / 46	56 / 52	70 / 64	84 / 77
-Starts per hour ³⁾	1/h	21 / 21	24 / 24	24 / 24	16 / 16	17 / 17
•For heavy-duty starting (class 20)						
-Rated motor curr. $I_M^{(2)}$, ramp-up t. 6s	A	38 / 34	46 / 42	50 / 46	64 / 58	77 / 70
-Starts per hour ³⁾	1/h	30 / 30	31 / 31	34 / 34	23 / 23	23 / 23
-Rated motor curr. $I_M^{(2)4)}$, ramp-up t. 8s	A	38 / 34	46 / 42	50 / 46	64 / 58	77 / 70
-Starts per hour ³⁾	1/h	21 / 21	22 / 22	24 / 24	16 / 16	16 / 16

1) Measurement at 60°C in accordance with UL/CSA not required.

2) 300 % current limiting on soft starter I_M . $T_{amb} = 40\text{ °C} / 50\text{ °C}$

3) For intermittent duty S4 with ON time 30%, $T_{amb} = 40\text{ °C} / 50\text{ °C}$, vertical standalone assembly. The specified switching frequencies do not apply to automatic mode. Factors for permissible switching frequency with different mounting position, direct assembly, side-by-side assembly and installation of an optional additional fan, see Configuration chapter.

4) Maximum settable rated motor current I_M , depending on the CLASS setting.

13.2.16 3RW40 55, 56, 73, 74, 75, 76 power electronics

Type		3RW4055	3RW4056	3RW4073	3RW4074	3RW4075	3RW4076
Power electronics							
Current carrying capacity rated operating current I_b							
*Acc. to IEC and UL/CSA ¹⁾ , for standalone assembly, AC-53a							
-At 40°C	A	134	162	230	280	356	432
-At 50 °C	A	117	145	205	248	315	385
-At 60 °C	A	100	125	180	215	280	335
Minimum settable rated motor current I_M for motor overload protection							
	A	59	87	80	130	131	207
Power loss							
*During operation after startup of the motor at uninterrupted rated operat. curr. (40°C) approx.	W	60	75	75	90	125	165
*During starting at 350% ²⁾ current limiting I_M (40°C)	W	1043	1355	2448	3257	3277	3600
Permissible rated motor current and starts per hour							
*For normal starting (class 10):							
-Rated motor curr. $I_M^{2)}$, ramp-up t. 10s	A	134 / 117	162 / 145	230 / 205	280 / 248	356 / 315	432 / 385
-Starts per hour ³⁾	1/h	20 / 20	8 / 8	14 / 14	20 / 20	16 / 16	17 / 17
-Rated motor curr. $I_M^{2)4)}$, ramp-up t. 20s	A	134 / 117	162 / 145	230 / 205	280 / 248	356 / 315	432 / 385
-Starts per hour ³⁾	1/h	7 / 7	1.4 / 1.4	3 / 3	8 / 8	5 / 5	5 / 5
*For heavy-duty starting (class 15)							
-Rated motor curr. $I_M^{2)}$, ramp-up t. 15s	A	134 / 117	152 / 140	210 / 200	250 / 220	341 / 315	402 / 385
-Starts per hour ³⁾	1/h	11 / 11	8 / 8	11 / 11	13 / 13	11 / 11	12 / 12
-Rated motor curr. $I_M^{2)4)}$, ramp-up t. 30s	A	134 / 117	152 / 140	210 / 200	250 / 220	341 / 315	402 / 385
-Starts per hour ³⁾	1/h	1.2 / 1.2	1.7 / 1.7	1 / 1	6 / 6	2 / 2	2 / 2
*For heavy-duty starting (class 20)							
-Rated motor curr. $I_M^{2)}$, ramp-up t. 20s	A	124 / 112	142 / 132	200 / 185	230 / 205	311 / 280	372 / 340
-Starts per hour ³⁾	1/h	12 / 12	9 / 9	10 / 10	10 / 10	10 / 10	10 / 10
-Rated motor curr. $I_M^{2)4)}$, ramp-up t. 40s	A	124 / 112	142 / 132	200 / 185	230 / 205	311 / 280	372 / 340
-Starts per hour ³⁾	1/h	2 / 2	2 / 2	1 / 1	5 / 5	1 / 1	1 / 1



1) Measurement at 60°C in accordance with UL/CSA not required.

2) 350% current limiting on soft starter I_M . Tamb = 40 °C / 50 °C







3) For intermittent duty S4 with ON time 70%, T_{amb}=40°C / 50 °C, vertical standalone assembly. The specified switching frequencies do not apply to automatic mode.

4) Maximum settable rated motor current I_M , depending on the CLASS setting.

13.2.17 3RW40 2., 3., 4. main conductor cross-sections

Soft starters	Type		3RW402.	3RW403.	3RW404.
Conductor cross-sections					
Screw terminals	Main conductors				
Front clamping point connected 	• Solid	mm ²	2 x (1.5...2.5); 2 x (2.5...6) according to IEC 60947; max. 1 x 10	2 x (1.5...16)	2 x (2.5...16)
	• With end sleeve	mm ²	2 x (1.5...2.5); 2 x (2.5...6)	1 x (0.75...25)	1 x (2.5...35)
	• Stranded	mm ²	–	1 x (0.75...35)	1 x (4...70)
	• AWG cables				
	- Solid	AWG	2 x (16 ... 12)		
Rear clamping point connected 	- Solid or stranded	AWG	2 x (14...10)	1 x (18...2)	2 x (10...1/0)
	- Stranded	AWG	1 x 8	–	–
	• Solid	mm ²	–	2 x (1.5...16)	2 x (2.5...16)
	• With end sleeve	mm ²	–	1 x (1.5...25)	1 x (2.5...50)
	• Stranded	mm ²	–	1 x (1.5...35)	1 x (10...70)
Both clamping points connected 	• AWG cables				
	- Solid or stranded	AWG	–	1 x (16...2)	2 x (10...1/0)
	• Solid	mm ²	–	2 x (1.5...16)	2 x (2.5...16)
	• With end sleeve	mm ²	–	2 x (1.5...16)	2 x (2.5...35)
	• Stranded	mm ²	–	2 x (1.5...25)	2 x (10...50)
	• AWG cables				
	- Solid or stranded	AWG	–	2 x (16...2)	1 x (10...2/0)
	• Tightening torque	Nm lb.in	2...2.5 18...22	4.5 40	6.5 58
	Tools		PZ2	PZ2	Allen screw 4 mm
	Degree of protection		IP20	IP20 (terminal compartment IP00)	IP20 (terminal compartment IP00)
Spring-loaded terminals	Main conductors				
	• Solid	mm ²	1...10	–	
	• Finely stranded with end sleeve	mm ²	1...6 end sleeves without plastic collar	–	
	• AWG cables				
	- Solid or stranded (finely stranded)	AWG	16...10	–	
	- Stranded	AWG	1 x 8	–	
	Tools		DIN ISO 2380-1A0; 5 x 3	–	
	Degree of protection		IP20	–	
Busbar connections	Main conductors				
	• With cable lug according to DIN 46234 or 20 mm wide				
	- Stranded	mm ²	–		2 x (10...70)
	- Finely-stranded	mm ²	–		2 x (10...50)
	• AWG cables, solid or stranded	AWG	–		2 x (7...1/0)

13.2.18 3RW40 5., 7. main conductor cross-sections

Soft starters	Type		3RW405.	3RW407.
Conductor cross-sections				
Screw terminals				
Main conductors:				
With box terminal			3RT19 55-4G (55 kW)	3RT19 66-4G
Front clamping point connected	<ul style="list-style-type: none"> • Finely stranded with end sleeve • Stranded • Ribbon cable conductors (number x width x thickness) • AWG cables, solid or stranded 	<ul style="list-style-type: none"> mm² mm² mm AWG 	<ul style="list-style-type: none"> 16...70 16...70 Min. 3 x 9 x 0.8, Max. 6 x 15.5 x 0.8 6...2/0 	<ul style="list-style-type: none"> 70...240 95...300 Min. 6 x 9 x 0.8 Max. 20 x 24 x 0.5 3/0...600 kcmil
				
Rear clamping point connected	<ul style="list-style-type: none"> • Finely stranded with end sleeve • Stranded • Ribbon cable conductors (number x width x thickness) • AWG cables, solid or stranded 	<ul style="list-style-type: none"> mm² mm² mm AWG 	<ul style="list-style-type: none"> 16...70 16...70 Min. 3 x 9 x 0.8, Max. 6 x 15.5 x 0.8 6...2/0 	<ul style="list-style-type: none"> 120...185 120...240 Min. 6 x 9 x 0.8 Max. 20 x 24 x 0.5 250...500 kcmil
				
Both clamping points connected	<ul style="list-style-type: none"> • Finely stranded with end sleeve • Stranded • Ribbon cable conductors (number x width x thickness) • AWG cables, solid or stranded • Terminal screws - Tightening torque 	<ul style="list-style-type: none"> mm² mm² mm AWG Nm lb.in 	<ul style="list-style-type: none"> Max. 1 x 50, 1 x 70 Max. 2 x 70 Max. 2 x (6 x 15.5 x 0.8) Max. 2 x 1/0 M10 (hexagon socket, A/F4) 10...12 90...110 	<ul style="list-style-type: none"> Min. 2 x 50; max. 2 x 185 Max. 2 x 70; max. 2 x 240 Max. 2 x (20 x 24 x 0.5) Min. 2 x 2/0; max. 2 x 500 kcmil M12 (hexagon socket, A/F5) 20...22 180...195
				
Screw terminals				
Main conductors:				
With box terminal			3RT19 56-4G	
Front or rear clamping point connected	<ul style="list-style-type: none"> • Finely stranded with end sleeve • Stranded • Ribbon cable conductors (number x width x thickness) • AWG cables, solid or stranded 	<ul style="list-style-type: none"> mm² mm² mm AWG 	<ul style="list-style-type: none"> 16...120 16...120 Min. 3 x 9 x 0.8 Max. 6 x 15.5 x 0.8 6...250 kcmil 	
 				
Both clamping points connected	<ul style="list-style-type: none"> • Finely stranded with end sleeve • Stranded • Ribbon cable conductors (number x width x thickness) • AWG cables, solid or stranded 	<ul style="list-style-type: none"> mm² mm² mm AWG 	<ul style="list-style-type: none"> Max. 1 x 95, 1 x 120 Max. 2 x 120 Max. 2 x (10 x 15.5 x 0.8) Max. 2 x 3/0 	
				
Screw terminals				
Main conductors:				
<u>Without box terminal / busbar connection</u>				
	<ul style="list-style-type: none"> • Finely stranded with cable lug • Stranded with cable lug • AWG cables, solid or stranded • Connecting bar (max. width) • Terminal screws - Tightening torque 	<ul style="list-style-type: none"> mm² mm² AWG mm Nm lb.in 	<ul style="list-style-type: none"> 16...95¹⁾ 25...120¹⁾ 4...250 kcmil 17 M8x25 (A/F13) 10...14 89...124 	<ul style="list-style-type: none"> 50...240²⁾ 70...240²⁾ 2/0...500 kcmil 25 M10x30 (A/F17) 14...24 124...210

1) When connecting cable lugs to DIN 46235, use 3RT19 56-4EA1 terminal cover for conductor cross-sections from 95 mm² to ensure the required clearance between phases.

2) When connecting cable lugs to DIN 46234 or DIN 46235, use 3RT19 66-4EA1 terminal cover for conductor cross-sections from 240 mm² or 185 mm² respectively to ensure the required clearance between phases.

13.2.19 3RW40 .. auxiliary conductor cross-sections

Soft starters	Type	3RW40..	
Conductor cross-sections			
Auxiliary conductors (1 or 2 conductors can be connected)			
Screw terminals			
• Solid	mm ²	2 x (0.5...2.5)	
• Finely stranded with end sleeve	mm ²	2 x (0.5...1.5)	
• AWG cables			
- Solid or stranded	AWG	2 x (20...14)	
- Finely stranded with end sleeve	AWG	2 x (20...16)	
• Terminal screws			
- Tightening torque	Nm	0.8...1.2	
	lb.in	7...10.3	
Spring-loaded terminals			
• Solid			
- 3RW40 2. to 3RW40 4.	mm ²	2 x (0.25...2.5)	
- 3RW40 5., 3RW40 7.	mm ²	2 x (0.25...1.5)	
• Finely stranded with end sleeve	mm ²	2 x (0.25...1.5)	
• AWG cables, solid or stranded	AWG	2 x (24...14) for 3RW402....3RW404.;	
		2 x (24...16) for 3RW405. and 3RW407.	

13.2.20 Electromagnetic compatibility according to EN 60947-4-2

	Standard	Parameters
Electromagnetic compatibility according to EN 60947-4-2		
EMC interference immunity		
Electrostatic discharge (ESD)	EN 61000-4-2	± 4 kV contact discharge, ± 8 kV air discharge
Electromagnetic RF fields	EN 61000-4-3	Frequency range: 80 to 1000 MHz with 80% at 1 kHz Degree of severity 3: 10 V/m
Conducted RF interference	EN 61000-4-6	Frequency range: 150 kHz...80 MHz with 80% at 1 kHz Interference 10 V
RF voltages and RF currents on cables		
• Burst	EN 61000-4-4	± 2 kV / 5 kHz
• Surge	EN 61000-4-5	±1 kV line to line ±2 kV line to ground
EMC interference emission		
EMC interference field strength	EN 55011	Limit value of Class A at 30...1000 MHz, Limit value of Class B for 3RW402.; 24 V AC/DC
Radio interference voltage	EN 55011	Limit value of Class A at 0.15...30 MHz, Limit value of Class B for 3RW402.; 24 V AC/DC
Radio interference suppression filters		
Degree of noise suppression A (industrial applications)	Not required	
Degree of noise suppression B (applications for residential areas)		
Control voltage		
• 110...230 V AC/DC	Not available ¹⁾	
• 115/230 V AC	Not available ¹⁾	
• 24 V AC/DC	Not required for 3RW402.;	
	Required for 3RW403. and 3RW404. (see table)	

1) Degree of noise suppression B cannot be obtained through the use of filters as the strength of the electromagnetic field is not attenuated by the filter.

13.2.21 Recommended filters

Soft starter types	Nominal current Soft starters A	Recommended filters ¹⁾		
		Filter types	Nominal current filters A	Terminals mm ²
3RW40 36	45	4EF1512-1AA10	50	16
3RW40 37	63	4EF1512-2AA10	66	25
3RW40 38	72	4EF1512-3AA10	90	25
3RW40 46	80	4EF1512-3AA10	90	25
3RW40 47	106	4EF1512-4AA10	120	50

1) The radio interference suppression filter is used to remove the conducted interference from the main circuit. The field-related emissions comply with degree of noise suppression B. The filter should be selected under standard conditions: 10 starts per hour, ramp-up time 4 s at 300% I_e

13.2.22 Types of coordination

Types of coordination

The type of coordination according to which the motor feeder with soft starter is mounted depends on the application-specific requirements. Normally, fuseless mounting (combination of motor starter protector and soft starter) is sufficient. If type of coordination 2 needs to be fulfilled, semiconductor fuses must be fitted in the motor feeder.

ToC 1

Type of coordination 1 in accordance with IEC 60947-4-1:

The device is defective following a short-circuit failure and therefore unsuitable for further use (personnel and equipment must not be put at risk).

ToC 2

Type of coordination 2 in accordance with IEC 60947-4-1:

The device is suitable for further use following a short-circuit failure (personnel and equipment must not be put at risk).

The type of coordination only refers to soft starters in conjunction with the stipulated protective device (motor starter protector / fuse), not to additional components in the feeder.

13.2.23 Fuseless version

Fuseless version

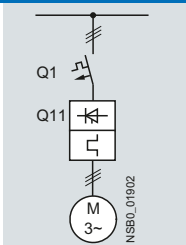

Soft starters Q11 Type	Nominal current A	Motor starter protectors ¹⁾		I _{q max} kA	Rated current A	575 V +10%		I _{q max} kA	Rated current A	
		Q1 Type	Q1 Type			Q1 Type	Q1 Type			
Type of coordination ²⁾										
3RW40 24	12.5	3RV1 021-1KA10	3RV20 21-4AA/ 3RV20 11-4AA (in size S00)	3RV1 321-1KC10	3RV23 21-4AC/ 3RV23 11-4AC (in size S00)	55	16	-	-	-
3RW40 26	25	3RV1 021-4DA10	3RV20 21-4DA	3RV1 321-4DC10	3RV23 21-4DC	55	25	-	-	-
3RW40 27	32	3RV1 031-4EA10	3RV20 21-4EA	3RV1 331-4EC10	3RV23 21-4EC	55	32	-	-	-
3RW40 28	38	3RV1 031-4FA10	3RV20 21-4FA	3RV1 331-4FC10	3RV23 21-4FC	55	40	-	-	-
3RW40 36	45	3RV1 031-4GA10		3RV1 331-4GC10		20	45	-	-	-
3RW40 37	63	3RV1 041-4JA10		3RV1 341-4JC10		20	63	-	-	-
3RW40 38	72	3RV1 041-4KA10		3RV1 341-4KC10		20	75	-	-	-
3RW40 46	80	3RV1 041-4LA10		3RV1 341-4LC10		11	90	-	-	-
3RW40 47	106	3RV1 041-4MA10		3RV1 341-4MC10		11	100	-	-	-
3RW40 55	134	3VL3 720-2DC36				35	200	3VL3 720-1DC36	12	200
3RW40 56	162	3VL3 720-2DC36				35	200	3VL3 720-1DC36	12	200
3RW40 73	230	3VL4 731-2DC36				65	315	3VL5 731-3DC36	35	315
3RW40 74	280	3VL4 731-2DC36				65	315	3VL5 731-3DC36	35	315
3RW40 75	356	3VL4 740-2DC36				65	400	3VL5 740-3DC36	35	400
3RW40 76	432	3VL5 750-2DC36				65	500	3VL5 750-3DC36	35	500

¹⁾ The rated motor current must be considered when selecting the devices. The 3RV13 and 3RV23 motor starter protectors are used for starter combinations (without motor protection). In this case, motor protection is provided by the 3RW40 soft starter.

²⁾ The types of coordination are described in chapter Types of coordination [Page 155].

13.2.24 Fused version (line protection only)

Fused version (line protection only)

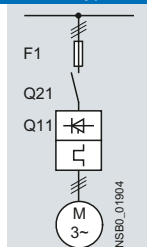

Soft starters ToC 1	Nominal current	Line protection, maximum Rated current	Size	Line contactors (optional)		
Q11 Type	A	F1 Type	A	Q21		
Type of coordination 1 ¹⁾ : I _q = 65 kA at 600 V + 5%						
3RW40 24	12.5	3NA3 820-6	50	00	3RT10 24	3RT20 25/3RT20 18 (in size S00)
3RW40 26	25	3NA3 822-6	63	00	3RT10 26	3RT20 26
3RW40 27	32	3NA3 824-6	80	00	3RT10 34	3RT20 27
3RW40 28	38	3NA3 824-6	80	00	3RT10 35	3RT20 28
3RW40 36	45	3NA3 130-6	100	1	3RT10 36	
3RW40 37	63	3NA3 132-6	125	1	3RT10 44	
3RW40 38	72	3NA3 132-6	125	1	3RT10 45	
3RW40 46	80	3NA3 136-6	160	1	3RT10 45	
3RW40 47	106	3NA3 136-6	160	1	3RT10 46	
3RW40 55	134	3NA3 244-6	250	2	3RT10 55-6A.36	
3RW40 56	162	3NA3 244-6	250	2	3RT10 56-6A.36	
3RW40 73	230	2 x 3NA3 354-6	2 x 355	3	3RT10 65-6A.36	
3RW40 74	280	2 x 3NA3 354-6	2 x 355	3	3RT10 66-6A.36	
3RW40 75	356	2 x 3NA3 365-6	2 x 500	3	3RT10 75-6A.36	
3RW40 76	432	2 x 3NA3 365-6	2 x 500	3	3RT10 76-6A.36	

1) The types of coordination are described in chapter Types of coordination [Page 155].
Type of coordination 1 only refers to soft starters in conjunction with the stipulated protective device (motor starter protector / fuse), not to additional components in the feeder.

13.2.25 Fused version with SITOR 3NE1 fuses

Assembly as for type of coordination 2, with SITOR all-range fuses (F'1) for combined thyristor and line protection.

Fused version with SITOR 3NE1 fuses (semiconductor and line protection)

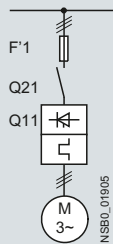

For suitable fuse bases, refer to "SENTRON switching and protecting devices for power distribution" —> "Switch disconnectors" the LV1 Catalog and to "BETA protecting" —> "SITOR semiconductor fuses" in the ET B1 Catalog or consult www.siemens.de/sitor

Soft starters Q11 Type	Nominal current A	All-range fuses F'1 Type	All-range fuses		Line contactors (optional) Q21	
			Rated current A	Size		
Type of coordination 2 ¹⁾ : I _q = 65 kA at 600 V + 5%						
3RW40 24	12.5	3NE1 814-0	20	000	3RT10 24	3RT20 25
3RW40 26	25	3NE1 803-0	35	000	3RT10 26	3RT20 26
3RW40 27	32	3NE1 020-2	80	00	3RT10 34	3RT20 27
3RW40 28	38	3NE1 020-2	80	00	3RT10 35	3RT20 28
3RW40 36	45	3NE1 020-2	80	00	3RT10 36	
3RW40 37	63	3NE1 820-0	80	000	3RT10 44	
3RW40 38	72	3NE1 820-0	80	000	3RT10 45	
3RW40 46	80	3NE1 021-0	100	00	3RT10 45	
3RW40 47	106	3NE1 022-0	125	00	3RT10 46	
3RW40 55	134	3NE1 227-2	250	1	3RT10 55-6A.36	
3RW40 56	162	3NE1 227-2	250	1	3RT10 56-6A.36	
3RW40 73	230	3NE1 331-2	350	2	3RT10 65-6A.36	
3RW40 74	280	3NE1 333-2	450	2	3RT10 66-6A.36	
3RW40 75	356	3NE1 334-2	500	2	3RT10 75-6A.36	
3RW40 76	432	3NE1 435-2	560	3	3RT10 76-6A.36	

1) The types of coordination are described in chapter Types of coordination [Page 155].
Type of coordination 2 only refers to soft starters in conjunction with the stipulated protective device (motor starter protector / fuse), not to additional components in the feeder.

13.2.26 Fused version with SITOR 3NE3/4/8 fuses

Assembly as for type of coordination 2, with additional SITOR fuses (F3) for thyristor protection only.

Fused version with 3NE3 SITOR fuses (semiconductor protection by fuse, line, and overload protection by motor starter protector; alternatively, installation with contactor and overload relay possible)

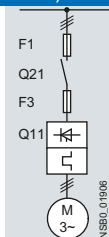
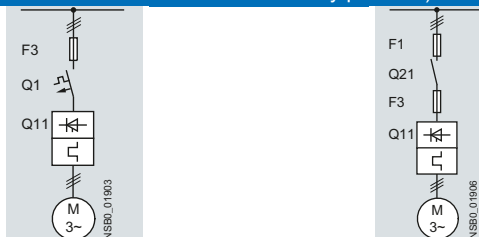

For suitable fuse bases, refer to under "SENTRON switching and protecting devices for power distribution" → "Switch disconnectors" in the LV1 Catalog and to "BETA protecting" → "SITOR semiconductor fuses" in the ET B1 Catalog or consult www.siemens.de/sitor

Soft starters Toc 2 Q11 Type	Nominal current A	Semiconductor fuses, minimum			Semiconductor fuses, maximum			Semiconductor fuses, minimum		
		F3 Type	Rated current A	Size	F3 Type	Rated current A	Size	F3 Type	Rated current A	Size
Type of coordination 2 ¹⁾ : I _q = 65 kA at 600 V + 5%										
3RW40 24	12.5	–	–	–	–	–	–	3NE4101	32	0
3RW40 26	25	–	–	–	3NE3 221	100	1	3NE4102	40	0
3RW40 27	32	–	–	–	3NE3 224	160	1	3NE4118	63	0
3RW40 28	38	–	–	–	3NE3 224	160	1	3NE4118	63	0
3RW40 36	45	–	–	–	3NE3 224	160	1	3NE4120	80	0
3RW40 37	63	–	–	–	3NE3 225	200	1	3NE4121	100	0
3RW40 38	72	3NE3 221	100	1	3NE3 227	250	1	–	–	–
3RW40 46	80	3NE3 222	125	1	3NE3 225	200	1	–	–	–
3RW40 47	106	3NE3 224	160	1	3NE3 231	350	1	–	–	–
3RW40 55	134	3NE3 227	250	1	3NE3 335	560	2	–	–	–
3RW40 56	162	3NE3 227	250	1	3NE3 335	560	2	–	–	–
3RW40 73	230	3NE3 232-0B	400	1	3NE3 333	450	2	–	–	–
3RW40 74	280	3NE3 233	450	1	3NE3 336	630	2	–	–	–
3RW40 75	356	3NE3 335	560	2	3NE3 336	630	2	–	–	–
3RW40 76	432	3NE3 337-8	710	2	3NE3 340-8	900	2	–	–	–

Soft starters Toc 2 Q11 Type	Nominal current A	Semiconductor fuses, max.			Semiconductor fuses, min.			Semiconductor fuses, max.			Cylindrical fuses	
		F3 Type	Rated current A	Size	F3 Type	Rated current A	Size	F3 Type	Rated current A	Size	F3 Type	Rated current A
Type of coordination 2 ¹⁾ : I _q = 65 kA at 600 V + 5%												
3RW40 24	12.5	3NE4117	50	0	3NE8015-1	25	00	3NE8017-1	50	00	3NC2240	40
3RW40 26	25	3NE4117	50	0	3NE8017-1	50	00	3NE8021-1	100	00	3NC2263	63
3RW40 27	32	3NE4118	63	0	3NE8018-1	63	00	3NE8022-1	125	00	3NC2280	80
3RW40 28	38	3NE4118	63	0	3NE8020-1	80	00	3NE8024-1	160	00	3NC2280	80
3RW40 36	45	3NE4120	80	0	3NE8020-1	80	00	3NE8024-1	160	00	3NC2280	80
3RW40 37	63	3NE4121	100	0	3NE8021-1	100	00	3NE8024-1	160	00	–	–
3RW40 38	72	–	–	–	3NE8022-1	125	00	3NE8024-1	160	00	–	–
3RW40 46	80	–	–	–	3NE8 022-1	125	00	3NE8024-1	160	00	–	–
3RW40 47	106	–	–	–	3NE8 024-1	160	00	3NE8024-1	160	00	–	–
3RW40 55	134	–	–	–	–	–	–	–	–	–	–	–
3RW40 56	162	–	–	–	–	–	–	–	–	–	–	–
3RW40 73	230	–	–	–	–	–	–	–	–	–	–	–
3RW40 74	280	–	–	–	–	–	–	–	–	–	–	–
3RW40 75	356	–	–	–	–	–	–	–	–	–	–	–
3RW40 76	432	–	–	–	–	–	–	–	–	–	–	–

13.2 3RW40

Soft starters ToC 2	Nominal current Q11 Type	Line contactors (optional) Q21		Motor starter protectors 400 V +10%			Line protection, maximum				
		Rated current A	Rated current A	Rated current A	575 V +10% Q1 Type	Rated current A	Rated current A	Size			
Type of coordination 2 ¹⁾ : I _g = 65 kA at 600 V + 5%											
3RW40 24	12.5	3RT10 24	3RT20 25/ 3RT20 18 (in size S00)	3RV1 021-4KA10	3RV20 21-4AA/ 3RV20 11-4AA (in size S00)	16	–	–	3NA3 820-6	50	00
3RW40 26	25	3RT10 26	3RT20 26	3RV1 021-4DA10	3RV20 21-4DA	25	–	–	3NA3 822-6	63	00
3RW40 27	32	3RT10 34	3RT20 27	3RV1 031-4EA10	3RV20 21-4EA	32	–	–	3NA3 824-6	80	00
3RW40 28	38	3RT10 35	3RT20 28	3RV1 031-4FA10	3RV20 21-4FA	40	–	–	3NA3 824-6	80	00
3RW40 36	45	3RT10 36		3RV1 031-4GA10		45	–	–	3NA3 130-6	100	1
3RW40 37	63	3RT10 44		3RV1 041-4JA10		63	–	–	3NA3 132-6	125	1
3RW40 38	72	3RT10 45		3RV1 041-4KA10		75	–	–	3NA3 132-6	125	1
3RW40 46	80	3RT10 45		3RV1 041-4LA10		90	–	–	3NA3 136-6	160	1
3RW40 47	106	3RT10 46		3RV1 041-4MA10		100	–	–	3NA3 136-6	160	1
3RW40 55	134	3RT10 55-6A.36		3VL3 720		200	3VL3 720	200	3NA3 244-6	250	2
3RW40 56	162	3RT10 56-6A.36		3VL3 720		200	3VL3 720	200	3NA3 244-6	250	2
3RW40 73	230	3RT10 65-6A.36		3VL4 731		315	3VL5 731	315	2 x 3NA3 354-6	2 x 355	3
3RW40 74	280	3RT10 66-6A.36		3VL4 731		315	3VL5 731	315	2 x 3NA3 354-6	2 x 355	3
3RW40 75	356	3RT10 75-6A.36		3VL4 740		400	3VL5 740	400	2 x 3NA3 365-6	2 x 500	3
3RW40 76	432	3RT10 76-6A.36		3VL5 750		500	3VL5 750	500	2 x 3NA3 365-6	2 x 500	3

1) The types of coordination are described in chapter Types of coordination [Page 155].
 Type of coordination 2 only refers to soft starters in conjunction with the stipulated protective device (motor starter protector / fuse), not to additional components in the feeder.

13.2.27 Motor protection tripping characteristics for 3RW40 (with symmetry)

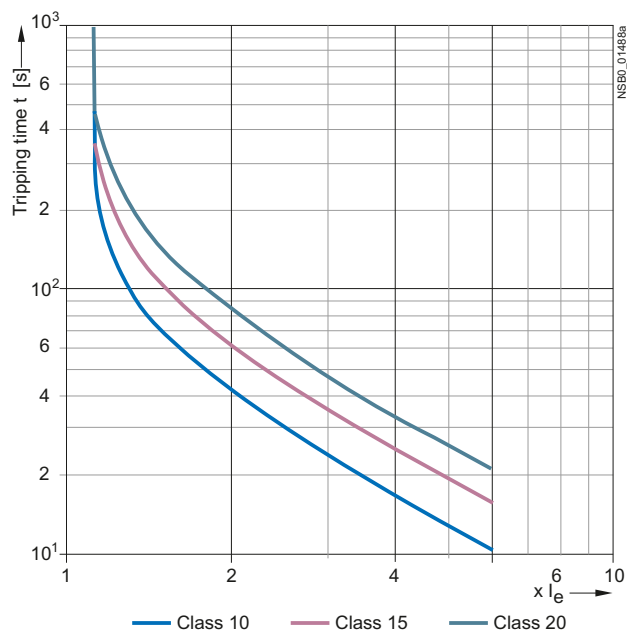

13.2.28 Motor protection tripping characteristics for 3RW40 (with asymmetry)

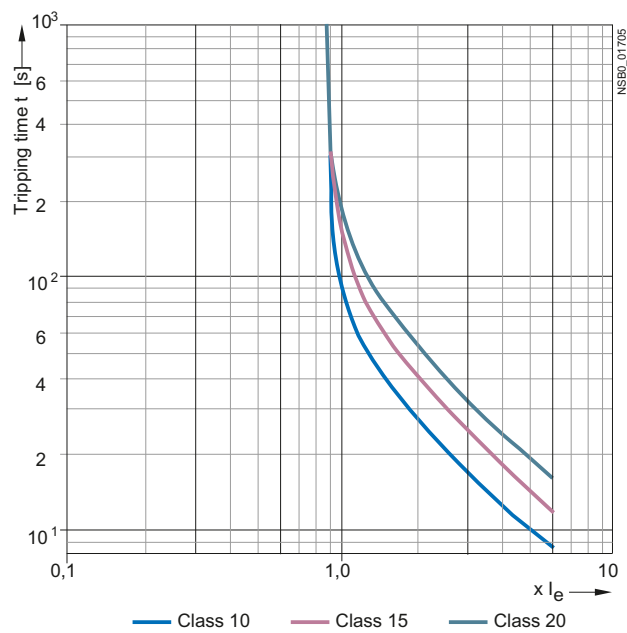

13.3 Win-Soft Starter selection and simulation software

This software can be used to simulate and select all SIEMENS soft starters, taking into account various parameters such as the supply system conditions, motor data, load data, specific application requirements, etc.

It is a useful tool, which does away with the need for time-consuming and complex manual calculations if you need to select the optimum soft starter for your particular case.

The Win-Soft Starter selection and simulation software can be downloaded from (<http://www.automation.siemens.com/mcms/low-voltage/en/industrial-controls/controls/solid-state-switching-devices/soft/software/Pages/default.aspx>)

More information about soft starters can likewise be found on the Internet at (<http://www.siemens.com/softstarter>)

Dimension drawings

14.1 3RW30 for standard applications

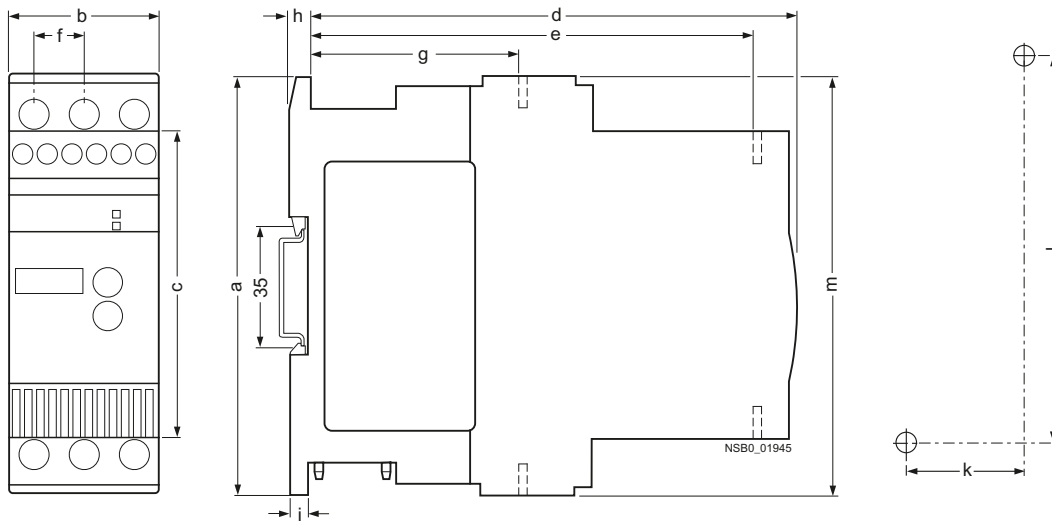

Type / dimensions (mm)	a	b	c	d	e	f	g	h	i	k	l	m
3RW301.-1.	95	45	62	146	126	14.4	63	5	6.5	35	85	95
3RW301.-2.	95	45	62	146	126	14.4	63	5	6.5	35	85	117.2
3RW302.-1.	125	45	92	146	126	14.4	63	5	6.5	35	115	125
3RW302.-2.	125	45	92	146	126	14.4	63	5	6.5	35	115	150
3RW303.	160	55	110	163	140	18	63	5	6.5	30	150	144
3RW304.	170	70	110	181	158	22.5	85	5	10	60	160	160

Distances from grounded parts (mm)	Lateral	Top	Bottom	Fixing screws	Tightening torques (Nm)
3RW301.	5	60	40	M4	1
3RW302.	5	60	40	M4	1
3RW303.	30	60	40	M4	1
3RW304.	30	60	40	M4	2

14.2 3RW40 for standard applications

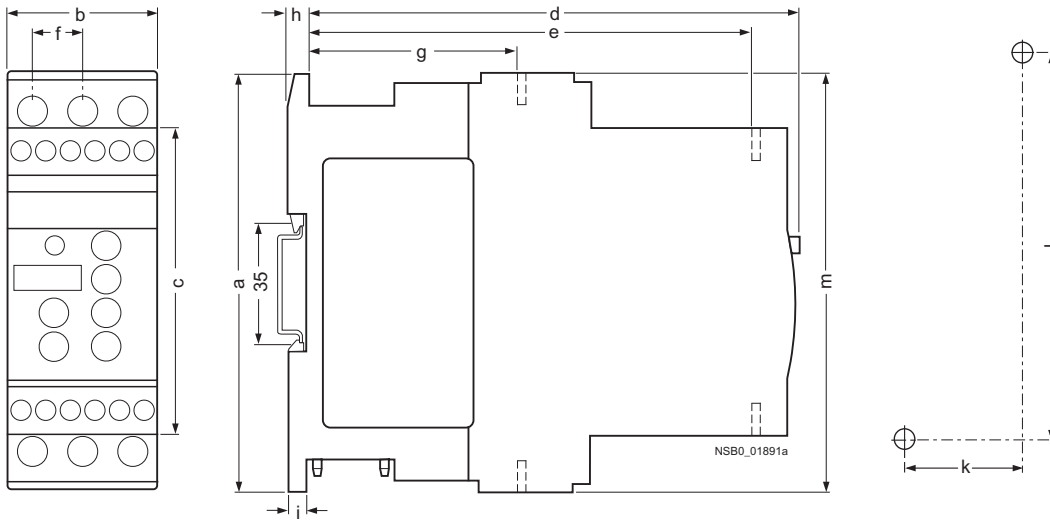

Type / dimensions (mm)	a	b	c	d	e	f	g	h	i	k	l	m
3RW402.-1.	125	45	92	149	126	14.4	63	5	6.5	35	115	125
3RW402.-2.	125	45	92	149	126	14.4	63	5	6.5	35	115	150
3RW403.	160	55	110	165	140	18	63	5	6.5	30	150	144
3RW404.	170	70	110	183	158	22.5	85	5	10	60	160	160

Distances from grounded parts (mm)	Lateral	Top	Bottom	Fixing screws	Tightening torques (Nm)
3RW402.	5	60	40	M4	1
3RW403.	30	60	40	M4	1
3RW404.	30	60	40	M4	2

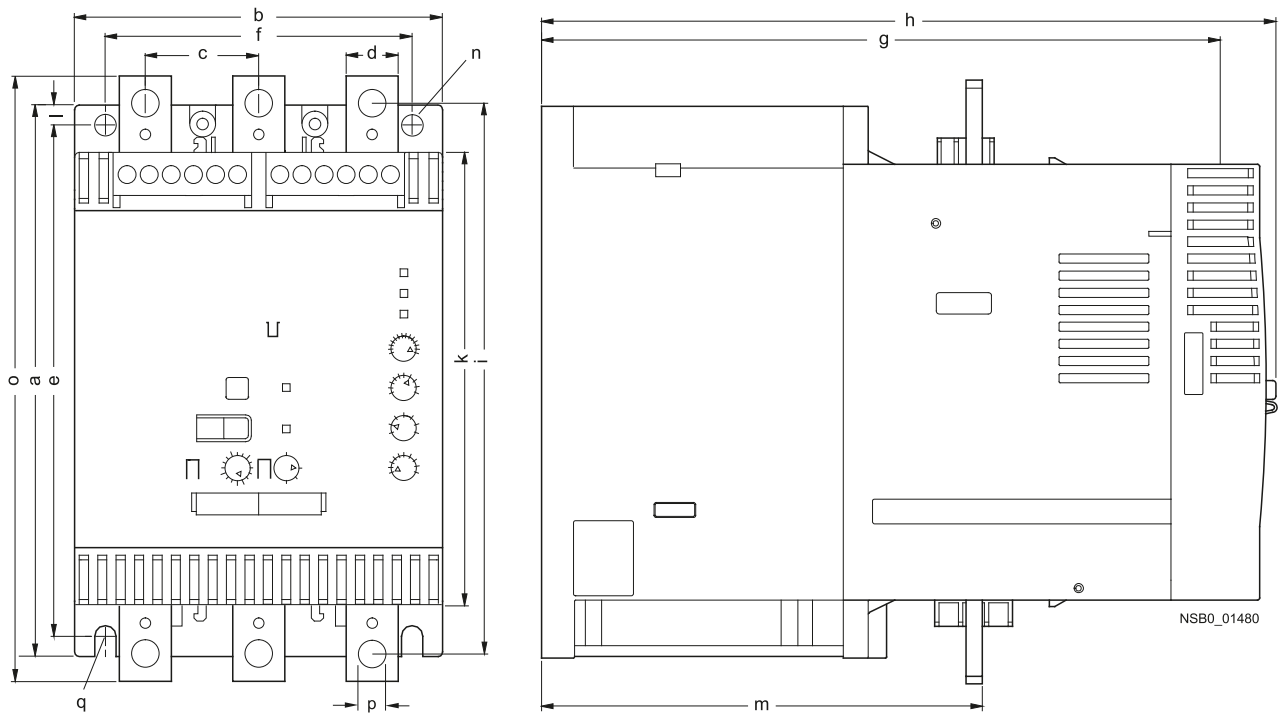

Type / dimensions (mm)	a	b	c	d	e	f	g	h	i	k	l	m	n	o	p	q
3RW405.	180	120	37	17	167	100	223	250	180	148	6.5	153	7	198	9	M6, 10 Nm
3RW407.	210	160	48	25	190	140	240	278	205	166	10	166	9	230	11	M8, 15 Nm

Typical circuit diagrams

15.1 Typical circuit for the optional thermistor motor protection evaluation

A thermistor motor protection evaluation function is optionally available for the 24 V AC/DC control voltage version of the 3RW40 2 to 3RW40 4.

Note

If a thermistor is connected (PTC type A or Klixon), you must remove the copper jumper between terminals T11/T21 and T22.

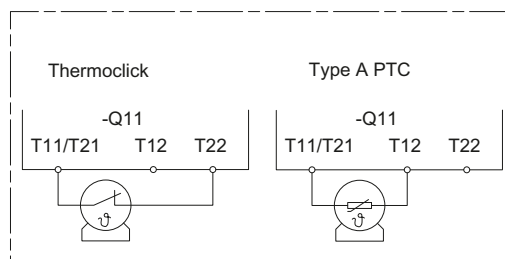

Figure 15-1 Optional thermistor motor protection evaluation

15.2 Control by pushbutton

15.2.1 Control of the 3RW30 by pushbutton

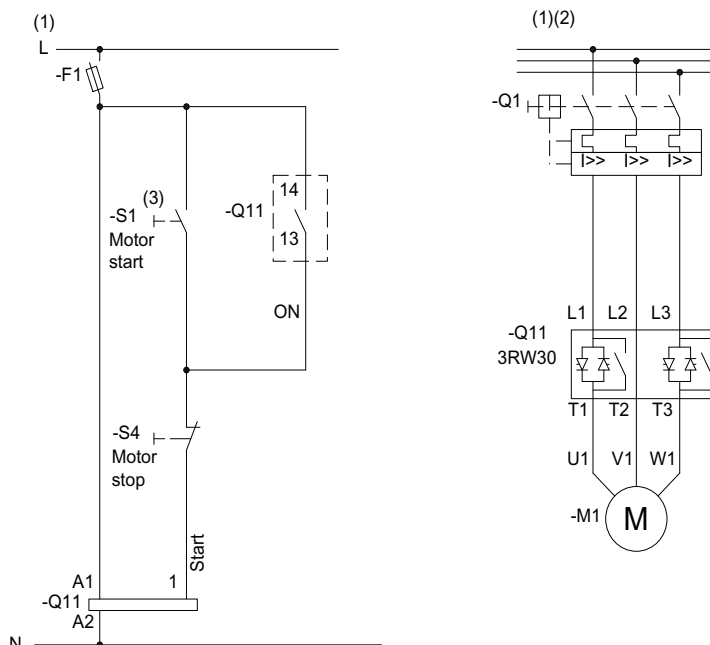

Figure 15-2 Wiring of the 3RW30 control and main circuits

(1) For the permissible values for the main and control voltage (dependent on the MLFB), refer to chapter Technical data [Page 121] .

(2) Alternatively, the motor feeder can be assembled as a fuseless or fused version with type of coordination 1 or 2. For the assignment of fuses and switching devices, refer to chapter Technical data [Page 121]

⚠ WARNING

(3) Automatic restart. Can result in death, serious injury, or property damage.

Faults caused by incorrect control voltage, a missing load, or a phase failure (refer to chapter 3RW30: LEDs and troubleshooting [Page 44]) are automatically reset when the system returns to normal. An automatic restart is initiated and the 3RW restarted if a start command is present at the input.

If you do not want the motor to start automatically, you must integrate suitable additional components, e.g. phase failure or load monitoring devices, into the control and main circuits.

15.2.2 Control of the 3RW40 by pushbutton

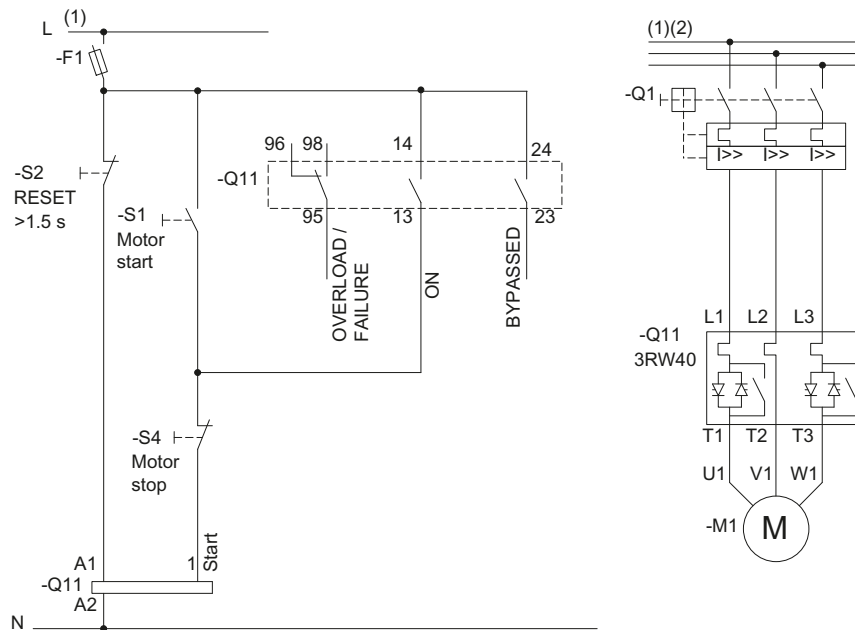

Figure 15-3 Wiring of the 3RW40 2 to 3RW40 4 control circuit and the 3RW40 2 to 3RW40 7 main circuit

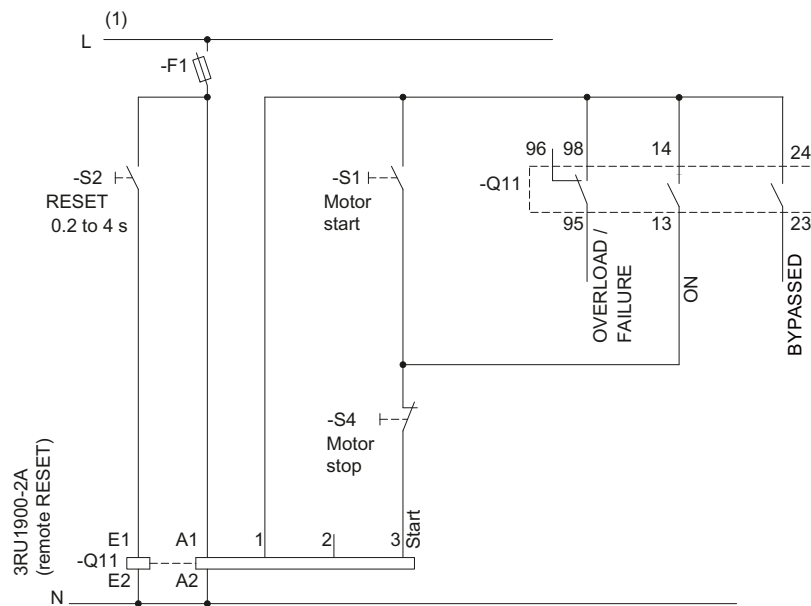

Figure 15-4 Wiring of the 3RW40 5 to 3RW40 7 control circuit

(1) For the permissible values for the main and control voltage (dependent on the MLFB), refer to chapter Technical data [Page 121].

(2) Alternatively, the motor feeder can be assembled as a fuseless or fused version with type of coordination 1 or 2. For the assignment of fuses and switching devices, refer to chapter Technical data [Page 121].

For the optional thermistor motor protection evaluation, refer to Typical circuit for the optional thermistor motor protection evaluation [Page 167].

15.3 Control by switch

15.3.1 Control of the 3RW30 by switch

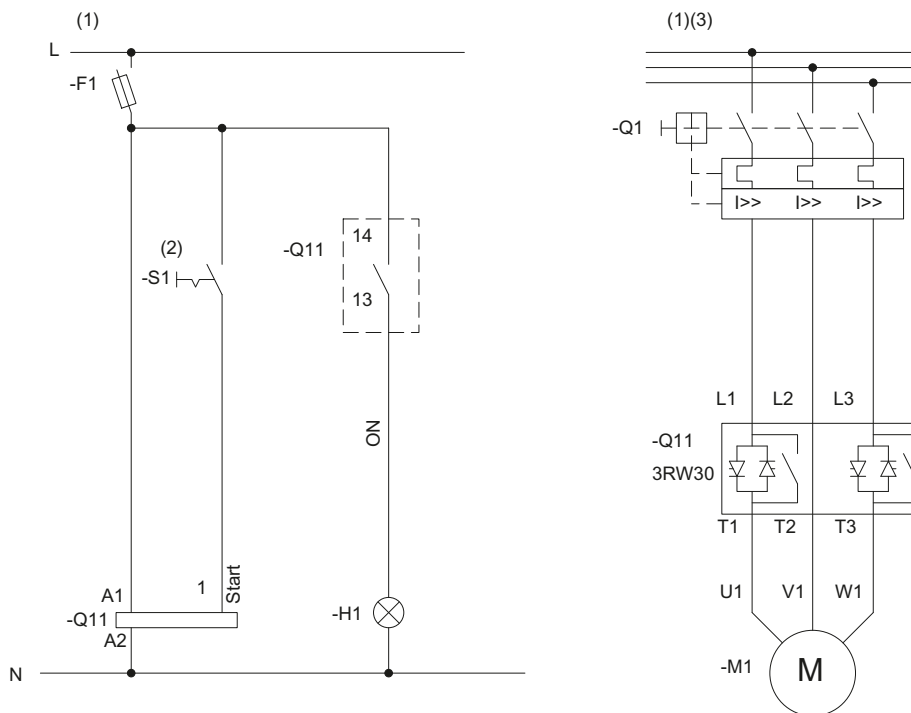

Figure 15-5 Wiring of the control and main circuits

(1) For the permissible values for the main and control voltage (dependent on the MLFB), refer to chapter Technical data [Page 121] .

⚠ WARNING

(2) Automatic restart. Can result in death, serious injury, or property damage.

Faults caused by incorrect control voltage, a missing load, or a phase failure (refer to chapter 3RW30: LEDs and troubleshooting [Page 44]) are automatically reset when the system returns to normal. An automatic restart is initiated and the 3RW restarted if a start command is present at the input.

If you do not want the motor to start automatically, you must integrate suitable additional components, e.g. phase failure or load monitoring devices, into the control and main circuits.

(3) Alternatively, the motor feeder can be assembled as a fuseless or fused version with type of coordination 1 or 2. For the assignment of fuses and switching devices, refer to chapter Technical data [Page 121]

15.3.2 Control of the 3RW40 by switch

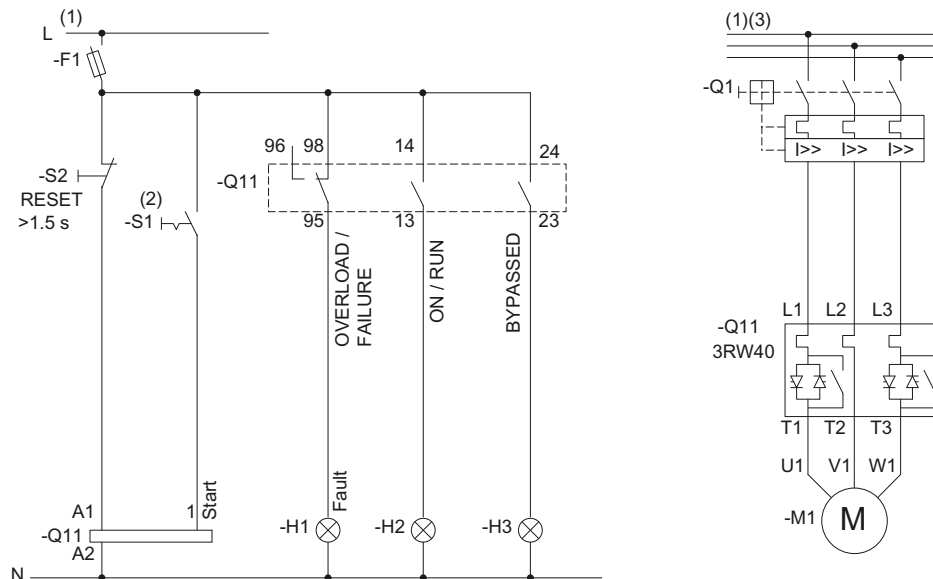

Figure 15-6 Wiring of the 3RW40 2 to 3RW40 4 control circuit and the 3RW40 2 to 3RW40 7 main circuit

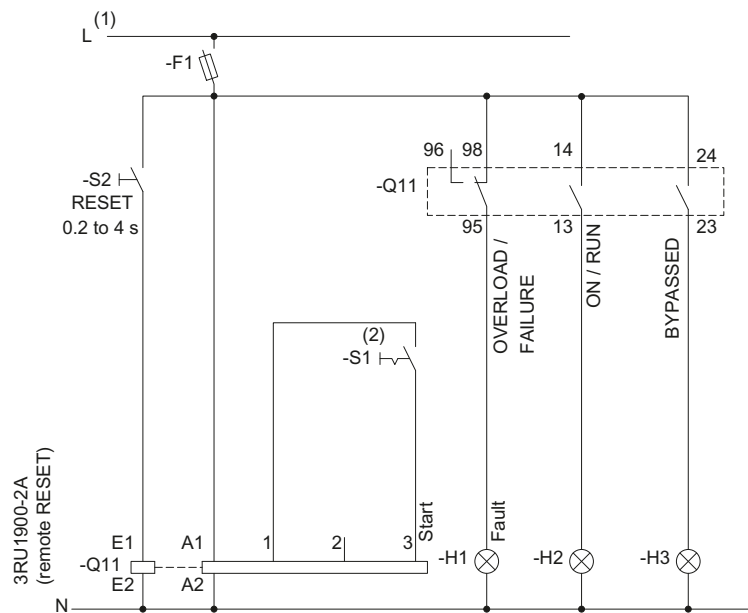

Figure 15-7 Wiring of the 3RW40 5 to 3RW40 7 control circuit

(1) For the permissible values for the main and control voltage (dependent on the MLFB), refer to chapter Technical data [Page 121].

⚠ WARNING

(2) Automatic restart.

Can result in death, serious injury, or property damage.

The start command (e.g. issued by the PLC or switch S1) must be reset prior to issuing a RESET command because the motor attempts to restart again automatically following this RESET command if a start command is still present. This particularly applies if the motor protection has tripped. For safety reasons, you are advised to integrate the group fault output (terminals 95 and 96) in the controller.

(3) Alternatively, the motor feeder can be assembled as a fuseless or fused version with type of coordination 1 or 2. For the assignment of fuses and switching devices, refer to chapter Technical data [Page 121]

For the optional thermistor motor protection evaluation, refer to Typical circuit for the optional thermistor motor protection evaluation [Page 167].

15.4 Control in automatic mode

15.4.1 Control of the 3RW30 in automatic mode

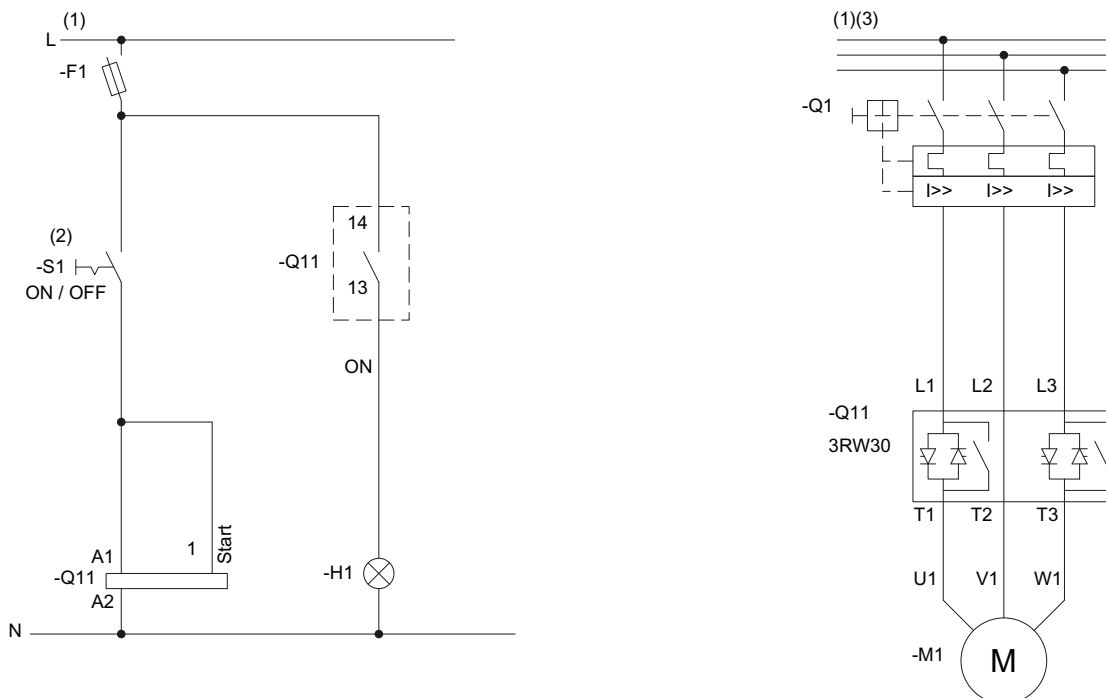

Figure 15-8 Wiring of the 3RW30 control and main circuits

(1) For the permissible values for the main and control voltage (dependent on the MLFB), refer to chapter Technical data [Page 121].

⚠ WARNING

(2) Automatic restart. Can result in death, serious injury, or property damage.

Faults caused by incorrect control voltage, a missing load, or a phase failure (refer to chapter 3RW30: LEDs and troubleshooting [Page 44]) are automatically reset when the system returns to normal. An automatic restart is initiated and the 3RW restarted if a start command is present at the input.

If you do not want the motor to start automatically, you must integrate suitable additional components, e.g. phase failure or load monitoring devices, into the control and main circuits.

(3) Alternatively, the motor feeder can be assembled as a fuseless or fused version with type of coordination 1 or 2. For the assignment of fuses and switching devices, refer to chapter Technical data [Page 121]

15.4.2 Control of the 3RW40 in automatic mode

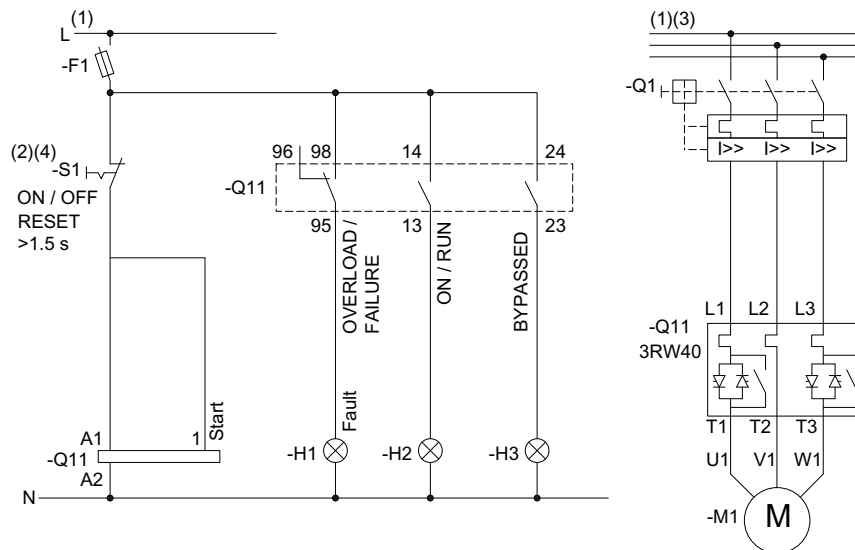

Figure 15-9 Wiring of the 3RW40 2 to 3RW40 4 control circuit and the 3RW40 2 to 3RW40 7 main circuit

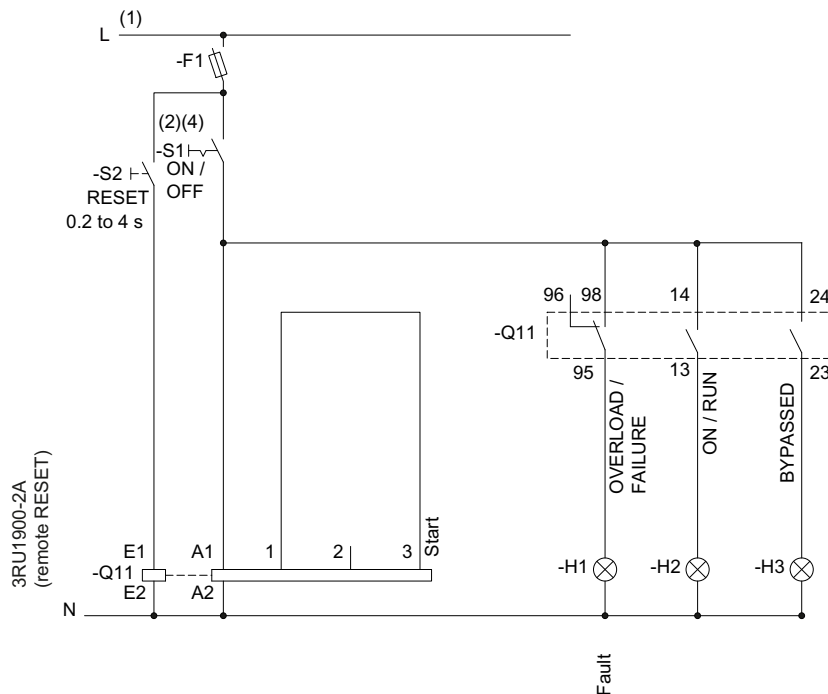

Figure 15-10 Wiring of the 3RW40 5 to 3RW40 7 control circuit

(1) For the permissible values for the main and control voltage (dependent on the MLFB), refer to chapter Technical data [Page 121].

WARNING

(2) Automatic restart.

Can result in death, serious injury, or property damage.

The start command (e.g. issued by the PLC or switch S1) must be reset prior to issuing a RESET command because the motor attempts to restart again automatically following this RESET command if a start command is still present. This particularly applies if the motor protection has tripped. For safety reasons, you are advised to integrate the group fault output (terminals 95 and 96) in the controller.

(3) Alternatively, the motor feeder can be assembled as a fuseless or fused version with type of coordination 1 or 2. For the assignment of fuses and switching devices, refer to chapter Technical data [Page 121]

Note

(4) Idle time until restart.

Owing to the intrinsic protection (3RW), an idle time of at least five minutes must be allowed prior to restarting if the device is switched on and off by means of the control voltage under field conditions.

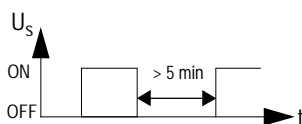

For the optional thermistor motor protection evaluation, refer to Typical circuit for the optional thermistor motor protection evaluation [Page 167].

15.5 Control by PLC

15.5.1 Control of the 3RW30 with 24 V DC by PLC

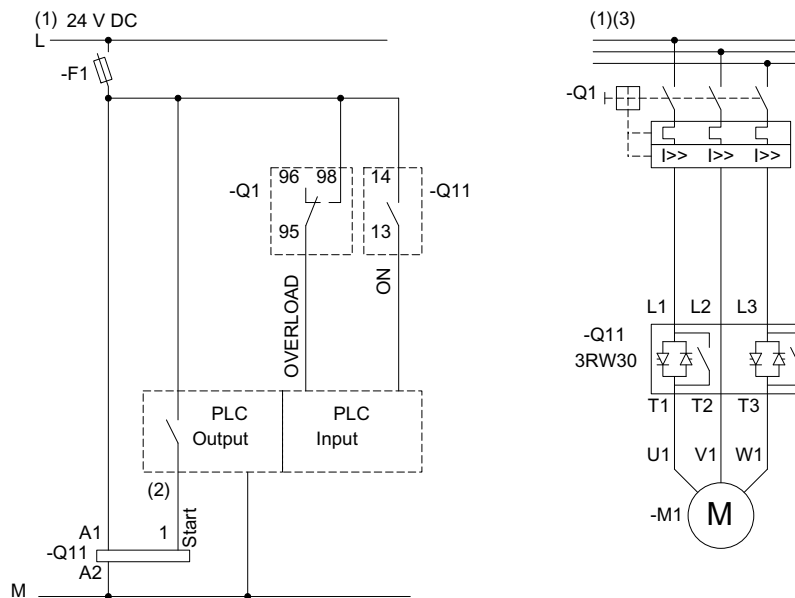

Figure 15-11 Wiring of the 3RW30 control and main circuits

(1) For the permissible values for the main and control voltage (dependent on the MLFB), refer to chapter Technical data [Page 121].

⚠ WARNING

(2) Automatic restart. Can result in death, serious injury, or property damage.

Faults caused by incorrect control voltage, a missing load, or a phase failure (refer to chapter 3RW30: LEDs and troubleshooting [Page 44]) are automatically reset when the system returns to normal. An automatic restart is initiated and the 3RW restarted if a start command is present at the input.

If you do not want the motor to start automatically, you must integrate suitable additional components, e.g. phase failure or load monitoring devices, into the control and main circuits.

(3) Alternatively, the motor feeder can be assembled as a fuseless or fused version with type of coordination 1 or 2. For the assignment of fuses and switching devices, refer to chapter Technical data [Page 121]

15.5.2 Control of the 3RW40 by PLC

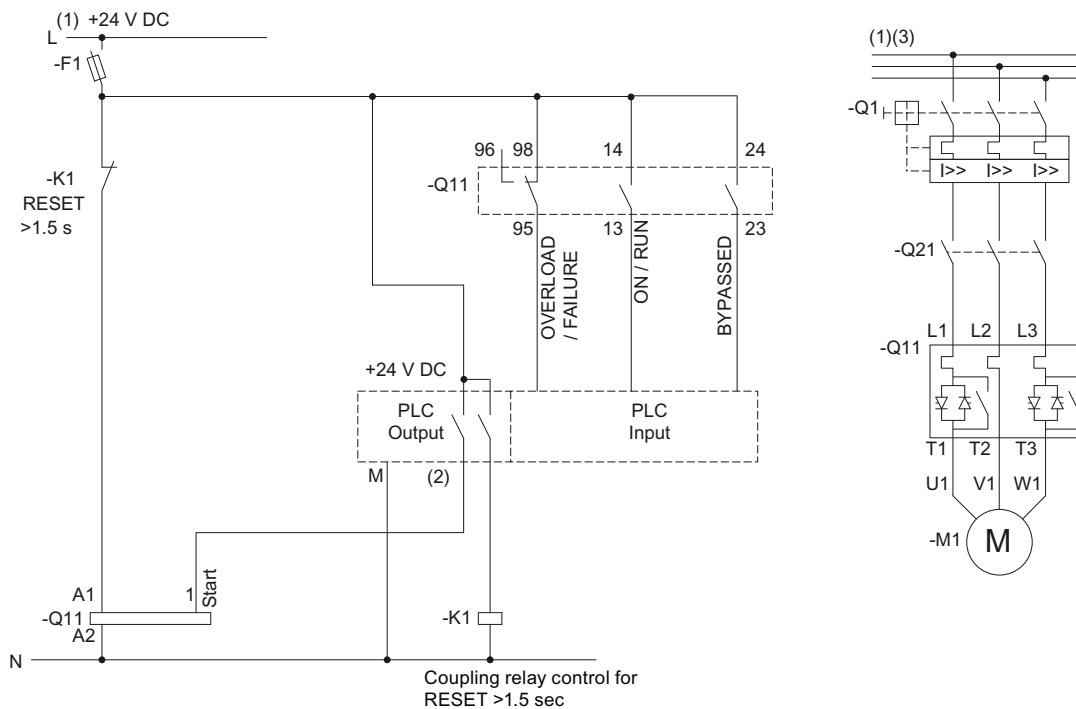

Figure 15-12 Wiring of the 3RW40 2 to 3RW40 4 control circuit (with 24 V control voltage) and the 3RW40 2 to 3RW40 7 main circuit

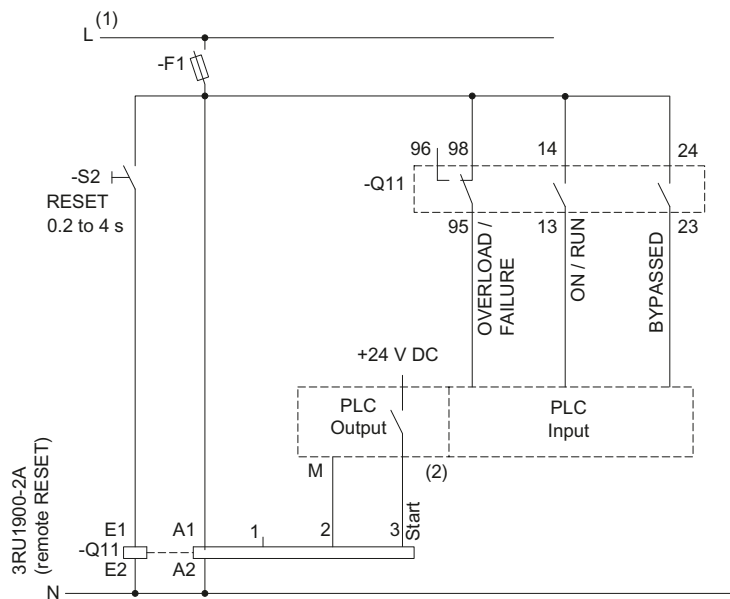

Figure 15-13 Wiring of the 3RW40 5 to 3RW40 7 control circuit

(1) For the permissible values for the main and control voltage (dependent on the MLFB), refer to chapter Technical data [Page 121] .

⚠ WARNING

(2) Automatic restart.
Can result in death, serious injury, or property damage.

The start command (e.g. issued by the PLC or switch S1) must be reset prior to issuing a RESET command because the motor attempts to restart again automatically following this RESET command if a start command is still present. This particularly applies if the motor protection has tripped. For safety reasons, you are advised to integrate the group fault output (terminals 95 and 96) in the controller.

(3) Alternatively, the motor feeder can be assembled as a fuseless or fused version with type of coordination 1 or 2. For the assignment of fuses and switching devices, refer to chapter Technical data [Page 121]

For the optional thermistor motor protection evaluation, refer to Typical circuit for the optional thermistor motor protection evaluation [Page 167].

15.6 Control with an optional main / line contactor

15.6.1 Control of the 3RW30 with a main contactor

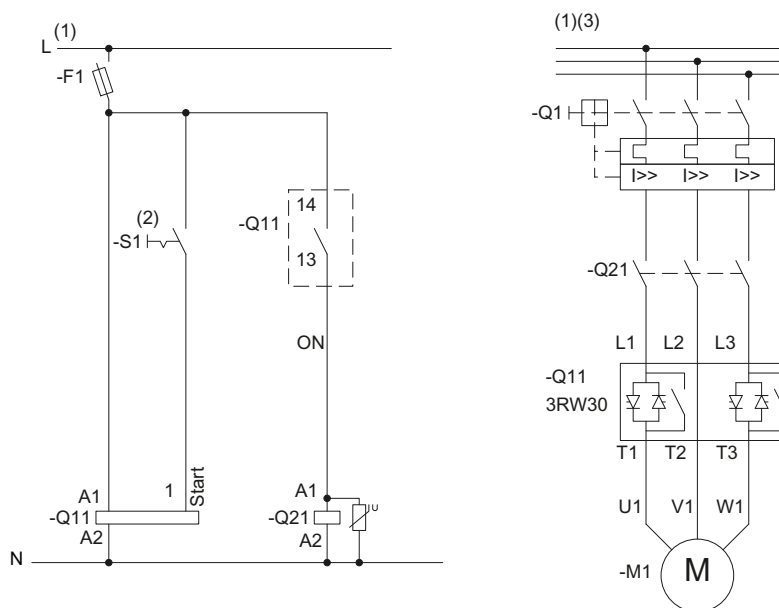

Figure 15-14 Wiring of the 3RW30 control and main circuits

(1) For the permissible values for the main and control voltage (dependent on the MLFB), refer to chapter Technical data [Page 121].

⚠ WARNING

(2) Automatic restart. Can result in death, serious injury, or property damage.

Faults caused by incorrect control voltage, a missing load, or a phase failure (refer to chapter 3RW30: LEDs and troubleshooting [Page 44]) are automatically reset when the system returns to normal. An automatic restart is initiated and the 3RW restarted if a start command is present at the input.

If you do not want the motor to start automatically, you must integrate suitable additional components, e.g. phase failure or load monitoring devices, into the control and main circuits.

(3) Alternatively, the motor feeder can be assembled as a fuseless or fused version with type of coordination 1 or 2. For the assignment of fuses and switching devices, refer to chapter Technical data [Page 121]

15.6.2 Control of the 3RW40 with a main contactor

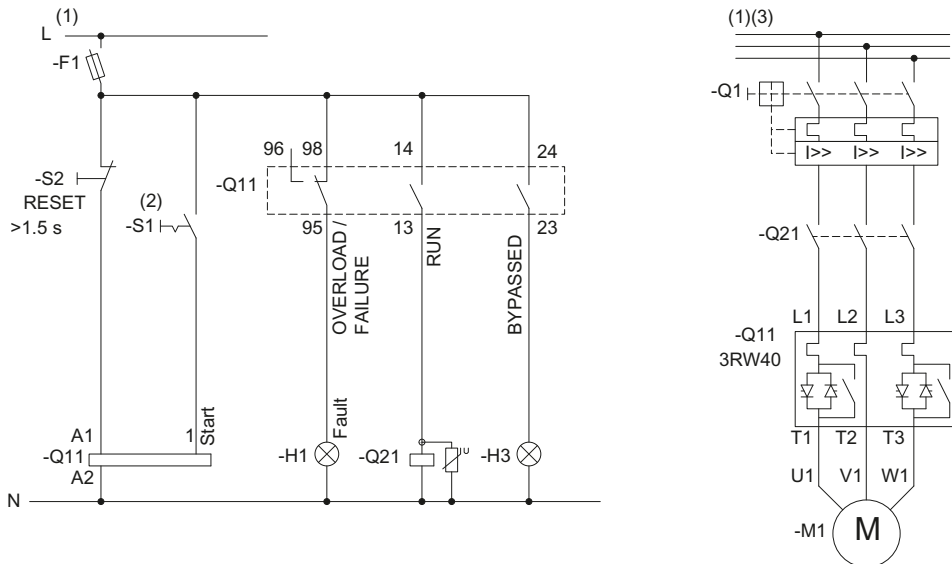

Figure 15-15 Wiring of the 3RW40 2 to 3RW40 4 control circuit and the 3RW40 2 to 3RW40 7 main circuit

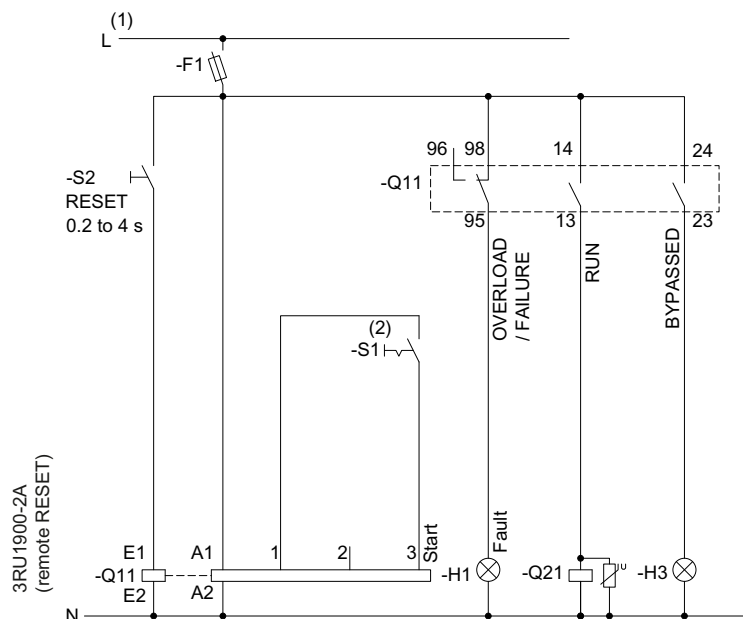



Figure 15-16 Wiring of the 3RW40 5 to 3RW40 7 control circuit

Note

If a soft stop is required, the function of output 13/14 must be reparameterized to "RUN" (refer to Commissioning the 3RW40 [Page 98]).

(1) For the permissible values for the main and control voltage (dependent on the MLFB), refer to chapter Technical data [Page 121].

 WARNING
<p>(2) Automatic restart. Can result in death, serious injury, or property damage.</p> <p>The start command (e.g. issued by the PLC or switch S1) must be reset prior to issuing a RESET command because the motor attempts to restart again automatically following this RESET command if a start command is still present. This particularly applies if the motor protection has tripped. For safety reasons, you are advised to integrate the group fault output (terminals 95 and 96) in the controller.</p>

(3) Alternatively, the motor feeder can be assembled as a fuseless or fused version with type of coordination 1 or 2. For the assignment of fuses and switching devices, refer to chapter Technical data [Page 121]

For the optional thermistor motor protection evaluation, refer to Typical circuit for the optional thermistor motor protection evaluation [Page 167].

15.7 Reversing circuit

15.7.1 3RW30 reversing circuit

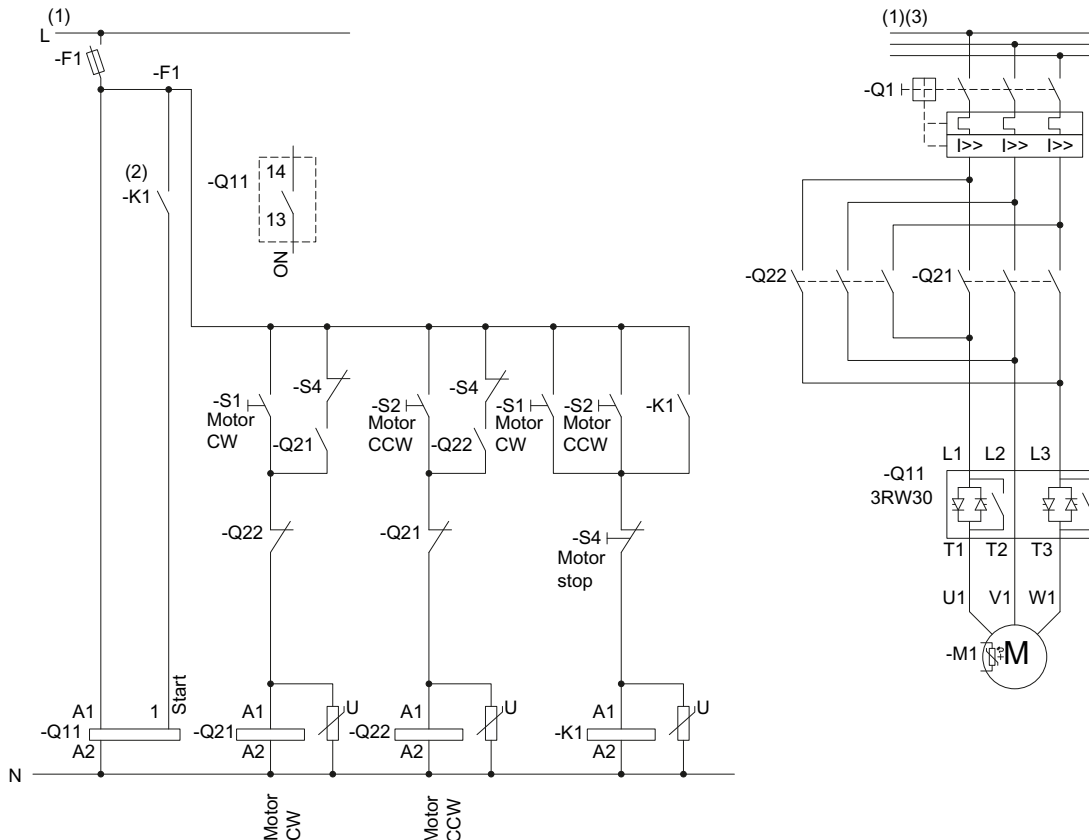

Figure 15-17 Wiring of the 3RW30 control and main circuits

(1) For the permissible values for the main and control voltage (dependent on the MLFB), refer to chapter Technical data [Page 121] .

⚠ WARNING

(2) Automatic restart. Can result in death, serious injury, or property damage.

Faults caused by incorrect control voltage, a missing load, or a phase failure (refer to chapter 3RW30: LEDs and troubleshooting [Page 44]) are automatically reset when the system returns to normal. An automatic restart is initiated and the 3RW restarted if a start command is present at the input.

If you do not want the motor to start automatically, you must integrate suitable additional components, e.g. phase failure or load monitoring devices, into the control and main circuits.

(3) Alternatively, the motor feeder can be assembled as a fuseless or fused version with type of coordination 1 or 2. For the assignment of fuses and switching devices, refer to chapter Technical data [Page 121]

15.7.2 3RW40 reversing circuit

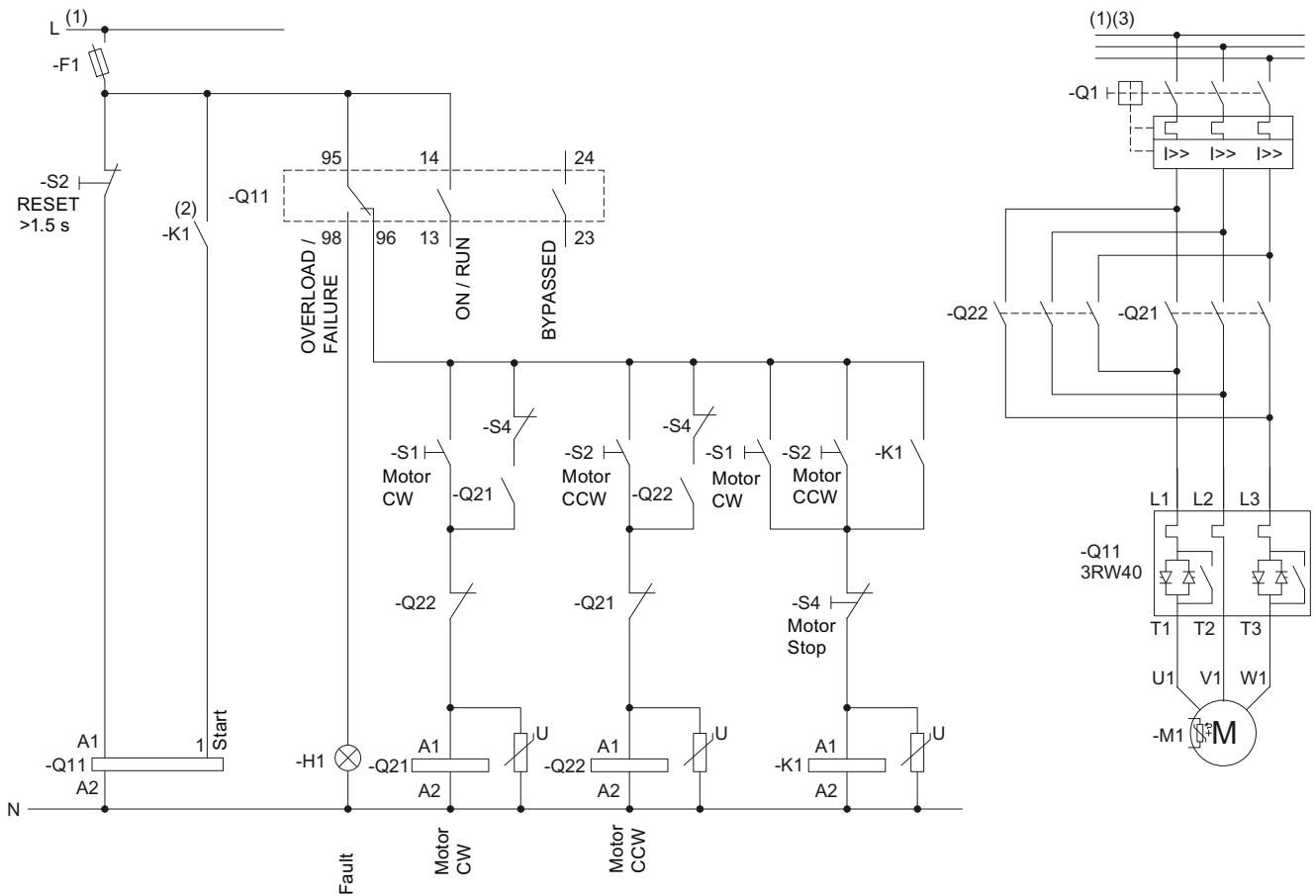

Figure 15-18 Wiring of the 3RW40 2 to 3RW40 5 control circuit and the 3RW40 2 to 3RW40 7 main circuit

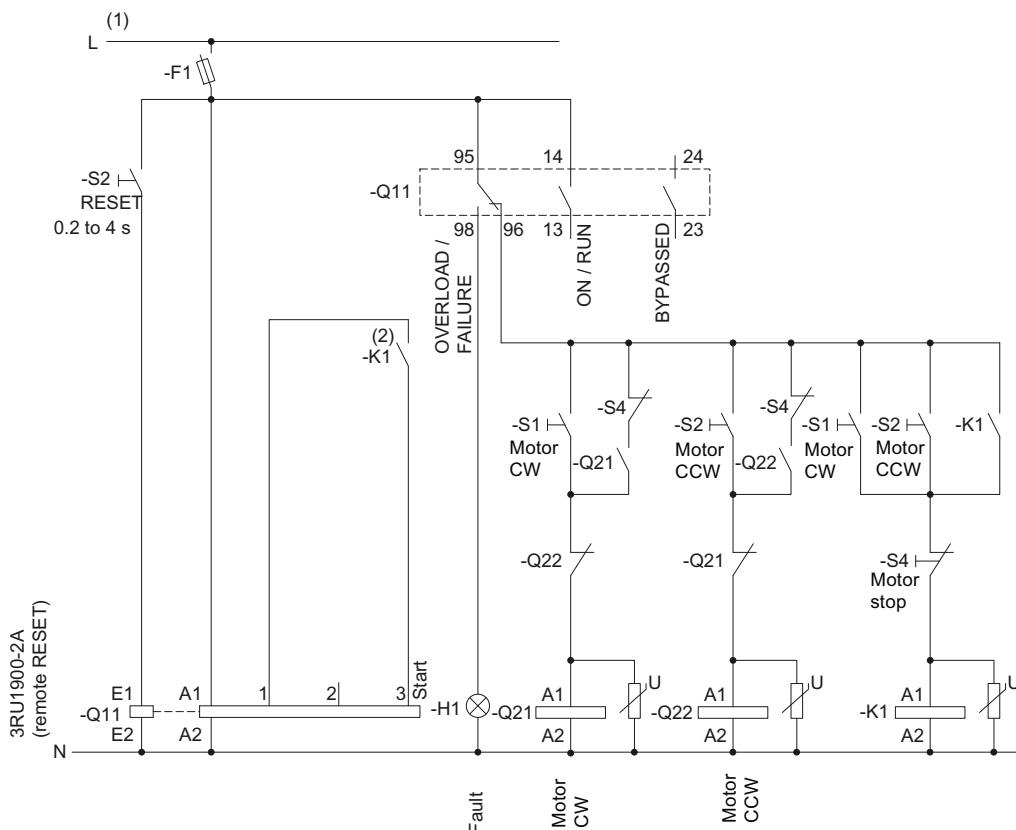



Figure 15-19 Wiring of the 3RW40 5 to 3RW40 7 control circuit

(1) For the permissible values for the main and control voltage (dependent on the MLFB), refer to chapter Technical data [Page 121] .

 WARNING
<p>(2) Automatic restart. Can result in death, serious injury, or property damage.</p> <p>The start command (e.g. issued by the PLC or switch S1) must be reset prior to issuing a RESET command because the motor attempts to restart again automatically following this RESET command if a start command is still present. This particularly applies if the motor protection has tripped. For safety reasons, you are advised to integrate the group fault output (terminals 95 and 96) in the controller.</p>

(3) Alternatively, the motor feeder can be assembled as a fuseless or fused version with type of coordination 1 or 2. For the assignment of fuses and switching devices, refer to chapter Technical data [Page 121]

For the optional thermistor motor protection evaluation, refer to Typical circuit for the optional thermistor motor protection evaluation [Page 167].

<p>NOTICE</p> <p>No soft stop possible. Set the ramp-down time to 0 s with the potentiometer.</p>
--

15.8 Control of a magnetic parking brake

15.8.1 3RW30 motor with magnetic parking brake

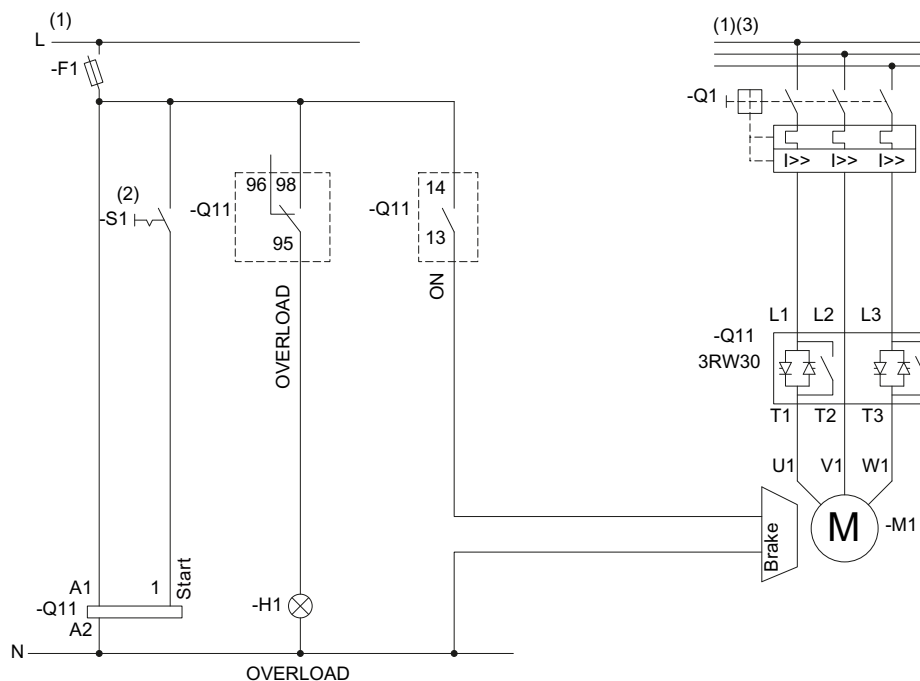



Figure 15-20 Wiring of the 3RW30 control and main circuits

(1) For the permissible values for the main and control voltage (dependent on the MLFB), refer to chapter Technical data [Page 121] .

 WARNING
<p>(2) Automatic restart. Can result in death, serious injury, or property damage.</p> <p>Faults caused by incorrect control voltage, a missing load, or a phase failure (refer to chapter 3RW30: LEDs and troubleshooting [Page 44]) are automatically reset when the system returns to normal. An automatic restart is initiated and the 3RW restarted if a start command is present at the input.</p> <p>If you do not want the motor to start automatically, you must integrate suitable additional components, e.g. phase failure or load monitoring devices, into the control and main circuits.</p>

(3) Alternatively, the motor feeder can be assembled as a fuseless or fused version with type of coordination 1 or 2. For the assignment of fuses and switching devices, refer to chapter Technical data [Page 121]

15.8.2 3RW40 2 to 3RW40 4, control of a motor with a magnetic parking brake

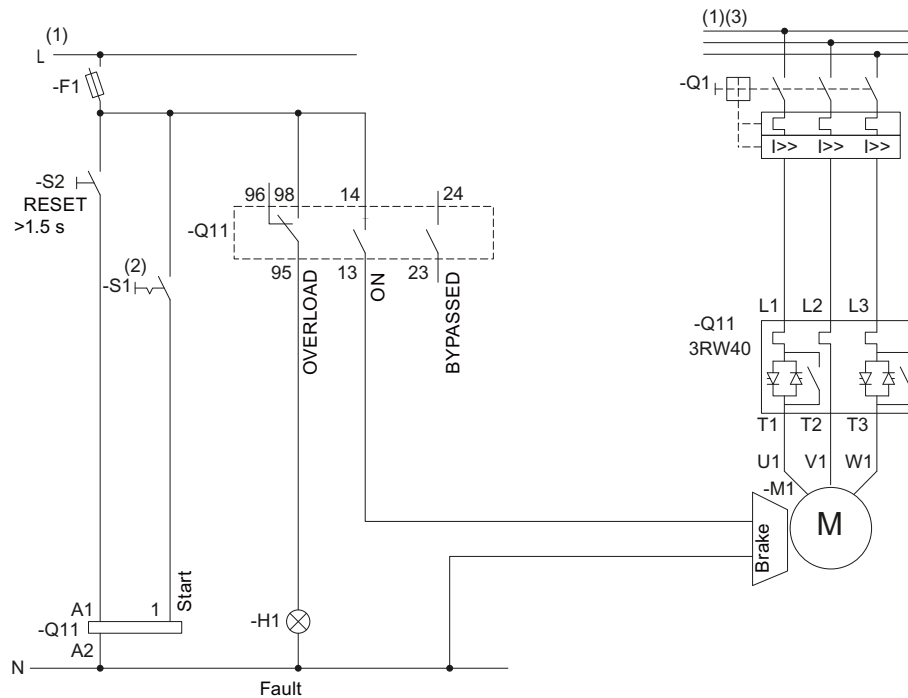

Figure 15-21 Wiring of the 3RW40 2 to 3RW40 4 control / main circuit

(1) For the permissible values for the main and control voltage (dependent on the MLFB), refer to chapter Technical data [Page 121] .

⚠ WARNING

(2) Automatic restart.

Can result in death, serious injury, or property damage.

The start command (e.g. issued by the PLC or switch S1) must be reset prior to issuing a RESET command because the motor attempts to restart again automatically following this RESET command if a start command is still present. This particularly applies if the motor protection has tripped. For safety reasons, you are advised to integrate the group fault output (terminals 95 and 96) in the controller.

(3) Alternatively, the motor feeder can be assembled as a fuseless or fused version with type of coordination 1 or 2. For the assignment of fuses and switching devices, refer to chapter Technical data [Page 121]

For the optional thermistor motor protection evaluation, refer to Typical circuit for the optional thermistor motor protection evaluation [Page 167].

NOTICE

No soft stop possible. Set the ramp-down time to 0 s with the potentiometer.

15.8.3 3RW40 5 to 3RW40 7, control of a motor with a magnetic parking brake

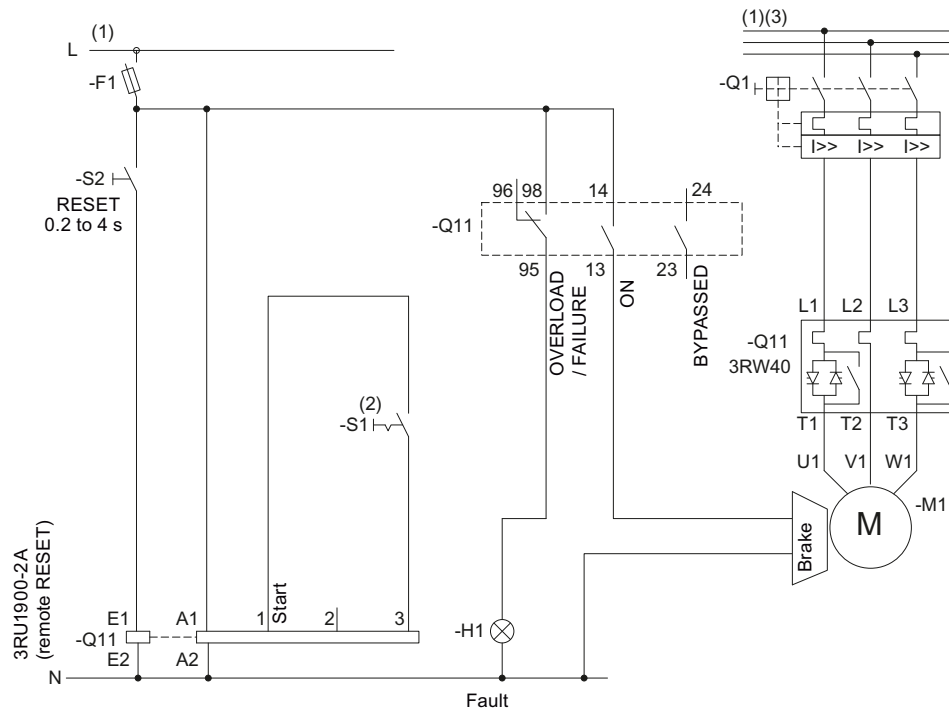

Figure 15-22 Wiring of the 3RW40 5 to 3RW40 7 control / main circuit

(1) For the permissible values for the main and control voltage (dependent on the MLFB), refer to chapter Technical data [Page 121].

WARNING

(2) Automatic restart.

Can result in death, serious injury, or property damage.

The start command (e.g. issued by the PLC or switch S1) must be reset prior to issuing a RESET command because the motor attempts to restart again automatically following this RESET command if a start command is still present. This particularly applies if the motor protection has tripped. For safety reasons, you are advised to integrate the group fault output (terminals 95 and 96) in the controller.

(3) Alternatively, the motor feeder can be assembled as a fuseless or fused version with type of coordination 1 or 2. For the assignment of fuses and switching devices, refer to chapter Technical data [Page 121]

For the optional thermistor motor protection evaluation, refer to Typical circuit for the optional thermistor motor protection evaluation [Page 167].

NOTICE

No soft stop possible. Set the ramp-down time to 0 s with the potentiometer.

15.9 Emergency stop

15.9.1 3RW30 emergency stop and 3TK2823 safety relay

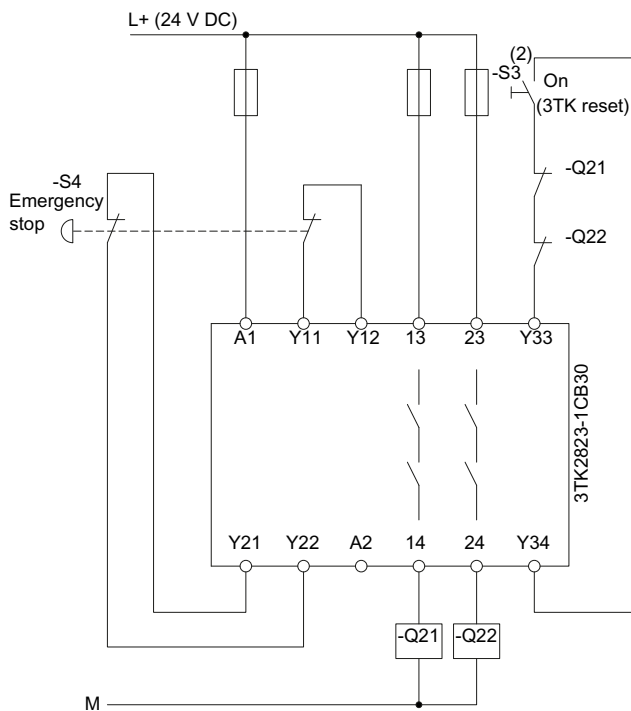

Figure 15-23 Wiring of the emergency stop control circuit and the 3TK28 safety relay

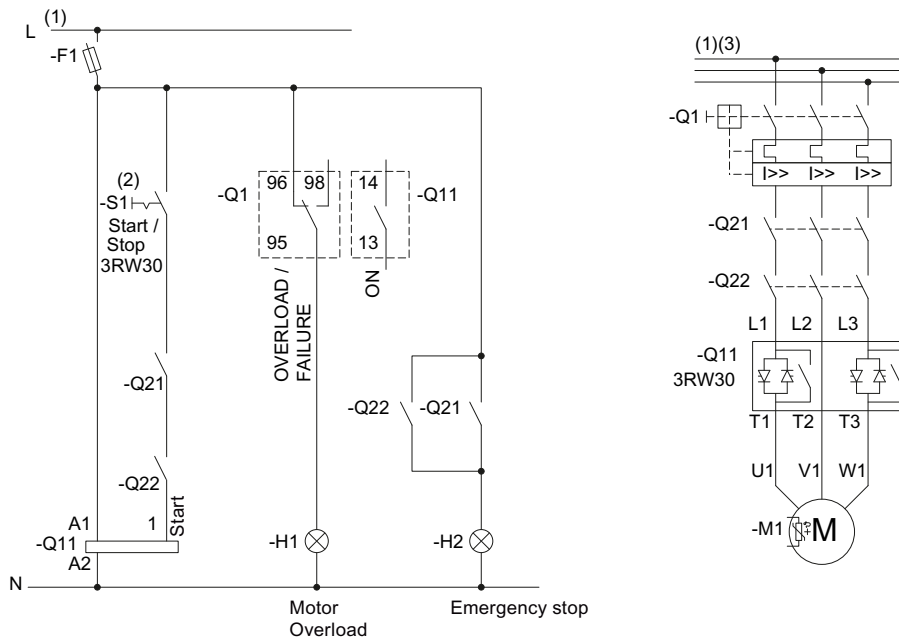



Figure 15-24 Wiring of the 3RW30 control and main circuits

(1) For the permissible values for the main and control voltage (dependent on the MLFB), refer to chapter Technical data [Page 121] .

 WARNING
<p>(2) Automatic restart. Can result in death, serious injury, or property damage.</p> <p>- If the 3TK28 is reset</p> <p>Faults caused by incorrect control voltage, a missing load, or a phase failure (refer to chapter 3RW30: LEDs and troubleshooting [Page 44]) are automatically reset when the system returns to normal.</p> <p>An automatic restart is initiated and the 3RW restarted if a start command is present at the input.</p> <p>If you do not want the motor to start automatically, you must integrate suitable additional components, e.g. phase failure or load monitoring devices, into the control and main circuits.</p>

(3) Alternatively, the motor feeder can be assembled as a fuseless or fused version with type of coordination 1 or 2. For the assignment of fuses and switching devices, refer to chapter Technical data [Page 121]

15.9.2 3RW40 2 to 3RW40 4 emergency stop and 3TK2823 safety relay

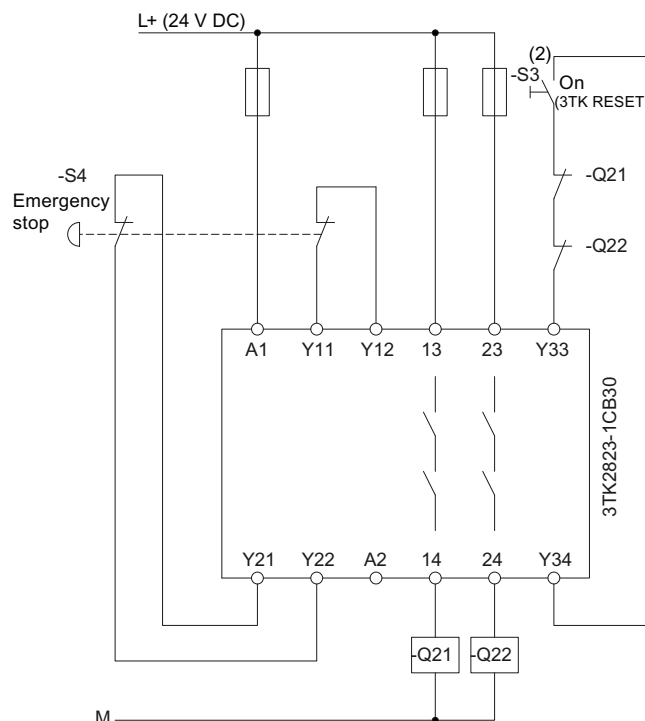

Figure 15-25 Wiring of the emergency stop control circuit and the 3TK28 safety relay

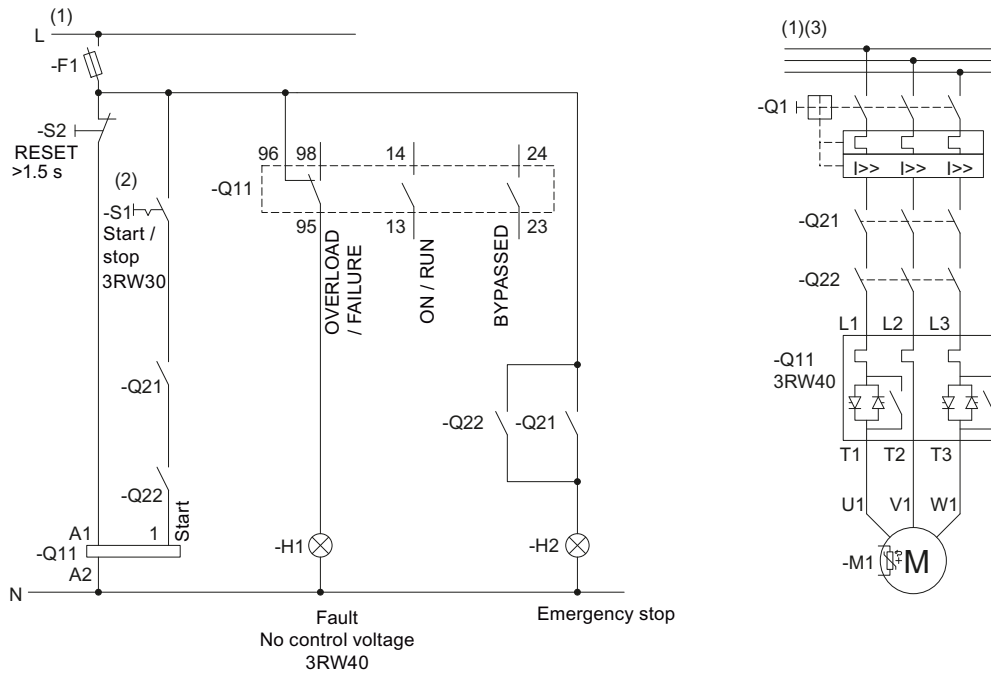

Figure 15-26 Wiring of the 3RW40 2 to 3RW40 4 control circuit and the 3RW40 2 to 3RW40 7 main circuit

(1) For the permissible values for the main and control voltage (dependent on the MLFB), refer to chapter Technical data [Page 121] .

WARNING

(2) Automatic restart.

Can result in death, serious injury, or property damage.

The start command (e.g. issued by the PLC or switch S1) must be reset prior to issuing a RESET command because the motor attempts to restart again automatically following this RESET command (3TK or 3RW) if a start command is still present. This particularly applies if the motor protection has tripped. For safety reasons, you are advised to integrate the group fault output (terminals 95 and 96) in the controller.

(3) Alternatively, the motor feeder can be assembled as a fuseless or fused version with type of coordination 1 or 2. For the assignment of fuses and switching devices, refer to chapter Technical data [Page 121]

For the optional thermistor motor protection evaluation, refer to Typical circuit for the optional thermistor motor protection evaluation [Page 167].

NOTICE

If the soft stop function is set (ramp-down time potentiometer set to >0 s) and the emergency stop circuit is tripped, a "Missing load voltage, phase failure / missing load" fault may be indicated on the soft starter. In this case, the soft starter must be reset according to the selected RESET MODE.

15.9.3 3RW40 5 to 3RW40 7 emergency stop and 3TK2823 safety relay

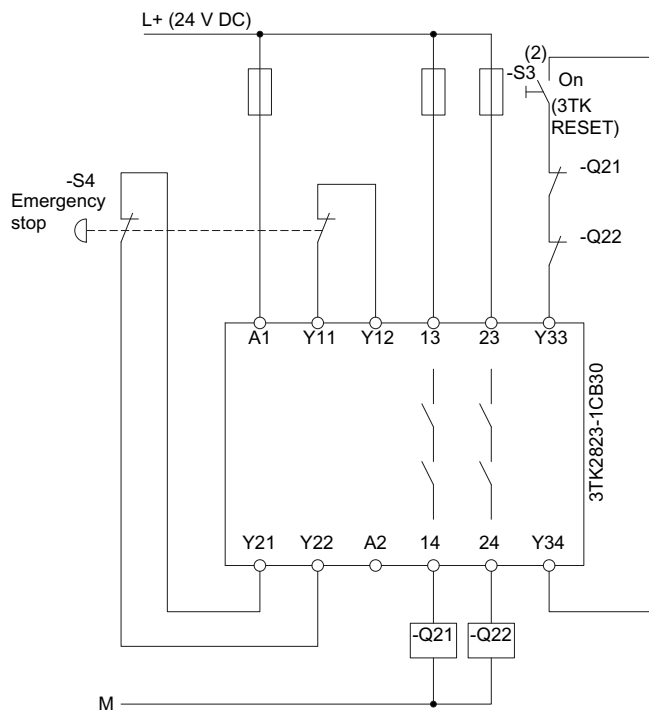

Figure 15-27 Wiring of the emergency stop control circuit and the 3TK28 safety relay

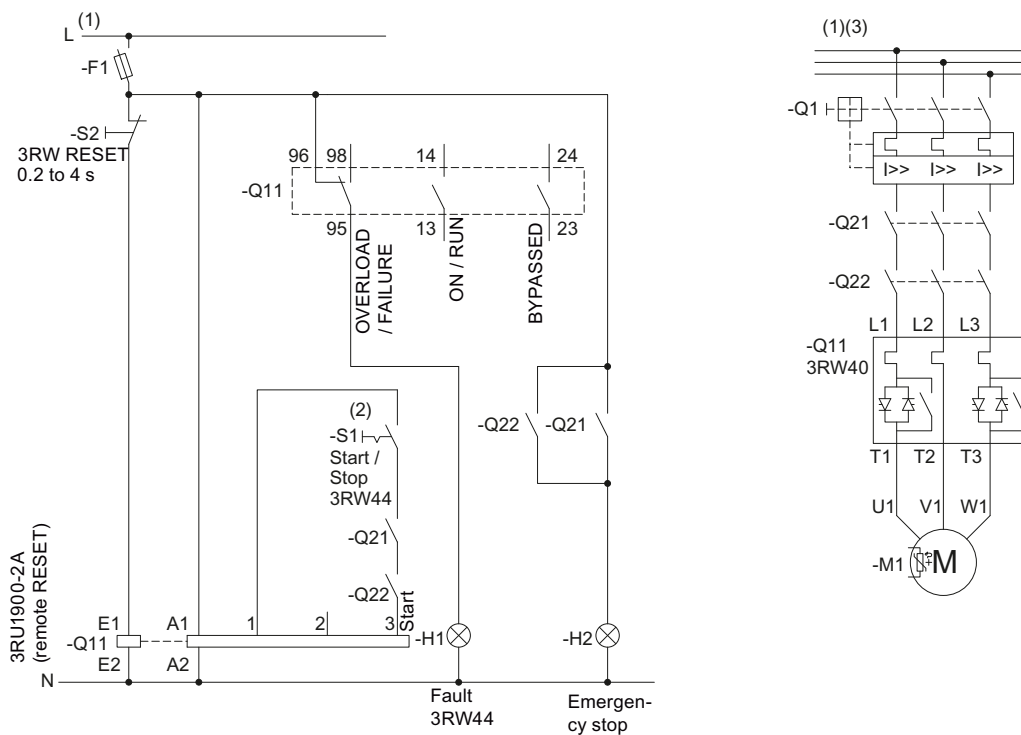

Figure 15-28 Wiring of the 3RW40 5 to 3RW40 7 control circuit and the 3RW40 2 to 3RW40 7 main circuit

(1) For the permissible values for the main and control voltage (dependent on the MLFB), refer to chapter Technical data [Page 121].

 **WARNING**

(2) Automatic restart.

Can result in death, serious injury, or property damage.

The start command (e.g. issued by the PLC or switch S1) must be reset prior to issuing a RESET command because the motor attempts to restart again automatically following this RESET command (3TK or 3RW) if a start command is still present. This particularly applies if the motor protection has tripped. For safety reasons, you are advised to integrate the group fault output (terminals 95 and 96) in the controller.

(3) Alternatively, the motor feeder can be assembled as a fuseless or fused version with type of coordination 1 or 2. For the assignment of fuses and switching devices, refer to chapter Technical data [Page 121]

For the optional thermistor motor protection evaluation, refer to Typical circuit for the optional thermistor motor protection evaluation [Page 167].

NOTICE

If the soft stop function is set (ramp-down time potentiometer set to >0 s) and the emergency stop circuit is tripped, a "Missing load voltage, phase failure / missing load" fault may be indicated on the soft starter. In this case, the soft starter must be reset according to the selected RESET MODE.

15.10 3RW and contactor for emergency starting

15.10.1 3RW30 and contactor for emergency starting

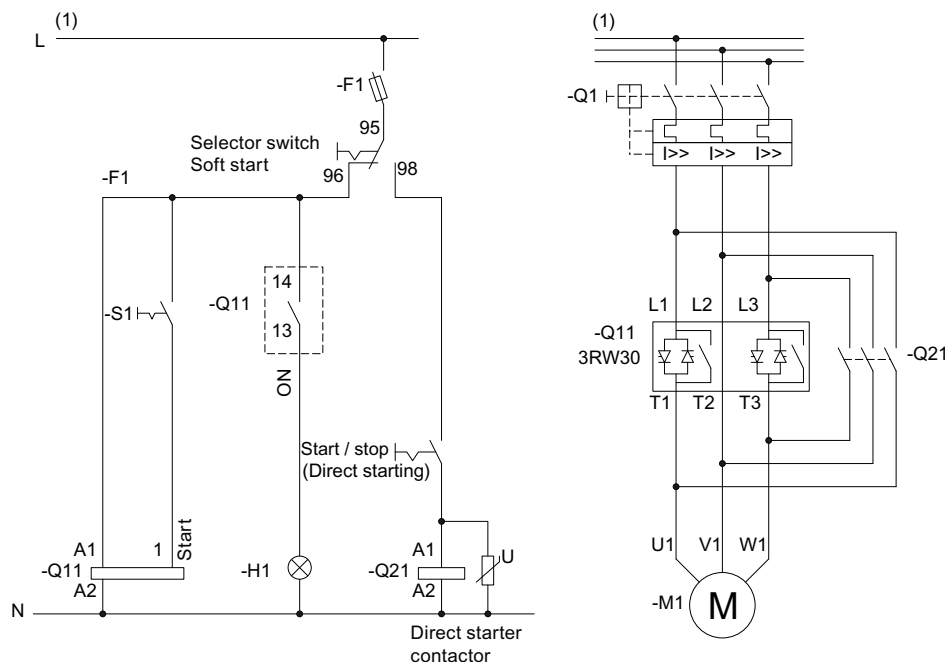

Figure 15-29 Wiring of the 3RW30 control and main circuits

(1) For the permissible values for the main and control voltage (dependent on the MLFB), refer to chapter Technical data [Page 121].

⚠ WARNING

(2) Automatic restart. Can result in death, serious injury, or property damage.

Faults caused by incorrect control voltage, a missing load, or a phase failure (refer to Troubleshooting chapter) are automatically reset when the system returns to normal. An automatic restart is initiated and the 3RW restarted if a start command is present at the input. If you do not want the motor to start automatically, you must integrate suitable additional components, e.g. phase failure or load monitoring devices, into the control and main circuits.

(3) Alternatively, the motor feeder can be assembled as a fuseless or fused version with type of coordination 1 or 2. For the assignment of fuses and switching devices, refer to chapter Technical data [Page 121]

15.10.2 3RW40 and contactor for emergency starting

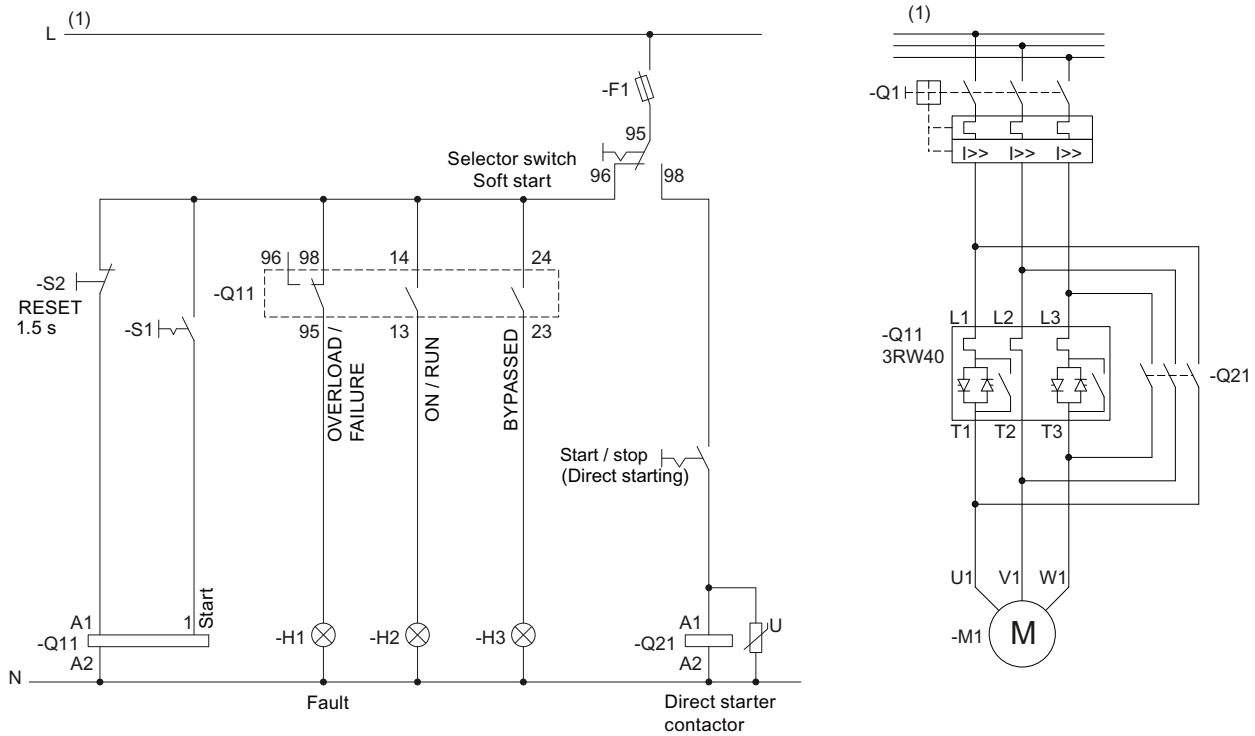

Figure 15-30 Wiring of the 3RW40 2 to 3RW40 4 control circuit and the 3RW40 2 to 3RW40 7 main circuit

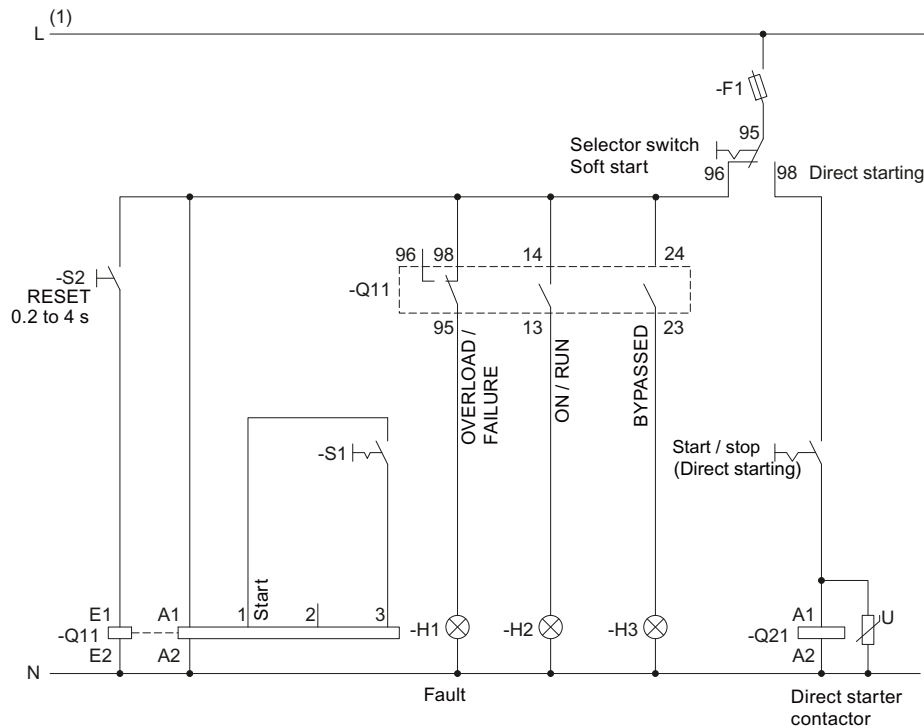

Figure 15-31 Wiring of the 3RW40 5 to 3RW40 7 control circuit

(1) For the permissible values for the main and control voltage (dependent on the MLFB), refer to chapter Technical data [Page 121] .

 **WARNING**

(2) Automatic restart.

Can result in death, serious injury, or property damage.

The start command (e.g. issued by the PLC or switch S1) must be reset prior to issuing a RESET command because the motor attempts to restart again automatically following this RESET command if a start command is still present. This particularly applies if the motor protection has tripped. For safety reasons, you are advised to integrate the group fault output (terminals 95 and 96) in the controller.

(3) Alternatively, the motor feeder can be assembled as a fuseless or fused version with type of coordination 1 or 2. For the assignment of fuses and switching devices, refer to chapter Technical data [Page 121]

For the optional thermistor motor protection evaluation, refer to Typical circuit for the optional thermistor motor protection evaluation [Page 167].

15.11 Dahlander / multispeed motor

15.11.1 3RW30 and Dahlander motor starting

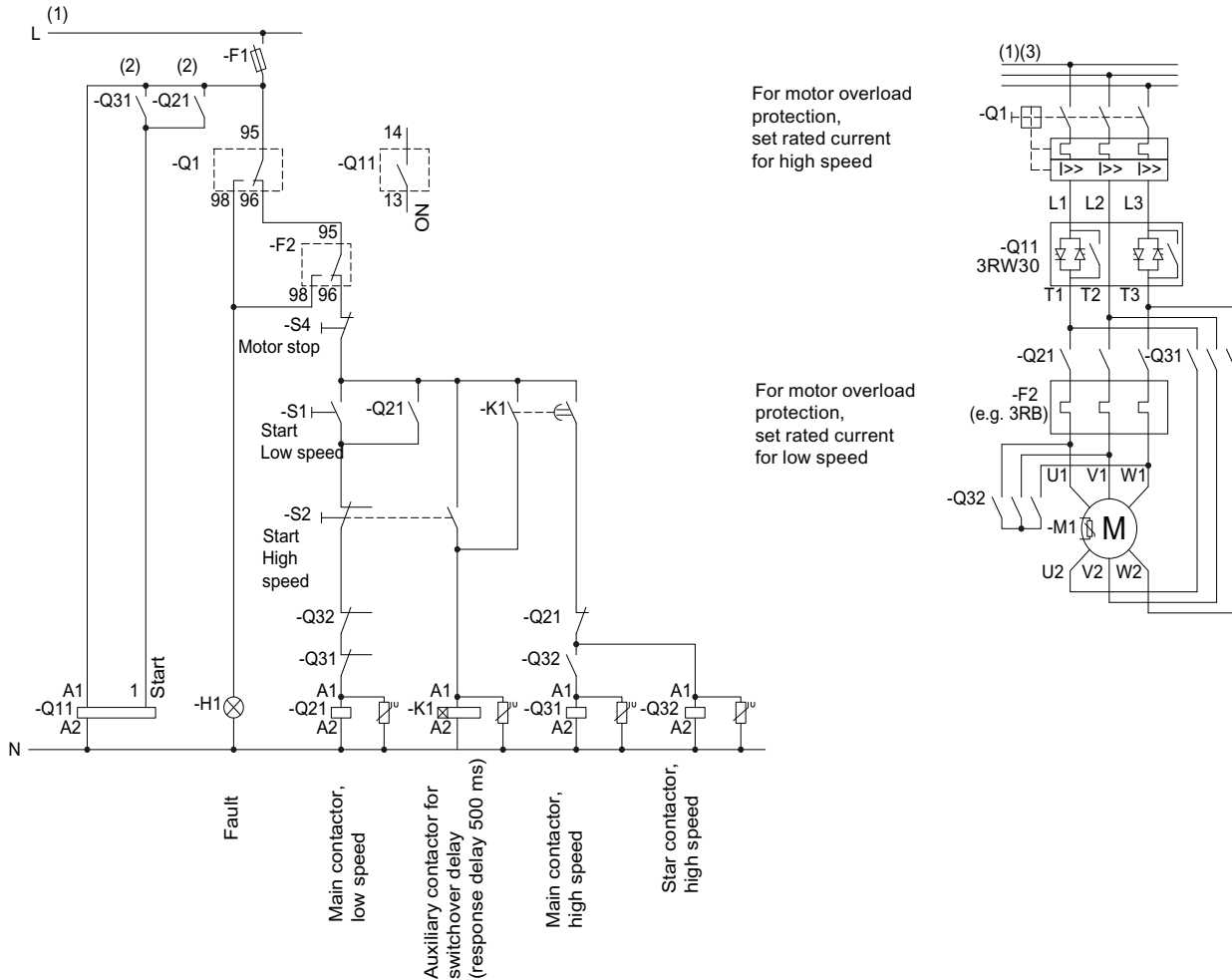

Figure 15-32 Wiring of the 3RW30 control and main circuits

(1) For the permissible values for the main and control voltage (dependent on the MLFB), refer to chapter Technical data [Page 121].

⚠ WARNING

(2) Automatic restart. Can result in death, serious injury, or property damage.

Faults caused by incorrect control voltage, a missing load, or a phase failure (refer to chapter 3RW30: LEDs and troubleshooting [Page 44]) are automatically reset when the system returns to normal. An automatic restart is initiated and the 3RW restarted if a start command is present at the input.

If you do not want the motor to start automatically, you must integrate suitable additional components, e.g. phase failure or load monitoring devices, into the control and main circuits.

(3) Alternatively, the motor feeder can be assembled as a fuseless or fused version with type of coordination 1 or 2. For the assignment of fuses and switching devices, refer to chapter Technical data [Page 121]

15.11.2 3RW40 2 to 3RW40 4 and Dahlander motor starting

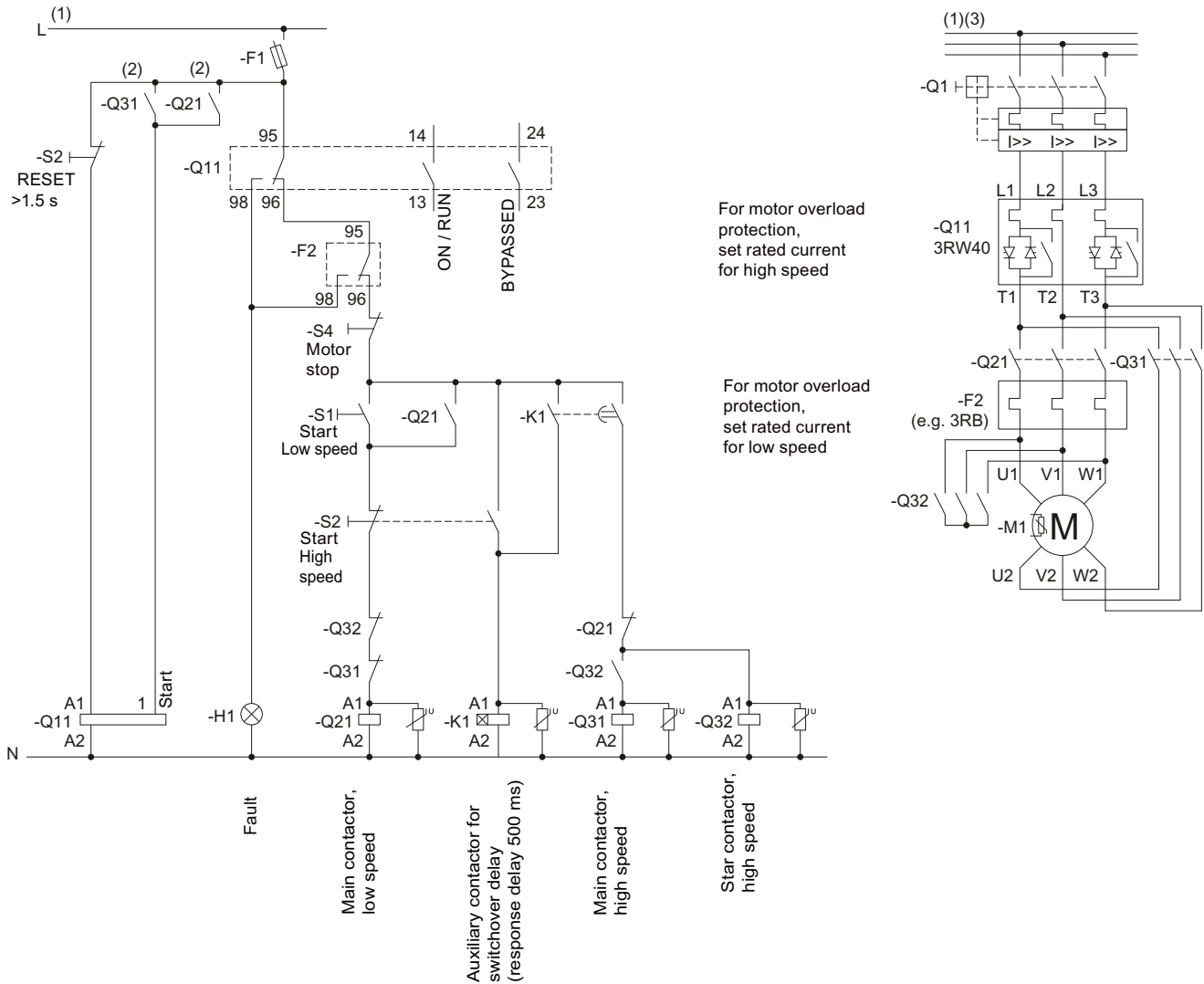



Figure 15-33 Wiring of the 3RW40 2 to 3RW40 4 control circuit and the 3RW40 2 to 3RW40 7 main circuit

(1) For the permissible values for the main and control voltage (dependent on the MLFB), refer to chapter Technical data [Page 121].

 WARNING
<p>(2) Automatic restart. Can result in death, serious injury, or property damage.</p> <p>The start command (e.g. issued by the PLC or switch S1) must be reset prior to issuing a RESET command because the motor attempts to restart again automatically following this RESET command if a start command is still present. This particularly applies if the motor protection has tripped. For safety reasons, you are advised to integrate the group fault output (terminals 95 and 96) in the controller.</p>
<p>(3) Alternatively, the motor feeder can be assembled as a fuseless or fused version with type of coordination 1 or 2. For the assignment of fuses and switching devices, refer to chapter Technical data [Page 121]</p> <p>For the optional thermistor motor protection evaluation, refer to Typical circuit for the optional thermistor motor protection evaluation [Page 167].</p>
NOTICE
No soft stop possible. Set the ramp-down time to 0 s with the potentiometer.

15.11.3 3RW40 5 to 3RW40 7 and Dahlander motor starting

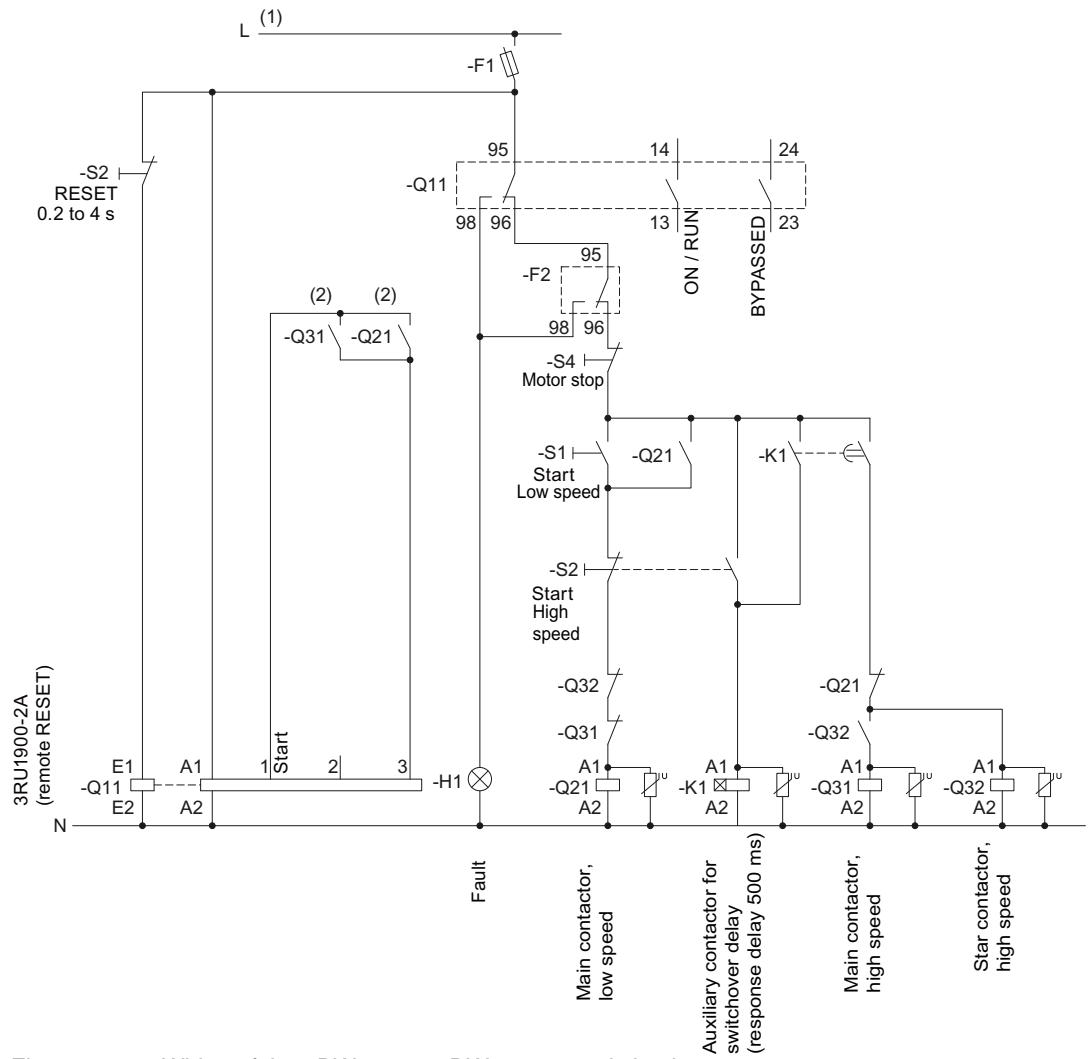

Figure 15-34 Wiring of the 3RW40 5 to 3RW40 7 control circuit

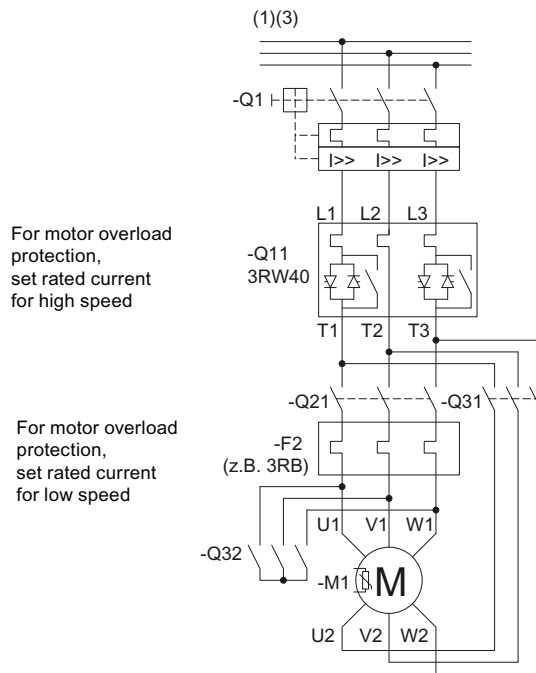

Figure 15-35 Wiring of the 3RW40 5 to 3RW40 7 main circuit

(1) For the permissible values for the main and control voltage (dependent on the MLFB), refer to chapter Technical data [Page 121] .

⚠ WARNING

(2) Automatic restart.

Can result in death, serious injury, or property damage.

The start command (e.g. issued by the PLC or switch S1) must be reset prior to issuing a RESET command because the motor attempts to restart again automatically following this RESET command if a start command is still present. This particularly applies if the motor protection has tripped. For safety reasons, you are advised to integrate the group fault output (terminals 95 and 96) in the controller.

(3) Alternatively, the motor feeder can be assembled as a fuseless or fused version with type of coordination 1 or 2. For the assignment of fuses and switching devices, refer to chapter Technical data [Page 121]

NOTICE

No soft stop possible. Set the ramp-down time to 0 s with the potentiometer.

Accessories

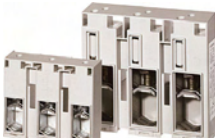

16.1 Box terminal blocks for soft starters

	For soft starter type	Size	Version	Order No.
Box terminal blocks for soft starters for round and ribbon cables				
	3RW40 5.	S6	<ul style="list-style-type: none"> Max. 70 mm² Max. 120 mm² 	3RT19 55-4G
	3RW40 7.	S12	<ul style="list-style-type: none"> Max. 240 mm² 	3RT19 66-4G

16.2 Auxiliary conductor terminals

	For soft starter type	Size	Order No.
Auxiliary conductor terminals, 3-pole			
	3RW30 4. 3RW40 4.	S3	3RT19 46-4F



16.3 Covers for soft starters

	For soft starter type	Size	Order No.
Terminal covers for box terminals			
	Additional touch protection to be fitted at the box terminals (2 units required per device)		
	3RW30 3. 3RW40 3.	S2	3RT19 36-4EA2
	3RW30 4. 3RW40 4.	S3	3RT19 46-4EA2
	3RW40 5.	S6	3RT19 56-4EA2
	3RW40 7.	S12	3RT19 66-4EA2
	Terminal covers for cable lug and busbar connections		
	For complying with the phase clearances and as touch protection if box terminal is removed (2 units required per contactor)		
	3RW30 4. 3RW40 4.	S3	3RT19 46-4EA1
	3RW40 5.	S6	3RT19 56-4EA1
	3RW40 7.	S12	3RT19 66-4EA1

16.4 Modules for RESET

	For soft starter type	Size	Order No.
Sealing covers			
	3RW40 2 to 3RW40 4.	S0, S2, S3	3RW49 00-0PB10
	3RW40 5. and 3RW40 7	S6 S12	3RW49 00-0PB00

16.4 Modules for RESET

	For soft starter type	Size	Version	Order No.
Modules for remote RESET, electrical				
	Operating range 0.85 to 1.1 x Us, Power consumption AC 80 VA, DC 70 W, ON time 0.2 s to 4 s, Switching frequency 60/h			
	3RW40 5. and 3RW40 7.	S6, S12	• AC/DC 24 V ... 30 V	3RU19 00-2AB71
			• AC/DC 110 V ... 127 V	3RU19 00-2AF71
			• AC/DC 220 V ... 250 V	3RU19 00-2AM71
Mechanical RESET, comprising				
	3RW40 5. and 3RW40 7.	S6, S12	• Resetting plunger, holder, and former	3RU19 00-1A
			• Suitable pushbutton IP65, 22 mm diameter, 12 mm stroke	3SB30 00-0EA11
			• Extension plunger	3SX13 35
Cable releases with holder for RESET				
	For 6.5 mm diameter holes in the control panel; max. control panel thickness 8 mm			
	3RW40 5. and 3RW40 7.	S6, S12	• Length 400 mm	3RU19 00-1B
			• Length 600 mm	3RU19 00-1C

Note

Remote RESET is already integrated in the 3RW40 2. to 3RW40 4. soft starters.

16.5 Link modules to 3RV10 motor starter protectors

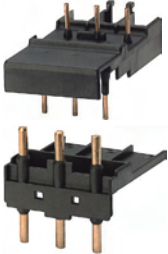
	For soft starter type	Size	Motor starter protector size	Order No.
Link modules to 3RV10 motor starter protectors				
	3RW30 13, 3RW30 14, 3RW30 16, 3RW30 17, 3RW30 18	S00	S0	3RA19 21-1A
	3RW30 26 3RW40 24 3RW40 26	S0	S0	3RA19 21-1A
	3RW30 36 3RW40 36	S2	S2	3RA19 31-1A
	3RW30 46, 3RW30 47 3RW40 46, 3RW40 47	S3	S3	3RA19 41-1A

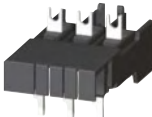

16.6 Link modules to 3RV20 motor starter protectors

	For soft starter type	Size	Motor starter protector size	Order No.
Link modules to 3RV20 motor starter protectors ¹⁾				
	With screw terminals			
	3RW30 1.	S00	S00	3RA29 21-1BA00
	3RW30 2.	S0	S0	3RA29 21-1BA00
	3RW40 2.	S0	S0	3RA29 21-1BA00
	With spring-loaded terminals			
	3RW30 1.	S00	S00	3RA29 11-2GA00
	3RW30 2.	S0	S0	3RA29 21-2GA00
	3RW40 2	S0	S0	3RA29 21-2GA00

1) Size S0 can be used up to 32 A.

16.7 Optional fan to increase the switching frequency (3RW40 2. to 3RW40 4.).

16.7 Optional fan to increase the switching frequency (3RW40 2. to 3RW40 4.).

	For soft starter type	Size	Order No.
Fan (to increase the switching frequency and for device mounting in positions different from the normal position)			
	3RW40 2.	S0	3RW49 28-8VB00
	3RW40 3., 3RW40 4	S2, S3	3RW49 47-8VB00
			

16.8 Spare parts for fans (3RW40 5., 3RW40 7.)

	For soft starter type	Size	Version Rated control supply voltage U _s	Order No.
	3RW40 5.-.BB3.	S6	115 V AC	3RW49 36-8VX30
	3RW40 5.-.BB4.	S6	230 V AC	3RW49 36-8VX40
	3RW40 7.-.BB3.	S12	115 V AC	3RW47 36-8VX30
	3RW40 7.-.BB4.	S12	230 V AC	3RW47 36-8VX40

16.9 Operating instructions

For soft starter type	Size	Order No.
Operating instructions for soft starters		
3RW30 1. to 3RW30 4.	S00 to S3	3ZX10 12-0RW30-2DA1
3RW40 2. to 3RW40 4.	S0 to S3	3ZX10 12-0RW40-1AA1
3RW40 5., 3RW40 7.	S6 , S12	3ZX10 12-0RW40-2DA1

Note

The operating instructions are included in the scope of supply.

Appendix

A.1 Configuration data

Configuration data

Siemens AG
 Technical Support Low-Voltage Control Systems
 Phone: +49 (0) 911-895-5900
 Fax: +49 (0) 911-895-5907
 e-mail: technical-assistance@siemens.com

1. Motor data

Siemens motor?

Rated output:	kW
Rated voltage:	V
Mains frequency:	Hz
Rated current:	A
Starting current:	A
Rated speed:	rpm
Rated torque:	Nm
Breakdown torque:	Nm
Mass moment of inertia:	kg*m2

Speed / torque characteristic curve

(The speed increments of the value pairs do not have to be equal)

n_M 1/m													" n_{syn} "
M_M / M_B													

Speed / current characteristic curve

(The speed increments of the value pairs do not have to be equal)

n_M 1/m												" n_{syn} "
I_M / I_B												

A.1 Configuration data

1. Load data

Load type (e.g. pump, mill etc.):

Rated speed: rpm
 Rated torque or rated output Nm or kW
 Mass moment of inertia (load-specific) kg*m²
 Mass moment of inertia (motor-specific) kg*m²

Speed / torque characteristic curve

(The speed increments of the value pairs do not have to be equal)

n _L 1/m												"n _{syn} "
M _L / M _B												

1. Start conditions

Starting frequency Starts
 Switching Rampup time
 cycles:
 Operating time
 Idle time
 Ramp-down time
 Ambient temperature °C

Yes Value

Starting current limitation?
 Acceleration torque limitation?
 Maximum ramp-up time?

1. Personal details

Last name, first name:
 Company:
 Department:
 Street:
 Zip code, town/city:
 Country:
 Phone:
 Fax:
 e-mail:

A.2 Table of parameters used

You can document your parameter settings in the table below.

Plant identifier	Installed 3RW type	Parameters 3RW30 or 3RW40				3RW40 parameters								
		U starting %	t ramp-up s	t ramp-down s	Ie motor A	Factor Ie limit value	CLASS value	RESET MODE LED	Output ON / RUN	Thermistor	Manual (off)	AUTO (yellow)	Remote (green)	
Pump XYZ	3RW4038-1TB04							<input type="checkbox"/> Manual (off)	<input type="checkbox"/> AUTO (yellow)	<input type="checkbox"/> Remote (green)	ON	RUN	PTC	Klixon
	3RW---B---							<input type="checkbox"/> Manual (off)	<input type="checkbox"/> AUTO (yellow)	<input type="checkbox"/> Remote (green)				
	3RW---B---							<input type="checkbox"/> Manual (off)	<input type="checkbox"/> AUTO (yellow)	<input type="checkbox"/> Remote (green)				
	3RW---B---							<input type="checkbox"/> Manual (off)	<input type="checkbox"/> AUTO (yellow)	<input type="checkbox"/> Remote (green)				
	3RW---B---							<input type="checkbox"/> Manual (off)	<input type="checkbox"/> AUTO (yellow)	<input type="checkbox"/> Remote (green)				
	3RW---B---							<input type="checkbox"/> Manual (off)	<input type="checkbox"/> AUTO (yellow)	<input type="checkbox"/> Remote (green)				
	3RW---B---							<input type="checkbox"/> Manual (off)	<input type="checkbox"/> AUTO (yellow)	<input type="checkbox"/> Remote (green)				

A.3 Correction sheet

TO

SIEMENS AG
A&D CD MM3

92220 Amberg / Germany

Fax: 0 96 21 / 80-33 37

FROM (please
complete):

Name

Company / Department

Address

Phone

Fax

System Manual for SIRIUS 3RW30 / 3RW40 soft starters

Have you noticed any errors while reading this manual?

If so, please use this form to tell us about them.

We welcome comments and suggestions for improvement.

Index

Numerics

3RW44 15, 28, 95
3RW44 soft starter 15, 28, 95

A

Accessories 199
Ambient temperature 80
Application examples 76
 Heavy-duty starting 78
 Normal starting 77
Applications 22
 For current limiting 30
 Soft stop 32
Assembly type 81, 84
ATEX 33, 134

B

Bypass contacts 96, 104, 109
Bypass mode 19
BYPASSED function 42

C

Capacitors 62
CLASS 10 76, 77, 107
CLASS 15 107
CLASS 20 78, 107
CLASS potentiometer 106
CLASS setting 33, 34, 106
Commissioning 92, 99
Configuration 73
Configurator 86
Contact 57
Current limiting 24, 27, 29, 30, 103, 104
Current limiting value 29, 104

D

Degree of protection 56
Device combinations 25
Diagnostics 44, 47, 97, 118
Direct mounting 56
Disconnecter 57

Documentation of parameters 205
Documentation of settings 205

F

Fan 53
Fault signals 37, 39, 45, 47, 60, 97, 118
Five safety rules for electricians 13, 58
Full motor protection 33

H

Heavy-duty starting 62, 78
 Ambient temperature 78
 General conditions and constraints 78
 Installation altitude 78
 ON time 78
 Parameter settings 78

I

Ie potentiometer 106
Increased safety 33, 134
Installation altitude 80
 CLASS 10 77
 CLASS 20 78
 Normal starting 77
Intrinsic device protection 35

M

Maximum ramp-up time 77, 78
Method of operation
 Soft starters 19
 Two-phase control 20
Motor current settings 107
Motor overload protection 33
Motor protection function 32
Motor ramp-up detection 104
Motor ramp-up time 95
Mounting position 81, 84
 Horizontal 53
 Vertical 53, 80

N

Natural stop 31
 Normal starting 73, 77, 122, 136, 138, 140, 142, 144
 Ambient temperature 77
 General conditions and constraints 77
 Installation altitude 77
 ON time 77
 Parameter settings 77

O

ON function 42, 109
 ON time 79
 Heavy-duty starting 78
 Normal starting 77
 Online configurator 86
 Output contact 96, 109
 Overload protection 34

P

Phase angle control 20
 Polarity balancing 20, 21
 PROFIBUS 15
 Protection against voltage failure 35
 PTC thermistors 35
 Pump stop 31

R

Ramp time 27, 94, 95, 102
 Ramp-down time 31, 105
 Ramp-up 104
 Ramp-up detection 28, 30, 76
 Ramp-up time 95
 3RW30 95
 3RW40 102
 ramp-up time
 Maximum 77, 78
 Rated data
 Reduction 80
 Rated operational current 106
 Recovery time
 Intrinsic device protection 35
 Motor overload protection 34
 Thermistor motor protection 35
 Reduced starting current 17
 RESET MODE 115
 RUN function 42, 109

S

Safety rules 13, 58
 Screw-type technology 65
 Selection criteria 22
 Semiconductor fuses 36
 Side-by-side assembly 55
 SIRIUS 3RW44 soft starter 15, 28, 95
 SIRIUS modular system 25
 SITOR 36
 SITOR semiconductor fuses 36
 Soft start 19, 94, 101
 Soft stop 19, 105
 Spring-loaded technology 65
 Standalone assembly 55
 Start 19
 Start modes 73
 Starting current 16
 Starting current asymmetry 29, 104
 Starting torque 16, 27
 Starting voltage 27
 Startup class 76
 Stop 19
 Stop modes 30
 Stop without load 31, 105
 Stopping torque 31
 Switching frequency 79, 85

T

t potentiometer 102, 105
 Technical Assistance 12
 Temperature sensor 35
 Thermistor motor protection 33, 35, 108, 134, 167
 Thermoclick sensors 35
 Three-phase induction motor 15, 18
 Thyristor 19, 20
 Thyristor protection 36
 Trip class 33, 34, 106
 Troubleshooting 44, 47, 97, 118
 Two-phase control 20
 Two-phase soft starters 20
 Type of coordination 36, 59, 60, 61, 62, 128
 1 128, 155
 2 128, 155

U

Ultra-heavy-duty starting 15

V

Voltage ramp 27, 29, 94, 101, 102

W

Water hammer 31

Win-Soft Starter 86

Win-Soft Starter software 86

X

xle potentiometer 104

Service & Support

Download catalogs and information material:
www.siemens.com/lowvoltage/catalogs

Newsletter – always up to date:
www.siemens.com/lowvoltage/newsletter

E-business in the Industry Mall:
www.siemens.com/lowvoltage/mall

Online-Support:
www.siemens.com/lowvoltage/support

Contact for all technical information:
Technical Assistance
Tel.: +49 (911) 895-5900
e-mail: technical-assistance@siemens.com
www.siemens.com/lowvoltage/technical-assistance

Siemens AG
Industry Sector
Postfach 4848
90026 NÜRNBERG
GERMANY

Subject to change without prior notice
Order No.: 3ZX1012-0RW30-1AC1

© Siemens AG 2010

www.siemens.com/automation