

Green Class Meter

KWH & KWH/DEMAND METER

INSTALLATION INSTRUCTIONS



E-Mon
850 Town Center Drive
Langhorne, PA 19047
(800)334-3666
www.emon.com



GREEN CLASS METER

Dear Valued Customer,

We are pleased that you chose to buy one of our products, and want you to be just as pleased with owning it. Before installing your new E-Mon product, please read the information on the following pages carefully.

We believe that you will find the E-Mon D-Mon meters easy to install and to use for monitoring and evaluating your electrical usage.

To be sure that you are 100% satisfied with your products, we provide toll-free technical and sales support Monday through Friday, 8:00 am to 7:30 pm, EST: (800) 334-3666. You may also reach us via e-mail at info@emon.com.

If you have questions, we can handle them quickly and effectively with a telephone call. Please let us try to help you **BEFORE** you remove your meter. And to help us help you, we ask that you have all relevant information on hand when you call (model or part numbers, nature of difficulty, etc.)

Be sure to forward this manual to the owner after installation is complete, so that they may use it as a reference guide when reading the E-Mon D-Mon meter.

Thank you.

TABLE OF CONTENTS

Section 1.0	Pre-Installation Information	4
Section 2.0	Safety Label Definitions and Information	6
Section 3.0	Precautionary and Safety Information	7
Section 4.0	Meter Installation	8
Section 4.1	Mounting the Meter	8
Section 4.2	Main Power Board Connections	8
Section 4.3	Current Sensor Installation & Wiring	10
Section 4.4	MAINS Line Voltage & Current Sensor Wiring Diagrams	13
Section 4.5	Line Voltage/Current Sensor Diagnostics	14
Section 4.6	Final Main Board Checks	15
Section 5.0	Monitoring Multiple Loads with One Meter	16
Section 6.0	KWh Meter Features & Functions	18
Section 6.1	KWh Meter Display Features	18
Section 6.2	How to Read the kWh Meter	19
Section 6.3	KWh Meter Hardware Functions	20
Section 7.0	KWh/Demand Meter Features & Functions*	22
Section 7.1	KWh/Demand Meter Display Functions	22
Section 7.2	How to Read the kWh/Demand Meter	23
Section 7.3	Demand Display Set-Up	24
Section 7.4	Demand Reset	26
Section 8.0	Preventative/Scheduled Maintenance	27
Section 9.0	Lithium Battery Replacement Instructions	28
Section 10.0	Troubleshooting Guide	30
Section 11.0	Frequently Asked Questions	31
Section 12.0	Meter Technical Specifications	32
Section 13.0	Meter Limited Warranty	35
* Applies to meters equipped with the Demand option.		

1.0 PRE-INSTALLATION INFORMATION

The E-Mon D-Mon® Green Class kWh/Demand meter is a 3-element meter used to monitor electric power usage of individual loads after the utility meter. **Installation must only be performed by qualified personnel and in accordance with these instructions and all applicable local and national electrical codes.** E-Mon or its representatives assume no responsibility for damages or injury resulting from the improper installation of this meter.

Meters are supplied in a UL Type 1 steel enclosure appropriate for indoor installation where it will not be affected by the elements, such as moisture and extreme temperatures.

Units designated by the “R” suffix on the model number have an extended environmental operating range and are enclosed in a NEMA 4X enclosure to accommodate outdoor environments. Verify the input voltage rating and configuration on the meter label to ensure it is suitable for the intended electrical services. Green Class meters labeled for 120/208V service **MUST NOT** be installed on service feeds of 277/480V and vice versa.

Verify the current sensors are sized suitably for the load to be monitored. Compare the color of the arrows on the current sensors to the chart below to confirm the correct current sensor is being used.

Sensor Arrow Color Code	Sensor Rating
Brown	100 Amp
Red	200 Amp
Yellow	400 Amp
Black	800 Amp
Blue	1600 Amp
White/Black	3200 Amp



CAUTION

Internal circuit card components are extremely sensitive to electrostatic discharge. Prior to handling or touching internal circuitry, discharge any static buildup on your person. To discharge yourself, touch a grounded metal object such as conduit or an earth grounded metal enclosure.



WARNING

Use of this instrument, Green Class, in a manner inconsistent with this manual or not specified by the manufacturer in writing, can cause permanent damage to the unit and/or serious injury to the operator. The protection and safety features provided by this equipment may become impaired or otherwise compromised.

NOTE: If any trouble arises during installation or functional verification operations, do not immediately remove unit. Before removing the unit, contact E-Mon's technical support department at (800) 334-3666. E-Mon's technical department will assist you in detailed troubleshooting of the Green Class installation.

1.1 Internal Electronic Assemblies

The unit is comprised of a Main Power Board, Display Board and Keyboard. All circuit cards are mounted inside a UL Type 1 (standard) or NEMA 4X (optional) enclosure.

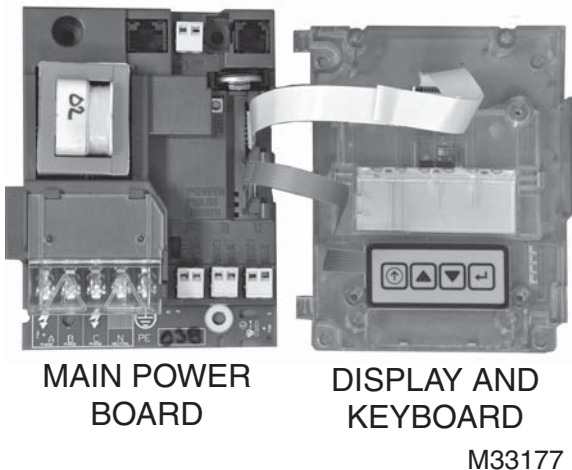

MAIN POWER
BOARD

DISPLAY AND
KEYBOARD

M33177

Fig. 1. Power Supply Board and Display Board

NOTE: Units are supplied in a UL Type 1 metal enclosure suitable for indoor applications only. Units supplied in the optional NEMA 4X fiberglass enclosure are suitable for either indoor or outdoor applications, within the defined specifications. Refer to Section 12.0 for a definition of suitable environmental conditions for indoor and outdoor units.

1.1.1 Main Power Board

Connections to this board include the MAINS Input Voltage, Current Sensors, external IDR interface and Isolated Pulse Output. The MAINS input terminals are covered with a protective shield for safety purposes. The current sensor assemblies interface to three header connectors, labeled A, B, and C along with conductor color indication. Each header connector input corresponds to an input voltage phase, so care must be taken to ensure each current sensor is connected to the correct input header.

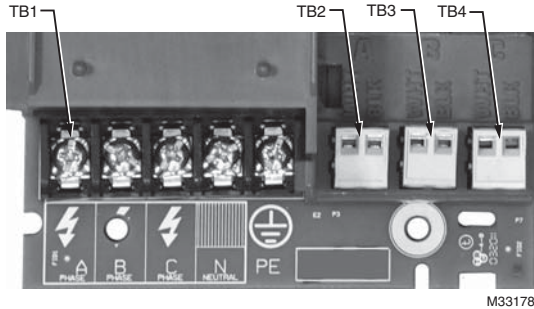

Fig. 2. Standard Configuration

1.1.2 Display Board

The display connects to the main power board via a flex-ribbon cable and is mounted on the inside of the enclosure door. The LCD readout indicates the cumulative kWh and instantaneous kW value on kWh meters. The LCD readout indicates cumulative kWh, peak demand and instantaneous kW values on kWh/ Demand meter. The Green meter also displays the CO2 footprint and the energy costs.

2.0 SAFETY LABEL DEFINITIONS AND INFORMATION

The Green Class meter may contain one or more of the following labels. Operator(s) should familiarize themselves with the meaning of each label to minimize risk.



The presence of this label is a cautionary indicator identifying a danger risk. The manual should be consulted prior to proceeding.



The presence of this label indicates an electrical shock hazard exists in the location or area where the label is placed. Prior to proceeding, the MAINS power must be disconnected and the manual consulted for safety information.

3.0 PRECAUTIONARY AND SAFETY INFORMATION



CAUTION

Internal circuit card components are extremely sensitive to electrostatic discharge. Be careful not to touch internal circuitry prior to discharging any static buildup on your person. To discharge yourself, touch a grounded metal object such as conduit or an earth-grounded metal enclosure.



WARNING

High voltages present on main PCB terminal block TB1 screw terminals. Risk of serious injury and/or electrical shock exists. Prior to performing any wiring operations, review all contents of the user manual and de-energize the MAINS power switch. Only qualified personnel should perform installation wiring. Installation wiring must comply with all local and national electrical codes.



WARNING

Failure to ground the enclosure creates a possible shock hazard. Do not operate the Green Class meter without a protective earth wire attached securely to the PE terminal screw. After installing protective earth wiring, secure the screw tightly (7in-lb torque.)



WARNING

NEVER open front panel of unit while unit has MAINS power applied. Failure to comply can increase the risk of serious injury and/or electrical shock.

4.0 METER INSTALLATION

4.1 Mounting the Meter

Using the appropriate sized mounting hardware, fasten the Green Class meter enclosure to the selected mounting surface. The four mounting holes are centered 6.75" H x 4" W. The mounting hole spacing is identical for either the UL Type 1 or NEMA 4X enclosure.

NOTE: Only the NEMA 4X enclosed unit is suitable for outdoor environmental conditions. Units housed in UL Type 1 enclosures must only be installed in indoor environments where it will not be affected by the elements, such as moisture and extreme temperatures.

4.2 Main Power Board Connections

1. Install a temporary ground for ESD (Electrostatic Discharge) protection. With all circuits de-energized, connect a temporary protective earth ground connection for ESD protection. Prior to performing any unit wiring, be sure to discharge any static on your person.
2. Install the Green Class Protective Earth Ground. Connect an earth ground wire to the Green Class protective earth ground terminal screw located on the right side of the line voltage terminal block. After installing the protective earth ground wire, securely fasten the protective earth ground screw.

WARNING

WARNING: Failure to attach the protective earth ground wire securely to the enclosure creates a potential shock hazard. Do not operate the Green Class meter without a protective earth ground connection securely installed.

3. Wire Entry.
 - a. Two openings exist on the unit enclosure, one for 1/2" conduit and one for 3/4" conduit. The 3/4" conduit opening located on the bottom of the enclosure is used to bring in MAINS Power (voltage lines to power meter) and current sensor wiring. The 1/2" conduit opening located on the top of the enclosure is used to interface low voltage signals, such as the IDR interface and isolated pulse output. (Outdoor enclosures equipped with one 3/4" conduit opening on bottom of enclosure only.)
 - b. Route the appropriate cabling to and through the respective enclosure opening. The conduit and fittings interfacing the enclosure entrances must be UL listed and properly sized to the enclosure port diameter. The interfacing fitting must use a gasket seal ring to interface between the conduit fitting and the enclosure entry point. After installing the conduit fitting and conduit, verify that the conduit fittings are aligned properly to their respective enclosure entrance ports and tightened securely to prevent moisture entry. VERIFY that each conduit slip nut is securely tightened to its respective conduit fitting.

- c. Outdoor applications require the use of the optional 4X enclosure. The same principles outlined for indoor meter installations as defined in the aforementioned paragraph carry over and apply to outdoor installations with one exception. This exception is that the conduit and fittings for outdoor installations require an outdoor material rating and approval for 4X applications.
4. Unit MAINS Wiring (Voltage Wiring Connections)
- a. Remove the shield located over the phase A,B and C screw terminals on the main power board. This shield can be removed by pulling back on the latch on the right side of the shield and lifting up on the front. Wire each connection to the terminal block with stranded wire 14-12 AWG, rated at 600 VAC.
 - b. Strip back all wire insulation to expose between 1/4" and 3/8" of the copper conductors. Gently twist each wire to prevent fraying. Insert the conductors into their respective terminal block position and tighten down the terminal block screw to securely fasten the conductor. The terminal block is clearly labeled PHASE A, PHASE B, PHASE C and NEUTRAL.
 - c. Connect the NEUTRAL wire to the appropriate terminal block position.

NOTE: For Delta MAINS input wiring, DO NOT connect the NEUTRAL wire. Remove the terminal block screw for this position.

- d. Connect the AC mains power wires (Phase A, Phase B and Phase C) to their respective positions as labeled on terminal block. Tighten the screws to 7 in-lb of torque.
 - e. After all conductors are connected to their respective terminal block positions and tightened down, verify that each terminal block screw is securely fastened by gently tugging on each conductor. Verify no conductor wires are frayed or are shorting to adjacent terminal block positions.
5. External Switch Mechanism/In-Line Fuse Installation
- a. To ensure a safe installation, the Green Class meter requires an external switch mechanism, such as a circuit breaker, be installed on the Green Class MAINS input wiring. The switch mechanism must be installed in close proximity to the meter and easily reachable for the operator. This device must also be marked as the disconnecting device for the Green Class meter.
 - b. Install 1/10 Amp Slow Activation in line fuses with the suitable voltage rating for each conductor phase at the MAINS input to the meter. The fuses must be labeled to indicate voltage and current rating as well as element characteristics. The fuse element must be slow activating type.
6. Once the MAINS wiring is complete, replace the clear Lexan protective shield over terminal block TB1 and close the enclosure front panel. Secure the enclosure cover using the locking mechanism. Activate the external circuit breaker or equivalent switch to apply AC MAINS power to the unit.
7. The Green Class meter display should turn on and indicate total kWh accumulation reading.

NOTE: On demand meters the unit display, clock and other critical configuration parameters will be reset once the unit installation and wiring is complete.

GREEN CLASS METER

8. Using an AC Voltmeter, verify the input voltage readings are within the limits specified below.

Meter Input Voltage Configuration	Nominal Voltage	Limits (+/- 10%)
120/208V, 3 Ph, 4 Wire	120 VAC (L-N)	108 to 132 VAC
277/480V, 3 Ph, 4 Wire	277 VAC (L-N)	249 to 305 VAC
240V, 3 Ph, 3 Wire	240 VAC (L-L)	216 to 264 VAC
480V, 3 Ph, 3 Wire	480 VAC (L-L)	432 to 528 VAC
347/600V, 3 Ph, 4 Wire	347 VAC (L-N)	540 to 660 VAC

9. Remove power from the unit by de-energizing the external switch.

NOTE: For 3-Wire systems, the voltages are measured Phase to Phase. On 4-Wire systems the voltages are measured Phase to Neutral.

4.3 Current Sensor Installation & Wiring

Once the AC voltages have been confirmed to be within acceptable limits, you are ready to install the current sensors. The MAIN power board contains three header connectors located at the bottom right of the board. The connectors are labeled A, B, and C along with conductor color indication. This format must be followed in order for the meter to function correctly.

The Green Class meter will be used with one of two basic types of current sensors:

- a. Split-Core Current Sensor: This sensor opens so that it can be attached around the circuit conductor being monitored without interrupting power. Unless otherwise specified, all Green Class meters are supplied with this sensor type.
- b. Solid-Core Current Sensor: This sensor does not open and requires the monitored conductor be removed from the circuit to install the current sensor. This type is only supplied when specified at time of order.

NOTE: The unit serial label specifies if the unit is set up for split or solid core current sensors. See ordering information for details.

Both types of current sensors output a 0-2 VAC signal proportional to the current being measured.

The current sensors must be matched with the voltage phases. The A phase sensor must be monitoring the same phase as the A phase voltage. B & C phase sensors must also monitor the same phase as their respective voltage inputs.

4.3.1 Installing the Split-Core Current Sensor Assembly

Each phase being monitored will require one two-piece current sensor assembly. Therefore, a three-phase meter will require three (3) assemblies. Open the two-piece current sensor assembly by releasing the nylon clamp using a flat head screwdriver.



Fig. 3. Split-Core Current Sensor Assembly

1. Reassemble the current sensor assembly around the conductor(s) to be monitored. Ensure the current sensor halves marked “Load” are both facing the load side of the conductor. The colored arrow will be on the source side of the conductor being monitored and MUST be pointed in a clockwise direction around the conductor being monitored. Tighten the nylon clamp to complete the assembly.

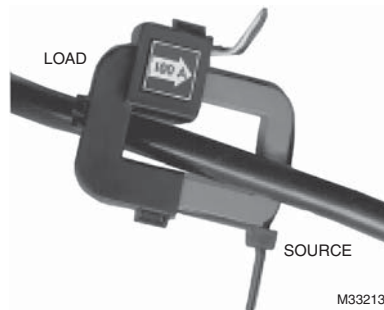

Fig. 4. Arrow On The Current Sensor Assembly

IMPORTANT:

When looking from the source side of the conductor(s) being monitored, you should see the arrow on the current sensor assembly. The arrow should be pointing in a clockwise direction around the conductor(s) being monitored. If the arrow is not positioned on the source side, inaccurate readings will result.

4.3.2 Installing the Solid-Core Current Sensor Assembly

The optional solid-core current sensors can be installed in the same applications as the standard split-core units, however, the conductors that they are monitoring must first be disconnected.

NOTE: Under no circumstances is this operation to take place without shutting off the power to the conductor(s) being monitored.

GREEN CLASS METER

With the power off, disconnect the conductor from its breaker or terminal. Slide the solid-core current sensor over the conductor, making sure that the indicator on the sensor is pointing in the direction of the load. After this is done, reconnect the conductor and verify that it is properly installed.

Run the black and white wires from the solid-core current sensors and install them according to the standard installation diagram. When this is completed, the power to the monitored conductor can be turned back on.



Fig. 5. Solid-core Current Sensor

4.3.3 Current Sensor Wiring

Once all the current sensors are installed on their appropriate phase conductors, you can begin terminating the current sensors on to the Green Class main power board.

The current sensor leads can be extended up to 2,000 feet (using #14-22 AWG wire) for remote monitoring applications. Consult your local electrical codes for proper wire sizing (#22 AWG twisted pair wire with a black and white conductor, rated for 600 VAC recommended.)

The current sensor connection points are located on the bottom right of the main power board. Three removable plugs exist, one for each current sensor phase input. The header portions of the connectors are labeled A, B and C. Text on the plastic cover of each of the connectors instruct you which terminal of the plug is for the white conductor and which terminal is wired to the black conductor. Once each current sensor is wired to its respective plug, insert each plug into the appropriate header.

4.4 MAINS Line Voltage & Current Sensor Wiring Diagrams

3-PHASE, 4-WIRE INSTALLATION DIAGRAM

NOTES:

LINE VOLTAGE CONNECTIONS: #14-12 AWG

SENSOR CONNECTIONS: B = BLACK LEAD W = WHITE LEAD

NEUTRAL NOT USED IN DELTA SYSTEM. REMOVE NEUTRAL TERMINAL BLOCK SCREW FOR DELTA SYSTEMS.

 1/10A 600 VAC INLINE FUSE PER CONDUCTOR. LITTLEFUSE PART NUMBER KLDR, 100.

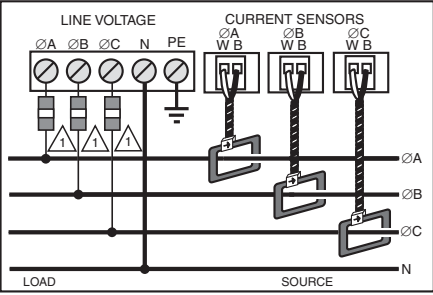

M33185

Fig. 6. 3-Phase, 4-Wire Installation Diagram

3-PHASE, 3-WIRE INSTALLATION DIAGRAM

NOTES:

LINE VOLTAGE CONNECTIONS: #14-12 AWG

SENSOR CONNECTIONS: B = BLACK LEAD W = WHITE LEAD

NEUTRAL NOT USED IN DELTA SYSTEM. REMOVE NEUTRAL TERMINAL BLOCK SCREW FOR DELTA SYSTEMS.

 1/10A 600 VAC INLINE FUSE PER CONDUCTOR. LITTLEFUSE PART NUMBER KLDR, 100.

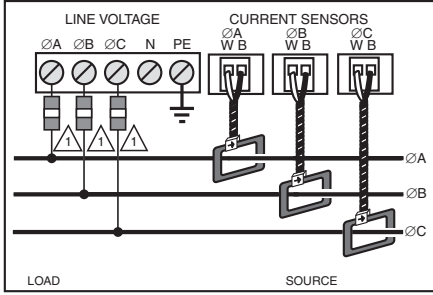

Fig. 7. 3-Phase, 3-Wire Installation Diagram

4.5 Line Voltage/Current Sensor Diagnostics

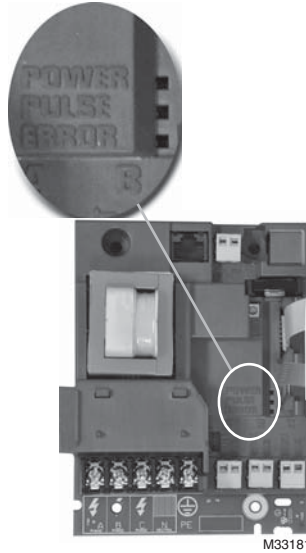

Fig. 8. Main Board

The three-phase AC MAINS voltage wiring and the current sensor wiring must be connected in the proper phase sequence. If there is a phase sequence error, the display LCD will display a message 'Check Sensor' in the upper right hand corner. Additionally, LED D1, Check Sensor, will illuminate if there is a phasing error.

Verify that the AC MAINS voltage wires are all connected to the correct positions on terminal block. Inspect the MAINS input wiring to verify each conductor is terminated at the correct terminal block position. Using an AC voltmeter, measure the AC voltage for each phase to neutral terminal and to the frame ground point.

Verify each current sensor by running at least 1% of the full scale rated current through the conductor being monitored by each phase. (e.g. 2 amp load required for each phase to perform sensor diagnostic procedures.)

- Verify that the current sensor white and black conductors are installed in the correct header positions.
- Verify the current sensors are installed in the correct direction on the conductor being monitored.
- Verify that the current sensor plugs are terminated in the correct header on the Main Power Board.

If the error messages still haven't been cleared, measure the AC voltage inputs across the plug terminals of each current sensor, individually. Set the AC voltmeter to the 20 Volt scale. If a reading of zero volts is indicated on the voltmeter, check for an open circuit. An open connection could exist at the plug terminals or at a splicing junction. Also verify a tight connection exists between the core halves.

If error message is still appearing, contact E-Mon technical support at (800) 334- 3666 for further assistance.

4.6 Final Main Board Checks

Once the phase error has been corrected, the Display LCD "Check Sensor" error should extinguish and the Main Power Board LED should extinguish.

5.0 MONITORING MULTIPLE LOADS WITH ONE METER

The Green Class meter provides extreme flexibility by allowing additional sets of current sensors to be used in parallel so that multiple load locations can be monitored by one meter. This feature allows a totalized display readout from two or more load circuits.

You may use parallel sensors to monitor specific breakers from one panel, specific breakers from more than one panel, two or more complete panels, etc.

When paralleling current sensors, the following rules must be followed for accurate readings:

Rule 1: Current sensors must be installed in complete sets of three, with a maximum of three sensors installed in parallel per phase.

Rule 2: All sensors used in parallel must be of the same amperage rating (i.e. 100 amp, 200 amp, etc.) The rating is determined by the current rating (amperage) of the Green Class meter. For example, a 200 amp meter must use extra sets of 200 amp current sensors.

Rule 3: All locations being monitored must have the same power source. A 480 volt meter cannot monitor a 208 volt load nor can a meter monitor two 480 or 208 volt loads if they are from different originating power sources or from different transformers.

Rule 4: The display readings must be multiplied by the number of sets of current sensors installed. E.g. meter reading of 5 kWh with 2 sets of current sensors... $5 \times 2 = 10$ kWh (actual usage.)

NOTE: One set of current sensors equates to three sensors, one per phase. The multiplier only applies when extra sets of current sensors are installed on one meter. Therefore, if you are using only one set of three sensors (one per phase) the multiplier is not required.

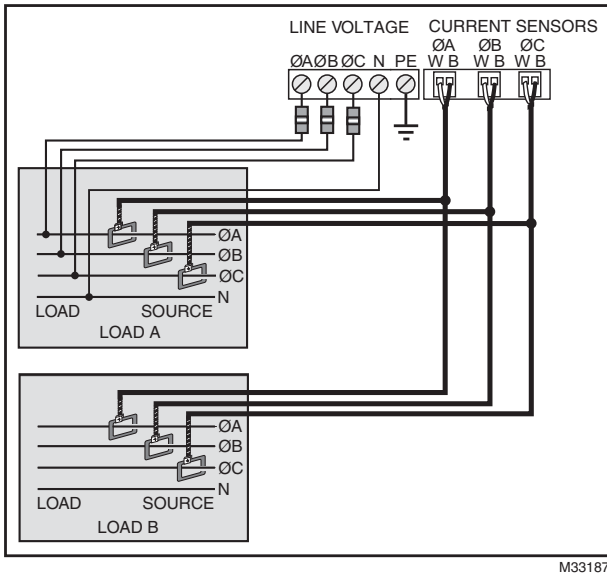

Fig. 9. Multiple Loads with one Meter

6.0 KWH METER FEATURES & FUNCTIONS

6.1 KWh Meter Display Features

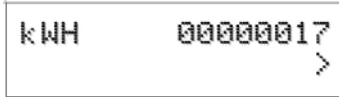

Fig. 10. Normal Mode (kWh Reading)

The Green Class kWh meter display requires no multiplier and shows kilowatt-hours consumed. See section 6.2 for information on calculating cost based on kWh usage.



Fig. 11. KW Load Mode (Current Load in kW)

The Green Class kWh meter LOAD display shows the present circuit load in kilowatts.



Fig. 12. Start Up Mode

When initially powered on, the Green Class meter will display the startup screens.

This screen indicates the meter voltage, amps and service configuration. It will remain on for approximately five seconds before switching to the version screen, after which the meter enters the normal operating mode.

6.2 How to Read the kWh Meter



Fig. 13. Readings are displayed in whole numbers

The Green Class kWh meter displays readings in whole numbers, there are no decimals.

To find the dollar cost for the power used by the load(s) being monitored, you must first find out what the cost per kWh is in your area (this cost can be found on your utility electric bill, or call your local utility and ask for their cost per kilowatt hour.) Simply multiply the cost per kWh by the kWh reading from the E-Mon D-Mon meter. The resultant figure is the dollar cost for power used by the load(s) being monitored by this meter.

Example:

8-digit display reading 00000017
 Cost per kWh from utility \$0.12100
 $17 \times \$0.121 = \2.06

NOTE: THE FOLLOWING ONLY APPLIES TO METERS USING MORE THAN ONE SET OF CURRENT SENSORS. For meters using parallel current sensors you must multiply the kWh display reading by the number of sets of current sensors installed.

Example: 250 (meter display reading) $\times 2$ (sets of sensors in parallel) = 500 kWh
 500 kWh $\times \$0.121$ (utility cost per kWh) = $\$60.50$

6.3 KWh Meter Hardware Functions

IDR Jack	8-pin RJ-45-used to connect kWh meter to the E-Mon Energy automatic meter reading system.
Calibration Jack	Connector J11 is for factory calibration only, and is not a user accessible port. Silicon plug is not to be removed.
Error LED	When lit, indicates that the current sensor is backwards or on the incorrect phase.
Meter Pulse LED	Blinks to show the meter load. Blink rate increases with load.
Power On LED	When lit, indicates power to meter is on.
Pulse Output	Optically isolated output pulse for connection to BAS or peripheral equipment.

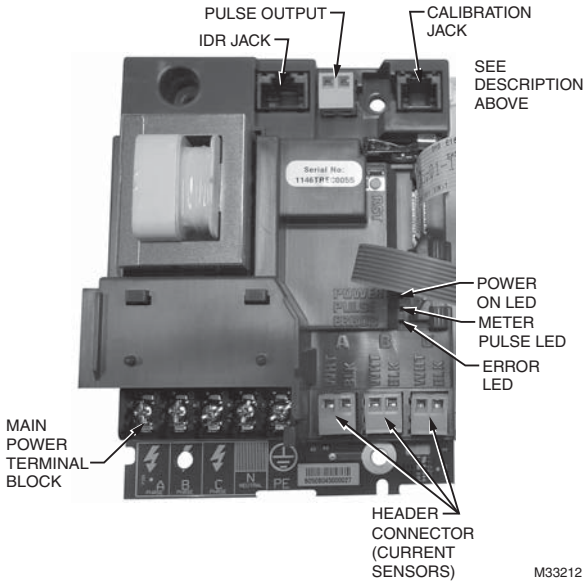

M33212

Fig. 14. Hardware Functions

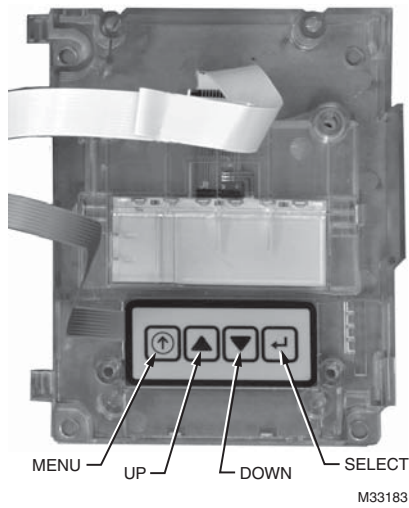

Fig. 15. Hardware Functions

7.0 KWH/DEMAND METER FEATURES & FUNCTIONS*

(*Applies to meters equipped with the Demand Option)

7.1 KWh/Demand Meter Display Functions

The Green Class kWh/Demand meter has a single display window that cycles through the energy data screens. The meter will cycle through four (4) separate screens. The screens are described below.

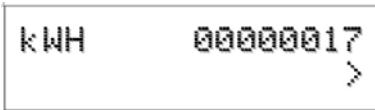

KWh display shows the amount of energy consumed in kilowatt hours (kWh). Reading is in whole numbers, there are no decimals and the meter requires no multipliers.



LOAD display shows the present circuit load in kilowatts.



KW display shows the electrical Demand in kilowatts (kW). Demand interval is either 15 minutes or 30 minutes. (Default is 15 minutes.)

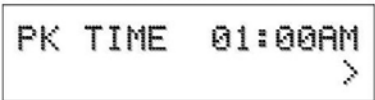

Time display shows the time of the day that the demand peak occurred.

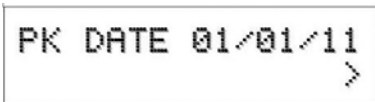

Date display shows the date of the demand (kW) peak.

Fig. 16. KWh/Demand Meter Display Functions

7.2 How to Read the kWh/Demand Meter

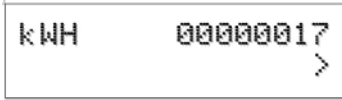

Fig. 17. kWh Reading

The Green Class kWh meter displays readings in whole numbers, there are no decimals.

To find the dollar cost for the power used by the load(s) being monitored, you must first find out what the cost per kWh is in your area (this cost can be found on your utility electric bill, or call your local utility and ask for their cost per kilowatt hour.) Simply multiply the cost per kWh by the kWh reading from the E-Mon D-Mon meter. The resultant figure is the dollar cost for power used by the load(s) being monitored by this meter.

Example:

8-digit display reading	00000017
Cost per kWh from utility	\$0.12100
17 x \$0.121 = \$2.06	



Fig. 18. kW (Demand) Reading

The kW (Demand) reading is the peak usage over a specified time period (15 minute standard, 30 minute optional). While kWh costs are interpreted as cents, Kilowatt costs are usually represented in dollars, and interpretation of demand costs are based on your utility’s tariff and rate structures. You will need to contact your utility to see how your utility structures their kilowatt demand charges to ensure proper allocation of costs utilizing data from the E-Mon D-Mon meter.

NOTE: THE FOLLOWING ONLY APPLIES TO METERS USING MORE THAN ONE SET OF CURRENT SENSORS.

For meters using parallel current sensors you must multiply the kWh display reading by the number of sets of current sensors installed. With Demand meters, the PEAK Demand is also multiplied by the number of sets of current sensors installed.

Example:

17(meter display reading) x 2 (sets of sensors in parallel) = 34 kWh

34 kWh x \$0.121 (utility cost per kWh) = \$4.12

7.3 Demand Display Set-Up

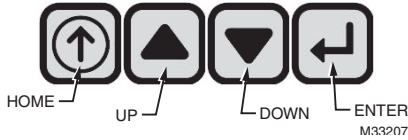

The demand meter display is set-up using the four buttons located on the meter display board which is mounted on the door inside the meter enclosure.



STEP 1: Press the HOME button to enter the menu screen.

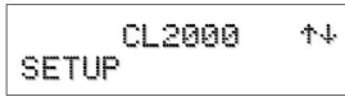

STEP 2: Press the DOWN button to enter the setup screen.



STEP 3: Press the ENTER button to enter the DATE screen.



STEP 4: Press the Enter button to cycle between the day, month, and year. Press the UP and DOWN buttons to change their respective numbers.

```
CHANGE
STORED
```

STEP 5: When the numbers have been changed, press ENTER again to save the changes.

STEP 6: Press the DOWN button to access the TIME screen.

```
SETUP      ↑↓
TIME↓Fr 03:10 PM
```

STEP 7: Press ENTER to cycle between the hour, minutes, and day of week selection Use the UP and DOWN buttons to change the selection.

```
CHANGE
STORED
```

STEP 8:When the changes are completed press the ENTER button to save the changes.

```
DEMAND INT  ↓
              15min
```

STEP 9: Press ENTER to enter the DEMAND INTERVAL screen.

```
DEMAND INT  ↓
              15min
```

STEP 10: Press ENTER again to access the interval selection screen. Use the UP and DOWN buttons to select the appropriate interval time. (default is 15 min.)

GREEN CLASS METER

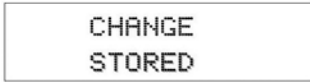

STEP 11: When the appropriate demand interval has been chosen, press ENTER to save the changes.

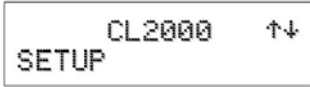

STEP 12: Press the HOME button to return to the setup screen.

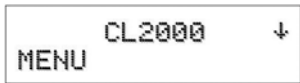

STEP 13: Press the UP arrow to display the MENU screen.

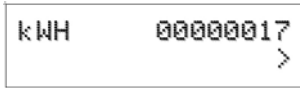

STEP 14: Press the ENTER button to enter the normal display screen.

7.4 Demand RESET

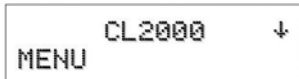

STEP 1: Press the HOME button to access the Series 2000 MENU screen.

```

      CL2000  ↑↓
CHECKOUT

```

STEP 2: Use the UP and DOWN buttons to access the CHECKOUT screen.

```

      CL2000  ↑↓
CHECKOUT

```

STEP 3: Press the ENTER button to access the kw RESET screen.

```

CHECKOUT  ↑↓
kW RESET  ↓YES

```

STEP 4: Press ENTER to access the RESET select screen. Use the UP and DOWN buttons to select “yes” or “no”. Press ENTER to save the selection. “Change stored” will be displayed after pressing ENTER.

```

      CL2000  ↓
MENU

```

STEP 5: Press the HOME button to return to the menu screens. Use UP and Down to select the MENU screen.

```

kW  00000017
      >

```

STEP 6: Press ENTER to return to the normal display.

7.5 Setup Cost / kWh

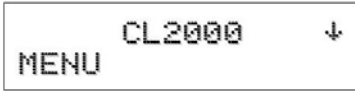

STEP 1: Press the HOME button to enter the menu screen.

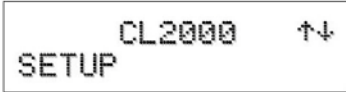

STEP 2: Press the DOWN button to enter the setup screen.



STEP 3: Use the UP and DOWN buttons to access the COST/Kwh screen.

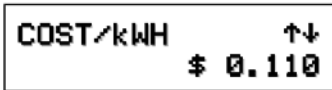

STEP 4: Press ENTER and use the UP and DOWN buttons to select the correct cost per kWh.

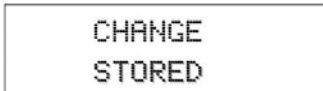

Step 5: Press ENTER to save the selection. "Change stored" will be displayed after pressing ENTER.



STEP 5: Press the HOME button to return to the menu screens.

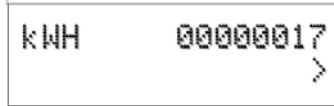

STEP 6: Press ENTER to return to the normal display.

7.6 Setup CO2 / kWh



STEP 1: Press the HOME button to enter the menu screen.

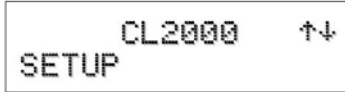

STEP 2: Press the DOWN button to enter the setup screen.



STEP 3: Use the UP and DOWN buttons to access the CO2/Kwh screen.

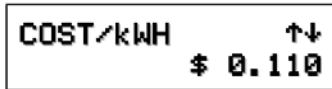

STEP 4: Press ENTER and use the UP and DOWN buttons to select the correct cost per kWh.

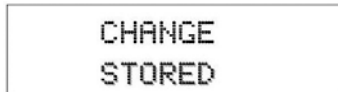

Step 5: Press ENTER to save the selection. "Change stored" will be displayed after pressing ENTER.



STEP 5: Press the HOME button to return to the menu screens.

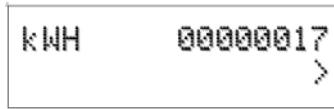

STEP 6: Press ENTER to return to the normal display.

8.0 PREVENTATIVE/SCHEDULED MAINTENANCE

The Green Class kWh/Demand meter is shipped in a calibrated, tested and fully functional condition.

- No field adjustments are required.
- No preventative or scheduled maintenance is required.
- No cleaning or decontamination procedures are required for this instrument.

9.0 LITHIUM BATTERY REPLACEMENT INSTRUCTIONS

The Green Class kWh/Demand meter has a Lithium Battery Cell, which is used to retain the contents of SRAM and the RTC during power outages. The battery has a life expectancy of greater than 5 years.

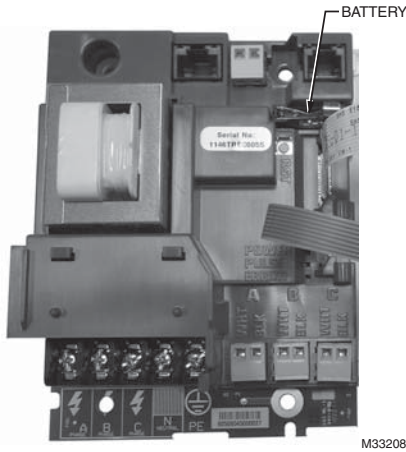

Fig. 19. Battery Location

Nominal Working Voltage	3 Vdc Output
Nominal Current Capacity	225 mAHr
Cell Chemical	Manganese Dioxide Lithium
Operating Temperature Range	-30 to +60 Degrees Celsius
Manufacturer	Panasonic
Manufacturer's Part Number	CR2032

Fig. 20. Battery Specifications at 25 Degrees Celsius

WARNING

WARNING: Only replace battery with Panasonic part number CR2032 only. Use of another battery may present a risk or explosion. See owners manual for safety instructions. Internal circuit card components are extremely sensitive to electrostatic discharge. Be careful not to touch internal circuitry prior to discharging any static buildup on your person. To discharge yourself, touch a grounded metal object such as conduit or a metal enclosure exterior.

The battery cell is mounted in a coin cell on the upper right side of the main power board. Replace the battery if the low battery warning is on display.

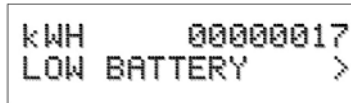

Fig. 21. Low Battery Display

Use the following procedure to replace the battery cell

STEP 1: Disconnect power from the meter at the unit external circuit breaker.

STEP 2: Remove the battery from its holder and place on a non-conductive surface.

STEP 3: Install new battery into the battery holder.

NOTE: Care should be taken to insure that the replacement battery is installed the same polarity as the battery that was removed. No damage to unit or battery will occur if battery is inadvertently installed in the wrong direction.

STEP 4: Dispose of the used battery in accordance with the manufacturers' (Panasonic) instructions.

10.0 TROUBLESHOOTING GUIDE

The Green Class kWh/Demand meter is calibrated and tested at the factory before being packaged and shipped. If installed properly and in accordance with these installation instructions, your Green Class meter should provide years of trouble free service. If the meter should not function, the following guide will assist in troubleshooting the installation.

Problem	Procedure to follow
1. Display window is blank.	Check wiring to voltage terminals.
	Check circuit breakers or fuses.
	Verify that the power is turned on.
	Test source for correct voltage.
2. Display shows incomplete figures or numbers other than zeros when power is turned on.	Press RESET button located on door inside meter enclosure (5 sec.)
3. Display reading all zeros (00000000)	Determine if load is sufficient to update the display.
	Check RESET button to ensure there are no wires or other objects pressing against it when the door is closed.
	Check the current sensors for installation and polarity.
	Be sure the current and voltage inputs have the proper phase relationship.
	Check wiring to voltage terminals.
	Check circuit breaker or fuses.
	Test source for correct voltage.
4. Display reads only a fraction of consumption	Check the supply voltage to be sure that it is on continuously 24 hrs/day.
	Check the current sensors for installation and polarity.
	Check sensor wiring to the terminal strip in meter (color coding B & W.)

NOTE: If you still need assistance after performing the above troubleshooting procedures, do not remove the unit. Before removing the unit, contact E-Mon's technical support department at (800) 334-3666, our support experts will assist you in detailed troubleshooting of the meter installation and assist you in getting the unit operating correctly.

11.0 FREQUENTLY ASKED QUESTIONS

Q. When providing line voltage to the meter, can I tap off of the same breaker I am monitoring?

A. Yes, the voltage can be pulled from the same breaker being monitored.

Q. Can the meter's line voltage wires be run in the same conduit as the sensor leads?

A. Yes, there will be no effect on the meter if the sensor leads and line voltage wires are run in the same conduit.

Q. Can the meter communication wires and line voltage wires be run in the same conduit?

A. It is NOT recommended to run these wires together due to noise concerns and their effects on the communications signal integrity. Communication wires can be routed separately using the 1/2" conduit port.

Q. How do I find the cost for kWh and kW to bill my tenants?

A. Your local utility bill should list the cost per kWh and kW. If not, simply call your utility and ask them to provide you with the cost per kWh and kW.

Q. What size wire do I use for the line voltage leads?

A. These wires are normally #14 AWG, but be sure to consult your local electrical codes for proper sizing requirements.

Q. What size wire should I use to extend the current sensor leads?

A. These wires are normally sized at #14-22 AWG, twisted pair arrangement. Consult your local electrical codes for proper sizing requirements. Q. The load I need to monitor has parallel feeds. How do I install the current sensors for this application?

A. There are two ways you can monitor parallel feeds. One method is to clamp the sensors around all feed wires for each phase (no additional reading multiplier required). The second way to monitor parallel feeds is to clamp the sensor around one of the feed wires for each phase, and when you read the kWh meter the final reading must be multiplied by the number of feed wires for each phase.

Q. I have two subpanels I would like to monitor with one meter. These subpanels are fed by different transformers in the building. Can I parallel sensors and monitor both panels with one meter?

A. No. These panels cannot be monitored by one meter because they are different power sources. When you parallel current sensors, all loads must be from the same voltage source.

Q. I have 5 breakers in one subpanel I would like to monitor with one meter. Can this be done without having to parallel current sensors?

GREEN CLASS METER

A. Yes. Simply run all the breaker wires through one set of current sensors. Make sure all A phase circuits are run through the A phase sensor, and the same for B & C phases. The meter should be sized by the highest amount of current being monitored by one sensor.

Q. I've gone through the troubleshooting guides and I still can't get my meter to work. What should I do?

A. Before removing the unit, contact E-Mon's technical support department at (800) 334-3666. Our technical support experts will assist you in detailed troubleshooting of the meter installation and assist you in getting the meter functional without having to remove and return the unit.

12.0 METER TECHNICAL SPECIFICATIONS

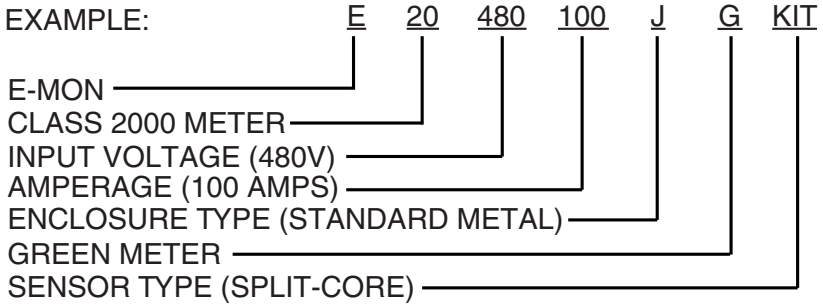

Ordering Information: Define brand, class, input voltage, current sensor amperage, enclosure type, and sensor type in the format A-BB-CCC-DDDD-E-F-GGG where:
A = Brand: E for E-Mon
BB = Class: 20 for Green Class
CCC = Input Voltage: 120, 208, 480 or 600
DDDD = Amperage: 100, 200,400,800,1600, or 3200
E = Enclosure Type: J = standard metal, R= 4X raintite, M = MMU
F= Meter Option: D for Demand, G for Green Meter, "blank" for kWh meter
GGG = sensor type: KIT = split-core, SCS= solid core "blank" = none supplied

Input Voltage Configuration	3-wire (Delta) Or 4-wire (Wye)
Mains Voltage Input	Up To 480 VAC RMS Available
Input Power	6 VA Maximum Rating
Current Sensor Rating	Up To 3200 Amps RMS AC Available
Power Factor	0.5 Leading Or Lagging
Line Frequency	50-60 Hz
Metering Accuracy	Certified To ANSI C12.16 (+/-% From 1- 100% Of Rated Load)
Voltage Operating Range	+/-10% Of Rated Load
Temperature Range	-20 C To +50 C (Standard indoor enclosure):
Temperature Range	-20 C To +70 C NEMA 4X (NEMA 4X outdoor enclosure)
Relative Humidity Range	0-95% Non-condensing
Altitude	2000 Meters Maximum
Voltage Overload	+25% Continuously: +100% For 20 Cycles
Current Sensor Overload	100% For 1 Minute Without Damaging Meter
Pollution Degree	Degree 2 In Accordance With IEC 664
Installation (Overvoltage) Category	Category 111
Measurement Category	Category 111
Enclosure Material	Indoor Housing Rating (Standard): NEMA 12 Outdoor Housing Rating (Optional): NEMA 4X
Display Readout	KWh Accumulated
Standard Ranges	4-Wire Wye, 120/208 VAC: 100, 200, 400, 800,1600,3200 Amp 2 Phase, 120/240 VAC: 100, 200, 400, 800,1600,3200 Amp 4-Wire Wye, 277/480 VAC: 100, 200, 400, 800,1600,3200 Amp 3-Wire Delta, 220/240 VAC: 100, 200,400,800,1600,3200 Amp 3-Wire Delta, 480 VAC: 100, 200, 400, 800,1600,3200 Amp

GREEN CLASS METER

Modem Interface	Cable:	UL-listed Telephone Cord, 6-cond. 300 VAC, Stranded Cond. 22-26 AWG.
	Cable Connector:	RJ-45 male IDC
	Input/Output Voltage:	+5 VDC/18 VAC
	Ckt Input Isolation	5.3K VAC for 1 Minute
	Baud Rate:	9600
IDR Interface Port	Cable:	UL-listed/rated Telephone Cord. 4-cond.
	Input/output Voltage:	Ground-isolated +/-5.4VDC
	Cable Connector:	RF-45 Male IDC Or Screw Terminal Termination
	Circuit Input Isolation:	5.3kVAC
	Circuit output Isolation:	21.5kVAC
	Isolated Pulse/Alarm Outputs (TB5, TB6):	
	Output Voltage Potential:	0 VDC to +5 VDC Logic Levels
	Mating Plug Connector:	Weidmuller PN: 152876
Recommended In-line Fuse	Signal Isolation Voltage:	5.3K VAC for 1 Minute
	Manufacturer:	Littlefuse
	Mfg. Part No:	KLDR.100
Battery Cell	Rating:	100mA, Time-delay, 600VAC Cartridge Fuse
	Description:	Non-rechargeable Cell Used For Memory Retention
	Manufacturer:	Panasonic
	Mfg Part No:	Manganese Dioxide Lithium
	Working Voltage:	3Vdc
	Current Capacity	225 mAhR
Manufacturer's Part Number	CR2032	

13.0 METER LIMITED WARRANTY

Subject to the exclusions listed below, E-Mon will either repair or replace (at its option) any product that it manufactures and which contains a defect in material or workmanship.

The following exclusions apply:

1. This Limited Warranty is only effective for a period of (5) five years following the date of manufacture when installed in accordance with manufacturer's instructions by qualified personnel.
2. E-Mon must be notified of the defect within ninety (90) days after the defect becomes apparent or known.
3. Buyer's remedies shall be limited to repair or replacement of the product or component which failed to conform to E-mon's express warranty set forth above.
4. Buyer shall be responsible for all freight costs and shall bear all risk of loss or damage to returned goods while in transit.
5. This Limited Warranty does not cover installation, removal, reinstallation, or labor costs, and excludes normal wear and tear. Buyer shall provide labor for the removal of the defective component or item and installation of its replacement at no charge to E-Mon.
6. This Limited Warranty does not cover any product if: (i) a product is altered or modified from its original manufactured condition, (ii) any repairs, alterations or other work has been performed by Buyer or others on such item, other than work performed with E-Mon's authorization and according to its approved procedures; (iii) the alleged defect is a result of abuse, misuse, improper maintenance, improper installation, accident or the negligence of any party; (iv) damaged as a result of events beyond E-Mon's control or other force majeure events or (v) used in conjunction with equipment, components, accessories, parts or materials not supplied or approved by E-Mon.
7. This Limited Warranty is limited to the obligation to repair or replace the manufactured product. This is the sole and exclusive remedy for any breach of warranty. IN NO EVENT SHALL E-MON BE LIABLE FOR ANY INDIRECT, INCIDENTAL, SPECIAL, CONSEQUENTIAL OR PUNITIVE DAMAGES (INCLUDING ANY DAMAGE FOR LOST PROFITS) ARISING OUT OF OR IN CONNECTION WITH THE FURNISHING OF PRODUCTS, PARTS OR SERVICES, OR THE PERFORMANCE, USE OF, OR INABILITY TO USE ANY PRODUCTS, PARTS OR SERVICES, SALE OF OR OTHERWISE, WHETHER BASED IN CONTRACT, WARRANTY, TORT, INCLUDING WITHOUT LIMITATION, NEGLIGENCE, OR ANY OTHER LEGAL OR EQUITABLE THEORY.
8. EXCEPT AS EXPRESSLY PROVIDED HEREIN, E-MON MAKES NO WARRANTY OF ANY KIND, EXPRESS OR IMPLIED WITH RESPECT TO ANY PRODUCTS, PARTS OR SERVICES PROVIDED BY E-MON INCLUDING, BUT NOT LIMITED TO, THE IMPLIED WARRANTIES OF MERCHANTABILITY AND FITNESS FOR A PARTICULAR PURPOSE. PRODUCTS OR COMPONENTS DISTRIBUTED, BUT NOT MANUFACTURED, BY E-MON ARE NOT WARRANTED BY E-MON AND BUYER MUST INSTEAD RELY ON THE REPRESENTATIONS AND WARRANTIES, IF ANY, PROVIDED DIRECTLY TO THE BUYER BY THE MANUFACTURER OF SUCH PRODUCT OR COMPONENT.

GREEN CLASS METER

E-Mon

850 Town Center Drive
Langhorne, PA 19047

www.emon.com
info@emon.com

© U.S. Registered Trademark
© 2011 E-Mon, LLC.
62-0415-01 JPG Rev. 11-11
Printed in United States

