

SWISH™ 2X2 TROFFER CENTER BASKET INSTALLATION INSTRUCTIONS



Thank you for buying RAB lighting fixtures. Our goal is to design the best quality products to get the job done right. We'd like to hear your comments. Call the Marketing Department at 888-RAB-1000 or email: marketing@rabweb.com

IMPORTANT

READ CAREFULLY BEFORE INSTALLING FIXTURE. RETAIN THESE INSTRUCTIONS FOR FUTURE REFERENCE.

RAB fixtures must be wired in accordance with the National Electrical Code and all applicable local codes. Proper grounding is required for safety. THIS PRODUCT MUST BE INSTALLED IN ACCORDANCE WITH THE APPLICABLE INSTALLATION CODE BY A PERSON FAMILIAR WITH THE CONSTRUCTION AND OPERATION OF THE PRODUCT AND THE HAZARDS INVOLVED.

WARNING: Make certain power is OFF before installing or maintaining fixture.

SAFETY INSTRUCTIONS

WARNING: Risk of fire or electric shock. Suitable for Damp locations.

WARNING: Suitable for 9/16" or 15/16" Flat Tee Grid in Insulated Ceilings.

WARNING: Fixture to be independently supported to building structure.

RECESSED CEILING MOUNTING

The fixture is suitable only for INDOOR RECESSED CEILING application. Above ceiling access required.

To mount in an insulated or non-insulated ceiling - 9/16" or 15/16" exposed Flat Tee Grid Ceiling follow the steps below.

1. Rotate and slide the **Housing** as required to fit through the **Tee-Grid Bar** and place it as indicated by the directional arrow in figure.
2. Firmly bend the pre-installed **Grid Clips** (4) against the **Tee-Grid Bar** to secure the **Housing**.
3. Support wires are required by Installation Codes. Support the **Housing** to the building structure by **Support Wires (supplied by others)** through the **Support Wire Hole**.
4. Make sure that the orientation of the **Access Plate** faces an accessible tile to make electrical splices.
5. Loosen screw on **Access Plate** and remove the **Access Plate**. Knock out appropriate **Conduit Knockouts** on the **Access Plate** to route input conduit. Use appropriate conduit connectors as required by code.
6. Connect wires as shown in wiring diagram. Push all wires back into the **Splice Box**. Be careful not to pinch wires. **WARNING: To prevent wiring damage or abrasion, do not expose wiring to edges of sheet metal or other sharp objects.**
7. Replace **Access Plate** and tighten **Access Plate Screw**.

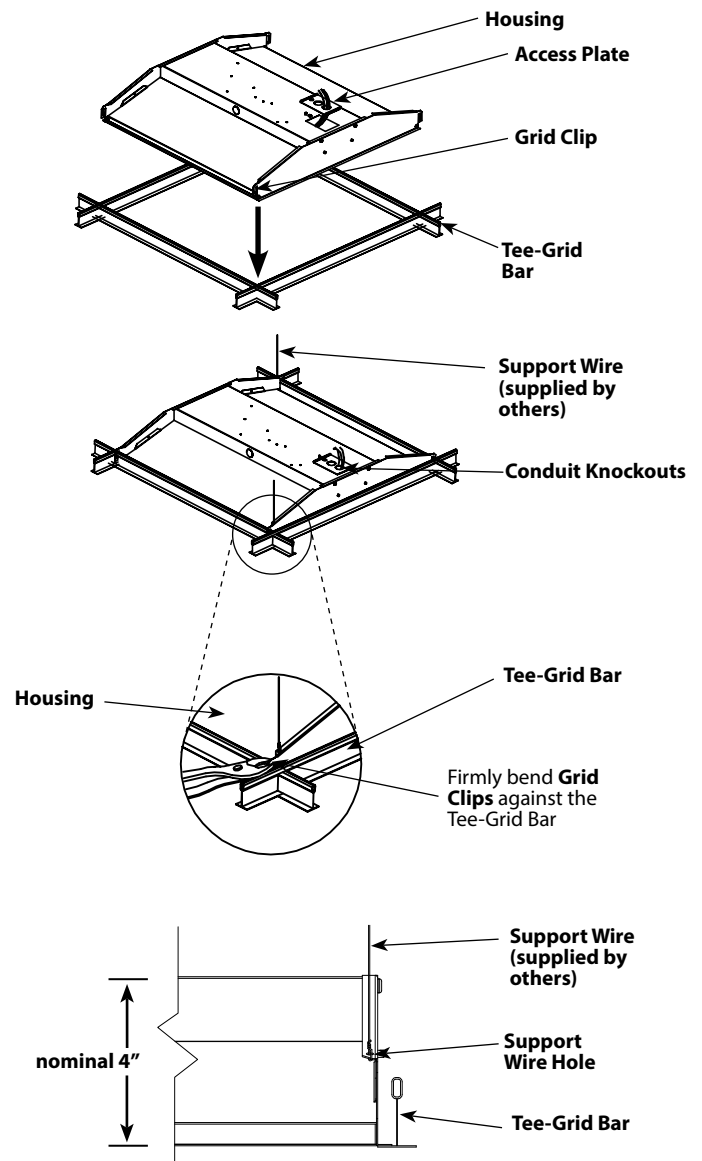

SWISH™ 2X2 TROFFER CENTER BASKET INSTALLATION INSTRUCTIONS



Thank you for buying RAB lighting fixtures. Our goal is to design the best quality products to get the job done right. We'd like to hear your comments. Call the Marketing Department at 888-RAB-1000 or email: marketing@rabweb.com

0-10V DIMMABLE WIRING

Universal voltage driver permits operation at 120V thru 277V, 50 or 60 Hz. 0-10V control wires must be rated for 300V minimum. For 0-10V Dimming, follow the wiring directions shown below.

1. Connect the black fixture lead to the LINE supply lead.
2. Connect the white fixture lead to the COMMON supply lead.
3. Connect the GROUND wire from fixture to supply ground. Do NOT connect the GROUND of the dimming fixture to the output.
4. Connect the violet fixture lead to the (V+) DIM lead.
5. Connect the gray fixture lead to the (V-) DIM lead.

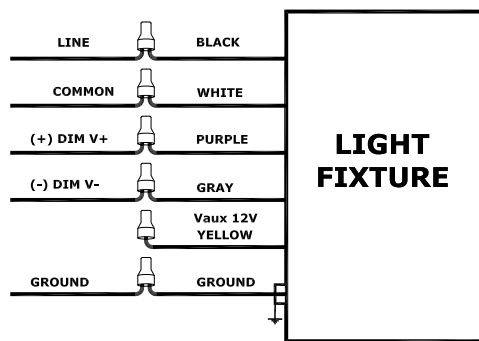

CLEANING & MAINTENANCE

CAUTION: Be sure fixture temperature is cool enough to touch. Do not clean or maintain while fixture is energized.

1. Clean polycarbonate lens & fixture with non-abrasive cleaning solution.
2. Do not open fixture to clean the LEDs. Do not touch the LEDs.

TROUBLESHOOTING

1. Check that the line voltage at fixture is correct. Refer to wiring directions.
2. Be sure the fixture is grounded properly.

Note: These instructions do not cover all details or variations in equipment nor do they provide for every possible situation during installation, operation or maintenance.



Easy Installation & Product Help

Tech Help Line
Call our experts 888 RAB-1000

rabweb.com
Visit our website for product info

email
Answered promptly sales@rabweb.com

19724 MICROWAVE SENSOR FOR D10



Thank you for buying RAB lighting fixtures. Our goal is to design the best quality products to get the job done right. We'd like to hear your comments. Call the Marketing Department at 888-RAB-1000 or email: marketing@rabweb.com



19724 Sensor



Antenna

IMPORTANT

READ CAREFULLY BEFORE INSTALLING FIXTURE. RETAIN THESE INSTRUCTIONS FOR FUTURE REFERENCE.

19724 is used with a 120-277VAC dimmable driver and comes with a sensor antenna. Sensor is shipped with Factory Settings outlined below under **DIP Switch Settings**. If settings other than factory pre-sets are desired, the consumer may change DIP Switch Settings. For more detailed control of the sensor, the consumer can purchase MVSREM wireless commissioning tool (remote) to re-program sensor settings.

DIP SWITCHES

Factory Settings shown below

SPECIFICATIONS

Sensor is not suitable for wet locations.

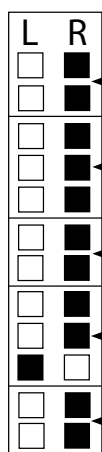

Fig. 1

Adjustable Detection Area
Time Delay
Daylight Sensor
Cut Off Period
Dim Level

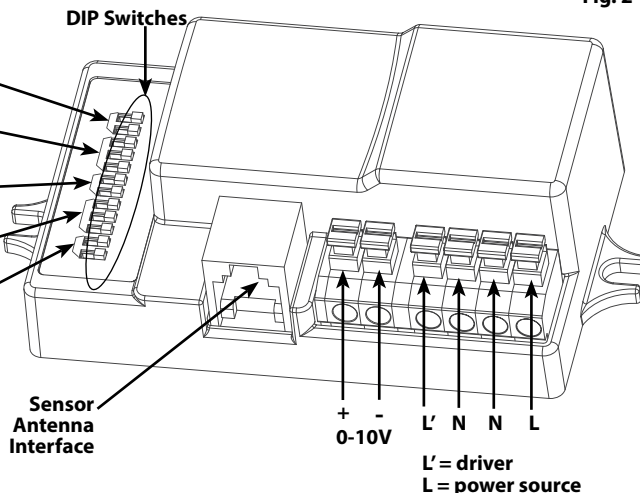

Fig. 2

DIP Switch Settings

Switch positions referred to as R for right position and L for left position when looking at sensor in orientation shown in Fig. 2, in which all switches are R.

See Fig. 1 and 2 for each setting's corresponding switches. Setting options for each category are noted in (parenthesis) below.

Factory Settings: designated in **bold** for each category

Detection Area:

- **100% (RR)**
- 75% (RL)
- 50% (LR)
- 10% (LL)

Time Delay: how long lamp remains on at 100% after last recognized motion

- **5s (RRR)**
- 30s (RRL)
- 1min (RLR)
- 5min (RLL)
- 10min (LRR)
- 20min (LRL)
- 30min (LLL)

Daylight Sensor:

- **Disabled (RR)**
- 5 fc (Daylight) (RL)
- 1 fc (Twilight) (LR)
- .2 fc (Darkness) (LL)

Cut Off Period: how long reduced light output lasts after time delay period before fixture switching off

- 0s (RRR)
- **10s (RRL)**
- 1min (RLR)
- 5min (RLL)
- 10min (LRR)
- 30min (LRL)
- 1hr (LLR)
- Always (LLL)

Dim Level: light output level after time delay

- **10% (RR)**
- 20% (RL)
- 30% (LR)
- 50% (LL)

19724 MICROWAVE SENSOR FOR D10

Thank you for buying RAB lighting fixtures. Our goal is to design the best quality products to get the job done right. We'd like to hear your comments. Call the Marketing Department at 888-RAB-1000 or email: marketing@rabweb.com

OPERATION

Multi-level Dimming:

- 100% light
- Dimmed to: 10, 20, 30, 50*%
**50% not on remote*
- Off

Cut Off Time Adjustment:

- Once room is vacated, light dims to selected % after chosen hold time elapses

Daylight Sensing:

- Surrounding natural light keeps fixture light off until room is occupied and natural light levels drop to selected level

8 Hour* Manual Mode:

- Turn fixture off-on 3 times within 3 seconds
- Green LED on antenna will flash and fixture will flash 3 times if done correctly
- Fixture will remain 100% for 8 hours, then sensor will come on automatically
- To cancel, turn the fixture off-on within 1 second

**Times out after one 8-hour cycle*

Ambient Daylight Threshold*:

- Turn fixture off-on 2 times within 2 seconds
- Green LED on antenna will flash slowly for 5 seconds and fixture will blink twice if done correctly
- Surrounding fc will be measured and recorded for 1 second
- Green LED on antenna and fixture will light for 10 seconds to indicate successful fc recording
- Most recent fc measurement overwrites any prior

**DIP settings (pg 1) and ambient lux overwrite each other depending on latest action*

Scene Mode:

- 100% detection range and 10% cut off dimming
- Scene 1 (SC1):** 1 min hold-time, 10 min cut off period, .2 fc daylight sensor
- Scene 2 (SC2):** 5 min hold-time, 10 min cut off period, .2 fc daylight sensor
- Scene 3 (SC3):** 10 min hold-time, 30 min cut off period, 1 fc daylight sensor
- Scene 4 (SC4):** 10 min hold-time, always on bi-level cut off period, 5 fc daylight sensor

SENSOR COVERAGE DIAGRAM

Below diagrams represent best average coverage from lab testing. Actual coverage may vary as metal on the fixtures can interfere with microwaves from the sensor

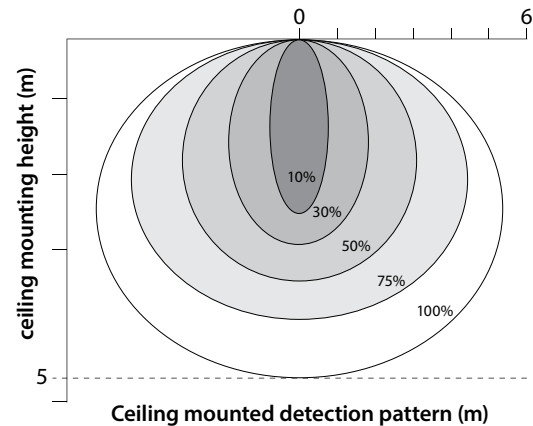

Fig. 3

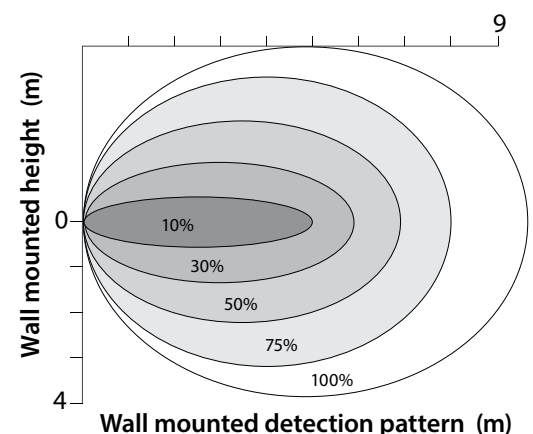

Fig. 4

SENSOR TECHNICAL DATA

Capacitance Load: 400W at 120V, 800W at 230V, 1000W at 277V

Operating Temperature: -20°C to +60°C (-4°F to +140°F)

Relay: Zero-cross relay

Maximum Mounting Height: 5m

Customizable Detection Area: 10, 50, 75 or 100%

Time Delay: 5s, 30s, 1min, 5min, 10min, 20min, 30min

Cut Off Period: 0s, 10s, 1min, 5min, 10min, 30min, 1hr, Bi-Level

Cut Off Dimming Level: 10, 20, 30, 50%

Cut Off Power: Less Than 1W

Daylight Threshold: About .2-5 fc or Disabled

Sensor Principle: High Frequency

Microwave Frequency: 5.8GHz +/- 75MHz

Microwave Power: <0.2mW

Detection Range Max: 16m across, 10m high

Detection Angle: About 30 to 150 degrees

19724 MICROWAVE SENSOR FOR D10

Thank you for buying RAB lighting fixtures. Our goal is to design the best quality products to get the job done right. We'd like to hear your comments. Call the Marketing Department at 888-RAB-1000 or email: marketing@rabweb.com

REMOTE

Sensor will beep one time to indicate remote received successfully

Remote settings will override DIP Switch settings

ON/OFF: disables sensor; light is permanently* on or off

*un-do permanent on/off by selecting either Auto-Mode, RESET, or any Scene mode button

Auto Mode: sensor activates and all previously selected settings remain programmed

RESET: overrides selected settings; reverts to DIP settings

Dim buttons: + dims up and - dims down, adjusting lamp brightness

Black Button: no function

Test 2s: automatic* test mode with 2 second time delay; disables cut off period and daylight sensor

*un-do automatic test mode by selecting either RESET, any Scene mode button, or hold time

Power 100% & Power 80%: adjusts power output; to save energy select Power 80%. Must return to full output after initial 10,000 hours of LEDs by pressing Power 100%.

Group B:

Yellow Sun Button: Ambient Daylight Threshold; records surrounding lux level and overwrites previously recorded value

.2, 1 and 5 fc: sets daylight sensor at respective ambient light values

Disable: disables daylight sensor; any motion registered by sensor activates fixture light

SC1, SC2, SC3, SC4: assigns one of 4 pre-set scenes; see "Operation" on pg 2 for scene descriptions

Fig. 5

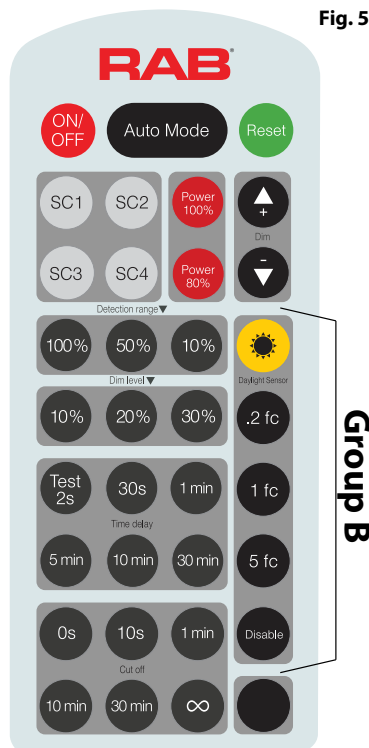

REMOTE CONTINUED

Detection Range Button Group: assigns detection range of 10, 50 or 100%; use coverage diagrams on pg 2 for guidance. To limit area in which motion will set off sensor, use a smaller percent. The sensor will not detect motion outside of 100% and the fixture will not light.

Time Delay Button Group: assigns hold time of 30 seconds, 1 minute, 5 minutes, 10 minutes, or 30 minutes

Cut Off Button Group: assigns cut off period of 0 seconds, 10 seconds, 1 minute, 10 minutes, 30 minutes, or 1 hour. 0 seconds gives fixture on/off control rather than dimming. + ∞ keeps the light on always (if daylight sensor is disabled) with Bi-Level dimming control.

Dim Level: assigns level of 10, 20, or 30% for dimmed light output after time delay passes

TROUBLESHOOTING

If the sensor does not detect motion as expected:

- Check fixture mounting to compare fixture location and sensor coverage with the coverage diagrams on pg 2
- Adjust fixture location as necessary

Fixture will not light/sensor does not detect motion:

- Make sure ON/OFF button was not selected as this results in disabling the sensor
- Check all settings to be sure there is no conflicting selection with the ambient light level

Fixture and sensor are too active:

- Check detection area setting and reduce coverage as needed
- Increase time delay and/or adjust cut off period.

Basic Function Overview:

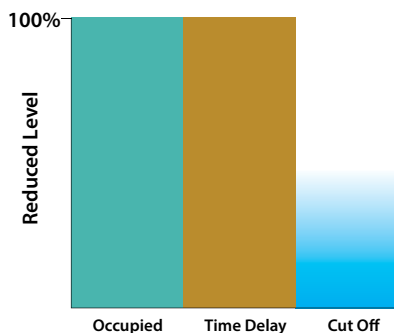

Fig. 6

Note: These instructions do not cover all details or variations in equipment nor do they provide for every possible situation during installation operation or maintenance.