

Please go to [www.quoizel.com](http://www.quoizel.com) for product cleaning tips. Go to the **Care + Maintenance** selection.

**Tools Required:** Flathead screwdriver, Phillips screwdriver, pliers, wire cutters, wire strippers, electrical tape, safety glasses.

**Light Source:** (2) A19 Medium Base 75W Maximum, Alternate bulb (2) 19W CFL.

**Estimated Assembly Time:** 30-45 minutes

**Preparation:** Identify and inspect all parts before beginning installation. Check package content list and diagrams below to be sure all parts are present. If any parts are missing or damaged, do not attempt to assemble, install, or operate the fixture. Contact customer service for replacement parts.

### **⚠ Warnings and Cautions**

Turn off electricity at circuit breaker or main fuse box before installation. Consult a licensed electrician if in doubt.

These instructions are provided for your safety. It is very important you read them completely before installing the fixture. We strongly recommend that a licensed, professional electrician perform the installation.

Disconnect fixture from power source before replacing bulbs. Make sure bulbs are given sufficient time to cool before removal. Do not subject glass parts to any shock while in operation or shattering may result.

### **⚠ Care of Tiffany Style Shade**

A new tiffany lamp shade has an oil film applied to the shade that protects the tiffany shade from scratches during shipment. If the oil applied is too heavy you can remove the excess oil film with a paper towel. Gently wipe away the excess oil.

For general cleaning of tiffany shades use a gentle lemon oil-based furniture polish applied to a soft cloth and wipe gently.

If a white powder appears on the soldered joints of the tiffany shade this is a normal oxidation process. Use a small amount of lemon oil or mineral oil applied directly to oxidized areas and the soldered area will return to like new.

### **Package Contents**

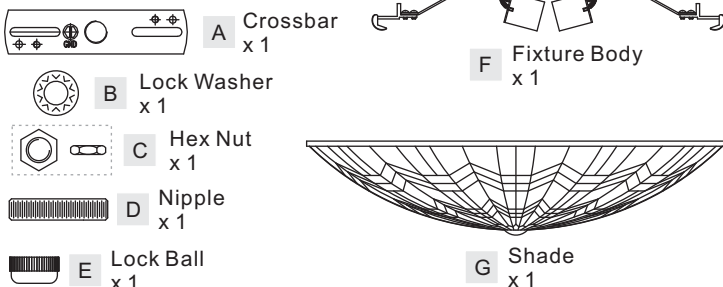

### **(Step 2 Continued)**

- Nut (C) against the Crossbar (A) to secure in place.
- D. Refer to Step 3 for wire connections.
- E. Place the Fixture Body (F) back over the Nipple (D) and secure with Lock Ball (E). Hand tighten until snug.

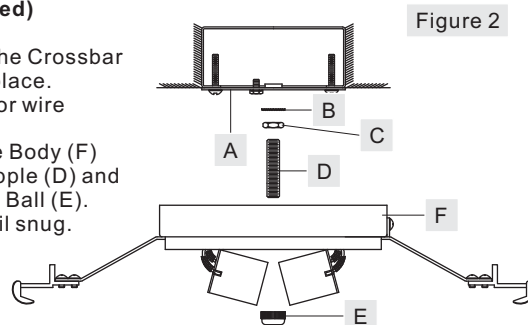

### **STEP 1 - Install Crossbar**

- A. Attach the Crossbar (A) to the Outlet Box with the head of the Green Ground Screw facing you. Secure it with Outlet Box Screws (not included). Tighten until snug.

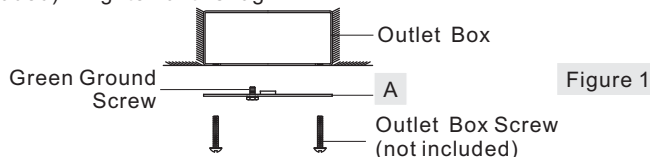

### **STEP 3 - Wire Connections**

- A. Use standard wire connectors (not included) to make all wire connections. Twist connectors until wires are tightly joined together. Wrap each connection with approved electrical tape and carefully stuff all the connected wires into the Outlet Box.

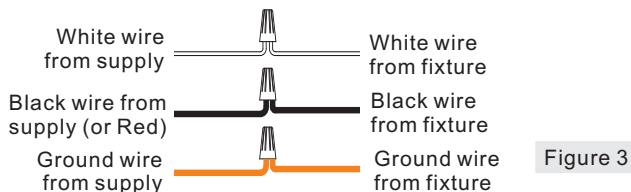

### **STEP 2 - Install Nipple and Fixture Body**

- \* Pliers is required for this step.
- A. Thread Hex Nut (C) to the middle of the Nipple (D). Place Lock Washer (B) over the Nipple (D) and then thread the Nipple (D) into the Crossbar (A) until the Nipple (D) is about 0.375" above the Crossbar (A).
- B. Place the Fixture Body (F) over the Nipple (D) against the ceiling to determine the correct position of the Nipple (D). Thread the Lock Ball (E) onto the Nipple (D). Adjust the Nipple (D) to allow the Fixture Body (F) to rest against the ceiling when held in place by the Lock Ball (E).
- C. Remove the Lock Ball (E) and the Fixture Body (F). Tighten the Hex

### **STEP 4 - Install Bulbs and Shade**

- A. This fixture uses standard bulb with a medium screw base. Maximum 75 watts. Insert bulb and screw snugly into place.
- B. Locate the Shade (G) wedge in the two Shade Holders

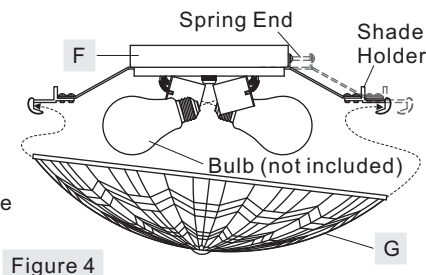

**Thank you for purchasing a Quoizel product.**  
**Need assistance with parts or assembly? Call Quoizel customer service at 1-800-645-3184**  
**or visit us on-line at [www.quoizel.com](http://www.quoizel.com)**

**(Step 4 Continued)**

without Spring. Pull the Shade Holder with the Spring out and position the Shade (G) onto the bottom of the Fixture Body (F). The Shade Holder will engage the Shade (G) after release.

Your fixture is now completed assembly and ready to use. Enjoy!

TFAT1617VA

FINISH: VALIANT BRONZE

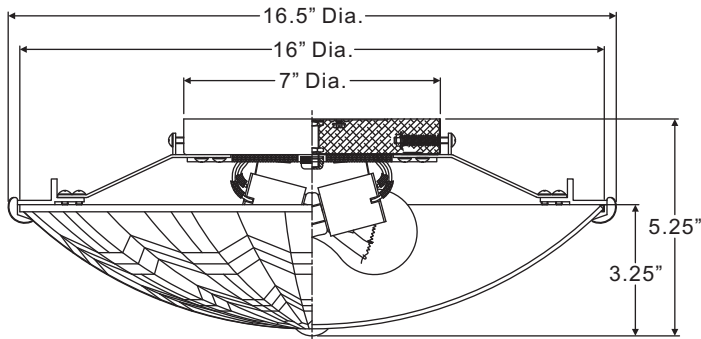
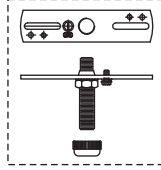

(2) 75W Medium Base Bulbs  
(Not Supplied)

NOTE: ALL DIMENSIONS ARE ROUNDED UP TO THE NEAREST 1/4"

NO.	PART NUMBER	REPLACEMENT PART	QTY.
1	G12821SH	SHADE	1

Thank you for purchasing a Quoizel product.  
Need assistance with parts or assembly? Call Quoizel customer service at 1-800-645-3184  
or visit us on-line at [www.quoizel.com](http://www.quoizel.com)