

MOUNTING INSTRUCTIONS WALLPACK LIGHT

SUITABLE FOR WATTAGES: 35W, 50W & 70W

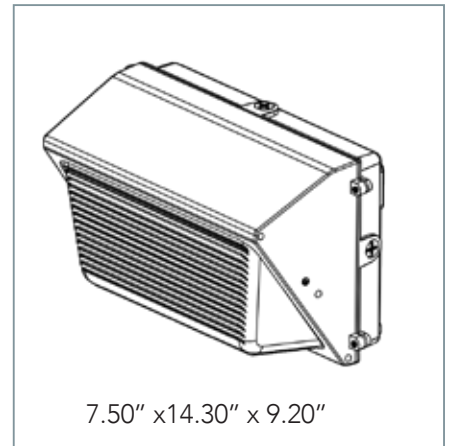
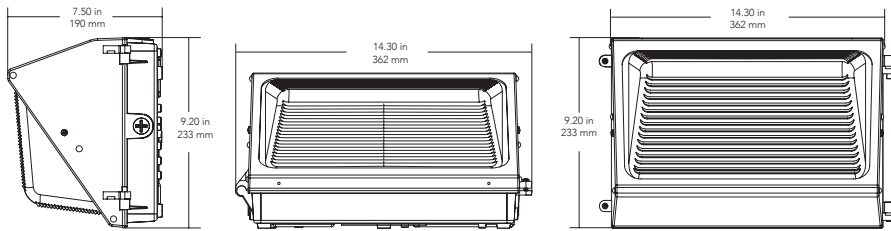

7.50" x 14.30" x 9.20"

IMPORTANT: READ BEFORE REMOVING FIXTURE FROM CARTON. RETAIN FOR FUTURE REFERENCE.

This fixture must be wired and installed in accordance with the NATIONAL ELECTRICAL CODE and all state and applicable local codes and ordinances. These codes and ordinances supersede any and all instruction contained herein. Installation should be performed only by a licensed and bonded electrician and a person familiar with the construction and operation of the product and the hazards involved in the installation and operation of this product. Proper grounding is required for safety. Make certain power is OFF before installing or maintaining fixture. Failure to do so may increase the RISK OF PERSONAL INJURY, PROPERTY DAMAGE, FIRE, AND DEATH. The manufacturer takes no responsibility for the product not installed under those guidelines and those contained in this document. See wiring diagram on back

CAUTION: For proper weatherproof function all gaskets must be seated properly and all screws inserted and tightened firmly. Apply weatherproof silicone sealant (NOT included) around the edge of the Wall Box and/or Junction Box. This is especially important with an uneven wall surface. Silicone all plugs and unused conduit entries.

MOUNTING INSTRUCTIONS:

1. Open fixture using two screws and housing will hinge open

J-BOX MOUNTING INSTRUCTIONS:

1. Drill or knock-out desired holes in bosses provided on casting backside
2. Remove plug from wiring access hole and place gasket behind back casting
3. Thread wire through housing and make wire connections in j-box (not provided)
4. Position fixture over j-box and fasten securely
5. Apply outdoor rated silicone caulking (not provided) around the j-box/ fixture joint to prevent water ingress

SURFACE MOUNTING INSTRUCTIONS:

1. Drill or knock-out desired mounting holes
2. Drill matching holes on mounting using template
3. Secure fixture to mounting surface with gasket provided between housing and wall
4. Make necessary wiring connection inside fixture
5. Apply outdoor rated silicone caulking (not provided) around the surface and fixture joint to prevent water ingress

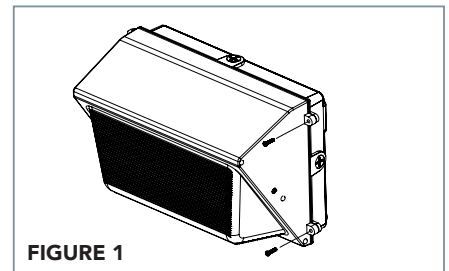

FIGURE 1

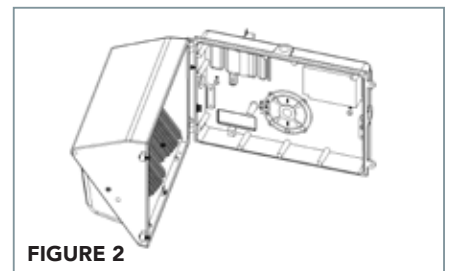

FIGURE 2

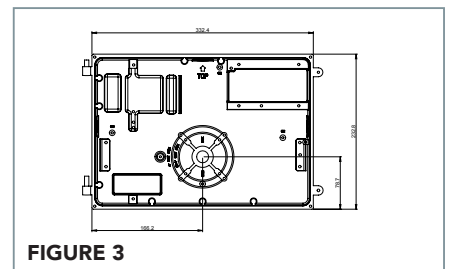

FIGURE 3

FIXTURE IS SUITABLE FOR WET LOCATION

MOUNTING INSTRUCTIONS

WALLPACK LIGHT

SUITABLE FOR WATTAGES: 35W, 50W & 70W

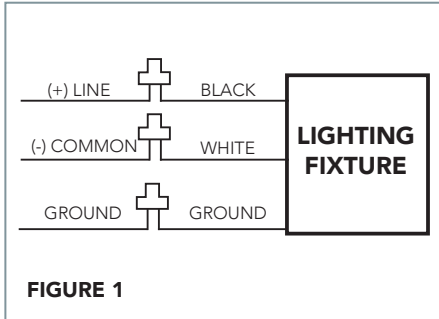

FIGURE 1

ON-OFF WIRING METHOD:

Universal voltage driver permits operation at 120V through 277V, 50 or 60 Hz. Units ordered with (480V) suffix are 480V, 60Hz. For Non-Dimming, follow the wiring directions as in FIG. 1

1. Connect the GROUND wire from fixture to supply ground
2. Connect the white fixture lead to the (-) COMMON supply lead
3. Connect the black fixture lead to the (+) LINE supply lead

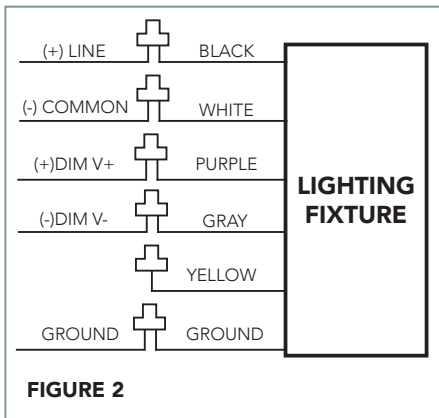

FIGURE 2

0-10V DIMMABLE WIRING METHOD:

Universal voltage driver permits operation at 120V through 277V, 50 or 60 Hz. For 0-10V Dimming, follow the wiring directions as in figure 2

1. Connect the GROUND wire from fixture to supply ground
2. Connect the white fixture lead to the (-) COMMON supply lead
3. Connect the black fixture lead to the (+) LINE supply lead
4. Connect the purple fixture lead to the (V+) DIM lead
5. Connect the gray fixture lead to the (V-) DIM lead
5. Cap the yellow fixture lead, if present. DO NOT connect

TROUBLESHOOTING:

1. Check that the line voltage at fixture is correct
2. Is there voltage at the lamp fixture wires? If there is no voltage, check all connections
3. Ensure that the fixture is grounded properly