



INSTALLATION INSTRUCTIONS 'INDY RECESSED' L4 • L6 • L8

IMPORTANT SAFETY INSTRUCTIONS

This fixture must be installed in accordance with local, federal codes and the NEC.

1. Read all instructions completely before beginning. Keep these instructions in safe place for future reference.
2. To reduce risk of fire and over-heating, make sure all connections are tight.
3. Turn off the electrical power before proceeding.

Universal Mounting Bracket:

Universal mounting bracket accepts various bar hangers.

Optional Juno Bar Hanger Accessories:

- HBTL 25" Tru-Lock Bar hangers
- HB52 52" C-Channel Bar Hangers
- HB28 28" C-Channel Bar Hangers
- LB27 27" Linear Bar Hangers

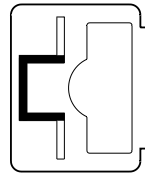
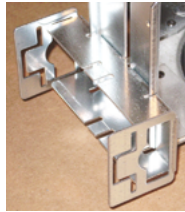

1/4" C CHANNEL

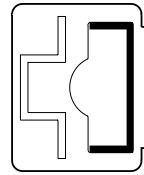

1-1/2" C CHANNEL

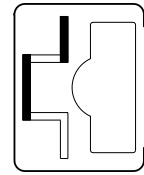

1/2" or 3/4" FLAT STRAP

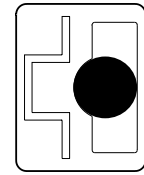

1/2" CONDUIT

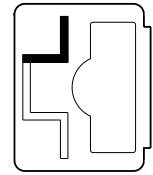

1/2" ANGLE BAR

Installation Instructions:

Step ①: Insert mounting bars into 'Universal Mounting Brackets' on either side of the fixture (see above for acceptable mounting bars).

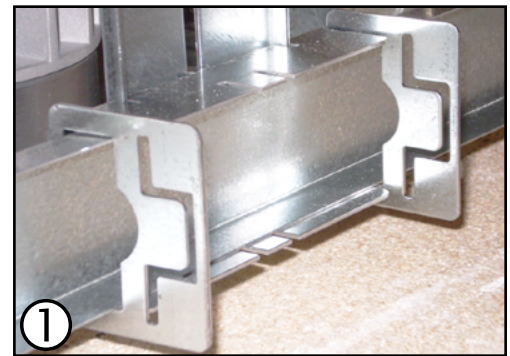

Step ②: For plaster ceiling applications, position fixture so that mounting bars lie on top of ceiling runners. For suspended ceiling applications, position fixture through opening in ceiling with bar hangers resting across inverted T. With fixture properly located, fasten the mounting bars securely to the ceiling runners/ Inverted T using binding wire or wire ties, then bend locking tab (see inset) to secure in place.

◆◆Accessory Indy Tru-Lock Bar hangers features a locking screw with secures bar hangers to Inverted T. (see detail 2A)

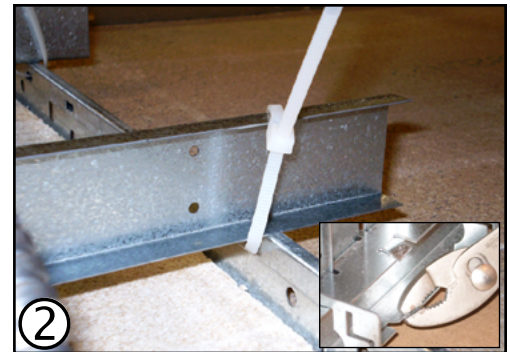
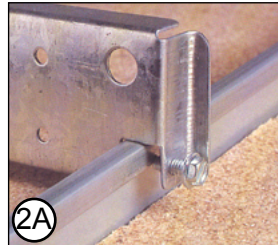

Step ③: Adjust mounting brackets (using 3/8" wrench) to the proper height by loosening nut on both mounting brackets and setting the fixture so the bottom edge of the mounting ring will be flush with the finished ceiling. Tighten nuts to secure in place. Mounting brackets provide up to 3" of vertical adjustment.

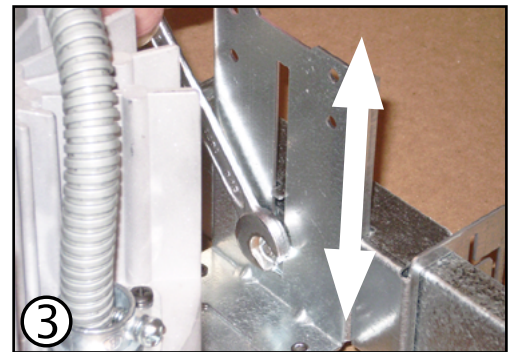

Technical Services Phone (888) 387-2212

Installation Instructions continued:

Step ④: Wiring:

- Remove junction box cover by releasing spring clip on top of box
- Remove knockout on junction box to feed power supply to fixture
- Junction box is pre-wired and requires only the connection of the supply wires as follows
 - Splice incoming line voltage lead to Black Thermal Protector lead
 - Splice incoming common lead to White Thermal Protector/White Driver jumper lead
 - Splice incoming ground lead to green fixture ground lead
 - Wire nut all open splices and replace J-Box cover.

◆◆ Provided only on fixtures 4500 lumens and above, see following pages for additional information.

*Thermal protector not required on fixtures 800-1500 lumens for 4" aperture fixtures and 800-1700 for 6" and 8" aperture fixtures.

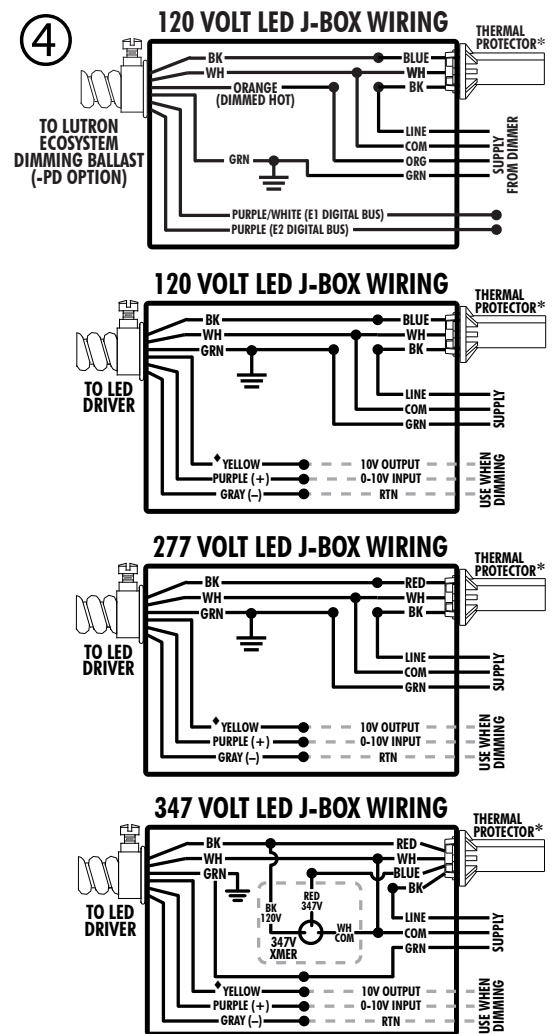

◆◆ **Important: To reduce risk of fire and over-heating, make sure all connections are tight.** ◆◆

Step ⑤: For plaster ceiling applications, once drywall has been mounted, additional adjustment may be needed to bring the housing down to flush.

This can be done by loosening the three (3) screws inside housing and raising/lowering housing.

- Fixture may be adjusted to accommodate ceiling thicknesses up to 2" thick.



Step ⑥: Install trim to complete installation.



Technical Services Phone (888) 387-2212

0-10V DIMMABLE DRIVER 4500-9000 LUMENS DIMMER: SOURCING APPLICATION

Note: Control system provides 0-10V out

SINGLE LIGHT
FIXTURE
APPLICATION

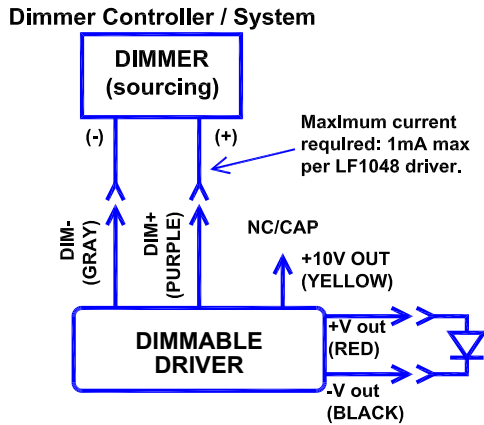

NOTE: This information is for reference only. Number of drivers connected on one line depends on many factors. Consult dimmer's manufacturer for more information.

MULTIPLE LIGHT FIXTURE APPLICATION

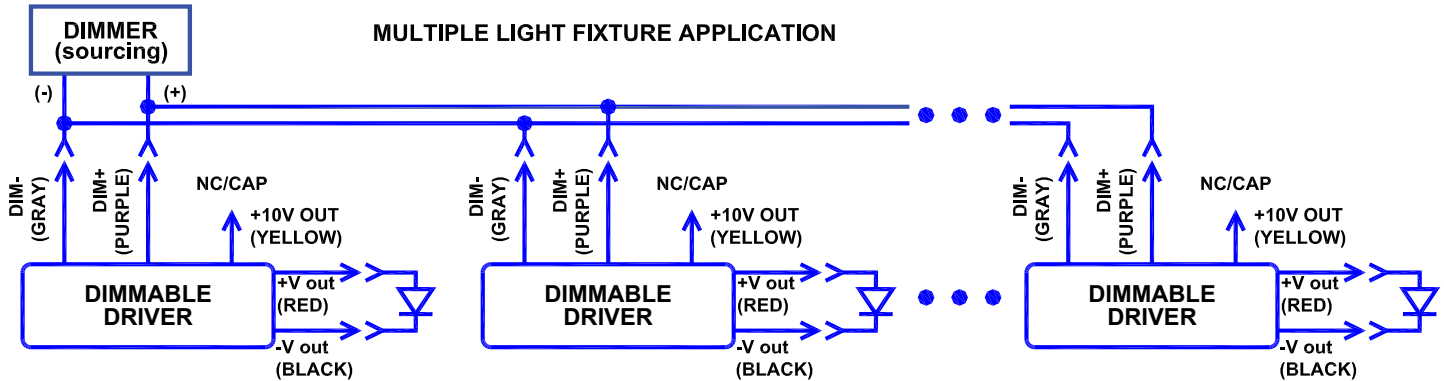

Advisory: +10V out (yellow wire) not used.

0-10V DIMMABLE DRIVER 4500-9000 LUMENS DIMMER: SINKING APPLICATION

Note: Driver provides 10V output

SINGLE LIGHT
FIXTURE
APPLICATION

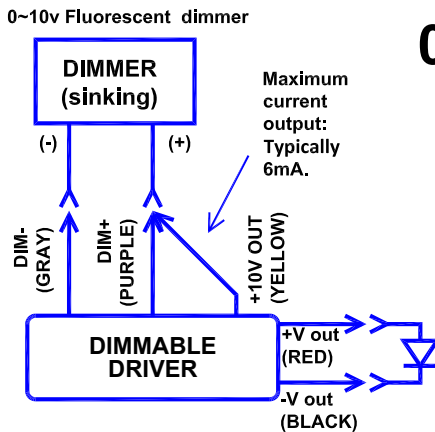

NOTE: This information is for reference only. Number of drivers connected on one line depends on many factors. Consult dimmer's manufacturer for more information.

MULTIPLE LIGHT FIXTURE APPLICATION

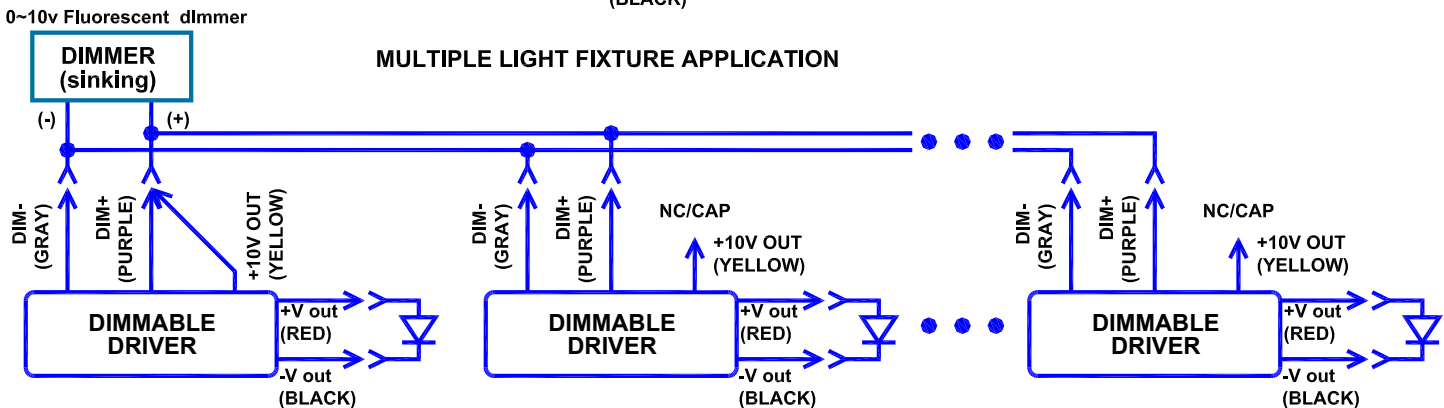

Advisory: Only one +10V out (yellow wire) used or needed to operate multiple drivers.

Technical Services Phone (888) 387-2212