

PHILIPS Day-Brite CFI

Recessed

LP3 paralouver 2x4

3 Lamp, T8, T5, or T5HO
18 or 24 cell

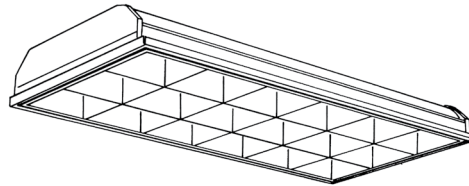

Project: _____
 Location: _____
 Cat.No: _____
 Type: _____
 Lamps: _____ Qty: _____
 Notes: _____

The Philips Day-Brite / Philips CFI LP3 paralouver recessed is designed to provide the optimum balance of visual comfort, luminaire efficiency, and low cost.

Ordering guide

Example: 2LP3GA332-36AL-UNV-1/3-EBLHE-LPT835HL

Width	Family	Ceiling Type	Air Function	No. of Lamps (not included)	Lamp Type	Louver Config. (cells wide x cells long)	Louver Finish	Voltage	Options
2	LP3			3					
2 2'	LP3 LP3 paralouver	G Grid F Flange Z Z-Spline/ Modular	A Air supply C Combination (air & heat transfer) H Heat transfer S Static (no air function)	3	28 28WT5 (46") 32 32WT8 (48") 54HO 54WT5HO (46")	36 3x6 38 3x8	AL Semi-specular anodized aluminum low iridescence W Matte white paint	120 277 347 UNV Universal Voltage 120-277V	1/3 One 3-lamp ballast 1/21 2-lamp & 1-lamp ballasts APC Air pattern control blades ASC Snap out air slot covers 2WC Two wireway covers DWC One deep wireway cover 2DWC Two deep wireway covers PAF Housing painted after fabrication EB Electronic ballast, <10% THD, std. ballast factor EB10R T8 electronic ballast, program rapid start, <10% THD EBLHE T8 electronic ballast, high efficiency, std. ballast factor EBLHE T8 electronic ballast, high efficiency, low ballast factor EBHHE T8 electronic ballast, high efficiency, high ballast factor EBSD T8 electronic step dimming ballast, .88 ballast factor EBD7 Advance Mark 7 dimming ballast, 0-10V (low voltage) control EBDX Advance Mark 10 dimming ballast, phase control EBD Electronic dimming ballast, customer specified E1 B100 emerg. ballast, T8, 350-450 lumens, 120/277V E1CAN B100-CAN emerg. ballast, Canada market, T8, 350-450 lumens, 120/347V E7 B60 emerg. ballast, T8, 600-700 lumens, 120/277V E5 B50 emerg. ballast, U.S. or Canada market, T8, 1100-1400 lumens, UNV E5CAN B50-CAN emerg. ballast, Canada market, T8, 1100-1400 lumens, 120/347V E5ST B50ST emerg. ballast w/self test, T8, 1100-1400 lumens, UNV E7LP LP550 emerg. ballast T5/T5HO, 430-700 lumens, 120/277V E6LP LP600 emerg. ballast U.S. or Canada market, T5/T5HO, 750-1325 lumens, 120/277V F1 3/8" flex, 3 wire 18 gauge 6' F2 3/8" flex, 4 wire 18 gauge 6' F2/5W 3/8" flex, 5 wire 18 gauge 6' GLR Fusing, fast blow LPT830 Installed T8/T5/T5HO lamps, 80+ CRI, 3000K LPT835 Installed T8/T5/T5HO lamps, 80+ CRI, 3500K LPT841 Installed T8/T5/T5HO lamps, 80+ CRI, 4100K LPT830HL Installed T8/T5 hi lumen lamps, 80+ CRI, 3000K LPT835HL Installed T8/T5 hi lumen lamps, 80+ CRI, 3500K LPT841HL Installed T8/T5 hi lumen lamps, 80+ CRI, 4100K CHIC Chicago plenum rated

Accessories (order separately)

- **FMA24** 2'x4' "F" mounting frame for NEMA "F" mounting
- **FKDP24** Flange conversion kit 2x4



2LP3 LP3 paralouver recessed 2x4

3 lamp, T8, T5, or T5HO, 18 or 24 cell

Application

- Low-brightness troffer for most ceilings:
 - Grid inverted T (NEMA “G”)
 - Flange-type for concealed mechanical suspension (NEMA “F”)
 - Modular and “Z” spline (NEMA “M/Z”)
- Designed for air supply/return through side slots and/or heat transfer. Select the appropriate catalog no. for air function desired. Air pattern control blades in side slots must be ordered as an option. Air boots by others.
- Excellent visual comfort and inconspicuous appearance.

Construction/Finish

- Housing is multi-stage phosphate treated for maximum corrosion resistance and finish coat is high reflectance baked white enamel.
- Flat black finish inside perimeter reveal for “floating door” appearance.

- Built in grid clips designed for use with standard 1-1/2” high grid ceiling members.
- Supplied with one wireway cover. Two wireway covers (2WC, 2DWC) are available.
- Standard wireway cover is designed to accommodate small can ballasts. Use of emergency ballasts or specification of ballasts other than generic ballasts may require the use of a larger wireway cover. Deep wireway cover (DWC) accommodates 2-3/8” W x 1-1/2” H ballasts and may be specified when ordering.

Electrical

- cULus listed for damp locations.
- Self-contained fluorescent emergency power packs can be incorporated. LP series emergency ballasts are recommended for use with the standard wireway cover. Standard series emergency ballasts may be used with the larger wireway cover.

Enclosure

- Parabolic-shaped louvers closely controlled for uniform low-brightness appearance, and interlocked to avoid vibration.
- Choice of semi-specular (AL) low iridescence anodized aluminum or matte white paint louver finishes.
- 18 Cell: Lengthwise shielding is 19°. Crosswise shielding is 36°.
- 24 Cell: Lengthwise shielding is 25°. Crosswise shielding is 36°.
- Bottom aluminum flange has mitered corners and fits flush with ceiling.
- Can be hinged and latched from either side.
- Shipped with plastic film to keep out construction dirt.
- Guide-post spring loaded latches standard.

Dimensions

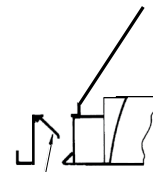
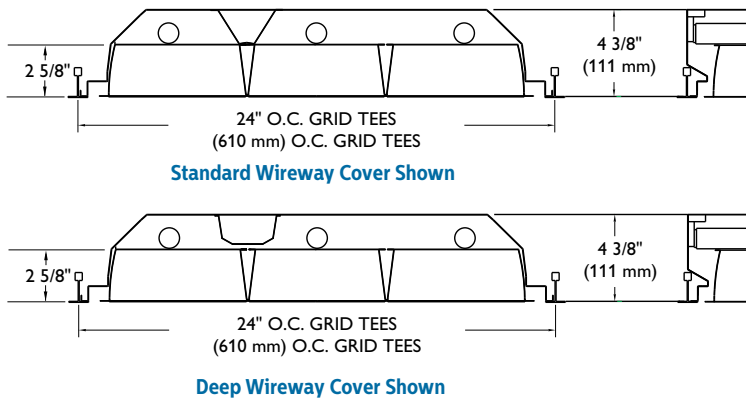

Optional Air Pattern Control (on Air and Combination Units)

- Fully adjustable
 - Closed= Static
 - 45°= Horizontal Air Supply
 - 90°= (fully open) – Vertical Air Supply
- Side Slots may also be used for Return Air to Plenum
- Snap-in Air Slot Covers (ASC) also available

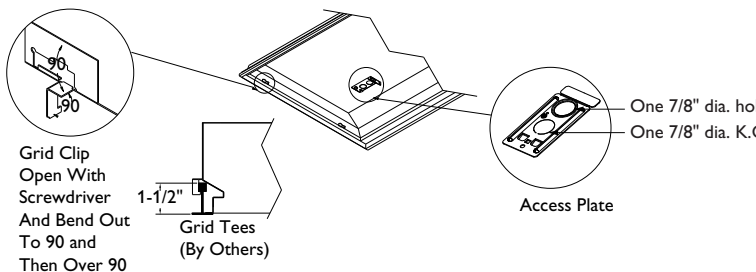

Some luminaires use fluorescent or high intensity discharge (HID) lamps that contain small amounts of mercury. Such lamps are labeled, “Contain Mercury” and/or the symbol “HG”. Lamps that contain mercury must be disposed of in accordance with local requirements. Information regarding lamp recycling and disposal can be found at www.lamprecycle.org

2LP3 LP3 paralouver recessed 2x4

3 lamp, T8, T5, or T5HO, 18 or 24 cell

Ceiling configuration

2 LP3 G S 3 32

Ceiling type

G = Grid (NEMA G)

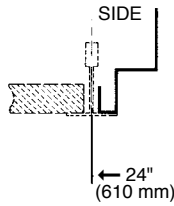

(NEMA Type G)
Lay-in acoustical ceilings using exposed grid suspension, with tees for luminaires on 24" x 48" spacing.

F = Flange (NEMA F)

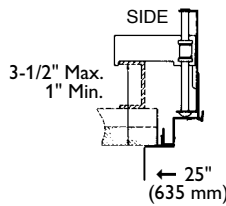

(NEMA Type F)
Flange for acoustical ceilings using concealed mechanical suspension. Swing-jack mounting brackets: adjustment 3-1/2" max. and 1" min. Refer to sheet 801-CL for output information.

Z = Modular & "Z" Spline (NEMA M/Z)

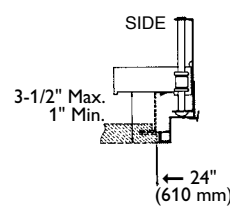

(NEMA M/Z)
Modular and "Z" Spline using concealed mechanical suspension. Swing-jack mounting brackets: adjustment 3-1/2" max. and 1" min.

Photometry

LP3 2x4 3 Lamp T8 18 Cell

Efficiency – 72.2%

LER – 60

TER – 55

Catalog No.	2LP3GS332-36AL-1/3-EB	Candlepower				Light Distribution				Average Luminance					
Test No.	20833	Angle	End	45	Cross	Degrees	Lumens	% Lamp	% Luminaire	Angle	End	45°	Cross		
S/MH	1.6	0	2286	2286	2286	0-30	1888	22.1	30.6	45	3525	4637	4687		
Lamp Type	F32T8	5	2285	2282	2273	0-40	3266	38.2	52.9	55	3262	3404	2631		
Lumens/Lamp	2850	10	2247	2265	2282	0-60	5712	66.8	92.5	65	1741	1428	1370		
Ballast Factor	0.88	15	2187	2248	2307	0-90	6173	72.2	100.0	75	183	214	214		
Input Watts	90	20	2111	2223	2367					85	75	94	75		
		25	2027	2210	2474	Coefficients of Utilization									
		30	1923	2217	2617	EFFECTIVE FLOOR CAVITY REFLECTANCE 20 PER (pfc=0.20)									
		35	1810	2226	2603	pcc	80			70			50		
		40	1678	2179	2404	pw	70	50	30	70	50	30	50	30	
		45	1528	2010	2032	RCR									
		50	1356	1669	1412	0	85	85	85	83	83	83	80	80	
		55	1147	1197	925	1	80	77	75	78	76	73	72	70	
		60	871	712	623	2	73	68	65	71	68	64	65	61	
		65	451	370	355	3	68	60	56	66	59	55	57	54	
		70	95	129	84	4	63	55	48	60	54	48	52	46	
		75	29	34	34	5	57	48	42	56	47	42	46	41	
		80	12	15	13	6	53	44	38	52	44	38	41	36	
		85	4	5	4	7	48	40	34	47	40	34	39	33	
						8	46	36	30	45	35	30	34	29	
						9	42	34	28	41	33	28	32	27	
						10	40	30	25	39	30	25	29	25	

Comparative yearly lighting energy cost per 1000 lumens – \$4.00 based on 3000 hrs. and \$.08 pwr KWH.

The photometric results were obtained in the Philips Day-Brite laboratory which is NVLAP accredited by the National Institute of Standards and Technology.

2LP3 LP3 paralouver recessed 2x4

3 lamp, T8, T5, or T5HO, 18 or 24 cell

LP3 2x4 3 Lamp T8 24 Cell		Efficiency – 70.9%				LER – 59				TER – 54					
Catalog No.	2LP3GS332-38AL-1/3-EB	Candlepower				Light Distribution				Average Luminance					
Test No.	20839	Angle	End	45	Cross	Degrees	Lumens	% Lamp	% Luminaire	Angle	End	45°	Cross		
S/MH	1.6	0	2343	2343	2343	0-30	1920	22.5	31.7	45	3566	4584	4720		
Lamp Type	F32T8	5	2348	2334	2326	0-40	3311	38.7	54.6	55	3071	3239	2784		
Lumens/Lamp	2850	10	2302	2316	2338	0-60	5717	66.9	94.3	65	610	1104	1366		
Ballast Factor	0.88	15	2240	2292	2358	0-90	6063	70.9	100.0	75	158	208	252		
Input Watts	90	20	2160	2255	2414					85	75	94	94		
		25	2069	2235	2506	Coefficients of Utilization									
		30	1963	2233	2651	EFFECTIVE FLOOR CAVITY REFLECTANCE 20 PER (pfc=0.20)									
		35	1844	2233	2636	pcc	80			70			50		
		40	1710	2175	2441	pw	70	50	30	70	50	30	50	30	
		45	1546	1987	2046	RCR									
		50	1345	1632	1481	0	83	83	83	81	81	81	79	79	
		55	1080	1139	979	1	79	76	73	77	75	71	71	69	
		60	669	636	663	2	72	68	64	70	67	63	64	60	
		65	158	286	354	3	67	60	56	66	59	55	57	54	
		70	52	80	90	4	61	54	48	59	53	47	52	46	
		75	25	33	40	5	56	48	42	56	47	42	46	41	
		80	10	14	16	6	53	44	38	52	42	38	41	36	
		85	4	5	5	7	48	40	34	47	40	34	38	34	
						8	46	36	30	45	35	30	34	29	
						9	42	34	28	41	33	28	32	27	
						10	40	30	26	39	30	25	29	25	
Comparative yearly lighting energy cost per 1000 lumens – \$4.07 based on 3000 hrs. and \$.08 pwr KWH.															
The photometric results were obtained in the Philips Day-Brite laboratory which is NVLAP accredited by the National Institute of Standards and Technology.															

© 2017 Philips Lighting Holding B.V. All rights reserved.
 Philips reserves the right to make changes in specifications and/or to discontinue any product at any time without notice or obligation and will not be liable for any consequences resulting from the use of this publication.
philips.com/luminaires



Philips Lighting North America Corporation
 200 Franklin Square Drive, Somerset, NJ 08873
 Tel. 855-486-2216

Philips Lighting Canada Ltd.
 281 Hillmount Rd, Markham, ON, Canada L6C 2S3
 Tel. 800-668-9008