

## DESCRIPTION

Recessed 6-inch LED lens downlight is available in various distributions, lumen and CRI/CCT options. Suitable for commercial construction and can be used for both new or renovation work. Insulation must be kept 3" from top and sides of housing. Use for general area lighting where high efficiency and visual comfort are required.

Catalog #		Type
Project		
Comments		Date
Prepared by		

## SPECIFICATION FEATURES

### MECHANICAL

#### Frame

Boat shaped galvanized steel frame with adjustable plaster lip accommodates ceilings up to 1/2" - 2" thick. May be used for new construction or remodeling installations. Provided with (2) remodel clips to secure frame when installed from below the ceiling.

#### Mounting Brackets

Bar hanger receivers adjust 2" vertically from above the ceiling or thru the aperture. Use with No Fuss™ bar hangers or with 1/2" EMT. Removable to facilitate installation from below the ceiling.

#### No Fuss™ Bar Hangers

Captive preinstalled bar hanger locks to tee grid with a screwdriver or pliers. Centering mechanism allows consistent positioning of fixtures.

### OPTICAL

#### LED Module

Proximity phosphors over chip on board LEDs provide a uniform source with high efficiency and no pixilation. Available in 80 or 90 CRI minimum, accuracy within 3 SDCM provides color uniformity. See ordering information for available CRI / CCT options. Passive thermal management achieves L70 at 50,000 hours in non IC applications. Integral diffuse lens provides visual shielding. Integral connector allows quick connection to housing flex.

#### Reflector

One piece parabolic aluminum reflector provides cutoff for a visually comfortable optic. Attaches to LED module with (3) speed clamps minimizing light leaks to lens. Self-flanged standard with an optional white painted flange.

#### Trim Retention

Reflectors are retained with two torsion springs holding the flange tightly to the finished ceiling surface.

#### ELECTRICAL Junction Box

(6) 1/2" and (2) 3/4" trade size pry outs positioned to allow straight conduit runs. Listed for (12) #12 AWG (six in, six out) 90°C conductors and feed thru branch wiring.

#### Driver

Integral UNV 120 - 277V 50/60 Hz constant current driver provides noise free operation. For 347V input use Halo transformer H347 or H347200. Continuous, flicker-free dimming from 100% to 10% with leading or trailing edge phase cut at 120V or 0 -10V analog control.

#### Emergency Option

Provides 90 minutes of standby lighting meeting most life safety codes for egress lighting. Available with both integral or remote charge indicator and test switch.

### Compliance

- cULus listed for wet location
- cCSAus listed for wet location
- IP66 Ingress Protection Rated
- Insulation must be kept 3" from top and sides.
- Airtight per ASTM-E283.
- Optional City of Chicago environmental air (CCEA) marking for plenum applications.
- EMI/RFI emissions per FCC 47CFR Part 18 non-consumer limits.
- Contains no mercury or lead and RoHS compliant.
- Photometric testing in accordance with IES LM-79-08.
- Lumen maintenance projections in accordance with IES LM-80-08 and TM-21-11.
- Can be used to comply with California Title 24 Non-Residential Lighting Controls requirements as a LED Luminaire.
- ENERGY STAR® listed for commercial applications, reference database for current listings.



**PD612**  
**PD618**

**PDM6**

**61V**

**1,200 & 1,800**  
**Lumen Series**

**LED**

**6-Inch Aperture**  
**Lens Downlight**

Lumens	1200 Series	
Input Voltage	120V	277V
Input Current	0.19A	0.1A
Input Power	23 W	23.2 W
Efficiency	73 LpW	73 LpW
Inrush Current	2.14A	4.1A

Lumens	1800 Series	
Input Voltage	120V	277V
Input Current	0.24A	0.12A
Input Power	29.5 W	29.4 W
Efficiency	70 LpW	70 LpW
Inrush Current	2.88A	6.94A

THD: ≤ 20%
PF: ≥ 0.90
T Ambient -30 - +40°C
Sound Rating ≤ 22dba

## ORDERING INFORMATION

**SAMPLE NUMBER:** PD612ED010REM-PDM6827-61VC

A complete luminaire consists of a housing, LED module and reflector, order separately.

Housing	Lumens	Driver	Options	LED Module	CRI/CCT
<b>PD6</b> = 6" aperture LED downlight <b>PD6CP</b> = 6" aperture LED downlight, CCEA listed for City of Chicago plenum requirements	<b>12</b> = 1,200 lumens (nominal) <b>18</b> = 1,800 lumens (nominal)	<b>ED010</b> = 120-277V 50/60Hz, 0-10V and LE/ TE phase cut dimming	<b>REM</b> = Emergency operation with remote indicator and test switch  <b>IEM</b> = Emergency operation with integral indicator and test switch, 60 Hz only (REM and IEM options not available with PD6CP housing)	<b>PDM6</b> = Downlight LED module for PD6 housing, provides 1,200 or 1,800 lumens (nominal) depending on connected housing type	<b>827</b> = 80 CRI, 2700K CCT <b>927</b> = 90 CRI, 2700K CCT <b>830</b> = 80 CRI, 3000K CCT <b>930</b> = 90 CRI, 3000K CCT <b>835</b> = 80 CRI, 3500K CCT <b>935</b> = 90 CRI, 3500K CCT <b>840</b> = 80 CRI, 4000K CCT <b>940</b> = 90 CRI, 4000K CCT

Reflector	Finish Option	Flange Option	Accessories
<b>61V</b> = 6" vertical parabolic reflector <b>61VEM</b> = 6" vertical parabolic reflector for IEM	<b>C</b> = Specular clear <b>G</b> = Specular gold <b>H</b> = Semi-specular clear <b>W</b> = White (white flange) <b>BB</b> = Black baffle (white flange) <b>WB</b> = White baffle (white flange)	<b>Blank</b> = Polished flange standard with C, G & H reflector finishes <b>Blank</b> = White flange standard with W, BB, & WB <b>WF</b> = White flange option available with C, G, & H reflector finishes	<b>HB128APK</b> = L channel hanger bar, 26", 'No-Fuss', pair (replacement) <b>RMB22</b> = 22" long wood joist mounting bars, pair <b>H347</b> = Step down transformer for 347V input <b>H347</b> = Step down transformer for 347V input, 75VA max <b>H347200</b> = Step down transformer for 347V input, 200VA max

## DIMENSIONS

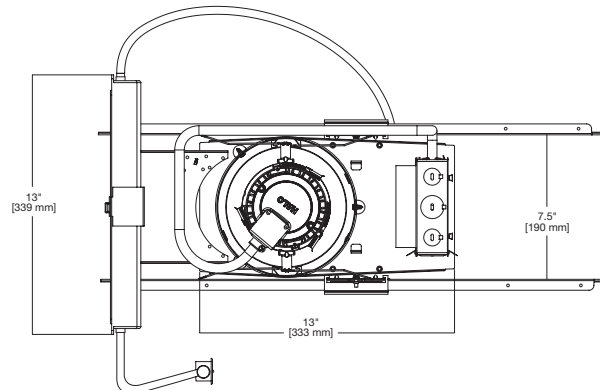
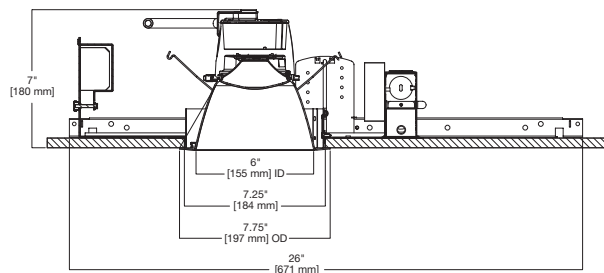
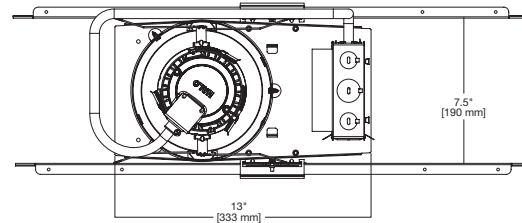
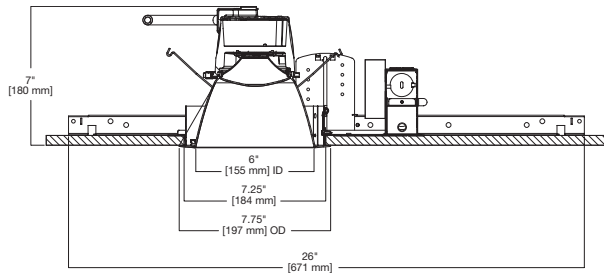

## COMPLIANCE TABLE

### 1200 LUMEN

80 CRI								
Catalog #	PD612ED010 - PDM6827		PD612ED010 - PDM6830		PD612ED010 - PDM6835		PD612ED010 - PDM6840	
	LUMENS	LPW	LUMENS	LPW	LUMENS	LPW	LUMENS	LPW
61VC	1528	66	1589	69	1644	71	1673	73
61VCWF	1538	67	1600	70	1655	72	1684	73
61VG	1519	66	1580	69	1635	71	1663	72
61VGWF	1483	64	1542	67	1596	69	1623	71
61VH	1410	61	1467	64	1518	66	1544	67
61VHWF	1412	61	1469	64	1520	66	1546	67
61VW	1397	61	1453	63	1503	65	1530	67
61VWB	1495	65	1555	68	1609	70	1637	71
61VBB	1363	59	1417	62	1467	64	1492	65

90 CRI								
Catalog #	PD612ED010 - PDM6927		PD612ED010 - PDM6930		PD612ED010 - PDM6935		PD612ED010 - PDM6940	
	LUMENS	LPW	LUMENS	LPW	LUMENS	LPW	LUMENS	LPW
61VC	1186	52	1274	55	1379	60	1378	60
61VCWF	1193	52	1283	56	1388	60	1388	60
61VG	1179	51	1267	55	1371	60	1370	60
61VGWF	1150	50	1236	54	1338	58	1338	58
61VH	1094	48	1176	51	1273	55	1272	55
61VHWF	1096	48	1178	51	1275	55	1274	55
61VW	1084	47	1165	51	1261	55	1260	55
61VWB	1160	50	1247	54	1349	59	1348	59
61VBB	1057	46	1136	49	1230	53	1229	53

### 1800 LUMEN

80 CRI								
Catalog #	PD618ED010 - PDM6827		PD618ED010 - PDM6830		PD618ED010 - PDM6835		PD618ED010 - PDM6840	
	LUMENS	LPW	LUMENS	LPW	LUMENS	LPW	LUMENS	LPW
61VC	1856	63	1936	66	2009	68	2045	69
61VCWF	1868	63	1949	66	2022	69	2058	70
61VG	1845	63	1925	65	1997	68	2032	69
61VGWF	1801	61	1879	64	1949	66	1984	67
61VH	1713	58	1787	61	1854	63	1887	64
61VHWF	1715	58	1789	61	1856	63	1889	64
61VW	1697	58	1770	60	1836	62	1869	63
61VWB	1816	62	1894	64	1965	67	2000	68
61VBB	1655	56	1727	59	1791	61	1823	62

90 CRI								
Catalog #	PD618ED010 - PDM6927		PD618ED010 - PDM6930		PD618ED010 - PDM6935		PD618ED010 - PDM6940	
	LUMENS	LPW	LUMENS	LPW	LUMENS	LPW	LUMENS	LPW
61VC	1448	49	1555	53	1679	57	1701	58
61VCWF	1457	49	1566	53	1690	57	1712	58
61VG	1439	49	1546	52	1669	57	1691	57
61VGWF	1405	48	1509	51	1629	55	1650	56
61VH	1336	45	1435	49	1549	53	1569	53
61VHWF	1338	45	1437	49	1552	53	1572	53
61VW	1324	45	1422	48	1535	52	1555	53
61VWB	1416	48	1522	52	1642	56	1664	56
61VBB	1291	44	1387	47	1497	51	1517	51

**ES, T24** ES = ENERGY STAR® Qualified  
T24 = Can be used to comply with California Title 24 Non-Residential

## PHOTOMETRY

### PD612ED010- PDM6835-61VC

Spacing Criteria = 0.84  
Lumens per Watt = 71.5 LpW  
Test No. P113874  
Test Model: PD612ED010- PDM6835-61VC

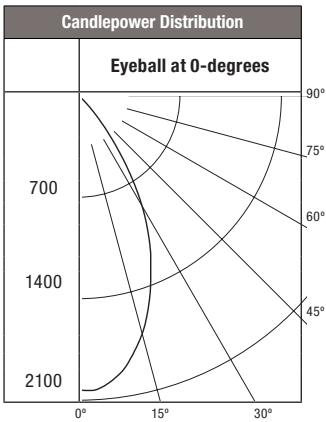

Candela Distribution	
Degrees Vertical	Candela
0*	2031
5	2012
15	1700
25	1175
35	546
45	103
55	11
65	3
75	0
85	0
90	0

\*CBCP

Luminance	
(Average Candela/M <sup>2</sup> )	
Degree	Avg. 0° Luminance
45	7993
55	1032
65	428
75	0
85	0

Cone of Light Footcandles			
Distance to Illuminated Plane	Initial Nadir Footcandles	Beam (ft.)	
		L Length	W Width
5.5'	67.1	4.4	4.4
7'	41.4	5.8	5.8
8'	31.7	6.6	6.6
9'	25.1	7.4	7.4
10'	20.3	8.2	8.2
12'	14.1	10	10

Beam diameter is to 50% of maximum footcandles, rounded to the nearest half-foot. Footcandle values are initial, apply appropriate light loss factors where necessary.

Zonal Lumen Summary		
Zone	Lumens	% Fixture
0-30	1193	72.5
0-40	1535	93.3
0-60	1638	99.6
0-90	1644	100

Scaling factor for the Battery back up:

- 1800 Lumen = 0.33
- 1200 Lumen = 0.27

### PD612ED010- PDM6930-61VC

Spacing Criteria = 0.84  
Lumens per Watt = 55.4 LpW  
Test No. P113877  
Test Model: PD612ED010- PDM6930-61VC

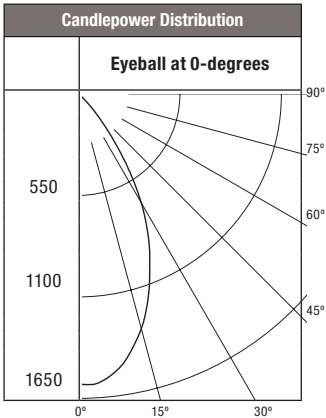

Candela Distribution	
Degrees Vertical	Candela
0*	1574
5	1559
15	1317
25	910
35	423
45	80
55	8
65	2
75	0
85	0
90	0

\*CBCP

Luminance	
(Average Candela/M <sup>2</sup> )	
Degree	Avg. 0° Luminance
45	6194
55	803
65	324
75	0
85	0

Cone of Light Footcandles			
Distance to Illuminated Plane	Initial Nadir Footcandles	Beam (ft.)	
		L Length	W Width
5.5'	52	4.4	4.4
7'	32.1	5.8	5.8
8'	24.6	6.6	6.6
9'	19.4	7.4	7.4
10'	15.7	8.2	8.2
12'	10.9	10	10

Beam diameter is to 50% of maximum footcandles, rounded to the nearest half-foot. Footcandle values are initial, apply appropriate light loss factors where necessary.

Zonal Lumen Summary		
Zone	Lumens	% Fixture
0-30	924	72.5
0-40	1189	93.3
0-60	1269	99.6
0-90	1274	100

Scaling factor for the Battery back up:

- 1800 Lumen = 0.33
- 1200 Lumen = 0.27

## PHOTOMETRY

### PD618ED010- PDM6835-61VC

Spacing Criteria = 0.84  
Lumens per Watt = 68.1 LpW  
Test No. P113858  
Test Model: PD618ED010- PDM6835-61VC

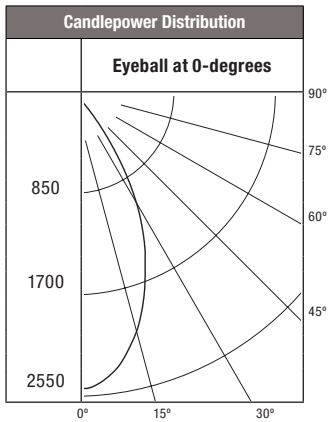

Candela Distribution	
Degrees Vertical	Candela
0*	2481
5	2457
15	2077
25	1435
35	667
45	126
55	13
65	4
75	0
85	0
90	0

\*CBCP

Luminance	
(Average Candela/M <sup>2</sup> )	
Degree	Avg. 0° Luminance
45	9761
55	1271
65	519
75	0
85	0

Cone of Light Footcandles			
Distance to Illuminated Plane	Initial Nadir Footcandles	Beam (ft.)	
		L Length	W Width
5.5'	79	4.4	4.4
7'	48.8	5.8	5.8
8'	37.4	6.6	6.6
9'	29.5	7.4	7.4
10'	23.9	8.2	8.2
12'	16.6	10	10

Beam diameter is to 50% of maximum footcandles, rounded to the nearest half-foot. Footcandle values are initial, apply appropriate light loss factors where necessary.

Zonal Lumen Summary		
Zone	Lumens	% Fixture
0-30	1457	72.5
0-40	1875	93.3
0-60	2001	99.6
0-90	2009	100

Scaling factor for the Battery back up:

- 1800 Lumens = 0.33
- 1200 Lumens = 0.27

### PD618ED010- PDM6930-61VC

Spacing Criteria = 0.84  
Lumens per Watt = 52.7 LpW  
Test No. P113861  
Test Model: PD618ED010- PDM6930-61VC

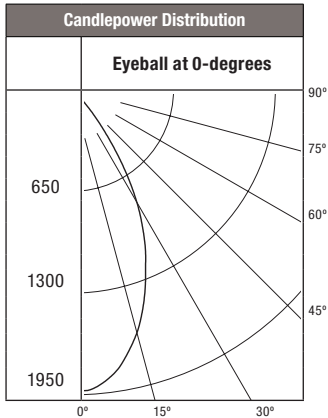

Candela Distribution	
Degrees Vertical	Candela
0*	1921
5	1902
15	1608
25	1111
35	516
45	98
55	10
65	3
75	0
85	0
90	0

\*CBCP

Luminance	
(Average Candela/M <sup>2</sup> )	
Degree	Avg. 0° Luminance
45	7559
55	984
65	402
75	0
85	0

Cone of Light Footcandles			
Distance to Illuminated Plane	Initial Nadir Footcandles	Beam (ft.)	
		L Length	W Width
5.5'	63.5	4.4	4.4
7'	39.2	5.8	5.8
8'	30	6.6	6.6
9'	23.7	7.4	7.4
10'	19.2	8.2	8.2
12'	13.3	10	10

Beam diameter is to 50% of maximum footcandles, rounded to the nearest half-foot. Footcandle values are initial, apply appropriate light loss factors where necessary.

Zonal Lumen Summary		
Zone	Lumens	% Fixture
0-30	1128	72.5
0-40	1452	93.3
0-60	1550	99.6
0-90	1555	100

Scaling factor for the Battery back up:

- 1800 Lumens = 0.33
- 1200 Lumens = 0.27