

Twist-Lock® Devices

50A, 480V AC, 2 Pole, 3 Wire Grounding

Insulgrip® Connector

HUBBELL



Features

- Box terminal with hex socket threaded slug, permits high clamping pressure on conductors without damaging strands
- Heavy duty two-piece external cord clamp provides maximum strain relief
- Box terminal with hex socket threaded slug, permits high clamping pressure on conductors without damaging strands
- Thermoplastic polyester interior provides heat resistance and impact strength
- Oversized contacts minimize operating temperature



Ordering Information

Description	Cord Diameter	UPC	Catalog Number
Nylon housing, thermoplastic polyester interior	.830"-1.250" (21.08-31.75)	783585829142	CS8464C

Listings

Listed to UL 498
Certified to CSA C22.2 No.42

Specifications

Housing	Nylon
Terminal Retainer	Thermoplastic polyester
Contacts	Brass
Terminal Screws	Stainless Steel
Cord Grip	Polyester

Performance

Electrical	
Current Interrupting	Certified for current interrupting at full rated current
Dielectric Voltage	Withstands 2,000V minimum

Mechanical	
Terminal Accommodation	#8 AWG - #4 AWG stranded copper wire only

Environmental	
Flammability	HB or better
Operating Temperatures	Maximum continuous 75°C; minimum -40°C (w/o impact)

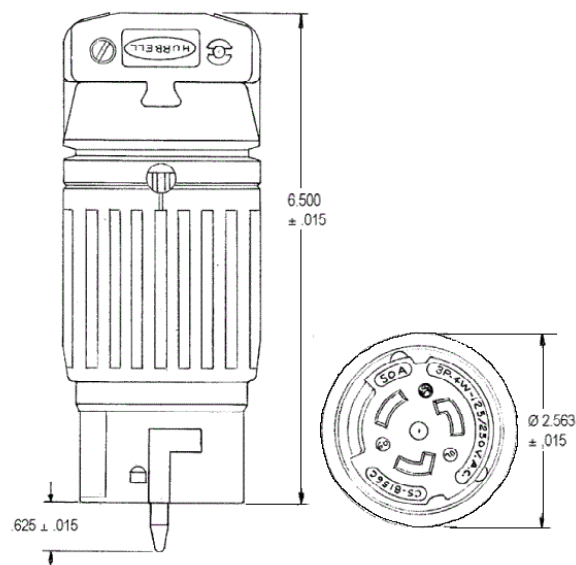

Accessories

Plug	CS8465C
Weatherproof Boot	HBL7717C
Flanged Inlet	CS8475
Weatherproof Boot	HBL7716C

Online Resources

Customer Use Drawing
eCatalog
Installation Instructions

Dimensions in Inches (mm)

Hubbell Wiring Device-Kellems • Hubbell Incorporated (Delaware) • 40 Waterview Drive • Shelton, CT 06484

Phone (800) 288-6000 • Fax (800) 255-1031 • Specifications subject to change without notice.

