

RadioRA 2 Wall-mount Designer keypads

RadioRA 2 wall-mount designer keypads provide homeowners with a simple and elegant way to operate lights, shades/draperies, motorized screens, and many other devices.

RadioRA 2 keypads feature large, easy-to-use buttons, plus a unique backlit engraving option that makes the keypads readable any time of the day or night. The keypad buttons are rounded, allowing engraving to be displayed at an upward angle, increasing readability.

Replacement Kits are available in a variety of colors and with custom engraving to clearly identify each button's function. The flexible design of the keypads allow the color, number of buttons, and the configuration of the buttons to be changed after the keypad is installed.

Use only Lutron® Designer (Claro® or Satin Colors®) wallplates. The mechanical design of the keypad is NOT compatible with non-Lutron wallplates. Wallplates are sold separately. Lutron Claro and Satin Colors wallplates snap on with no visible means of attachment.

Model Numbers

RRD-W1RLD-XX*	Dual group with 1 Raise/Lower
RKD-W1RLD-XX*-E	Engraved Replacement Kit
RRD-W2RLD-XX*	Dual group with 2 Raise/Lower
RKD-W2RLD-XX*-E	Engraved Replacement Kit
RRD-W3BD-XX*	3 button dual group
RKD-W3BD-XX*-E	Engraved Replacement Kit
RRD-W3BRL-XX*	3 buttons with Raise/Lower
RKD-W3BRL-XX*-E	Engraved Replacement Kit
RRD-W5BRLIR-XX*	5 buttons with Raise/Lower and Infrared (IR) lens
RKD-W5BRLIR-XX*-E	Engraved Replacement Kit
RRD-W6BRL-XX*	6 buttons with Raise/Lower
RKD-W6BRL-XX*-E	Engraved Replacement Kit
RRD-W7B-XX*	7 buttons
RKD-W7B-XX*-E	Engraved Replacement Kit

*RadioRA 2 wall-mount designer keypads are available in 27 colors. Please see page 7 for color selections.



RRD-W1RLD



RRD-W2RLD



RRD-W3BD



RRD-W3BRL



RRD-W5BRLIR



RRD-W6BRL



RRD-W7B

RadioRA 2 Wall-mount Designer keypads

Specifications

Model Numbers	Keypads: RRD-W1RLD-XX, RRD-W2RLD-XX, RRD-W3BD-XX, RRD-W3BRL-XX, RRD-W5BRLIR-XX, RRD-W6BRL-XX, RRD-W7B-XX Replacement Kits: RKD-W1RLD-XX-E, RKD-W2RLD-XX-E, RKD-W3BD-XX-E, RKD-W3BRL-XX-E, RKD-W5BRLIR-XX-E, RKD-W6BRL-XX-E, RKD-W7B-XX-E
Power	120 V~ 50/60 Hz 0.5 A
Typical Power Consumption	0.6 W Test conditions: all backlights on medium intensity, two LEDs on (two presets active), keypad powered at 120 V~
Regulatory Approvals	UL, CSA, NOM, FCC, IC, COFETEL
Environment	Ambient operating temperature: 32 °F to 104 °F (0 °C to 40 °C), 0% to 90% humidity, non-condensing. Indoor use only.
Communications	Wall-mount designer keypads communicate with the system through Radio Frequency (RF) and must be located within 30 ft (9 m) of a repeater.
ESD protection	Tested to withstand electrostatic discharge without damage or memory loss, in accordance with IEC 61000-4-2.
Surge Protection	Tested to withstand surge voltages without damage or loss of operation, in accordance with IEEE C62.41-1991 Recommended Practice on Surge Voltages in Low-Voltage AC Power Circuits.
Power Failure	Power failure memory: should power be interrupted, the keypad will return to its previous state when power is restored.
Mounting	Requires a U.S. wallbox. 3 ½ in (89 mm) deep recommended, 2 ¼ in (57 mm) deep minimum.
Wiring	Wall-mount designer keypads require a neutral wire connection.
Warranty	1 Year Limited Warranty. http://www.lutron.com/resiinfo

Design Features

- At the press of a single button, lights fade ON or OFF to desired levels and shades/draperies open or close to desired positions.
- Light levels and shade/drapery positions can be fine-tuned by pressing and holding the raise/lower buttons.
- Programmable to select scene or room preset levels or positions.
- Adjustable backlight intensity.
- IR receivers at the front (-W5BRLIR only) and back (all models) of the keypad allow for the use of an IR remote for line-of-sight operation (front) or IR repeater kit integration (back).
- Use an IR remote to select the same programmed rooms, scenes, and raise/lower buttons as the keypad (-W5BRLIR only).
- Configurable Raise/Lower selection
 - Last button or IR room/scene (default) - devices controlled by the last button pressed or last IR room/scene selected will raise/lower.
 - Double-tap - devices controlled by a double-tapped button will raise/lower.
- Prepaid engraving included. Redeemable for one engraved Replacement Kit.

RadioRA 2 Wall-mount Designer keypads

Dimensions

All dimensions are shown as $\frac{\text{in}}$
(mm)

Front View

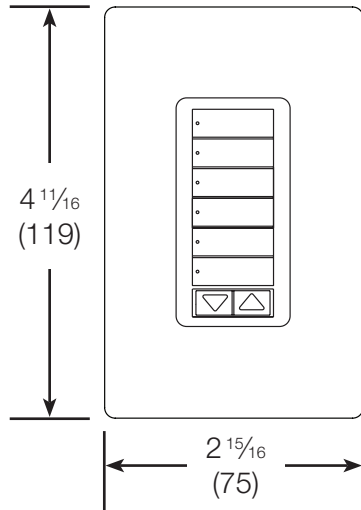

Side View

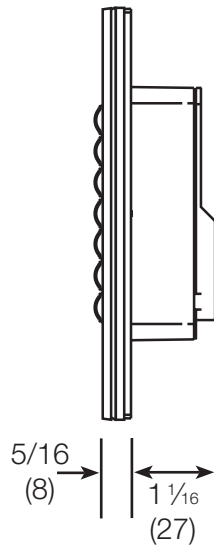

Rear View

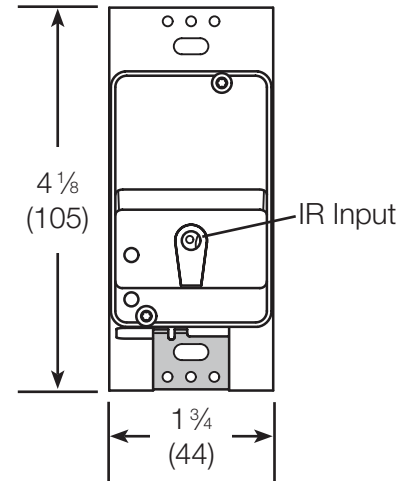

Mounting and Parts Identification

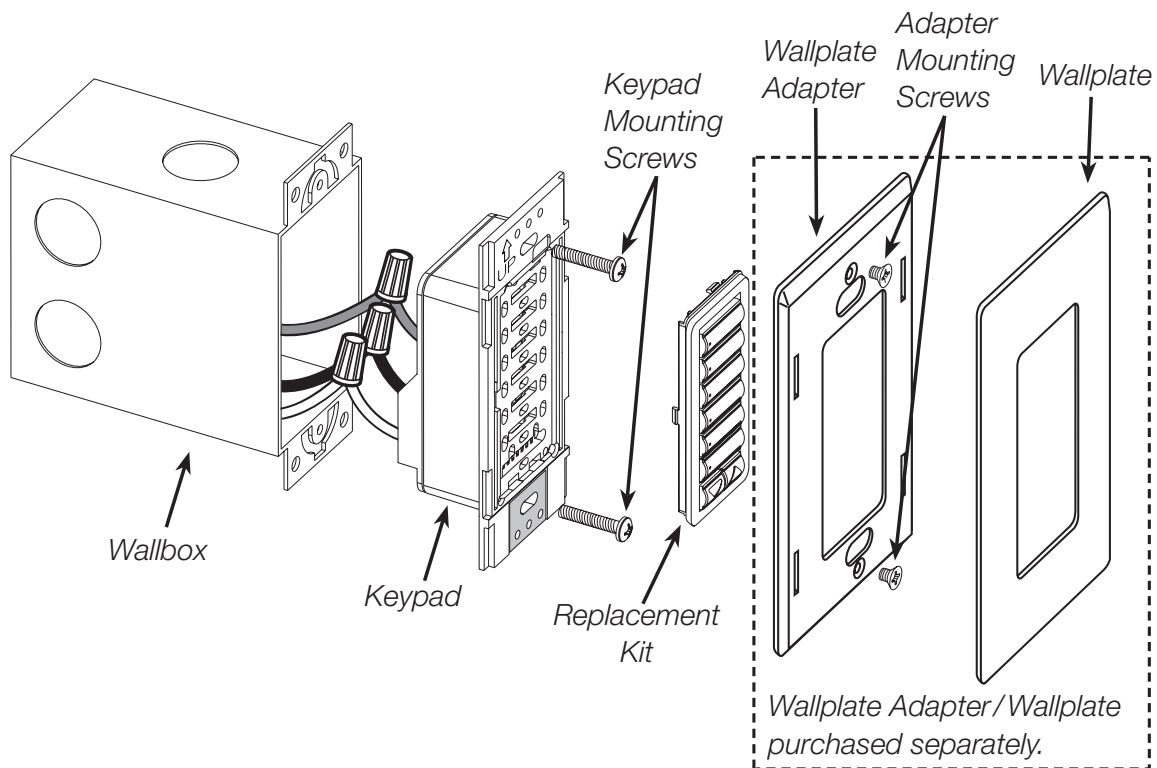

RadioRA 2 Wall-mount Designer keypads

Operation

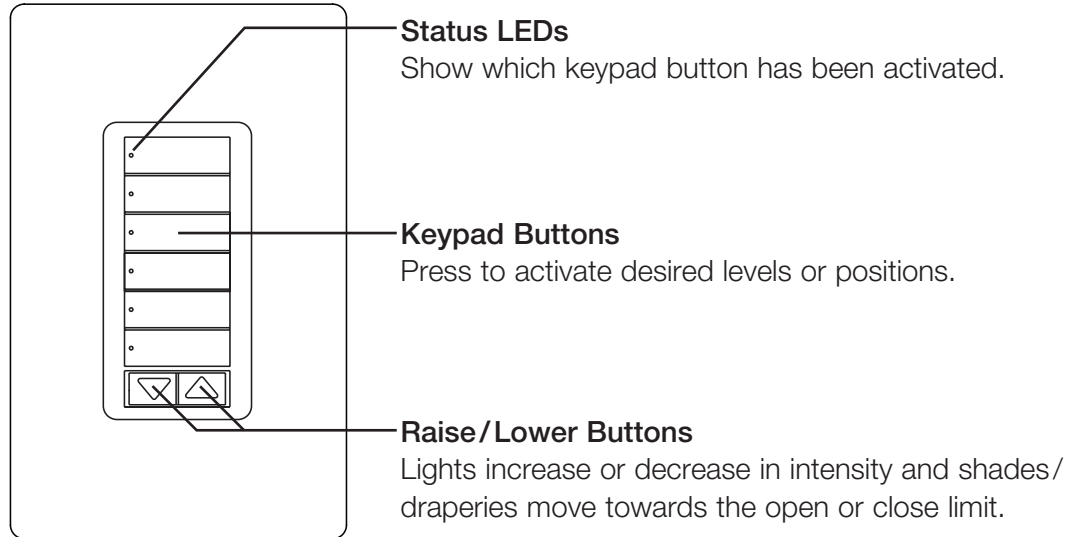

Wiring Diagram

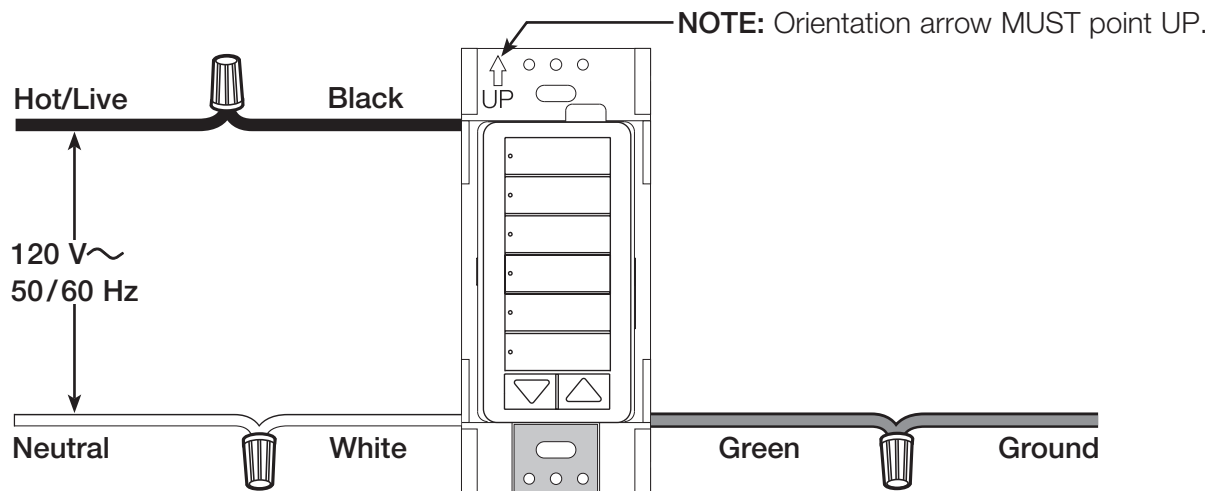

RadioRA 2 Wall-mount Designer keypads

Keypad IR Receiver

An integral feature of the *RadioRA 2* lighting control system is to utilize keypads to receive IR signals and communicate to the rest of the *RadioRA 2* system through RF signals. *RadioRA 2* keypads can receive IR signals from Lutron® wireless remotes (models GRX-IT & GRX-8IT) and 3rd party learnable IR remotes.

IR Mapping

When a keypad receives one of the supported *Lutron* IR codes, it will simulate the corresponding button press as shown below. The IR receiver on the back of a keypad allows IR transmitters to mimic the functions of the buttons on the front of the keypad. For example, if RRD-W3BD is used, the IR remote maps to the six IR buttons shown below.

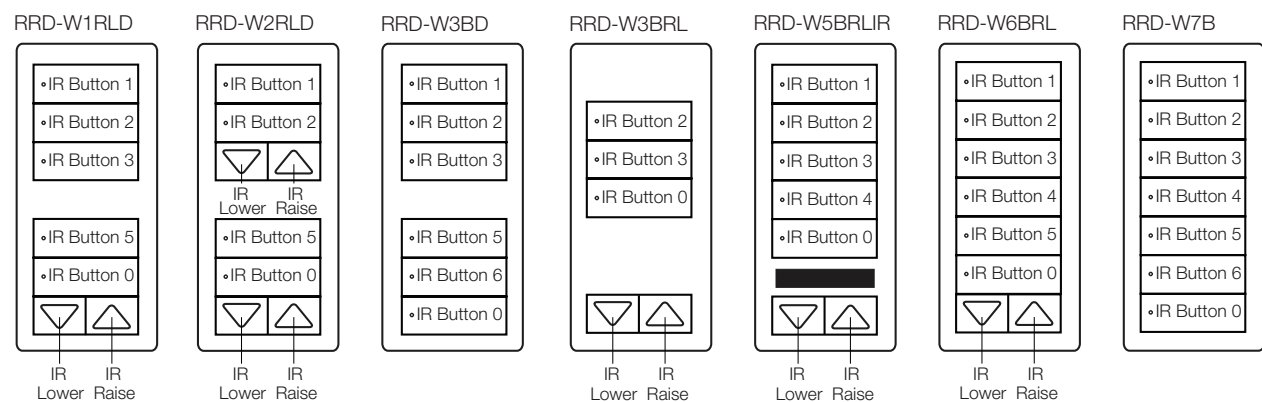

Supported IR Remotes

RadioRA 2 keypads can be controlled by Lutron® IR remotes (models GRX-IT & GRX-8IT) and 3rd party learnable IR remotes.

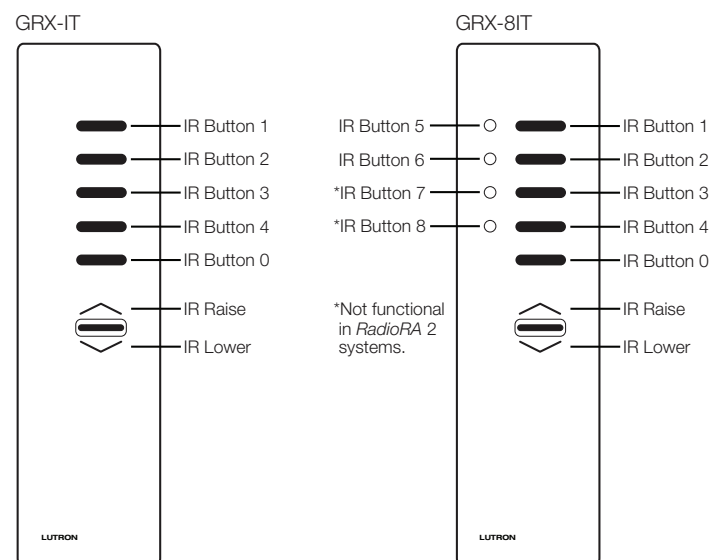

RadioRA 2 Wall-mount Designer keypads

Learnable IR Remote Codes

IR Technical Specifications*

Category	Specification
IR Carrier Frequency	40.0 kHz
Duty Cycle	40%
Single Bit Time	2.288 ms
Baud Rate	437 bps
Command Length	36 bits
Command Duration	82.368 ms
Logic One	Presence of IR modulated at 40.0 kHz
Logic Zero	Absence of IR

IR Codes

Remote Button	IR Code (Hexadecimal)
IR Button 1	FF88BD1D0h
IR Button 2	FF88BD240h
IR Button 3	FF88BD2B0h
IR Button 4	FF88BD710h
IR Button 5	FF88BD7E0h
IR Button 6	FF88BD470h
IR Button 0	FF88BD120h
IR Raise	FF8882220h
IR Lower	FF8882140h

Single Bit Time

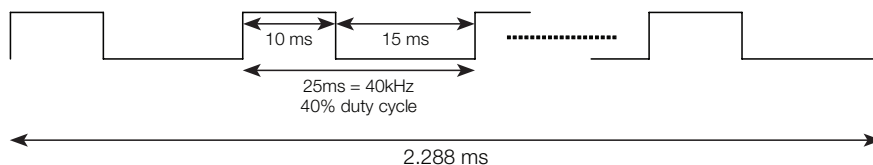

*IR codes are transmitted from an IR remote to the IR receiver on a keypad while a button on the remote is being held down. Timeouts may occur when seven seconds of continuous IR code transmission has taken place. Therefore, it is important to transmit the most significant bit of the IR code first.

NEC® Requirements

RadioRA 2 keypads can accept IR into the front or back of the unit, leading to the potential to have both electric light and power conductors and Class 2 circuit conductors in the same wallbox.

Solution...

The 2008 National Electrical Code® (NEC) Article 725.136 (D) provides the specific rules governing Class 2 conductors and electric light and power conductors within the same wallbox. It states that electric light and power conductors may be allowed in the same enclosure as Class 2 circuit conductors, provided they are both introduced for connection to the same equipment, and if one of the following requirements is also met:

1. The electric light and power conductors are routed to maintain a minimum of 1/4 in (6 mm) of separation from the Class 2 circuit conductors, or:
2. The circuit conductors operate at 150 V~ or less, and meet the following requirement:
Class 2 circuits are installed using types CL3, CL3R, CL3P or permitted substitute cables and the cable conductors extending beyond the jacket are separated by a minimum of 1/4 in (6 mm), or by a nonconductive sleeve/barrier, from all other conductors.

Understand though...

The NEC is a document subject to interpretation. Your local city, county, municipality or state authorities have the final authority to approve or disapprove any installation. They must always be consulted for verification of the code, and the manner in which it will be applied in your area, prior to installation.

RadioRA 2 Wall-mount Designer keypads

Colors and Finishes

Gloss Finishes



White
WH



Ivory
IV

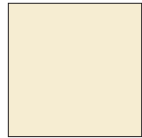

Almond
AL



Light
Almond
LA



Gray
GR



Brown
BR



Black
BL

Satin Finishes



Hot
HT



Merlot
MR



Plum
PL

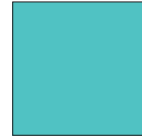

Turquoise
TQ

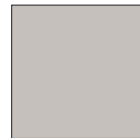

Taupe
TP



Eggshell
ES



Biscuit
BI



Snow
SW



Palladium
PD



Midnight
MN



Sienna
SI



Terracotta
TC



Greenbriar
GB



Bluestone
BG



Mocha
Stone
MS



Goldstone
GS



Desert Stone
DS



Stone
ST



Limestone
LS

- Due to printing limitations, colors and finishes shown cannot be guaranteed to perfectly match actual product colors.
- Color chip keychains are available for more precise color matching:
Gloss Finishes- DG-CK-1
Satin Finishes - SC-CK-1

Metal Finish (wallplate only)



Stainless
Steel SS

When using Stainless Steel wallplates, it is recommended to order the keypad in Black (BL) or Midnight (MN).