

Right Angle Slotted Metal Framing



Create the support framing you need

Right Angle Metal Framing is manufactured from commercial quality steel in three different sizes. The small sizes are 14 ga. steel, the larger is 12 ga. steel. With this offering, an endless variety of metal framing requirements can be met, from lightweight supporting needs to larger shelving for inventory storage.

One of the legs on all sizes is 1-5/8 in. wide, while the other is either 1-5/8 in., 2-3/8 in. or 3-1/8 in. long. Depending on the frame requirements, a single size can be utilized throughout, or the sizes can be interchanged to get the most efficient usage from the material.

This section will serve as a guide to plan and build your structure.

Installation time is reduced - inventory space is minimal

Scribe marks are placed every 3/4 in. which saves planning, layout and cutting time and ensures accuracy. The exclusive slot and hole pattern, repeated every 3 in., is scientifically designed for ease of assembly and rigidity. No welding is necessary, no holes to drill. A 9/16 in. wrench is the only tool required for assembly. The proper nuts and bolts are included with the material to ensure fast and easy erection.

Right angle metal framing is packaged in 10' and 12' lengths to minimize cut offs and ensure maximum use of material.

120 feet, 10, 12 foot lengths of right angle metal framing take up the same amount of space as one 2x4. A standard package includes 5 pieces to a bundle, significantly reducing handling and storage space.

The importance of cutting right angle easily, quickly and accurately is the key to time saving assembly. The portable cutter provides these advantages and makes layout and erection of any structure a "light-work" job.

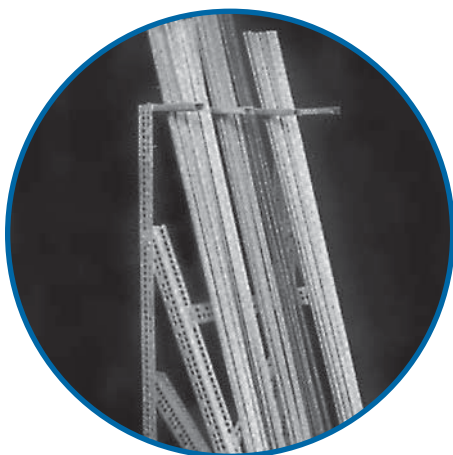
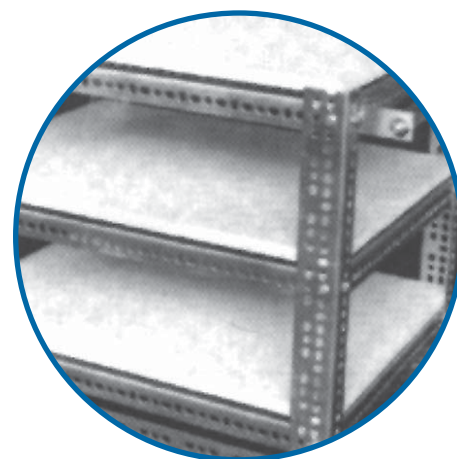

Finish is designed for long lasting durability

The standard GoldGalv® hardware finish is applied to all Right Angle Metal Framing after rolling and punching of the holes. This provides you with a number of benefits. First, raw ends resulting from cuts will be protected by the sacrificial quality of zinc. Second, the edges of all holes are protected against formation of rust, to provide a call back free installation. Third, the electrogalvanizing provides an excellent bonding surface for paint if desired for aesthetic reasons.

Note: Product is also available in pregalvanized (PG) sections.

FLEXIBILITY

SIMPLICITY

ECONOMY

Right Angle Slotted Metal Framing

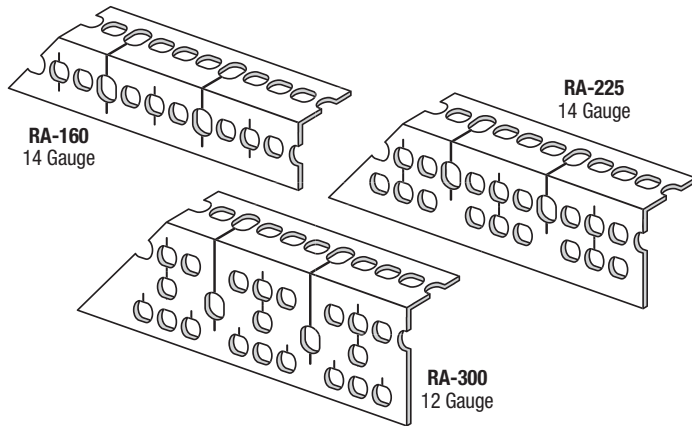

Cat. No.	Length ft.	No. of ft./per Pkg.
RA-160-10	10	50
RA-160-12	12	60
RA-225-10	10	50
RA-225-12	12	60
RA-300-10	10	50
RA-300-12	12	60

Each package includes 36 nuts and bolts.

Extra Nuts and Bolts

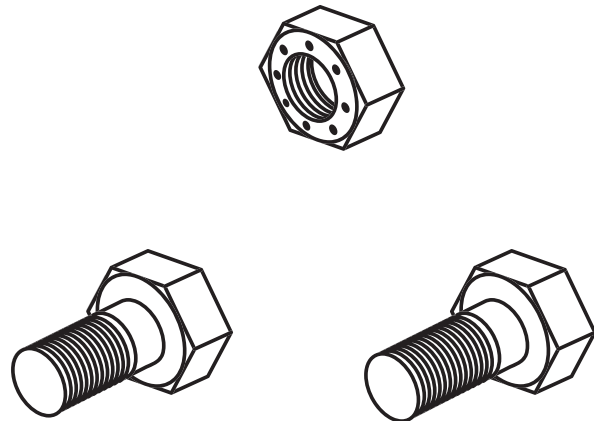

Cat. No.	Package 100 Sets	Std. Ctn.
RA-BN-5/8	2-3/8 in. - 16 x 1-5/8 in.	100
Use with RA-160 & RA-225		
RA-BN-3/4	2-3/8 in. - 16 x 3/4 in.	100
Use with RA-300		

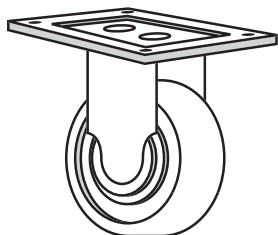

RA-RC

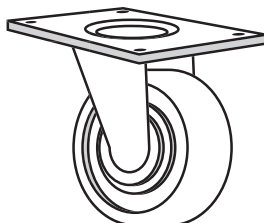

RA-SC

Rigid & Swivel Casters.
Hard rubber composition 3-1/2 in. dia.
with load rating of 225 lb. per wheel.

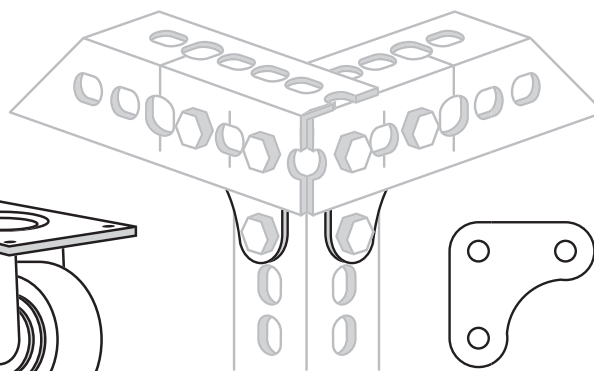

RA-GP
Gusset Plate
For extra rigid
assembly

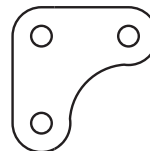

RA-C
Portable Cutter

Cat. No.	Package	Std. Ctn.
RA-GP	25	100
RA-RC	2	2
RA-SC	2	2
RA-C	1	1