

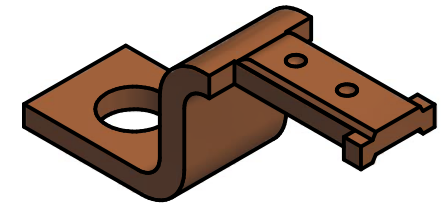

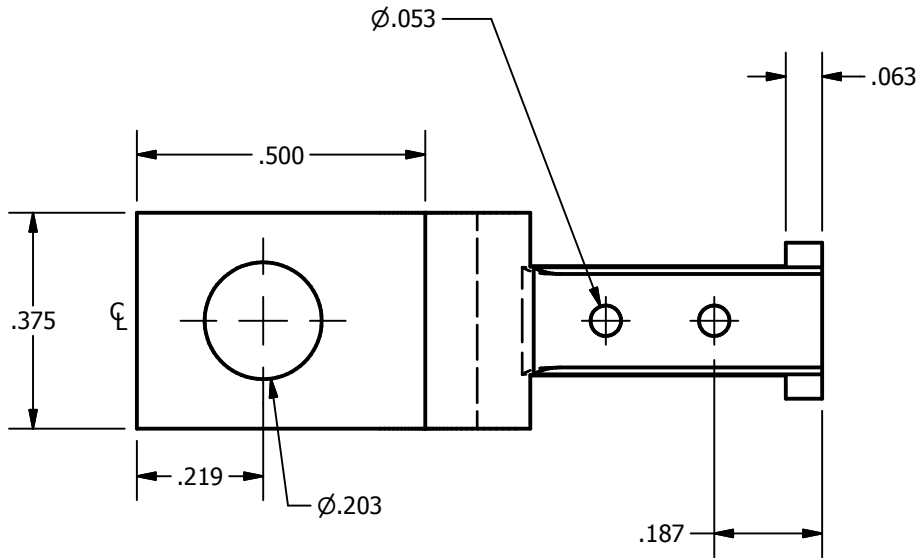

| | | | | |
|-------------------------|--------------------|----------------|--|----------------------------|
| SCREW: NONE | MATERIAL: COPPER | REV: G |  | |
| CAT. NO.: NONE | PLATING: SEE CHART | DRAWN BY: JG | SCALE: 3=1 | 800-776-9775 www.ilsco.com |
| INFORMATION SHEET: NONE | MARKING: SEE CHART | DATE: 6/4/2007 | SIZE: A | DWG. NO. F0013 |
| | | | | SHEET: 1 OF 1 |

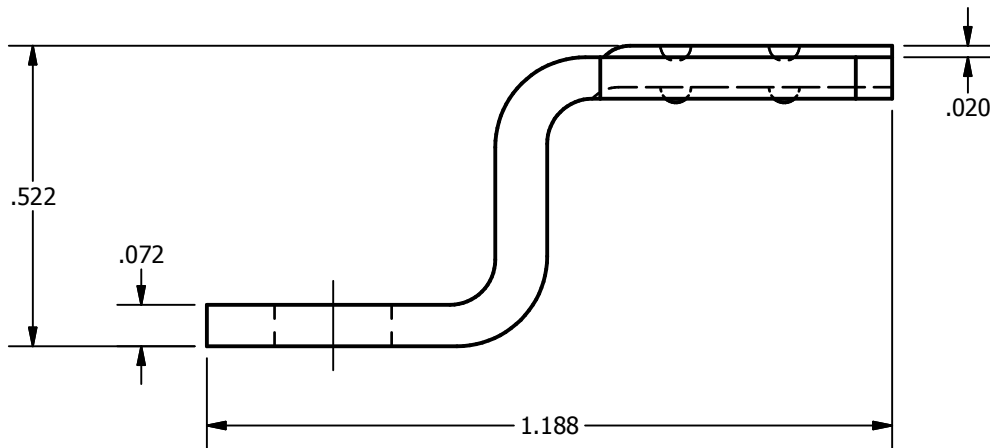

VIEW9
SCALE 2 : 1



| DEV | PLATING | MARKING |
|------|------------|--|
| COOB | BRIGHT DIP | SLU-35  |
| COOT | EL-TIN | SLU-35  |
| C10B | BRIGHT DIP | BTC 0614  |