

CHCC1DU & CHCC1DIU

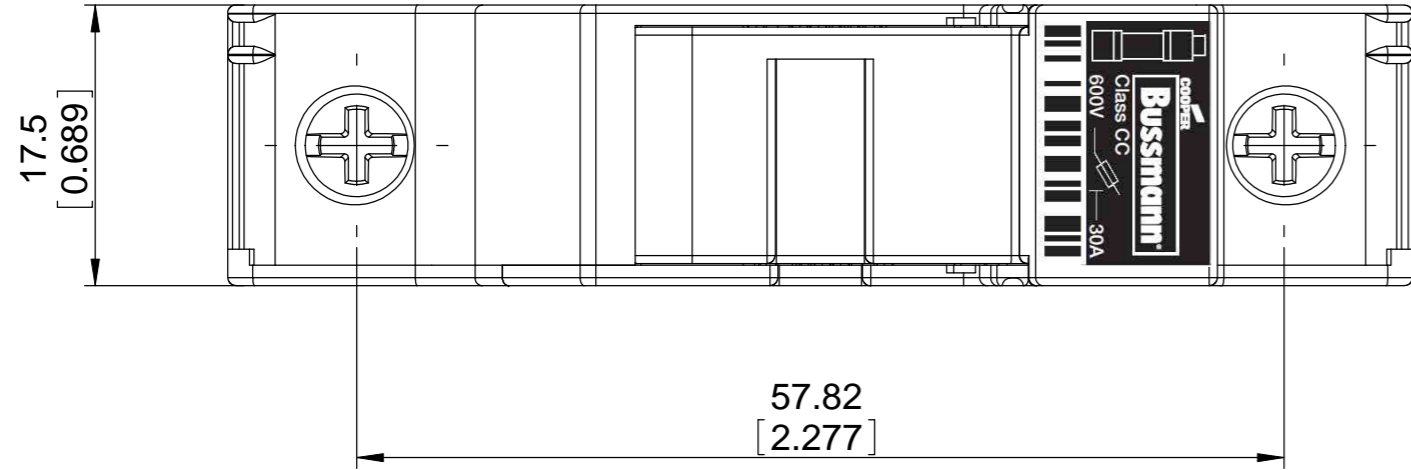

CHCC1DI-48U

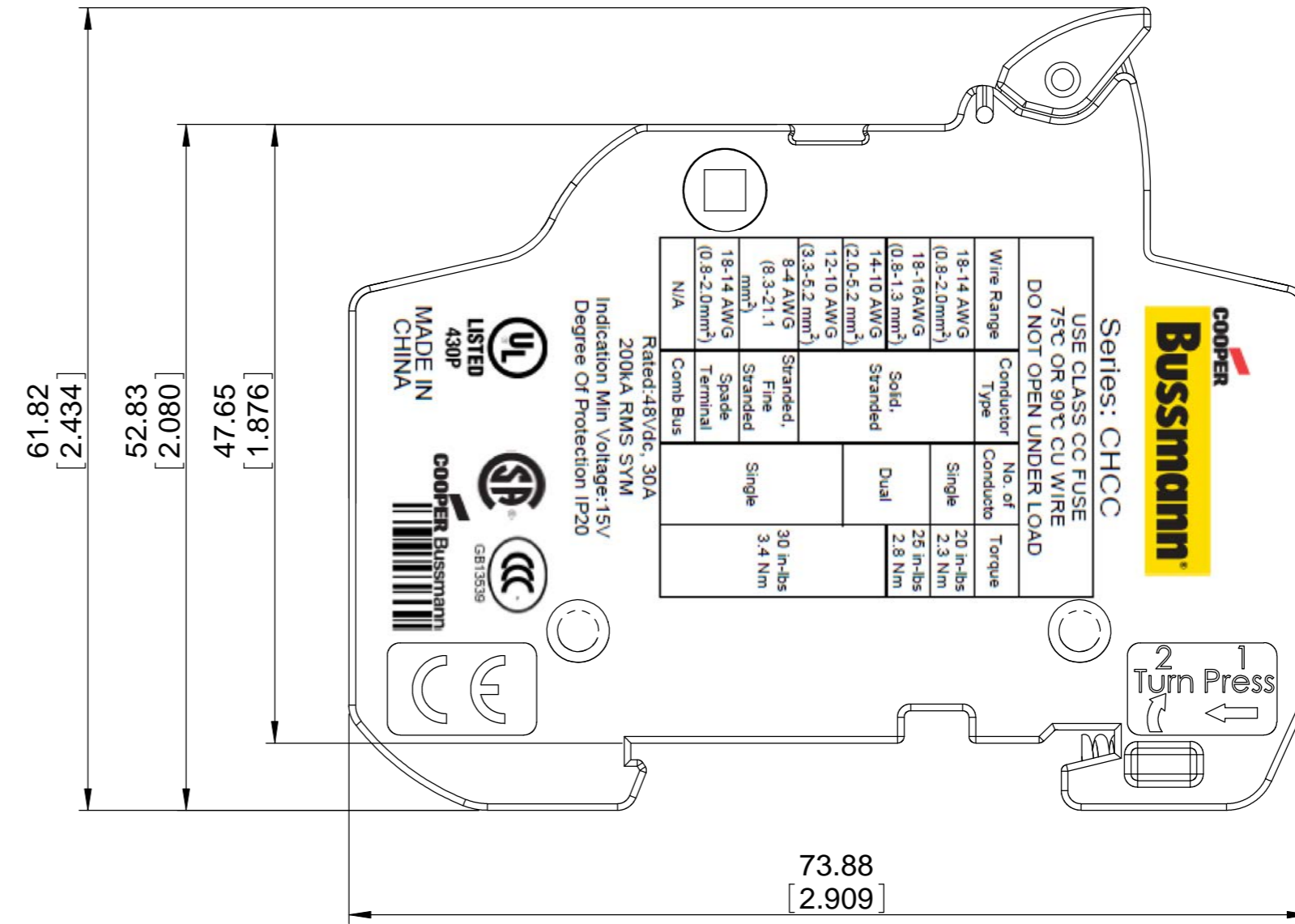
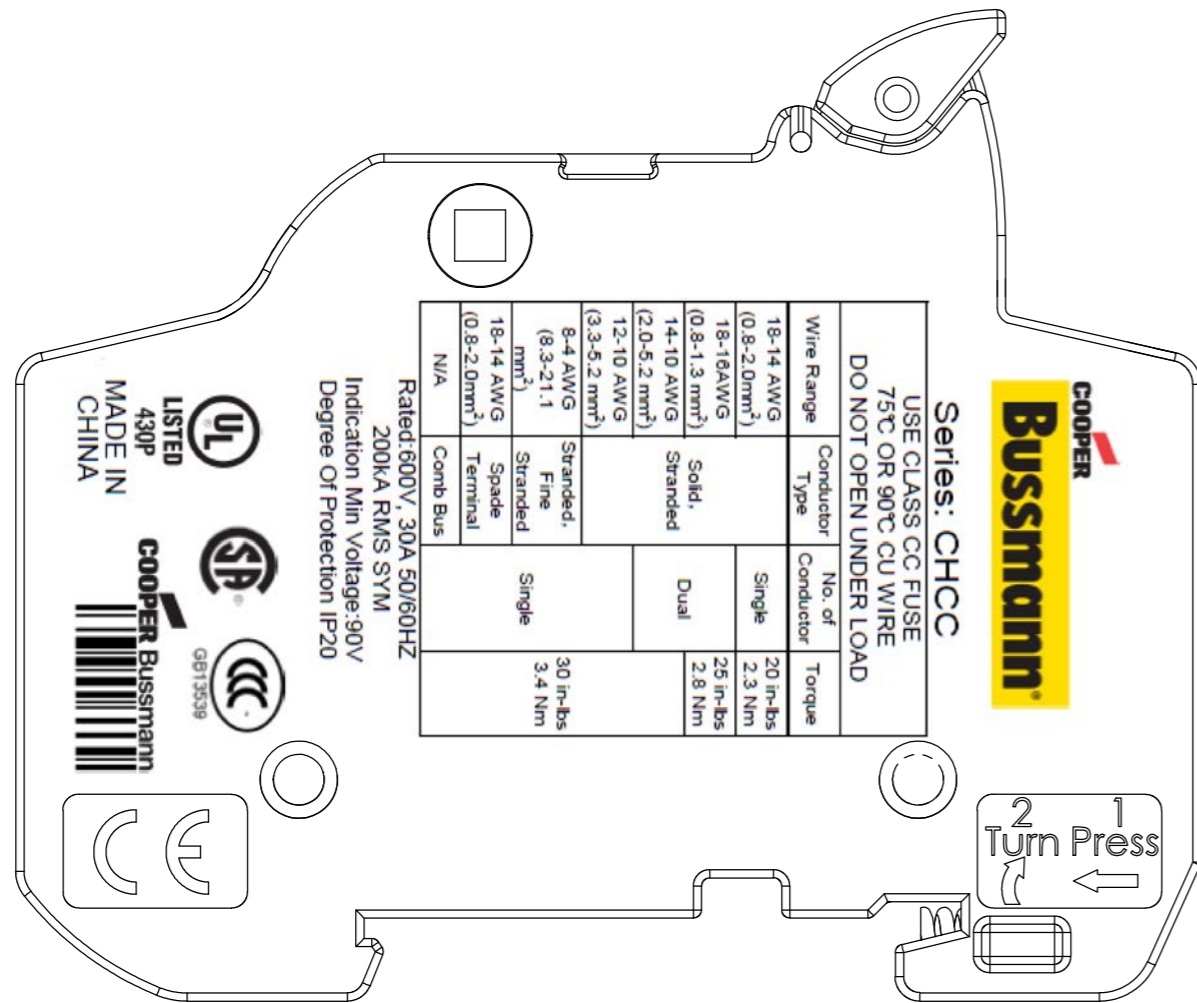
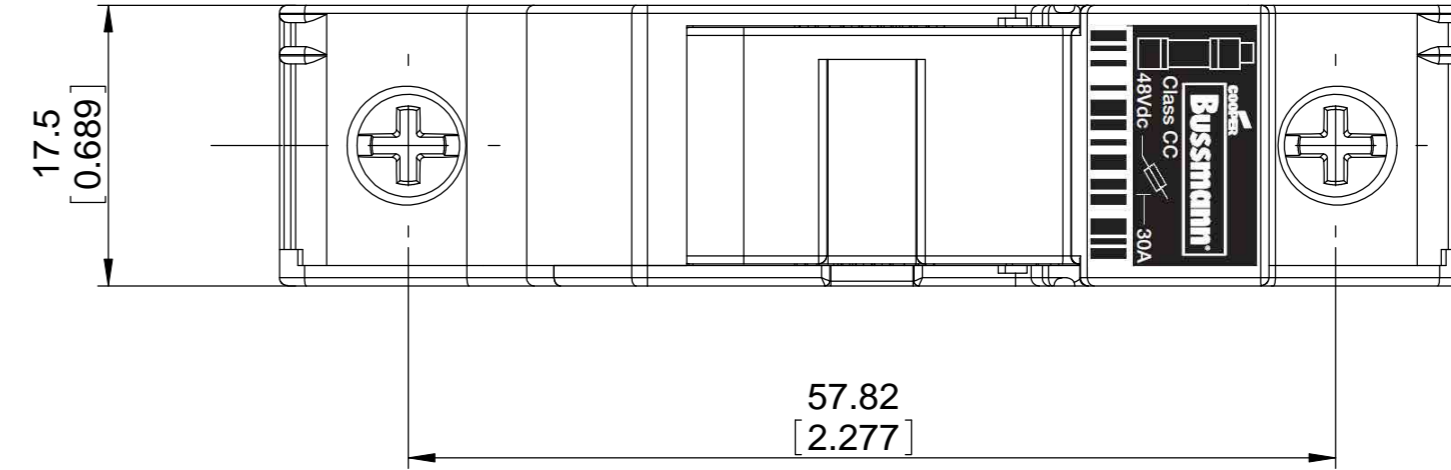

COOPER Bussmann
St. Louis MO 63178

TITLE:
10X38MODULAR FUSE HOLDER-CUST

SCALE: 1.5:1 SIZE: A3 SHEET: 1 OF 3

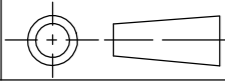

CHM1DU&CHM1DIU

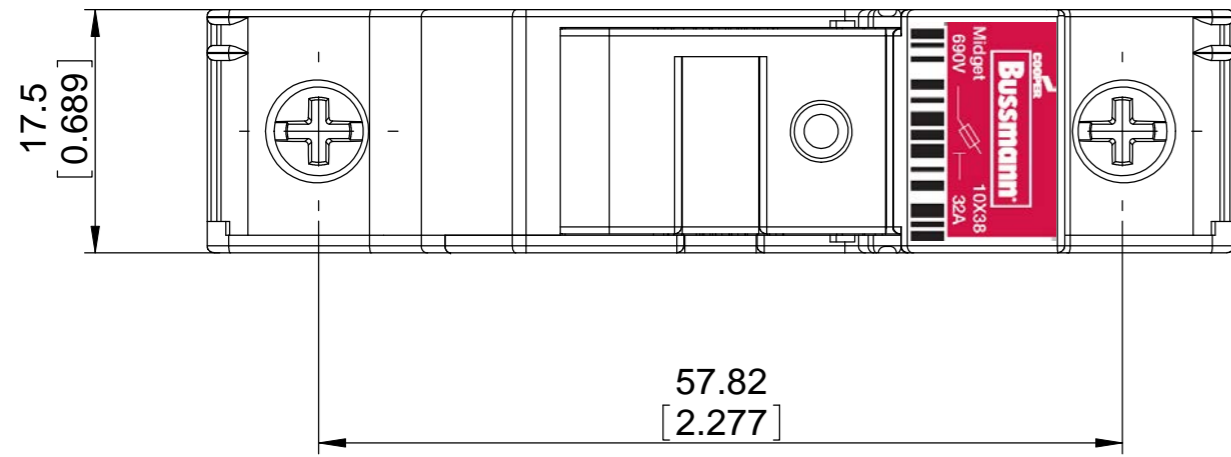

CHM1DI-48U

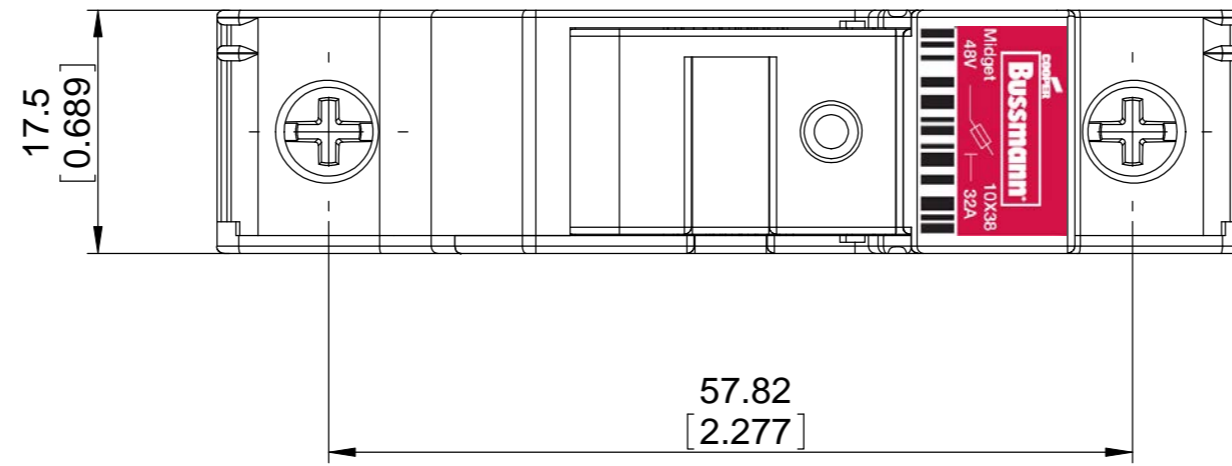

CHM1DNXU

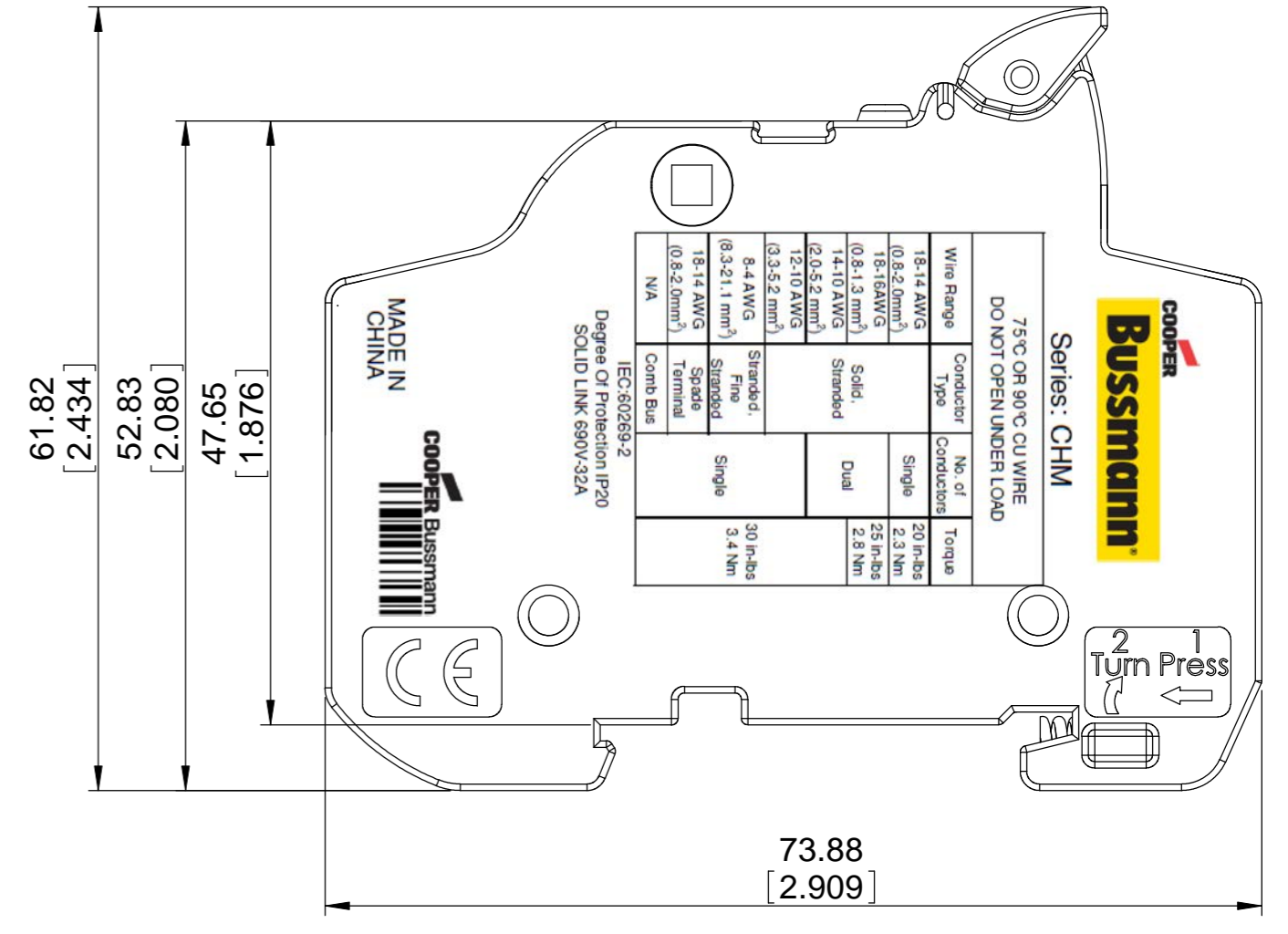
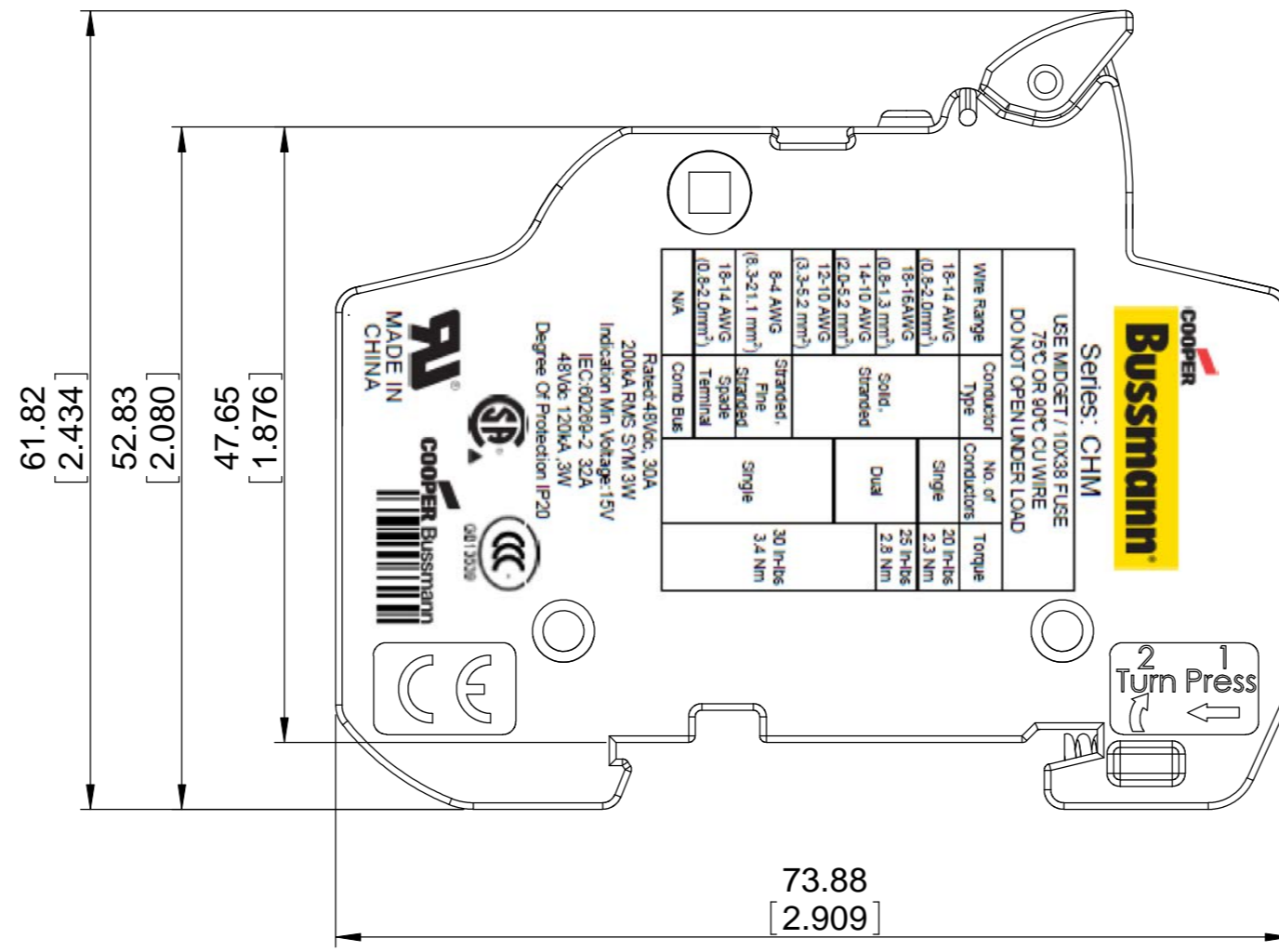
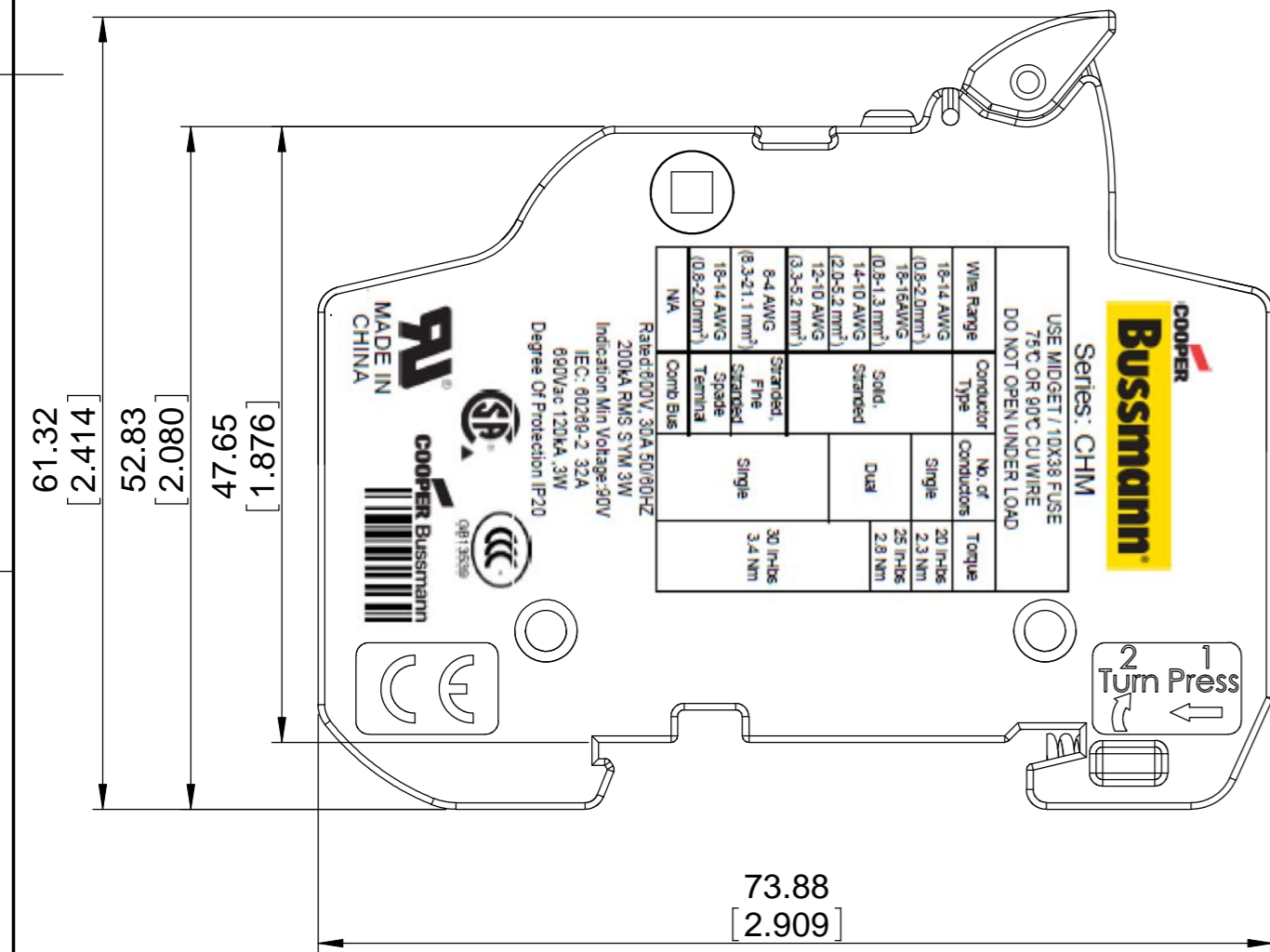
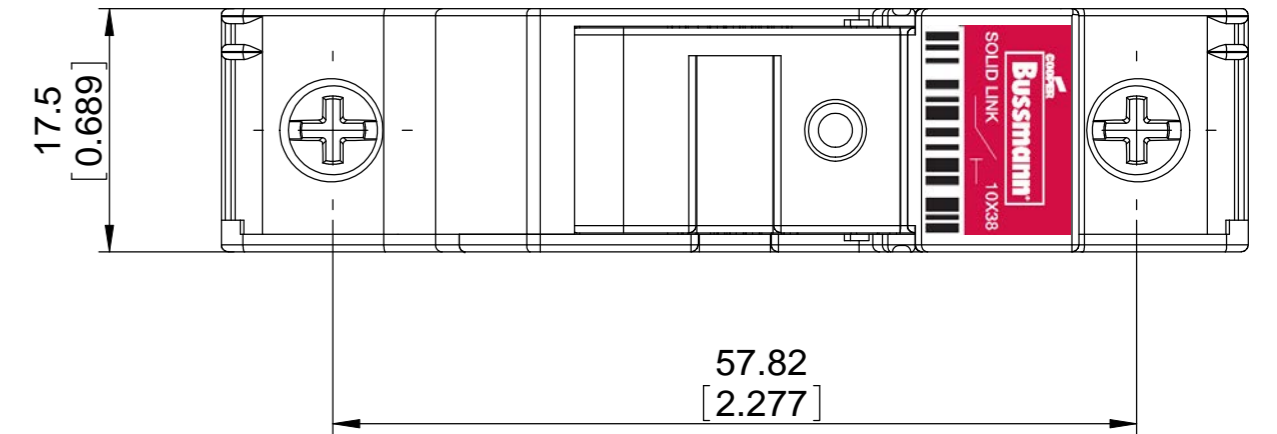

DESIGN UNITS: METRIC (mm)
UNLESS OTHERWISE SPECIFIED [INCHES]

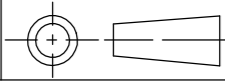

THIRD ANGLE PROJECTION

CHPV1U&CHPV1IU

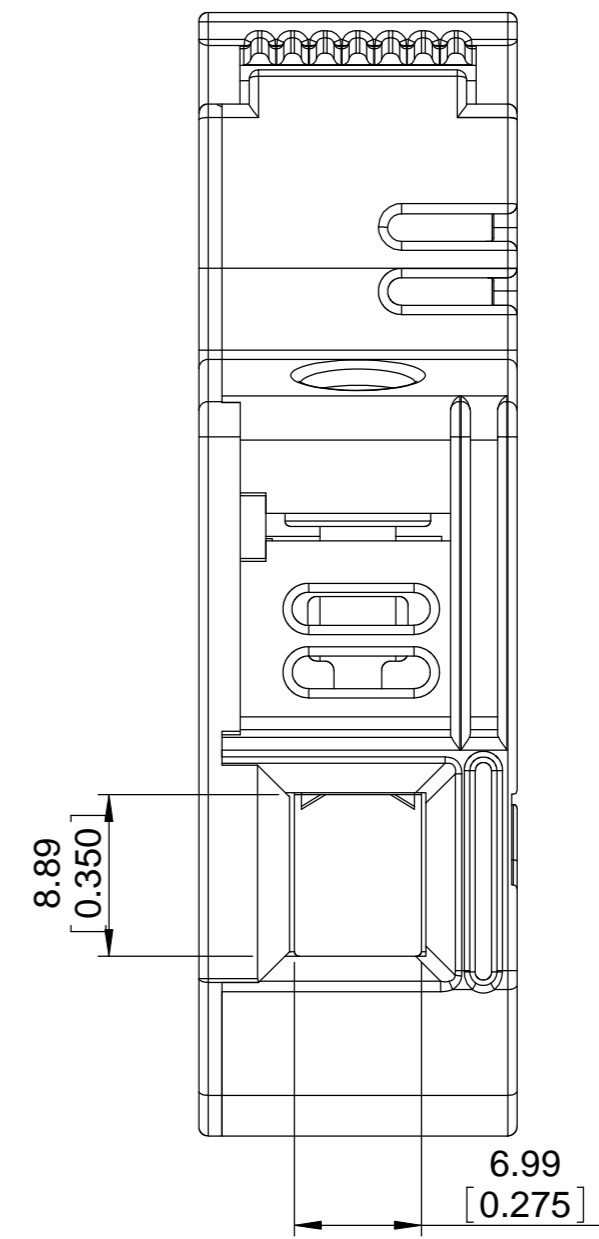
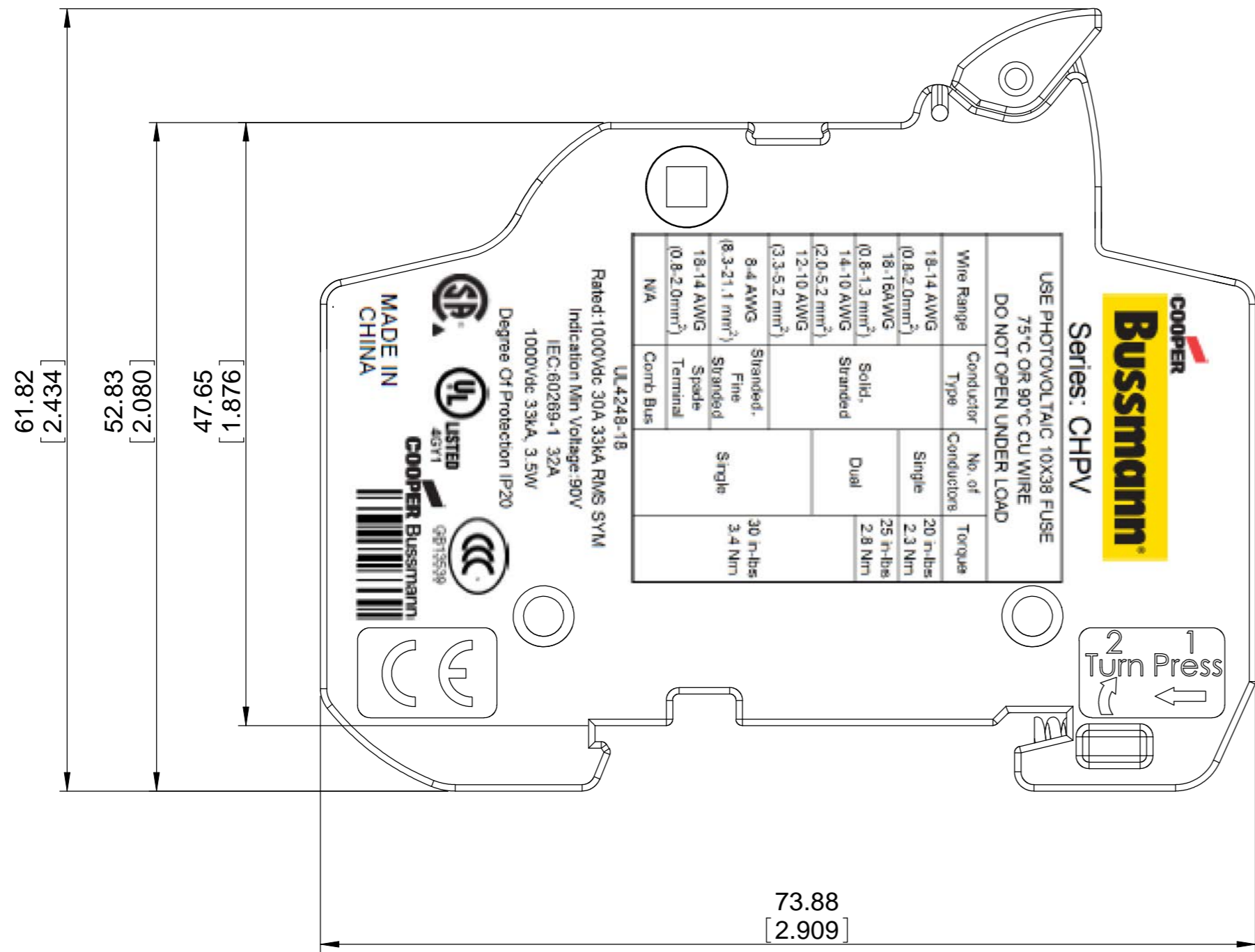
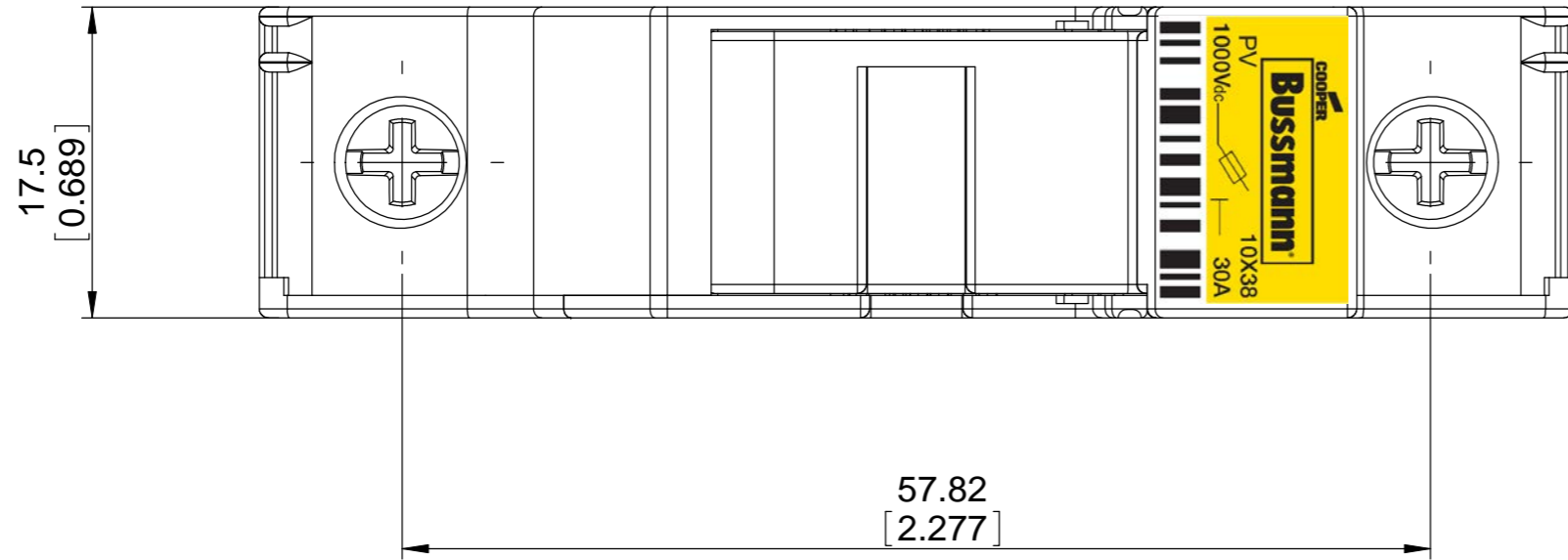

COOPER Bussmann
St. Louis MO 63178

TITLE:
10X38MODULAR FUSE HOLDER-CUST

SCALE: 2:1 SIZE: A3 SHEET: 3 OF 3